

# Panasonic<sup>®</sup>

## Owner's Manual

---

Digital Camera

Model No. **DC-BGH1**

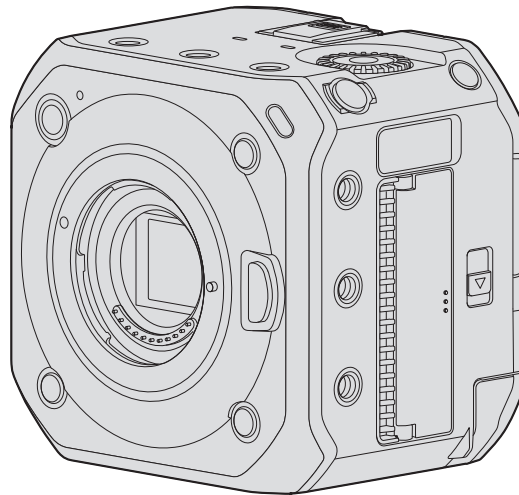

# LUMIX

Please read these instructions carefully before using this product, and save this manual for future use.

# Information for Your Safety

**Dear Customer,**

**Thank you for choosing Panasonic!**

You have purchased one of the most sophisticated and reliable products on the market today. Used properly, we're sure it will bring you and your family years of enjoyment. Please take time to fill in the information below. The serial number is on the tag located on the underside of your camera. Be sure to **retain this manual** as your convenient camera information source.

Date of Purchase
Dealer Purchased From
Dealer Address
Dealer Phone No.
Model No.
Serial No.

Please note that the actual controls and components, menu items, etc. of your Digital Camera may look somewhat different from those shown in the illustrations in this Owner's Manual.

## **Carefully observe copyright laws.**

Recording of pre-recorded tapes or discs or other published or broadcast material for purposes other than your own private use may infringe copyright laws. Even for the purpose of private use, recording of certain material may be restricted.

### **WARNING:**

**To reduce the risk of fire, electric shock or product damage,**

- **Do not expose this unit to rain, moisture, dripping or splashing.**
- **Use the recommended accessories.**
- **Do not remove covers.**
- **Do not repair this unit by yourself. Refer servicing to qualified service personnel.**

The socket outlet shall be installed near the equipment and shall be easily accessible.

## ■ Product identification marking

<b>Product</b>	<b>Location</b>
Digital Camera	Rear (Battery installing place)
AC adaptor	Bottom

**THE FOLLOWING APPLIES ONLY IN THE U.S.A.**

**FCC Note:**

This equipment has been tested and found to comply with the limits for a Class B digital device, pursuant to Part 15 of the FCC Rules.

These limits are designed to provide reasonable protection against harmful interference in a residential installation. This equipment generates, uses, and can radiate radio frequency energy and, if not installed and used in accordance with the instructions, may cause harmful interference to radio communications.

However, there is no guarantee that interference will not occur in a particular installation. If this equipment does cause harmful interference to radio or television reception, which can be determined by turning the equipment off and on, the user is encouraged to try to correct the interference by one or more of the following measures:

- Reorient or relocate the receiving antenna.
- Increase the separation between the equipment and receiver.
- Connect the equipment into an outlet on a circuit different from that to which the receiver is connected.
- Consult the dealer or an experienced radio/TV technician for help.

**FCC Caution:**

- Any unauthorized changes or modifications to this equipment would void the user's authority to operate this device.
- To assure continued compliance, follow the attached installation instructions and use only shielded interface cables with ferrite core when connecting to computer or peripheral devices.

This device complies with Part 15 of the FCC Rules. Operation is subject to the following two conditions: (1) This device may not cause harmful interference, and (2) this device must accept any interference received, including interference that may cause undesired operation.

**Supplier's Declaration of Conformity**

Trade name: Panasonic

Model No.: DC-BGH1

Responsible Party:

Panasonic Corporation of North America

Two Riverfront Plaza, Newark, NJ 07102-5490

Support Contact: <http://shop.panasonic.com/support>

**THE FOLLOWING APPLIES ONLY IN THE U.S.A.**

Contains FCC ID: VPYLB1JS955

This transmitter must not be co-located or operated in conjunction with any other antenna or transmitter.

This equipment complies with FCC radiation exposure limits set forth for an uncontrolled environment and meets the FCC radio frequency (RF) Exposure Guidelines as this equipment has very low levels of RF energy.

**THE FOLLOWING APPLIES ONLY IN CANADA.**

CAN ICES-3(B)/NMB-3(B)

Contains IC: 772C-LB1JS955

This device contains licence-exempt transmitter(s)/receiver(s) that comply with Innovation, Science and Economic Development Canada's licence-exempt RSS(s). Operation is subject to the following two conditions:

- (1) This device may not cause interference.
- (2) This device must accept any interference, including interference that may cause undesired operation of the device.

The available scientific evidence does not show that any health problems are associated with using low power wireless devices. There is no proof, however, that these low power wireless devices are absolutely safe. Low power Wireless devices emit low levels of radio frequency energy (RF) in the microwave range while being used. Whereas high levels of RF can produce health effects (by heating tissue), exposure of low-level RF that does not produce heating effects causes no known adverse health effects. Many studies of low-level RF exposures have not found any biological effects. Some studies have suggested that some biological effects might occur, but such findings have not been confirmed by additional research. DC-BGH1 (HMN is 1JS2005) has been tested and found to comply with ISED radiation exposure limits set forth for an uncontrolled environment and meets RSS-102 of the ISED radio frequency (RF) Exposure rules.

## ■ About the battery pack

- Always use genuine Panasonic batteries (AG-VBR59, AG-VBR89, AG-VBR118).
- If you use other batteries, we cannot guarantee the quality of this product.

### CAUTION

Battery pack (Lithium ion battery pack)

- Use the specified unit to recharge the battery pack.
- Do not use the battery pack with equipment other than the specified unit.
- Do not get dirt, sand, liquids, or other foreign matter on the terminals.
- Do not touch the plug terminals (+ and –) with metal objects.
- Do not disassemble, remodel, heat or throw into fire.

If any electrolyte should come into contact with your hands or clothes, wash it off thoroughly with water.

If any electrolyte should come into contact with your eyes, never rub the eyes.

Rinse eyes thoroughly with water, and then consult a doctor.

### CAUTION

- Danger of explosion if battery is incorrectly replaced. Replace only with the type recommended by the manufacturer.
- When disposing of the batteries, please contact your local authorities or dealer and ask for the correct method of disposal.

- Do not heat or expose to flame.
- Do not leave the battery(ies) in a car exposed to direct sunlight for a long period of time with doors and windows closed.
- Do not expose to low air pressure at high altitudes.
- Do not expose to extremely low air pressure, as this may result in explosions or leakage of flammable liquids and gases.

### Warning

Risk of fire, explosion and burns. Do not disassemble, heat above 60 °C (140 °F) or incinerate.

## ■ About the AC adaptor (supplied)

### CAUTION!

To reduce the risk of fire, electric shock or product damage,

- **Do not install or place this unit in a bookcase, built-in cabinet or in another confined space. Ensure this unit is well ventilated.**

### AC adaptor

This AC adaptor operates on AC between 100 V and 240 V.

But

- In the U.S.A. and Canada, the AC adaptor must be connected to a 120 V AC power supply only.
- When connecting to an AC supply outside of the U.S.A. or Canada, use a plug adaptor to suit the AC outlet configuration.
- When connecting to a supply of greater than AC 125 V, ensure the cord you use is suited to the voltage of the AC supply and the rated current of the AC adaptor.
- Contact an electrical parts distributor for assistance in selecting a suitable AC plug adaptor or AC cord set.

---

## Cautions for Use

- Do not use any other AC cables except the supplied one.
- Use a high speed HDMI cable (Type A - Type A plug) that is compatible with 4K and has an HDMI logo.
- For the USB connection cable, use one that is a shielded product with a ferrite core compliant to USB Type C (USB3.1) that is less than 1.5 m (4.9 feet).
- When connecting a BNC cable to the [GENLOCK IN] terminal or [TC IN/OUT] terminal, use one that is less than 2.8 m (9.1 feet). It is recommended to use a double shielded BNC cable equivalent to 5C-FB.
- For the cable that connects to the LAN terminal, use the one below.  
LAN cable (STP (Shielded Twisted Pair), category 5e or above, maximum 100 m (328 feet))
- Do not use the Headphone cables with the length of 3 m (9.8 feet) or more.
- Do not use the Stereo microphone cables with the length of 3 m (9.8 feet) or more.

**Keep this unit as far away as possible from electromagnetic equipment (such as microwave ovens, TVs, video games etc.).**

- If you use this unit on top of or near a TV, the pictures and/or sound on this unit may be disrupted by electromagnetic wave radiation.
- Do not use this unit near cell phones because doing so may result in noise adversely affecting the pictures and/or sound.
- Recorded data may be damaged, or pictures may be distorted, by strong magnetic fields created by speakers or large motors.
- Electromagnetic wave radiation may adversely affect this unit, disturbing the pictures and/or sound.
- If this unit is adversely affected by electromagnetic equipment and stops functioning properly, turn this unit off and remove the battery or disconnect AC adaptor. Then reinsert the battery or reconnect AC adaptor and turn this unit on.

**Do not use this unit near radio transmitters or high-voltage lines.**

- If you record near radio transmitters or high-voltage lines, the recorded pictures and/or sound may be adversely affected.

- 
- **To clean your camera, remove the battery or a card, or disconnect the power plug from the outlet, and wipe with a soft, dry cloth.**
  - **Do not press the lens with excessive force.**
  - **Do not allow camera to come into contact with pesticides or volatile substances (can cause surface damage or coating to peel).**
  - **Do not keep rubber or plastic products in contact with the camera for a long period of time.**
  - **Do not use solvents such as benzine, thinner, alcohol, kitchen detergents, etc., to clean the camera, since it may deteriorate the external case or the coating may peel off.**
  - **Do not leave the camera with the lens facing the sun, as rays of light from the sun may cause it to malfunction.**
  - **Always use the supplied cords and cables.**
  - **Do not extend the supplied cord or cable.**
  - The data on the card may be damaged or lost due to electromagnetic waves, static electricity or breakdown of the camera or the card. We recommend storing important data on a PC etc.
  - **Do not leave any metal items (such as clips) near the contact areas of the power plug or near the batteries.**
-

# About Operating Instructions

## ■ Symbols Used in This Document

### Operating symbols

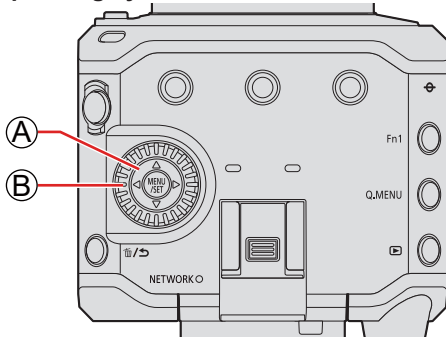

(A) ▲▼◀▶	Cursor button up/down/left/right
(B) ⚙️	Control dial

- Other symbols, such as icons shown on the screen of the output destination, are also used in explanations.
- This document describes the procedure for selecting menu items as follows:  
Example: Set the [Rec Quality] of the [Video] ([Image Quality]) menu

[MENU/SET] → [📹] → [📺] → Select [Rec Quality]

- The images and drawings of this document are an illustration to explain the functions.
- This document uses illustrations with an optional battery (AG-VBR59) attached.
- Description in these operating instructions is based on the interchangeable lens (H-ES12060).

# Contents

<b>Information for Your Safety</b>	<b>2</b>	<b>4. Recording Videos</b>	<b>51</b>
About Operating Instructions.....	6	<b>Recording Videos</b> .....	<b>51</b>
<b>1. Introduction</b>	<b>10</b>	Recording Videos.....	51
Before Use.....	10	[Exposure Mode].....	53
Standard Accessories.....	12	<b>Recording Settings For Video</b> .....	<b>55</b>
Lenses That Can Be Used .....	15	[System Frequency] .....	55
Memory Cards That Can Be Used.....	16	[Rec. File Format].....	55
Names of Parts .....	17	[Rec Quality].....	56
<b>2. Getting Started</b>	<b>21</b>	[Image Area of Video].....	61
Power supply .....	21	<b>Time Code</b> .....	<b>62</b>
Supplying power with an AC adaptor .....	21	Setting the Time Code.....	62
Supplying power from a PoE+ power supply .....	22	<b>Synchronizing the Time Code</b>	
Turning the camera on.....	23	<b>with an External Device</b> .....	<b>64</b>
Turning the camera off.....	23	Preparations for Time Code Synchronization.....	64
Power Indications.....	24	Synchronize the Time Code of the External Device	
<b>Attaching a Lens</b> .....	<b>25</b>	with That of the Camera (TC OUT) .....	65
<b>Connecting the external monitor</b> .....	<b>27</b>	Synchronize the Time Code of the Camera	
Connecting to the external monitor .....	27	with That of the External Device (TC IN).....	66
Attaching the Cable Lock Band.....	28	<b>Genlock settings</b> .....	<b>67</b>
<b>Inserting Cards (Optional)</b> .....	<b>30</b>	Input a sync signal .....	67
Inserting / removing the card.....	30	Horizontal phase adjustment.....	69
Formatting Cards (Initialization) .....	32		
[Folder / File Settings] .....	33		
[Double Card Slot Function] .....	34		
<b>Setting the Clock</b>			
<b>(When Turning On for the First Time)</b> .....	<b>35</b>		
Clock Set.....	35		
Time zone .....	37		
<b>3. Basic Operations</b>	<b>38</b>		
Camera Setting Operations .....	38		
<b>Display Settings</b> .....	<b>39</b>		
Information Display (HDMI/SDI).....	39		
Output destination screen display .....	40		
Switching the Display Information .....	41		
<b>Control Panel</b> .....	<b>43</b>		
<b>Quick Menu</b> .....	<b>44</b>		
<b>Menu Operation Methods</b> .....	<b>46</b>		
Menu operation .....	46		
[Reset].....	50		

<b>5. Recording settings</b>	<b>70</b>	<b>7. Output image</b>	<b>133</b>
<b>Focus / Zoom</b> .....	<b>70</b>	<b>Images Output via HDMI</b> .....	<b>133</b>
Selecting the Focus Mode .....	70	<b>HDMI Output Image Quality</b>	
Using AF .....	71	<b>(Resolution / Frame Rate)</b> .....	<b>134</b>
Selecting the AF Mode .....	73	Settings for Down-Converting .....	134
[Continuous AF] .....	78	<b>HDMI Output Settings</b> .....	<b>137</b>
[AF Custom Setting(Video)] .....	78	Outputting Control Information to	
Record Using MF .....	79	an External Recorder .....	137
Recording with Zoom .....	83	Outputting Down-converted Audio to	
<b>Metering / Exposure / ISO Sensitivity</b> .....	<b>85</b>	an HDMI Device .....	137
[Metering Mode] .....	85	Outputting Audio via HDMI .....	137
Exposure Compensation .....	86	Output the enlarged display of MF assist via HDMI .....	137
Locking Focus and Exposure (AF/AE Lock) .....	87	<b>SDI output settings</b> .....	<b>138</b>
ISO Sensitivity .....	88	Set the resolution during recording when output	
[ISO Sensitivity (video)] .....	90	via SDI .....	138
[Dual Native ISO Setting] .....	90	Output control information to the external recorder .....	139
[Luminance Level] .....	90	Output audio via SDI .....	139
<b>White Balance / Image Quality</b> .....	<b>91</b>	Set the gain of the audio signal that is output via SDI .....	139
White Balance (WB) .....	91	Output the enlarged display of MF assist via SDI .....	139
[Master Pedestal Level] .....	95		
[Photo Style] .....	96	<b>8. Connections with External Devices</b>	<b>140</b>
Recording While Controlling Overexposure (Knee) .....	100	<b>External Microphones (Optional)</b> .....	<b>140</b>
[Filter Settings] .....	101	<b>XLR Microphone Adaptor (Optional)</b> .....	<b>142</b>
<b>Audio Settings</b> .....	<b>105</b>	<b>Headphones</b> .....	<b>144</b>
[Sound Rec Level Disp.] .....	105	<b>Using a remote control unit</b> .....	<b>145</b>
[Mute Sound Input] .....	105	<b>Importing Images to a PC</b> .....	<b>146</b>
[Sound Rec Gain Level] .....	105		
[Sound Rec Level Adj.] .....	106	<b>9. Playback</b>	<b>148</b>
[Sound Rec Level Limiter] .....	106	<b>Playing Back Videos</b> .....	<b>148</b>
[Wind Noise Canceller] .....	106	<b>Switching the Display Mode</b> .....	<b>151</b>
[Lens Noise Cut] .....	106	Thumbnail Display .....	151
<b>Main Assist Functions</b> .....	<b>107</b>	Group Images .....	152
[Image Stabilizer] .....	107	<b>Deleting Images</b> .....	<b>153</b>
[SS/Gain Operation] .....	108		
[Luminance Spot Meter] .....	109	<b>10. Camera Customization</b>	<b>154</b>
[Zebra Pattern] .....	110	<b>Fn Buttons</b> .....	<b>154</b>
[Frame Marker] .....	111	Fn Button Default Settings .....	154
Color bars / Test Tone .....	111	Register Functions to the Fn Buttons .....	155
		Use the Fn Buttons .....	160
<b>6. Special Video Recording</b>	<b>112</b>	<b>Quick Menu Customization</b> .....	<b>161</b>
<b>[Variable Frame Rate]</b> .....	<b>112</b>	Register to the Quick Menu .....	161
<b>[Focus Transition]</b> .....	<b>114</b>	<b>Custom Mode</b> .....	<b>165</b>
<b>[Live Cropping]</b> .....	<b>117</b>	Register in Custom Mode .....	165
<b>Log Recording</b> .....	<b>120</b>	Using Custom Mode .....	167
[V-Log L] Settings .....	120	Calling Up Settings .....	168
[V-LogL View Assist] .....	121	<b>My Menu</b> .....	<b>169</b>
<b>HLG Videos</b> .....	<b>122</b>	Registration in My Menu .....	169
[Hybrid Log Gamma] settings .....	122	Edit My Menu .....	170
[HLG View Assist] .....	123	<b>[Save/Restore Camera Setting]</b> .....	<b>171</b>
<b>Anamorphic Recording</b> .....	<b>124</b>		
Anamorphic (4:3) video .....	124		
[Anamorphic Desqueeze Display] .....	125		
<b>[Synchro Scan]</b> .....	<b>126</b>		
<b>[Loop Recording (video)]</b> .....	<b>127</b>		
<b>[Segmented File Recording]</b> .....	<b>128</b>		
<b>List of Recording Qualities That Enable</b>			
<b>Special Videos to be Recorded</b> .....	<b>129</b>		



<b>11. Menu Guide</b>	<b>172</b>	<b>13. Materials</b>	<b>238</b>
<b>List of Menu</b> .....	<b>172</b>	<b>Optional Accessories</b> .....	<b>238</b>
<b>[Rec Mode] menu</b> .....	<b>176</b>	<b>External Monitor Displays</b> .....	<b>239</b>
[Rec Mode] menu (Recording mode).....	176	Recording Screen .....	239
<b>[Video] menu</b> .....	<b>176</b>	Playback Screen .....	244
[Video] menu ([Image Quality]) .....	176	<b>Lamp / Indicator Display</b> .....	<b>248</b>
[Video] menu ([Image Format]) .....	179	<b>Message Displays</b> .....	<b>249</b>
[Video] menu ([Focus]).....	180	<b>Troubleshooting</b> .....	<b>251</b>
[Video] menu ([Audio]) .....	181	Power .....	251
[Video] menu ([Others]).....	183	External device.....	251
<b>[Custom] menu</b> .....	<b>185</b>	Recording.....	252
[Custom] menu ([Image Quality]) .....	185	Playback.....	254
[Custom] menu ([Focus/Shutter]).....	186	Wi-Fi Function .....	254
[Custom] menu ([Operation]).....	187	Others .....	255
[Custom] menu ([Monitor / Display]).....	188	<b>Cautions for Use</b> .....	<b>256</b>
[Custom] menu ([IN/OUT]) .....	191	<b>Available Recording Time with the Battery</b> .....	<b>260</b>
[Custom] menu ([Lens / Others]).....	192	<b>Video Recording Time with Cards</b> .....	<b>263</b>
<b>[Setup] menu</b> .....	<b>193</b>	<b>List of Default Settings / Custom Saving / Settings</b>	
[Setup] menu ([Card/File]).....	193	<b>Available for Copying</b> .....	<b>266</b>
[Setup] menu ([Monitor / Display]).....	194	<b>Specifications</b> .....	<b>276</b>
[Setup] menu ([IN/OUT]) .....	194	<b>Trademarks and Licenses</b> .....	<b>282</b>
[Setup] menu ([Setting]) .....	196	<b>Useful Information</b>	
[Setup] menu ([Others]).....	197	<b>(Only For Latin American Countries)</b> .....	<b>284</b>
<b>[Playback] menu</b> .....	<b>199</b>		
How to Select an Image(s) in the [Playback] menu .....	199		
[Playback] menu ([Playback Mode]).....	200		
[Playback] menu ([Add/Delete Info.]) .....	200		
[Playback] menu ([Edit Image]) .....	201		
[Playback] menu ([Others]) .....	202		
<b>Entering Characters</b> .....	<b>203</b>		
<b>12. Remote Operations</b>	<b>204</b>		
<b>About Remote Operation</b> .....	<b>204</b>		
<b>Tethered Recording</b> .....	<b>207</b>		
Installing "LUMIX Tether".....	207		
Operating the Camera from a PC .....	208		
<b>Connecting to a Smartphone</b> .....	<b>213</b>		
Flow of connecting a smartphone .....	213		
Installing "LUMIX Sync".....	214		
Connecting to a Smartphone (Bluetooth Connection)...	215		
Connecting to a Smartphone (Wi-Fi connection) .....	218		
Connecting to a Smartphone			
(Wired LAN connection).....	223		
<b>Operating the Camera with a Smartphone</b> .....	<b>225</b>		
Getting started.....	225		
[Remote shooting].....	226		
[Shutter Remote Control] .....	226		
[Import images] .....	227		
[Location Logging].....	228		
[Remote Wakeup] .....	229		
[Auto Clock Set] .....	230		
[Camera settings copy] .....	230		
<b>Wi-Fi Connections</b> .....	<b>231</b>		
[Via Network].....	231		
[Direct].....	234		
Connect to Wi-Fi Using Previously Saved Settings .....	235		
<b>[LAN / Wi-Fi Setup] menu</b> .....	<b>237</b>		

# 1. Introduction

## Before Use

### ■ Firmware of Your Camera/Lens

Firmware updates may be provided in order to improve camera capabilities or to add functionality. For smoother recording, we recommend updating the firmware of the camera/lens to the latest version.

- **For the latest information on the firmware or to download/update the firmware, visit the following support site:**  
<https://panasonic.jp/support/global/cs/dsc/>  
(English only)
- To check the firmware version of the camera/lens, attach the lens to the camera and select [Firmware Version] in the [Setup] ([Others]) menu. You can also update the firmware in [Firmware Version]. (➔ 198 / [Firmware Version])
- This document provides explanations for camera firmware version 1.0.

### ■ This camera does not have a monitor.

Display the recording screen or menu with one of the following methods below.

- Connecting the external monitor (➔ 27 / [Connecting the external monitor](#))
- Using a PC software "LUMIX Tether" (➔ 207 / [Tethered Recording](#))
  - You can take pictures (Still images) when you use "LUMIX Tether".



### ■ Handling of the Camera

When using the camera, take care not to drop it, bump it, or apply undue force. These may cause malfunction or damage to the camera and lens.

The camera is not dust resistant, splash resistant, or waterproof. Avoid using the camera in places with excessive dust or sand, or where water can come into contact with the camera.

If sand, dust, or liquid gets on wipe it off with a dry soft cloth.

**When using in low temperatures (-10 °C to 0 °C (14 °F to 32 °F))**

Before use, attach a Panasonic lens with a minimum recommended operating temperature of -10 °C (14 °F).

**Do not place a hand inside the camera mount.**

This may cause a failure or damage because the sensor is a precision device.

■ **Condensation (When the lens is fogged up)**

- Condensation occurs when there are temperature or humidity differences. Take care as this may lead to soiling, mold, and malfunctions in the lens.
- If condensation occurs, turn off the camera and leave it for approx. 2 hours. The fog will disappear naturally when the temperature of the camera becomes close to the ambient temperature.

■ **Be Sure to Perform Trial Recording in Advance**

Perform trial recording in advance of an important event (wedding, etc.) to check that recording can be performed normally.

■ **No Compensation Regarding Recording**

Please note that compensation cannot be provided in the event that recording could not be performed due to a problem with the camera or a card.

■ **Be Careful with Regard to Copyrights**

Under copyright law, you may not use the images and audio you have recorded without the permission of the copyright holder.

■ **Also Read “Cautions for Use” (➔ [256 / Cautions for Use](#))**

# Standard Accessories

---

## Digital camera body

(Digital camera body is referred to as **camera** in this document.)

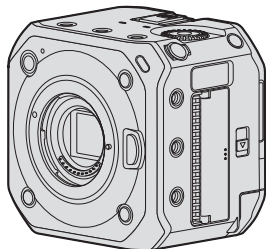

---

Check that all the accessories are supplied before using the camera.

(Product numbers correct as of October 2020.)

## AC adaptor

SAE0011A

- This is used for power supply.

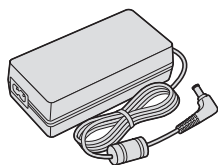

## AC cable

K2CA2CA00025

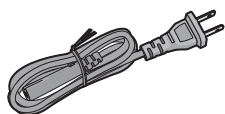

## Cable lock band

1AC1MC551Z

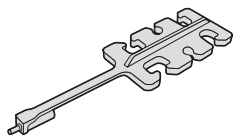

**Body cap\*1**

VKF4971

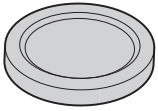

**Hot shoe cover\*1**

DVYE1121Z

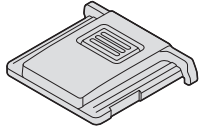

**BNC terminal cover\*1**

DVKJ1044Z/K

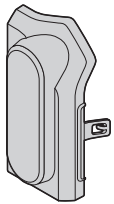

**HDMI terminal cover\*1**

DVKJ1045Z/K

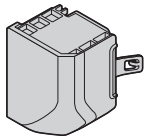

**AUDIO terminal cover\*1**

DVKJ1046Z/K

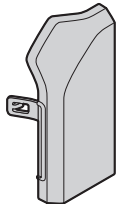

**DC IN terminal cover\*1**

DVKJ1047Y/K



**REMOTE terminal cover\*1**

DVKJ1048Z/K

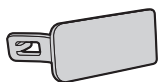

\*1 This is attached to the camera at the time of purchase but it's removable.

- The accessories and their shape will differ depending on the country or area where the camera was purchased.
- **The battery pack is optional.**  
(Battery pack is indicated as **battery pack** or **battery** in the text.)
- **The memory card is optional.**  
(Memory card is indicated as **card** in the text.)
- **The Interchangeable lens is optional.**  
(Interchangeable lens is indicated as **lens** in this text.)
- Always use the supplied cords and cables. Do not extend the supplied cord or cable.
- Please dispose of all packaging appropriately.
- Keep small parts in a safe place out of the reach of children.

**(For U.S.A. only)**

- If accessories are lost, customers can visit us at <http://shop.panasonic.com/support> for further information about obtaining replacement parts.

**(For Canada only)**

- If any accessories are lost, customers in Canada should visit our support page at [www.panasonic.ca/english/support](http://www.panasonic.ca/english/support) for further information about obtaining replacement parts.

# Lenses That Can Be Used

This unit can use the dedicated lenses compatible with the Micro Four Thirds™ System lens mount specification (Micro Four Thirds mount).

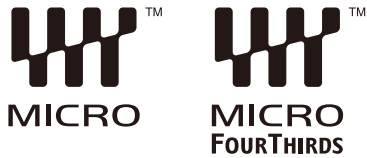

You can also use a lens of any of the following standards by attaching a mount adaptor.

Lens	Mount adaptor
Four Thirds™ mount specification lens  	Mount Adaptor (DMW-MA1: optional)
Leica M Mount interchangeable lens	M Mount Adaptor (DMW-MA2M: optional)
Leica R Mount interchangeable lens	R Mount Adaptor (DMW-MA3R: optional)

## ■ About the lens and functions

Depending on the lens used, certain functions, such as Auto Focus, Image Stabilizer, and zoom functions, may be disabled or operate differently.

- **Refer to catalogues/websites for most current information regarding supported lenses.**  
<https://panasonic.jp/support/global/cs/dsc/>  
 (English only)

- The focal length noted on the Micro Four Thirds lens is equivalent to double when converted to the 35 mm film camera. (It will be equivalent to 100 mm lens when a 50 mm lens is used.)

# Memory Cards That Can Be Used

You can use the following memory cards with this camera.

- SD memory card, SDHC memory card, and SDXC memory card are referred to by the generic name of **card** in this document.

SD memory card (512 MB to 2 GB)	<ul style="list-style-type: none"> <li>• The camera supports SDHC/SDXC memory cards compliant with UHS Speed Class 3 of the UHS-I/UHS-II standard.</li> <li>• The camera supports SDHC/SDXC memory cards compliant with Video Speed Class 90 of the UHS-II standard.</li> </ul>
SDHC memory card (4 GB to 32 GB)	
SDXC memory card (48 GB to 128 GB)	



Use cards that have the compatible SD Speed Class, UHS Speed Class, and Video Speed Class according to the bit rate of the recording quality.

- Speed classes are standards to guarantee the minimum speed necessary for continuous writing.

Bit rate of the recording quality	Speed Class	Example of indication
72 Mbps	Class 10	<b>CLASS 10 10</b>
	UHS Speed Class 1 or higher	<b>U1</b>
	Video Speed Class 10 or higher	<b>V10</b>
100 Mbps to 200 Mbps	UHS Speed Class 3	<b>U3</b>
	Video Speed Class 30 or higher	<b>V30</b>
400 Mbps	Video Speed Class 60 or higher	<b>V60 V90</b>

- You can prevent the writing and deleting of data by setting the write-protect switch (A) on the card to “LOCK”.
- The data stored on a card may be damaged due to electromagnetic waves, static electricity or a failure of the camera or card. We recommend backing up important data.
- Keep the memory card out of reach of children to prevent swallowing.

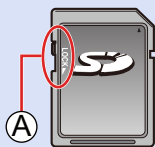



# Names of Parts

## ■ Front

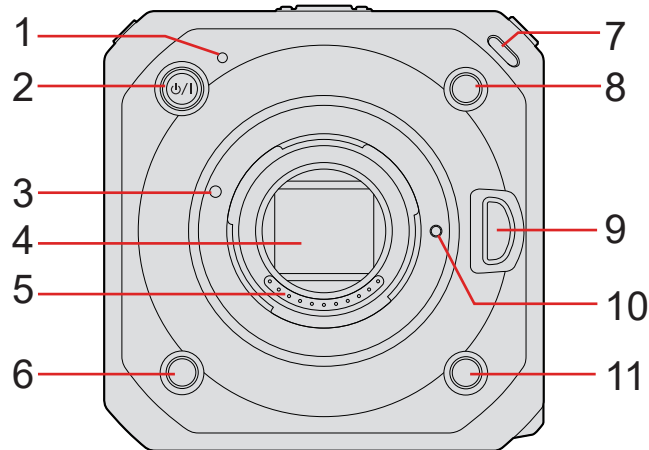

- 1 Status indicator (➔ [248 / Lamp / Indicator Display](#))
  - This displays the power status.
- 2 [⏻/⏻] Camera ON/OFF button (➔ [23 / Turning the camera on](#))
- 3 Lens fitting mark
- 4 Sensor
- 5 Contact points
- 6 Fn button ([Fn4]) (➔ [154 / Fn Buttons](#))
- 7 Front tally lamp (➔ [248 / Lamp / Indicator Display](#))
  - This will light when recording begins. It will also blink when the available recording time of the recording medium becomes short. When you do not want the lamp to light or when you want to change the brightness, you can set it on the menu screen. (➔ [192 / \[Tally Lamp\]](#))
- 8 Fn button ([Fn2]) (➔ [154 / Fn Buttons](#))
- 9 Lens release button
- 10 Lens lock pin
- 11 Fn button ([Fn3]) (➔ [154 / Fn Buttons](#))

■ Top

■ Bottom

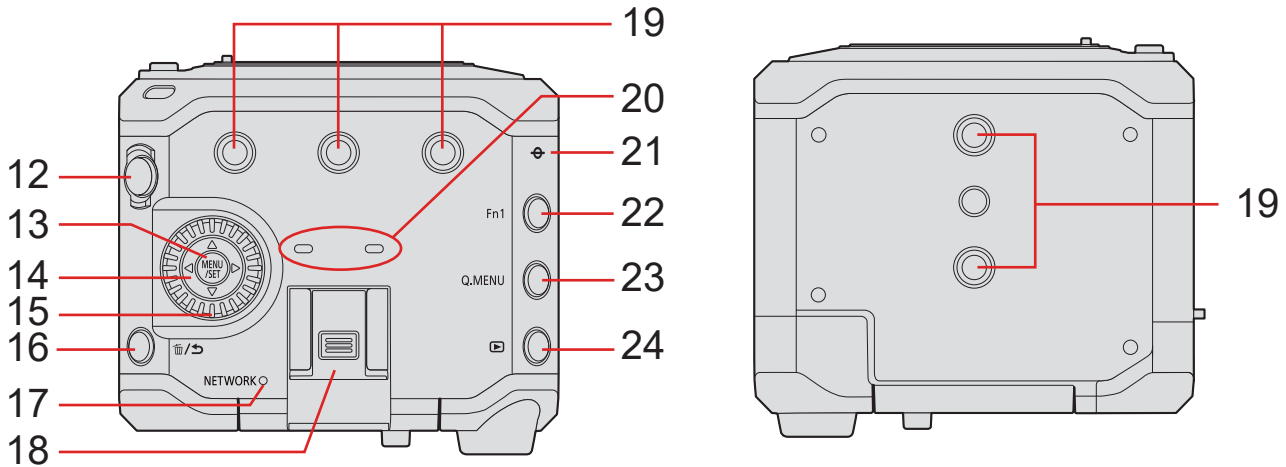

- 12 Video rec. button (➔ 51 / Recording Videos)
- 13 [MENU/SET] button (➔ 46 / Menu Operation Methods)
- 14 Cursor buttons
- 15 Control dial
- 16 [⏏] (Delete) button / [↵] (Cancel) button
- 17 [NETWORK] connection lamp (➔ 248 / Lamp / Indicator Display)
  - Displays the network status.
- 18 Hot shoe (hot shoe cover)
  - Keep the hot shoe cover out of reach of children to prevent swallowing.
- 19 Tripod mount
  - You can attach a tripod, platform or camera cage etc.
  - The size of the mounting screw is 1/4-20 UNC (Screw length is 5.5 mm (0.22 inch) or less)
  - If you attempt to attach a screw longer than 5.5 mm (0.22 inch), you may not be able to securely fix it in place or it may damage the camera.
- 20 Stereo microphone
  - Do not block the microphone with a finger. Audio will be difficult to record.
- 21 [⊖] (Recording distance reference mark)
- 22 Fn button ([Fn1]) (➔ 154 / Fn Buttons)
- 23 [Q.MENU] button (➔ 44 / Quick Menu)
- 24 [▶] (Playback) button (➔ 148 / Playing Back Videos)

## ■ Back

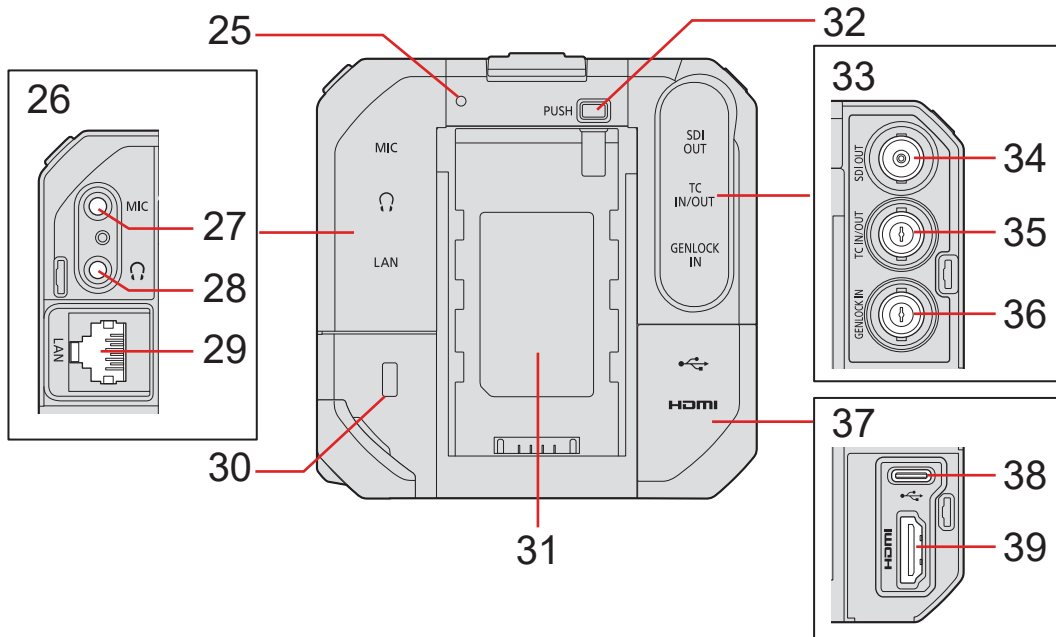

- 25 Rear tally lamp (➔ [248 / Lamp / Indicator Display](#))
- This works the same as the front tally lamp. You can set whether to make the lamp light at the menu screen separately from the front tally lamp. (➔ [192 / \[Tally Lamp\]](#))
- 26 AUDIO terminal cover
- 27 [MIC] terminal (➔ [140 / External Microphones \(Optional\)](#))
- This connects the external microphone.
- 28 Headphone terminal (➔ [144 / Headphones](#))
- This connects the headphones for the audio monitor.
- 29 [LAN] terminal
- Supplying power from a PoE+ power supply. (➔ [22 / Supplying power from a PoE+ power supply](#))
  - You can control the camera remotely by connecting with a PC that has the “LUMIX Tether” software installed. (➔ [207 / Tethered Recording](#))
  - You can remotely operate the camera by connecting it with a LAN cable to the wireless access point to which the smartphone that has the “LUMIX Tether” software installed is connected to. (➔ [223 / Connecting to a Smartphone \(Wired LAN connection\)](#))
- 30 Security Slot
- Attaching anti-theft equipment can prevent theft. We are not liable for damages that may occur resulting from theft.
- 31 Battery attachment part
- 32 Battery release button
- 33 BNC terminal cover
- 34 [SDI OUT] terminal (➔ [27 / Connecting the external monitor](#))
- This connects external monitors etc. and outputs an SDI signal.
- 35 [TC IN/OUT] terminal (➔ [64 / Synchronizing the Time Code with an External Device](#))
- This connects with an external device and inputs/outputs a time code.
- 36 [GENLOCK IN] terminal (➔ [67 / Genlock settings](#))
- This connects with an external device and inputs a sync signal.
- 37 HDMI terminal cover
- 38 [USB] terminal
- You can control the camera remotely by connecting with a PC that has the “LUMIX Tether” software installed. (➔ [207 / Tethered Recording](#))
  - Import shooting data by connecting with a PC. (➔ [146 / Importing Images to a PC](#))
- 39 [HDMI] terminal (Type A) (➔ [27 / Connecting the external monitor](#))
- This connects with an external monitor etc. and outputs a video signal.

■ Right side

■ Left side

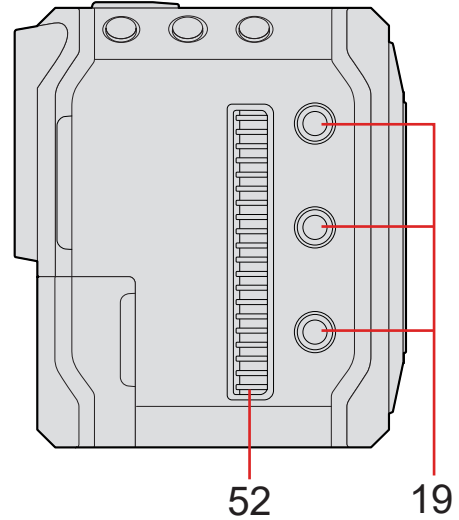
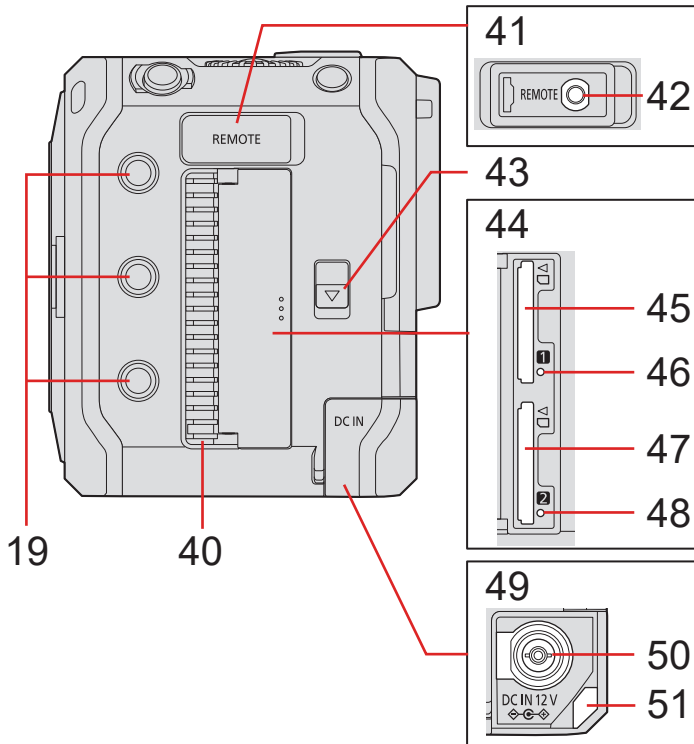

- 40 Fan outlet
  - The fan outlet for the cooling fan. Do not block it when using this camera.
- 41 REMOTE terminal cover
  - Keep the REMOTE terminal cover out of reach of children to prevent swallowing.
- 42 [REMOTE] terminal (➔ [145 / Using a remote control unit](#))
  - You can control a part of the function remotely by connecting the remote control unit (commercially available) to the camera. (A Panasonic shutter remote control (DMW-RS2) cannot be used.)
- 43 Card door release lever
- 44 Card door
- 45 Card slot 1 (➔ [30 / Inserting Cards \(Optional\)](#))
- 46 Card access light 1
- 47 Card slot 2 (➔ [30 / Inserting Cards \(Optional\)](#))
- 48 Card access light 2
- 49 DC IN terminal cover
  - Keep the DC IN terminal cover out of reach of children to prevent swallowing.
- 50 [DC IN 12 V] terminal (➔ [21 / Supplying power with an AC adaptor](#))
- 51 Cable lock band attachment part (➔ [28 / Attaching the Cable Lock Band](#))
- 52 Fan Inlet
  - The fan inlet for the cooling fan. Do not block it when using this camera.

- The terminal cover is attached to the camera upon purchase. You can remove the terminal cover from the camera.
- When connecting a BNC cable to the [GENLOCK IN] terminal or [TC IN/OUT] terminal, use one that is less than 2.8 m (9.1 feet).  
It is recommended to use a double shielded BNC cable equivalent to 5C-FB.

# 2. Getting Started

## Power supply

You can supply power to the camera using an AC adaptor (supplied), a PoE+\*<sup>1</sup> compatible switching hub or PoE+ compatible injector (commercially available), and a battery pack (optional)\*<sup>2</sup>.

\*<sup>1</sup> PoE+ is an abbreviation of Power Over Ethernet Plus.

\*<sup>2</sup> This will be referred to as “battery pack” or “battery” onwards.

- When several power supplies are connected at the same time, it will be prioritized in the order of AC adaptor, PoE+ power supply and then battery.
- The battery that can be used with the camera is AG-VBR59/AG-VBR89/AG-VBR118. (As of October 2020)

### Supplying power with an AC adaptor

Connect the supplied AC adaptor and AC cable to the camera to supply power (power supply).

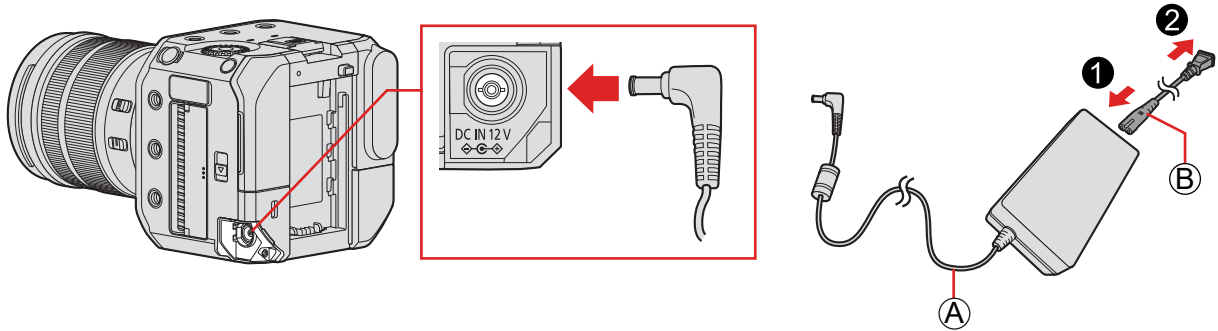

Ⓐ AC adaptor (supplied)

Ⓑ AC cable (supplied)

**1** Connect the AC adaptor to the [DC IN 12 V] terminal of the camera.

**2** Connect the AC cable to the AC adaptor, then plug it into the power outlet.

- The AC cable is for this camera only, so do not use it with other devices. Additionally, do not use the AC cable of other devices with this camera.

- Do not use any other AC adaptors except the supplied one. This may cause malfunction.
- Do not use any other AC cables except the supplied one. This may cause malfunction.
- Turn off the camera before connecting or disconnecting the power plug.
- Do not leave any metal items (such as clips) near the contact areas of the power plug. Otherwise, a fire and/or electric shocks may be caused by short-circuiting or the resulting heat generated.
- Do not use the AC adaptor and AC cable with other devices. This may cause malfunction.
- If there is a power outage or other problems with the electrical outlet, please reconnect the power plug.
- Power is being consumed even if the camera is turned off. When the camera will not be used for a long time, remove the power plug from the electrical outlet in order to save power.

## Supplying power from a PoE+ power supply

This camera is PoE+ (IEEE 802.3at compliant) compatible. Connect the camera to a PoE+ compatible switching hub or PoE+ compatible injector to supply power (power supply).

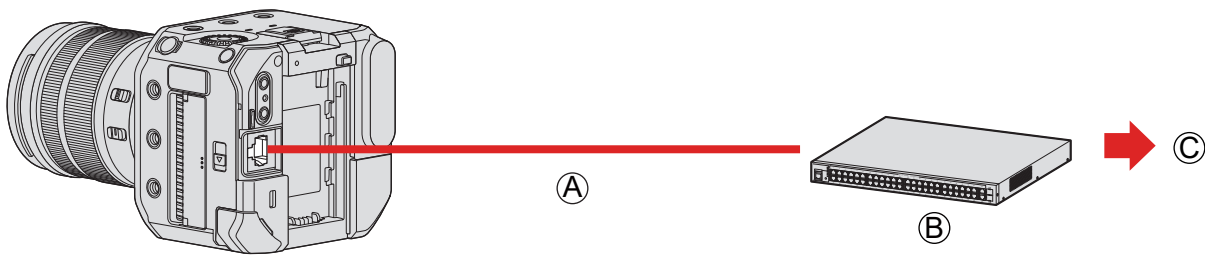

- Ⓐ PoE+ compatible LAN cable (commercially available)
- Ⓑ PoE+ compatible switching hub (commercially available)
- Ⓒ Power plug

### 1 Connect the [LAN] terminal of the camera and the PoE+ compatible switching hub with a PoE+ compatible LAN cable.

- For the cable that connects to the LAN terminal, use the one below.
  - LAN cable (STP (Shielded Twisted Pair), category 5e or above, maximum 100 m (328 feet))
- **Use a PoE+ (IEEE 802.3at compliant) compatible switching hub or power supplying device. <sup>\*1</sup> (Not all PoE+ (IEEE 802.3at compliant) compatible device operations are guaranteed.)**
  - <sup>\*1</sup> Make sure it complies with the safety standards IEC 60950-1 or IEC 62368-1. If you are uncertain on whether or not it complies with the safety standards, please contact the manufacturer of the switching hub or power supplying device.
- You cannot use a PoE (IEEE 802.3af compliant) switching hub or power supplying device.
- After turning the camera on, when the device or cable used is determined PoE+ incompatible by the camera, the camera automatically turns off. (Determining may take approximately 3 minutes.)
- The camera's Wi-Fi connection, Bluetooth connection, and USB connection cannot be used while supplying power with PoE+.
- If you connect a PC to a switching hub that supplies power to the camera with PoE+ via a LAN cable, you can remotely control the camera with the software "LUMIX Tether" while supplying power to the camera with PoE+.

## Turning the camera on

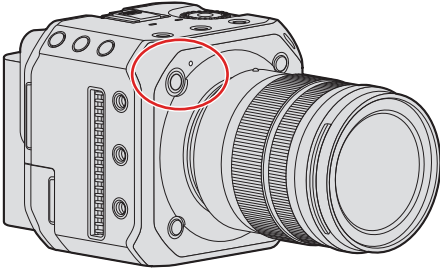

### 1 Turning the camera on.

- Press and hold the camera ON/OFF button for more than one second.
- The status indicator will light up.
- You can change the language displayed on the screen from [Language] ([G]) in the [Setup] ([Others]) menu.

## Turning the camera off

### 1 Turning the camera off.

- Press and hold the camera ON/OFF button for more than two seconds.
- The status indicator will go off.

## Power Indications

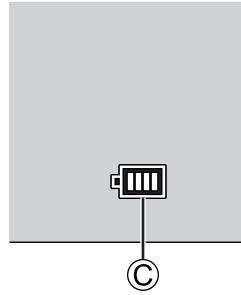
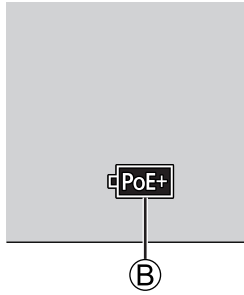
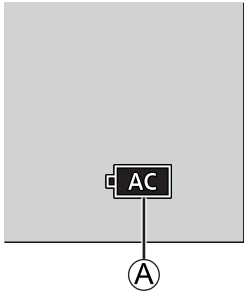

- Ⓐ When supplying power with an AC adapter
- Ⓑ When supplying power by connecting to a PoE+ compatible switching hub
- Ⓒ Battery indication

### ■ Status indicator

This informs you about the camera status with the lamp. (➔ [248 / Lamp / Indicator Display](#))

### ■ Battery indication

	75% or higher
	74% to 50%
	49% to 25%
	24% or below
 <b>Blinking in red</b>	Low battery <ul style="list-style-type: none"> <li>• Charge or replace the battery.</li> </ul>

- The battery level indicated on the screen is an approximate. The exact level varies depending on the environment and the operating conditions. The actual battery level may differ from the battery level displayed in the indication.
- To ensure that safe products are used, we recommend that a genuine Panasonic battery pack is used. There is a possibility that other battery packs may lead to fire or explosion. Please be advised that we are not liable for any accident or failure occurring as a result of use of a counterfeit battery pack.



# Attaching a Lens

- Change the lens in a location where there is not a lot of dirt and dust. If dirt or dust gets on the lens (➔ [257 / Dirt on the image sensor](#))
- Change the lens while the lens cap is attached.

## 1 Turn the camera off.

- Press and hold the camera ON/OFF button for more than two seconds.

## 2 Turn the lens rear cap and the body cap in the direction of the arrow to remove them.

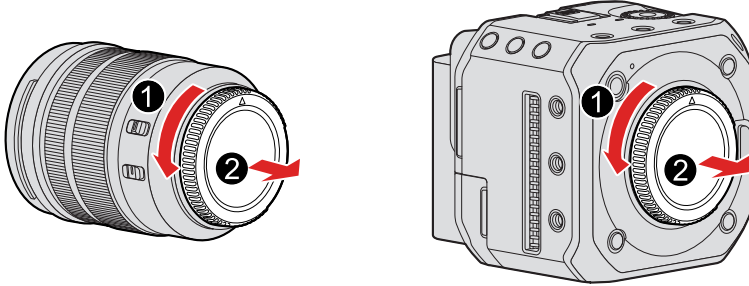

## 3 Align the lens fitting marks on the lens and camera and then rotate the lens in the direction of the arrow.

- Attach the lens by rotating it until it clicks.

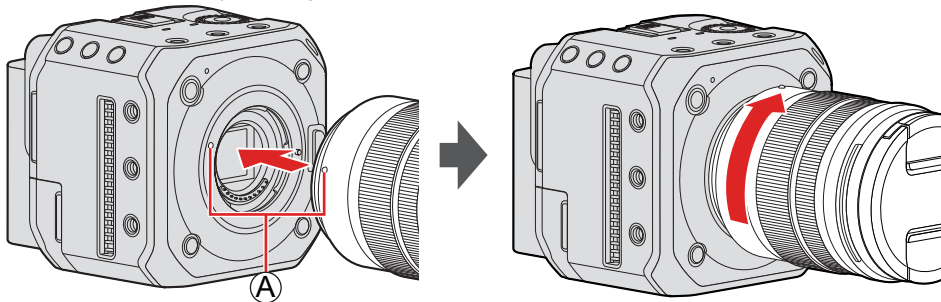

Ⓐ Lens fitting mark

- Insert the lens straight in. Inserting this at an angle to attach it may damage the camera lens mount.

## Removing a Lens

- ❶ Turn the camera off.
  - Press and hold the camera ON/OFF button for more than two seconds.
- ❷ While pressing the lens release button, rotate the lens in the direction of the arrow until it stops and then remove it.

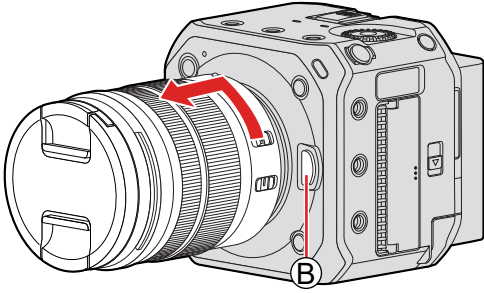

Ⓑ Lens release button

- After removing the lens, be sure to attach the body cap and the lens rear cap.

# Connecting the external monitor

Connect the camera to an external monitor or external recorder etc. to output video and audio.

## Connecting to the external monitor

Preparation:

- Turn off the camera, external monitor, or external recorder etc.

### 1 Connect the camera and external monitor or external recorder with an HDMI cable or BNC cable.

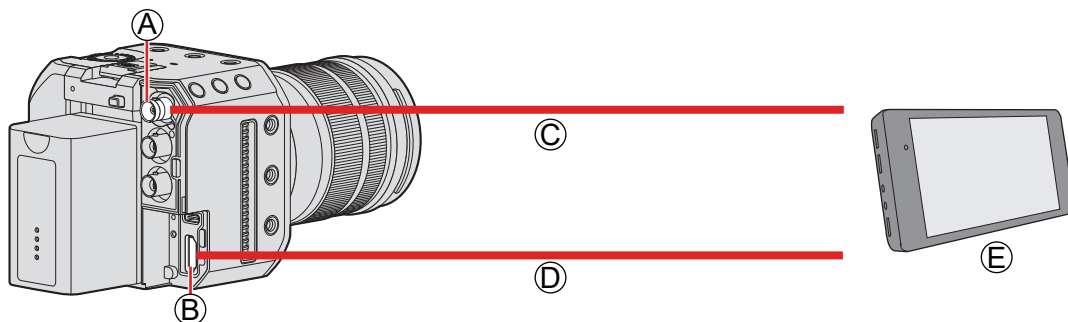

- (A) [SDI OUT] terminal
- (B) [HDMI] terminal
- (C) BNC cable (commercially available)
- (D) HDMI cable (commercially available)
- (E) External monitor or external recorder (commercially available)

- Check the direction of the terminals and plug in/out straight holding onto the plug. (Inserting at an angle can deform the terminal and cause malfunction.)
- Do not connect the cable to the wrong terminals. This may cause a malfunction.

#### ■ When the images are not output (→ [251 / External device](#))

#### ■ Settings of the display (→ [39 / Display Settings](#))

- The recording information or menu screen will only be output to either the HDMI output destination or SDI output destination. You can set where to display it in [Display Information].

#### ■ Output image settings (→ [133 / 7. Output image](#))

- Sets the resolution etc. of the footage to be output to the external device during recording.

- It is recommended to use a double shielded BNC cable equivalent to 5C-FB.
- Use a high speed HDMI cable (Type A - Type A plug) that is compatible with 4K and has an HDMI logo.
- You can output via HDMI and SDI at the same time. You can also connect to either “LUMIX Tether” or “LUMIX Sync” at the same time.
- If you do not have an external monitor or external recorder, you can watch the live view while remotely controlling the camera by connecting a PC that has the “LUMIX Tether” software installed to the camera. (➔ [207 / Tethered Recording](#))

## Attaching the Cable Lock Band

Use of the supplied cable lock band prevents detachment of the cable and damage to the terminals.

- Put the camera on a stable surface to perform this task.

**1** Loosely mount the cable lock band to the cable lock band mount on the camera, and then rotate the screws in the direction of the arrows to secure the cable lock band.

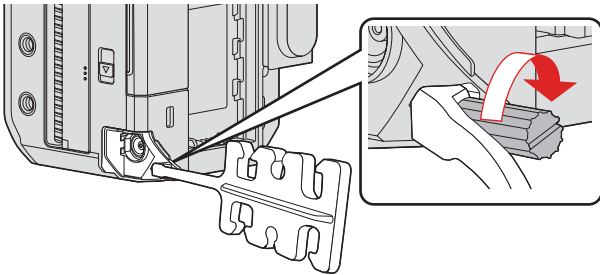

**2** Connect the AC adaptor, the HDMI cable and the USB connection cable to the camera.

**3** Fit the AC cable to the clamp.

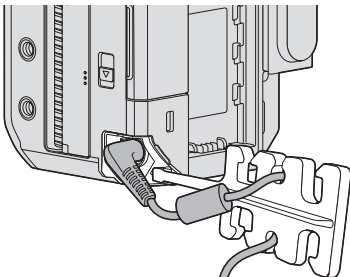

**4** Fit the HDMI cable and USB connection cable to the clamp.

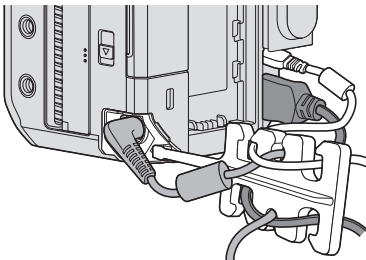

■ **Removing the cable lock band**

- To remove the cable lock band, follow the steps for attaching it in the reverse order.
- It may not be possible to attach HDMI cables or USB connection cables depending on the shape.

# Inserting Cards (Optional)

This camera supports the double card slot function. When two cards are used, relay recording and backup recording are available.

## Inserting / removing the card

### 1 Open the card door.

- Slide the card door release lever to the direction of the arrow.

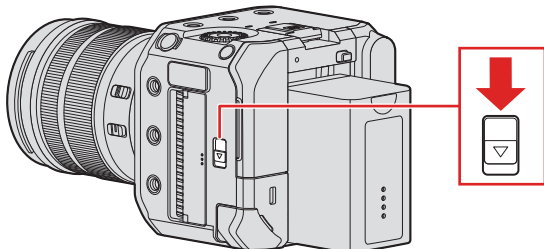

### 2 Insert the cards.

- Match the orientation of the cards as shown in the figure and then insert them firmly until they click.

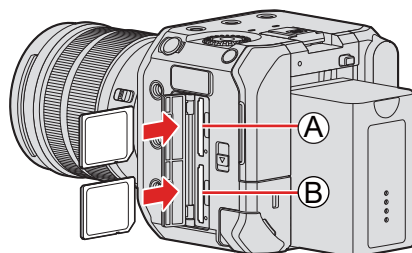

- Ⓐ Card slot 1
- Ⓑ Card slot 2

- Do not touch the card connection contacts Ⓒ.

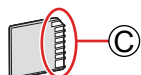

### 3 Close the card door.

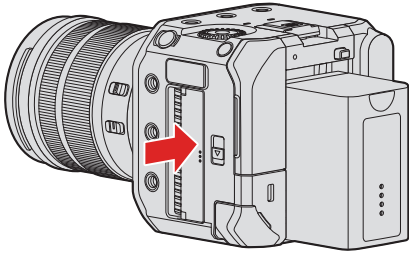

- The card will be displayed onto the screen of the output destination.

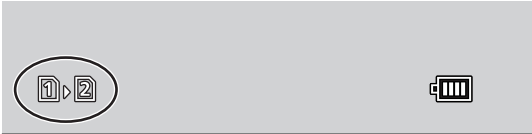

- You can set the way to record to card slots 1 and 2:  
[] → [] → [Double Card Slot Function] (➔ 34 / [Double Card Slot Function])

#### ■ Indications during card access

The card access light **A** turns on while the card is being accessed.

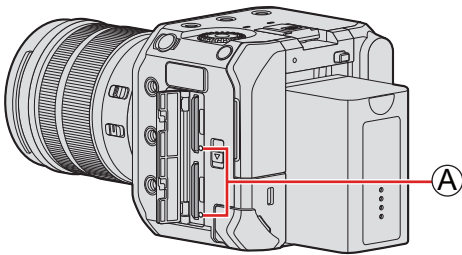

- **Do not perform the following operations during access. The camera may operate incorrectly or the card and recorded images may be damaged.**
  - Turn off the camera. (Pressing the camera ON/OFF button, stopping power supply, or removing the battery.)
  - Remove the card
  - Subject the camera to vibration, impacts, or static electricity.
- You can set so that the card access light does not turn on:  
[] → [] → [Card Access Light] (➔ 196 / [Card Access Light])

## Removing a Card

- ① Open the card door.
- ② Push the card until it clicks and then pull the card out straight.

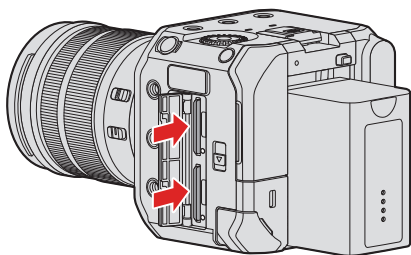

- The card may be warm just after the camera has been used.

## Formatting Cards (Initialization)

Format the cards with the camera before use in order to ensure optimal card performance.

- **When a card is formatted, all of the data stored in the card is erased and cannot be restored. Save a backup of necessary data before formatting the card.**

[MENU/SET] → [ ] → [ ] → Select [Card Format]

Settings: [Card Slot 1] / [Card Slot 2]

- Do not turn off the camera or perform another operation during formatting.
- Take care not to turn off the camera while formatting is in progress.
- If the card has been formatted with a PC or other device, format it again with the camera.
- You can format the card while keeping the camera settings information stored on the card:  
 [ ] → [ ] → [Save/Restore Camera Setting] → [Keep Settings While Format] (→ [171](#) / [\[Save/Restore Camera Setting\]](#))



## [Folder / File Settings]

Set the folder and file name where to save the images.

Folder name	File name
100ABCDE 	PABC0001.MP4 

- ❶ Folder number (3 digits, 100 to 999)
- ❷ 5-character user-defined segment
- ❸ 3-character user-defined segment
- ❹ File number (4 digits, 0001 to 9999)
- ❺ Extension

[MENU/SET] → [F] → [C] → Select [Folder / File Settings]

<b>[Select Folder]*<sup>1</sup></b>	Selects a folder for storing images.
<b>[Create a New Folder]</b>	Creates a new folder with an incremented folder number. <ul style="list-style-type: none"> <li>• If there are no recordable folders in the card, a screen for resetting the folder number is displayed.</li> </ul> <b>[OK]:</b> Increments the folder number without changing the 5-character user-defined segment (❷ above). <b>[Change]:</b> Changes the 5-character user-defined segment (❷ above). This will also increment the folder number.
<b>[File Name Setting]</b>	<b>[Folder Number Link]:</b> Uses the 3-character user-defined segment (❸ above) to set the folder number (❶ above). <b>[User Setting]:</b> Changes the 3-character user-defined segment (❸ above).

\*<sup>1</sup> When [Double Card Slot Function] is set to [Allocation Rec], [Select Folder (Slot 1)] and [Select Folder (Slot 2)] will be displayed.

- Follow the steps on “Entering Characters” when the character entry screen is displayed. (→ [203 / Entering Characters](#))  
 Available characters: alphabetic characters (upper-case), numerals, [ \_ ]

- Each folder can store up to 1000 files.
- File numbers are assigned sequentially from 0001 to 9999 in the order of recording. If you change the storage folder, a number continuing on from the last file number will be assigned.
- In the following cases, a new folder with an incremented folder number will be created automatically when the next file is saved:
  - The number of files in the current folder reaches 1000.
  - The file number reaches 9999.
- New folders cannot be created when there are folders numbered from 100 all the way up to 999. We recommend backing up your data and formatting the card.
- [Select Folder] is not available when [Backup Rec] in [Double Card Slot Function] is being used.

**[File Number Reset]**

Refresh the folder number to reset the file number to 0001.

[MENU/SET] → [ ] → [ ] → Select [File Number Reset]



Settings: [Card Slot 1] / [Card Slot 2]

- When the folder number reaches 999, the file number cannot be reset. We recommend backing up your data and formatting the card.
- **To reset the folder number to 100:**
  - ① Perform [Card Format] to format the card. (→ [32 / Formatting Cards \(Initialization\)](#))
  - ② Perform [File Number Reset] to reset the file number.
  - ③ Select [Yes] on the folder number reset screen.

**[Double Card Slot Function]**

This sets the way recording to the card slots 1 and 2 is performed.

[MENU/SET] → [ ] → [ ] → Select [Double Card Slot Function]

<b>[Recording Method]</b>	 ([Relay Rec])	Selects the priority of card slots for recording. <b>[Destination Card Slot]: [1→2] / [2→1]</b> Relays recording to the card in the other card slot after the first card runs out of free space.
	 ([Backup Rec])	Records the same images to both cards simultaneously.
	 ([Allocation Rec])	Allows you to specify the card slot to be used for recording for different image formats. <b>[JPEG Destination]*1 / [Video Destination]</b>

\*1 You can use it when recording still images using the “LUMIX Tether” software.

**Notes about relay recording**

- The following video cannot be continued to be recorded on another card:
  - [Loop Recording (video)]

**Notes about Backup Recording**

- We recommend using cards with the same Speed Class rating and capacity.  
If the card Speed Class or capacity is insufficient when video recording, recording to both cards stops.
- Backup recording is not available with the following video. They can only be recorded on a single card:
  - [Loop Recording (video)]
- Video cannot be recorded when the following card combination is used.
  - SD memory card or SDHC memory card, and SDXC memory card

# Setting the Clock (When Turning On for the First Time)

When turning the camera on for the first time, to record the information of the correct time and date, make sure to set the clock and time zone before using. The clock will automatically advance from January 1, 2020 0:00:00 at the point the camera is turned on for the first time.

## Clock Set

### 1 Turn the camera on.

- Press and hold the camera ON/OFF button for more than one second.
- The status indicator will light up.

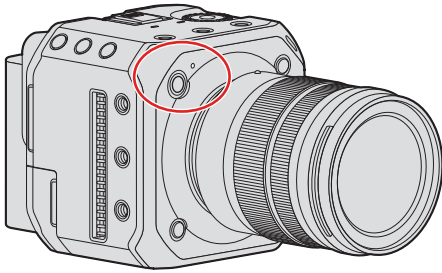

### 2 Select [Clock Set].

- [MENU/SET] → [ ] → [ ] → [Clock Set]

### 3 Set the clock.

◀▶ : Select an item (year, month, day, hour, minute, or second).

▲▼ : Select a value.

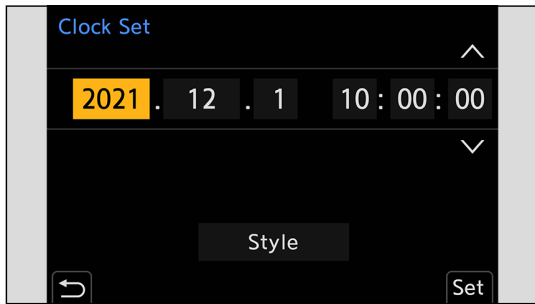

#### To set the display order and time display format

- The setting screen of the display order and time display format will be displayed if you select [Style] with ◀▶ and press [MENU/SET].

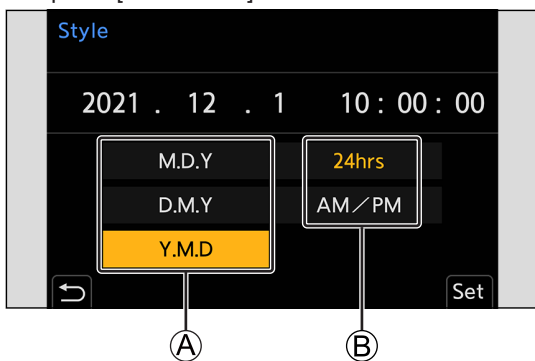

Ⓐ Display order

Ⓑ Time display format

### 4 Confirm your selection.

- Press [MENU/SET].

- The clock settings are maintained for approx. 3 months even without supplying power by using the built-in clock battery. (To charge the built-in battery, connect the AC adaptor (supplied) to the camera for more than approx. 24 hours while keeping the camera turned off.)

## Time zone

### 1 Display the setting screen of the [Time Zone].

- [MENU/SET] → [🔍] → [🌐] → [Time Zone]

### 2 Set the time zone.

- Select a time zone with ◀▶, and press [MENU/SET].
- If you are using Daylight Savings [🌞], press ▲. (The time will move forward by 1 hour.)  
To return to the normal time, press ▲ again.

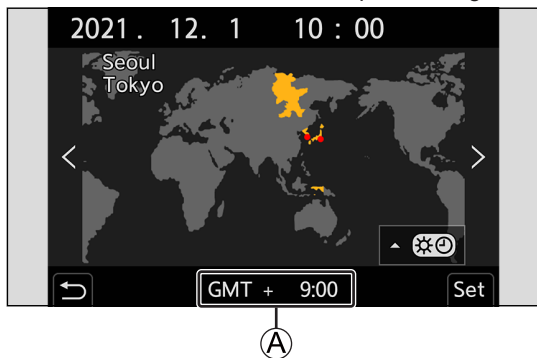

Ⓐ Time difference from GMT (Greenwich Mean Time)

# 3. Basic Operations

## Camera Setting Operations

When changing the camera settings, operate the camera using the following operation parts.

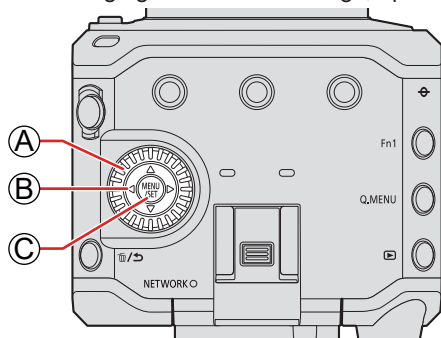

Ⓐ **Control dial** (⊙)

**Rotate:** Selects an item or numeric value.

Ⓑ **Cursor buttons** (▲▼◀▶)

**Press:** Selects an item or numeric value.

Ⓒ **[MENU/SET] button**

**Press:** Confirms a setting.

- Displays the menu during recording and playback.

# Display Settings

The recording information or menu screen will only be output to either the HDMI output destination or SDI output destination.

## Information Display (HDMI/SDI)

You can set the output destination of recording information or menu screen. The default setting is set to [AUTO].

[MENU/SET] →  →  → Select [Info Display (HDMI/SDI)]

[AUTO]	Only displays to the external device connected via HDMI. When it is not connected via HDMI, it will be displayed on the external device connected via SDI. (when [SDI Output] is [ON]).
[HDMI]	Only displays to the external device connected via HDMI.
[SDI]	Only displays to the external device connected via SDI. (when [SDI Output] is [ON]).
[OFF]	Neither will be displayed.

- For external devices not set in the output destination of the information, the whole screen or part of the screen will be displayed in black depending on the setting screen.
- By pressing [Fn1], you can switch the settings of [Info Display (HDMI/SDI)] in the order of [AUTO], [HDMI], [SDI], and [OFF].
  - [Info Display (HDMI/SDI)] is assigned to the [Fn1] at default setting.
  - About Fn buttons (➔ [154 / Fn Buttons](#))
- When the menu screen is not output to the external monitor, you can reset the [Info Display (HDMI/SDI)] settings to [AUTO] by pressing [MENU/SET], [Q.MENU], and [Fn3] at the same time.

## Output destination screen display

The following icons will be displayed on the output destination screen upon purchase.

- For information about the icons other than those described here (➔ [239 / External Monitor Displays](#))

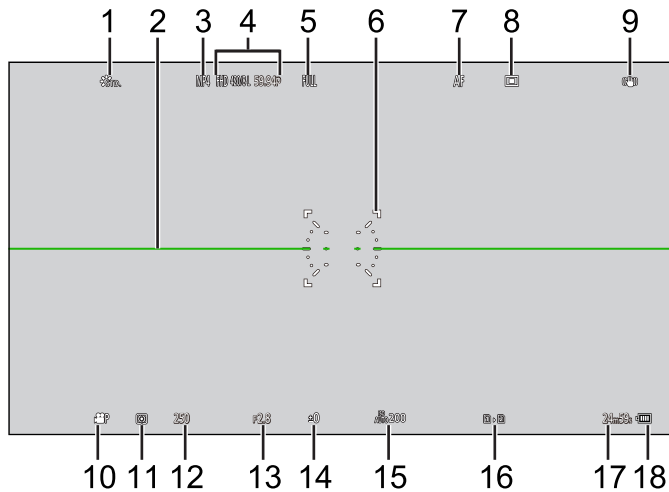

- 1 [Photo Style]
- 2 Level gauge
- 3 [Rec. File Format]
- 4 [Rec Quality]
- 5 [Image Area of Video]
- 6 AF area
- 7 [Focus Mode]
- 8 [AF Mode]
- 9 [Image Stabilizer]
- 10 [Exposure Mode]
- 11 [Metering Mode]
- 12 Shutter speed
- 13 Aperture value
- 14 Exposure compensation value
- 15 [Sensitivity]
- 16 Card slot / [Double Card Slot Function]
- 17 Video recording time
- 18 Power supply



## Switching the Display Information

The recording information (icons) on the recording screen and playback screen can be hidden. You can also display the control panel.

### 1 Set [Display Information].

- [MENU/SET] → [⚙️] → [📺] → [Display Information]

Settings:

**[Display Info in Rec Mode]:** [WITH INFO] / [WITHOUT INFO] / [CTRL PANEL]

**[Display Info in Playback]:** [WITH INFO] / [DETAILED INFO DISP] / [WITHOUT INFO]

[WITH INFO]	Display information (icons) to the recording screen/playback screen.
[WITHOUT INFO]	Do not display information (icons) to the recording screen/playback screen.
[CTRL PANEL]	Display control panel when recording. (➡️ 43 / <a href="#">Control Panel</a> )
[DETAILED INFO DISP]	Display detailed information to the playback screen.

## Switch the information display with a Fn button

If you register the [Display Information] to a Fn button, the display switches every time you press that Fn button.

- About Fn buttons (➔ [155 / Register Functions to the Fn Buttons](#))

### ■ Recording Screen

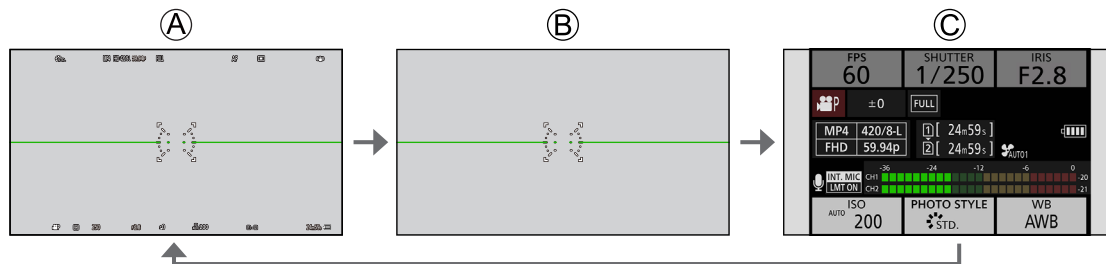

- Ⓐ [WITH INFO]
- Ⓑ [WITHOUT INFO]
- Ⓒ [CTRL PANEL]

### ■ Playback Screen

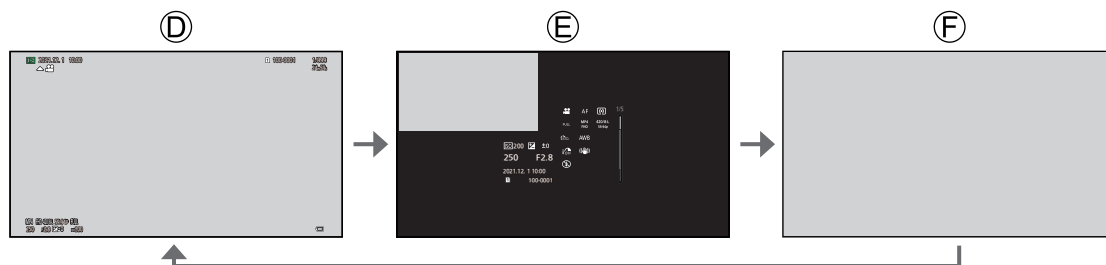

- Ⓓ [WITH INFO]
- Ⓔ [DETAILED INFO DISP]\*1
- Ⓕ [WITHOUT INFO]

\*1 Pressing ▲▼ switches the display information. (➔ [246 / Detailed information display screen](#))

- You can switch between displaying or not displaying the level gauge at [Level Gauge]. (➔ [189 / \[Level Gauge\]](#))

# Control Panel

This screen allows you to view the current recording settings on the monitor.

## 1 Display the control panel.

- [MENU/SET] → [⚙️] → [📷] → [Display Information] → [Display Info in Rec Mode] → [CTRL PANEL]

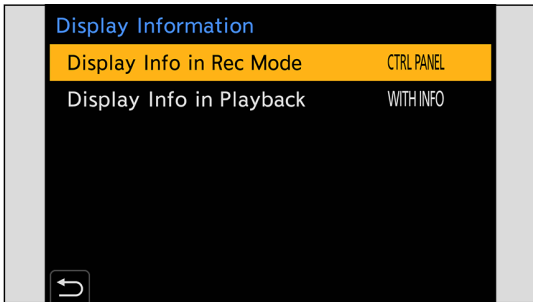

## 2 Close the menu.

- Press [↩️] several times.

## 3 Select a menu item.

- Press ▲▼◀▶.

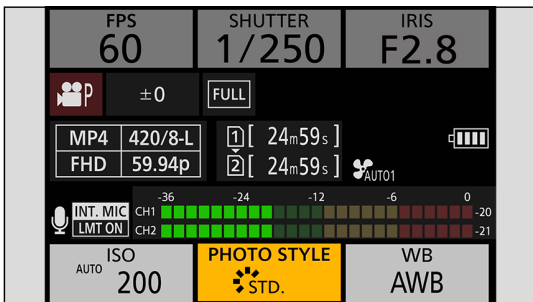

## 4 Change the setting.

- Rotate ⚙️ to select a setting.
- Refer to the pages explaining each item for information on how to change the settings.

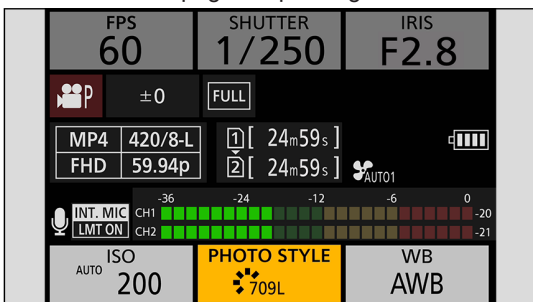

# Quick Menu

This menu enables you to quickly set functions that are frequently used during recording without calling up the menu screen. You can also change the Quick menu display method and the items to display.

## 1 Display the Quick menu.

- Press [Q.MENU].

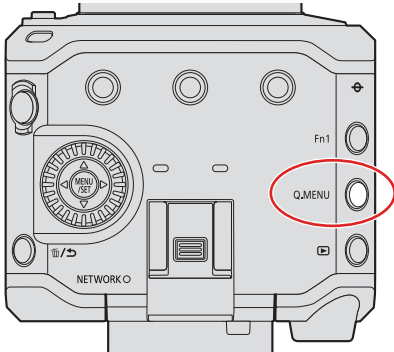

## 2 Select a menu item.

- Press ▲▼◀▶.



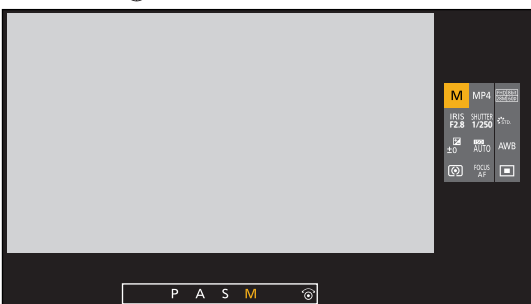

## 3 Select a setting item.

- Rotate ⚙️.



## 4 Close the Quick menu.

- Press [Q.MENU].

- Some items cannot be set depending on the recording mode or camera settings.
- The Quick menu can be customized:  
[] → [] → [Q.MENU Settings] (➔ [161 / Quick Menu Customization](#))

# Menu Operation Methods

In this camera, the menu is used for setting a wide variety of functions and performing camera customizations.

## Menu operation

### Configuration of the menu

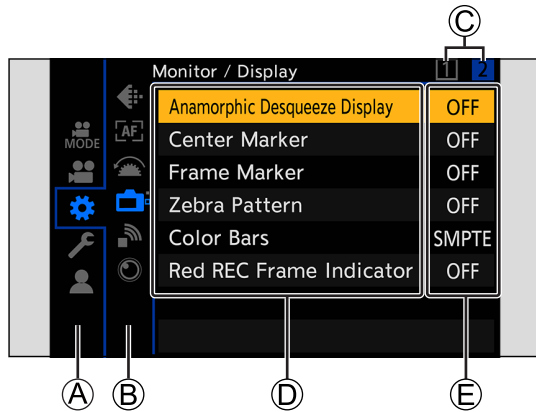

- Ⓐ Main tab
- Ⓑ Sub tab
- Ⓒ Page tab
- Ⓓ Menu item
- Ⓔ Setting item

## 1 Display the menu.

- Press [MENU/SET].

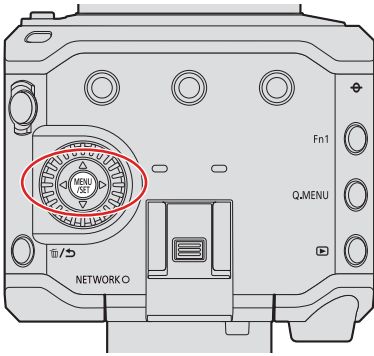

## 2 Select a main tab.

- Press ▲▼ to select a main tab and then press ►.
- You can also perform the same operation by pressing [Q.MENU] or by rotating  to select a main tab, then pressing [MENU/SET].

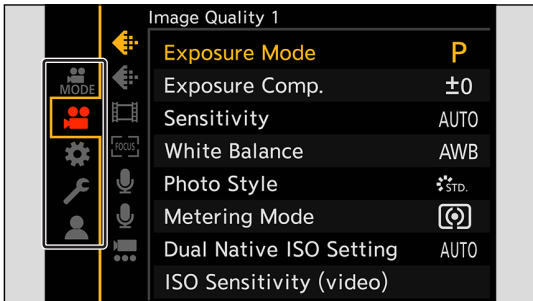

## 3 Select a sub tab.

- Press ▲▼ to select a sub tab and then press ►.
- You can also perform the same operation by rotating  to select a sub tab, then pressing [MENU/SET].

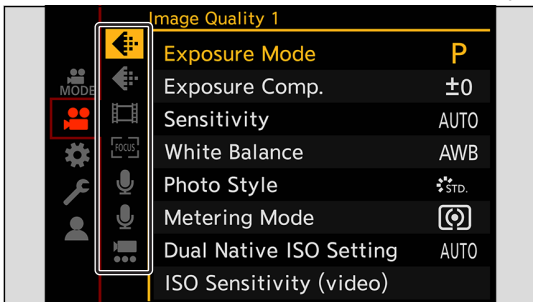

- If there are page tabs, after the page tabs  have finished switching, it is switched to the next sub tab.



## 4 Select a menu item.

- Press ▲▼ to select a menu item and then press ►.
- You can also perform the same operation by rotating  to select a sub tab, then pressing [MENU/SET].

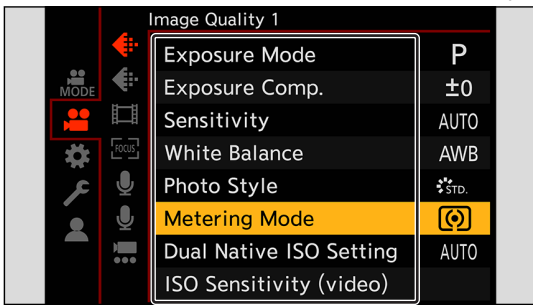

## 5 Select a setting item and then confirm your selection.

- Select a setting item with ▲▼, then press [MENU/SET].
- You can also perform the same operation by rotating  to select a setting item, then pressing [MENU/SET].

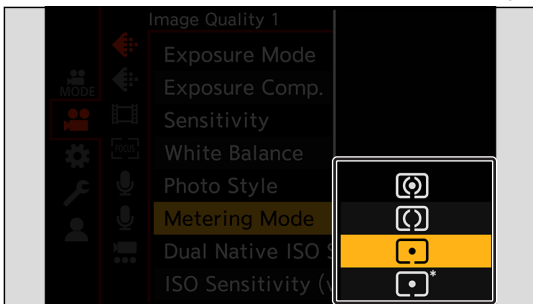

## 6 Close the menu.

- Press [L/+] several times.

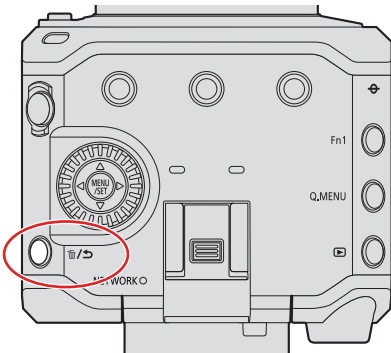

- For details about menu items, refer to Menu Guide. (➔ [172 / 11. Menu Guide](#))



## Displaying Descriptions About Menu Items and Settings

When you press a Fn button that has the [Display Information] function registered while a menu item or setting item is selected, the details of that menu will be displayed on the screen.

- About Fn buttons (➔ [155 / Register Functions to the Fn Buttons](#))

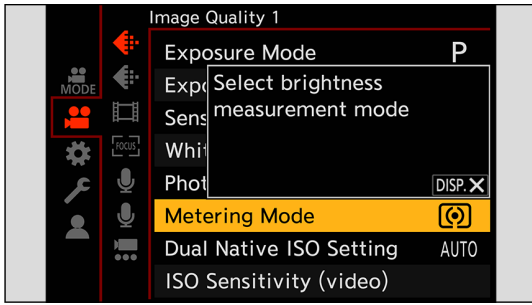

## Grayed Out Menu Items

Menu items that cannot be set are displayed grayed out.

When you press [MENU/SET] while a grayed out menu item is selected, the reason why it cannot be set will be displayed. The reason why a menu item cannot be set may not be displayed depending on the menu item.

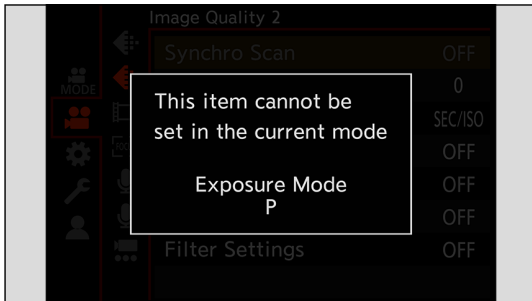

**[Reset]**

Return each of the following settings to the default setting:

- Recording settings
- Network settings (Settings of [LAN / Wi-Fi] and [Bluetooth], password when connected to the camera with the "LUMIX Tether" software.)
- Setup and custom settings (Anything other than [LAN / Wi-Fi] and [Bluetooth].)

[MENU/SET] → [f] → [⚙] → Select [Reset]

### ■ When the menu screen does not display to the external device

- ① Press [Q.MENU], [Fn2], and [Fn4] at the same time.
  - After all the lamps blink for approx. 5 seconds, the camera automatically shuts off and then turns on again.
  - The recording setting, network setting, and set up/custom setting returns to the default setting.

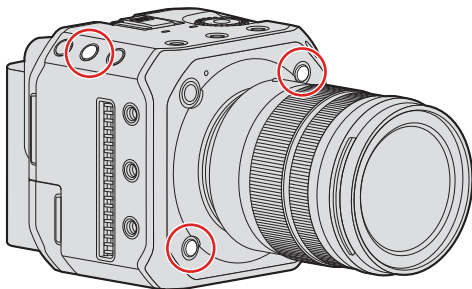

- If the setup and custom settings are reset, the [Playback] menu is also reset.
- The folder numbers and clock settings are not reset.
- List of default settings and settings that can be reset (➔ [266 / List of Default Settings / Custom Saving / Settings Available for Copying](#))

# 4. Recording Videos

## Recording Videos

It is possible to record video with a maximum resolution of C4K (4096x2160) on this camera. It also supports switching of the system frequency and 2 types of recording file format; MP4 and MOV.

### Recording Videos

#### 1 Start recording.

- Press the video rec. button **(A)**.
- Release the video rec. button right after you press it.
- During video recording, the front tally lamp **(B)** and rear tally lamp **(C)** light.

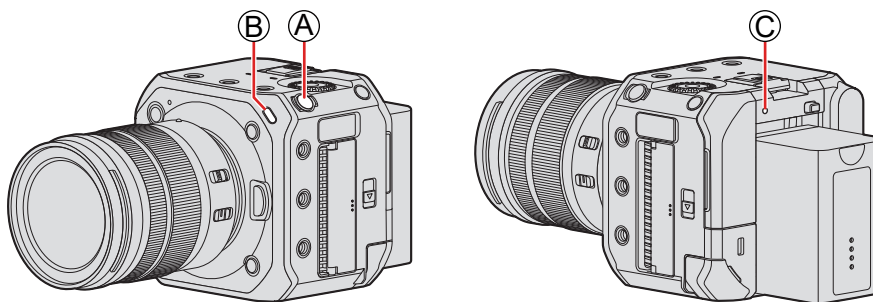

#### 2 Stop recording.

- Press the video rec. button **(A)** again.

## Screen Displays While Video Recording

The video recording time (D) and elapsed recording time (E) will be displayed.

- The recording state indication (F) and card access indication (G) turn red while videos are being recorded.

















- When the remaining capacity of the battery or card gets low during video recording, the tally lamps blink at long intervals. When there is no remaining capacity in the battery or card, video recording is stopped and the tally lamps blink at short intervals.
- If an operation such as a zoom or button operation is performed during video recording, that operation sound may be recorded.
- The lens operation sound (AF and image stabilizer) may be recorded to video.
- If the operation sound of pressing the video rec. button to end recording bothers you, try the following:
  - Record by remotely operating the camera (➔ [204 / 12. Remote Operations](#))
  - Connect a remote control unit (commercially available) that is compatible with the camera to the [REMOTE] terminal to record.
- Depending on the type of card, the card access indication may appear for a while after video recording. This is not a malfunction.
- Depending on the external device, during playback, situations such as image or sound quality being poor, recording information not being displayed correctly, or playback not being possible may occur.
- If the camera temperature rises, [△] may be displayed and recording may stop. Wait until the camera cools down.
- You can change the tally lamp that turns on. You can also change the settings so the tally lamps do not turn on:
  - [Settings] ➔ [Tally Lamp] ➔ [192 / \[Tally Lamp\]](#)
- You can display a red frame on the recording screen that indicates that video is being recorded:
  - [Settings] ➔ [Red REC Frame Indicator] ➔ [191 / \[Red REC Frame Indicator\]](#)



## [Exposure Mode]

### 1 Set the exposure mode.

- [MENU/SET] → [ ] → [ ] → [Exposure Mode]

<b>P</b>	With [P] mode (Program AE mode), the camera automatically sets the shutter speed and aperture value according to the subject's brightness.
<b>A</b>	<p>With [A] mode (Aperture-Priority AE Mode), you can set the aperture value and record.</p> <p><b>① Set the aperture value.*1</b></p> <ul style="list-style-type: none"> <li>• Rotate .</li> <li>• When wearing headphones, you can adjust the volume by rotating . You can switch to aperture value setting operations by pressing .</li> </ul> <p>(The operation switches back to volume adjustment if you press  again.)</p>
<b>S</b>	<p>With [S] mode (Shutter-Priority AE mode), you can adjust the shutter speed and record.</p> <p><b>① Set the shutter speed.*2</b></p> <ul style="list-style-type: none"> <li>• Rotate .</li> <li>• When wearing headphones, you can adjust the volume by rotating . You can switch to shutter speed setting operations by pressing .</li> </ul> <p>(The operation switches back to volume adjustment if you press  again.)</p>
<b>M</b>	<p>With [M] mode (Manual exposure mode) you can adjust the aperture value and shutter speed manually and record.</p> <p><b>① Set the shutter speed and aperture value.*1, *2</b></p> <ul style="list-style-type: none"> <li>• Rotate . (Every time  is pressed, the shutter speed setting operation and aperture value setting operation is switched.)</li> <li>• When wearing headphones, you can adjust the volume by rotating . You can switch to shutter speed setting operation, aperture value setting operation, and volume adjustment operations each time you press .</li> <li>• The ISO sensitivity is set to [AUTO] in the default setting. For that reason, the ISO sensitivity will be set according to the aperture value and shutter speed. When ISO sensitivity is set to [AUTO], exposure compensation can also be used.</li> </ul> <p><b>Manual Exposure Assist</b></p> <p>When ISO sensitivity is set to other than [AUTO], Manual Exposure Assist (example: +1) will be displayed on the recording screen.</p> <p>You can check the difference between the current exposure value and the correct exposure (<math>\pm 0</math>) measured by the camera.</p> <ul style="list-style-type: none"> <li>• Use Manual Exposure Assist as a guide. We recommend checking the images on the playback screen when recording.</li> </ul>

\*1 At default setting, [Aperture Value] is assigned to [Fn2]. You can press [Fn2] to display the setting screen of the aperture value and rotate  to set the aperture value.

\*2 [Shutter Speed] is assigned to the  at default setting. You can display the setting screen of the shutter speed by pressing the  and set the shutter speed by rotating .

- About Fn buttons (➔ [154 / Fn Buttons](#))

- The brightness of the recording screen and of actual recorded images may differ. Check the images on the playback screen.
- When using a lens with an aperture ring, set the position of the aperture ring to other than [A] to use the aperture value of the lens.

# Recording Settings For Video

This section describes the settings used when video recording.

## [System Frequency]

This changes the system frequency of videos that are recorded and played back.

The default setting is for the system frequency to be set to the TV broadcast system for the region where the camera was bought.

[MENU/SET] →  →  → Select [System Frequency]

<b>[59.94Hz (NTSC)]</b>	System frequency for regions using the NTSC broadcasting system
<b>[50.00Hz (PAL)]</b>	System frequency for regions using the PAL broadcasting system
<b>[24.00Hz (CINEMA)]</b>	System frequency for producing cinema film

- After changing the setting, turn the camera off and on.
- If you record using a system frequency that differs from the broadcasting system of your region, it may not be possible for you to properly playback videos on your TV.
- A video recorded with a system frequency different from the setting of [System Frequency] cannot be played back in the camera.

## [Rec. File Format]

Sets the recording file format of videos to be recorded.

[MENU/SET] →  →  → Select [Rec. File Format]

<b>[MP4]</b>	This file format is suitable for playback on PCs.
<b>[MOV]</b>	This file format is suitable for image editing.

- When [System Frequency] is set to [24.00Hz (CINEMA)], it is fixed to [MOV].

## [Rec Quality]

Sets the image quality of videos to be recorded. The image qualities you can select depend on the [System Frequency] and [Rec. File Format] settings.

[Rec Quality] settings can also be made using [Filtering] (➔ 60 / [Filtering]) to display only items that meet your conditions and [add to list] (➔ 60 / [add to list]) to register recording qualities you use often.

[MENU/SET] ➔ [ ] ➔ [ ] ➔ Select [Rec Quality]

- To record video with a bit rate of 72 Mbps or more, it requires a card with the corresponding Speed Class. (➔ 16 / Memory Cards That Can Be Used)

## [Rec. File Format]: [MP4]

- Image compression: Long GOP
- Audio format: AAC (2ch)

- Ⓐ Recording frame rate
- Ⓑ Bit rate
- Ⓒ YUV/bit
- Ⓓ Video compression format
  - HEVC: H.265/HEVC
  - AVC: H.264/MPEG-4 AVC

### ■ [System Frequency]: [59.94Hz (NTSC)]

[Rec Quality]	Resolution (Aspect ratio)	Ⓐ / Ⓑ / Ⓒ / Ⓓ
[4K/10bit/100M/60p]	3840x2160 (16:9)	59.94p / 100 Mbps / 4:2:0/10 bit / HEVC
[4K/8bit/100M/30p]		29.97p / 100 Mbps / 4:2:0/8 bit / AVC
[4K/10bit/72M/30p]		29.97p / 72 Mbps / 4:2:0/10 bit / HEVC
[4K/8bit/100M/24p]		23.98p / 100 Mbps / 4:2:0/8 bit / AVC
[4K/10bit/72M/24p]		23.98p / 72 Mbps / 4:2:0/10 bit / HEVC
[FHD/8bit/28M/60p]	1920x1080 (16:9)	59.94p / 28 Mbps / 4:2:0/8 bit / AVC
[FHD/8bit/20M/30p]		29.97p / 20 Mbps / 4:2:0/8 bit / AVC
[FHD/8bit/24M/24p]		23.98p / 24 Mbps / 4:2:0/8 bit / AVC

### ■ [System Frequency]: [50.00Hz (PAL)]

[Rec Quality]	Resolution (Aspect ratio)	Ⓐ / Ⓑ / Ⓒ / Ⓓ
[4K/10bit/100M/50p]	3840x2160 (16:9)	50.00p / 100 Mbps / 4:2:0/10 bit / HEVC
[4K/8bit/100M/25p]		25.00p / 100 Mbps / 4:2:0/8 bit / AVC
[4K/10bit/72M/25p]		25.00p / 72 Mbps / 4:2:0/10 bit / HEVC
[FHD/8bit/28M/50p]	1920x1080 (16:9)	50.00p / 28 Mbps / 4:2:0/8 bit / AVC
[FHD/8bit/20M/25p]		25.00p / 20 Mbps / 4:2:0/8 bit / AVC



**[Rec. File Format]: [MOV]**

- Audio format: LPCM (2ch)

- Ⓐ Recording frame rate
- Ⓑ Bit rate
- Ⓒ YUV/bit
- Ⓓ Video compression format
  - **HEVC:** H.265/HEVC
  - **AVC:** H.264/MPEG-4 AVC
- Ⓔ Image compression

**■ [System Frequency]: [59.94Hz (NTSC)]**

[Rec Quality]	Resolution (Aspect ratio)	Ⓐ / Ⓑ / Ⓒ / Ⓓ / Ⓔ
[4K-A/60p/420/8-L]	3328x2496 (4:3)	59.94p / 150 Mbps / 4:2:0/8 bit / AVC / Long GOP
[4K-A/30p/422/10-I]		29.97p / 400 Mbps / 4:2:2/10 bit / AVC / ALL-Intra
[4K-A/30p/422/10-L]		29.97p / 150 Mbps / 4:2:2/10 bit / AVC / Long GOP
[4K-A/30p/420/8-L]		29.97p / 100 Mbps / 4:2:0/8 bit / AVC / Long GOP
[4K-A/24p/422/10-I]		23.98p / 400 Mbps / 4:2:2/10 bit / AVC / ALL-Intra
[4K-A/24p/422/10-L]		23.98p / 150 Mbps / 4:2:2/10 bit / AVC / Long GOP
[4K-A/24p/420/8-L]		23.98p / 100 Mbps / 4:2:0/8 bit / AVC / Long GOP
[C4K/60p/420/10-L]	4096x2160 (17:9)	59.94p / 200 Mbps / 4:2:0/10 bit / HEVC / Long GOP
[C4K/60p/420/8-L]		59.94p / 150 Mbps / 4:2:0/8 bit / AVC / Long GOP
[C4K/30p/422/10-I]		29.97p / 400 Mbps / 4:2:2/10 bit / AVC / ALL-Intra
[C4K/30p/422/10-L]		29.97p / 150 Mbps / 4:2:2/10 bit / AVC / Long GOP
[C4K/30p/420/8-L]		29.97p / 100 Mbps / 4:2:0/8 bit / AVC / Long GOP
[C4K/24p/422/10-I]		23.98p / 400 Mbps / 4:2:2/10 bit / AVC / ALL-Intra
[C4K/24p/422/10-L]		23.98p / 150 Mbps / 4:2:2/10 bit / AVC / Long GOP
[C4K/24p/420/8-L]	23.98p / 100 Mbps / 4:2:0/8 bit / AVC / Long GOP	
[4K/60p/420/10-L]	3840x2160 (16:9)	59.94p / 200 Mbps / 4:2:0/10 bit / HEVC / Long GOP
[4K/60p/420/8-L]		59.94p / 150 Mbps / 4:2:0/8 bit / AVC / Long GOP
[4K/30p/422/10-I]		29.97p / 400 Mbps / 4:2:2/10 bit / AVC / ALL-Intra
[4K/30p/422/10-L]		29.97p / 150 Mbps / 4:2:2/10 bit / AVC / Long GOP
[4K/30p/420/8-L]		29.97p / 100 Mbps / 4:2:0/8 bit / AVC / Long GOP
[4K/24p/422/10-I]		23.98p / 400 Mbps / 4:2:2/10 bit / AVC / ALL-Intra
[4K/24p/422/10-L]		23.98p / 150 Mbps / 4:2:2/10 bit / AVC / Long GOP
[4K/24p/420/8-L]	23.98p / 100 Mbps / 4:2:0/8 bit / AVC / Long GOP	

4. Recording Videos - Recording Settings For Video

[FHD/60p/422/10-I]	1920x1080 (16:9)	59.94p / 200 Mbps / 4:2:2/10 bit / AVC / ALL-Intra
[FHD/60p/422/10-L]		59.94p / 100 Mbps / 4:2:2/10 bit / AVC / Long GOP
[FHD/60p/420/8-L]		59.94p / 100 Mbps / 4:2:0/8 bit / AVC / Long GOP
[FHD/30p/422/10-I]		29.97p / 200 Mbps / 4:2:2/10 bit / AVC / ALL-Intra
[FHD/30p/422/10-L]		29.97p / 100 Mbps / 4:2:2/10 bit / AVC / Long GOP
[FHD/30p/420/8-L]		29.97p / 100 Mbps / 4:2:0/8 bit / AVC / Long GOP
[FHD/24p/422/10-I]		23.98p / 200 Mbps / 4:2:2/10 bit / AVC / ALL-Intra
[FHD/24p/422/10-L]		23.98p / 100 Mbps / 4:2:2/10 bit / AVC / Long GOP
[FHD/24p/420/8-L]		23.98p / 100 Mbps / 4:2:0/8 bit / AVC / Long GOP

- Ⓐ Recording frame rate
- Ⓑ Bit rate
- Ⓒ YUV/bit
- Ⓓ Video compression format
  - HEVC: H.265/HEVC
  - AVC: H.264/MPEG-4 AVC
- Ⓔ Image compression

■ [System Frequency]: [50.00Hz (PAL)]

[Rec Quality]	Resolution (Aspect ratio)	Ⓐ / Ⓑ / Ⓒ / Ⓓ / Ⓔ
[4K-A/50p/420/10-L]	3328x2496 (4:3)	50.00p / 200 Mbps / 4:2:0/10 bit / HEVC / Long GOP
[4K-A/50p/420/8-L]		50.00p / 150 Mbps / 4:2:0/8 bit / AVC / Long GOP
[4K-A/25p/422/10-I]		25.00p / 400 Mbps / 4:2:2/10 bit / AVC / ALL-Intra
[4K-A/25p/422/10-L]		25.00p / 150 Mbps / 4:2:2/10 bit / AVC / Long GOP
[4K-A/25p/420/8-L]		25.00p / 100 Mbps / 4:2:0/8 bit / AVC / Long GOP
[C4K/50p/420/10-L]	4096x2160 (17:9)	50.00p / 200 Mbps / 4:2:0/10 bit / HEVC / Long GOP
[C4K/50p/420/8-L]		50.00p / 150 Mbps / 4:2:0/8 bit / AVC / Long GOP
[C4K/25p/422/10-I]		25.00p / 400 Mbps / 4:2:2/10 bit / AVC / ALL-Intra
[C4K/25p/422/10-L]		25.00p / 150 Mbps / 4:2:2/10 bit / AVC / Long GOP
[C4K/25p/420/8-L]		25.00p / 100 Mbps / 4:2:0/8 bit / AVC / Long GOP
[4K/50p/420/10-L]	3840x2160 (16:9)	50.00p / 200 Mbps / 4:2:0/10 bit / HEVC / Long GOP
[4K/50p/420/8-L]		50.00p / 150 Mbps / 4:2:0/8 bit / AVC / Long GOP
[4K/25p/422/10-I]		25.00p / 400 Mbps / 4:2:2/10 bit / AVC / ALL-Intra
[4K/25p/422/10-L]		25.00p / 150 Mbps / 4:2:2/10 bit / AVC / Long GOP
[4K/25p/420/8-L]		25.00p / 100 Mbps / 4:2:0/8 bit / AVC / Long GOP
[FHD/50p/422/10-I]	1920x1080 (16:9)	50.00p / 200 Mbps / 4:2:2/10 bit / AVC / ALL-Intra
[FHD/50p/422/10-L]		50.00p / 100 Mbps / 4:2:2/10 bit / AVC / Long GOP
[FHD/50p/420/8-L]		50.00p / 100 Mbps / 4:2:0/8 bit / AVC / Long GOP
[FHD/25p/422/10-I]		25.00p / 200 Mbps / 4:2:2/10 bit / AVC / ALL-Intra
[FHD/25p/422/10-L]		25.00p / 100 Mbps / 4:2:2/10 bit / AVC / Long GOP
[FHD/25p/420/8-L]		25.00p / 100 Mbps / 4:2:0/8 bit / AVC / Long GOP

- Ⓐ Recording frame rate
- Ⓑ Bit rate
- Ⓒ YUV/bit
- Ⓓ Video compression format
  - **AVC**: H.264/MPEG-4 AVC
- Ⓔ Image compression

#### ■ [System Frequency]: [24.00Hz (CINEMA)]

[Rec Quality]	Resolution (Aspect ratio)	Ⓐ / Ⓑ / Ⓒ / Ⓓ / Ⓔ
[4K-A/24p/422/10-I]	3328x2496 (4:3)	24.00p / 400 Mbps / 4:2:2/10 bit / AVC / ALL-Intra
[4K-A/24p/422/10-L]		24.00p / 150 Mbps / 4:2:2/10 bit / AVC / Long GOP
[4K-A/24p/420/8-L]		24.00p / 100 Mbps / 4:2:0/8 bit / AVC / Long GOP
[C4K/24p/422/10-I]	4096x2160 (17:9)	24.00p / 400 Mbps / 4:2:2/10 bit / AVC / ALL-Intra
[C4K/24p/422/10-L]		24.00p / 150 Mbps / 4:2:2/10 bit / AVC / Long GOP
[C4K/24p/420/8-L]		24.00p / 100 Mbps / 4:2:0/8 bit / AVC / Long GOP
[4K/24p/422/10-I]	3840x2160 (16:9)	24.00p / 400 Mbps / 4:2:2/10 bit / AVC / ALL-Intra
[4K/24p/422/10-L]		24.00p / 150 Mbps / 4:2:2/10 bit / AVC / Long GOP
[4K/24p/420/8-L]		24.00p / 100 Mbps / 4:2:0/8 bit / AVC / Long GOP
[FHD/24p/422/10-I]	1920x1080 (16:9)	24.00p / 200 Mbps / 4:2:2/10 bit / AVC / ALL-Intra
[FHD/24p/422/10-L]		24.00p / 100 Mbps / 4:2:2/10 bit / AVC / Long GOP
[FHD/24p/420/8-L]		24.00p / 100 Mbps / 4:2:0/8 bit / AVC / Long GOP

- In this document, videos are indicated as follows according to their resolution:
  - 4K-A (3328x2496) video: **Anamorphic (4:3) video**
  - C4K (4096x2160) video: **C4K video**
  - 4K (3840x2160) video: **4K video**
  - Full High Definition (1920x1080) video: **FHD video**

- Since the camera employs the VBR recording format, the bit rate is changed automatically depending on the subject to record. As a result, video recording time is shortened when a fast-moving subject is recorded.
- Videos in ALL-Intra and 4:2:2/10-bit formats are intended for editing on a PC used for video production.
- When the following functions are being used, [Image Area of Video] is fixed to [FULL].
  - Anamorphic (4:3) video
  - C4K video
  - 4K video
- When using the following function, you can only select 8-bit FHD video:
  - [Filter Settings]: [Miniature Effect]
- You can register a combination of [System Frequency], [Rec. File Format], [Image Area of Video], and [Rec Quality] to My List. (➔ 60 / [add to list](#))

## [Filtering]

When the [Rec. File Format] is set to [MOV], you can specify items such as frame rate, number of pixels (resolution), and codec (YUV, Bit value, Image compression), and only display recording quality that meets those conditions.

### ① In the [Rec Quality] setting screen, press [Fn1].

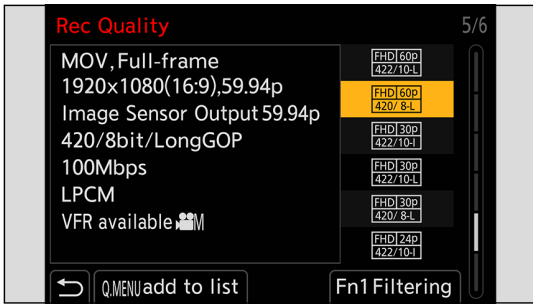

### ② Select an item with ▲▼ and press [MENU/SET].

- Settings: [Frame Rate] / [Resolution] / [Codec] / [Variable Frame Rate] / [Hybrid Log Gamma]

### ③ Select the filtering condition with ▲▼ then press [MENU/SET].

### ④ Press [Fn1] to confirm the setting.

- You are returned to the [Rec Quality] setting screen.

## ■ Clearing the filtering conditions

Select [ANY] in Step ③.

- The filtering conditions are also cleared when you do the following:
  - Change the [System Frequency]
  - Select a recording quality from [Rec Quality (My List)]

- When you change recording quality using a filter, the current filtering conditions are stored.

## [add to list]

Select a recording quality and register it in My List. The recording quality you register can be set in [Rec Quality (My List)].

### ① In the [Rec Quality] setting screen, press [Q.MENU].

- The following settings are also registered at the same time:
  - [System Frequency]
  - [Rec. File Format]
  - [Image Area of Video]

## ■ Setting or deleting in My List

### ① Select [Rec Quality (My List)].

- [Icon] → [Icon] → [Rec Quality (My List)]

### ② Select an item with ▲▼ and press [MENU/SET].

- You cannot select setting items that have different system frequencies.
- To delete from My List, select the item and press [Q.MENU].

- Up to 12 types of recording quality can be registered.

## [Image Area of Video]

Set the image area during video recording. The angle of view differs depending on the image area. Narrowing the image area allows you to achieve a telescopic effect without image deterioration.

[MENU/SET] → [ ] → [ ] → Select [Image Area of Video]

Item	Settings details
[FULL]	Records according to the range that corresponds to the image circle of the lens that is for Micro four thirds. Angle of view: Wide Telescopic effect: Not possible
[PIXEL/PIXEL]	Records with one pixel on the sensor, which is equal to one pixel of the video. Records a range corresponding to the resolution range in [Rec Quality]. (→ 56 / [Rec Quality]) Angle of view: Narrow Telescopic effect: Possible

### ■ Image area (Ex.: FHD video)

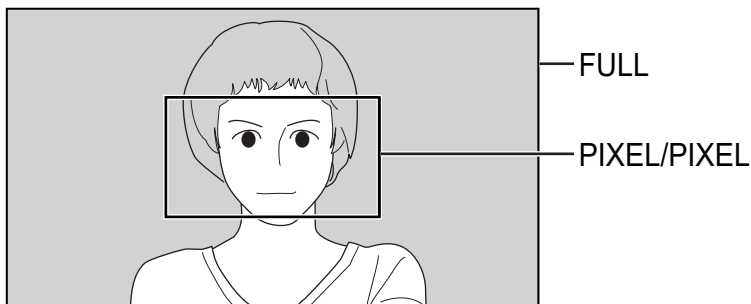

- When the following functions are being used, [Image Area of Video] is fixed to [FULL].
  - [Live Cropping]
  - Anamorphic (4:3) video
  - C4K video
  - 4K video

# Time Code

When [Rec. File Format] is set to [MOV], the time code is automatically recorded during video recording. If [MP4], the time code is not recorded.

## Setting the Time Code

Sets the recording, display, and output of the time code.

### 1 Set [Rec. File Format] to [MOV].

- [MENU/SET] → [MODE] → [Image Format] → [Rec. File Format] → [MOV]

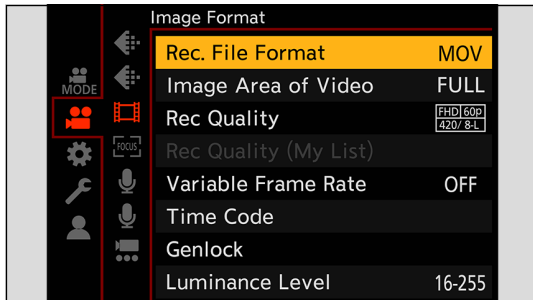

### 2 Select [Time Code].

- [MENU/SET] → [MODE] → [Image Format] → [Time Code]

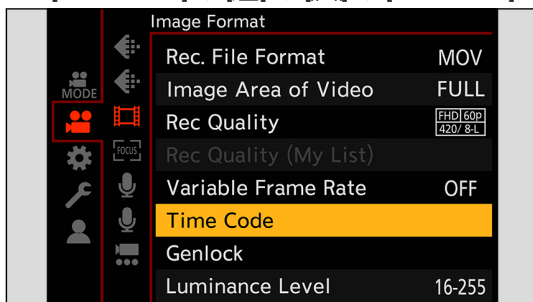

#### 4. Recording Videos - Time Code

[Time Code Display]	Displays the time code on the recording screen.
[Count Up]	<p><b>[REC RUN]:</b> Counts the time code only when recording videos.</p> <p><b>[FREE RUN]:</b> Counts the time code also when video recording is stopped and when the camera is turned off.</p> <ul style="list-style-type: none"> <li>• When the following function is being used, [Count Up] is fixed to [REC RUN]: <ul style="list-style-type: none"> <li>– [Variable Frame Rate]</li> </ul> </li> </ul>
[Time Code Value]	<p><b>[Reset]:</b> Sets to 00:00:00:00 (hour: minute: second: frame)</p> <p><b>[Manual Input]:</b> Manually input hour, minute, second and frame.</p> <p><b>[Current Time]:</b> Sets hour, minute and second to current time and sets frame to 00.</p>
[Time Code Mode]	<p><b>[DF]:</b> Drop Frame. The camera modifies the difference between recorded time and time code.</p> <ul style="list-style-type: none"> <li>• Seconds and frames are separated by “.”.</li> </ul> <p>Example: 00:00:00.00</p> <p><b>[NDF]:</b> Non-Drop Frame. Records the time code without drop frame.</p> <ul style="list-style-type: none"> <li>• Seconds and frames are separated by “.”.</li> </ul> <p>Example: 00:00:00:00</p> <ul style="list-style-type: none"> <li>• When the following functions are being used, [Time Code Mode] is fixed to [NDF]: <ul style="list-style-type: none"> <li>– [50.00Hz (PAL)] / [24.00Hz (CINEMA)] ([System Frequency])</li> <li>– 23.98p [Rec Quality]</li> </ul> </li> </ul>
[HDMI Time Code Output] / [SDI Time Code Output]	<p>Images to be output via HDMI/SDI will be added with time code information then output.</p> <ul style="list-style-type: none"> <li>• The device screen may go dark depending on the connected device.</li> </ul>
[External TC Setting]	<p>Synchronize the time code default value with an external device that supports time code input and output. (➔ <a href="#">64 / Synchronizing the Time Code with an External Device</a>)</p> <p><b>[TC Synchronization]:</b> Selects the input (➔ <a href="#">66 / Synchronize the Time Code of the Camera with That of the External Device (TC IN)</a>) and output (➔ <a href="#">65 / Synchronize the Time Code of the External Device with That of the Camera (TC OUT)</a>) for time code signals. (LTC signal)</p> <p><b>[TC Output Reference]:</b> Sets the timing for time code signal output. (➔ <a href="#">65 / Synchronize the Time Code of the External Device with That of the Camera (TC OUT)</a>)</p>

# Synchronizing the Time Code with an External Device

Synchronize the time code default value with an external device that supports time code signal input and output.

## Preparations for Time Code Synchronization

When [Count Up] is set to [FREE RUN], you can synchronize the initial value of the time code with an external device.

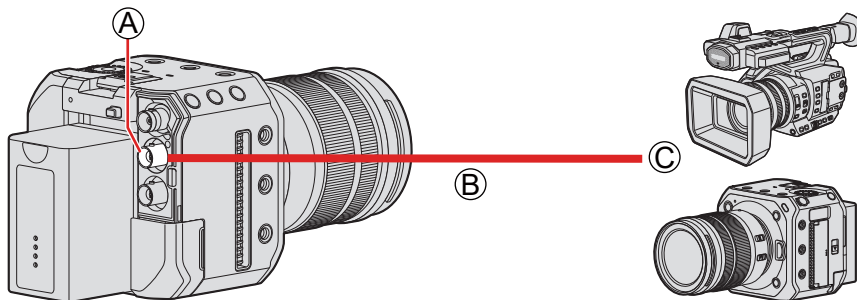

- Ⓐ [TC IN/OUT] terminal
- Ⓑ BNC cable (commercially available)
- Ⓒ External devices

### 1 Set [Count Up] to [FREE RUN].

- [MENU/SET] → [ ] → [ ] → [Time Code] → [Count Up] → [FREE RUN]

### 2 Connect the camera and external device with a BNC cable.

- When connecting a BNC cable to the [TC IN/OUT] terminal, use one that is less than 2.8 m (9.1 feet). It is recommended to use a double shielded BNC cable equivalent to 5C-FB.



## Synchronize the Time Code of the External Device with That of the Camera (TC OUT)

The initial time code value of the external device is synchronized according to the time code signal of the camera.

### 1 Prepare for time code synchronizing. (➔ 64 / Preparations for Time Code Synchronization)

### 2 Set [TC Synchronization] to [TC OUT].

- [MENU/SET] ➔ [ ] ➔ [ ] ➔ [Time Code] ➔ [External TC Setting] ➔ [TC Synchronization] ➔ [TC OUT]
- The time code signal is output according to the recording frame rate of the [Rec Quality] and the [Time Code Mode] ([DF]/[NDF]) setting.

### 3 Select [TC Output Reference].

- [MENU/SET] ➔ [ ] ➔ [ ] ➔ [Time Code] ➔ [External TC Setting] ➔ [TC Output Reference]

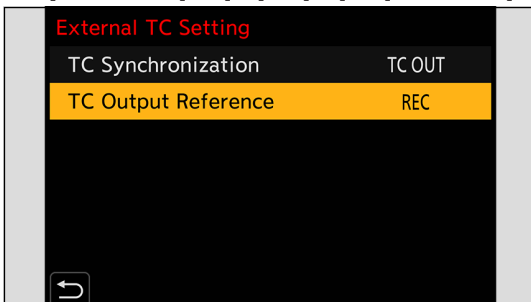

[REC]	Outputs the time code signal for the images that you record.
[HDMI] / [SDI]	When connected with an external device (external recorder, etc.) via HDMI/SDI, the time code signal output is delayed slightly to match the HDMI/SDI images.

### 4 Operate the external device to synchronize the time code.

#### Outputting the Time Code Signal Again

By setting as follows, the time code signal can be output just by connecting with the external device with the BNC cable:

- [Count Up] ([Time Code]): [FREE RUN]
- [TC Synchronization] ([External TC Setting] in [Time Code]): [TC OUT]

## Synchronize the Time Code of the Camera with That of the External Device (TC IN)

The initial time code value of the camera is synchronized according to the time code signal of the external device.

- In advance, change the [System Frequency] (➔ 55 / [System Frequency]), [Rec Quality] (➔ 56 / [Rec Quality]), and [Time Code Mode] (➔ 63 / [Time Code Mode]) to match the external device.

### 1 Prepare for time code synchronizing. (➔ 64 / Preparations for Time Code Synchronization)

### 2 Set [TC Synchronization] to [TC IN].

- [MENU/SET] ➔ [ ] ➔ [ ] ➔ [Time Code] ➔ [External TC Setting] ➔ [TC Synchronization] ➔ [TC IN]

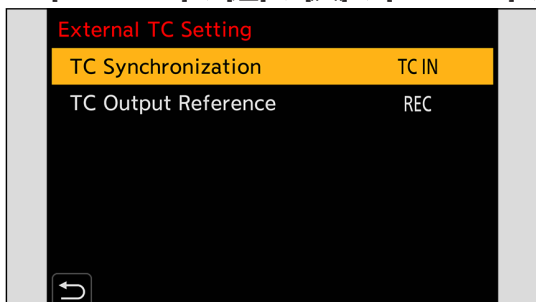

### 3 Operate the external device to output the time code signal.

- Set the time code count method of the external device to free run, and output the signal.
- When synchronized with the time code of an external device, this camera is in a slave state, and the [ TC ] of the time code shown on the screen switches to **[TC]**.

## Maintaining, Releasing, and Restoring the Slave State

Even if you disconnect the BNC cable, the camera will remain in slave state.

- Perform one of the following operations to release the camera from the slave state.
  - Operate the camera ON/OFF button
  - Switch the recording mode
  - Change the [System Frequency]
  - Set the [Variable Frame Rate]
  - Switch the [Rec Quality] between 23.98p and a different recording frame rate
  - Change the following [Time Code] setting items  
[Count Up], [Time Code Value], [Time Code Mode], [TC Synchronization]
- To restore the slave state, reconnect the BNC cable to the external device while set as follows. The time code signal can be input just by connecting.
  - [Count Up] ([Time Code]): [FREE RUN]
  - [TC Synchronization] ([External TC Setting] in [Time Code]): [TC IN]

- Even when the system frequency differs between the camera and the external device, their initial time code values may be synchronized. Bear in mind, however, that the time codes lose sync as they count up.

# Genlock settings

When using several units of this camera or recording in combination with other recording devices, input the external sync signal from the [GENLOCK IN] terminal to synchronize the cameras.

The camera is compatible with BBS (Black Burst Sync) and tri-level sync.

## Input a sync signal

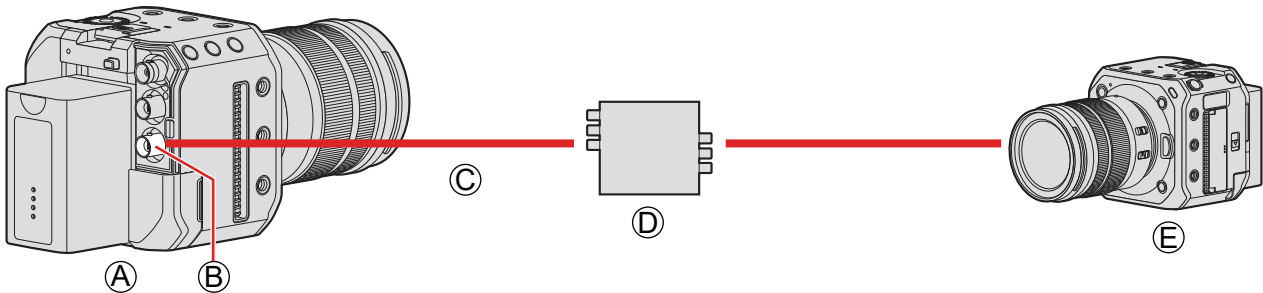

- Ⓐ Camera (Slave)
- Ⓑ [GENLOCK IN] terminal
- Ⓒ BNC cable (commercially available)
- Ⓓ Sync signal generator (Master)
- Ⓔ External device (Slave)

**1** Connect the sync signal generator and camera with a BNC cable.

**2** Set [Genlock Input] to [ON].

- [MENU/SET] → [ ] → [ ] → [Genlock] → [Genlock Input] → [ON]

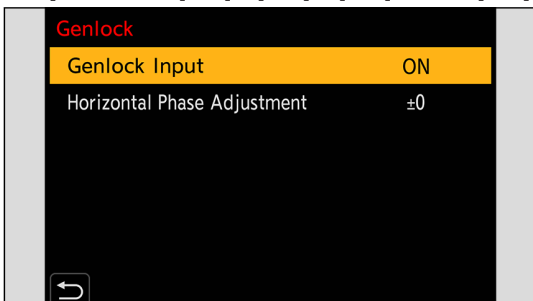

**3** Output a sync signal with the sync signal generator.

- When connecting a BNC cable to the [GENLOCK IN] terminal, use one that is less than 2.8 m (9.1 feet). It is recommended to use a double shielded BNC cable equivalent to 5C-FB.

## Compatible reference signal

The compatible reference signal differs depending on the following camera settings.

- [MENU/SET] → [🔧] → [📡] → [HDMI / SDI Connections] → [SDI Output]
- [MENU/SET] → [🔧] → [📡] → [SDI Rec Output] → [SDI Output Resolution]  
(The items that can be set differs depending on the recording frame rate of the [Rec Quality]. (➔ [138 / Set the resolution during recording when output via SDI](#)))

### ■ [System Frequency]: [59.94Hz (NTSC)]

Camera setting		Compatible sync signal	
		BBS	Tri-level sync
[SDI Output]	OFF	480/59.94i	1080/59.94i
[SDI Output Resolution] ([SDI Output]: [ON])	1080p* <sup>1</sup>		
	1080i		
	1080PsF		
	720p		720/59.94p

### ■ [System Frequency]: [50.00Hz (PAL)]

Camera setting		Compatible sync signal	
		BBS	Tri-level sync
[SDI Output]	OFF	576/50.00i	1080/50.00i
[SDI Output Resolution] ([SDI Output]: [ON])	1080p* <sup>2</sup>		
	1080i		
	1080PsF		
	720p		720/50.00p

\*<sup>1</sup> When the recording frame rate is set to 29.97p of [Rec Quality], there is no compatible tri-level sync signal.

\*<sup>2</sup> When the recording frame rate is set to 25.00p of [Rec Quality], there is no compatible tri-level sync signal.

- Even when a sync signal is detected, the icon will not be displayed on the recording screen.
- Input a sync signal before starting to record. (The syncing cannot be started when the sync signal is input while recording.)
- The [Genlock] does not work when the recording frame rate is set to a [Rec Quality] of 23.98 or 24.00.

## Horizontal phase adjustment

Adjusts the horizontal phase.

### 1 Select [Horizontal Phase Adjustment].

- [MENU/SET] → [ ] → [ ] → [Genlock] → [Horizontal Phase Adjustment]

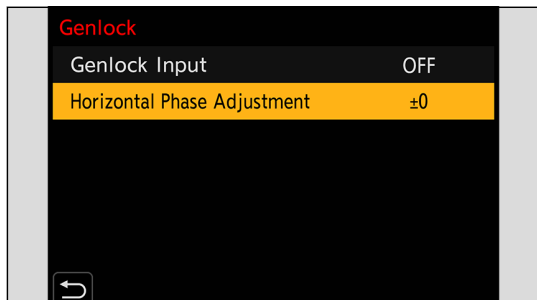

### 2 Set the horizontal phase.

- Rotate  to adjust the value, then press [MENU/SET].
- It can be set with the range of -206 to +49.

# 5. Recording settings

## Focus / Zoom

### Selecting the Focus Mode

Select the focusing method ([Focus Mode]) to match subject movement.

#### 1 Set the Focus Mode.

- [MENU/SET] → [MODE] → [FOCUS] → [Focus Mode]

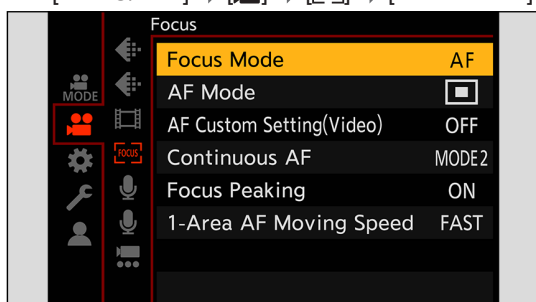

[AF]*1	Automatically adjusts the focus.
[MF]	Manually adjusts the focus. This is used when you want to fix the focus or do not want the AF to work. (→ <a href="#">79 / Record Using MF</a> )

\*1 When recording video: Operates according to the settings of [Continuous AF].  
 When recording still images: When you turn the AF/AE button (half-press shutter button) of the “LUMIX Tether” software to ON, it performs focusing and fixes the focus.

## Using AF

Select the focus mode and the AF mode appropriate for the subject and scene.

### 1 Set the focus mode to [AF].

- [MENU/SET] → [MODE] → [FOCUS] → [Focus Mode] → [AF]

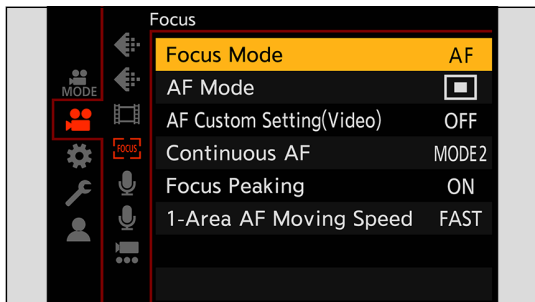

### 2 Select [AF Mode].

- [MENU/SET] → [MODE] → [FOCUS] → [AF Mode]

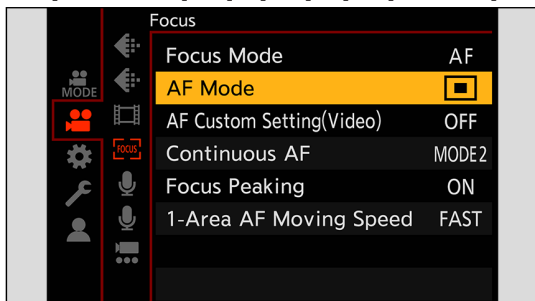

### ■ [AF-ON]

The AF also works when you press a Fn button that has [AF-ON] registered.

- [MENU/SET] → [SETTINGS] → [Fn Button Set] → [Setting in REC mode] → [AF-ON]

**Subjects and recording conditions that make focusing difficult with AF mode**

- Fast-moving subjects
- Extremely bright subjects
- Subjects without contrast
- Subjects recorded through windows
- Subjects near shiny objects
- Subjects in very dark locations
- When recording subjects both distant and near
- You can change the operation of AF-ON so that AF prioritizes subjects close by. This function is useful when the camera mistakenly focuses on the background:  
[Settings] → [AF-ON] → [Fn Button Set] → [Setting in REC mode] → [AF-ON : Near Shift] (→ [155 / Register Functions to the Fn Buttons](#))
- You can change the operation of AF-ON so that AF prioritizes subjects far away. This function is useful when taking pictures through fences or nets:  
[Settings] → [AF-ON] → [Fn Button Set] → [Setting in REC mode] → [AF-ON : Far Shift] (→ [155 / Register Functions to the Fn Buttons](#))
- When the following operations are performed while recording, it may take some time for the camera to focus.
  - When zooming from the wide-angle end to the telephoto end
  - When the subject is suddenly changed from one far away to one close by
- If using the zoom after achieving focus, the focus may be erroneous. In that case, re-adjust the focus.



## Selecting the AF Mode

Select the focusing method to match the position and number of subjects.

### 1 Select [AF Mode].

- [MENU/SET] → [AF Mode] → [AF Mode]

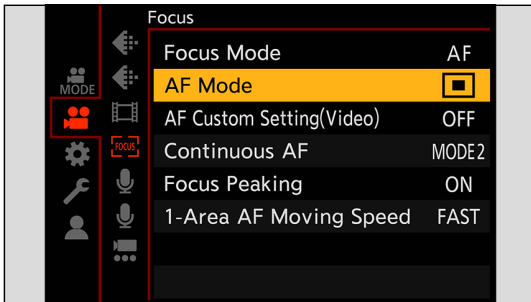

### 2 Select the AF mode.

- Rotate [AF Mode] icon.

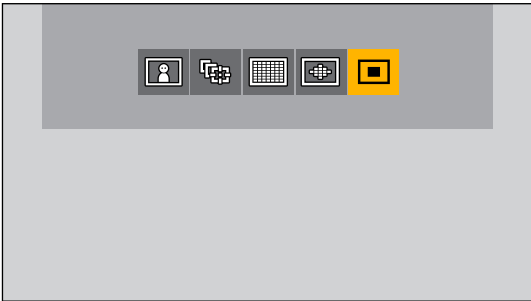

- [Face/Eye/Body/Animal Detect.] (→ 74 / [Face/Eye/Body/Animal Detect.])
- [Tracking] (→ 75 / [Tracking])
- [225-Area] (→ 76 / [225-Area])
- [Zone (Oval)] (→ 76 / [Zone (Oval)])
- [1-Area] (→ 77 / [1-Area])

### 3 Confirm your selection.

- Press [MENU/SET].

- When the following function is being used, the AF mode is fixed to [Face/Eye/Body/Animal Detect.] (face detection):
  - [Live Cropping]
- When the following functions are being used, the AF mode is fixed to [1-Area] (1-Area) (It is not possible to move the AF area or change its size.):
  - [Digital Zoom]
  - [Miniature Effect] ([Filter Settings])

**[Face/Eye/Body/Animal Detect.]**

The camera detects a person's face, eyes, and body (entire body or upper half of the body) and adjusts the focus. With animal detection enabled, the camera will also detect animals, such as birds, canines (including wolves), and felines (including lions).

When the camera detects a person's face (A) / (B) or body or an animal's body (C)\*1, an AF area is displayed.

\*1 When the animal detection is enabled.

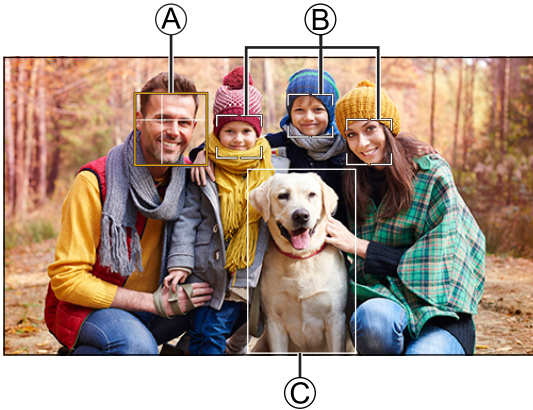

<b>Yellow</b>	AF area to be brought into focus. The camera selects this automatically.
<b>White</b>	Displayed when multiple subjects are detected.

- Eye detection works only for the eyes inside the yellow frame (A).
- When a person's eyes are detected, the eye closer to the camera will be brought into focus. The exposure will be adjusted to the face. (When [Metering Mode] is set to [☉])
- The camera can detect the faces of up to 15 people.
- The camera can detect a combined total of up to 3 human and animal bodies.
- If any humans or animals are not detected, the camera operates as [☐].

**■ Enable / Disable Animal Detection****① Display the AF mode selection screen.**

- [MENU/SET] → [👤] → [FOCUS] → [AF Mode]

**② Select [👤] and then press ▲.**

- This enables animal detection, and the icon changes to [👤].
- Press ▲ again to disable animal detection.

## ■ Move and Change the Size of the Yellow AF Area

You can move the yellow AF area to the position of the white AF area and replace the white AF area with the yellow AF area. If moving to a position outside an AF area, then the [ ] AF area will be set.

- ① **Display the AF mode selection screen.**
  - [MENU/SET] → [ ] → [FOCUS] → [AF Mode]
- ② **Select [ ] and then press ▼.**
- ③ **Press ▲▼◀▶ to move the position of the AF area.**
- ④ **Rotate [ ] to change the size of the AF area.**
  - The first press of [Fn1] returns the AF area position to the center. The second press returns the size of the AF area to the default.
- ⑤ **Press [MENU/SET].**
  - On the recording screen, press [MENU/SET] to cancel the AF area setting.

## [Tracking]

The AF area follows the movement of the subject, maintaining focusing.

- ① **Start tracking.**
  - Aim the AF area over the subject, and press [Fn1].

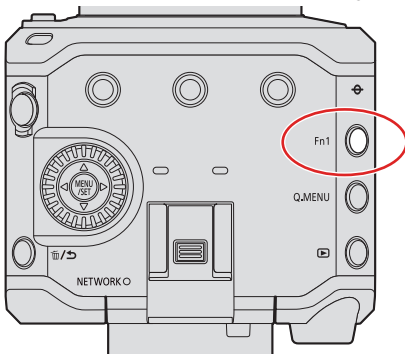

- To release AF Tracking → Press [Fn1] again.
- Set [Metering Mode] to [ ] to continue to adjust the exposure as well.
  - In the following, [ ] operates as [ ]:
    - [Monochrome] / [L.Monochrome] / [L.Monochrome D] ([Photo Style])
    - [Sepia] / [Monochrome] / [Dynamic Monochrome] ([Filter Settings])
    - When the subject is small

## ■ Move the Position of the AF Area

- ① Display the AF mode selection screen.
  - [MENU/SET] → [AF] → [FOCUS] → [AF Mode]
- ② Select [225] and then press ▼.
- ③ Press ▲▼◀▶ to move the position of the AF area.
  - To return the position back to the center, press [Fn1].
- ④ Press [MENU/SET].

### [225-Area]

The camera selects the most optimal AF area to focus from 225 areas.

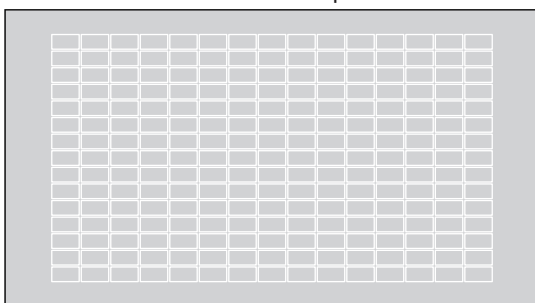

### [Zone (Oval)]

Within the 225 AF areas, a central oval zone can be focused.

## ■ Move and Change the Size of the AF Area

- ① Display the AF mode selection screen.
  - [MENU/SET] → [AF] → [FOCUS] → [AF Mode]
- ② Select [Zone] and then press ▼.
- ③ Press ▲▼◀▶ to move the position of the AF area.

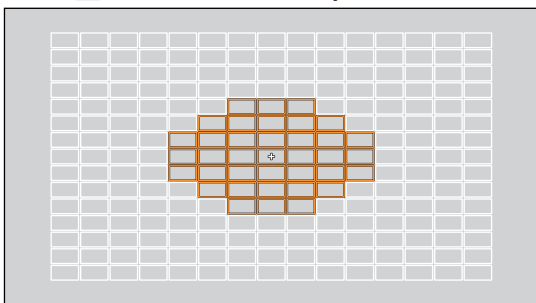

- ④ Rotate ⚙️ to change the size of the AF area.
  - The first press of [Fn1] returns the AF area position to the center. The second press returns the size of the AF area to the default.
- ⑤ Press [MENU/SET].

**[1-Area]**

Specify the point to be brought into focus.

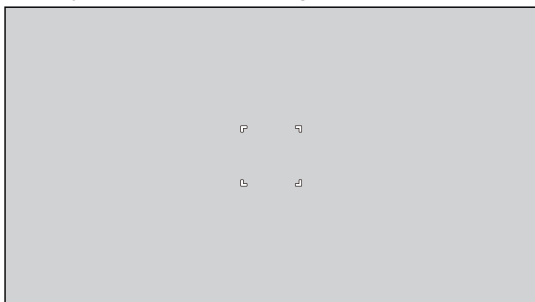

### ■ Move and Change the Size of the AF Area

**1** Display the AF mode selection screen.

- [MENU/SET] → [ ] → [FOCUS] → [AF Mode]

**2** Select [ ] and then press ▼.

**3** Press ▲▼◀▶ to move the position of the AF area.

**4** Rotate ⌚ to change the size of the AF area.

- The first press of [Fn1] returns the AF area position to the center. The second press returns the size of the AF area to the default.

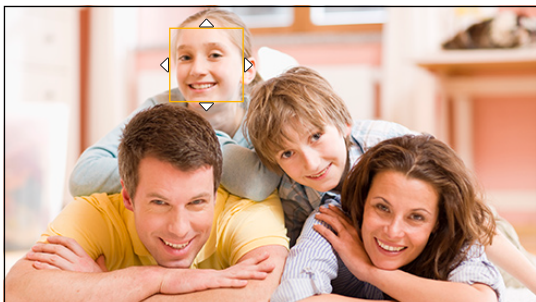

**5** Press [MENU/SET].

## [Continuous AF]

You can select how to set the focus in AF when recording videos.

[MENU/SET] →  →  → Select [Continuous AF]

<b>[MODE1]</b>	The camera continues to automatically focus only during recording.
<b>[MODE2]</b>	The camera automatically keeps focusing on subjects during recording standby and during recording.
<b>[OFF]</b>	The camera maintains the focus point at the start of recording.

- Depending on the recording conditions or lens used, the AF operation sound may be recorded during video recording. If the operation sound bothers you, we recommend recording with [Continuous AF] set to [OFF].
- If the zoom is operated while recording videos, the subject may take a while to come into focus.
- [MODE2] does not work during recording standby in the following cases:
  - In low light situations

## [AF Custom Setting(Video)]

You can fine-adjust the focusing method for video recording using [Continuous AF].

[MENU/SET] →  →  → Select [AF Custom Setting(Video)]

<b>[ON]</b>	Enables the following settings.
<b>[OFF]</b>	Disables the following settings.
<b>[SET]</b>	<b>[AF Speed]</b> <b>[+] side:</b> Focus moves at a faster speed. <b>[-] side:</b> Focus moves at a slower speed.
	<b>[AF Sensitivity]</b> <b>[+] side:</b> When the distance to the subject changes significantly, the camera immediately readjusts the focus. <b>[-] side:</b> When the distance to the subject changes significantly, the camera waits for a little before readjusting the focus.

## Record Using MF

Use this function when you want to fix the focus or when the distance between the lens and the subject is determined and you do not want to activate AF.

### 1 Set the focus mode to [MF].

- [MENU/SET] → [MODE] → [FOCUS] → [Focus Mode] → [MF]

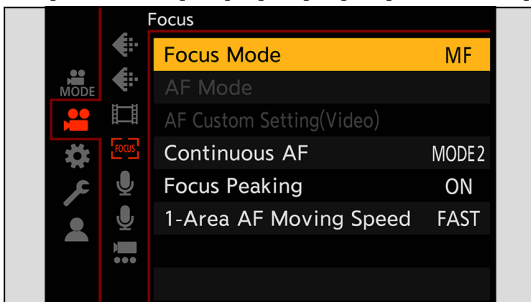

### 2 Close the menu.

- Press [↵].

### 3 Rotate the focus ring.

- When an interchangeable lens without a focus ring is being used, press a Fn button that has [AF Mode] registered.
- About Fn buttons → [155 / Register Functions to the Fn Buttons](#)

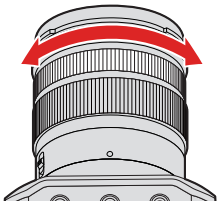

### 4 Select the focus point.

- Press ▲▼◀▶ to select the focus point.
- To return the point to be brought into focus to the center, press [Fn1].

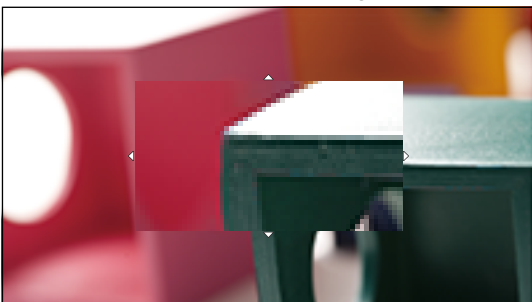

## 5 Adjust the focus.

The operations used to focus differ depending on the lens.

**When using an interchangeable lens with a focus ring**

**Rotate to (A) side:** Focuses on nearby subject

**Rotate to (B) side:** Focuses on distant subject

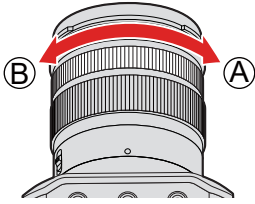

**When using an interchangeable lens with a focus lever**

**Move to (C) side:** Focuses on nearby subject

**Move to (D) side:** Focuses on distant subject

- The focusing speed varies depending on how far you move the focus lever.

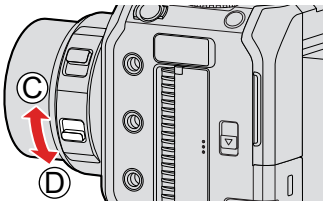

**When using an interchangeable lens with no focus ring**

**Press (right arrow):** Focuses on nearby subject

**Press (left arrow):** Focuses on distant subject

- Pressing and holding (left and right arrows) will increase the focus speed.

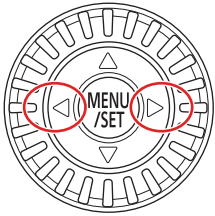



- This will display the in-focus portion highlighted with color. (Focus Peaking)
- A recording distance guideline is displayed. (MF Guide)

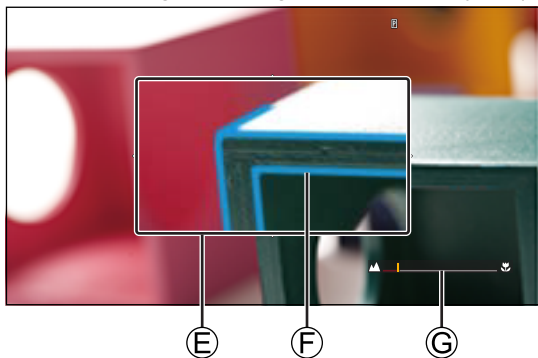

- Ⓔ MF Assist (enlarged screen)
- Ⓕ Focus Peaking
- Ⓖ MF Guide

## 6 Close the MF Assist screen.

- Press [MENU/SET].



## 7 Start recording.

- Press the video rec. button fully.

## 8 Stop recording.

- Press the video rec. button again.

## ■ Operations on the MF Assist Screen





Button operation	Description of operation
 *1	Moves the enlarged display position.
	Enlarges*2 / reduces the screen.
[Fn1]*1	First time: Returns the MF Assist position to the center. Second time: Returns the MF Assist magnification to the default setting.

\*1 When using an interchangeable lens with no focus ring, you can perform these operations after pressing  to display the screen that lets you set the area to be enlarged.

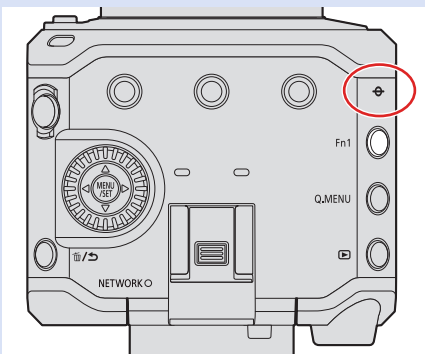
\*2 When the [MF Assist Display] is set to [PIP] from the [MF Assist] of the [Custom] ([Focus/Shutter]) menu, you can enlarge it to approx. 3x to 6x, and when it is set to [FULL] it can be enlarged to approx. 3x to 20x.

- MF Assist and MF Guide may not display depending on the lens used.
- During MF, pressing [AF-ON] will activate AF.
- The recording distance reference mark is a mark used to measure the recording distance. Use this when taking pictures with MF or taking close-up pictures.



- You can change the Focus Peaking sensitivity and the display method:  
 → [FOCUS] → [Focus Peaking] (→ [181](#) / [Focus Peaking])
- You can change the display method of the magnified screen:  
 → [AF] → [MF Assist] (→ [186](#) / [MF Assist])
- You can change the MF Guide display units:  
 → [AF] → [MF Guide] (→ [187](#) / [MF Guide])
- You can disable focus ring operation:  
 → [AF] → [Focus Ring Lock] (→ [187](#) / [Focus Ring Lock])
- The camera memorizes the focus point when you turn it off:  
 → [AF] → [Lens Focus Resume] (→ [192](#) / [Lens Focus Resume])

## Recording with Zoom

Use the optical zoom of the lens to zoom to telephoto or wide-angle.

By using [Image Area of Video], you can increase the telephoto effect without deteriorating the image quality.

- For details about [Image Area of Video] (➔ 61 / [Image Area of Video])

### 1 Rotate the zoom ring.

**T**: Telephoto

**W**: Wide-angle

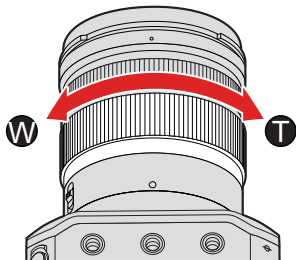

- Rotating the zoom ring displays the focal length on the recording screen.

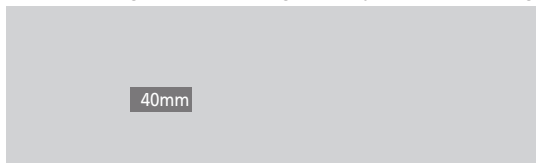

- The focal length display can be hidden:  
 [Settings] ➔ [Camera] ➔ [Focal Length] (➔ 188 / [Focal Length])

**[Digital Zoom]**

You can increase the zoom ratio 4x higher than the original zoom ratio. Note that, with Digital Zoom, enlarging will decrease picture quality.

[MENU/SET] →  →  → Select [Digital Zoom]  
Settings: [4x] / [2x] / [OFF]

- When using [Digital Zoom], it is recommended to fix the camera so that it does not move.

**[Power Zoom Lens]**

Sets the screen display and operations when using an interchangeable lens that is compatible with power zoom (electrically operated zoom).

- This may only be selected when using a lens that is compatible.

[MENU/SET] →  →  → Select [Power Zoom Lens]





<b>[Step Zoom]</b>	When it is set to [ON] and a zoom operation is performed, zooming stops at each decided focal point position. This does not work during video recording.
<b>[Zoom Ring]</b>	This may only be selected when a power zoom-compatible lens with a zoom lever and zoom ring is attached. When set to [OFF], the operations controlled by the zoom ring are disabled to prevent accidental operation.

# Metering / Exposure / ISO Sensitivity

## [Metering Mode]

The type of optical measurement to measure brightness can be changed.

[MENU/SET] → [ ] → [ ] → Select [Metering Mode]

 <b>(Multi-metering)</b>	Method in which the most suitable exposure is measured by judging the allocation of brightness on the whole screen.
 <b>(Center-weighted)</b>	Method used to perform measuring which focuses on the center of the screen.
 <b>(Spot)</b>	Method used to measure the extremely small part around the spot-metering target. <ul style="list-style-type: none"> <li>• When you move the AF area, the spot metering target also moves to match.</li> </ul> <div data-bbox="507 651 842 837" style="border: 1px solid black; width: 210px; height: 83px; margin: 10px auto; text-align: center;">  </div> Spot-metering target
 <b>(Highlight-weighted)</b>	Method used to perform measuring which focuses on the highlighted parts of the screen to prevent overexposure. This is suitable for theater photography, etc.

- The standard value for correct exposure can be adjusted:  
 [ ] → [ ] → [Exposure Offset Adjust.] (→ 186 / [Exposure Offset Adjust.]

## Exposure Compensation

You can compensate the exposure when the correct exposure determined by the camera is too bright or too dark. You can adjust the exposure in 1/3 EV steps in a range of  $\pm 3$  EV.

### 1 Display the exposure compensation screen.

- [MENU/SET] → [MODE] → [MENU] → [Exposure Comp.]



### 2 Compensate the exposure.

- Rotate

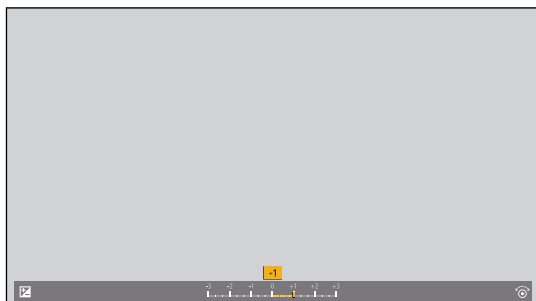

### 3 Confirm your selection.

- Press [MENU/SET].

- If you set the ISO sensitivity to [AUTO] when [Exposure Mode] is set to [M], you can compensate the exposure.
- The set exposure compensation value is stored even if you turn off the camera.
- The standard value for correct exposure can be adjusted:  
 → [MENU] → [Exposure Offset Adjust.] (→ 186 / [Exposure Offset Adjust.]

## Locking Focus and Exposure (AF/AE Lock)

Lock the focus and exposure in advance to take pictures with the same focus and exposure settings while changing the composition.

This is useful when you want to bring an edge of the screen into focus or there is a backlight, for example.

### 1 Register [AE LOCK], [AF LOCK], or [AF/AE LOCK] to the Fn button. (→ 155 / Register Functions to the Fn Buttons)

[AE LOCK]	The exposure is locked.
[AF LOCK]	The focus is locked.
[AF/AE LOCK]	Both focus and exposure are locked.

### 2 Lock focus and exposure.

- Press and hold the Fn button.
- If focus is locked, then the AF lock icon will be displayed.
- If exposure is locked, then the AE lock icon will be displayed.

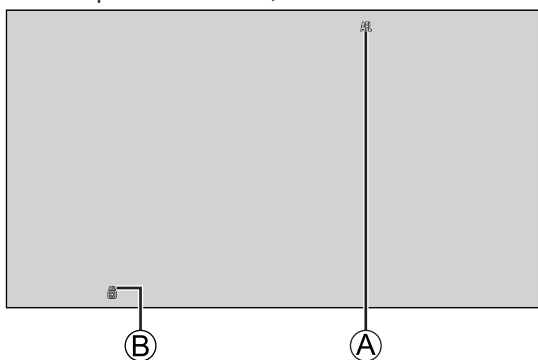

- Ⓐ AF lock icon (AFL)
- Ⓑ AE lock icon (AEL)

### 3 Hold the Fn button to decide on the composition and then perform recording.

- The lock can be maintained even without pressing and holding the Fn button:  
 [⚙️] → [AF] → [AF/AE Lock Hold] (→ 186 / [AF/AE Lock Hold])

## ISO Sensitivity

You can set light sensitivity (ISO sensitivity). With the default settings, you can set 160 to 51200 in 1/3 EV increments. This camera supports Dual Native ISO which enables recording at high sensitivity with reduced noise by switching the base sensitivity. The base sensitivity can also be fixed as necessary.

### 1 Press [Fn3].

- At default setting, [Sensitivity] is assigned to [Fn3].
- About Fn buttons (➔ [154 / Fn Buttons](#))
- You can also set it in the [Sensitivity] of the [Video] ([Image Quality]) menu

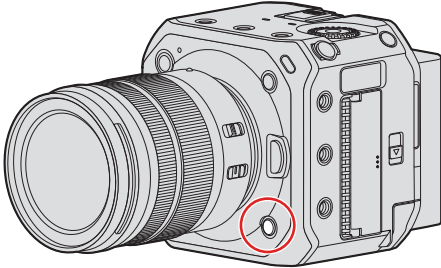

### 2 Select ISO sensitivity.

- Rotate .



### 3 Confirm your selection.

- Press [MENU/SET].



## ■ Setting Items (ISO Sensitivity)

<b>[AUTO]</b>	The ISO sensitivity is automatically adjusted according to the brightness. Maximum [6400] <sup>*1</sup>
<b>[160] to [51200]</b>	The ISO sensitivity is fixed at the selected value. <ul style="list-style-type: none"> <li>You can extend the ISO sensitivity range in between a lower limit of [80] and an upper limit of [204800] by setting [Extended ISO] (➔ 185 / [Extended ISO]) to [ON] in the [Custom] ([Image Quality]) menu.</li> </ul>

<sup>\*1</sup> Default setting. The upper limit can be changed with [ISO Sensitivity (video)].

- When the following functions are being used, the ISO sensitivity that can be set is restricted.
  - [High Dynamic] ([Filter Settings]): Fixed to [AUTO]
  - Other than [High Dynamic] ([Filter Settings]): Up to an upper limit of [6400]
  - [Like709] ([Photo Style]): Down to a lower limit of [160]
  - [V-Log L] ([Photo Style]): Down to a lower limit of [400], up to an upper limit of [25600]
  - [Hybrid Log Gamma] ([Photo Style]): Down to a lower limit of [320].

- You can change the intervals between ISO sensitivity settings values:  
[Settings] ➔ [ISO Increments] (➔ 185 / [ISO Increments])
- The setting range of ISO sensitivity can be extended:  
[Settings] ➔ [Extended ISO] (➔ 185 / [Extended ISO])
- You can change the units for sensitivity to dB when recording video:  
[SS/Gain Operation] (➔ 108 / [SS/Gain Operation])

## [ISO Sensitivity (video)]

Sets the lower and upper limits for ISO sensitivity when ISO sensitivity is set to [AUTO].

[MENU/SET] →  →  → Select [ISO Sensitivity (video)]

<b>[ISO Auto Lower Limit Setting]</b>	Sets the lower limit for ISO sensitivity when ISO sensitivity is [AUTO]. <ul style="list-style-type: none"> <li>Set in the range between [160] and [25600].</li> </ul>
<b>[ISO Auto Upper Limit Setting]</b>	Sets the upper limit for ISO sensitivity when ISO sensitivity is [AUTO]. <ul style="list-style-type: none"> <li>Set to [AUTO] or in the range between [200] and [51200].</li> </ul>

- When [Filter Settings] is set to [High Dynamic], [ISO Sensitivity (video)] cannot be used.

## [Dual Native ISO Setting]

You can set whether to switch the base sensitivity automatically or to fix it.

[MENU/SET] →  →  → Select [Dual Native ISO Setting]

<b>[AUTO]</b>	The base sensitivity is automatically switched according to the brightness. ISO sensitivity that can be set: [AUTO] / [160] to [51200]. (When [Extended ISO] is set: [AUTO] / [80] to [204800].)
<b>[LOW]</b>	Sets the base sensitivity for low sensitivity. ISO sensitivity that can be set: [AUTO] / [160] to [800]. (When [Extended ISO] is set: [AUTO] / [80] to [800].)
<b>[HIGH]</b>	Sets the base sensitivity for high sensitivity. ISO sensitivity that can be set: [AUTO] / [800] to [51200]. (When [Extended ISO] is set: [AUTO] / [800] to [204800].)

- When [Filter Settings] is set to [High Dynamic], [Dual Native ISO Setting] is fixed to [AUTO].

## [Luminance Level]

You can set the luminance range to suit the purpose of video recording.

[MENU/SET] →  →  → Select [Luminance Level]

Settings: [0-255] / [16-235] / [16-255]

- When set to a 10-bit [Rec Quality], the setting items change to [0-1023], [64-940], and [64-1023].
- When [Photo Style] is set to [V-Log L], this is fixed to [0-255] ([0-1023]).

# White Balance / Image Quality

## White Balance (WB)

White balance (WB) is a function that corrects the color cast produced by the light illuminating the subject. It corrects the colors so that white objects appear in white to make the overall color closer to what is seen by the eye.

Normally, you can use auto ([AWB], [AWBc] or [AWBw]) to obtain the optimal white balance. Set this function when the coloring of the image is different from what you expected, or you want to change the coloring to capture the ambience.

### 1 Press [Fn4].

- At default setting, [White Balance] is assigned to [Fn4].
- About Fn buttons (➔ [154 / Fn Buttons](#))
- You can also set it from the [White Balance] of the [Video] ([Image Quality]) menu.

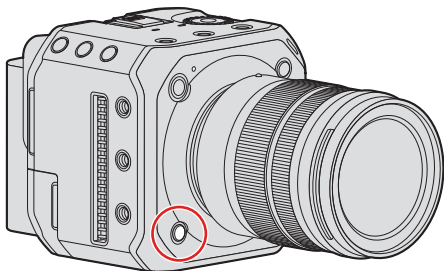

### 2 Select the white balance.



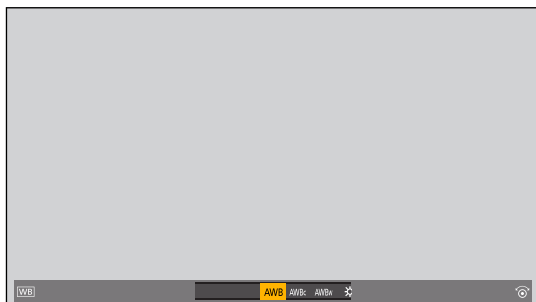



- Rotate .



### 3 Confirm your selection.

- Press [MENU/SET].

■ Setting Items (White Balance)

[AWB]	Auto
[AWBc]	Auto (Reduces the reddish hue under an incandescent light source)
[AWBw]	Auto (Leaves the reddish hue under an incandescent light source)
	Clear sky
	Cloudy sky
	Shade under a clear sky
	Incandescent light
	Set mode 1 to 4 (➔ 93 / Registering the White Set)
	Color temperatures 1 to 4 (➔ 93 / Color Temperature Setting)

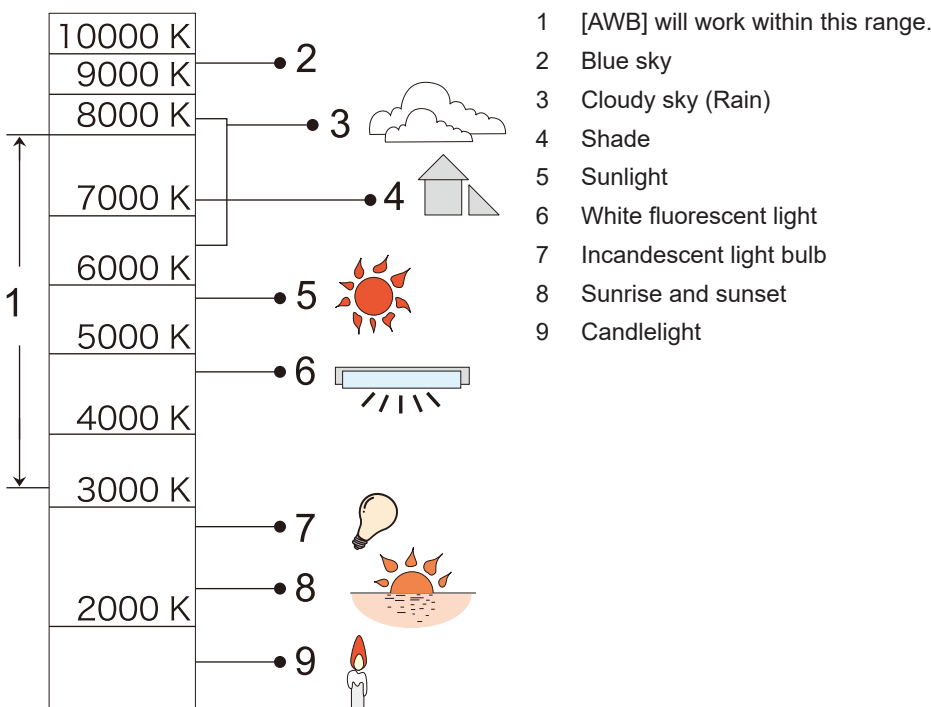

K=Kelvin Color Temperature

- Under lighting such as fluorescent or LED lighting, the appropriate white balance will vary depending on the lighting type. Use [AWB], [AWBc], [AWBw] or [K1] to [K4].
- The white balance is fixed to [AWB] while [Filter Settings] is being used.

## ■ Registering the White Set

Take pictures of a white object under the light source of the recording location to adjust the white balance until it appears white.

- ① **Press [Fn4] and then select any value from [ ] to [ ].**
  - At default setting, [White Balance] is assigned to [Fn4].
    - About Fn buttons (➔ [154 / Fn Buttons](#))
  - You can also set it from the [White Balance] of the [Video] ([Image Quality]) menu.
- ② **Press ▲.**
- ③ **Aim the camera at a white object so that it appears inside the frame at the center of the screen and then press [MENU/SET].**
  - This will set the white balance and return you to the recording screen.

## ■ Color Temperature Setting

Set the numeric value for the white balance color temperature.

- ① **Press [Fn4] and then select any value from [ ] to [ ].**
  - At default setting, [White Balance] is assigned to [Fn4].
    - About Fn buttons (➔ [154 / Fn Buttons](#))
  - You can also set it from the [White Balance] of the [Video] ([Image Quality]) menu.
- ② **Press ▲.**
  - The color temperature setting screen is displayed.
- ③ **Press ▲▼ to select the color temperature and then press [MENU/SET].**
  - You can set a color temperature from [2500K] to [10000K].

## Adjusting the White Balance

You can adjust the coloring when the coloring you want is not produced by the set white balance.

**① Press [Fn4].**

- At default setting, [White Balance] is assigned to [Fn4].
  - About Fn buttons (➔ [154 / Fn Buttons](#))
- You can also set it from the [White Balance] of the [Video] ([Image Quality]) menu.

**② Select the white balance and then press ▼.**

- The adjustment screen is displayed.

**③ Adjust the coloring.**

- ◀: [A] (AMBER: ORANGE)
- ▲: [G] (GREEN: GREENISH)
- ▶: [B] (BLUE: BLUISH)
- ▼: [M] (MAGENTA: REDDISH)
- Press [Fn1] to return to the unadjusted state.

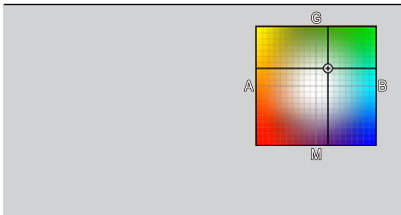

**④ Confirm your selection.**

- Press [MENU/SET].

- When the white balance is adjusted, the color of its recording screen icon changes to the adjusted color. Adjusting toward the [G] side will display [+], while adjusting toward the [M] side will display [-].

## [Master Pedestal Level]

You can adjust the black level, which serves as the reference for images.

### 1 Select [Master Pedestal Level].

- [MENU/SET] → [MODE] → [MENU] → [Master Pedestal Level]



### 2 Adjust master pedestal.

- Rotate .
- Set in the range between -15 and +15.

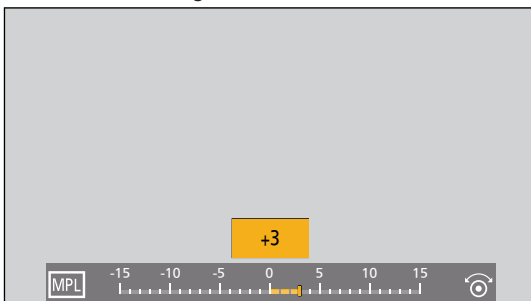















- [Master Pedestal Level] is not available when using the following function:
  - [V-Log L] ([Photo Style])

## [Photo Style]

You can select the finishing settings of images to suit your subjects and expression styles. The image quality can be adjusted for each Photo Style.

[MENU/SET] → [👤] → [🔍] → Select [Photo Style]

 <b>STD.</b>	<b>[Standard]</b>	The standard setting.
 <b>VIVID</b>	<b>[Vivid]</b>	A setting that produces a more vivid quality with higher saturation and contrast.
 <b>NAT</b>	<b>[Natural]</b>	A setting that produces a softer quality with lower contrast.
 <b>LAND</b>	<b>[Landscape]</b>	A setting suited for sceneries with vivid blue skies and greens.
 <b>PORT</b>	<b>[Portrait]</b>	A setting suited for portraits with a healthy and beautiful skin tone.
 <b>MONO</b>	<b>[Monochrome]</b>	A monochrome setting with no color shades.
 <b>L.MONO</b>	<b>[L.Monochrome]</b>	A black-and-white setting with rich gradation and crisp black accents.
 <b>L.MONO D</b>	<b>[L.Monochrome D]</b>	A monochrome setting that creates a dynamic impression with enhanced highlights and shadows.
 <b>CNED2</b>	<b>[Cinelike D2]</b>	A setting that creates a film-like finishing touch using a gamma curve and gives priority to the dynamic range. <ul style="list-style-type: none"> <li>This function is suitable for video editing processes.</li> </ul>
 <b>CNEV2</b>	<b>[Cinelike V2]</b>	A setting that creates a film-like finishing touch using a gamma curve that gives priority to the contrast.
 <b>709L</b>	<b>[Like709]</b>	A setting that minimizes overexposure by applying a gamma curve correction equivalent to Rec.709 to perform compression (knee adjustment) of high-luminance areas. <ul style="list-style-type: none"> <li>Rec.709 is an abbreviation of "ITU-R Recommendation BT.709", a standard for high definition broadcasting.</li> </ul>
 <b>V-Log L</b>	<b>[V-Log L]</b>	Gamma curve setting intended for post production processing. <ul style="list-style-type: none"> <li>It allows you to add rich gradation to images during post production editing.</li> </ul>
 <b>HLG</b>	<b>[Hybrid Log Gamma]</b>	A setting for recording motion pictures with a wide dynamic range in HLG format. (➔ <a href="#">122 / HLG Videos</a> )
 <b>MY 1</b>	<b>[MY PHOTO STYLE 1]*<sup>1</sup> to [MY PHOTO STYLE 10]*<sup>1</sup></b>	Adjusts the image quality of Photo Style items to your preferred settings and registers these as My Photo Style items. (➔ <a href="#">99 / Registering Settings in My Photo Style</a> )

\*1 Effects up to [MY PHOTO STYLE 4] are displayed with the default settings. You can set the items to display in the menu with [Show/Hide Photo Style] in [Photo Style Settings]. (➔ [185 / Show/Hide Photo Style](#))



- The range of available ISO sensitivities is different when [Photo Style] is set to the following: (➔ 89 / [Setting Items \(ISO Sensitivity\)](#))
  - [Like709], [V-Log L], [Hybrid Log Gamma]
    - The range of available ISO sensitivities is also different for [LOW] and [HIGH] in [Dual Native ISO Setting]. Reset the exposure if necessary when ISO sensitivity changes.
- You can set the knee mode with [Like709]. (➔ 100 / [Recording While Controlling Overexposure \(Knee\)](#))
- When [Filter Settings] is being used, [Photo Style] is not available.
- You can make detailed Photo Style settings:
  - [⚙️] ➔ [⏏️] ➔ [Photo Style Settings] (➔ 185 / [Photo Style Settings](#))





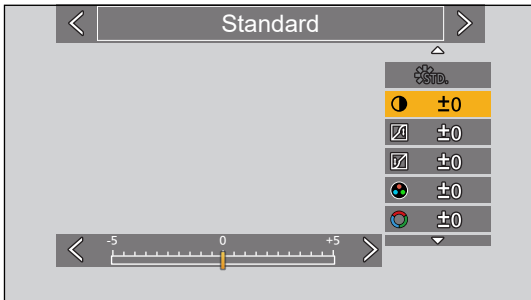







## Adjusting Image Quality

- 1 Press ◀▶ to select the type of Photo Style.
- 2 Press ▲▼ to select an item and then press ◀▶ to adjust.
  - Adjusted items are indicated with [✳️].



- 3 Press [MENU/SET].
  - When the image quality is adjusted, the Photo Style icon on the recording screen is indicated with [✳️].

### ■ Settings Items (Image Quality Adjustment)

	<b>[Contrast]</b> *1	Adjusts the contrast in the image.
	<b>[Highlight]</b> *1	Adjusts the brightness of bright areas.
	<b>[Shadow]</b> *1	Adjusts the brightness of dark areas.
	<b>[Saturation]</b> *2	Adjusts the vividness of colors.
	<b>[Color Tone]</b> *3	Adjusts blue and yellow tints.
	<b>[Hue]</b> *2	Assuming that the reference point is red, this rotates the hue toward violet/magenta or yellow/green to adjust the coloring of the entire image.
	<b>[Filter Effect]</b> *3	<p><b>[Yellow]:</b> Enhances the contrast. (Effect: weak) Records the sky with a clear blue.</p> <p><b>[Orange]:</b> Enhances the contrast. (Effect: medium) Records the sky with a darker blue.</p> <p><b>[Red]:</b> Enhances the contrast. (Effect: strong) Records the sky with a much darker blue.</p> <p><b>[Green]:</b> Skin and lips of people appear in natural tones. Green leaves appear brighter and more enhanced.</p> <p><b>[OFF]:</b> —</p>
	<b>[Sharpness]</b>	Adjusts the outlines in the image.
	<b>[Noise Reduction]</b>	Adjusts the noise reduction effect. <ul style="list-style-type: none"> <li>Increasing the effect may cause a slight drop in picture resolution.</li> </ul>
	<b>[Dual Native ISO Setting]</b> *4	Sets the Dual Native ISO. (➔ 90 / [Dual Native ISO Setting])
	<b>[Sensitivity]</b> *4	Sets the ISO sensitivity. (➔ 88 / ISO Sensitivity)
	<b>[White Balance]</b> *4	Sets the white balance. (➔ 91 / White Balance (WB)) <ul style="list-style-type: none"> <li>While [WB] is selected, press [Fn2] to display the white balance setting screen. Press [Fn2] again to return to the original screen.</li> </ul>

\*1 Cannot be adjusted when [Like709], [V-Log L] or [Hybrid Log Gamma] is selected.

\*2 Available when anything other than [Monochrome], [L.Monochrome], [L.Monochrome D] or [V-Log L] is selected.

\*3 Available when [Monochrome], [L.Monochrome] or [L.Monochrome D] is selected.

\*4 Available when the following is set while [MY PHOTO STYLE 1] to [MY PHOTO STYLE 10] are selected:

[Settings] ➔ [Photo Style Settings] ➔ [My Photo Style Settings] ➔ [Add Effects] ➔ [Sensitivity] / [White Balance] ➔ [ON]

## Registering Settings in My Photo Style

- ① Press ◀▶ to select the type of Photo Style.
- ② Adjust the image quality.
  - My Photo Style displays the types of Photo Style at the top of image quality adjustment. Select the base Photo Style.
- ③ Press [Fn1].
- ④ (When [MY PHOTO STYLE 1] to [MY PHOTO STYLE 10] is selected)  
Press ▲▼ to select [Save Current Setting] and then press [MENU/SET].
- ⑤ Press ▲▼ to select the registration destination number and then press [MENU/SET].
  - A confirmation screen will be displayed.  
On the confirmation screen, press [Fn1] to change the My Photo Style name.  
Up to 22 characters may be entered. Double-byte characters are treated as 2 characters.  
For information on how to enter characters (➔ [203 / Entering Characters](#))

## Changing the Registered Contents of My Photo Style

- ① Select any value from [MY PHOTO STYLE 1] to [MY PHOTO STYLE 10].
- ② Press [Fn1] and then set the item.
  - [Load Preset Setting]
  - [Save Current Setting]
  - [Edit Title]
  - [Restore to Default]

## Recording While Controlling Overexposure (Knee)

When [Photo Style] is set to [Like709], you can adjust the knee so that recording can be performed with minimal overexposure.

### 1 Set [Photo Style] to [Like709].

- [MENU/SET] → [P] → [K] → [Photo Style] → [Like709]

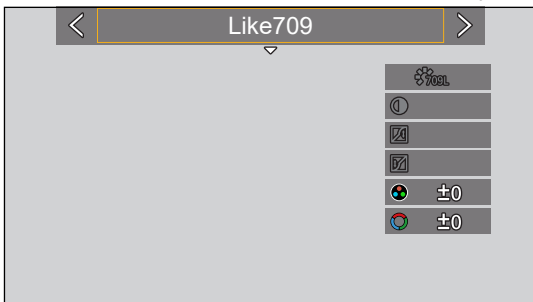

### 2 Press [Q.MENU].

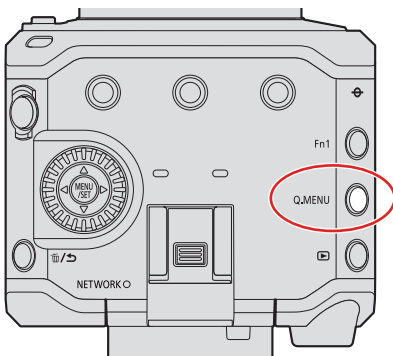

### 3 Select a knee setting.

- Press ◀▶ to select a setting item.

[AUTO]	Adjusts the compression levels of high-luminance areas automatically.
[MANUAL]	<p>Allows you to adjust the master knee point and master knee slope manually.</p> <p>① Press ▲▼ to select an item and then press ◀▶ to adjust.</p> <p>[POINT]: Master knee point [SLOPE]: Master knee slope</p> <ul style="list-style-type: none"> <li>• Values within the following ranges can be set:             <ul style="list-style-type: none"> <li>– Master knee point: 80.0 to 107.0</li> <li>– Master knee slope: 0 to 99</li> </ul> </li> </ul>
[Off]	—

### 4 Confirm your selection.

- Press [MENU/SET].

## [Filter Settings]

This mode records with additional image effects (filters).

### 1 Set the [Filter Effect].

- [MENU/SET] → [Filter Settings] → [Filter Effect] → [SET]

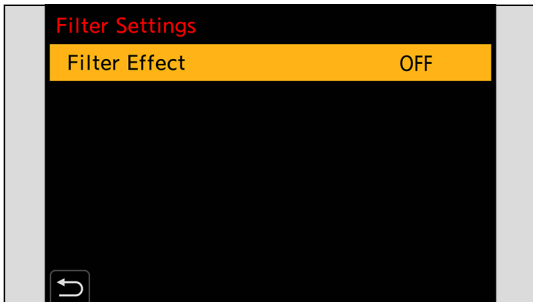

### 2 Select the filter.

- Press ▲▼ to select, and then press [MENU/SET].
- Press [Fn1] to switch the screen between normal display and guide display. The guide display shows the description of each filter.

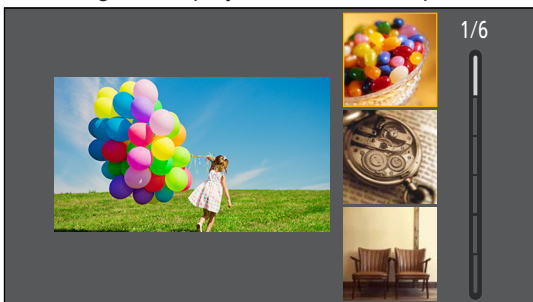

## Adjusting the Filter Effect

You can adjust the filter effect.

- ① Select the filter.
- ② On the recording screen, press ►.
- ③ Rotate  to set.
  - To return to the recording screen, press [MENU/SET] again.
  - When the filter effect is adjusted, the filter icon on the recording screen is indicated with [\*].



Filter	Items that can be adjusted
[Expressive]	Vividness
[Retro]	Coloring
[Old Days]	Contrast
[High Key]	Coloring
[Low Key]	Coloring
[Sepia]	Contrast
[Monochrome]	Coloring
[Dynamic Monochrome]	Contrast
[Impressive Art]	Vividness
[High Dynamic]	Vividness
[Cross Process]	Coloring
[Toy Effect]	Coloring
[Toy Pop]	Area with reduced peripheral brightness
[Bleach Bypass]	Contrast
[Miniature Effect]	Vividness
[Fantasy]	Vividness
[One Point Color]	Amount of color left

- White balance will be fixed to [AWB].
- The upper limit to ISO sensitivity is [6400].
- When [High Dynamic] is set, the ISO sensitivity is fixed to [AUTO].
- Depending on the filter, the recording screen may seem as if frames are missed.
- When [Image Area of Video] is [PIXEL/PIXEL], recording video with [Toy Effect] / [Toy Pop] is not possible.
- Filter on/off operations can be registered to a Fn button:  
 [Settings] → [Filter Effect] → [Fn Button Set] → [Setting in REC mode] → [Filter Effect] (→ [155 / Register Functions to the Fn Buttons](#))
- When displaying the [Filter Effect] setting screen using the Fn button, pressing [Fn1] displays the filter selection screen.

## Setting the Type of Defocus ([Miniature Effect])

- 1 Set [Filter Effect] to [Miniature Effect].
- 2 Press ▼ to display the setting screen.
- 3 Press ▲▼ or ◀▶ to move the in-focus portion.



- 4 Rotate ⦿ to change the size of in-focus portion.
  - To reset the in-focus portion setting to the default, press [Fn1].
- 5 Press [MENU/SET] to set.

- No audio is recorded in videos.
- When the system frequency is set to [59.94Hz (NTSC)], the length of the video recorded will be approx. 1/10 of the actual recording time. The displayed video recording time will be approx. 10 times longer than the recording time displayed during normal video recording.  
 When the system frequency is set to [50.00Hz (PAL)] or [24.00Hz (CINEMA)], the length of the video recorded will be approx. 1/8 of the actual recording time. The displayed video recording time will be approx. 8 times longer than the recording time displayed during normal video recording.
- If you end video recording after a short time, the camera may go on recording for a certain period.

## Setting the Color to Be Left ([One Point Color])

- ❶ Set [Filter Effect] to [One Point Color].
- ❷ Press ▼ to display the setting screen.
- ❸ Press ▲▼◀▶ to move the frame and select the color you want to leave.
  - To return the frame back to the center, press [Fn1].



- ❹ Press [MENU/SET].



# Audio Settings

## [Sound Rec Level Disp.]

The sound recording level is displayed on the recording screen.

[MENU/SET] → [M] → [M] → Select [Sound Rec Level Disp.]  
Settings: [ON] / [OFF]

- When [Sound Rec Level Limiter] is set to [OFF], [Sound Rec Level Disp.] is fixed to [ON].

## [Mute Sound Input]

This mutes audio input.

[MENU/SET] → [M] → [M] → Select [Mute Sound Input]  
Settings: [ON] / [OFF]

- [M] is displayed on the recording screen.
- The audio input from the external microphone will also be muted.

## [Sound Rec Gain Level]

This switches the gain of audio input.

[MENU/SET] → [M] → [M] → Select [Sound Rec Gain Level]

<b>[STANDARD]</b>	This is the standard input gain setting. (0 dB)
<b>[LOW]</b>	Audio input is reduced for recording in environments with loud noises. (-12 dB)

- [Sound Rec Gain Level] is not available when [Mic Socket] is set to **[LINE]** and an external audio device is connected.

## [Sound Rec Level Adj.]

Manually adjust the sound recording level.

### ① Select [Sound Rec Level Adj.].

- [MENU/SET] → [ ] → [ ] → [Sound Rec Level Adj.]

### ② Press ◀▶ to adjust the sound recording level and then press [MENU/SET].

- You can adjust the sound recording level within the range from [MUTE], [-18dB] to [+12dB] in steps of 1 dB.
- Displayed dB values are approximate.

- When set to [MUTE], [ ] is displayed in the recording screen.

## [Sound Rec Level Limiter]

The sound recording level is adjusted automatically to minimize sound distortion (crackling noise).

[MENU/SET] → [ ] → [ ] → Select [Sound Rec Level Limiter]

Settings: [ON] / [OFF]

## [Wind Noise Canceller]

This reduces the wind noise coming into the built-in microphone while maintaining sound quality.

[MENU/SET] → [ ] → [ ] → Select [Wind Noise Canceller]

[HIGH]	This effectively reduces the wind noise by reducing the low-pitched sound when a strong wind is detected.
[STANDARD]	This reduces wind noise without loss of sound quality by filtering out only wind noise.
[OFF]	—

- You may not see the full effect depending on the recording conditions.
- This function works only with the built-in microphone. When an external microphone is connected, [Wind Cut] is displayed. (→ [141 / Reduction of Wind Noise](#))

## [Lens Noise Cut]

You can reduce the zoom sound produced during video recording when you are using interchangeable lens compatible with power zoom.

[MENU/SET] → [ ] → [ ] → Select [Lens Noise Cut]

Settings: [ON] / [OFF]

- When this function is used, the sound quality may differ from that during normal operation.

# Main Assist Functions

This section describes the main assist functions that are convenient when recording.



- The [Custom] ([Monitor / Display]) menu has display assist functions such as the center marker. (➔ 188 / [Custom] menu ([Monitor / Display]))

## [Image Stabilizer]

Set the image stabilizer operation to match the recording situation.

- When using a lens with an O.I.S. switch, set the switch on the lens to ON.
- When you use a lens with no connection function with the camera, [Image Stabilizer] cannot be selected.
- When you use a lens without the stabilizer function, [Operation Mode] cannot be selected.

[MENU/SET] ➔  ➔  ➔ Select [Image Stabilizer]

<b>[Operation Mode]</b>	 <b>[Normal]:</b> Corrects vertical, horizontal, and rotational camera shake. This function is suitable for normal recording.
	<b>[OFF]:</b> Turns the in-lens image stabilization function OFF.
<b>[E-Stabilization (Video)]</b>	During video recording the 4 types of camera shakes, the vertical, horizontal, pitch, and yaw axes is corrected through the combined use of the in-lens and electronic image stabilizers. <ul style="list-style-type: none"> <li>• When [E-Stabilization (Video)] is working, the  of the recording screen will be switched to .</li> <li>• When set to [ON], the angle of view may become narrower.</li> </ul>

- The image stabilizers to be activated differ depending on your lens.
- When the following functions are being used, [E-Stabilization (Video)] is not available:
  - [Digital Zoom]
  - [Variable Frame Rate]
  - [Live Cropping]

## [SS/Gain Operation]

You can switch the units of shutter speed values and gain (sensitivity) values.

[MENU/SET] → [ ] → [ ] → Select [SS/Gain Operation]

<b>[SEC/ISO]</b>	Displays the shutter speed in seconds and the gain in ISO.
<b>[ANGLE/ISO]</b>	Displays the shutter speed in degrees and the gain in ISO. <ul style="list-style-type: none"> <li>The angle can be set in a range between 11° and 358°. (When [Synchro Scan] is set to [OFF])</li> </ul>
<b>[SEC/dB]</b>	Displays the shutter speed in seconds and the gain in dB. <ul style="list-style-type: none"> <li>0 dB corresponds to either of the following ISO sensitivity values. <ul style="list-style-type: none"> <li>When [Dual Native Gain Setting] is set to [AUTO] or [LOW]: [160]</li> <li>When [Dual Native Gain Setting] is set to [HIGH]: [800]</li> </ul> </li> </ul>

- When [SS/Gain Operation] is set to [SEC/dB], menu names change as shown below:
  - [Dual Native ISO Setting] → [Dual Native Gain Setting]
  - [ISO Sensitivity (video)] → [Gain Setting]
  - [ISO Auto Lower Limit Setting] → [Auto Gain Lower Limit Setting]
  - [ISO Auto Upper Limit Setting] → [Auto Gain Upper Limit Setting]
  - [Extended ISO] → [Extended Gain Setting]

## Setting Range for Gain (Sensitivity)

When [SS/Gain Operation] is set to [SEC/dB], gain (sensitivity) can be set in the following ranges.

[Dual Native Gain Setting]	[Extended Gain Setting]	Setting Range for Gain (Sensitivity)
<b>[AUTO]</b>	<b>[OFF]</b>	[AUTO], [0 dB] to [50 dB]
	<b>[ON]</b>	[AUTO], [-6 dB] to [62 dB]
<b>[LOW]</b>	<b>[OFF]</b>	[AUTO], [0 dB] to [14 dB]
	<b>[ON]</b>	[AUTO], [-6 dB] to [14 dB]
<b>[HIGH]</b>	<b>[OFF]</b>	[AUTO], [0 dB] to [36 dB]
	<b>[ON]</b>	[AUTO], [0 dB] to [48 dB]

## [Luminance Spot Meter]

Specify any spot on the subject to measure the luminance over a small area.

### 1 Set [Luminance Spot Meter].

- [MENU/SET] → [Settings] → [Camera] → [Luminance Spot Meter] → [ON]

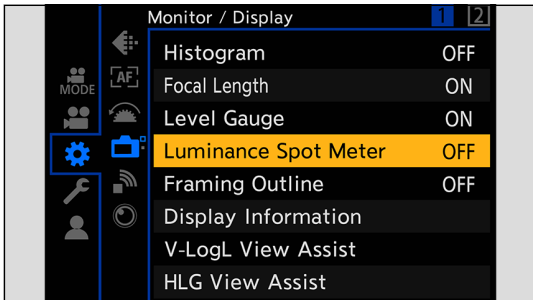

### 2 Select the position where you want to measure the luminance.

- Press ▲▼◀▶ to select and then press [MENU/SET].
- To return the position back to the center, press [Fn1].



#### ■ Measurement Range

Measuring is possible in the range -7% to 109% (IRE).

- When [Photo Style] is set to [V-Log L], this can be measured with Stop units. (Calculated as 0 Stop=42% (IRE))

## [Zebra Pattern]

Parts that are brighter than the benchmark value are displayed with stripes.

You can also set the benchmark value and the breadth of the range so that the stripes are displayed on parts that are within the range of brightness you specify.



[ZEBRA1]



[ZEBRA2]



[ZEBRA1+2]

[MENU/SET] → [⚙️] → [📷] → Select [Zebra Pattern]

[ZEBRA1]	Parts that are brighter than the benchmark value are displayed with [ZEBRA1] stripes.
[ZEBRA2]	Parts that are brighter than the benchmark value are displayed with [ZEBRA2] stripes.
[ZEBRA1+2]	Both [ZEBRA1] and [ZEBRA2] are displayed.
[OFF]	—
[SET]	Sets the benchmark brightness. [Zebra 1] / [Zebra 2] 50% to 105% / [BASE/RANGE]

### When [BASE/RANGE] Was Selected with [SET]

Centered on the brightness set with [Base Level], parts with the brightness in the range set in [Range] are displayed with the stripes.

- [Base Level] can be set in the range between 0% and 109% (IRE).
  - [Range] can be set in the range between  $\pm 1\%$  and  $\pm 10\%$  (IRE).
  - When [Photo Style] is set to [V-Log L], these are set at Stop units. (Calculated as 0 Stop=42% (IRE))
- [ZEBRA1+2] cannot be selected while you are setting [BASE/RANGE].

## [Frame Marker]

A frame with the set aspect ratio is displayed on the recording screen.

This allows you to see during recording the angle of view that will be achieved with trimming (cropping) in post-processing.

[MENU/SET] → [⚙️] → [📺] → Select [Frame Marker]

[ON]	Displays video grid lines on the recording screen.
[OFF]	—
[SET]	Sets the aspect ratio of video grid lines. [Frame Aspect]: [2.39:1] / [2.35:1] / [2.00:1] / [1.85:1] / [16:9] / [4:3] / [5:4] / [1:1] / [4:5] / [9:16]
	[Frame Color]: Sets the color of video grid lines.
	Sets the outer side opacity of video grid lines. [Frame Mask]: [100%] / [75%] / [50%] / [25%] / [OFF]

## Color bars / Test Tone

The color bars are displayed on the recording screen. A test tone is output while the color bars are being displayed.

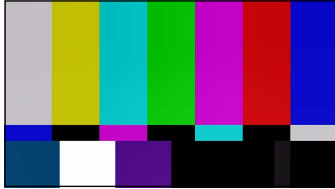

[SMPTE]

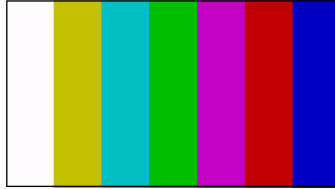

[EBU]



[ARIB]

[MENU/SET] → [⚙️] → [📺] → Select [Color Bars]

Settings: [SMPTE] / [EBU] / [ARIB]

- To end the display, press [MENU/SET].

### ■ Adjusting the Test Tone

There are 4 levels ([−12dB], [−18dB], [−20dB], and [MUTE]) of test tone to select.

① Rotate  to select the test tone level.

- The color bars and test tone will be recorded on the video if video recording is started while the color bars are being displayed.

# 6. Special Video Recording

## [Variable Frame Rate]

By recording using a frame rate that is different to the playback frame rate, you can record smooth slow motion video and fast motion video.

<b>Slow Motion Video (Overcrank Recording)</b>	Set a number of frames that is higher than the recording frame rate of the [Rec Quality]. For example: When recording at 48 fps and set to a 24.00p [Rec Quality], the speed is halved.
<b>Fast Motion Video (Undercrank Recording)</b>	Set a number of frames that is lower than the recording frame rate of the [Rec Quality]. For example: When recording at 12 fps and set to a 24.00p [Rec Quality], the speed is doubled.

### 1 Set [Rec. File Format] to [MOV].

- [MENU/SET] → [MODE] → [Image Format] → [Rec. File Format] → [MOV]

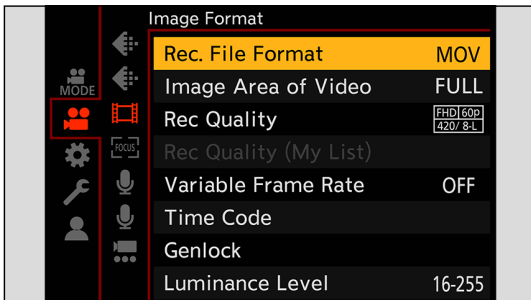

### 2 Select a recording quality with which you can use [Variable Frame Rate] recording.

- [MENU/SET] → [MODE] → [Image Format] → [Rec Quality]
- Items with which you can use [Variable Frame Rate] are indicated as [VFR available].
- Recording qualities with which you can use [Variable Frame Rate] recording: → [129 / List of Recording Qualities That Enable Special Videos to be Recorded](#)

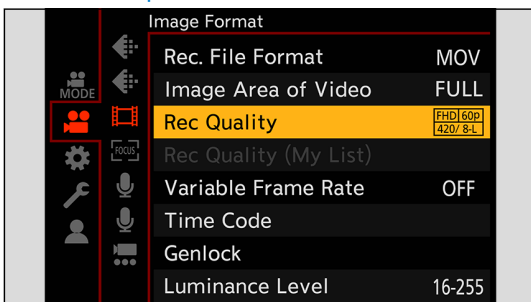



### 3 Set [Variable Frame Rate].

- [MENU/SET] → [ ] → [ ] → [Variable Frame Rate] → [ON]
- Press ◀▶ to switch between [ON] and [OFF].

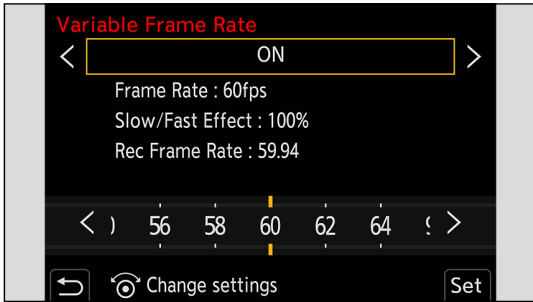

### 4 Set the frame rate.

- Rotate ⚙ to select a numeric value, then press [MENU/SET].
- The angle of view is reduced when you set to a frame rate exceeding 200 fps.

#### Available Frame Rate Setting Ranges

The frame rate you can set differs depending on the [Rec Quality] settings.

[Rec Quality]	Frame rate
Anamorphic (4:3) video / C4K video / 4K video	2 fps to 60 fps
FHD video	2 fps to 240 fps* <sup>1</sup>

\*<sup>1</sup> When [Image Area of Video] is set to [PIXEL/PIXEL], it is not possible to set to a frame rate exceeding 150 fps.

- You can filter to show just the recording qualities where [Variable Frame Rate] can be used. (➔ 60 / [Filtering])
- When using [Variable Frame Rate], it is recommended to fix the camera so it does not move.
- Focus mode switches to MF.  
(When using an interchangeable lens with no focus ring, you cannot set focus with MF.)
- Audio will not be recorded during variable frame rate recording.
- When set to a frame rate exceeding 60 fps, there may be some deterioration in recording quality.
- When the following functions are being used, [Variable Frame Rate] is not available:
  - [Filter Settings]
  - [Live Cropping]

# [Focus Transition]

Smoothly transitions the focus position from the current position to a position registered in advance.

## 1 Select [Focus Transition].

- [MENU/SET] → [ ] → [ ] → [Focus Transition]

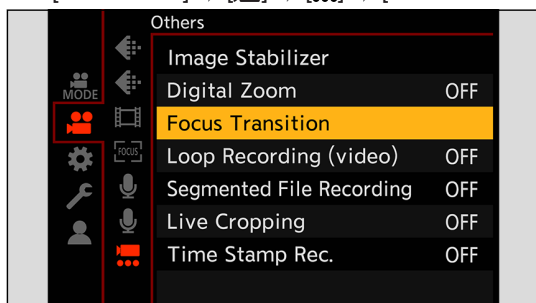

## 2 Set the recording settings.

[Start]	Start recording.
[Focus Pull Setting]	Registers the focus position. <ul style="list-style-type: none"> <li>• The setting screen for the focus position is displayed when you select either [1], [2], or [3]. Use the same procedure as MF (→ 79 / Record Using MF) to check the focus, then press [MENU/SET] to register the focus position.</li> </ul>
[Focus Transition Speed]	Sets the moving speed of focus. <ul style="list-style-type: none"> <li>• Moving speed: [SH] (fast) to [SL] (slow)</li> </ul>
[Focus Transition Rec]	Starts Focus Transition when recording starts. <ul style="list-style-type: none"> <li>• Select the position registered with [Focus Pull Setting].</li> </ul>
[Focus Transition Wait]	Sets the wait time before the start of Focus Transition.

## 3 Close the menu.

- Selects [Start], and press [MENU/SET].
- The recording screen is displayed.
- To return to the setting screen, press [Fn1].

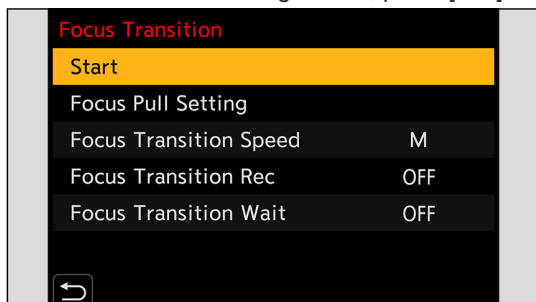

## 4 Start recording.

- Press the video rec. button.
- If you have enabled [Focus Transition Rec], Focus Transition will start when you start recording a video.

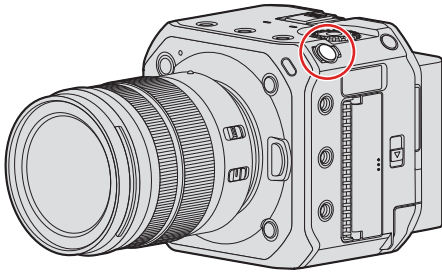

## 5 Start Focus Transition.

- Press ◀▶ to select [1], [2], or [3], and then press [MENU/SET].
- When [Focus Transition Wait] is set, Focus Transition starts after the set time has elapsed.

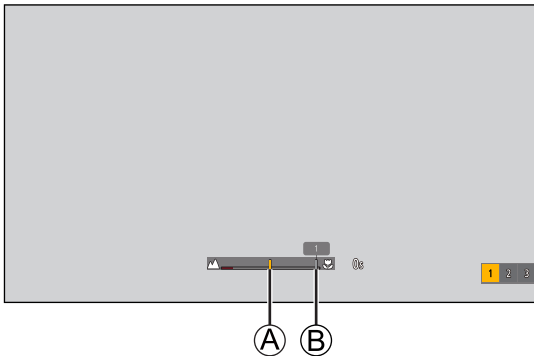

- Ⓐ Current focus position
- Ⓑ Registered focus position

## 6 End Focus Transition.

- Press [Q.MENU].

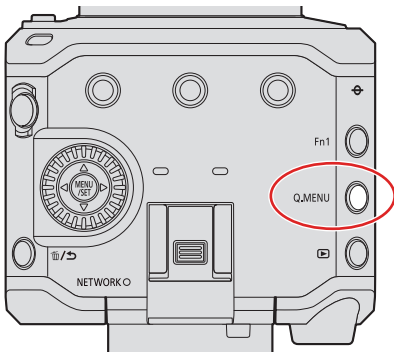

## 7 Stop recording.

- Press the video rec. button once again.

- Maintain the same distance to the subject after setting the focus position.
- The moving speed of focus varies depending on the lens being used.
- While using [Focus Transition], it is not possible to focus on anything other than the registered focus position.
- Any of the operations below will clear the focus position settings.
  - Operating the camera ON/OFF button
  - Zoom operation
  - Switching the focus mode
  - Switching the recording mode
  - Replacing the lens
- When the following functions are being used, [Focus Transition] is not available:
  - [Variable Frame Rate]
  - [Live Cropping]
- [Focus Transition] cannot be used when using an interchangeable lens that does not support the AF continuous function.

# [Live Cropping]

By cropping a part of the image from the image displayed in the live view, it is possible to record FHD video that incorporates panning and zooming with the camera staying in a fixed position.



Pan



Zoom in

- When using [Live Cropping], it is recommended to fix the camera so it does not move.

## 1 Set [Rec. File Format].

- [MENU/SET] → [MODE] → [Image Format] → [Rec. File Format] → [MP4] / [MOV]

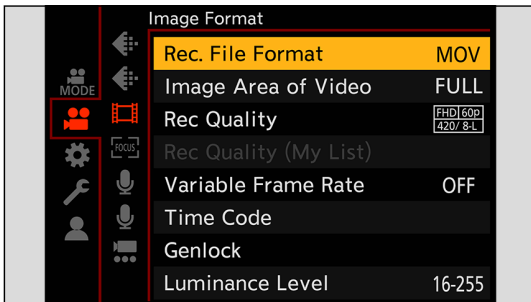

## 2 Select a recording quality with which you can record [Live Cropping] video.

- [MENU/SET] → [MODE] → [Image Format] → [Rec Quality]
- A recording quality with which you can record [Live Cropping] video: → [129 / List of Recording Qualities That Enable Special Videos to be Recorded](#)

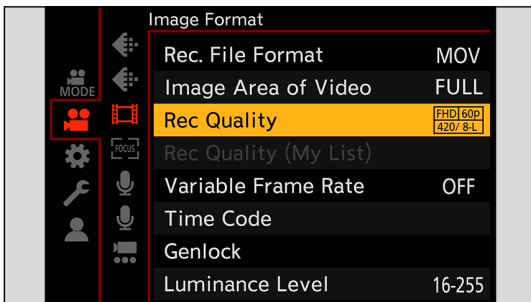

### 3 Set the time for panning or zooming.

- [MENU/SET] → [MODE] → [LIVE CROPPING] → [40SEC] / [20SEC]
- If you have selected a recording format or recording quality where Live Cropping recording is not available, the camera switches to a recording format or FHD video recording quality where recording is possible.

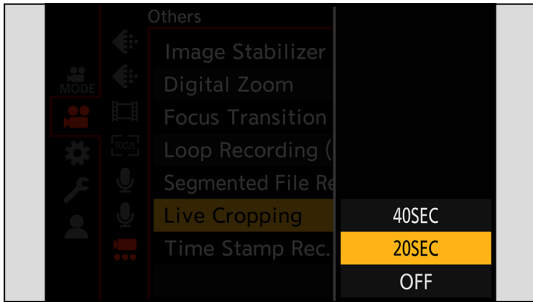

### 4 Set the cropping start frame.

- Select the range to be cropped and press [MENU/SET].

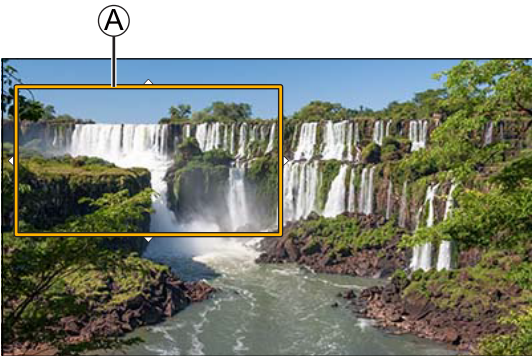

Ⓐ Cropping start frame

### 5 Set the cropping end frame.

- Select the range to be cropped and press [MENU/SET].
- To redo the settings for the position and size of the start frame and the end frame, press ◀.

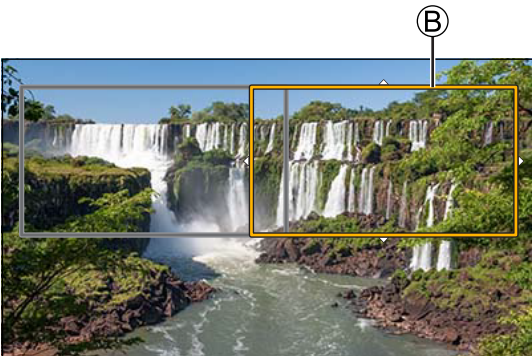

Ⓑ Cropping end frame

## 6 Start Live Cropping recording.

- Press the video rec. button.
- When the set operating time has elapsed, recording automatically ends. To end recording midway, press the video rec. button again.

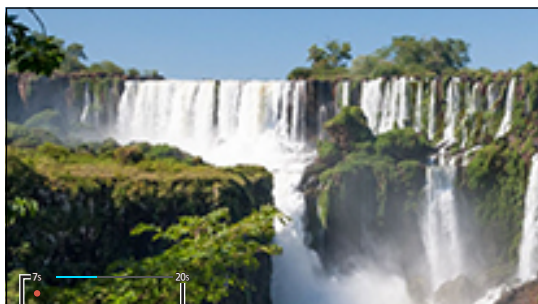
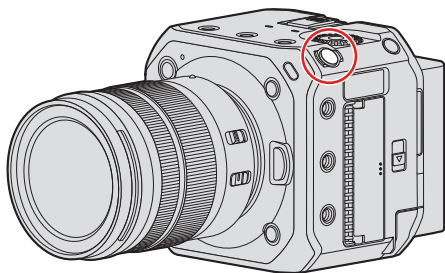

C

D

© Elapsed recording time

Ⓓ Set operating time

### ■ Operations for Setting the Cropping Frame

Button operation	Description of operation
▲▼◀▶	Moves the frame.
⊙	Enlarges / reduces the frame.
[Fn1]	<b>Start frame:</b> Returns the frame position and size to the default settings. <b>End frame:</b> Cancels the settings for the position and size of the frame.
[MENU/SET]	Confirms the frame position and size.

- AF mode switches to [i] (face detection). (Human bodies cannot be detected. It is not possible to specify the person to bring into focus.)
- Brightness measurements and focusing are performed within the cropping frame. To lock the focus point, set [Continuous AF] to [OFF], or set the focus mode to [MF].
- [Metering Mode] will be [☉] (multi-metering).

# Log Recording

## [V-Log L] Settings

Setting [Photo Style] to [V-Log L] enables Log recording. Images finished with rich gradation can be created through post production processing.

[MENU/SET] → [ ] → [ ] → [Photo Style] → Select [V-Log L]

- Post-production processing is enabled by utilizing LUT (Look-Up Table).  
You can download LUT data from the following support site:  
<https://panasonic.jp/support/global/cs/dsc/download/index3.html>  
(English only)

## ISO Sensitivity When [V-Log L] Is Set

The lower limit of available ISO sensitivity is [400], and the upper limit is [25600].

- The range of available ISO sensitivities is also different for [LOW] and [HIGH] in [Dual Native ISO Setting].
- Reset the exposure if necessary when ISO sensitivity changes.

## Exposure When [V-Log L] Is Set

The [V-Log L] curve characteristics comply with “V-Log/V-Gamut REFERENCE MANUAL Rev.1.0”. When set to [V-Log L], the standard exposure when gray with a reflectance ratio of 18% is imaged is IRE 42%.

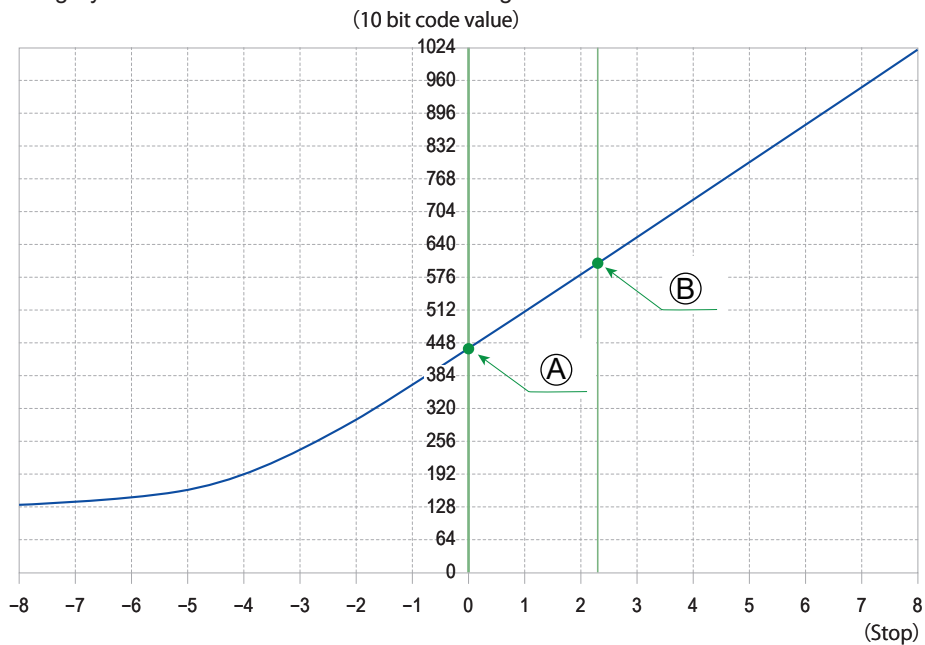

- (A) Reflectance ratio: 18%  
(B) Reflectance ratio: 90%



## When [Photo Style] is set to [V-Log L]

Reflectance ratio (%)	0	18	90
IRE(%)	7.3	42	61
Stop	—	0.0	2.3
10 bit code value	128	433	602
12 bit code value	512	1732	2408

- When luminance is to be displayed by Stop units, this camera calculates IRE 42% to 0 Stop.

- Luminance can be checked by Stop units:

[Settings] → [Camera] → [Luminance Spot Meter] (→ 109 / [Luminance Spot Meter])

[Settings] → [Camera] → [Zebra Pattern] (→ 110 / [Zebra Pattern])

## [V-LogL View Assist]

When [Photo Style] is set to [V-Log L], images output via HDMI/SDI will darken. Using [V-LogL View Assist] means you can output images with LUT data applied via HDMI/SDI.

[MENU/SET] → [Settings] → [Camera] → Select [V-LogL View Assist]

[Read LUT File]	Reads LUT data from the card.
[LUT Select]	Selects the LUT data to be applied from among the preset ([Vlog_709]) and registered LUT data.
[LUT View Assist (HDMI)]	Applies LUT data to images output over HDMI.
[LUT View Assist (SDI)]	Applies LUT data to images output over SDI.

- When applying the LUT data, [LUT] is displayed on the recording screen.
- Up to 4 LUT data files can be registered.

### ■ Reading LUT Files

- The following LUT data can be used:
  - The “.vlt” format, which meets the requirements specified in the “VARICAM 3DLUT REFERENCE MANUAL Rev.1.0”
  - File names consisting of up to 8 alphanumeric characters (excluding extension)
- Save the LUT data with a file extension of “.vlt” in the root directory of the card (the folder opened when the card is opened on a PC).

- Insert a card on which LUT data is saved into the camera.
- Select [Read LUT File].
  - [MENU/SET] → [Settings] → [Camera] → [V-LogL View Assist] → [Read LUT File] → [Card Slot 1] / [Card Slot 2]
- Press ▲▼ to select the LUT data to read and then press [MENU/SET].
- Press ▲▼ to select the location to register the data, and then press [MENU/SET].
  - When registered items are selected, they will be overwritten.

# HLG Videos

Record videos with the wide dynamic range of the HLG format. You can record in very bright light where overexposure can occur or in dark areas where underexposure can occur, maintaining the rich yet subtle colors you can see with your naked eye. You can view the video that you record by outputting via HDMI/SDI to devices (TVs, etc.) that support the HLG format, or playing back directly on supporting devices.

- “HLG (Hybrid Log Gamma)” is an international standard (ITU-R BT.2100) HDR format.

## [Hybrid Log Gamma] settings

### 1 Set [Rec. File Format].

- [MENU/SET] → [MODE] → [RECORD] → [Rec. File Format] → [MP4] / [MOV]

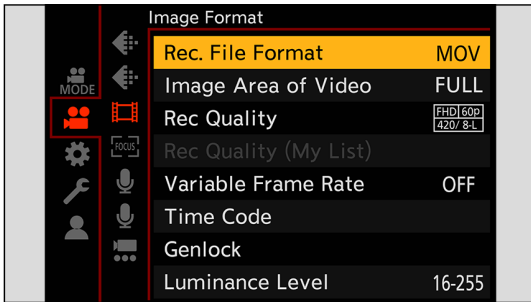

### 2 Select a recording quality with which you can record HLG video.

- [MENU/SET] → [MODE] → [RECORD] → [Rec Quality]
- Items available for recording with HLG video are indicated as [HLG available].
- Recording qualities with which you can record HLG video: → [129 / List of Recording Qualities That Enable Special Videos to be Recorded](#)

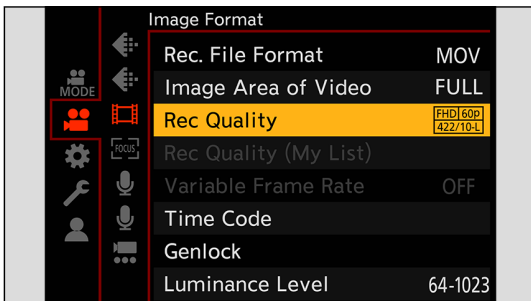

### 3 Set [Photo Style] to [Hybrid Log Gamma].

- [MENU/SET] → [MODE] → [RECORD] → [Photo Style] → [Hybrid Log Gamma]

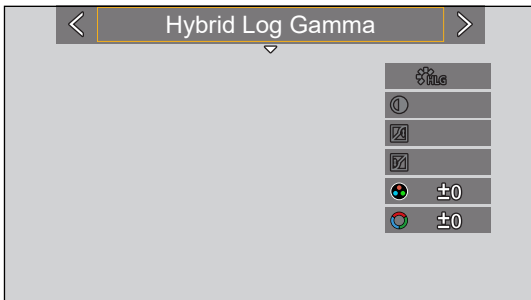

- When the [Rec. File Format] has been set to [MOV], you can filter to show just the recording qualities where HLG video recording can be used. (➔ 60 / [Filtering])
- HLG images are shown dark on devices that do not support the HLG format. With [HDMI] / [SDI] in [HLG View Assist] of the [Custom] ([Monitor / Display]) menu, you can set the conversion method for images displayed for monitoring. (➔ 123 / [HLG View Assist])

## ISO Sensitivity When [Hybrid Log Gamma] Is Set

The lower limit of available ISO sensitivities will become [320].

- The range of available ISO sensitivities is also different for [LOW] and [HIGH] in [Dual Native ISO Setting].
- Reset the exposure if necessary when ISO sensitivity changes.

## [HLG View Assist]

At recording or playback of an HLG video, this outputs images with converted color gamut and brightness over HDMI/SDI.

[MENU/SET] ➔ [⚙️] ➔ [📺] ➔ [HLG View Assist] ➔ Select [HDMI] or [SDI]

[AUTO]*1	The image to be output via HDMI will only be converted with the setting of [MODE2] when connected to a device that does not support HDR (HLG format).
[MODE1]	Converts with an emphasis on bright areas such as the sky. <ul style="list-style-type: none"> <li>• [MODE1] is displayed on the recording screen.</li> </ul>
[MODE2]	Converts with an emphasis on the brightness of a main subject. <ul style="list-style-type: none"> <li>• [MODE2] is displayed on the recording screen.</li> </ul>
[OFF]	Displays without converting color gamut and brightness. <ul style="list-style-type: none"> <li>• HLG images appear darker on devices that do not support the HLG format.</li> </ul>

\*1 Can only be set while [HDMI] is selected.

# Anamorphic Recording

This camera can record video with a resolution of 4K-A (anamorphic (4:3) video) that is compatible with anamorphic recording with an aspect ratio of 4:3.

## Anamorphic (4:3) video

### 1 Set [Rec. File Format] to [MOV].

- [MENU/SET] → [ ] → [ ] → [Rec. File Format] → [MOV]

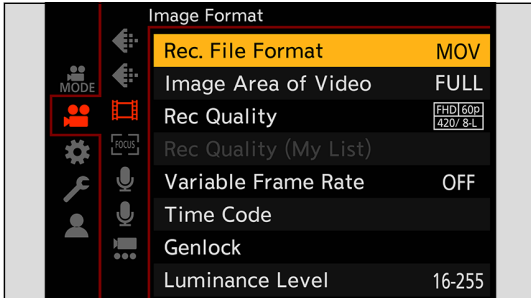

### 2 Select a recording quality wherein you can record Anamorphic (4:3) video.

- [MENU/SET] → [ ] → [ ] → [Rec Quality]
- Items available for recording Anamorphic (4:3) video are indicated as [ANAMOR].
- Recording qualities wherein you can record Anamorphic (4:3) video: → [129 / List of Recording Qualities That Enable Special Videos to be Recorded](#)

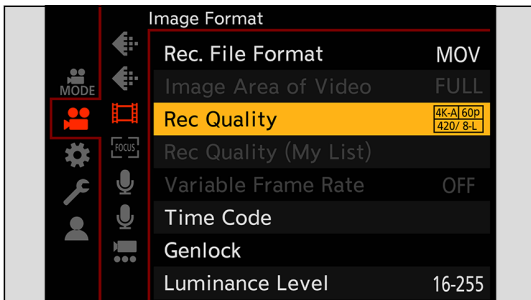

- By filtering [Rec Quality] by the number of pixels, you can display just those recording qualities that can record Anamorphic (4:3) video. (→ [60 / \[Filtering\]](#))

## [Anamorphic Desqueeze Display]

Display the desqueezed images suited to the magnification of the anamorphic lens. Using the [Frame Marker], it is also possible to impose on display the frame of the angle of view when cropping after de-squeeze editing.

### 1 Set [Anamorphic Desqueeze Display].

- [MENU/SET] → [⚙️] → [📷] → [Anamorphic Desqueeze Display]  
Settings: [2.0x] / [1.8x] / [1.5x] / [1.33x] / [1.30x] / [OFF]
- Make settings to suit the magnification of the anamorphic lens you are using.

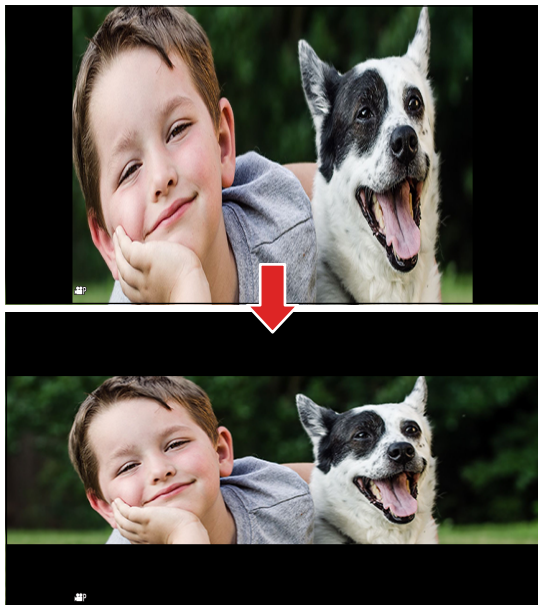

### 2 Set [Frame Marker].

- [MENU/SET] → [⚙️] → [📷] → [Frame Marker] (→ 111 / [Frame Marker])

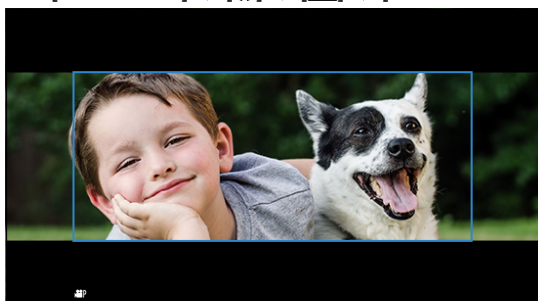

- During recording, images output via HDMI are not displayed de-squeezed.

# [Synchro Scan]

Fine-adjust the shutter speed to reduce flickering and horizontal stripes.

The shutter speed set in Synchro Scan is saved separately from the shutter speed used for normal recording. In the Synchro Scan setting screen you can call up the current shutter speed for normal recording and adjust it.

## 1 Set the exposure mode to [S] or [M].

- [MENU/SET] → [MODE] → [MENU/SET] → [Exposure Mode] → [S] / [M]

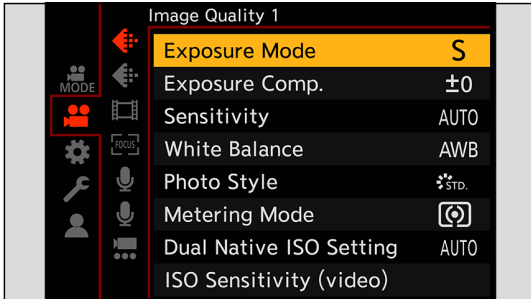

## 2 Set [Synchro Scan].

- [MENU/SET] → [MODE] → [MENU/SET] → [Synchro Scan] → [ON]



## 3 Set the shutter speed.

- Rotate  to select a numeric value, then press [MENU/SET].
- You can call up the current shutter speed for normal recording by pressing [Fn1].
- Adjust the shutter speed while looking at the screen so that flickering and horizontal stripes will be minimized.

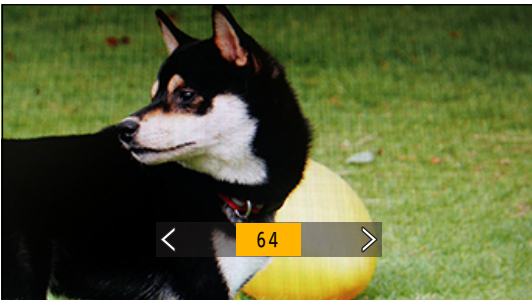

- When you set [Synchro Scan] to [ON], the available shutter speed range becomes narrower.

# [Loop Recording (video)]

Even when recording uses up the card's free space, the camera continues the recording by deleting the oldest segment of the recorded data.

## 1 Set [Rec. File Format] to [MOV].

- [MENU/SET] → [ ] → [ ] → [Rec. File Format] → [MOV]

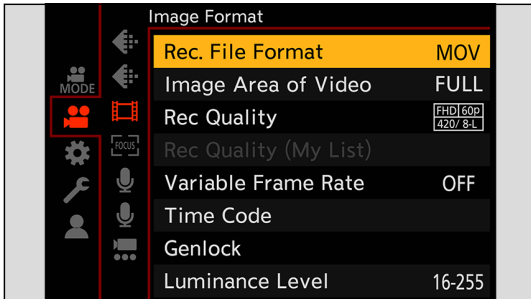

## 2 Set [Loop Recording (video)].

- [MENU/SET] → [ ] → [ ] → [Loop Recording (video)] → [ON]
- [ ] is displayed on the recording screen.
- When the recording fills the card to capacity, loop recording starts and video recording time is no longer displayed.

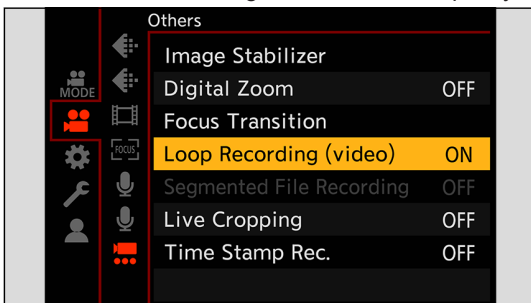

- Make sure the camera does not turn off during recording.
- Loop recording cannot start if there is insufficient available capacity on the card.
- When the recording time exceeds 12 hours, recording continues with data being deleted in order from the point where recording started.
- When the following functions are being used, [Loop Recording (video)] is not available:
  - [Rec Quality] with a bit rate of 400 Mbps
  - [Variable Frame Rate]
  - [Live Cropping]

# [Segmented File Recording]

To avoid video loss due to unforeseen interruptions to the power supply, recorded video is divided every few minutes while MOV video is being recorded.

- The divided videos are saved as one group image.

## 1 Set [Rec. File Format] to [MOV].

- [MENU/SET] → [MODE] → [Image Format] → [Rec. File Format] → [MOV]

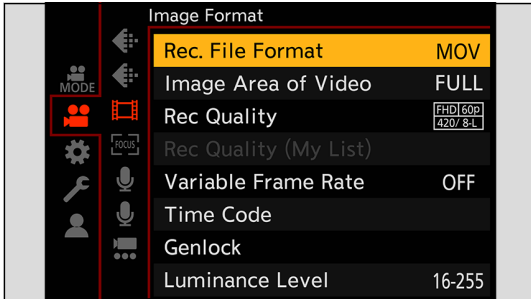

## 2 Set [Segmented File Recording].

- [MENU/SET] → [MODE] → [Others] → [Segmented File Recording] → [10MIN.] / [5MIN.] / [3MIN.] / [1 MIN.]

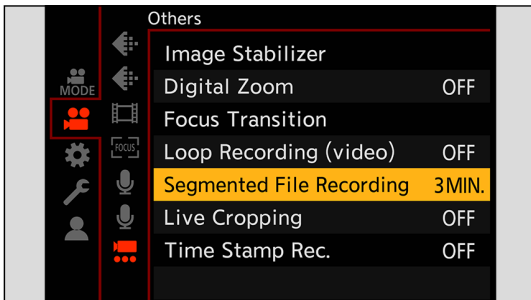

- When the following function is being used, [Segmented File Recording] is not available:
  - [Loop Recording (video)]



# List of Recording Qualities That Enable Special Videos to be Recorded

**VFR:** Recording qualities that enable use of [Variable Frame Rate]

**Live Crop:** Recording qualities that enable use of [Live Cropping]

**HLG:** Recording qualities with which you can record HLG video

**ANAMOR 4:3:** Recording qualities for anamorphic recording with an aspect ratio of 4:3

## [Rec. File Format]: [MP4]

### ■ [System Frequency]: [59.94Hz (NTSC)]

[Rec Quality]	Live Crop	HLG
[4K/10bit/100M/60p]		✓
[4K/8bit/100M/30p]		
[4K/10bit/72M/30p]		✓
[4K/8bit/100M/24p]		
[4K/10bit/72M/24p]		✓
[FHD/8bit/28M/60p]	✓	
[FHD/8bit/20M/30p]	✓	
[FHD/8bit/24M/24p]		

### ■ [System Frequency]: [50.00Hz (PAL)]

[Rec Quality]	Live Crop	HLG
[4K/10bit/100M/50p]		✓
[4K/8bit/100M/25p]		
[4K/10bit/72M/25p]		✓
[FHD/8bit/28M/50p]	✓	
[FHD/8bit/20M/25p]	✓	

**[Rec. File Format]: [MOV]****■ [System Frequency]: [59.94Hz (NTSC)]**

[Rec Quality]	VFR	Live Crop	HLG	ANAMOR 4:3
[4K-A/60p/420/8-L]				✓
[4K-A/30p/422/10-I]			✓	✓
[4K-A/30p/422/10-L]			✓	✓
[4K-A/30p/420/8-L]	✓			✓
[4K-A/24p/422/10-I]			✓	✓
[4K-A/24p/422/10-L]			✓	✓
[4K-A/24p/420/8-L]	✓			✓
[C4K/60p/420/10-L]			✓	
[C4K/60p/420/8-L]				
[C4K/30p/422/10-I]			✓	
[C4K/30p/422/10-L]			✓	
[C4K/30p/420/8-L]	✓			
[C4K/24p/422/10-I]			✓	
[C4K/24p/422/10-L]			✓	
[C4K/24p/420/8-L]	✓			
[4K/60p/420/10-L]			✓	
[4K/60p/420/8-L]				
[4K/30p/422/10-I]			✓	
[4K/30p/422/10-L]			✓	
[4K/30p/420/8-L]	✓			
[4K/24p/422/10-I]			✓	
[4K/24p/422/10-L]			✓	
[4K/24p/420/8-L]	✓			
[FHD/60p/422/10-I]			✓	
[FHD/60p/422/10-L]			✓	
[FHD/60p/420/8-L]	✓	✓		
[FHD/30p/422/10-I]		✓	✓	
[FHD/30p/422/10-L]		✓	✓	
[FHD/30p/420/8-L]	✓	✓		
[FHD/24p/422/10-I]		✓	✓	
[FHD/24p/422/10-L]		✓	✓	
[FHD/24p/420/8-L]	✓	✓		

## ■ [System Frequency]: [50.00Hz (PAL)]

[Rec Quality]	VFR	Live Crop	HLG	ANAMOR 4:3
[4K-A/50p/420/10-L]			✓	✓
[4K-A/50p/420/8-L]				✓
[4K-A/25p/422/10-I]			✓	✓
[4K-A/25p/422/10-L]			✓	✓
[4K-A/25p/420/8-L]	✓			✓
[C4K/50p/420/10-L]			✓	
[C4K/50p/420/8-L]				
[C4K/25p/422/10-I]			✓	
[C4K/25p/422/10-L]			✓	
[C4K/25p/420/8-L]	✓			
[4K/50p/420/10-L]			✓	
[4K/50p/420/8-L]				
[4K/25p/422/10-I]			✓	
[4K/25p/422/10-L]			✓	
[4K/25p/420/8-L]	✓			
[FHD/50p/422/10-I]			✓	
[FHD/50p/422/10-L]			✓	
[FHD/50p/420/8-L]	✓	✓		
[FHD/25p/422/10-I]		✓	✓	
[FHD/25p/422/10-L]		✓	✓	
[FHD/25p/420/8-L]	✓	✓		

## ■ [System Frequency]: [24.00Hz (CINEMA)]

[Rec Quality]	VFR	Live Crop	HLG	ANAMOR 4:3
[4K-A/24p/422/10-I]			✓	✓
[4K-A/24p/422/10-L]			✓	✓
[4K-A/24p/420/8-L]	✓			✓
[C4K/24p/422/10-I]			✓	
[C4K/24p/422/10-L]			✓	
[C4K/24p/420/8-L]	✓			
[4K/24p/422/10-I]			✓	
[4K/24p/422/10-L]			✓	
[4K/24p/420/8-L]	✓			
[FHD/24p/422/10-I]		✓	✓	
[FHD/24p/422/10-L]		✓	✓	
[FHD/24p/420/8-L]	✓	✓		

# 7. Output image

In this chapter, image settings output to the external device during recording is explained.

- The resolution of the image to be output via HDMI/SDI differs depending on the settings of [Rec Quality].
  - When the image is not output (➔ [251 / External device](#))
- Output settings during playback (➔ [195 / \[Output Resolution\(Playback\)\]](#))

## Images Output via HDMI

Aspect ratio, resolution, and frame rate output is according to the [Rec Quality] settings in the [Video] ([Image Format]) menu. Resolution and frame rate can be down-converted for output according to the application. YUV 4:2:2 is used for YUV and bit value output, as shown below.

Recording to card	HDMI output
4:2:2 10 bit	4:2:2 10 bit
4:2:0 10 bit	4:2:2 10 bit
4:2:0 8 bit	4:2:2 8 bit

### ■ Resolution, frame rate

- Resolution and frame rate is output according to the following menu combinations:
    - [Rec Quality] in the [Video] ([Image Format]) menu.
    - [Down Convert] in [HDMI Rec Output] of the [Custom] ([IN/OUT]) menu.
  - Anamorphic (4:3) video is output with a 4K or FHD resolution.
  - For details, refer to “Image Quality When Outputting via HDMI”. (➔ [135 / Image Quality When Outputting via HDMI](#))
- When set to a 4:3 [Rec Quality], bands are added to the images and they are output with a 16:9 aspect ratio.
- Output may be in 8-bit if you output to devices that do not support 10-bit.

### Notice Regarding HDMI Output

- It may take some time for the output method to change.
- When you use the HDMI output during recording, the image may be displayed with a time lag.
- When you check the image and audio from the external device connected to the camera, the microphone of the camera may pick up the sound from the speakers of the external device, producing an abnormal sound (audio feedback). If this occurs, move the camera away from the external device or lower the volume on the external device.

# HDMI Output Image Quality (Resolution / Frame Rate)

## Settings for Down-Converting

Make settings for the down-conversion of resolution and frame rate for HDMI output.

[MENU/SET] → [⚙️] → [📺] → [HDMI Rec Output] → Select [Down Convert]

[AUTO]	Outputs by down-converting to match the connected device.
[4K/30p] ([4K/25p])	Outputs by down-converting resolution to 4K and frame rate to either 29.97p or 25.00p.
[1080p]	Down-converts resolution to FHD (1080), and outputs as progressive.
[1080i]	Down-converts resolution to FHD (1080), and outputs as interlaced.
[OFF]	Outputs at the resolution and recording frame rate of the [Rec Quality].

- The items you can select depend on the [System Frequency] setting.
- Anamorphic (4:3) video is output with a 4K or FHD resolution.
- If down-converting, AF may take longer than usual for focusing, and the performance of continuous focus tracking may deteriorate.

## Image Quality When Outputting via HDMI

Output is with the resolution and frame rate according to the combinations of the [Rec Quality] and [Down Convert] settings.

- When [Down Convert] is set to [AUTO], the output matches the connected device.
- There is no HDMI output when setting combinations result in a [—] in the below tables.

### ■ [System Frequency]: [59.94Hz (NTSC)]

[Down Convert]	Resolution and recording frame rate of the [Rec Quality]		
	4K-A/59.94p 4K/59.94p	4K-A/29.97p 4K/29.97p	4K-A/23.98p 4K/23.98p
[4K/30p]	4K/29.97p	4K/29.97p	—
[1080p]	1080/59.94p	1080/29.97p* <sup>1</sup>	1080/23.98p
[1080i]	1080/59.94i	1080/59.94i	—
[OFF]	4K/59.94p	4K/29.97p	4K/23.98p

\*<sup>1</sup> Output is 1080/59.94p if the connected device is not compatible.

[Down Convert]	Resolution and recording frame rate of the [Rec Quality]		
	C4K/59.94p	C4K/29.97p	C4K/23.98p
[4K/30p]	4K/29.97p	4K/29.97p	—
[1080p]	1080/59.94p	1080/29.97p* <sup>1</sup>	1080/23.98p
[1080i]	1080/59.94i	1080/59.94i	—
[OFF]	C4K/59.94p	C4K/29.97p	C4K/23.98p

\*<sup>1</sup> Output is 1080/59.94p if the connected device is not compatible.

[Down Convert]	Resolution and recording frame rate of the [Rec Quality]		
	1080/59.94p	1080/29.97p	1080/23.98p
[4K/30p]	—	—	—
[1080p]	1080/59.94p	1080/29.97p* <sup>1</sup>	1080/23.98p
[1080i]	1080/59.94i	1080/59.94i	—
[OFF]	1080/59.94p	1080/29.97p	1080/23.98p

\*<sup>1</sup> Output is 1080/59.94p if the connected device is not compatible.

## ■ [System Frequency]: [50.00Hz (PAL)]

[Down Convert]	Resolution and recording frame rate of the [Rec Quality]			
	4K-A/50.00p 4K/50.00p	4K-A/25.00p 4K/25.00p	C4K/50.00p	C4K/25.00p
[4K/25p]	4K/25.00p	4K/25.00p	4K/25.00p	4K/25.00p
[1080p]	1080/50.00p	1080/25.00p* <sup>2</sup>	1080/50.00p	1080/25.00p* <sup>2</sup>
[1080i]	1080/50.00i	1080/50.00i	1080/50.00i	1080/50.00i
[OFF]	4K/50.00p	4K/25.00p	C4K/50.00p	C4K/25.00p

\*<sup>2</sup> Output is 1080/50.00p if the connected device is not compatible.

[Down Convert]	Resolution and recording frame rate of the [Rec Quality]	
	1080/50.00p	1080/25.00p
[4K/25p]	—	—
[1080p]	1080/50.00p	1080/25.00p* <sup>2</sup>
[1080i]	1080/50.00i	1080/50.00i
[OFF]	1080/50.00p	1080/25.00p

\*<sup>2</sup> Output is 1080/50.00p if the connected device is not compatible.

## ■ [System Frequency]: [24.00Hz (CINEMA)]

[Down Convert]	Resolution and recording frame rate of the [Rec Quality]		
	4K-A/24.00p 4K/24.00p	C4K/24.00p	1080/24.00p
[1080p]	1080/24.00p	1080/24.00p	1080/24.00p
[OFF]	4K/24.00p	C4K/24.00p	1080/24.00p



# HDMI Output Settings

## Outputting Control Information to an External Recorder

Recording start and stop control information is output to an external recorder connected by HDMI.

[MENU/SET] → [⚙️] → [📡] → [HDMI Rec Output] → Select [HDMI Recording Control]

Settings: [ON] / [OFF]

- It can be set when [HDMI Time Code Output] is [ON].
- Control information is output when pressing the video rec. button, even if the video cannot be recorded (such as when there is no card inserted into the camera).
- Only compatible external devices can be controlled.

## Outputting Down-converted Audio to an HDMI Device

When an XLR Microphone Adaptor (DMW-XLR1: optional) is attached, audio is down-converted to a format suitable for the connected HDMI external device before being output.

[MENU/SET] → [⚙️] → [📡] → [HDMI Rec Output] → Select [Sound Down Convert]

<b>[AUTO]</b>	Output is down-converted to match the connected device.
<b>[OFF]</b>	Output is according to the settings in [XLR Mic Adaptor Setting].

## Outputting Audio via HDMI

Output audio to an external device connected by HDMI.

[MENU/SET] → [⚙️] → [📡] → [HDMI Rec Output] → Select [Sound Output (HDMI)]

Settings: [ON] / [OFF]

## Output the enlarged display of MF assist via HDMI

This outputs the enlarged display of MF assist to the external device connected via HDMI.

[MENU/SET] → [⚙️] → [📡] → [HDMI Rec Output] → Select [HDMI MF Assist Output]

Settings: [ON] / [OFF]

- When [HDMI MF Assist Output] is set to [OFF] and is in enlarged display with MF assist, the camera information display will not be output via HDMI.

# SDI output settings

## Set the resolution during recording when output via SDI

Set the resolution of the image to be output via SDI.

[MENU/SET] → [⚙️] → [📡] → [SDI Rec Output] → Select [SDI Output Resolution]

Settings: [1080p] / [1080i] / [1080PsF] / [720p]

### ■ Settings Items ([SDI Output Resolution])

Output is with the resolution and frame rate according to the combinations of the [Rec Quality] and [SDI Output Resolution] settings.

The items that can be set at [SDI Output Resolution] differs depending on the recording frame rate of the [Rec Quality].

#### [System Frequency]: [59.94Hz (NTSC)]

[SDI Output Resolution]	Recording frame rate of the [Rec Quality]		
	59.94p	29.97p	23.98p
1080p	1080/59.94p	1080/29.97p	1080/23.98p
1080i	1080/59.94i	—	—
1080PsF	—	1080/29.97PsF	1080/23.98PsF
720p	720/59.94p	—	—

#### [System Frequency]: [50.00Hz (PAL)]

[SDI Output Resolution]	Recording frame rate of the [Rec Quality]	
	50.00p	25.00p
1080p	1080/50.00p	1080/25.00p
1080i	1080/50.00i	—
1080PsF	—	1080/25.00PsF
720p	720/50.00p	—

#### [System Frequency]: [24.00Hz (CINEMA)]

[SDI Output Resolution]	Recording frame rate of the [Rec Quality]
	24.00p
1080p	—
1080i	—
1080PsF	1080/24.00PsF
720p	—

- This memorizes the setting value for each recording frame rate of [Rec Quality].
- When [System Frequency] is set to [24.00Hz (CINEMA)], it is fixed to [1080PsF].

## Output control information to the external recorder

Outputs record starting and stopping control information to the external recorder connected with SDI.

[MENU/SET] → [⚙️] → [📡] → [SDI Rec Output] → Select [SDI Recording Control]  
Settings: [ON] / [OFF]

- It can be set when [SDI Time Code Output] is [ON].
- Control information is output when pressing the video rec. button, even if the video cannot be recorded (such as when there is no card inserted into the camera).
- Only compatible external devices can be controlled.

## Output audio via SDI

Outputs audio to external devices connected via SDI.

[MENU/SET] → [⚙️] → [📡] → [SDI Rec Output] → Select [Sound Output (SDI)]  
Settings: [ON] / [OFF]

- High resolution audio cannot be output when output via SDI. When [Sound Output (SDI)] is set to [ON], [96kHz/24bit] of [XLR Mic Adaptor Setting] cannot be used.

## Set the gain of the audio signal that is output via SDI

Sets the audio signal's gain that is output to the SDI connected external device.

[MENU/SET] → [⚙️] → [📡] → [SDI Rec Output] → Select [SDI Sound Output Gain Adj.]  
Settings: [0dB] / [-6dB] / [-8dB]

## Output the enlarged display of MF assist via SDI

Outputs the enlarged display of MF assist to an external device connected via SDI.

[MENU/SET] → [⚙️] → [📡] → [SDI Rec Output] → Select [SDI MF Assist Output]  
Settings: [ON] / [OFF]

- When the [SDI MF Assist Output] is set to [OFF] and it is in enlarged display with MF assist, the camera's information display will not be output via SDI.

# 8. Connections with External Devices

In this chapter, external devices connected to this unit are explained.

- Some optional accessories may not be available in some countries.
- For information about connection methods of external monitor (➔ 27 / [Connecting the external monitor](#))

## External Microphones (Optional)

With a Stereo Shotgun Microphone (DMW-MS2: optional) or Stereo Microphone (VW-VMS10: optional), you can record higher-quality audio compared to the built-in microphone.

### 1 Set the [Mic Socket] that suits the device to be connected.

- [MENU/SET] ➔ [ ] ➔ [ ] ➔ [Mic Socket]

<b>MIC</b>	<b>[Mic Input (Plug-in Power)]</b>	When connecting an external microphone that requires a power supply from the camera [MIC] terminal.
<b>MIC</b>	<b>[Mic Input]</b>	When connecting an external microphone that does not require a power supply from the camera [MIC] terminal.
<b>LINE</b>	<b>[Line Input]</b>	When connecting an external audio device for line output.

- The setting will be fixed to **[MIC]** when a Stereo Shotgun Microphone (DMW-MS2: optional) is connected.
- When using **[MIC]**, if you connect an external microphone that does not require power supply, the connected external microphone may malfunction. Check the device before connecting.

### 2 Turn the camera off.

- Press and hold the camera ON/OFF button for more than two seconds.

### 3 Connect the camera and external microphone.

- If mounting the external microphone on the camera hot shoe, remove the hot shoe cover.

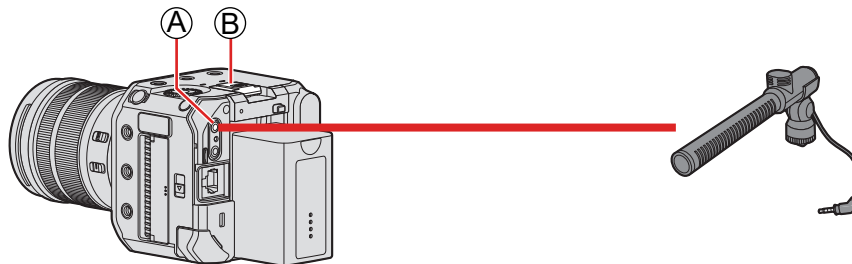

- Ⓐ [MIC] terminal
- Ⓑ Hot shoe

- Do not use the Stereo microphone cables with the length of 3 m (9.8 feet) or more.

### ■ Removing the Hot Shoe Cover

Remove the hot shoe cover by pulling it in the direction of arrow ② while pressing it in the direction of arrow ①.

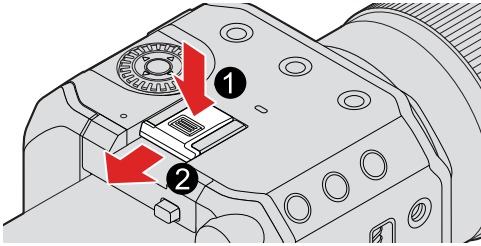

### Setting the Sound Pickup Range (DMW-MS2: Optional)

When using the Stereo Shotgun Microphone (DMW-MS2: optional), you can set the microphone sound pickup range.

#### ① Select [Special Mic.].

- [MENU/SET] → [Microphone Icon] → [Microphone Icon] → [Special Mic.]

[STEREO]	Picks up sound over a wide area.
[LENS AUTO]	Picks up sound from a range automatically set by the lens angle of view.
[SHOTGUN]	Helps prevent picking up background noise, and records sound from a specific direction.
[S.SHOTGUN]	Narrows the sound pickup range more than with [SHOTGUN].
[MANUAL]	Sets the range manually for sound pickup.

#### ② (When [MANUAL] is selected)

Press ◀▶ to adjust the sound pickup range and then press [MENU/SET].

- You can register the [MANUAL] sound pickup range setting in a Fn button:  
[Settings Icon] → [Microphone Icon] → [Fn Button Set] → [Setting in REC mode] → [Special Mic. Directivity Adjust] (→ [155 / Register Functions to the Fn Buttons](#))

### Reduction of Wind Noise

This reduces wind noise when an external microphone is connected.

[MENU/SET] → [Microphone Icon] → [Microphone Icon] → Select [Wind Cut]

Settings: [HIGH] / [STANDARD] / [LOW] / [OFF]

- While the external microphone is connected, [EXT.] is displayed on the screen.
- When an external microphone is connected, [Sound Rec Level Disp.] automatically turns [ON], and the recording level is displayed on the screen.
- When the external microphone is attached, do not carry the camera by holding the external microphone. It may become detached.
- If noises are recorded when using the AC adaptor, use the battery.
- Setting [Wind Cut] may alter the usual sound quality.
- For details, refer to the operating instructions for the external microphone.

# XLR Microphone Adaptor (Optional)

By attaching an XLR Microphone Adaptor (DMW-XLR1: optional) to the camera, you can use a commercially available XLR microphone to enable the recording of superior-quality high-res/stereo audio.

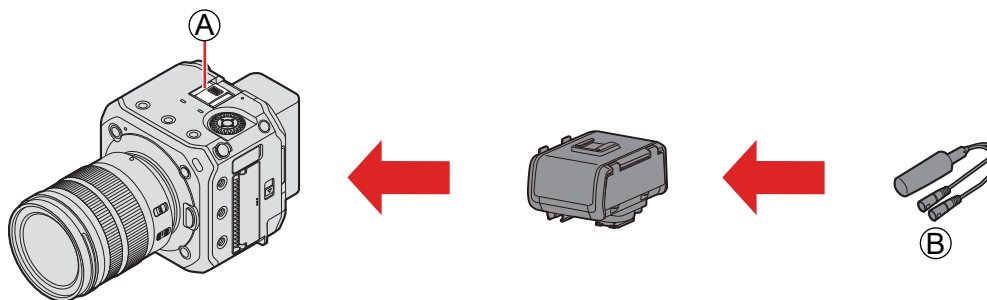

Ⓐ Hot shoe

Ⓑ Commercially available XLR microphone

Preparation:

- Turn off the camera, and remove the hot shoe cover. (➔ [141 / Removing the Hot Shoe Cover](#))

## 1 Attach the XLR Microphone Adaptor to the hot shoe.

## 2 Turn the camera on.

- Press and hold the camera ON/OFF button for more than one second.

## 3 Select [XLR Mic Adaptor Setting].

- [MENU/SET] ➔ [👤] ➔ [🎤] ➔ [XLR Mic Adaptor Setting]

[96kHz/24bit]	Records high resolution audio at 96 kHz/24-bit. <ul style="list-style-type: none"> <li>• Only available when [Rec. File Format] is set to [MOV].</li> <li>• [Sound Output (SDI)] is set to [OFF].</li> </ul>
[48kHz/24bit]	Records high-quality audio at 48 kHz/24-bit. <ul style="list-style-type: none"> <li>• Only available when [Rec. File Format] is set to [MOV].</li> </ul>
[48kHz/16bit]	Records standard-quality audio at 48 kHz/16-bit.
[OFF]	Records audio using the built-in microphone of the camera.

- While an XLR Microphone Adaptor is attached, [XLR] is displayed on the screen.
- When [XLR Mic Adaptor Setting] is set to other than [OFF], the following settings are fixed:
  - [Sound Rec Level Limiter]: [OFF]
  - [Wind Noise Canceller]: [OFF]
  - [Sound Output]: [Recorded Sound]
- [Sound Rec Gain Level] and [Sound Rec Level Adj.] cannot be used when [XLR Mic Adaptor Setting] is set to other than [OFF].
- When the XLR Microphone Adaptor is attached, [Sound Rec Level Disp.] automatically turns [ON], and the recording level is displayed on the screen.
- When the XLR Microphone Adaptor is attached, do not carry the camera by holding the XLR Microphone Adaptor. It may become detached.
- If noises are recorded when using the AC adaptor, use the battery.
- For details, refer to the operating instructions for the XLR Microphone Adaptor.

# Headphones

You can record videos while monitoring their sound by connecting commercially available headphones to the camera.



Ⓐ Headphone terminal

- Do not use the Headphone cables with the length of 3 m (9.8 feet) or more.
- Excessive sound pressure from earphones and headphones can cause hearing loss.

## Switching the Sound Output Method

[MENU/SET] → [ ] → [ ] → Select [Sound Output]

[REALTIME]	Audio without time lag. It may differ from the sound recorded in videos.
[REC SOUND]	Audio to be recorded in videos. Output sound may be delayed from actual sound.

- The setting is fixed to [REC SOUND] in the following cases:
  - When [Special Mic.] is set to [LENS AUTO], [SHOTGUN], [S.SHOTGUN], or [MANUAL]
  - When using an XLR Microphone Adaptor (DMW-XLR1: optional)

## Adjusting the Headphone Volume

Connect the headphones and rotate .

 : Reduces the volume.

 : Increases the volume.

### ■ To adjust the volume using the menu

#### ① Select [Headphone Volume].

- [MENU/SET] → [ ] → [ ] → [Headphone Volume]

#### ② Press ▲▼ to adjust the headphone volume and then press [MENU/SET].

- It can be adjusted in a range of [0] to [LEVEL15].



## Using a remote control unit

You can control a part of the function remotely by connecting the remote control unit (commercially available) to the camera. It can be used in the following ways. (The operations that can be performed vary depending on the remote control unit used.)

- Starting / stopping the recording
- Aperture adjustment
- Manual focus operation
- Zoom operation (Power zoom lens)



Ⓐ [REMOTE] terminal

- A Panasonic shutter remote control (DMW-RS2) cannot be used.
- It may not operate properly depending on the combination of the remote control unit and lens.

# Importing Images to a PC

After connecting to the PC, you can copy the recorded images by dragging files and folders on this camera to the PC.

The camera can be connected to a PC running any of the following OSs which can detect mass storage devices.

## Supported OS

Windows: Windows 10

Mac: OS X v10.11, macOS 10.12 to macOS 10.15

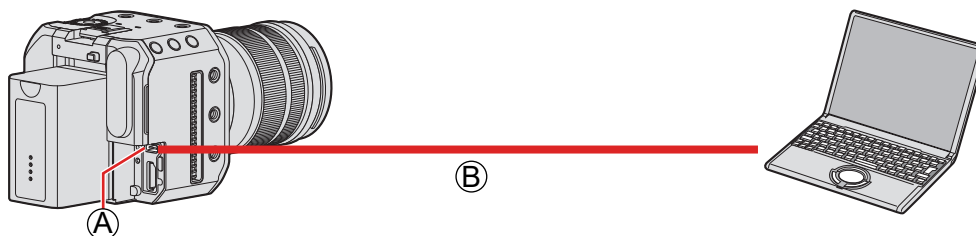

Ⓐ [USB] terminal

Ⓑ USB connection cable (commercially available)

- Plug in/out straight holding onto the plug. (Inserting these at an angle may cause deformation or malfunction)
- Do not connect the cable to the wrong terminals. This may cause a malfunction.

Preparation:

- Turn on the camera and PC.

## 1 Set [USB Mode] to [PC(Storage)].

- [MENU/SET] → [ ] → [ ] → [USB Mode] → [PC(Storage)]

## 2 Connect the camera and PC with the USB connection cable.

- Windows: A drive ("LUMIX") is displayed in [This PC].
- Mac: A drive ("LUMIX") is displayed on the desktop.

## 3 Drag the files and folders from the camera to the PC.

### Folder Structure Inside Card

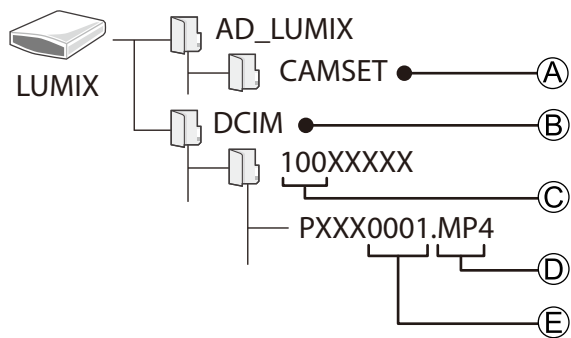

- Ⓐ The camera's setup information
- Ⓑ Images
- Ⓒ Folder number
- Ⓓ MP4: MP4 videos  
MOV: MOV videos  
JPG: JPEG format pictures
- Ⓔ File number

- For the USB connection cable, use one that is a shielded product with a ferrite core compliant to USB Type C (USB3.1) that is less than 1.5 m (4.9 feet).
- Turn off the camera and disconnect the USB connection cable before removing the card from the camera. Otherwise, the recorded data may be damaged.
- The camera image cannot be output to an external device via HDMI/SDI when [USB Mode] is set to [PC(Storage)] and the camera is connected to the PC with a USB connection cable.

# 9. Playback

This chapter explains how to playback and delete videos.

- Connect the camera to the external device and output the image. (➔ 27 / [Connecting the external monitor](#))
- You can set the output resolution during playback. (➔ 195 / [\[Output Resolution\(Playback\)\]](#))
- Images recorded on devices other than this one may not be played back correctly on this camera.

## Playing Back Videos

### 1 Display the playback screen.

- Press [▶].

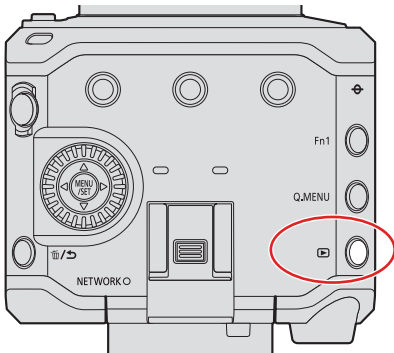

### 2 Select a video.

- Select the image by pressing ◀▶.
- You can move continuously through images by pressing and holding ◀▶.



- Ⓐ Card slot
- Ⓑ Video recording time

### 3 Playback the video.

- Press ▲.



C

D

© Elapsed playback time

ⓓ Playback bar

### 4 Stop playback.

- Press ▼.

#### ■ Operations During Video Playback

Button operation	Description of operation
▲	Plays / pauses.
▼	Stops.
◀	Performs fast-rewind playback. <ul style="list-style-type: none"> <li>• If you press ◀ again, the fast-rewind speed increases.</li> </ul>
	Performs frame-by-frame rewinding (while paused).
▶	Performs fast-forward playback. <ul style="list-style-type: none"> <li>• If you press ▶ again, the fast-forward speed increases.</li> </ul>
	Performs frame-by-frame forwarding (while paused).

#### ■ Adjusting volume

Adjust the volume on the connected external device.

- To check the sound with headphones (commercially available), connect the headphones to the connected external device. (While outputting to an external device, audio is not output from the headphone terminal.)

## Switching the Card to Display

Images are displayed separately by card slot. When you press [Q.MENU] during playback you can switch the card that will be displayed.

- Use the Fn button registered with [Card Slot Change] to operate. In default settings, this is registered in [Q.MENU].
  - About Fn buttons (➔ [154 / Fn Buttons](#))

### ① Press [Q.MENU].

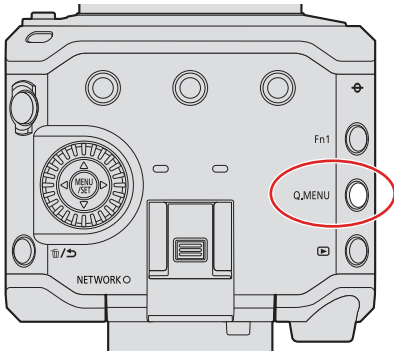

### ② Press ▲▼ to select [Card Slot 1] or [Card Slot 2] and then press [MENU/SET].



- The camera can playback videos in MP4 and MOV formats.
- Video recorded with a [System Frequency] setting that is different to the current one cannot be played back.
- When it is output via HDMI and SDI at the same time, it can be output with the same resolution. When [SDI Output] is set to [ON] at [HDMI / SDI Connections] of the [Setup] ([IN/OUT]) menu, output with a resolution above 4K is not possible. When playing back an image at a resolution above 4K, set the [SDI Output] to [OFF].
- High resolution audio cannot be output during SDI output.
  - When output only via SDI: It is down converted to [48kHz/24bit].
  - When output via SDI and HDMI at the same time: It is down converted to [48kHz/24bit] or [48kHz/16bit] depending on the capabilities of the HDMI connection device.
- Depending on the aspect ratio, gray bands may be displayed on the top and bottom or the left and right of images. You can change the band color in [Background Color(Playback)] in [HDMI / SDI Connections] of the [Setup] ([IN/OUT]) menu. (➔ [195 / \[Background Color\(Playback\)\]](#))
- Change the settings of your external device if images are displayed with the top or bottom cut off.
- Also refer to the operating instructions for the external device.

# Switching the Display Mode

This switches to thumbnail display (Multi playback), which displays several images at the same time.

## Thumbnail Display



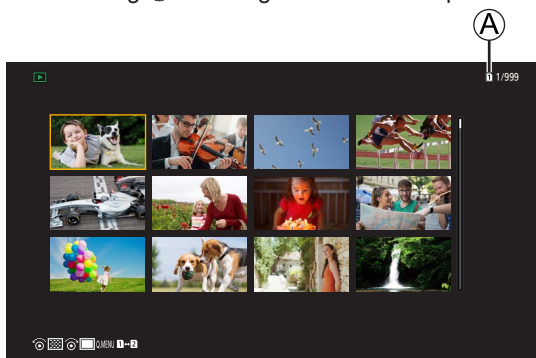

### 1 Switch to thumbnail display.

- Rotate  to the left.
- The display is switched in the order of 12-image screen ⇨ 30-image screen.
- Rotating  to the right returns to the previous display.



Ⓐ Card slot

### 2 Select an image.

- Press     to select an image and then press [MENU/SET].
- Images indicated with [!] cannot be played back.

## Group Images

Images recorded using [Segmented File Recording] are handled as group images in the camera, and can be deleted and edited on a group basis.

You can also delete and edit each image in a group individually.

### Playing the Images in a Group One by One

Operations such as displaying thumbnails and deleting images are available with images in groups just as with normal playback.

- 1 Select the group image in the playback state. (→ [148 / Playing Back Videos](#))



- 2 Press ▼ to display the images in the group.
- 3 Press ◀▶ to select an image.
  - To return to the normal playback screen, press ▼ again.



# Deleting Images

- Images cannot be restored once they have been deleted. Carefully confirm the images before deletion.
- You can only delete the images in the card of the selected card slot.
- If you delete a group image, all images in the group are deleted.





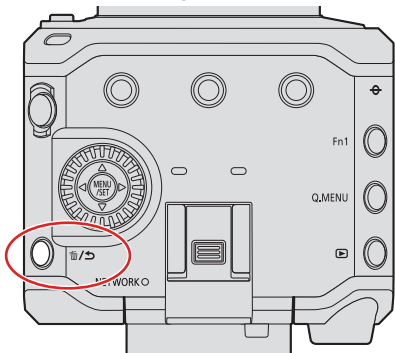



## [Delete Single]

- 1 Press  in playback state.





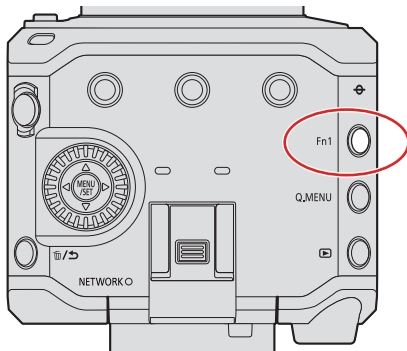

- 2 Press   to select [Delete Single] and then press [MENU/SET].

## [Delete Multi]

- 1 Press  in playback state.
- 2 Press   to select [Delete Multi] and then press [MENU/SET].
  - 1 Press     to select the image to delete and then press [MENU/SET].
    -  is displayed for the selected image.
    - If you press [MENU/SET] again, the selection is canceled.
    - Up to 100 images can be selected.
  - 2 Press [Fn1] to delete the selected image.



- To switch the card selected for deleting images, press [Q.MENU] and then select the card slot.
- You can delete all images in the card or all images not set with a rating:

    [Delete All Images]  202 / [Delete All Images]

# 10. Camera Customization

This chapter describes the customization function with which you can configure the camera to your preferred settings.

- Detailed settings for camera operations and screen display are available in the [Custom] menu. (➔ 185 / [Custom] menu)

## Fn Buttons

You can register functions to the Fn (Function) buttons. Additionally, you can register other functions to [⏏/⏪] and [Q.MENU] in the same way as with the Fn buttons.

Different functions can be set for both during recording and playback.

### Fn Button Default Settings

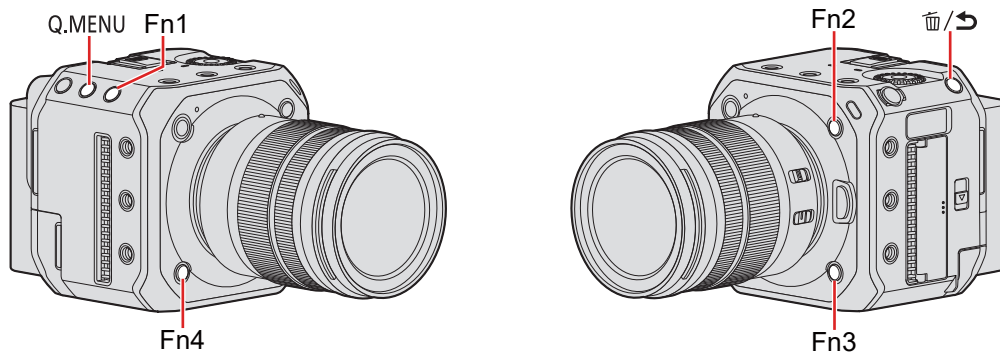

Fn buttons	[Setting in REC mode]	[Setting in PLAY mode]
[Fn1]	[Info Display (HDMI/SDI)]	[Info Display (HDMI/SDI)]
[⏏/⏪]	[Shutter Speed]	—
[Q.MENU]	[Q.MENU]	[Card Slot Change]
[Fn2]	[Aperture Value]	[Rating★3]
[Fn3]	[Sensitivity]	[No Setting]
[Fn4]	[White Balance]	[No Setting]

# Register Functions to the Fn Buttons

## 1 Select [Fn Button Set].

- [MENU/SET] → [Settings] → [Fn Button Set] → [Setting in REC mode] / [Setting in PLAY mode]

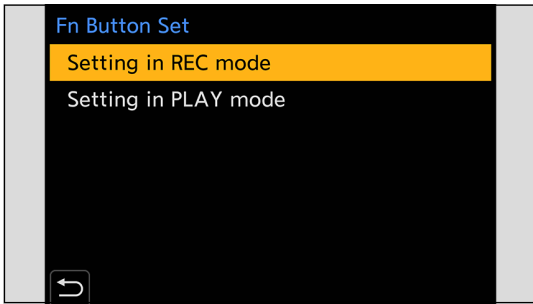

## 2 Select the button.

- Press ▲▼ to select the button and then press [MENU/SET].
- Selection is also possible by rotating ⚙.

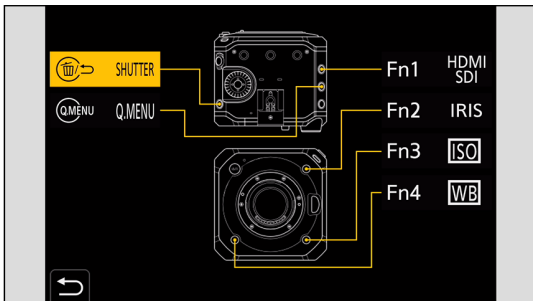

## 3 Find the function to register.

- You can select by pressing ◀ to select the sub tab, pressing ▲▼ or rotating ⚙, and then pressing ▶.
- Each press [Q.MENU] switches between tabs [1] and [2].



## 4 Register the function.

- Press ▲▼ to select a function and then press [MENU/SET].
- Selection is also possible by rotating ⚙.
- Select items with [➤] by selecting the item again.
- Depending on the button, some functions cannot be registered.

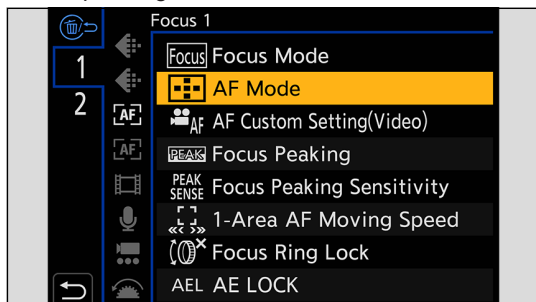

- You can also press and hold the Fn button (2 sec.) to display the screen in Step 4. (This may not be displayed depending on the registered function and on the button type.)

## Setting Items ([Fn Button Set] / [Setting in REC mode])

### ■ [1] tab

#### [Image Quality]

- [Exposure Mode] (➔ 53 / [Exposure Mode])
- [Aperture Value] (➔ 53 / [Exposure Mode])
- [Shutter Speed] (➔ 53 / [Exposure Mode])
- [Exposure Comp.] (➔ 86 / [Exposure Compensation])
- [Dual Native ISO Setting] (➔ 90 / [Dual Native ISO Setting])
- [Sensitivity] (➔ 88 / [ISO Sensitivity])
- [White Balance] (➔ 91 / [White Balance (WB)])
- [Photo Style] (➔ 96 / [Photo Style])
- [Metering Mode] (➔ 85 / [Metering Mode])
- [i.Dynamic Range] (➔ 178 / [i.Dynamic Range])
- [Filter Effect] (➔ 101 / [Filter Settings])
- [One Push AE]
  - Adjusts the aperture value and shutter speed to the settings suited for the correct exposure determined by the camera.
- [Synchro Scan] (➔ 126 / [Synchro Scan])

#### [Focus]

- [Focus Mode] (➔ 70 / [Selecting the Focus Mode])
- [AF Mode] (➔ 73 / [Selecting the AF Mode])
- [AF Custom Setting(Video)] (➔ 78 / [AF Custom Setting(Video)])
- [Focus Peaking] (➔ 181 / [Focus Peaking])
- [Focus Peaking Sensitivity] (➔ 181 / [Focus Peaking Sensitivity])
- [1-Area AF Moving Speed] (➔ 181 / [1-Area AF Moving Speed])
- [Focus Ring Lock] (➔ 187 / [Focus Ring Lock])
- [AE LOCK] (➔ 87 / [Locking Focus and Exposure (AF/AE Lock)])
- [AF LOCK] (➔ 87 / [Locking Focus and Exposure (AF/AE Lock)])
- [AF/AE LOCK] (➔ 87 / [Locking Focus and Exposure (AF/AE Lock)])
- [AF-ON]
  - AF works.
- [AF-ON : Near Shift]
  - AF operates giving priority to close-up subjects.
- [AF-ON : Far Shift]
  - AF operates giving priority to distant subjects.
- [Focus Area Set]
  - Displays the AF area/MF Assist transition screen.

#### [Image Format]

- [Rec. File Format] (➔ 55 / [Rec. File Format])
- [Rec Quality] (➔ 56 / [Rec Quality])
- [Rec Quality (My List)] (➔ 60 / [add to list])
- [Variable Frame Rate] (➔ 112 / [Variable Frame Rate])
- [Time Code Display] (➔ 63 / [Time Code Display])

#### [Audio]

- [Sound Rec Level Disp.] (➔ 105 / [Sound Rec Level Disp.])
- [Mute Sound Input] (➔ 105 / [Mute Sound Input])
- [Sound Rec Level Adj.] (➔ 106 / [Sound Rec Level Adj.])
- [Sound Rec Level Limiter] (➔ 106 / [Sound Rec Level Limiter])
- [XLR Mic Adaptor Setting] (➔ 142 / [XLR Microphone Adaptor (Optional)])
- [Special Mic. Directivity Adjust] (➔ 141 / [Setting the Sound Pickup Range (DMW-MS2: Optional)])

 [Others (Video)]

- [Image Stabilizer] (➔ 107 / [Image Stabilizer])
- [E-Stabilization (Video)] (➔ 107 / [E-Stabilization (Video)])
- [Image Area of Video] (➔ 61 / [Image Area of Video])
- [Digital Zoom] (➔ 84 / [Digital Zoom])
- [Focus Transition] (➔ 114 / [Focus Transition])
- [Live Cropping] (➔ 117 / [Live Cropping])

 [Operation]

- [Q.MENU] (➔ 44 / Quick Menu)
- [Rec / Playback Switch]
  - Switches to the playback screen.
- [Video Record] (➔ 51 / Recording Videos)
- [Cursor Button Lock]
  - Disables the operation of cursor buttons and [MENU/SET]. Pressing the Fn button assigned with [Cursor Button Lock] again will release the lock.
- [Display Information] (➔ 42 / Switch the information display with a Fn button, ➔ 49 / Displaying Descriptions About Menu Items and Settings)

## ■ [2] tab

 [Monitor / Display]

- [Level Gauge] (➔ 189 / [Level Gauge])
- [Histogram] (➔ 188 / [Histogram])
- [Luminance Spot Meter] (➔ 189 / [Luminance Spot Meter])
- [Frame Marker] (➔ 111 / [Frame Marker])
- [Zebra Pattern] (➔ 110 / [Zebra Pattern])
- [LUT View Assist (HDMI)] (➔ 121 / [LUT View Assist (HDMI)])
- [LUT View Assist (SDI)] (➔ 121 / [LUT View Assist (SDI)])
- [LUT Select] (➔ 121 / [LUT Select])
- [HLG View Assist (HDMI)] (➔ 123 / [HLG View Assist])
- [HLG View Assist (SDI)] (➔ 123 / [HLG View Assist])
- [Anamorphic Desqueeze Display] (➔ 125 / [Anamorphic Desqueeze Display])
- [Color Bars] (➔ 111 / Color bars / Test Tone)

 [Lens / Others]

- [Zoom Control]
  - You can operate zoom when using an interchangeable lens that supports the power zoom.
- [Step Zoom] (➔ 84 / [Step Zoom])

 [Card/File]

- [Destination Card Slot]
  - Changes the priority of cards for recording. This can be used if [Double Card Slot Function] (➔ 34 / [Double Card Slot Function]) is set to [Relay Rec].

 [IN/OUT]

- [LAN / Wi-Fi] (➔ 194 / [LAN / Wi-Fi])
- [Info Display (HDMI/SDI)] (➔ 39 / Information Display (HDMI/SDI))
- [Fan Mode] (➔ 192 / [Fan Mode])

 [Others]

- [No Setting]
  - Set when not using as a Fn button.
- [Off (Disable Press and Hold)]
  - This sets the registration screen of the function to not be displayed even when you long press the Fn button.
- [Restore to Default]
  - Restore the default settings for the Fn button. (➔ 154 / Fn Button Default Settings)

## Setting Items ([Fn Button Set] / [Setting in PLAY mode])

### ■ [1] tab

#### [Playback Mode]

- [Anamorphic Desqueeze Display] (➔ 125 / [\[Anamorphic Desqueeze Display\]](#))

#### [Add/Delete Info.]

- [Delete Single] (➔ 153 / [\[Delete Single\]](#))
- [Protect] (➔ 200 / [\[Protect\]](#))
- [Rating★1] (➔ 200 / [\[Rating\]](#))
- [Rating★2] (➔ 200 / [\[Rating\]](#))
- [Rating★3] (➔ 200 / [\[Rating\]](#))
- [Rating★4] (➔ 200 / [\[Rating\]](#))
- [Rating★5] (➔ 200 / [\[Rating\]](#))

#### [Edit Image]

- [Copy] (➔ 201 / [\[Copy\]](#))

#### [Operation]

- [Rec / Playback Switch]
  - Switches to the recording screen.
- [Video Record] (➔ 51 / [Recording Videos](#))
- [Display Information] (➔ 42 / [Switch the information display with a Fn button](#), ➔ 49 / [Displaying Descriptions About Menu Items and Settings](#))

#### [Card/File]

- [Card Slot Change] (➔ 150 / [Switching the Card to Display](#))

#### [IN/OUT]

- [LAN / Wi-Fi] (➔ 194 / [\[LAN / Wi-Fi\]](#))
- [Info Display (HDMI/SDI)] (➔ 39 / [Information Display \(HDMI/SDI\)](#))
- [Fan Mode] (➔ 192 / [\[Fan Mode\]](#))
- [LUT View Assist (HDMI)] (➔ 121 / [\[LUT View Assist \(HDMI\)\]](#))
- [LUT View Assist (SDI)] (➔ 121 / [\[LUT View Assist \(SDI\)\]](#))
- [HLG View Assist (HDMI)] (➔ 123 / [\[HLG View Assist\]](#))
- [HLG View Assist (SDI)] (➔ 123 / [\[HLG View Assist\]](#))

#### [Others]

- [No Setting]
  - Set when not using as a Fn button.
- [Off (Disable Press and Hold)]
  - This sets the registration screen of the function to not be displayed even when you long press the Fn button.
- [Restore to Default]
  - Restore the default settings for the Fn button. (➔ 154 / [Fn Button Default Settings](#))

## Use the Fn Buttons

During recording, pressing the Fn buttons enables usage of the functions registered in [Setting in REC mode], and during playback, it enables usage of the functions registered in [Setting in PLAY mode].

### 1 Press the Fn button.

### 2 Select a setting item.

- Press ◀▶ to select a setting item and then press [MENU/SET].
- Selection is also possible by rotating ⚙.
- Display and selection methods of a setting item differ depending on the menu item.

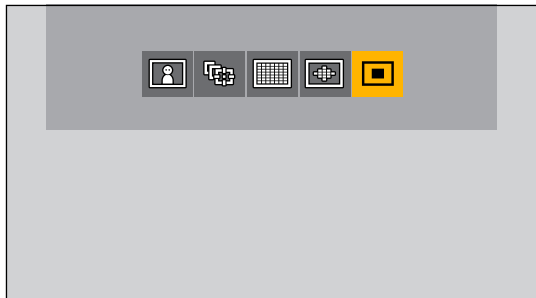



# Quick Menu Customization

You can change the items to display on the Quick menu and their order to suit your preferences.

- For information about Quick menu operation methods (➔ 44 / [Quick Menu](#))

## Register to the Quick Menu

Change the menus to be displayed in the Quick menu.

### 1 Select [Q.MENU Settings].

- [MENU/SET] ➔ [⚙️] ➔ [📷] ➔ [Q.MENU Settings] ➔ [Item Customize (Video)]

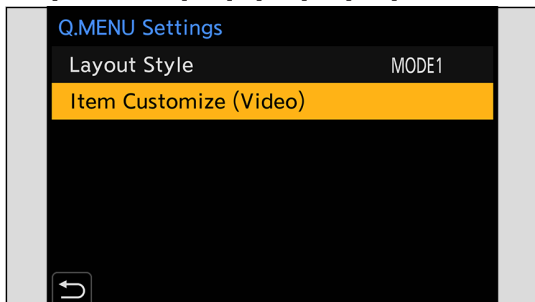

### 2 Select the item position (① to ⑫).

- Press ▲▼◀▶ to select the position and then press [MENU/SET].

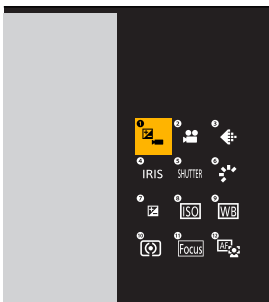

### 3 Find the function to register.

- You can select by pressing ◀ to select the sub tab, pressing ▲▼ or rotating ⚙️, and then pressing ▶.
- Each press of [Q.MENU] switches between tabs [1] and [2].

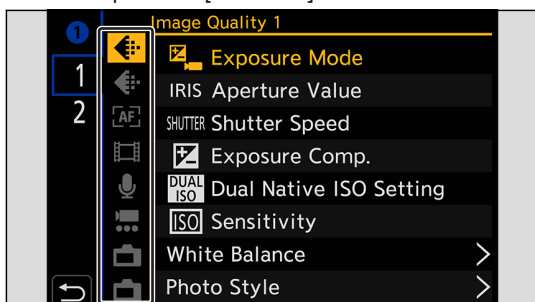

## 4 Register menu items.

- Press ▲▼ to select an item and then press [MENU/SET].
- Selection is also possible by rotating ⚙.
- Select items with [➤] by selecting the item again.

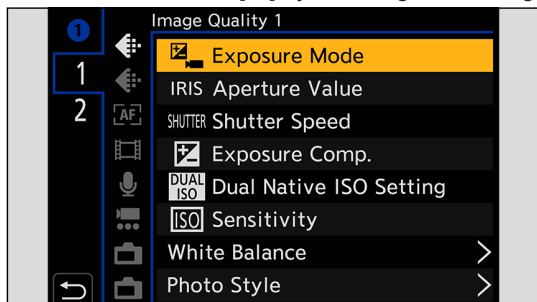

## Menu Items That Can Be Registered

### ■ [1] tab

#### [Image Quality]

- [Exposure Mode] (➔ 53 / [Exposure Mode])
- [Aperture Value] (➔ 53 / [Exposure Mode])
- [Shutter Speed] (➔ 53 / [Exposure Mode])
- [Exposure Comp.] (➔ 86 / Exposure Compensation)
- [Dual Native ISO Setting] (➔ 90 / [Dual Native ISO Setting])
- [Sensitivity] (➔ 88 / ISO Sensitivity)
- [White Balance] (➔ 91 / White Balance (WB))
- [Photo Style] (➔ 96 / [Photo Style])
- [Metering Mode] (➔ 85 / [Metering Mode])
- [i.Dynamic Range] (➔ 178 / [i.Dynamic Range])
- [Filter Effect] (➔ 101 / [Filter Settings])
- [Synchro Scan] (➔ 126 / [Synchro Scan])

#### [Focus]

- [Focus Mode] (➔ 70 / Selecting the Focus Mode)
- [AF Mode] (➔ 73 / Selecting the AF Mode)
- [AF Custom Setting(Video)] (➔ 78 / [AF Custom Setting(Video)])
- [Focus Peaking] (➔ 181 / [Focus Peaking])
- [Focus Peaking Sensitivity] (➔ 181 / [Focus Peaking Sensitivity])
- [1-Area AF Moving Speed] (➔ 181 / [1-Area AF Moving Speed])

#### [Image Format]

- [Rec. File Format] (➔ 55 / [Rec. File Format])
- [Rec Quality] (➔ 56 / [Rec Quality])
- [Rec Quality (My List)] (➔ 60 / [add to list])
- [Variable Frame Rate] (➔ 112 / [Variable Frame Rate])
- [Time Code Display] (➔ 63 / [Time Code Display])

#### [Audio]

- [Sound Rec Level Disp.] (➔ 105 / [Sound Rec Level Disp.])
- [Sound Rec Level Adj.] (➔ 106 / [Sound Rec Level Adj.])
- [Sound Rec Level Limiter] (➔ 106 / [Sound Rec Level Limiter])
- [XLR Mic Adaptor Setting] (➔ 142 / XLR Microphone Adaptor (Optional))
- [Special Mic. Directivity Adjust] (➔ 141 / Setting the Sound Pickup Range (DMW-MS2: Optional))

#### [Others (Video)]

- [Image Stabilizer] (➔ 107 / [Image Stabilizer])
- [E-Stabilization (Video)] (➔ 107 / [E-Stabilization (Video)])
- [Image Area of Video] (➔ 61 / [Image Area of Video])
- [Digital Zoom] (➔ 84 / [Digital Zoom])
- [Focus Transition] (➔ 114 / [Focus Transition])
- [Live Cropping] (➔ 117 / [Live Cropping])

#### [Monitor / Display]

- [Level Gauge] (➔ 189 / [Level Gauge])
- [Histogram] (➔ 188 / [Histogram])
- [Luminance Spot Meter] (➔ 189 / [Luminance Spot Meter])
- [Frame Marker] (➔ 111 / [Frame Marker])
- [Zebra Pattern] (➔ 110 / [Zebra Pattern])
- [LUT View Assist (HDMI)] (➔ 121 / [LUT View Assist (HDMI)])
- [LUT View Assist (SDI)] (➔ 121 / [LUT View Assist (SDI)])
- [HLG View Assist (HDMI)] (➔ 123 / [HLG View Assist])
- [HLG View Assist (SDI)] (➔ 123 / [HLG View Assist])
- [Anamorphic Desqueeze Display] (➔ 125 / [Anamorphic Desqueeze Display])
- [Color Bars] (➔ 111 / Color bars / Test Tone)

## ■ [2] tab

### ☉ [Lens / Others]

- [Step Zoom] (➔ 84 / [Step Zoom])

### 📄 [Card/File]

- [Destination Card Slot]
  - Changes the priority of cards for recording. This can be used if [Double Card Slot Function] (➔ 34 / [Double Card Slot Function]) is set to [Relay Rec].

### 📶 [IN/OUT]

- [LAN / Wi-Fi] (➔ 194 / [LAN / Wi-Fi])
- [Fan Mode] (➔ 192 / [Fan Mode])

### ⚙️ [Others]

- [No Setting]
  - Set when not registering any function.

## Quick Menu Detailed Settings

[MENU/SET] ➔ [⚙️] ➔ [📄] ➔ Select [Q.MENU Settings]

[Layout Style]	Changes the appearance of the Quick menu. <b>[MODE1]:</b> Displays the live view and the menu simultaneously. <b>[MODE2]:</b> Displays the menu in full screen.
[Item Customize (Video)]	Customizes the Quick menu to display.

# Custom Mode

Menu settings that match your preferences can be registered in Custom mode.

You can use registered settings by switching to [Custom Mode C1] until [Custom Mode C12] at the recording mode menu.

## Register in Custom Mode

You can register the currently set information of the camera.

At the time of purchase, the default settings of the [Creative Video Mode] menus are registered with all Custom modes.

### 1 Set menu settings of the state you wish to save.

### 2 Select [Save to Custom Mode].

- [MENU/SET] → [Fn] → [Settings] → [Save to Custom Mode]

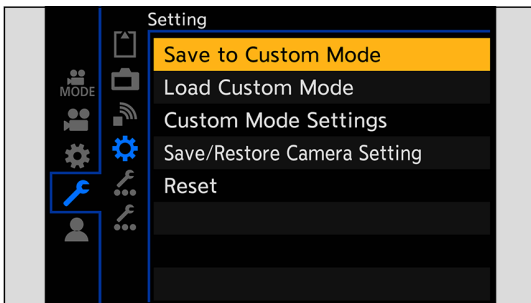

### 3 Register.

- Select the save-to number and then press [MENU/SET].
- A confirmation screen will be displayed. Press [Fn1] to change the Custom mode name.  
For information on how to enter characters (→ [203 / Entering Characters](#))

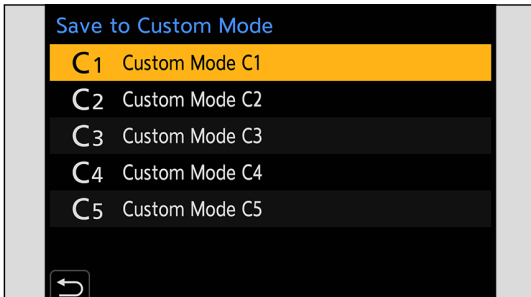

- List of settings that can be registered in Custom mode (→ [266 / List of Default Settings / Custom Saving / Settings Available for Copying](#))

## Custom Mode Detailed Settings

You can create additional Custom mode sets, and how long to retain temporarily changed settings details.

[MENU/SET] → [f] → [⚙] → Select [Custom Mode Settings]

<b>[Limit No. of Custom Mode]</b>	Sets the number of custom modes that will be displayed in the recording mode menu. A maximum of 12 sets can be registered; 5 sets are available as default settings.
<b>[Edit Title]</b>	Changes the Custom mode name. A maximum of 22 characters can be entered. A two-byte character is treated as two characters. • For information on how to enter characters (➔ <a href="#">203 / Entering Characters</a> )
<b>[How to Reload Custom Mode]</b>	Sets the timing at which to return the settings that were changed temporarily while the Custom mode was being used to their registered settings. <b>[Change Recording Mode] / [Turn the Power ON]</b>
<b>[Select Loading Details]</b>	Sets the types of settings to call up with [Load Custom Mode]. <b>[F / SS / ISO Sensitivity]:</b> Enables calling up of aperture value, shutter speed, and ISO sensitivity settings. <b>[White Balance]:</b> Enables calling up of white balance settings.

## Using Custom Mode

### 1 Select Custom mode.

- [MENU/SET] → [MODE] → [Settings] → [Custom Mode C1] to [Custom Mode C12]

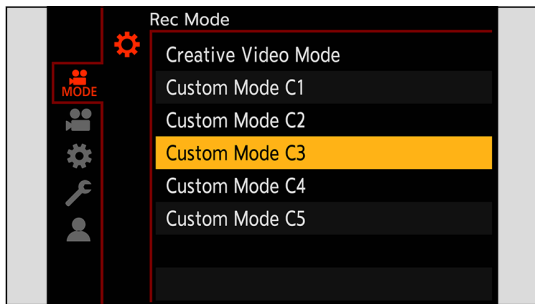

- The selected Custom mode icon will be displayed on the recording screen.

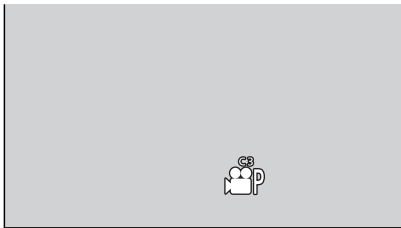

## Changing Registered Details

Registered settings do not change even if you change the camera settings temporarily with [Custom Mode C1] to [Custom Mode C12]. To change the registered details, overwrite them by using [Save to Custom Mode] in the [Setup] ([Setting]) menu.

## Calling Up Settings

Call up registered Custom mode settings to the selected recording mode and overwrite the current settings with the called up settings.

### 1 Set to the recording mode to use.

### 2 Select [Load Custom Mode].

- [MENU/SET] → [ ] → [ ] → [Load Custom Mode]

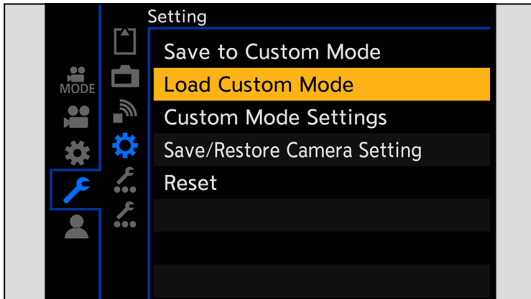

### 3 Select the Custom mode to call up.

- Select the Custom mode and then press [MENU/SET].

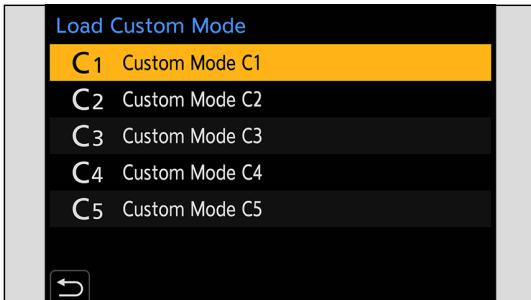



# My Menu

Register frequently-used menus in My Menu. A maximum of 23 items can be registered. Registered menus can be called up from [1] to [3].

## Registration in My Menu

### 1 Select [Add].

- [MENU/SET] → [1] → [Add] → [Add]

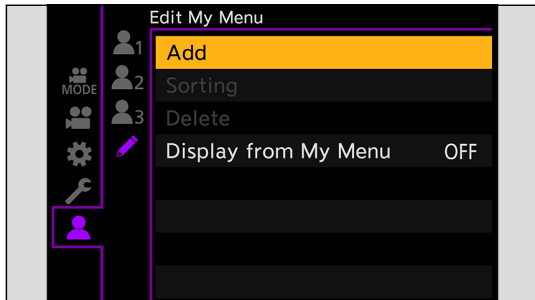

### 2 Register.

- Select the menu to register and then press [MENU/SET].

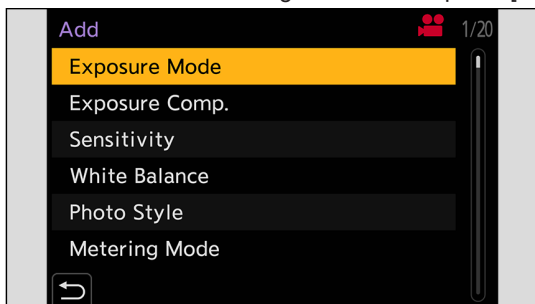

## Calling up My Menu

Call up the menus registered in My Menu.

[MENU/SET] → [1] → [1] / [2] / [3] → Registered menus

## Edit My Menu

You can reorder the display order of My Menu, and delete unnecessary menus.

[MENU/SET] → [Person] → Select [Pencil]

<b>[Add]</b>	Selects and registers the menus to be displayed in My Menu.
<b>[Sorting]</b>	Changes the order of My Menu. Select the menu to change, then set the destination.
<b>[Delete]</b>	Deletes menus that are registered to My Menu. <b>[Delete Item]:</b> Selects the menu, then deletes. <b>[Delete All]:</b> Deletes all menus registered in My Menu.
<b>[Display from My Menu]</b>	Displays My Menu first when displaying a menu. <b>[ON]:</b> Displays My Menu. <b>[OFF]:</b> Displays the last-used menu.

# [Save/Restore Camera Setting]

Saves the camera's settings information to the card. Saved settings information can be loaded to the camera, letting you set the same settings on multiple cameras.

[MENU/SET] → [↶] → [⚙️] → Select [Save/Restore Camera Setting]

<p>[Save]</p>	<p>Saves the camera's settings information to the card.</p> <ul style="list-style-type: none"> <li>• If saving new data, then select [New File], and if overwriting an existing file, select that existing file.</li> <li>• When [New File] is selected, a screen to select the file name to save as is displayed.</li> </ul> <p><b>[OK]:</b> Saves using the file name on the screen.</p> <p><b>[Change the file name]:</b> Changes the file name and saves the file.</p> <ul style="list-style-type: none"> <li>• Available characters: alphabetic characters (upper-case), numerals, up to 8 characters</li> <li>• For information on how to enter characters (➔ <a href="#">203 / Entering Characters</a>)</li> </ul>
<p>[Load]</p>	<p>Loads the settings information on the card and copies it to the camera.</p>
<p>[Delete]</p>	<p>Deletes settings information on the card.</p>
<p>[Keep Settings While Format]</p>	<p>When formatting the card, formats the card while keeping camera settings information stored on the card.</p>

- Only settings information from the same model can be loaded.
- Up to 10 instances of settings information can be saved on one card.
- List of functions for which saving of settings information is possible (➔ [266 / List of Default Settings / Custom Saving / Settings Available for Copying](#))

# 11. Menu Guide

This chapter provides a list of menus and describes them in detail.

- For information about menu operation methods. (➔ [46 / Menu Operation Methods](#))
- Refer to the “13. Materials” chapter for the following list:
  - List of Default Settings / Custom Saving / Settings Available for Copying: ➔ [266 / List of Default Settings / Custom Saving / Settings Available for Copying](#)

## List of Menu

### [Rec Mode] menu

⚙️ Recording mode (➔ [176 / \[Rec Mode\] menu \(Recording mode\)](#))

### [Video] menu

🔍 [Image Quality] (➔ [176 / \[Video\] menu \(\[Image Quality\]\)](#))

- [Exposure Mode]
- [Exposure Comp.]
- [Sensitivity]
- [White Balance]
- [Photo Style]
- [Metering Mode]
- [Dual Native ISO Setting]
- [ISO Sensitivity (video)]
- [Synchro Scan]
- [Master Pedestal Level]
- [SS/Gain Operation]
- [i.Dynamic Range]
- [Vignetting Comp.]
- [Diffraction Compensation]
- [Filter Settings]

📺 [Image Format] (➔ [179 / \[Video\] menu \(\[Image Format\]\)](#))

- [Rec. File Format]
- [Image Area of Video]
- [Rec Quality]
- [Rec Quality (My List)]
- [Variable Frame Rate]
- [Time Code]
- [Genlock]
- [Luminance Level]

🎯 [Focus] (➔ [180 / \[Video\] menu \(\[Focus\]\)](#))

- [Focus Mode]
- [AF Mode]
- [AF Custom Setting(Video)]
- [Continuous AF]
- [Focus Peaking]
- [1-Area AF Moving Speed]

** [Audio] (→ 181 / [Video] menu ([Audio]))**

- [Sound Rec Level Disp.]
- [Mute Sound Input]
- [Sound Rec Gain Level]
- [Sound Rec Level Adj.]
- [Sound Rec Level Limiter]
- [Wind Noise Canceller] / [Wind Cut]
- [Lens Noise Cut]
- [Mic Socket]
- [Special Mic.]
- [XLR Mic Adaptor Setting]
- [Sound Output]
- [Headphone Volume]

** [Others] (→ 183 / [Video] menu ([Others]))**

- [Image Stabilizer]
- [Digital Zoom]
- [Focus Transition]
- [Loop Recording (video)]
- [Segmented File Recording]
- [Live Cropping]
- [Time Stamp Rec.]

**[Custom] menu**** [Image Quality] (→ 185 / [Custom] menu ([Image Quality]))**

- [Photo Style Settings]
- [ISO Increments]
- [Extended ISO]
- [Exposure Offset Adjust.]

** [Focus/Shutter] (→ 186 / [Custom] menu ([Focus/Shutter]))**

- [AF/AE Lock Hold]
- [AF+MF]
- [MF Assist]
- [MF Guide]
- [Focus Ring Lock]

** [Operation] (→ 187 / [Custom] menu ([Operation]))**

- [Q.MENU Settings]
- [Fn Button Set]
- [Video Rec. Button]

** [Monitor / Display] (→ 188 / [Custom] menu ([Monitor / Display]))**

- [Histogram]
- [Focal Length]
- [Level Gauge]
- [Luminance Spot Meter]
- [Framing Outline]
- [Display Information]
- [V-LogL View Assist]
- [HLG View Assist]
- [Anamorphic Desqueeze Display]
- [Center Marker]
- [Frame Marker]
- [Zebra Pattern]
- [Color Bars]
- [Red REC Frame Indicator]

 **[IN/OUT]** (➔ 191 / [Custom] menu ([IN/OUT]))

- [HDMI Rec Output]
- [SDI Rec Output]
- [Fan Mode]
- [Tally Lamp]

 **[Lens / Others]** (➔ 192 / [Custom] menu ([Lens / Others]))

- [Lens Focus Resume]
- [Power Zoom Lens]
- [Lens Fn Button Setting]

**[Setup] menu** **[Card/File]** (➔ 193 / [Setup] menu ([Card/File]))

- [Card Format]
- [Double Card Slot Function]
- [Folder / File Settings]
- [File Number Reset]
- [Copyright Information]

 **[Monitor / Display]** (➔ 194 / [Setup] menu ([Monitor / Display]))

- [Level Gauge Adjust.]

 **[IN/OUT]** (➔ 194 / [Setup] menu ([IN/OUT]))

- [Headphone Volume]
- [LAN / Wi-Fi]
- [Bluetooth]
- [USB Mode]
- [HDMI / SDI Connections]
- [Info Display (HDMI/SDI)]
- [Power/Network Indicator]
- [Card Access Light]

 **[Setting]** (➔ 196 / [Setup] menu ([Setting]))

- [Save to Custom Mode]
- [Load Custom Mode]
- [Custom Mode Settings]
- [Save/Restore Camera Setting]
- [Reset]





 **[Others]** (➔ 197 / [Setup] menu ([Others]))

- [Clock Set]
- [Time Zone]
- [System Frequency]
- [Device Name]
- [Pixel Refresh]
- [Language]
- [Firmware Version]
- [Online Manual]

**[My Menu]** **[Page 1]** (➔ 169 / My Menu) **[Page 2]** (➔ 169 / My Menu) **[Page 3]** (➔ 169 / My Menu) **[Edit My Menu]** (➔ 170 / Edit My Menu)

- [Add]
- [Sorting]
- [Delete]
- [Display from My Menu]

## [Playback] menu

-  [Playback Mode] (➔ 200 / [Playback] menu ([Playback Mode]))
  - [Anamorphic Desqueeze Display]
  
-  [Add/Delete Info.] (➔ 200 / [Playback] menu ([Add/Delete Info.]))
  - [Protect]
  - [Rating]
  
-  [Edit Image] (➔ 201 / [Playback] menu ([Edit Image]))
  - [Copy]
  
-  [Others] (➔ 202 / [Playback] menu ([Others]))
  - [Delete All Images]

## [Rec Mode] menu

### [Rec Mode] menu (Recording mode)

▶ : Default settings

▶ [Creative Video Mode] / [Custom Mode C1] to [Custom Mode C12]

This selects a recording mode. (➔ [167 / Using Custom Mode](#))

## [Video] menu

### [Video] menu ([Image Quality])

▶ : Default settings

#### [Exposure Mode]

▶ [P] / [A] / [S] / [M]

Sets the exposure mode. (➔ [53 / Exposure Mode](#))

#### [Exposure Comp.]

[-3] to [+3] (▶ ± 0)

This compensates the exposure. (➔ [86 / Exposure Compensation](#))

#### [Sensitivity]

▶ [AUTO] / [160] to [51200]

This sets the sensitivity to light. (➔ [88 / ISO Sensitivity](#))

#### [White Balance]

▶ [AWB] / [AWBc] / [AWBw] /  /  /  /  /  to  /  to 

This compensates the effect of the light of the color that illuminates the subject. (➔ [91 / White Balance \(WB\)](#))



**[Photo Style]**

▶ [Standard] / [Vivid] / [Natural] / [Landscape] / [Portrait] / [Monochrome] / [L.Monochrome] / [L.Monochrome D] / [Cinelike D2] / [Cinelike V2] / [Like709] / [V-Log L] / [Hybrid Log Gamma] / [MY PHOTO STYLE 1] to [MY PHOTO STYLE 10]

You can select the finishing settings of images to suit your subjects and expression styles. (➔ 96 / [\[Photo Style\]](#))

**[Metering Mode]**

▶  /  /  / 

You can switch the method of measurement for the brightness. (➔ 85 / [\[Metering Mode\]](#))

**[Dual Native ISO Setting]**

▶ [AUTO] / [LOW] / [HIGH]

Sets whether to switch the base sensitivity automatically or to fix it. (➔ 90 / [\[Dual Native ISO Setting\]](#))

**[ISO Sensitivity (video)]**

[ISO Auto Lower Limit Setting]	▶ [160] to [25600]
[ISO Auto Upper Limit Setting]	▶ [AUTO] / [200] to [51200]

Sets the lower and upper limits for ISO sensitivity when ISO sensitivity is set to [AUTO]. (➔ 90 / [\[ISO Sensitivity \(video\)\]](#))

**[Synchro Scan]**

[ON] / ▶ [OFF]

Fine-adjust the shutter speed to reduce flickering and horizontal stripes. (➔ 126 / [\[Synchro Scan\]](#))

**[Master Pedestal Level]**

[-15] to [15] (▶ 0)

You can adjust the black level, which serves as the reference for images. (➔ 95 / [\[Master Pedestal Level\]](#))

**[SS/Gain Operation]**

▶ [SEC/ISO] / [ANGLE/ISO] / [SEC/dB]

You can switch the units of shutter speed values and gain (sensitivity) values. (➔ 108 / [\[SS/Gain Operation\]](#))

**[i.Dynamic Range]**

[AUTO] / [HIGH] / [STANDARD] / [LOW] / ► [OFF]

Contrast and exposure are compensated when the brightness difference between the background and subject is great.

- Compensation effect may not be achieved depending on the recording conditions.
- When the following functions are being used, [i.Dynamic Range] is not available:
  - [Like709] / [V-Log L] / [Hybrid Log Gamma] ([Photo Style])
  - [Filter Settings]

**[Vignetting Comp.]**

[ON] / ► [OFF]

When the screen periphery darkens as a result of the lens characteristics, you can record pictures with the brightness of the screen periphery corrected.

- Compensation effect may not be achieved depending on the recording conditions.
- Noise in the periphery of the picture may stand out with higher ISO sensitivity.
- When the following functions are being used, [Vignetting Comp.] is not available:
  - [PIXEL/PIXEL] ([Image Area of Video])
  - [Variable Frame Rate]

**[Diffraction Compensation]**

[AUTO] / ► [OFF]

The camera raises the image resolution by correcting the blurriness caused by diffraction when the aperture is closed.

- Compensation effect may not be achieved depending on the recording conditions.
- Noise may stand out with higher ISO sensitivity.

**[Filter Settings]**

[Filter Effect]

[ON] / ► [OFF] / [SET]

This mode records with additional image effects (filters). (➔ 101 / [Filter Settings])

## [Video] menu ([Image Format])

▶ : Default settings

### [Rec. File Format]

▶ [MP4] / [MOV]

Sets the video recording file format. (➔ 55 / [Rec. File Format])

### [Image Area of Video]

▶ [FULL] / [PIXEL/PIXEL]

Sets the image area during video recording. (➔ 61 / [Image Area of Video])

### [Rec Quality]

Sets the video recording image quality. (➔ 56 / [Rec Quality])

### [Rec Quality (My List)]

Calls up a recording quality registered in My List. (➔ 60 / [add to list])

### [Variable Frame Rate]

[ON] / ▶ [OFF]

Varies the recording frame rate to record slow motion video and fast motion video. (➔ 112 / [Variable Frame Rate])

### [Time Code]

[Time Code Display]	[ON] / ▶ [OFF]
[Count Up]	▶ [REC RUN] / [FREE RUN]
[Time Code Value]	[Reset]
	[Manual Input]
	[Current Time]
[Time Code Mode]	▶ [DF] / [NDF]
[HDMI Time Code Output]	[ON] / ▶ [OFF]
[SDI Time Code Output]	[ON] / ▶ [OFF]
[External TC Setting]	[TC Synchronization]
	[TC Output Reference]
Sets the recording, display, and output of the time code. (➔ 62 / Time Code)	

**[Genlock]**

[Genlock Input]	[ON] / ▶ [OFF]
[Horizontal Phase Adjustment]	[-206] to [+49] (▶ [±0])
This synchronizes the image signal of the camera and external device. (➔ 67 / <a href="#">Genlock settings</a> )	

**[Luminance Level]**

[0-255] / [16-235] / ▶ [16-255]
You can set the luminance range to suit the purpose of video recording. (➔ 90 / <a href="#">[Luminance Level]</a> )



**[Video] menu ([Focus])**

▶ : Default settings

**[Focus Mode]**

▶ [AF] / [MF]
This switches between AF and MF. (➔ 70 / <a href="#">Selecting the Focus Mode</a> )

**[AF Mode]**

 / ▶ 
You can select the focus method according to the position or number of subjects. (➔ 73 / <a href="#">Selecting the AF Mode</a> )

**[AF Custom Setting(Video)]**

[ON] / ▶ [OFF]	
[SET]	[AF Speed] / [AF Sensitivity]
You can fine-adjust the focusing method for video recording using [Continuous AF]. (➔ 78 / <a href="#">[AF Custom Setting(Video)]</a> )	

**[Continuous AF]**

[MODE1] / ▶ [MODE2] / [OFF]
You can select how to set the focus in AF when recording videos. (➔ 78 / <a href="#">[Continuous AF]</a> )

**[Focus Peaking]**

▶ [ON] / [OFF]

[SET]

[Focus Peaking Sensitivity]

[Display Color]



During MF operation, in-focus portions (portions on the screen with clear outlines) are highlighted with color.

- If the [Focus Peaking Sensitivity] is adjusted to the negative direction, portions to be highlighted are reduced, allowing you to achieve a more precise focus.
- With [Display Color], you can set the display color of the in-focus portion.

**[1-Area AF Moving Speed]**

▶ [FAST] / [NORMAL]

Sets the speed when moving a single AF area.

This operates when AF mode is set to ,  or .

**[Video] menu ([Audio])**

▶ : Default settings

**[Sound Rec Level Disp.]**

[ON] / ▶ [OFF]

The sound recording level is displayed on the recording screen. (➔ 105 / [Sound Rec Level Disp.]

**[Mute Sound Input]**

[ON] / ▶ [OFF]

This mutes audio input. (➔ 105 / [Mute Sound Input])

**[Sound Rec Gain Level]**

▶ [STANDARD] / [LOW]

This switches the gain of audio input. (➔ 105 / [Sound Rec Gain Level])

**[Sound Rec Level Adj.]**

[MUTE], [-18dB] to [+12dB] ▶ [0dB]

Manually adjust the sound recording level. (➔ 106 / [Sound Rec Level Adj.]

**[Sound Rec Level Limiter]**

▶ [ON] / [OFF]

The sound recording level is adjusted automatically to minimize sound distortion (crackling noise). (➔ 106 / [\[Sound Rec Level Limiter\]](#))

**[Wind Noise Canceller]**

[HIGH] / ▶ [STANDARD] / [OFF]

This reduces the wind noise coming into the built-in microphone while maintaining sound quality. (➔ 106 / [\[Wind Noise Canceller\]](#))

**[Wind Cut]**

[HIGH] / [STANDARD] / [LOW] / ▶ [OFF]

This reduces wind noise when an external microphone is connected. (➔ 141 / [Reduction of Wind Noise](#))

**[Lens Noise Cut]**

▶ [ON] / [OFF]

You can reduce the zoom sound produced during video recording when you are using interchangeable lens compatible with power zoom. (➔ 106 / [\[Lens Noise Cut\]](#))

**[Mic Socket]**

▶ [MIC] / [MIC] / [LINE]

Sets the [MIC] terminal input method that suits the device to be connected. (➔ 140 / [External Microphones \(Optional\)](#))

**[Special Mic.]**

▶ [STEREO] / [LENS AUTO] / [SHOTGUN] / [S.SHOTGUN] / [MANUAL]

Sets the sound pickup range when using the Stereo Shotgun Microphone (DMW-MS2: optional). (➔ 141 / [Setting the Sound Pickup Range \(DMW-MS2: Optional\)](#))

**[XLR Mic Adaptor Setting]**

[96kHz/24bit] / [48kHz/24bit] / ▶ [48kHz/16bit] / [OFF]

Sets the audio input for when an XLR Microphone Adaptor (DMW-XLR1: optional) is attached. (➔ 142 / [XLR Microphone Adaptor \(Optional\)](#))

**[Sound Output]**

▶ [REALTIME] / [REC SOUND]

Sets the audio output method when headphones are connected. (➔ [144 / Switching the Sound Output Method](#))**[Headphone Volume]**

[0] to [LEVEL15] ▶ [LEVEL3]

Adjusts the volume when headphones are connected. (➔ [144 / Adjusting the Headphone Volume](#))**[Video] menu ([Others])**

▶ : Default settings

**[Image Stabilizer]**

[Operation Mode] ▶ [(( ))) / [OFF]

[E-Stabilization (Video)] [ON] / ▶ [OFF]

Configures image stabilizer settings. (➔ [107 / \[Image Stabilizer\]](#))**[Digital Zoom]**

[4x] / [2x] / ▶ [OFF]

You can zoom in up to 4x the original zoom magnification. (➔ [84 / \[Digital Zoom\]](#))**[Focus Transition]**

[Start]

[Focus Pull Setting] [1] / [2] / [3]

[Focus Transition Speed] [SH] / [H] / ▶ [M] / [L] / [SL]

[Focus Transition Rec] [1] / [2] / [3] / ▶ [OFF]

[Focus Transition Wait] [10SEC] / [5SEC] / ▶ [OFF]

Smoothly transitions the focus position from the current position to a position registered in advance. (➔ [114 / \[Focus Transition\]](#))**[Loop Recording (video)]**

[ON] / ▶ [OFF]

When the recording fills the card to capacity, recording continues while deleting older data. (➔ [127 / \[Loop Recording \(video\)\]](#))

**[Segmented File Recording]**

[10MIN.] / [5MIN.] / [3MIN.] / [1 MIN.] / ► [OFF]

Video is divided every few minutes while being recorded. (➔ 128 / [\[Segmented File Recording\]](#))**[Live Cropping]**

[40SEC] / [20SEC] / ► [OFF]

By cropping a part of the range displayed in the live view, it is possible to record FHD video that incorporates panning and zooming with the camera staying in a fixed position. (➔ 117 / [\[Live Cropping\]](#))**[Time Stamp Rec.]**

[ON] / ► [OFF]

Records the recorded date and time superimposed on the images.

- You cannot delete recording dates after superimposing them.
- When the following functions are being used, [Time Stamp Rec.] is not available:
  - Anamorphic (4:3) video
  - [Variable Frame Rate]



# [Custom] menu

## [Custom] menu ([Image Quality])

▶ : Default settings

### [Photo Style Settings]

[Show/Hide Photo Style]	[Vivid] / [Natural] / [Landscape] / [Portrait] / [L.Monochrome] / [L.Monochrome D] / [Cinelike D2] / [Cinelike V2] / [Like709] / [V-Log L] / [Hybrid Log Gamma] / [MY PHOTO STYLE 1] to [MY PHOTO STYLE 10]
Sets Photo Style items to be displayed on the menu.	
[My Photo Style Settings]	[Add Effects]
	[Load Preset Setting]
Enables detailed image quality adjustment settings for My Photo Style.	
<p><b>[Add Effects]:</b> Enables [Dual Native ISO Setting], [Sensitivity], and [White Balance] settings in image quality adjustment.</p> <p><b>[Load Preset Setting]:</b> Sets the timing at which image quality adjustment values changed in My Photo Style are returned to their registered state.</p>	
[Reset Photo Style]	
Returns details changed in [Photo Style] and [Photo Style Settings] to their default settings.	

### [ISO Increments]

▶ [1/3 EV] / [1 EV]

Changes the intervals between ISO sensitivity adjustment values.

### [Extended ISO]

[ON] / ▶ [OFF]

Extends the setting range of ISO sensitivity.

- The extendible range depends on the [Dual Native ISO Setting] (➔ [90](#) / [\[Dual Native ISO Setting\]](#)).
  - When set to [AUTO]: Lower limit can be extended to [80] and the upper limit can be extended to [204800]
  - When set to [LOW]: Lower limit can be extended to [80]
  - When set to [HIGH]: Upper limit can be extended to [204800]

**[Exposure Offset Adjust.]**

[Multi Metering]	[-1 EV] to [+1 EV] (▶ [±0 EV])
[Center Weighted]	[-1 EV] to [+1 EV] (▶ [±0 EV])
[Spot]	[-1 EV] to [+1 EV] (▶ [±0 EV])
[Highlight Weighted]	[-1 EV] to [+1 EV] (▶ [±0 EV])

Adjusts the exposure level that is the standard correct exposure for each item of [Metering Mode]. Adds the adjustment value from this function to the exposure compensation value (➔ 86 / [Exposure Compensation](#)) when recording.

- It is not possible to add an adjustment value of a range that exceeds ±3 EV.

**[Custom] menu ([Focus/Shutter])**

▶ : Default settings

**[AF/AE Lock Hold]**

[ON] / ▶ [OFF]
----------------

This sets button operations for AF/AE Lock. Turning this [ON] maintains the lock after releasing the button until it is pressed again.

**[AF+MF]**

[ON] / ▶ [OFF]
----------------

You can fine-adjust the focus manually during AF Lock by rotating the focus ring.

- When a Fn button that has [AF-ON] registered is pressed
- When locked using the Fn button [AF LOCK] or [AF/AE LOCK]

**[MF Assist]**

(When an interchangeable lens with a focus ring is attached) [Focus Ring]	▶ [ON] / [OFF]
[AF Mode]	▶ [ON] / [OFF]
[MF Assist Display]	[FULL] / ▶ [PIP]

This sets the display method of MF Assist (enlarged screen).

**[Focus Ring]:** The screen is enlarged by focusing with the lens.

**[AF Mode]:** The screen is enlarged by pressing a Fn button that has [AF Mode] registered.

**[MF Assist Display]:** Sets the display method (full screen mode/windowed mode) of MF Assist (enlarged screen).

- While you are using the following functions, MF Assist will not be displayed:
  - Video recording
  - [Digital Zoom]

**[MF Guide]**

▶ [ON] / [OFF]

During MF, MF Guide, which acts as a guide to recording distance, is displayed on the screen.

**[Focus Ring Lock]**

[ON] / ▶ [OFF]

This disables the focus ring operation during MF to lock the focus.

- [MFL] is displayed on the recording screen while the focus ring is locked.

**[Custom] menu ([Operation])**

▶ : Default settings

**[Q.MENU Settings]**

[Layout Style]

▶ [MODE1] / [MODE2]

[Item Customize (Video)]

Customizes the Quick menu. (➔ [164 / Quick Menu Detailed Settings](#))

**[Fn Button Set]**

[Setting in REC mode]

[Setting in PLAY mode]

Registers a function to the Fn button. (➔ [155 / Register Functions to the Fn Buttons](#))

**[Video Rec. Button]**

▶ [ON] / [OFF]

Enables/disables the video rec. button.

## [Custom] menu ([Monitor / Display])

▶ : Default settings

### [Histogram]

[ON] / ▶ [OFF]

This displays the histogram.

Turning this [ON] displays the histogram transition screen.

Press ▲▼◀▶ to set the position.

- A histogram is a graph that displays brightness along the horizontal axis, and the number of pixels at each brightness level on the vertical axis. By looking at the distribution of the graph, you can determine the current exposure.

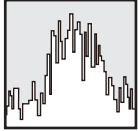

- Ⓐ Dark
- Ⓑ Bright

- When the recorded image and the histogram do not match each other under the following conditions, the histogram is displayed in orange:
  - During exposure compensation
  - When the correct exposure is not achieved, such as in low light situations.
- The histogram is an approximation in the recording mode.

### [Focal Length]

▶ [ON] / [OFF]

Displays the focal length on the recording screen during zoom control.

**[Level Gauge]**

▶ [ON] / [OFF]

Displays the level gauge which is useful in correcting camera tilt.

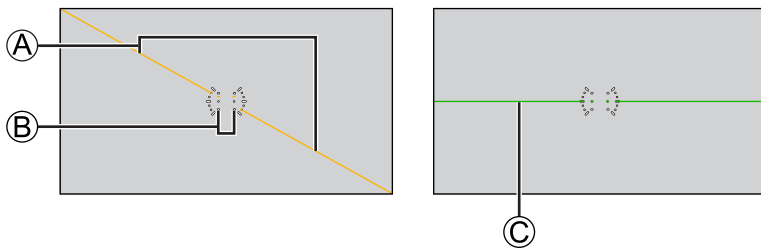

- Ⓐ Horizontal
- Ⓑ Vertical
- Ⓒ Green (no tilt)

- Even after correcting the tilt, there may still be an error of approx.  $\pm 1^\circ$ .
- When the camera is tilted significantly upwards or downwards, the level gauge may not be displayed correctly.
- You can adjust the level gauge and reset the adjusted values in [Level Gauge Adjust.] in the [Setup] ([Monitor / Display]) menu. (➔ [194 / \[Level Gauge Adjust.\]](#))

**[Luminance Spot Meter]**

[ON] / ▶ [OFF]

Specify any spot on the subject to measure the luminance over a small area. (➔ [109 / \[Luminance Spot Meter\]](#))

**[Framing Outline]**

[ON] / ▶ [OFF]

Displays the outline for the live view.

**[Display Information]**

[Display Info in Rec Mode]

▶ [WITH INFO] / [WITHOUT INFO] / [CTRL PANEL]

[Display Info in Playback]

▶ [WITH INFO] / [DETAILED INFO DISP] / [WITHOUT INFO]

Switches the information display of the recording screen and playback screen. (➔ [41 / Switching the Display Information](#))

**[V-LogL View Assist]**

[Read LUT File]	
[LUT Select]	
[LUT View Assist (HDMI)]	[ON] / ► [OFF]
[LUT View Assist (SDI)]	[ON] / ► [OFF]
You can output images with LUT data applied via HDMI/SDI. (➔ <a href="#">121</a> / <a href="#">[V-LogL View Assist]</a> )	

**[HLG View Assist]**

[HDMI]	► [AUTO] / [MODE1] / [MODE2] / [OFF]
[SDI]	[MODE1] / ► [MODE2] / [OFF]
At recording or playback of HLG video, this outputs images with converted color gamut and brightness over HDMI/SDI. (➔ <a href="#">123</a> / <a href="#">[HLG View Assist]</a> )	

**[Anamorphic Desqueeze Display]**

[ $2.0x$ ] / [ $1.8x$ ] / [ $1.5x$ ] / [ $1.33x$ ] / [ $1.30x$ ] / ► [OFF]
This displays the de-squeezed images suited to the magnification of the anamorphic lens. (➔ <a href="#">125</a> / <a href="#">[Anamorphic Desqueeze Display]</a> )

**[Center Marker]**

[ON] / ► [OFF]
The center of the recording screen will be displayed as [+].

**[Frame Marker]**

[ON] / ► [OFF]	
[SET]	[Frame Aspect]
	[Frame Color]
	[Frame Mask]
A frame with the set aspect ratio is displayed on the recording screen. (➔ <a href="#">111</a> / <a href="#">[Frame Marker]</a> )	

**[Zebra Pattern]**

[ZEBRA1] / [ZEBRA2] / [ZEBRA1+2] / ► [OFF]	
[SET]	[Zebra 1]
	[Zebra 2]
Parts that are brighter than the benchmark value are displayed with stripes. (➔ <a href="#">110</a> / <a href="#">[Zebra Pattern]</a> )	

**[Color Bars]**

[SMPTE] / [EBU] / [ARIB]

The color bars are displayed on the recording screen. (➔ [111 / Color bars / Test Tone](#))**[Red REC Frame Indicator]**

[ON] / ▶ [OFF]

A red frame is displayed on the recording screen that indicates that video is being recorded.

**[Custom] menu ([IN/OUT])**

▶ : Default settings

**[HDMI Rec Output]**

[Down Convert]	▶ [AUTO] / [4K/30p] ([4K/25p]) / [1080p] / [1080i] / [OFF]
[HDMI Recording Control]	[ON] / ▶ [OFF]
[Sound Down Convert]	[AUTO] / ▶ [OFF]
[Sound Output (HDMI)]	▶ [ON] / [OFF]
[HDMI MF Assist Output]	▶ [ON] / [OFF]

Sets HDMI output during recording. (➔ [134 / HDMI Output Image Quality \(Resolution / Frame Rate\)](#), ➔ [137 / HDMI Output Settings](#))

**[SDI Rec Output]**

[SDI Output Resolution]	▶ [1080p] / [1080i] / [1080PsF] / [720p]
[SDI Recording Control]	[ON] / ▶ [OFF]
[Sound Output (SDI)]	▶ [ON] / [OFF]
[SDI Sound Output Gain Adj.]	[0dB] / [-6dB] / ▶ [-8dB]
[SDI MF Assist Output]	▶ [ON] / [OFF]

Sets the SDI output during recording. (➔ [138 / SDI output settings](#))

- When [System Frequency] is set to [24.00Hz (CINEMA)], [SDI Output Resolution] is fixed to [1080PsF].

**[Fan Mode]**

▶ [AUTO1] / [AUTO2] / [NORMAL] / [SLOW]

Sets fan operation.

**[AUTO1]:** The fan operation switches automatically according to the temperature of the camera. This setting prioritizes controlling rises in temperature in the camera.**[AUTO2]:** The fan operation switches automatically according to the temperature of the camera. This setting prioritizes reducing fan noise.**[NORMAL]:** The fan operates constantly at a standard speed.**[SLOW]:** The fan operates constantly at low speed.**[Tally Lamp]**

[Front Tally Lamp]

▶ [H] / [L] / [OFF]

[Rear Tally Lamp]

▶ [ON] / [OFF]

This sets the operation of the tally lamp.

**[Custom] menu ([Lens / Others])**

▶ : Default settings

**[Lens Focus Resume]**

[ON] / ▶ [OFF]

The camera saves the focus position when you turn it off.

**[Power Zoom Lens]**

[Step Zoom]

[ON] / ▶ [OFF]

[Zoom Ring]

▶ [ON] / [OFF]

Sets the screen display and operation when using an interchangeable lens compatible with power zoom. (➔ 84 / [Power Zoom Lens])

**[Lens Fn Button Setting]**

▶ [Focus Stop] / [AF Mode] / [Focus Ring Lock] / [AE LOCK] / [AF LOCK] / [AF/AE LOCK] / [AF-ON] / [AF-ON : Near Shift] / [AF-ON : Far Shift] / [Focus Area Set] / [Image Stabilizer] / [No Setting] / [Off (Disable Press and Hold)] / [Restore to Default]

Sets the function to be assigned to the focus button of an interchangeable lens.

- You can call up the assigned function by setting the focus selector switch of a compatible interchangeable lens to [Fn] and then pressing the focus button of the lens.
- When [Focus Stop] is used, the focus is locked while the focus button is pressed and held.



# [Setup] menu

## [Setup] menu ([Card/File])

▶ : Default settings

### [Card Format]

[Card Slot 1] / [Card Slot 2]

Formats the card (initialization). (➔ 32 / [Formatting Cards \(Initialization\)](#))

### [Double Card Slot Function]

[Recording Method]

▶ [ ] / [ ] / [ ]

This sets the way recording to the card slots 1 and 2 is performed. (➔ 34 / [\[Double Card Slot Function\]](#))

### [Folder / File Settings]

[Select Folder] / [Create a New Folder] / [File Name Setting]

Set the folder and file name where to save the images. (➔ 33 / [\[Folder / File Settings\]](#))

### [File Number Reset]

[Card Slot 1] / [Card Slot 2]

Resets the file number of the next recording to 0001. (➔ 34 / [\[File Number Reset\]](#))

### [Copyright Information]

[Artist]

[ON] / ▶ [OFF] / [SET]

[Copyright Holder]

[ON] / ▶ [OFF] / [SET]

[Display Copyright Info.]

During the recording of still images, the registered names of the artist and the copyright holder are recorded in the Exif data of the image.

- You can register each name from [SET] in [Artist] and [Copyright Holder]. For information on how to enter characters (➔ [203 / Entering Characters](#))
- Up to 63 characters may be entered.
- You can confirm registered copyright information in [Display Copyright Info.].

## [Setup] menu ([Monitor / Display])

### [Level Gauge Adjust.]

[Adjust.]

Hold the camera in a horizontal position, and press [MENU/SET]. The level gauge will be adjusted.

[Level Gauge Value Reset]

Restores the default level gauge setting.

## [Setup] menu ([IN/OUT])

▶ : Default settings

### [Headphone Volume]

[0] to [LEVEL15] (▶ [LEVEL3])

Adjusts the volume when headphones are connected. (➔ 144 / [Adjusting the Headphone Volume](#))

- This functions in tandem with [Headphone Volume] in the [Video] ([Audio]) menu.

### [LAN / Wi-Fi]

[LAN / Wi-Fi Function] (➔ 208 / [Operating the Camera from a PC](#), ➔ 218 / [Connecting to a Smartphone \(Wi-Fi connection\)](#), ➔ 223 / [Connecting to a Smartphone \(Wired LAN connection\)](#))

[LAN / Wi-Fi Setup] (➔ 237 / [\[LAN / Wi-Fi Setup\] menu](#))

### [Bluetooth]

[Bluetooth] (➔ 215 / [Connecting to a Smartphone \(Bluetooth Connection\)](#))

[Remote Wakeup] (➔ 229 / [\[Remote Wakeup\]](#))

[Returning from Sleep Mode] (➔ 229 / [Shortening the Return Time when performing \[Remote Wakeup\]](#))





[Location Logging] (➔ 228 / [\[Location Logging\]](#))

[Auto Clock Set] (➔ 230 / [\[Auto Clock Set\]](#))



[Wi-Fi network settings]

**[Wi-Fi network settings]:** Registers the Wi-Fi access point. Wireless access points used to connect the camera to Wi-Fi networks will be registered automatically.

**[USB Mode]**

 [PC(Storage)] / ▶  [PC(Tether)]	
<p>This sets the communication method to be used when the USB connection cable is connected.</p> <p> <b>[PC(Storage)]</b>: Select this setting to export images to a connected PC. (➔ <a href="#">146 / Importing Images to a PC</a>)</p> <p> <b>[PC(Tether)]</b>: Select this setting to control the camera from a PC installed with "LUMIX Tether". (➔ <a href="#">207 / Tethered Recording</a>)</p>	

**[HDMI / SDI Connections]**

[SDI Output]	▶ [ON] / [OFF]
<p>This outputs via SDI.</p>	
[Output Resolution(Playback)]	<p>When [SDI Output] is set to [OFF]:</p> <p>▶ [AUTO] / [C4K/60p] / [C4K/50p] / [C4K/30p] / [C4K/25p] / [C4K/24p] / [4K/60p] / [4K/50p] / [4K/30p] / [4K/25p] / [4K/24p] / [1080p] / [1080i] / [720p] / [576p] / [480p]</p> <p>When [SDI Output] is set to [ON]:</p> <p>▶ [1080p] / [1080i] / [1080PsF]<sup>*1, *2</sup> / [720p]</p>
<p>Sets the HDMI/SDI output resolution for playback. When it is output via HDMI and SDI at the same time, it is output with the same settings. (When [SDI Output] is set to [ON], output with a resolution above 4K is not possible. When playing back an image at a resolution above 4K, set the [SDI Output] to [OFF].)</p> <p><sup>*1</sup> HDMI is output with [1080p].</p> <p><sup>*2</sup> When [System Frequency] is set to [24.00Hz (CINEMA)], it is fixed to [1080PsF].</p> <ul style="list-style-type: none"> <li>• The items you can select depend on the [System Frequency] setting.</li> <li>• If no image appears on the external device with [AUTO], switch to a constant setting other than [AUTO] to set a format supported by your external device. (Refer to the operating instructions for the external device.)</li> </ul>	
[LUT View Assist (HDMI)] / [LUT View Assist (SDI)]	[ON] / ▶ [OFF]
<p>Images with LUT data applied are output via HDMI/SDI when you record/playback videos with [Photo Style] set to [V-Log L]. (➔ <a href="#">121 / [V-LogL View Assist]</a>)</p> <ul style="list-style-type: none"> <li>• This is linked with [LUT View Assist (HDMI)] / [LUT View Assist (SDI)] in [V-LogL View Assist] of the [Custom] ([Monitor / Display]) menu.</li> </ul>	
[HLG View Assist (HDMI)] / [HLG View Assist (SDI)]	[AUTO] <sup>*1</sup> / [MODE1] / [MODE2] / [OFF]
<p>At recording or playback of HLG video, this converts their color gamut and brightness for display. (➔ <a href="#">123 / [HLG View Assist]</a>)</p> <p><sup>*1</sup> It can only be set when [HLG View Assist (HDMI)] is selected.</p> <ul style="list-style-type: none"> <li>• The default setting differs depending on the output method.              [HLG View Assist (HDMI)]: [AUTO]              [HLG View Assist (SDI)]: [MODE2]</li> <li>• This is linked with [HDMI] / [SDI] in [HLG View Assist] of the [Custom] ([Monitor / Display]) menu.</li> </ul>	
[Background Color(Playback)]	 / ▶ 
<p>Sets the color of the bands displayed on the top and bottom or the left and right of images output on an external device or similar display.</p> <ul style="list-style-type: none"> <li>• We recommend setting to  to prevent burn-in on the screen of the output destination.</li> </ul>	

**[Info Display (HDMI/SDI)]**

▶ [AUTO] / [HDMI] / [SDI] / [OFF]

This sets the output destination of the recording information and menu screen. (➔ [39 / Information Display \(HDMI/SDI\)](#))

**[Power/Network Indicator]**

▶ [ON] / [OFF]

This will light up the status indicator and [NETWORK] connection lamp.

**[Card Access Light]**

▶ [ON] / [OFF]

The card access lamp will light up when the card is being accessed.

**[Setup] menu ([Setting])****[Save to Custom Mode]**

[C1] to [C12]

You can register the currently set information of the camera. (➔ [165 / Register in Custom Mode](#))

**[Load Custom Mode]**

[C1] to [C12]

Calls up registered Custom mode settings to the selected recording mode and overwrites the current settings with called up settings. (➔ [168 / Calling Up Settings](#))

**[Custom Mode Settings]**

[Limit No. of Custom Mode]

[Edit Title]

[How to Reload Custom Mode]

[Select Loading Details]

Sets the ease of use of Custom mode. (➔ [166 / Custom Mode Detailed Settings](#))

**[Save/Restore Camera Setting]**

[Save] / [Load] / [Delete] / [Keep Settings While Format]

Saves the camera's settings information to the card. Saved settings information can be loaded to the camera, letting you set the same settings on multiple cameras. (➔ [171](#) / [\[Save/Restore Camera Setting\]](#))

**[Reset]**

Returns the camera to its default settings. (➔ [50](#) / [\[Reset\]](#))

**[Setup] menu ([Others])**

▶ : Default settings

**[Clock Set]**

Sets the date and time. (➔ [35](#) / [Clock Set](#))

**[Time Zone]**

Sets the time zone. (➔ [37](#) / [Time zone](#))

**[System Frequency]**

▶ [59.94Hz (NTSC)] / [50.00Hz (PAL)] / [24.00Hz (CINEMA)]

This changes the system frequency of videos that are recorded and played back. (➔ [55](#) / [\[System Frequency\]](#))

**[Device Name]**

This will set the camera name (32 characters or less). For information on how to enter characters (➔ [203](#) / [Entering Characters](#))

- The set name will be displayed as the individual ID for SSID during Wi-Fi connection or Tethered recording.
- When Tethered recording using several cameras, it is recommended to set an individual device name for each camera.

**[Pixel Refresh]**

This optimizes the image sensor and image processing.

- The image sensor and image processing are optimized when the camera is purchased. Use this function when bright spots that do not exist in the subject get recorded.
- When performing pixel refresh, block the lens from light with a body cap etc.
- Turn the camera off and on after the pixels are corrected.

**[Language]**

This set the language displayed on the screen.

- If you set a different language by mistake, select [Globe] from the menu icons to set the desired language.

**[Firmware Version]**

[Firmware Update] / [Software info]

You can check the firmware versions of the camera and lens. In addition, you can update the firmware, and display information about the camera software.

**[Firmware Update]:** Updates firmware.

- 1 Download the firmware. (➔ [10 / Firmware of Your Camera/Lens](#))
- 2 Save the firmware to the root directory of the card (the first folder that appears when you access the card on your PC), and then insert the card into the camera.
- 3 Select [Firmware Update], press [MENU/SET], and then select [Yes] to update the firmware.

**[Software info]:** Displays information about the camera software.

- When a supported optional item (XLR Microphone Adaptor, etc.) is attached to the camera, you can also check its firmware version.

**[Online Manual]**

[URL display] / [QR Code display]

Displays the URL or QR code in order to browse the "Owner's Manual" (HTML/PDF).

# [Playback] menu

## How to Select an Image(s) in the [Playback] menu

Follow the steps below when the image selection screen is displayed.

- Images are displayed separately by card slot. To switch the card to display, press [Q.MENU] and select the card slot.
- You can only select/edit images on one card at a time.

### ■ When [Single] has been selected

- 1 Press ◀▶ to select the image.

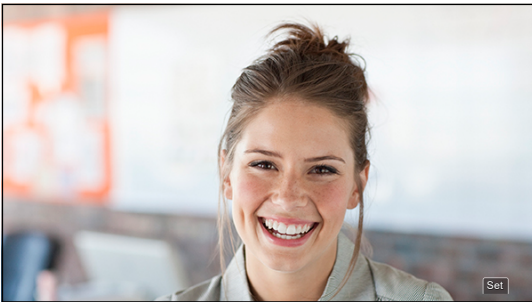

- 2 Press [MENU/SET].

- If [Set/Cancel] is displayed at the right bottom of the screen, the setting is canceled when [MENU/SET] is pressed again.

### ■ When [Multi] has been selected

- 1 Press ▲▼◀▶ to select the image, and then press [MENU/SET] to set (repeat).

- The setting is canceled when [MENU/SET] is pressed again.

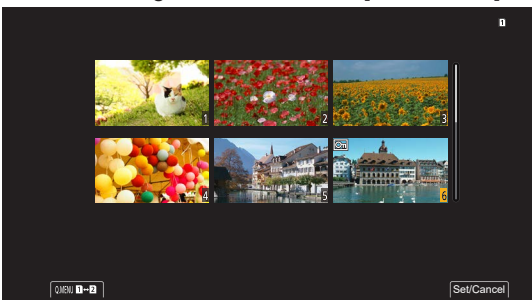

## [Playback] menu ([Playback Mode])

▶ : Default settings

### [Anamorphic Desqueeze Display]

[2.0x] / [1.8x] / [1.5x] / [1.33x] / [1.30x] / ▶ [OFF]

This displays the de-squeezed images suited to the magnification of the anamorphic lens. (➔ 125 / [\[Anamorphic Desqueeze Display\]](#))

- This is linked with [Anamorphic Desqueeze Display] of the [Custom] ([Monitor / Display]) menu.

## [Playback] menu ([Add/Delete Info.])

### [Protect]

[Single] / [Multi] / [Cancel]

You can set protection for images so that they will not be deleted by mistake. However, if you format the card, the protected images will also be deleted.

- For information about how to select images. (➔ 199 / [How to Select an Image\(s\) in the \[Playback\] menu](#))
- [Cancel] only allows to cancel settings at once for the images in a single card.
- Be careful because the [Protect] setting may be disabled on a device other than this camera.

### [Rating]

[Single] / [Multi] / [Cancel]

If you set any of the five different rating levels for images, you can delete all images except for those with ratings.

- 1 Select an image. (➔ 199 / [How to Select an Image\(s\) in the \[Playback\] menu](#))
- 2 Press ◀▶ to select a rating level (1 to 5) and then press [MENU/SET].
  - When [Multi] is selected, repeat Steps 1 and 2.
  - To cancel the setting, set the rating level to [OFF].



## [Playback] menu ([Edit Image])

▶ : Default settings

### [Copy]

[Copy Direction]

▶ [1→2] / [2→1]

[Select Copy] / [Copy All in Folder] / [Copy All in Card]

You can copy the images in one of the cards to the other card.

- Copied images will be saved in a new folder.

**[Select Copy]:** Copies selected images.

- 1 Select the folder containing the images to copy.
- 2 Select the images. (➡ [199 / How to Select an Image\(s\) in the \[Playback\] menu](#))
- 3 Press [Fn1] to execute.

**[Copy All in Folder]:** Copies all images in a folder.

- 1 Select the folder to copy.
- 2 Check the images to be copied and then press [MENU/SET] to execute copying.

**[Copy All in Card]:** Copies all images in the card.

#### ■ Using the Fn button to copy images

If you press the Fn button with [Copy] assigned while playing back one image at a time, the image currently being played back will be copied to the other card.

Select the copy destination folder from the following options. In the case of group images, [Create a New Folder] is selected automatically.

**[Same Folder Number as Source]:** Copies to a folder with the same name as the folder of the image to be copied.

**[Create a New Folder]:** Creates a new folder with an incremented folder number and then copies the image to it.

**[Select Folder]:** Selects a folder to store the image and then copies the image to it.

- You can set up to 100 images at once with [Select Copy].
- The [Protect] setting is not copied.
- Copying may take a while.
- When using the following combinations of cards, videos cannot be copied:
  - Copying from an SDXC memory card to an SD memory card or SDHC memory card

## [Playback] menu ([Others])

### [Delete All Images]

[Delete All] / [Delete All Non-rating]

Deletes all images in a card.

**[Delete All]:** Deletes all images in a card.

**[Delete All Non-rating]:** Deletes all images except those with a rating set.

- Images cannot be restored once they have been deleted. Carefully confirm the images before deletion.
- Depending on the number of images to be deleted, it may take some time to delete them.

# Entering Characters

Follow the steps below when the character entry screen is displayed.

## 1 Enter characters.

- Press ▲▼◀▶ to select characters and then press [MENU/SET] until the character to enter is displayed. (Repeat this)
- To repeatedly enter the same character, rotate ⌚ to the right to move the entry position cursor.
- If you select an item and press [MENU/SET], you can perform the following operations:
  - [A/a]: Change the character type to [A] (upper case characters), [a] (lower case characters), [1] (numbers), and [&] (special characters)
  - [ ]: Enter a blank
  - [Delete]: Delete a character
  - [◀]: Move the entry position cursor to the left
  - [▶]: Move the entry position cursor to the right
- When entering a password, Ⓐ shows the number of characters you have entered and the number of characters you can enter.

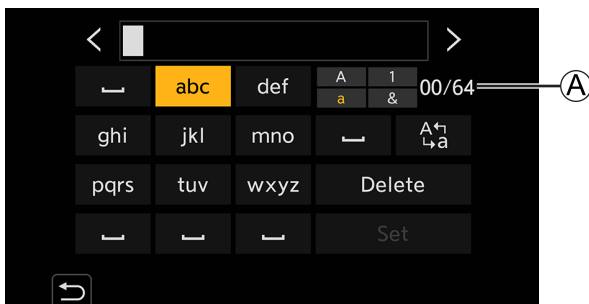

## 2 Complete entering.

- Select [Set] and then press [MENU/SET].

# 12. Remote Operations

This chapter explains the remote operation of the camera.

## About Remote Operation

Connect the camera to a PC or smartphone with a USB connection cable\*1, LAN cable, or Wi-Fi / Bluetooth\*2.

\*1 Only when connecting to a PC.

\*2 Bluetooth connection can be used only when connecting to a smartphone.

### Remote Operations from a PC

You can record remotely using the software "LUMIX Tether". (➔ [207 / Tethered Recording](#))

Example: When connecting the camera and PC with a USB connection cable or LAN cable.

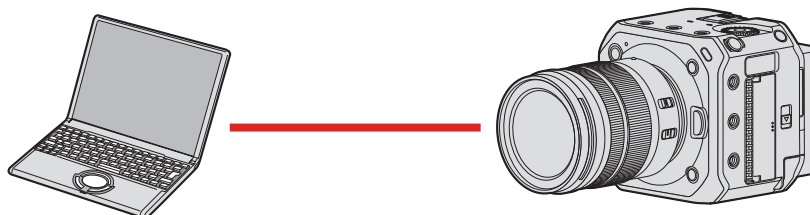

### Remote Operations from a Smartphone

You can record remotely using the smartphone app "LUMIX Sync". (➔ [213 / Connecting to a Smartphone](#))

Example: When the camera is connected to a smartphone by Wi-Fi.



This document refers to both smartphones and tablets as **smartphones**.

■ **Checking operation when connected to a network**

**External monitor display**

📶 : The Wi-Fi function is set to on, or there is a connection.

📶 : The Bluetooth function is set to on, or there is a connection.

📶 : Connected with a LAN cable.

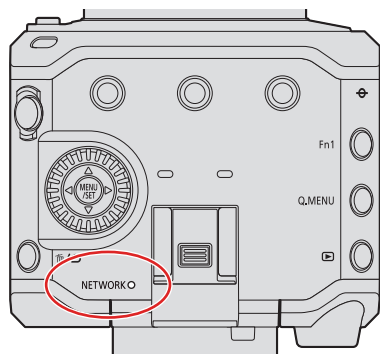

**[NETWORK] connection lamp (blue)**

Lit:

After being connected with a LAN cable.

When Wi-Fi/Bluetooth function is ON or connected.

Blinking:

When sending Tether recorded images to a PC from a camera.

**■ Fn Button Assigned with [LAN / Wi-Fi]**

You can perform the following operations by pressing the Fn button assigned with [LAN / Wi-Fi] during network connection.

- About Fn buttons (➔ [155 / Register Functions to the Fn Buttons](#))

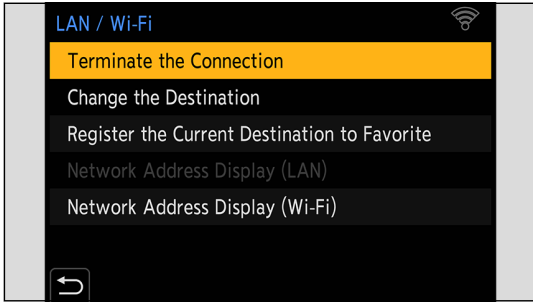

<b>[Terminate the Connection]</b>	Terminates connection.
<b>[Change the Destination]</b>	Terminates connection, and allows you to select a different connection.
<b>[Register the Current Destination to Favorite]</b>	Registers the current connection destination or method so that you can easily connect with the same connection settings next time.
<b>[Network Address Display (LAN)]</b>	Displays the MAC address and IP address of the camera when connected with a LAN cable. (➔ <a href="#">237 / [Network Address Display (LAN)]</a> )
<b>[Network Address Display (Wi-Fi)]</b>	Displays the MAC address and IP address during Wi-Fi connection. (➔ <a href="#">237 / [Network Address Display (Wi-Fi)]</a> )

- Depending on the function being used or the connection destination, you may not be able to perform some of these operations.

- If you turn the camera off without terminating the network connection, when the camera is turned on next, it is automatically reconnected with the previously connected network connection method.
- The camera's Wi-Fi connection, Bluetooth connection, and USB connection cannot be used while supplying power with PoE+.
- Do not insert/remove the card or move to an area without any reception while a connection is being made.
- The camera cannot be used to connect to a public wireless LAN connection.
- We strongly recommend that you set an encryption to maintain information security.
- Images may not be completely sent depending on radio wave conditions. If the connection is terminated while importing images, images with missing parts may be sent.

# Tethered Recording

If you install the “LUMIX Tether” camera control software on your PC, you can connect the camera to the PC and then control the camera from the PC and record while checking the live view on the PC screen (tethered recording). In addition, you can output via HDMI/SDI to an external monitor or TV etc. during tethered recording.

## Installing “LUMIX Tether”

This software is for controlling the camera from a PC. It allows you to change various settings and to record remotely and then save the images to the PC.

Check the following site and then download and install the software:

<https://panasonic.jp/support/global/cs/dsc/>

(English only)

### Operating environment

<b>Supported OS</b>	Windows: Windows 10 64 bit
	Mac: OS X v10.11, macOS 10.12 to macOS 10.15
<b>Interface</b>	USB terminal (SuperSpeed USB (USB3.1), Type-C) LAN terminal Wi-Fi (IEEE 802.11b/g/n)

- Supported OSs are current as of October 2020 and are subject to change.
- To download the software, your PC needs to be able to connect to the internet.
- Downloading may take a while depending on the communication environment.
- For how to operate the software, refer to the operation guide for “LUMIX Tether”.

## Operating the Camera from a PC

Connect the camera and PC with a USB connection cable, LAN cable or Wi-Fi.

- When connecting the camera directly to a PC with a USB connection cable or LAN cable, you can connect to “LUMIX Tether” with the default setting. Proceed to step 2. (Operate from step 1 if you change the default setting of [LAN / Wi-Fi] or [USB Mode] in the [Setup] ([IN/OUT]) menu.)
- When connecting with Wi-Fi, output the camera menu screen via HDMI/SDI to an external monitor etc. (→ [27 / Connecting the external monitor](#))

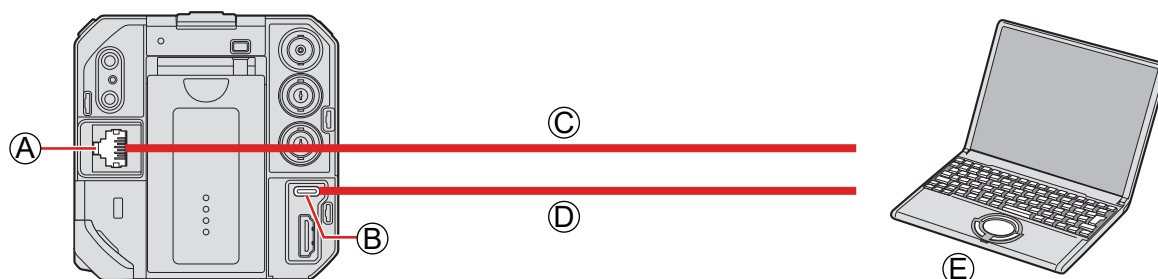

Ⓐ [LAN] terminal

Ⓑ [USB] terminal

Ⓒ LAN cable (commercially available) or Ⓓ USB connection cable (commercially available)

Ⓔ PC (commercially available)

- Plug in/out straight holding onto the plug. (Inserting these at an angle may cause deformation or malfunction)
- Do not connect the cable to the wrong terminals. This may cause a malfunction.

Preparation:

- Turn on the camera and PC.
- Install “LUMIX Tether” on PC.



## 1 (When connecting with a USB connection cable)

Set [USB Mode] to [PC(Tether)].

- [MENU/SET] → [ ] → [ ] → [USB Mode] → [PC(Tether)]

(When connecting with a LAN cable)

Set the camera to DHCP server before setting it to a wired LAN connection setting.

- [MENU/SET] → [ ] → [ ] → [LAN / Wi-Fi] → [LAN / Wi-Fi Setup] → [IP Address Setting (LAN)] → [DHCP Server]
- If you changed the setting of [IP Address Setting (LAN)], turn the camera off and then on again.
- [MENU/SET] → [ ] → [ ] → [LAN / Wi-Fi] → [LAN / Wi-Fi Function] → [New Connection] → [Control With LUMIX Tether] → [LAN]

(When connecting with Wi-Fi)

Set the camera to a Wi-Fi connection setting.

- [MENU/SET] → [ ] → [ ] → [LAN / Wi-Fi] → [LAN / Wi-Fi Function] → [New Connection] → [Control With LUMIX Tether] → [Wi-Fi] → [Via Network] / [Direct]
- For details about [Via Network] and [Direct]. (→ [231 / Wi-Fi Connections](#))
- Proceed to Step 3.

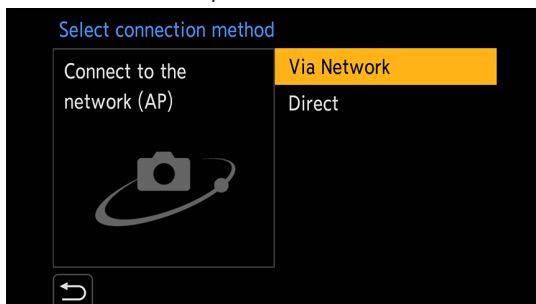

## 2 Connect the camera and PC with the USB connection cable or LAN cable.

- At default setting, the camera is set to DHCP server. By connecting the camera directly to your PC with a LAN cable, you can connect the camera to your PC without manually setting network information such as the IP address.
- When using PoE+ power supply with the camera, connect a PoE+ compatible switching hub and PC with a LAN cable.

## 3 Use “LUMIX Tether” to operate the camera from the PC.

- (When connecting for the first time with a LAN cable or Wi-Fi)  
Set a password to connect to the camera from “LUMIX Tether”. (from 8 to 31 characters)
- A tether icon is displayed in the upper right of the screen during recording standby.

## Terminating the Network Connection

To terminate the network connection between the camera and PC, follow the steps below.

① On the PC, close the “LUMIX Tether”.

② Terminate the network connection.

- [MENU/SET] → [ ] → [ ] → [LAN / Wi-Fi] → [LAN / Wi-Fi Function] → [Yes]
- You can also perform the same operation by pressing the Fn button assigned with [LAN / Wi-Fi]. (→ [206 / Fn Button Assigned with \[LAN / Wi-Fi\]](#))

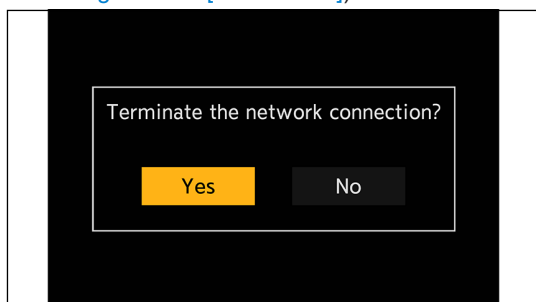

- For the USB connection cable, use one that is a shielded product with a ferrite core compliant to USB Type C (USB3.1) that is less than 1.5 m (4.9 feet).
- For the cable that connects to the LAN terminal, use the one below.
  - LAN cable (STP (Shielded Twisted Pair), category 5e or above, maximum 100 m (328 feet))
- If the camera is connected to PC using both of LAN cable and USB connection cable, the USB connection cable will be prioritized.
- Wi-Fi/Bluetooth function cannot be used while the connection is being made using a USB connection cable or LAN cable.
- When you use [Reset] in the [Setup] ([Setting]) menu to reset the network settings, the password to connect to the camera from “LUMIX Tether” will also be reset.
- The camera cannot be connected to “LUMIX Tether” and “LUMIX Sync” at the same time.

## Operating multiple cameras

You can operate multiple cameras remotely using “LUMIX Tether”.

The connecting method differs depends on whether you set the camera to a setting for DHCP server or DHCP client to connect.

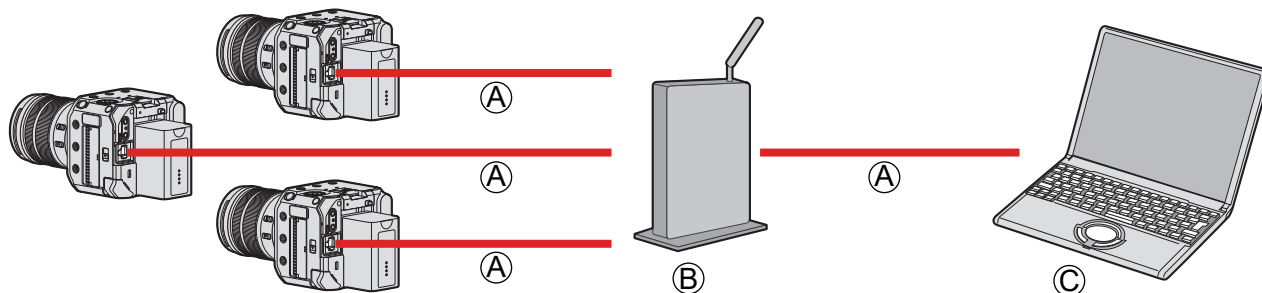

(A) LAN cable (commercially available)

(B) Router (commercially available)

(C) PC (commercially available)

Example: When the DHCP server is within the LAN and the camera is set to DHCP client to connect.

### 1 Set the camera to a DHCP client.

- [MENU/SET] → [ ] → [ ] → [LAN / Wi-Fi] → [LAN / Wi-Fi Setup] → [IP Address Setting (LAN)] → [DHCP Client]
- If you changed the setting of [IP Address Setting (LAN)], turn the camera off and then on again.

### 2 Connect all cameras and the router with LAN cables.

### 3 Connect the router and PC with a LAN cable.

### 4 Operate “LUMIX Tether” to operate the camera remotely.

- When Tethered recording using several cameras, it is recommended to set an individual device name for each camera:  
[ ] → [ ] → [Device Name]

## Tether Connection Mode

You can set the camera to tether connection mode by operating the camera remotely from “LUMIX Tether”.

If you set the camera to tether connection mode when it is not recording, it enters a connection standby state for LUMIX Tether while maintaining the connection between the camera and PC, and it can quickly return to a state where remote shooting is possible.

- The status indicator lights up (orange) during tether connection mode.
- For how to operate the software, refer to the operation guide for “LUMIX Tether”.

## Taking a still picture

You can take still pictures by operating the camera remotely from the operation panel of “LUMIX Tether”.

- When you are recording still pictures you can use the functions which are not available during video recording.
- The functions for still pictures are not displayed on the menu screen.
- The setting items differ from those during video recording.

Example)

<b>Recording mode</b>	[P] / [A] / [S] / [M]
<b>Shutter speed (sec.)</b>	1 to 1/16000
<b>Exposure Compensation</b>	[±5EV] <ul style="list-style-type: none"> <li>• When the exposure compensation value falls below or exceeds ±3 EV, the brightness of the recording screen will no longer change.</li> </ul>
<b>Picture quality</b>	JPEG (FINE / STD.)
<b>Picture size</b>	[L] / [M] / [S]
<b>Image Stabilizer</b>	[Panning]
<b>1 shot AF</b>	Available

- The following settings are fixed:
  - [Aspect Ratio]: [4:3]
  - [Photo Style]: [Standard]
- [P] / [A] / [S] / [M] mode can be used only during Tether recording.  
After finishing Tether recording, select [Creative Video Mode] in [Rec Mode].
- For how to operate the software, refer to the operation guide for “LUMIX Tether”.

# Connecting to a Smartphone

Use the smartphone app “Panasonic LUMIX Sync” (hereafter “LUMIX Sync”) for remote recording and image transfers.

## Flow of connecting a smartphone

- When performing connection setting, output the camera menu screen via HDMI/SDI to an external monitor etc. (➔ [27 / Connecting the external monitor](#))

### 1 Install “LUMIX Sync” on your smartphone. (➔ [214 / Installing “LUMIX Sync”](#))

### 2 Connect to a smartphone.

When connecting a smartphone that supports Bluetooth Low Energy and the camera via Bluetooth.

- **Bluetooth connection** (➔ [215 / Connecting to a Smartphone \(Bluetooth Connection\)](#))

When connecting a smartphone that does not support Bluetooth Low Energy and the camera via Wi-Fi.

- **Wi-Fi connection** (➔ [218 / Connecting to a Smartphone \(Wi-Fi connection\)](#))

When connecting the camera to the wireless access point which the smartphone is connected to with a wired LAN.

- **Wired LAN connection** (➔ [223 / Connecting to a Smartphone \(Wired LAN connection\)](#))

### 3 Operate the camera using the smartphone. (➔ [225 / Operating the Camera with a Smartphone](#))

- [Remote shooting]
- [Shutter Remote Control]
- [Import images]
- [Location Logging]
- [Remote Wakeup]
- [Auto Clock Set]
- [Camera settings copy]

## Installing “LUMIX Sync”

“LUMIX Sync” is an application for smartphones provided by Panasonic.

### Supported OS

Android™: Android 5 or higher

iOS: iOS 11 or higher

- 1** Connect the smartphone to a network.
- 2** (Android) Select “Google Play™ Store”.  
(iOS) Select “App Store”.
- 3** Enter “Panasonic LUMIX Sync” or “LUMIX” into the search box.
- 4** Select and install the “Panasonic LUMIX Sync” .

- Use the latest version.
- Supported OSs are current as of October 2020 and are subject to change.
- Read the [Help] in the “LUMIX Sync” menu for further details on how to operate.
- The camera cannot be connected to “LUMIX Tether” and “LUMIX Sync” at the same time.
- When the recording mode is [P] / [A] / [S] / [M], you cannot connect to “LUMIX Sync”.  
Select [Creative Video Mode] in [Rec Mode] of the recording mode menu.
- The app may not operate correctly depending on your smartphone.  
For information on the “LUMIX Sync”, refer to the following support site:  
<https://panasonic.jp/support/global/cs/dsc/>  
(English only)

## Connecting to a Smartphone (Bluetooth Connection)

Follow a simple connection setup procedure (pairing) to connect to a smartphone that supports Bluetooth Low Energy. When pairing is set up, the Wi-Fi connection will be established automatically by just operating “LUMIX Sync”.

- For the first-time connection, pairing settings are required. For information about connecting for the second time onwards (→ 217 / [Connecting to a Paired Smartphone](#))

- Supported smartphones  
Android™: Android 5 or higher with Bluetooth 4.0 or higher (excluding those that do not support Bluetooth Low Energy)  
iOS: iOS 11 or higher
- Turn on the smartphone's Bluetooth function in advance.

### 1 On the smartphone, start up “LUMIX Sync”.

- A message regarding device (camera) registration is displayed. Select [Next].
- If you have closed the message, select [?], then register the camera using [Camera registration (pairing)].

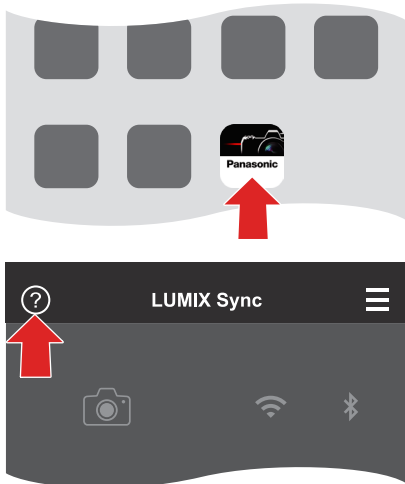

### 2 Check the content in the displayed guide and select [Next] until the screen to register the camera is displayed.

Operating the camera in accordance with the smartphone guide.

### 3 Set the camera to Bluetooth pairing standby state.

- [MENU/SET] → [ ] → [Bluetooth] → [Bluetooth] → [SET] → [Pairing]
- The camera enters pairing standby state and the device name (A) is displayed.



#### 4 On the smartphone, select the camera's device name.

- (iOS devices) When a message to confirm the change of destination is displayed, select [Join].

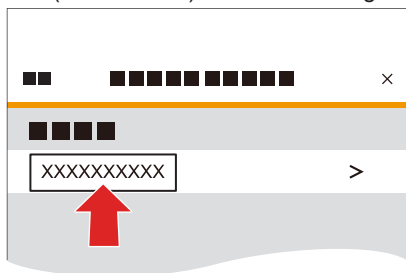

#### 5 When a message indicating that device registration is complete, select [OK].

- A Bluetooth connection between the camera and the smartphone will be made.

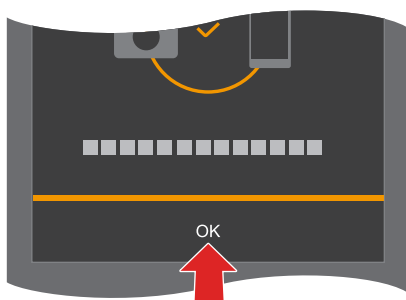

- The paired smartphone is registered as a paired device.
- During Bluetooth connection, [📶] is displayed in the recording screen. When the Bluetooth function is enabled, but a connection is not established with the smartphone, [📶] appears translucent.
- Up to 16 smartphones can be registered. If you try to register more than 16 smartphones, the registration information will be deleted from the oldest first.

### Wi-Fi connection with a Bluetooth connected smartphone

You can establish Wi-Fi connection by operating "LUMIX Sync".

- 1 Select [📶] ([Remote shooting]) or [📷] ([Import images]) in the "LUMIX Sync" home screen.
  - During Wi-Fi connection, [📶] is displayed on the recording screen.



## End Bluetooth Connection

To terminate the Bluetooth connection, turn off the Bluetooth function of the camera.

[MENU/SET] → [🔧] → [📶] → [Bluetooth] → [Bluetooth] → Select [OFF]

- Even if you terminate the connection, the pairing information for it will not be deleted.

## Connecting to a Paired Smartphone

Connect paired smartphones using the following procedure.

- 1 **Enable the Bluetooth function of the camera.**
  - [MENU/SET] → [🔧] → [📶] → [Bluetooth] → [Bluetooth] → [ON]
- 2 **On the smartphone, start up “LUMIX Sync”.**
  - If a message is displayed indicating that the smartphone is searching for cameras, close the message.
- 3 **Select [☰].**
- 4 **Select [Bluetooth Setup].**

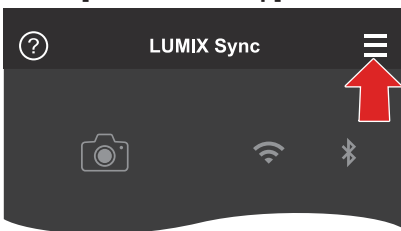

- 5 **Turn Bluetooth ON.**

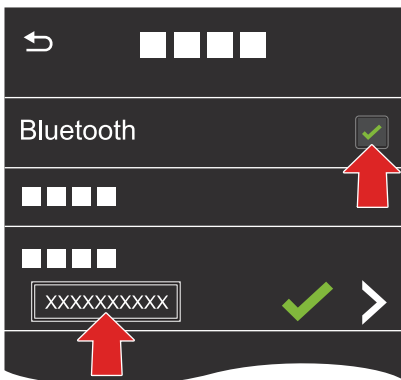

- 6 **From [Camera registered] items, select the camera's device name.**

- Even if you set up pairing with more than one smartphone, you can only connect to one smartphone at a time.
- When pairing takes some time, canceling the pairing settings on both the smartphone and camera and re-establishing the connection may result in the camera being detected correctly.

## Canceling Pairing

- ❶ **Cancel the pairing setting of the camera.**
  - [MENU/SET] → [Fn] → [Wi-Fi] → [Bluetooth] → [Bluetooth] → [SET] → [Delete]
- ❷ **Select the smartphone for which to cancel the pairing.**

- Also cancel the pairing setting on the smartphone.
- When [Reset] in the [Setup] ([Setting]) menu is used to reset the network settings, the information for registered devices is deleted.

## Connecting to a Smartphone (Wi-Fi connection)

Use Wi-Fi to connect the camera and a smartphone. With default settings, simple connection with smartphones is possible without entering a password. You can also use password authentication for enhanced connection security.

### 1 Set the camera to Wi-Fi connection standby status.

- [MENU/SET] → [Fn] → [Wi-Fi] → [LAN / Wi-Fi] → [LAN / Wi-Fi Function] → [New Connection] → [Control With Smartphone] → [Wi-Fi]
- The SSID **A** of the camera is displayed on the screen.

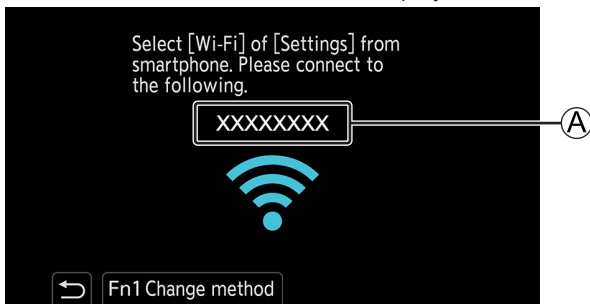

### 2 In the setting menu of the smartphone, turn the Wi-Fi function ON.

### 3 Select the SSID displayed on the screen of the output destination.

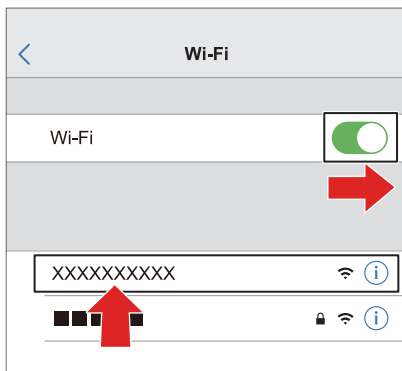

#### 4 On the smartphone, start up “LUMIX Sync”.

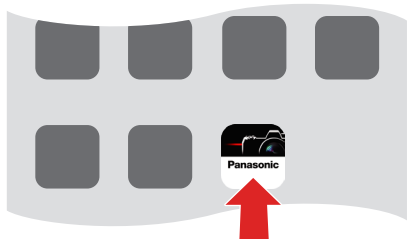

#### 5 (At the first connection)

Confirm the device name displayed on the screen of the output destination and then select [Yes].



- When a device different than the one you want to connect to is displayed, the camera will automatically connect to that device if you select [Yes]. If there are other Wi-Fi connection devices nearby, we recommend using either QR code or manual password input to connect with password authentication. (➔ [220 / Using Password Authentication to Connect](#))

## Using Password Authentication to Connect

You can enhance Wi-Fi connection security by using password authentication through either QR code or manual input.

### ■ Scanning QR code to connect

- ① **Set [Wi-Fi Password] on the camera to [ON].**
  - [MENU/SET] → [🔍] → [📶] → [LAN / Wi-Fi] → [LAN / Wi-Fi Setup] → [Wi-Fi Password] → [ON]
- ② **Display the QR code (A).**
  - [MENU/SET] → [🔍] → [📶] → [LAN / Wi-Fi] → [LAN / Wi-Fi Function] → [New Connection] → [Control With Smartphone] → [Wi-Fi]
  - Press [MENU/SET] to enlarge the QR code.

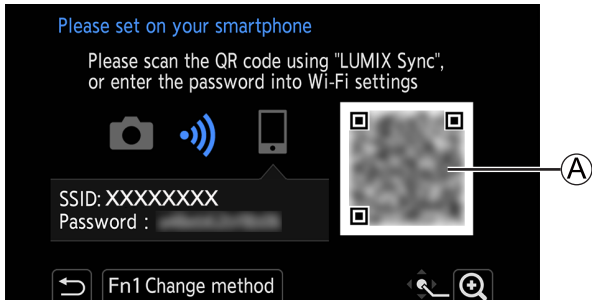

- ③ **On the smartphone, start up “LUMIX Sync”.**
  - If a message is displayed indicating that the smartphone is searching for cameras, close the message.
- ④ **Select [☰].**
- ⑤ **Select [Wi-Fi connection].**
- ⑥ **Select [QR code].**
- ⑦ **Scan the QR code displayed on the screen of the output destination using “LUMIX Sync”.**
  - (iOS devices) When a message to confirm the change of destination is displayed, select [Join].
- ⑧ **(At the first connection) Confirm the device name displayed on the screen of the output destination and then select [Yes].**



### Manually entering a password to connect

- 1 Display the screen in Step 2 of “Scanning QR code to connect”. (→ 220 / Scanning QR code to connect)
- 2 In the setting menu of the smartphone, turn the Wi-Fi function ON.

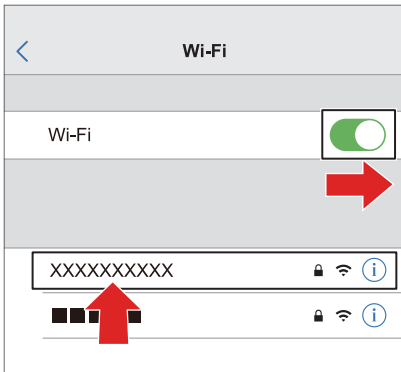

- 3 On the Wi-Fi setup screen, select the SSID **B** displayed on the screen of the output destination.

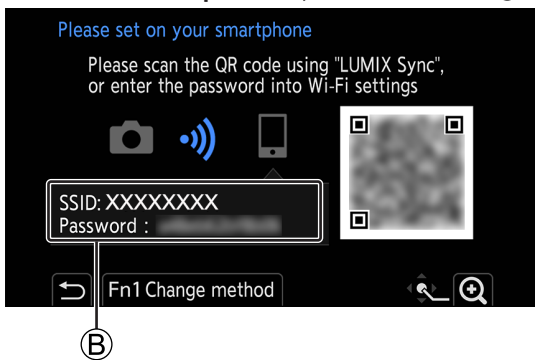

- 4 (At the first connection) Enter the password **B** displayed on the screen of the output destination.
- 5 On the smartphone, start up “LUMIX Sync”.
- 6 (At the first connection) Confirm the device name displayed on the screen of the output destination and then select [Yes].



## Connection Methods Other Than the Default Settings

When connecting with [Via Network], or [WPS Connection] in [Direct], follow the steps below:

### ❶ Display the connection method setting screen for the camera.

- [MENU/SET] → [Fn] → [Wi-Fi] → [LAN / Wi-Fi] → [LAN / Wi-Fi Function] → [New Connection] → [Control With Smartphone] → [Wi-Fi]

### ❷ Press [Fn1].

#### ■ Connecting via network

- 1 Select [Via Network] and then press [MENU/SET].
  - Connect the camera to a wireless access point. (➔ 231 / [Via Network])
- 2 In the setting menu of the smartphone, turn the Wi-Fi function ON.
- 3 Connect the smartphone to the wireless access point that the camera is connected to.
- 4 On the smartphone, start up "LUMIX Sync".

#### ■ Connecting directly

- 1 Select [Direct] and then press [MENU/SET].
  - Select [WPS Connection] to connect the camera to a smartphone. (➔ 234 / [Direct])
- 2 On the smartphone, start up "LUMIX Sync".

## Terminating the Wi-Fi Connection

To end the Wi-Fi connection between the camera and smartphone, follow the steps below.

### 1 Set the camera to recording mode.

### 2 Terminate the Wi-Fi connection.

- [MENU/SET] → [Fn] → [Wi-Fi] → [LAN / Wi-Fi] → [LAN / Wi-Fi Function] → [Yes]
- You can also perform the same operation by pressing the Fn button assigned with [LAN / Wi-Fi]. (➔ 206 / Fn Button Assigned with [LAN / Wi-Fi])

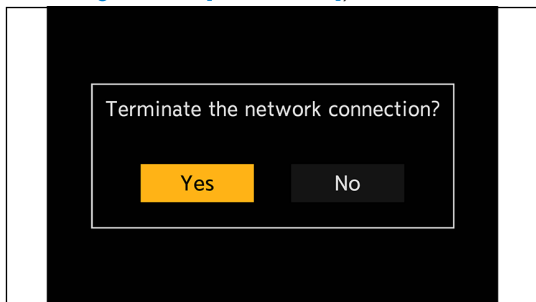

### 3 On the smartphone, close the "LUMIX Sync".

## Connecting to a Smartphone (Wired LAN connection)

Connect the camera to the smartphone by connecting it to a wireless access point to which the smartphone is connected with a LAN cable.

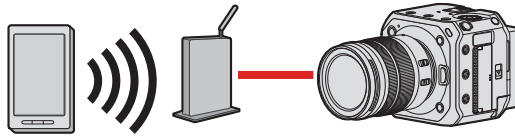

Preparation:

- Connect a smartphone to a wireless access point.

### 1 Set the camera to a DHCP client.

- [MENU/SET] → [F] → [Wi-Fi] → [LAN / Wi-Fi] → [LAN / Wi-Fi Setup] → [IP Address Setting (LAN)] → [DHCP Client]
- If you changed the setting of [IP Address Setting (LAN)], turn the camera off and then on again.

### 2 Set the camera to a wired LAN connection setting.

- [MENU/SET] → [F] → [Wi-Fi] → [LAN / Wi-Fi] → [LAN / Wi-Fi Function] → [New Connection] → [Control With Smartphone] → [LAN]

### 3 Insert a LAN cable to the camera's [LAN] terminal and connect it to the wireless access point.

### 4 On the smartphone, start up "LUMIX Sync".

### 5 (At the first connection)

Confirm the device name displayed on the screen of the output destination and then select [Yes].

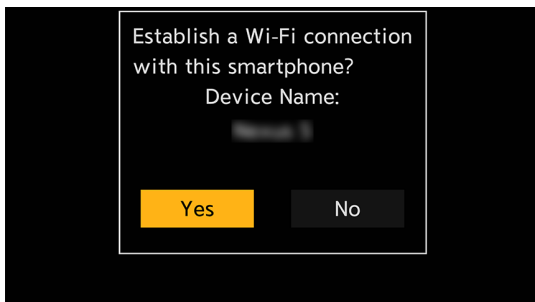

## Terminating the Wired LAN Connection

To end the connection between the camera and smartphone, follow the steps below.

❶ Set the camera to recording mode.

❷ Terminate the wired LAN connection.

- [MENU/SET] → [ ] → [ ] → [LAN / Wi-Fi] → [LAN / Wi-Fi Function] → [Yes]
- You can also perform the same operation by pressing the Fn button assigned with [LAN / Wi-Fi]. (→ [206 / Fn Button Assigned with \[LAN / Wi-Fi\]](#))

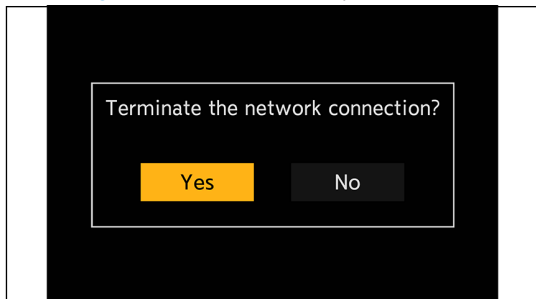

❸ On the smartphone, close the “LUMIX Sync”.

- For the cable that connects to the LAN terminal, use the one below.
  - LAN cable (STP (Shielded Twisted Pair), category 5e or above, maximum 100 m (328 feet))
- Also refer to the operating instructions for the wireless access point.



# Operating the Camera with a Smartphone

This explains the functions for operating the camera from a smartphone. Functions described in this document with the **(Bluetooth)** symbol require a Bluetooth connection by a smartphone that supports Bluetooth Low Energy.

## Getting started

- Connect the camera to a smartphone. (➔ 213 / [Connecting to a Smartphone](#))
- On the smartphone, start up “LUMIX Sync”.

### ■ Home Screen

When you start up “LUMIX Sync”, the home screen is displayed.

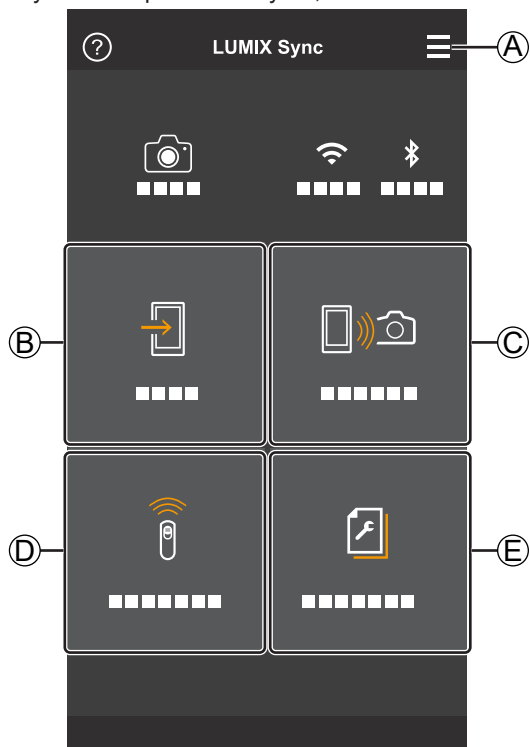

#### App settings

This allows connection settings, camera ON/OFF operations, and displays Help.



[Import images] (➔ 227 / [\[Import images\]](#))



[Remote shooting] (➔ 226 / [\[Remote shooting\]](#))



[Shutter Remote Control] (➔ 226 / [\[Shutter Remote Control\]](#))



[Camera settings copy] (➔ 230 / [\[Camera settings copy\]](#))

## [Remote shooting]

You can use the smartphone to record from a remote location while viewing the live view images from the camera.



### 1 Select [📱📷] ([Remote shooting]) in the home screen.

- (iOS devices) When a message to confirm the change of destination is displayed, select [Join].

### 2 Start recording.

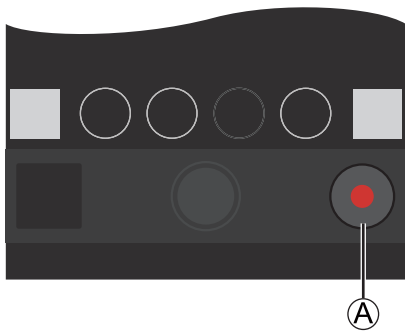

Ⓐ Starts / ends the video recording

- The recorded image is saved on the camera.
- Certain features, including some settings, may not be available.

## [Shutter Remote Control]

### Bluetooth

You can use the smartphone as a remote control for the shutter.

### 1 Select [📱📷] ([Shutter Remote Control]) in the home screen.

### 2 Start recording.

 Starts / ends the video recording

- The recorded image is saved on the camera.
- [Shutter Remote Control] is not available when connected to Wi-Fi or wired LAN.

## [Import images]

Transfer an image stored on the card to the smartphone.

### 1 Select [📷] ([Import images]) in the home screen.

- (iOS devices) When a message to confirm the change of destination is displayed, select [Join].

### 2 Select the image to transfer.

- You can switch the card displayed by touching (A).

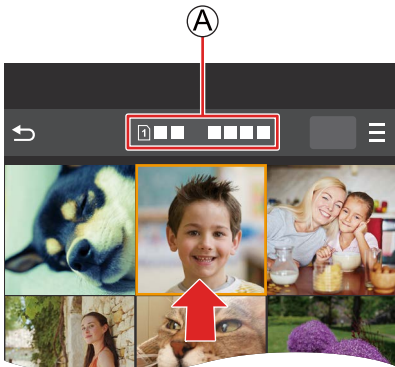

### 3 Transfer the image.

- Select [📷].
- If the image is a video, you can play it back by touching [▶] at the center of the screen.

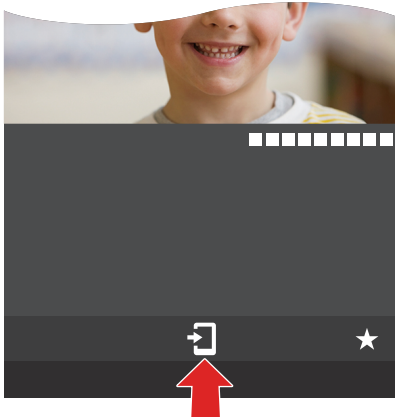

- When a video is played back, this has a small data size and is transmitted using “LUMIX Sync”, therefore its image quality will differ from that of the actual video recording. Depending on the smartphone and on the usage conditions, the image quality may deteriorate or the sound may skip during video playback.
- Files larger than 4 GB cannot be sent.
- Images recorded using the following functions cannot be transferred:
  - [MOV] videos

## [Location Logging]

### Bluetooth

The smartphone sends its location information to the camera via Bluetooth, and the camera performs recording while writing the acquired location information.

Preparation:

- Enable the GPS function on the smartphone.

## 1 Enable [Location Logging] on the camera.

- [MENU/SET] → [🔍] → [📶] → [Bluetooth] → [Location Logging] → [ON]
- The camera will enter a mode where location information can be recorded and [GPS] is displayed in the recording screen.

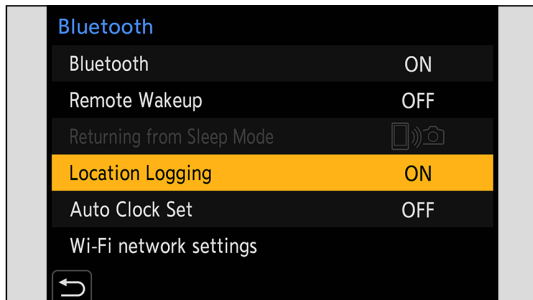

## 2 Record images with the camera.

- Location information will be written to the recorded images.

- When [GPS] on the recording screen appears translucent, location information cannot be acquired, therefore data cannot be written. Smartphone GPS positioning may not be possible if the smartphone is within a building, a bag, or something similar. Move the smartphone to a position affording a wide view of the sky to improve positioning performance. Also refer to the operating instructions of your smartphone.
- Images with location information are indicated with [GPS].
- Be sure to pay special attention to the privacy, and portrait rights, etc. of the subject when you use this function. Use at your own risk.
- The smartphone drains its battery faster while acquiring location information.
- [Location Logging] is not available when connected with a LAN cable.

## [Remote Wakeup]

### Bluetooth

Even when the camera is turned off, the smartphone can be used to start the camera and record images, or check the recorded images.

Preparation:

**1 Enable [Remote Wakeup] on the camera.**

- [MENU/SET] → [🔧] → [📶] → [Bluetooth] → [Remote Wakeup] → [ON]

- [Remote Wakeup] is not available when connected with a LAN cable.

## Turning Off the Camera

**1 Select [📷] ([Remote shooting]) or [📷] ([Import images]) in the “LUMIX Sync” home screen.**

**2 Select [☰] in the “LUMIX Sync” home screen.**

**3 Select [Turn off the camera].**

- [Turn off the camera] is not displayed when it is not connected via Wi-Fi.

**4 Select [Power OFF].**

- When [Remote Wakeup] has been set, since the Bluetooth function continues to work even when the camera is turned off, power is being consumed.
- If you turn off the camera by pressing the camera ON/OFF button on the camera, [Remote Wakeup] will not work.

## Turning On the Camera

**1 Select [📷] ([Remote shooting]) in the “LUMIX Sync” home screen.**

- (iOS devices) When a message to confirm the change of destination is displayed, select [Join].
- The camera turns on, and automatically connects using Wi-Fi.



## Shortening the Return Time when performing [Remote Wakeup]

You can shorten the time it takes to enable the priority function when waking up the camera remotely.

Preparation:

- Set [Remote Wakeup] in [Bluetooth] to [ON].

[MENU/SET] → [🔧] → [📶] → [Bluetooth] → Select [Returning from Sleep Mode]

 [Import / Remote Priority]	Shortens the time to return when using [Import images] or [Remote shooting].
 [Remote Shutter Priority]	Shortens the time to return when using [Shutter Remote Control].

## [Auto Clock Set]

### Bluetooth

Synchronize the clock and the time zone setting of the camera with those of a smartphone.

#### 1 Enable [Auto Clock Set] on the camera.

- [MENU/SET] → [ ] → [Bluetooth] → [Auto Clock Set] → [ON]

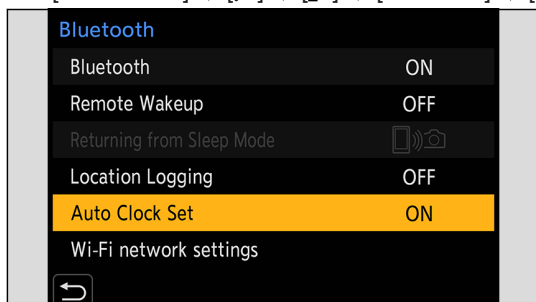

- [Auto Clock Set] is not available when connected with a LAN cable.

## [Camera settings copy]

### Bluetooth

This saves the camera's settings information to the smartphone. Saved settings information can be loaded to the camera, letting you set the same settings on multiple cameras.

#### 1 Select [ ] ([Camera settings copy]) in the "LUMIX Sync" home screen.

#### 2 Save or load settings information.

- Read the [Help] in the "LUMIX Sync" menu for further details on how to operate the "LUMIX Sync".
- Only settings information from the same model can be loaded.
- When transferring settings information, a Wi-Fi connection is automatically created.  
(iOS devices) When a message to confirm the change of destination is displayed, select [Join].
- You can save or load the settings information of items that are the same as those in [Save/Restore Camera Setting] in the [Setup] ([Setting]) menu. (→ [266 / List of Default Settings / Custom Saving / Settings Available for Copying](#))
- [Camera settings copy] is not available when connected with a LAN cable.

# Wi-Fi Connections

- When [Wi-Fi] has been selected in [New Connection] under [LAN / Wi-Fi Function] from [LAN / Wi-Fi] of the [Setup] ([IN/OUT]) menu, select the connection method from either [Via Network] or [Direct] to connect. On the other hand, when you use [Select destination from History(Wi-Fi)] or [Select destination from Favorite(Wi-Fi)], the camera connects to the selected device with the previously-used settings.

## [Via Network]

Connect the camera and an external device through the wireless access point.

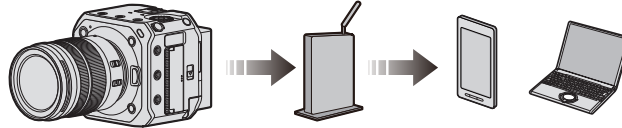

### 1 Select the method for connecting to a wireless access point.

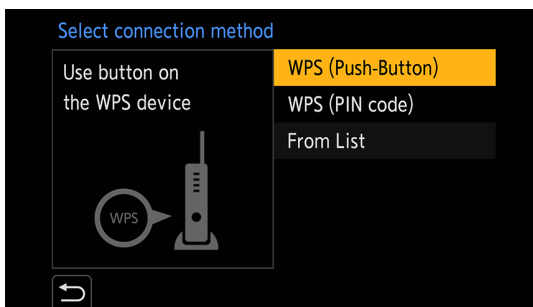

Settings: [WPS (Push-Button)] / [WPS (PIN code)] / [From List]

- After selecting [Via Network] once, the camera will connect to the previously-used wireless access point. To change the wireless access point used for connection, press [Fn1] and change the connection destination.
- Check the operating instructions and settings of the wireless access point.

### ■ [WPS (Push-Button)]

Press the WPS button on the wireless access point to set up a connection.

- ① Press the wireless access point WPS button until it switches to WPS mode.

Example)

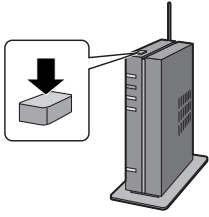

### ■ [WPS (PIN code)]

Enter a PIN code into the wireless access point to set up a connection.

- ① Select the wireless access point you are connecting to.
- ② Enter the PIN code displayed on the screen of the output destination into the wireless access point.
- ③ Press [MENU/SET] on the camera.

### ■ [From List]

Searches for a wireless access point to use, and connects to it.

- Confirm the encryption key of the wireless access point.

- ① Select the wireless access point you are connecting to.
  - Press [Fn1] to run a wireless access point search again.
  - If no wireless access point is found, refer to “Connecting by Manual Input” below.

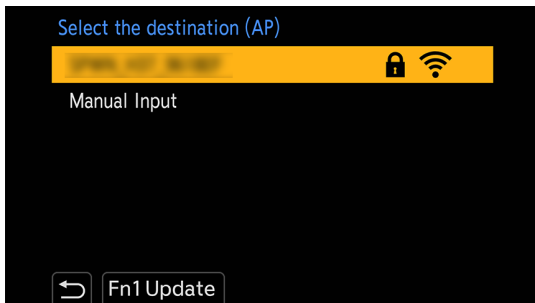

- ② (If network authentication is encrypted)  
Enter the encryption key.



## Connecting by Manual Input

- Check the SSID, network authentication, encryption, and encryption key of the wireless access point you are using.

- 1 In the screen in Step 1 of “[From List]”, select [Manual Input].
- 2 Enter the SSID of the wireless access point you are connecting to, and then select [Set].
  - For information on how to enter characters (➔ [203 / Entering Characters](#))
- 3 Select the network authentication.

[WPA2-PSK]	Supported encryption: [TKIP], [AES]
[WPA2/WPA-PSK]	
[No Encryption]	—

- 4 (When other than [No Encryption] is selected)  
Enter the encryption key and then select [Set].

**[Direct]**

Directly connect the camera and the external device.



# 1 Select the method for connecting with the external device.

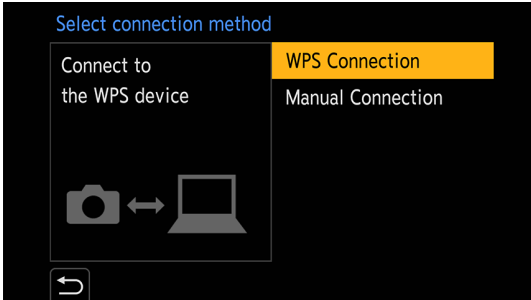

<b>[WPS Connection]</b>	<b>[WPS (Push-Button)]</b> Press the WPS button on the external device to connect. <ul style="list-style-type: none"> <li>On the camera, press [Fn1] to extend the connection wait time.</li> </ul>
	<b>[WPS (PIN code)]</b> Enter the PIN code into the camera, and connect.
<b>[Manual Connection]</b>	Search for the camera on the external device to connect. Enter the SSID and password displayed on the screen of the output destination into the device. <ul style="list-style-type: none"> <li>If the destination is set to smartphone, the password is not displayed. Select the SSID to establish a connection. (➔ <a href="#">218 / Connecting to a Smartphone (Wi-Fi connection)</a>)</li> </ul> <div data-bbox="429 1178 767 1368" data-label="Image">          A screenshot of the manual connection screen. It says "Enter the password" and "Enter the password in the destination device settings". Below this is an icon of a camera and a laptop with a double-headed arrow. There are two input fields: "SSID: XXXXXXXX" and "Password: ". A back arrow is at the bottom left.       </div>

- Also refer to the operating instructions for the device to be connected.
- The name of the camera (SSID) can be changed:  
 [Fn] ➔ [Wi-Fi] ➔ [Device Name] (➔ [197 / \[Device Name\]](#))

## Connect to Wi-Fi Using Previously Saved Settings

Use the Wi-Fi connection history to connect using the same settings as previously.

### 1 Display the Wi-Fi connection history.

- [MENU/SET] → [F7] → [Wi-Fi] → [LAN / Wi-Fi] → [LAN / Wi-Fi Function] → [Select destination from History(Wi-Fi)] / [Select destination from Favorite(Wi-Fi)]

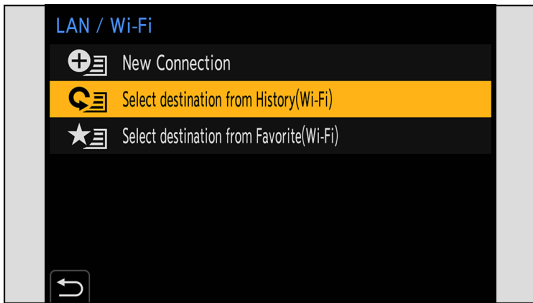

### 2 Select the History item to connect to.

- Press [Fn1] to confirm details of the connection history.

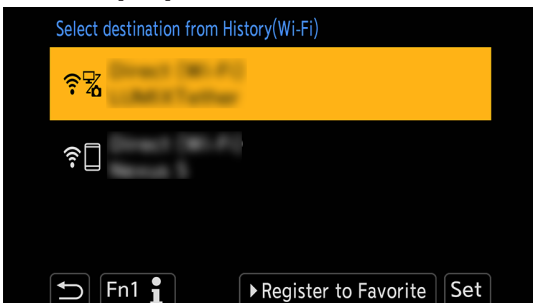

## Register to Favorite

You can register the Wi-Fi connection history to Favorite.

### 1 Display the Wi-Fi connection history.

- [MENU/SET] → [F7] → [Wi-Fi] → [LAN / Wi-Fi] → [LAN / Wi-Fi Function] → [Select destination from History(Wi-Fi)]

### 2 Select the History item to register and then press ▶.

### 3 Enter a registration name and then select [Set].

- For information on how to enter characters (→ [203 / Entering Characters](#))
- A maximum of 30 characters can be entered. A two-byte character is treated as two characters.

## Editing Items Registered in Favorite

### ① Display items registered to Favorite.

- [MENU/SET] → [🔧] → [📶] → [LAN / Wi-Fi] → [LAN / Wi-Fi Function] → [Select destination from Favorite(Wi-Fi)]

### ② Select the History item to edit in Favorite and then press ▶.

[Remove from Favorite]	—
[Change the Order in Favorite]	Specify the destination location of the desired item to change the display order.
[Change the Registered Name]	Enter characters to change the registered name. <ul style="list-style-type: none"> <li>• For information on how to enter characters (➔ <a href="#">203 / Entering Characters</a>)</li> </ul>

- The number of items that can be saved in History is limited. Register frequently-used connection settings to Favorite.
- When [Reset] in the [Setup] ([Setting]) menu is used to reset the network settings, the content registered in History and Favorite is deleted.
- If the device you want to connect to (smartphone, etc.) is connected to a wireless access point other than the camera, you cannot connect the device to the camera using [Direct]. Change the Wi-Fi settings of the device you want to connect to so that the access point to be used is set to the camera. You can also select [New Connection] and reconnect the devices. (➔ [218 / Connecting to a Smartphone \(Wi-Fi connection\)](#))
- It may be difficult to connect to networks to which many devices are connected. In these cases, connect using [New Connection].

# [LAN / Wi-Fi Setup] menu

This configures the settings required for the wired LAN / Wi-Fi function. The settings cannot be changed when connected to wired LAN / Wi-Fi.

## 1 Displaying the [LAN / Wi-Fi Setup] menu.

- [MENU/SET] → [🔧] → [📶] → [LAN / Wi-Fi] → [LAN / Wi-Fi Setup]
- Cannot be set during connection via USB.

[IP Address Setting (LAN)]	<p>Set the IP address for wired LAN connection. You can select whether to automatically assign an IP address using a DHCP or to set any fixed IP address.</p> <p><b>[DHCP Server]:</b> Select this to connect the camera as a DHCP server (default setting).</p> <p><b>[DHCP Client]:</b> Select this to connect the camera as a DHCP client.</p> <p><b>[Static IP Address]:</b> Select this to connect using the IP address set in [Static IP Address Setting].</p> <p><b>[Static IP Address Setting]:</b> You can set IP address used for [Static IP Address]. [IP Address]: The default setting is &lt;192.168.0.2&gt;. [Subnet Mask]: The default setting is &lt;255.255.255.0&gt;. [Default Gateway]: The default setting is &lt;192.168.0.1&gt;.</p> <ul style="list-style-type: none"> <li>• Set the IP address, subnet mask, and default gateway with the correct combination.</li> <li>• For details about DHCP settings or settings of a fixed IP address, contact the administrator of the network you are using.</li> <li>• If you changed the setting of [IP Address Setting (LAN)], turn the camera off and then on again.</li> </ul>
[Wi-Fi Password]	<p>You can use a password to connect for enhanced security. (➔ <a href="#">220 / Using Password Authentication to Connect</a>)</p>
[LAN / Wi-Fi Function Lock]	<p>To prevent incorrect operation and use of the wired LAN / Wi-Fi function by a third party and to protect personal information in the camera and included with images, protect the wired LAN / Wi-Fi function with a password.</p> <p><b>[Setup]:</b> Enter any 4-digit numbers as the password.</p> <ul style="list-style-type: none"> <li>• For information on how to enter characters (➔ <a href="#">203 / Entering Characters</a>)</li> </ul> <p><b>[Cancel]:</b> Cancel the password.</p> <ul style="list-style-type: none"> <li>• Once a password is set, you are required to enter it each time you use the wired LAN / Wi-Fi function.</li> <li>• If you forget your password, you can use [Reset] in the [Setup] ([Setting]) menu to reset the network settings and thereby reset the password.</li> </ul>
[Network Address Display (LAN)]	<p>Displays the MAC address and IP address of the camera during wired LAN connection.</p>
[Network Address Display (Wi-Fi)]	<p>Displays the MAC address and IP address of the camera during Wi-Fi connection.</p>

# 13. Materials

## Optional Accessories

(Product numbers correct as of October 2020.)

<b>Battery Pack</b>	AG-VBR59, AG-VBR89, AG-VBR118
<b>Battery Charger</b>	AG-BRD50
<b>LED Video Light</b>	VW-LED1
<b>Stereo Shotgun Microphone</b>	DMW-MS2
<b>Stereo Microphone</b>	VW-VMS10
<b>XLR Microphone Adaptor</b>	DMW-XLR1
<b>Body cap</b>	DMW-BDC1
<b>Mount Adaptor</b>	DMW-MA1, DMW-MA2M, DMW-MA3R
<b>Tripod adaptor<sup>*1</sup></b>	DMW-TA1

<sup>\*1</sup> Use if the attached lens is in contact with the tripod pedestal.

- Some optional accessories may not be available in some countries.
- For the latest information on optional accessories, refer to our catalogues/web pages, etc.
- (For U.S.A. only)  
To order optional accessories please visit <http://shop.panasonic.com> or your local Photo Specialty Dealer.



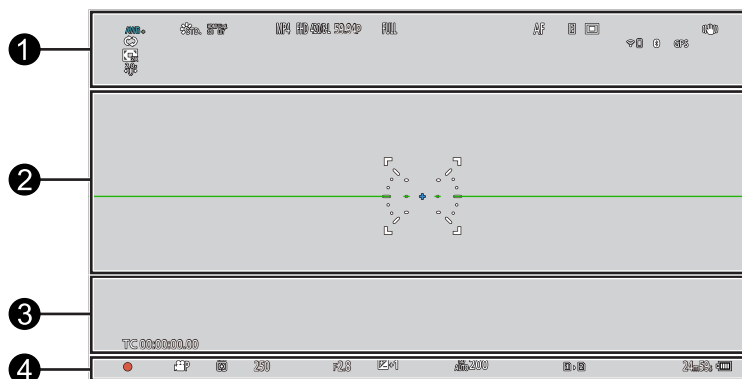

# External Monitor Displays

## Recording Screen







1



AWBc AWBw ☀️ 🏠 ⚙️ 📷	[White Balance] (➔ 91 / <a href="#">White Balance (WB)</a> )
AWB + AWB -	White balance adjustment (➔ 94 / <a href="#">Adjusting the White Balance</a> )
STD.	[Photo Style] (➔ 96 / <a href="#">[Photo Style]</a> )
*EXPS	[Filter Settings] (➔ 101 / <a href="#">[Filter Settings]</a> ) / Filter effect adjustment (➔ 102 / <a href="#">Adjusting the Filter Effect</a> )
HDMI V-LogL SDI LUT	LUT View Assist (➔ 121 / <a href="#">[V-LogL View Assist]</a> )
HDMI HLG SDI MODE2	[HLG View Assist] (➔ 123 / <a href="#">[HLG View Assist]</a> )
MP4 MOV	[Rec. File Format] (➔ 55 / <a href="#">[Rec. File Format]</a> )
FHD 420/8-L	[Rec Quality] (➔ 56 / <a href="#">[Rec Quality]</a> )
59.94p 60/59.94p	Recording frame rate (➔ 56 / <a href="#">[Rec Quality]</a> ) / [Variable Frame Rate] (➔ 112 / <a href="#">[Variable Frame Rate]</a> )
FULL PIXEL PIXEL	[Image Area of Video] (➔ 61 / <a href="#">[Image Area of Video]</a> )
AF MF	[Focus Mode] (➔ 70 / <a href="#">Selecting the Focus Mode</a> , ➔ 79 / <a href="#">Record Using MF</a> )
AFL	AF Lock (➔ 87 / <a href="#">Locking Focus and Exposure (AF/AE Lock)</a> )
P	[Focus Peaking] (➔ 181 / <a href="#">[Focus Peaking]</a> )
👤 📷 📱 📺 📡	[AF Mode] (➔ 73 / <a href="#">Selecting the AF Mode</a> )
📶 📱 📶 📡	Wi-Fi connection status (➔ 205 / <a href="#">Checking operation when connected to a network</a> )
📶 📱 📶 📡	Wired LAN connection status (➔ 205 / <a href="#">Checking operation when connected to a network</a> )
📶 📱 📶 📡	USB connection status ("LUMIX Tether") (➔ 207 / <a href="#">Tethered Recording</a> )
📶	Bluetooth connection status (➔ 205 / <a href="#">Checking operation when connected to a network</a> )
GPS	[Location Logging] (➔ 228 / <a href="#">[Location Logging]</a> )
👤 📷 📱 📺 📡	[Image Stabilizer] (➔ 107 / <a href="#">[Image Stabilizer]</a> )

	Jitter warning
	[Anamorphic Desqueeze Display] (→ 125 / [Anamorphic Desqueeze Display])
	[Loop Recording (video)] (→ 127 / [Loop Recording (video)])
	[Digital Zoom] (→ 84 / [Digital Zoom])

2









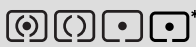

	[Histogram] (→ 188 / [Histogram])
	AF area
	Spot-metering target (→ 85 / [Metering Mode])
	[Center Marker] (→ 190 / [Center Marker])
[Level Gauge] (→ 189 / [Level Gauge])	

3

<b>XXmXXs</b>	Elapsed recording time (→ 52 / <a href="#">Screen Displays While Video Recording</a> )
<b>TC 00:00:00.00</b>	Time code (→ 62 / <a href="#">Time Code</a> )
<b>INT.</b> <b>EXT.</b>	Built-in microphone, External microphone (→ 105 / <a href="#">[Sound Rec Level Disp.]</a> , → 140 / <a href="#">External Microphones (Optional)</a> )
<b>48kHz/16bit</b> <b>XLR</b>	[XLR Mic Adaptor Setting] (→ 142 / <a href="#">XLR Microphone Adaptor (Optional)</a> )
<b>LMT ON</b> <b>LMT OFF</b>	[Sound Rec Level Limiter] (→ 106 / <a href="#">[Sound Rec Level Limiter]</a> )
	Mute (→ 105 / <a href="#">[Mute Sound Input]</a> )
Sound recording level (→ 105 / <a href="#">[Sound Rec Level Disp.]</a> )	
	Temperature rise warning icon (→ 252 / <a href="#">Recording</a> )
	Fan error warning icon (→ 255 / <a href="#">Others</a> )



4

2021.12. 1 10:00:00	[Time Stamp Rec.] (➔ 184 / [Time Stamp Rec.]
	Recording state (lit in red) (➔ 52 / Screen Displays While Video Recording)
	[Exposure Mode] (➔ 53 / [Exposure Mode]), Recording mode (➔ 176 / [Rec Mode] menu (Recording mode))
	[Metering Mode] (➔ 85 / [Metering Mode])
AEL	[AE LOCK] (➔ 87 / Locking Focus and Exposure (AF/AE Lock))
250	Shutter speed
F2.8	Aperture value
	[Exposure Comp.] (➔ 86 / Exposure Compensation)
	Manual exposure assist (➔ 53 / Manual Exposure Assist)
ISO AUTO 200	[Sensitivity] (➔ 88 / ISO Sensitivity) / [Dual Native ISO Setting] (➔ 90 / [Dual Native ISO Setting])
	Card access indication (lit in red) (➔ 52 / Screen Displays While Video Recording)
	Card slot (➔ 30 / Inserting Cards (Optional)) / [Double Card Slot Function] (➔ 34 / [Double Card Slot Function])
	No card
	Card full
XXmXXs	Video recording time (➔ 52 / Screen Displays While Video Recording)
	Battery indication (➔ 24 / Battery indication) Power supply (➔ 21 / Power supply)

■ Control Panel

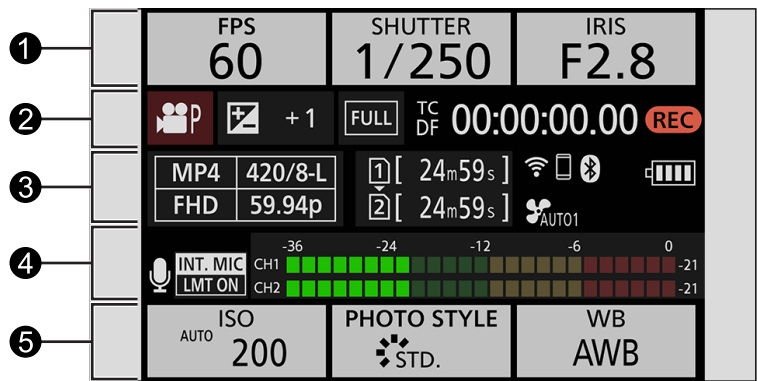

①

FPS 60	Frame rate (➔ 56 / [Rec Quality]) / [Variable Frame Rate] (➔ 112 / [Variable Frame Rate])
SHUTTER 1/250	Shutter speed
IRIS F2.8	Aperture value

②

	[Exposure Mode] (➔ 53 / [Exposure Mode]), Recording mode (➔ 176 / [Rec Mode] menu (Recording mode))
 	Exposure compensation value (➔ 86 / Exposure Compensation) / Manual exposure assist (➔ 53 / Manual Exposure Assist)
FULL	[Image Area of Video] (➔ 61 / [Image Area of Video])
TC DF 00:00:00.00	Time code (➔ 62 / Time Code)
	Recording state (➔ 52 / Screen Displays While Video Recording)

3

	[Rec. File Format] (→ 55 / [Rec. File Format]) / [Rec Quality] (→ 56 / [Rec Quality])
	Card slot (→ 30 / [Inserting Cards (Optional)]) / [Double Card Slot Function] (→ 34 / [Double Card Slot Function])
24m59s	Video recording time (→ 52 / [Screen Displays While Video Recording])
	Wi-Fi connection status (→ 205 / [Checking operation when connected to a network])
	Wired LAN connection status (→ 205 / [Checking operation when connected to a network])
	USB connection status (“LUMIX Tether”) (→ 207 / [Tethered Recording])
	Bluetooth connection status (→ 205 / [Checking operation when connected to a network])
	[Fan Mode] (→ 192 / [Fan Mode])
	Battery indication (→ 24 / [Battery indication]) Power supply (→ 21 / [Power supply])

4

	Built-in microphone, External microphone (→ 105 / [Sound Rec Level Disp.], → 140 / [External Microphones (Optional)])
	[XLR Mic Adaptor Setting] (→ 142 / [XLR Microphone Adaptor (Optional)])
	[Sound Rec Level Limiter] (→ 106 / [Sound Rec Level Limiter])
	Mute (→ 105 / [Mute Sound Input])
Sound recording level (→ 105 / [Sound Rec Level Disp.]	

5

	[Sensitivity] (→ 88 / [ISO Sensitivity]) / [Dual Native ISO Setting] (→ 90 / [Dual Native ISO Setting])
	[Photo Style] (→ 96 / [Photo Style])
	LUT View Assist (→ 121 / [V-LogL View Assist]) / [HLG View Assist] (→ 123 / [HLG View Assist])
	[White Balance] (→ 91 / [White Balance (WB)])

# Playback Screen

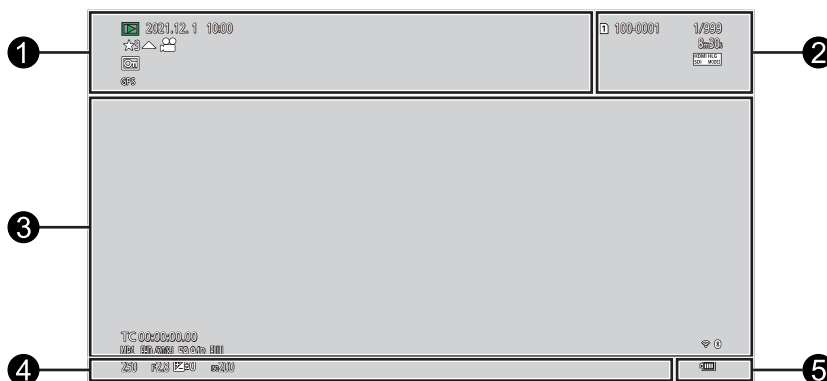



**1**

2021.12.1 10:00:00	Recording date and time (➔ 35 / Clock Set)
★3	[Rating] (➔ 200 / [Rating])
▲ 👤	Video playback (➔ 148 / Playing Back Videos)
📁	[Segmented File Recording] (➔ 128 / [Segmented File Recording])
🔒	[Protect] (➔ 200 / [Protect])
GPS	[Location Logging] (➔ 228 / [Location Logging])
📶	Obtaining information
XXmXXs	Elapsed playback time (➔ 148 / Playing Back Videos)

**2**

1 2	Card slot (➔ 30 / Inserting Cards (Optional))
100-0001	Folder/file number (➔ 147 / Folder Structure Inside Card)
1/999	Image number/Total number of images
9 files	Number of group images/Number of files (➔ 152 / Group Images)
XXmXXs	Video recording time (➔ 148 / Playing Back Videos)
▶ XXmXXs 👤 XXs	[Variable Frame Rate] (➔ 112 / [Variable Frame Rate])
↻ XXmXXs	[Loop Recording (video)] (➔ 127 / [Loop Recording (video)])
HDMI V-LogL SDI LUT	LUT View Assist (➔ 121 / [V-LogL View Assist])
HDMI HLG SDI MODE2	[HLG View Assist] (➔ 123 / [HLG View Assist])



3

	Group images (➔ <a href="#">152 / Group Images</a> )
TC 00:00:00.00	Time code (➔ <a href="#">62 / Time Code</a> )
48kHz/16bit 	[XLR Mic Adaptor Setting] (➔ <a href="#">142 / XLR Microphone Adaptor (Optional)</a> )
MP4 MOV	[Rec. File Format] (➔ <a href="#">55 / [Rec. File Format]</a> )
FHD 420/8-L	[Rec Quality] (➔ <a href="#">56 / [Rec Quality]</a> )
59.94p 60/59.94p	Frame rate (➔ <a href="#">56 / [Rec Quality]</a> ) / [Variable Frame Rate] (➔ <a href="#">112 / [Variable Frame Rate]</a> )
FULL <small>PIXEL</small> <small>PIXEL</small>	[Image Area of Video] (➔ <a href="#">61 / [Image Area of Video]</a> )
	Wi-Fi/Bluetooth connection status (➔ <a href="#">205 / Checking operation when connected to a network</a> )

4

Recording information

5

  AC 	Battery indication (➔ <a href="#">24 / Battery indication</a> ) Power supply (➔ <a href="#">21 / Power supply</a> )
---	--

■ Detailed information display screen

- ① Card slot (➔ 30 / Inserting Cards (Optional))
- ② Recording date and time (➔ 35 / Clock Set)
- ③ Folder/file number (➔ 147 / Folder Structure Inside Card)
- ④ Recording information (basic)
- ⑤ Recording information (advanced)

Detailed information display

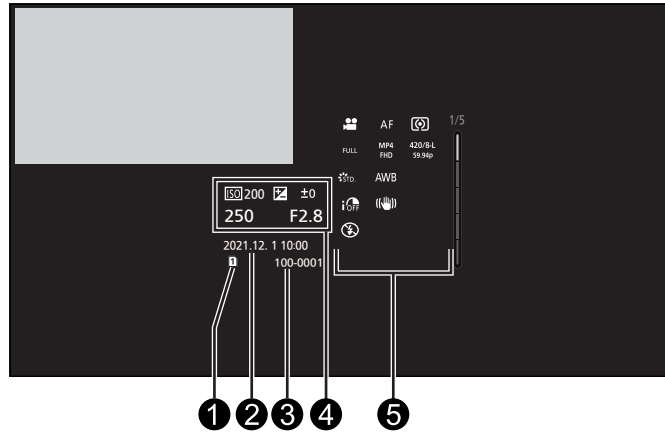

Histogram display

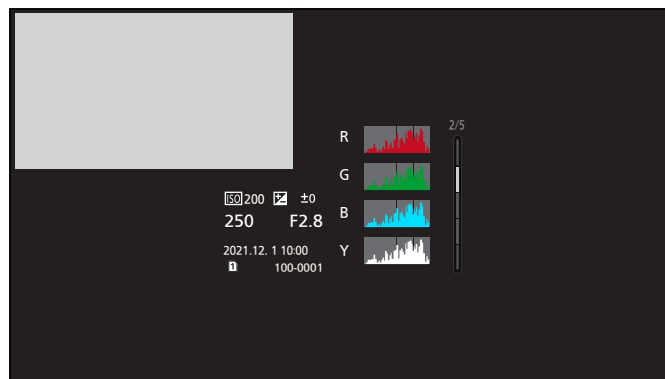
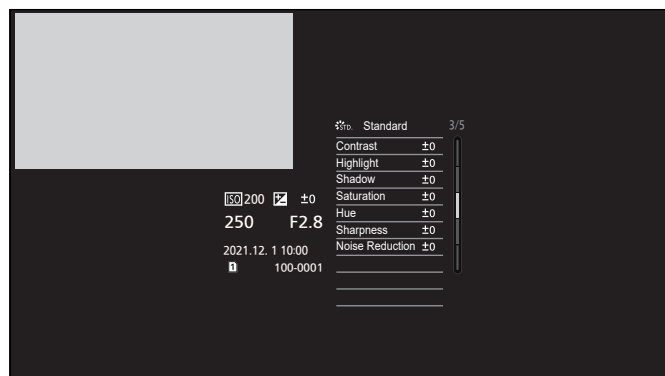
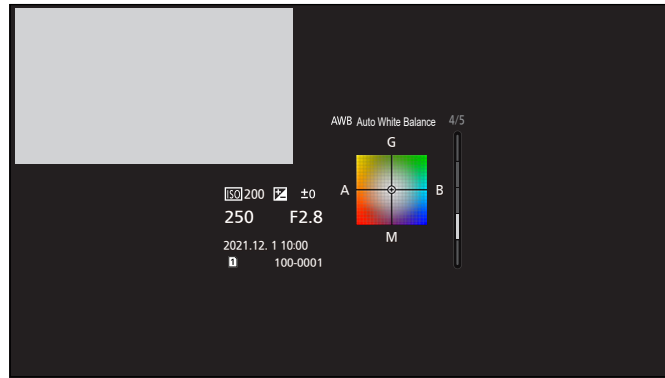

Photo Style display



White balance display



Lens information display



# Lamp / Indicator Display

Shows the status of the camera with the lamp/indicator.

## ■ Status indicator (Green / Orange)

<b>Lights up (Green)</b>	The camera is turned on.
<b>Lights up (Orange)</b>	Tether connect mode (➔ <a href="#">212 / Tether Connection Mode</a> )
<b>Blinks (Green, once/sec.)</b>	(When using PoE+ power supply.) Determining PoE+. (➔ <a href="#">22 / Supplying power from a PoE+ power supply</a> )  (When using battery.) Low battery (It blinks in orange when in Tether connect mode.)
<b>Blinks (Green, 4 times/sec.)</b>	(When using PoE+ power supply.) Insufficient power supply capacity  (When using battery.) The camera is turned off forcibly due to low battery. (It blinks in orange when in Tether connect mode.)
<b>Blinks (alternately green and orange)</b>	System error (Turn off the camera and then on again.)
<b>Off</b>	The camera is turned off.

## ■ Front tally lamp / Rear tally lamp (Red)

<b>Lights up</b>	During video recording. (or sending data to external devices)
<b>Blinks (Red, once/sec.)</b>	Low battery and card capacity.
<b>Blinks (Red, 4 times/sec.)</b>	Stops recording forcibly due to low battery and card capacity.

## ■ [NETWORK] connection lamp (Blue)

<b>Lights up</b>	After being connected with a LAN cable. When Wi-Fi/Bluetooth function is ON or connected.
<b>Blinks</b>	When sending Tether recorded images to a PC from a camera.

- When the power is turned off and [Remote Wakeup] is set to [ON], the [NETWORK] connection lamp turns off even if the Bluetooth function is working.



# Message Displays

Meanings of main messages and response methods.

## Card

### [Memory Card Error] / [Format this card?]

- It is a format that cannot be used with the camera. Either insert another card, or back up any necessary data before formatting. (➔ [32 / Formatting Cards \(Initialization\)](#))

### [Memory Card Error] / [This memory card cannot be used]

- Use a card compatible with the camera. (➔ [16 / Memory Cards That Can Be Used](#))

### [Insert memory card again.] / [Try another card]

- Unable to access the card. Reinsert the card.
- Insert a different card.

### [Read Error] / [Write Error] / [Please check the card]

- Failure to read or write data. Turn off the camera, reinsert the card, and then turn it on again.
- The card may be broken.
- Insert a different card.

### [Recording was cancelled due to the limitation of the writing speed of the card]

- Insufficient card write speed. Use a card of a supported Speed Class. (➔ [16 / Memory Cards That Can Be Used](#))
- If the recording stops even when you are using a card that meets the specified Speed Class rating, the data writing speed of the card is getting slow. We recommend backing up data, and formatting. (➔ [32 / Formatting Cards \(Initialization\)](#))

## Lens

### [The lens is not attached properly. Do not push lens release button while lens is attached.]

- Remove the lens once, and then attach it again without pressing the lens release button. (➔ [25 / Attaching a Lens](#))  
Turn on the camera again, and if it is still displaying, contact the dealer.

### [Lens attachment failed. Please make sure the lens is attached correctly.]

- Remove the lens from the camera body and gently wipe the contacts on the lens and the camera body using a dry cotton swab. Attach the lens, turn on the camera again, and if it is still displaying, contact the dealer.

## Others

**[Some pictures cannot be deleted] / [This picture cannot be deleted]**

- Images that do not comply with the DCF standard cannot be deleted. Back up any necessary data before formatting the card. (➔ [32 / Formatting Cards \(Initialization\)](#))

**[A folder cannot be created]**

- The maximum number of folder numbers has been reached, so new folders cannot be created. After formatting, execute [File Number Reset] in the [Setup] ([Card/File]) menu. (➔ [34 / \[File Number Reset\]](#))

**[Please turn camera off and then on again] / [System Error]**

- Turn off and on the camera. If the message is displayed even when doing this several times, contact the dealer.

**[The fan is not functioning correctly.]**

- The fan has stopped. Turn off and on the camera. If the fan does not work after turning the camera off and then on again, consult the dealer.
- The temperature of the camera will rise if you continue to use the camera with the fan stopped. Do not use over long periods of time.

# Troubleshooting

First, try out the following procedures.

If the problem is not resolved, it may be improved by selecting [Reset] (➔ [50 / \[Reset\]](#)) in the [Setup] ([Setting]) menu.

## Power

### The camera does not turn on.

- You cannot use a PoE (IEEE 802.3af compliant) compatible switching hub or power supplying device.
- Power may not be supplied if the total power limit is exceeded on power supply devices that allow connections to multiple PoE+ terminals. Refer to the operating instructions of the PoE+ power supply device.

## External device

### The images are not output to the external monitor or external recorder during recording.

- When the images do not show up on the HDMI output destination, connect an external device that can output via SDI or operate “LUMIX Tether” on a PC and try the following.  
When the menu screen is not displayed at the SDI output destination, check the settings of [Info Display (HDMI/SDI)]. (➔ [39 / Information Display \(HDMI/SDI\)](#))
  - Set the [Down Convert] to [AUTO] in [HDMI Rec Output] of the [Custom] ([IN/OUT]) menu. When setting to anything other than [AUTO], set it according to resolution the connected external device can display.
  - Depending on the settings of [Rec Quality] and [Down Convert], there are combinations where HDMI will not be output. (➔ [56 / \[Rec Quality\]](#), ➔ [134 / Settings for Down-Converting](#))
- When the images do not show up on the SDI output destination, connect an external device that can output via HDMI or operate “LUMIX Tether” on a PC and try the following.  
When the menu screen is not displayed at the HDMI output destination, check the settings of [Info Display (HDMI/SDI)]. (➔ [39 / Information Display \(HDMI/SDI\)](#))
  - Set the [SDI Output] to [ON] from the [HDMI / SDI Connections] of the [Setup] ([IN/OUT]) menu.
  - Check the settings in [SDI Output Resolution] under [SDI Rec Output] of the [Custom] ([IN/OUT]) menu. (➔ [138 / Set the resolution during recording when output via SDI](#))
- The images do not show up on both the HDMI and SDI output destination.
  - When you press [Q.MENU], [Fn2], and [Fn4] at the same time, [Reset] is performed and the camera returns to the default settings. Afterwards, set the menu according to the external device’s capabilities.

### The images are not output to the external monitor or external recorder during playback.

- Check the settings in [Output Resolution(Playback)] under [HDMI / SDI Connections] of the [Setup] ([IN/OUT]) menu. (➔ [195 / \[Output Resolution\(Playback\)\]](#))
- Set the [SDI Output] to [ON] from the [HDMI / SDI Connections] of the [Setup] ([IN/OUT]) menu when the images do not show up on the SDI output destination.
- When you press [Q.MENU], [Fn2], and [Fn4] at the same time, [Reset] is performed and the camera returns to the default settings. Afterwards, set the menu according to the external device’s capabilities.

### The recording information or menu screen is not displayed on the external monitor or external recorder.

- The recording information or menu screen will only be output to either the HDMI output destination or SDI output destination. You can set the output destination of recording information or menu screen in [Info Display (HDMI/SDI)] of the [Setup] ([IN/OUT]) menu. (➔ [39 / Information Display \(HDMI/SDI\)](#))

**The image is blurry or not colored.**

- Confirm the connection. (➔ [27 / Connecting the external monitor](#))

**The output destination images are displayed with gray bands.**

- Gray bands may be displayed on the top and bottom or the left and right of the images. You can change the band color in [Background Color(Playback)] in [HDMI / SDI Connections] of the [Setup] ([IN/OUT]) menu. (➔ [195 / \[Background Color\(Playback\)\]](#))

**Cannot communicate with the PC.**

- When connected with a USB connection cable.  
Please confirm settings of [USB Mode] in the [Setup] ([IN/OUT]) menu. (➔ [195 / \[USB Mode\]](#))
- When connected with a LAN cable.  
Check the setting in [IP Address Setting (LAN)] under [LAN / Wi-Fi Setup] from [LAN / Wi-Fi] of the [Setup] ([IN/OUT]) menu. (➔ [237 / \[LAN / Wi-Fi Setup\] menu](#))
- When connected with Wi-Fi. (➔ [254 / Wi-Fi Function](#))
- Turn the camera off and on.

## Recording

**Cannot record videos.**

- When using a large capacity card, you may not be able to record for a while after turning on the camera.

**Recording stops before finishing. Cannot use some functions.**

- Recording video requires a card of a supported Speed Class. Use a compatible card. (➔ [16 / Memory Cards That Can Be Used](#))
- In high ambient temperatures or if the camera is used for continuous recording, the temperature of the camera will rise. To protect the camera against a rise in temperature, after [△] is displayed, recording will be stopped. Wait until the camera cools down.

**The recorded image is whitish.**

- Images may look whitish when the lens or image sensor gets dirty with fingerprints or similar. If the lens is dirty, turn the camera off, then wipe the lens surface with a soft, dry cloth. For information about how to clean the image sensor. (➔ [257 / Dirt on the image sensor](#))

**The recorded image is too bright or dark.**

- Ensure AE Lock is not set where it is not appropriate. (➔ [87 / Locking Focus and Exposure \(AF/AE Lock\)](#))

**The subject is not focused properly.**

- Confirm the following details:
  - Is the subject outside of the focus range?
  - Is AF Lock (➔ [87 / Locking Focus and Exposure \(AF/AE Lock\)](#)) set where it is not appropriate?

**The recorded image looks rough. Noise appears on the picture.**

- Try the following:
  - Reduce the ISO sensitivity. (➔ [88 / ISO Sensitivity](#))
  - Increase [Noise Reduction] of [Photo Style] to the positive direction, or adjust each item other than [Noise Reduction] to the negative direction. (➔ [97 / Adjusting Image Quality](#))

**The subject appears distorted on the image.**

- When a moving subject is recorded, the subject may appear distorted in the picture.  
This is a characteristic of the MOS sensor that is the image sensor of the camera, and is not a malfunction.

**Striping or flicker may appear under lighting such as fluorescent or LED lighting.**

- This is characteristic of MOS sensors which serve as the camera's pickup sensors. This is not a malfunction.
- If flicker or horizontal stripes are noticeable when recording video, this can be mitigated by fixing the shutter speed.
- You can fine-adjust the shutter speed with [Synchro Scan]. (➔ [126](#) / [\[Synchro Scan\]](#))

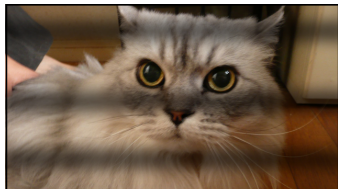
**Stripes appear in high ISO sensitivity.**

- Stripes may appear in high ISO sensitivity or depending on the lens you use.  
Decrease the ISO sensitivity. (➔ [88](#) / [ISO Sensitivity](#))

**The brightness or coloring of the recorded image is different from the actual scene.**

- When recording under lighting such as fluorescent or LED lighting, increasing the shutter speed may introduce slight changes to brightness or coloring. These are a result of the characteristics of the light source and do not indicate a malfunction.
- When recording subjects in extremely bright locations or recording under lighting such as fluorescent, LED, mercury, or sodium lighting, the coloring or screen brightness may change or horizontal striping may appear on the screen.

**Bright spot not in subject is recorded.**

- Pixels may be missing from the image sensor. Perform [Pixel Refresh]. (➔ [197](#) / [\[Pixel Refresh\]](#))

**It may flicker for an instant or the brightness of the screen may change significantly for an instant.**

- This occurs when the subject brightness changes, making the lens aperture change. This is not a malfunction.

**In videos, abnormal clicking and buzzing sounds are recorded. The recorded audio is very quiet.**

- Depending on the recording conditions or the lens used, the sound of aperture and focus actions may be recorded in videos. You can set the focus operation during video recording to [OFF] in [Continuous AF] (➔ [78](#) / [\[Continuous AF\]](#)).
- Do not block the microphone hole during video recording.

**An operation sound is recorded in a video.**

- If the operation sound during recording bothers you, try the following:
  - Record by operating the camera remotely (➔ [204](#) / [12. Remote Operations](#))
  - Connect a remote control unit (commercially available) compatible with this unit to the [REMOTE] terminal to record.

## Playback

### Cannot playback. There are no recorded pictures.

- Folders and images processed on a PC cannot be played.
- Videos recorded with a different [System Frequency] setting cannot be played back. Return the [System Frequency] setting to the one you used during the recording. (➔ [55](#) / [\[System Frequency\]](#))

## Wi-Fi Function

### A Wi-Fi connection cannot be established. Radio waves get disconnected. Wireless access point is not displayed.

#### General tips for using a Wi-Fi connection

- Use within the communication range of the device to be connected.
- Usage near devices that utilize the 2.4 GHz frequency such as microwave ovens and cordless telephones may result in the radio wave being lost. Use the camera at a sufficient distance from these devices.
- If you place the camera on a metal table or shelf, the radio waves may be adversely affected. In such cases, you may not be able to establish a connection. Move the camera away from the metal surface.

#### Wireless access point

- Confirm that the connected wireless access point can be used.
- Confirm the radio wave conditions of the wireless access point.
  - Move the camera closer to the wireless access point.
  - Change the location and angle of the wireless access point.
- Depending on the wireless access point, the radio wave may not be displayed even though it is present.
  - Turn off and then on the wireless access point.
  - If the wireless channel of the wireless access point cannot be set automatically, manually set the channel supported by the camera.
  - If the wireless access point SSID is set not to broadcast, it may not be detected. Enter the SSID, and then connect. (➔ [233](#) / [Connecting by Manual Input](#))
- Depending on the wireless access point, connection may be automatically disconnected after specific time has passed. Reconnect the connection again.

### Connection to a wireless access point cannot be established.

- The wireless access point information set on the camera is wrong. Check the authentication type and encryption key. (➔ [233](#) / [Connecting by Manual Input](#))
- Radio waves from other devices may block the connection to a wireless access point. Check the status of other devices that are connected to the wireless access point as well as the status of other wireless devices.

### (iOS devices) Wi-Fi connection attempt fails.

- Follow the message displayed to allow connection to the camera. If you still cannot connect, select the SSID of the camera on the Wi-Fi setup screen of the smartphone to connect. If the SSID is not displayed, turn off and on the camera, then perform the connection settings again.

### Connection to a smartphone via Wi-Fi cannot be established.

- Change the access point to connect to in the smartphone Wi-Fi settings to the camera.

**The PC is not recognized when I use a Wi-Fi connection. The camera cannot be connected to the PC using the Wi-Fi function.**

- When the clock settings of the PC connected to the camera differs considerably from those of the camera, the camera cannot be connected to the PC depending on the OS.
- 

**I have forgotten the password for the Wi-Fi.**

- In the [Setup] ([Setting]) menu, [Reset], reset network settings. (➔ 50 / [Reset]) However, all information set in [LAN / Wi-Fi] and [Bluetooth] will also be reset.

## Others

** is displayed on the screen.**

- The fan has stopped. Turn off and on the camera. If the fan does not work after turning the camera off and then on again, consult the dealer.
  - The temperature of the camera will rise if you continue to use the camera with the fan stopped. Do not use over long periods of time.
- 

**There is rattling noise from the lens when the camera is turned on or off, or when the camera is swung.**

**There is a sound from the lens when recording.**

- This is the sound of the lens moving and aperture operation. It is not a malfunction.
- 

**The camera becomes warm.**

- The camera surface may become warm during use, but this does not indicate a problem with performance or quality.

# Cautions for Use

## ■ The camera

**Keep this unit as far away as possible from electromagnetic equipment (such as microwave ovens, TVs, video games etc.).**

- If you use this unit on top of or near a TV, the pictures and/or sound on this unit may be disrupted by electromagnetic wave radiation.
- Do not use this unit near cell phones because doing so may result in noise adversely affecting the pictures and/or sound.
- Recorded data may be damaged, or pictures may be distorted, by strong magnetic fields created by speakers or large motors.
- Electromagnetic wave radiation may adversely affect this unit, disturbing the pictures and/or sound.
- If this unit is adversely affected by electromagnetic equipment and stops functioning properly, turn this unit off and disconnect AC adaptor. Then reconnect AC adaptor and turn this unit on.

**Do not use this unit near radio transmitters or high-voltage lines.**

- If you record near radio transmitters or high-voltage lines, the recorded pictures and/or sound may be adversely affected.

**Always use the supplied cords and cables. If you use optional accessories, use the cords and the cables supplied with them.**

**Do not extend the cords or the cables.**

**Do not spray the camera with insecticides or volatile chemicals.**

- If the camera is sprayed with such chemicals, the body of the camera may be damaged and the surface finish may peel off.

**Do not keep products made of rubber, PVC or similar materials in contact with the camera for a long period of time.**

## ■ When using in cold places or at low temperatures

- **Skin burns may result if you leave the metal parts of the camera in direct contact with the skin for long periods of time at cold places (environments with temperatures at or below 0 °C (32 °F), such as ski resorts or places at high altitude).**  
**Use gloves or similar when using it for long periods.**
- If using in cold locations, do not allow water droplets and snow to remain on the camera. If these are left on the camera, water may freeze in gaps in the camera ON/OFF button and microphone, making these parts difficult to move, and/or leading to reduced volume. This is not a malfunction.

## ■ Cleaning

**Before cleaning the camera, disconnect the power plug from the electrical outlet. Then wipe the camera with a dry, soft cloth.**

- When the camera is soiled badly, it can be cleaned by wiping the dirt off with a wrung wet cloth, and then with a dry cloth.
- Do not use solvents such as benzine, thinner, alcohol, kitchen detergents, etc., to clean the camera, since it may deteriorate the external case or the coating may peel off.
- When using a chemical cloth, be sure to follow the accompanying instructions.



### ■ Dirt on the image sensor

If dirt gets inside the mount when changing lenses, depending on the recording conditions, it may adhere to the image sensor and appear on the recorded picture.

To prevent debris or dust adhering to internal parts of the body, avoid changing the lens in a dusty environment and always fit the body cap or a lens when storing the camera. Remove any dirt on the body cap before attaching it.

### Removing dirt on the image sensor

The image sensor is very precise and delicate, so be sure to observe the following when you do have to clean it yourself.

- Blow dust off the surface of the image sensor using a commercially available blower. Do not blow the dust off with excessive power.
- Do not put the blower brush further inside than the lens mount as the image sensor may get scratched.
- Do not use any objects except a blower brush to clean the image sensor.
- If you cannot remove the dirt or dust with the blower, consult the dealer or Panasonic.

### ■ AC Adaptor

- If you use the battery charger near a radio, the radio reception may be disturbed. Keep the charger 1 m (3.3 feet) or more away from radio.
- During usage, the AC adaptor may emit an electrical hum; this is not a malfunction.
- After use, be sure to disconnect the power plug from the electrical outlet. (A very small amount of current is consumed if it is left connected.)

### ■ Card

**Do not leave the card in areas with high temperatures, direct sunlight, or areas prone to electromagnetic waves and static.**

**Do not bend or drop the card.**

**Do not subject the card to strong vibration.**

- Otherwise, the card and recorded data may be damaged.
- Put the card in the card case or the storage bag after use and when storing or carrying the card.
- Do not allow dirt, water or other foreign objects to get into the contacts on the card. Additionally, do not touch the contacts with your hands.

### ■ Battery

- The unusable battery should be discarded in accordance with battery recycling laws. Call the RBRC hotline at 1-800-822-8837 for information.

## ■ Personal Information

Personal information is stored within the camera and in recorded images. We recommend that you enhance security by setting Wi-Fi password and a wired LAN/Wi-Fi function lock to protect personal information. (➔ 237 / [LAN / Wi-Fi Setup] menu)

- Images may contain information that can be used to identify the user, such as recording dates and times, and location information. Confirm details carefully before uploading images to a web service.

## Disclaimer

- Information including personal information may be altered or vanish due to erroneous operation, effect of static electricity, accident, malfunction, repair, or other handlings. Please note in advance that Panasonic is not liable in any way for any direct or indirect damage from the alteration or vanishing of information or personal information.

## When requesting a repair or transferring / disposing of the camera

- After making a copy of personal information, be sure to delete information, including personal information, such as wired / wireless LAN connection settings that you have registered or saved within the camera with [Reset] (➔ 50 / [Reset]).
- Reset the settings to protect the personal information. (➔ 50 / [Reset])
- Remove the card from the camera.
- Settings may return to factory default when camera is repaired.
- Please contact the dealer where you purchased the camera or Panasonic if above operations are not possible due to malfunction.

## Points to remember when disposing of/transferring the memory card

Format or delete using the camera or a PC will only modify the file management information, so it will not delete the data in the card completely.

We recommend physically destroying the card or using commercially available PC data deletion software to delete the card data completely when disposing of/transferring the card.

You are responsible for handling of data on cards.

## ■ When Not Using the Camera for a Long Period of Time

- Ensure you remove the card from the camera.
- We recommend storing the camera with a desiccant (silica gel) when you keep it in a closet or a cabinet.
- Check all the parts before recording when you have not used the camera for a long period of time.

## ■ Image Data

- Recorded data may be damaged or lost if the camera breaks down due to inappropriate handling. Panasonic will not be liable for any damage caused due to loss of recorded data.

## ■ Tripod / Unipod

- Make sure the tripod/unipod is stable when the camera is attached to it.
- Care is required because tightening the screw excessively may damage the camera, or cause the rating label to come off.
- When using this unit with a large-diameter lens, the lens may come into contact with the pedestal depending on the tripod/unipod. Tightening the screw with the lens and pedestal in contact with each other may damage this unit or the lens. Therefore it is recommended to attach the tripod adaptor (DMW-TA1: optional) before mounting on the tripod/unipod.
- Also refer to the operating instructions for the tripod/unipod.

### ■ Network connection

This unit cannot be directly connected to the communication lines (including public wireless LAN) of telecommunications carriers (mobile communication company, fixed communication company, Internet provider, etc.). When connecting this unit to the Internet, be sure to connect via a router etc.

#### **There is the risk that data sent and received via radio waves may be intercepted**

Please note that there is the risk that data sent and received via radio waves may be intercepted by a third party.

### ■ Wi-Fi Function

#### **Use the camera as a wireless LAN device**

When using devices or PC systems that require more reliable security than wireless LAN devices, ensure that the appropriate measures are taken for safety designs and defects for the systems used.

Panasonic will not take any responsibility for any damage that arises when using the camera for any purpose other than as a wireless LAN device.

#### **Use of the Wi-Fi function of the camera is presumed to be in countries where it is sold**

There is the risk that the camera violates the radio wave regulations if used in countries other than those where it is sold, and Panasonic takes no responsibility for any violations.

#### **Do not use the camera in areas with magnetic fields, static electricity or interference**

- Do not use the camera in areas with magnetic fields, static electricity or interference, such as near microwave ovens. These may cause the interruption of the radio waves.
- Using the camera near devices such as microwave ovens or cordless telephones that use the 2.4 GHz radio wave band may cause a decrease in performance in both devices.

#### **Do not connect to the wireless network you are not authorized to use**

When the camera utilizes its wireless LAN function, wireless networks (SSID) that you are not authorized to use may be displayed, however do not attempt to connect to the network as it may be considered as an unauthorized access.

# Available Recording Time with the Battery

Listed below are the time lengths available for recording when the battery is being used.

- Using an SDHC memory card.
- Using the interchangeable lens (H-ES12060).
- When outputting via HDMI to an external monitor.
- The values listed are approximate.

## ■ AG-VBR59

[Rec. File Format]: [MP4]

[Rec Quality]	Continuous available recording time (Actual available recording time) (minutes)	
	[Image Area of Video]	
	[FULL]	[PIXEL/PIXEL]
4K/10bit/100M/60p	270 (135)	—
4K/8bit/100M/30p	300 (150)	—
FHD/8bit/28M/60p	300 (150)	340 (170)

[Rec. File Format]: [MOV]

[Rec Quality]	Continuous available recording time (Actual available recording time) (minutes)	
	[Image Area of Video]	
	[FULL]	[PIXEL/PIXEL]
4K/60p/420/10-L	260 (130)	—
4K/30p/422/10-L	280 (140)	—
FHD/60p/422/10-L	280 (140)	320 (160)
FHD/60p/420/8-L	300 (150)	330 (165)

## ■ AG-VBR89

[Rec. File Format]: [MP4]

[Rec Quality]	Continuous available recording time (Actual available recording time) (minutes)	
	[Image Area of Video]	
	[FULL]	[PIXEL/PIXEL]
4K/10bit/100M/60p	420 (210)	—
4K/8bit/100M/30p	480 (240)	—
FHD/8bit/28M/60p	480 (240)	530 (265)

[Rec. File Format]: [MOV]

[Rec Quality]	Continuous available recording time (Actual available recording time) (minutes)	
	[Image Area of Video]	
	[FULL]	[PIXEL/PIXEL]
4K/60p/420/10-L	420 (210)	—
4K/30p/422/10-L	450 (225)	—
FHD/60p/422/10-L	450 (225)	500 (250)
FHD/60p/420/8-L	470 (235)	520 (260)

### ■ AG-VBR118

[Rec. File Format]: [MP4]

[Rec Quality]	Continuous available recording time (Actual available recording time) (minutes)	
	[Image Area of Video]	
	[FULL]	[PIXEL/PIXEL]
4K/10bit/100M/60p	560 (280)	—
4K/8bit/100M/30p	640 (320)	—
FHD/8bit/28M/60p	640 (320)	710 (355)

[Rec. File Format]: [MOV]

[Rec Quality]	Continuous available recording time (Actual available recording time) (minutes)	
	[Image Area of Video]	
	[FULL]	[PIXEL/PIXEL]
4K/60p/420/10-L	560 (280)	—
4K/30p/422/10-L	600 (300)	—
FHD/60p/422/10-L	600 (300)	670 (335)
FHD/60p/420/8-L	630 (315)	700 (350)

- Actual available recording time is the time available for recording when repeating actions such as turning the camera on and off, starting/stopping recording, etc.

- The available recording time vary depending on the surrounding environment and the usage conditions. For example, these will reduce in the following case:
  - In low-temperature environments, such as on ski slopes.
- If the usage duration drops significantly even when the battery is fully charged, then the battery is at the end of its service life. Check the battery status, and replace with a new battery.

# Video Recording Time with Cards

Listed below are the time lengths of videos that can be recorded on a card.

- The values listed are approximate.
- Video recording time is the total time of all the videos which have been recorded.

## [Rec. File Format]: [MP4]

### ■ [System Frequency]: [59.94Hz (NTSC)]

[Rec Quality]	Card capacity		
	32 GB	64 GB	128 GB
[4K/10bit/100M/60p] [4K/8bit/100M/30p] [4K/8bit/100M/24p]	41m00s	1h25m	2h45m
[4K/10bit/72M/30p] [4K/10bit/72M/24p]	57m00s	1h55m	3h55m
[FHD/8bit/28M/60p]	2h25m	4h55m	9h45m
[FHD/8bit/24M/24p]	2h50m	5h40m	11h25m
[FHD/8bit/20M/30p]	3h15m	6h30m	13h00m

### ■ [System Frequency]: [50.00Hz (PAL)]

[Rec Quality]	Card capacity		
	32 GB	64 GB	128 GB
[4K/10bit/100M/50p] [4K/8bit/100M/25p]	41m00s	1h25m	2h45m
[4K/10bit/72M/25p]	57m00s	1h55m	3h55m
[FHD/8bit/28M/50p]	2h25m	4h55m	9h45m
[FHD/8bit/20M/25p]	3h15m	6h30m	13h00m

**[Rec. File Format]: [MOV]**

■ **[System Frequency]: [59.94Hz (NTSC)]**

[Rec Quality]	Card capacity		
	32 GB	64 GB	128 GB
[4K-A/30p/422/10-I] [4K-A/24p/422/10-I] [C4K/30p/422/10-I] [C4K/24p/422/10-I] [4K/30p/422/10-I] [4K/24p/422/10-I]	10m00s	21m00s	42m00s
[C4K/60p/420/10-L] [4K/60p/420/10-L] [FHD/60p/422/10-I] [FHD/30p/422/10-I] [FHD/24p/422/10-I]	20m00s	42m00s	1h20m
[4K-A/60p/420/8-L] [4K-A/30p/422/10-L] [4K-A/24p/422/10-L] [C4K/60p/420/8-L] [C4K/30p/422/10-L] [C4K/24p/422/10-L] [4K/60p/420/8-L] [4K/30p/422/10-L] [4K/24p/422/10-L]	27m00s	56m00s	1h50m
[4K-A/30p/420/8-L] [4K-A/24p/420/8-L] [C4K/30p/420/8-L] [C4K/24p/420/8-L] [4K/30p/420/8-L] [4K/24p/420/8-L] [FHD/60p/422/10-L] [FHD/60p/420/8-L] [FHD/30p/422/10-L] [FHD/30p/420/8-L] [FHD/24p/422/10-L] [FHD/24p/420/8-L]	41m00s	1h25m	2h45m



**■ [System Frequency]: [50.00Hz (PAL)]**

[Rec Quality]	Card capacity		
	32 GB	64 GB	128 GB
[4K-A/25p/422/10-I] [C4K/25p/422/10-I] [4K/25p/422/10-I]	10m00s	21m00s	42m00s
[4K-A/50p/420/10-L] [C4K/50p/420/10-L] [4K/50p/420/10-L] [FHD/50p/422/10-I] [FHD/25p/422/10-I]	20m00s	42m00s	1h20m
[4K-A/50p/420/8-L] [4K-A/25p/422/10-L] [C4K/50p/420/8-L] [C4K/25p/422/10-L] [4K/50p/420/8-L] [4K/25p/422/10-L]	27m00s	56m00s	1h50m
[4K-A/25p/420/8-L] [C4K/25p/420/8-L] [4K/25p/420/8-L] [FHD/50p/422/10-L] [FHD/50p/420/8-L] [FHD/25p/422/10-L] [FHD/25p/420/8-L]	41m00s	1h25m	2h45m

**■ [System Frequency]: [24.00Hz (CINEMA)]**

[Rec Quality]	Card capacity		
	32 GB	64 GB	128 GB
[4K-A/24p/422/10-I] [C4K/24p/422/10-I] [4K/24p/422/10-I]	10m00s	21m00s	42m00s
[FHD/24p/422/10-I]	20m00s	42m00s	1h20m
[4K-A/24p/422/10-L] [C4K/24p/422/10-L] [4K/24p/422/10-L]	27m00s	56m00s	1h50m
[4K-A/24p/420/8-L] [C4K/24p/420/8-L] [4K/24p/420/8-L] [FHD/24p/422/10-L] [FHD/24p/420/8-L]	41m00s	1h25m	2h45m

- Depending on the recording conditions and the type of card, video recording time vary.
- The continuous recordable time for videos is displayed on the screen.













































# List of Default Settings / Custom Saving / Settings Available for Copying



































































: The function to return to default settings using [Reset].

: The function to save settings details in the Custom mode using [Save to Custom Mode].









































: The function to copy settings details using [Save/Restore Camera Setting].

























































Menu		Default setting	Compatible functions
 [Rec Mode]:  [Rec Mode]		[Creative Video Mode]	 
 [Video]: 			
[Exposure Mode]		[P]	  
[Exposure Comp.]		[±0]	  
[Sensitivity]		[AUTO]	  
[White Balance]		[AWB]	  
[Photo Style]		 STD]	  
[Metering Mode]		 ]	  
[Dual Native ISO Setting]		[AUTO]	  
[ISO Sensitivity (video)]	[ISO Auto Lower Limit Setting]	[160]	  
	[ISO Auto Upper Limit Setting]	[AUTO]	  
[Synchro Scan]		[OFF]	  
[Master Pedestal Level]		[0]	  
[SS/Gain Operation]		[SEC/ISO]	  
[i.Dynamic Range]		[OFF]	  
[Vignetting Comp.]		[OFF]	  
[Diffraction Compensation]		[OFF]	  
[Filter Settings]	[Filter Effect]	[OFF]	  



















































 [Video]:  [Image Format]			
[Rec. File Format]	When [System Frequency] is set to [59.94Hz (NTSC)] or [50.00Hz (PAL)]: [MP4]	  	
	When [System Frequency] is set to [24.00Hz (CINEMA)]: [MOV]		
[Image Area of Video]	[FULL]	  	
[Rec Quality]	When [System Frequency] is set to [59.94Hz (NTSC)]: [FHD/8bit/28M/60p]	  	
	When [System Frequency] is set to [50.00Hz (PAL)]: [FHD/8bit/28M/50p]		
	When [System Frequency] is set to [24.00Hz (CINEMA)]: [FHD/24p/420/8-L]		
[Rec Quality (My List)]	—	  	
[Variable Frame Rate]	[OFF]	  	
[Time Code]	[Time Code Display]	[OFF]	  
	[Count Up]	[REC RUN]	  
	[Time Code Value]	—	—
	[Time Code Mode]	[DF]	  
	[HDMI Time Code Output]	[OFF]	  
	[SDI Time Code Output]	[OFF]	  
	[External TC Setting]	—	  
[Genlock]	[Genlock Input]	[OFF]	  
	[Horizontal Phase Adjustment]	[±0]	  
[Luminance Level]	[16-255]	  	

 [Video]:  [Focus]			
[Focus Mode]	[AF]	  	
[AF Mode]		  	
[AF Custom Setting(Video)]	[ON] / [OFF]	[OFF]	  
	[SET]	—	  
[Continuous AF]	[MODE2]	  	
[Focus Peaking]	[ON] / [OFF]	[ON]	  
	[SET]	—	  
[1-Area AF Moving Speed]	[FAST]	  	
 [Video]:  [Audio]			
[Sound Rec Level Disp.]	[OFF]	  	
[Mute Sound Input]	[OFF]	  	
[Sound Rec Gain Level]	[STANDARD]	  	
[Sound Rec Level Adj.]	[0dB]	  	
[Sound Rec Level Limiter]	[ON]	  	
[Wind Noise Canceller]	[STANDARD]	  	
[Wind Cut]	[OFF]	  	
[Lens Noise Cut]	[ON]	  	
[Mic Socket]	<b>MIC</b> 	  	
[Special Mic.]	[Stereo]	  	
[XLR Mic Adaptor Setting]	[48kHz/16bit]	  	
[Sound Output]	[REALTIME]	  	
[Headphone Volume]	[LEVEL3]	 	

[Video]:  [Others]			
[Image Stabilizer]	[Operation Mode]		
	[E-Stabilization (Video)]	[OFF]	
[Digital Zoom]		[OFF]	
[Focus Transition]	[Start]	—	—
	[Focus Pull Setting]	—	—
	[Focus Transition Speed]	[M]	
	[Focus Transition Rec]	[OFF]	
	[Focus Transition Wait]	[OFF]	
[Loop Recording (video)]		[OFF]	
[Segmented File Recording]		[OFF]	
[Live Cropping]		[OFF]	
[Time Stamp Rec.]		[OFF]	
[Custom]:  [Image Quality]			
[Photo Style Settings]	[Show/Hide Photo Style]	—	
	[My Photo Style Settings]	—	
	[Reset Photo Style]	—	—
[ISO Increments]		[1/3 EV]	
[Extended ISO]		[OFF]	
[Exposure Offset Adjust.]	[Multi Metering]	[±0 EV]	
	[Center Weighted]	[±0 EV]	
	[Spot]	[±0 EV]	
	[Highlight Weighted]	[±0 EV]	





































 [Custom]:  [Focus/Shutter]			
[AF/AE Lock Hold]		[OFF]	  
[AF+MF]		[OFF]	  
[MF Assist]	(interchangeable lens with a focus ring attached) [Focus Ring]	[ON]	  
	[AF Mode]	[ON]	  
	[MF Assist Display]	[PIP]	  
[MF Guide]		[ON]	  
[Focus Ring Lock]		[OFF]	  
 [Custom]:  [Operation]			
[Q.MENU Settings]	[Layout Style]	[MODE1]	  
	[Item Customize (Video)]	—	  
[Fn Button Set]	[Setting in REC mode]	—	  
	[Setting in PLAY mode]	—	  
[Video Rec. Button]		[ON]	  



























⚙️ [Custom]: 🖥️ [Monitor / Display]			
[Histogram]	[OFF]	  	
[Focal Length]	[ON]	  	
[Level Gauge]	[ON]	  	
[Luminance Spot Meter]	[OFF]	  	
[Framing Outline]	[OFF]	  	
[Display Information]	[Display Info in Rec Mode]	[WITH INFO]	  
	[Display Info in Playback]	[WITH INFO]	  
[V-LogL View Assist]	[Read LUT File]	—	—
	[LUT Select]	[Vlog_709]	 
	[LUT View Assist (HDMI)]	[OFF]	 
	[LUT View Assist (SDI)]	[OFF]	 
[HLG View Assist]	[HDMI]	[AUTO]	  
	[SDI]	[MODE2]	  
[Anamorphic Desqueeze Display]	[OFF]	  	
[Center Marker]	[OFF]	  	
[Frame Marker]	[ON] / [OFF]	[OFF]	  
	[SET]	—	  
[Zebra Pattern]	[ZEBRA1] / [ZEBRA2] / [ZEBRA1+2] / [OFF]	[OFF]	  
	[SET]	—	  
[Color Bars]	—	  	
[Red REC Frame Indicator]	[OFF]	  	

⚙️ [Custom]: 📡 [IN/OUT]			
[HDMI Rec Output]	[Down Convert]	[AUTO]	  
	[HDMI Recording Control]	[OFF]	  
	[Sound Down Convert]	[OFF]	  
	[Sound Output (HDMI)]	[ON]	  
	[HDMI MF Assist Output]	[ON]	  
[SDI Rec Output]	[SDI Output Resolution]	When [System Frequency] is set to other than [24.00Hz (CINEMA)]: [1080p] When [System Frequency] is set to [24.00Hz (CINEMA)]: [1080PsF]	  
	[SDI Recording Control]	[OFF]	  
	[Sound Output (SDI)]	[ON]	  
	[SDI Sound Output Gain Adj.]	[-8dB]	  
	[SDI MF Assist Output]	[ON]	  
[Fan Mode]		[AUTO1]	  
[Tally Lamp]	[Front Tally Lamp]	[H]	  
	[Rear Tally Lamp]	[ON]	  
⚙️ [Custom]: 📡 [Lens / Others]			
[Lens Focus Resume]		[OFF]	  
[Power Zoom Lens]	[Step Zoom]	[OFF]	  
	[Zoom Ring]	[ON]	  
[Lens Fn Button Setting]		[Focus Stop]	  



🔧 [Setup]: 📄 [Card/File]			
[Card Format]		—	—
[Double Card Slot Function]	[Recording Method]		
	[Destination Card Slot]		
[Folder / File Settings]	[Select Folder]	—	—
	[Create a New Folder]	—	—
	[File Name Setting]	[Folder Number Link]	
[File Number Reset]		—	—
[Copyright Information]	[Artist]	[OFF]	
	[Copyright Holder]	[OFF]	
	[Display Copyright Info.]	—	—
🔧 [Setup]: 🖥️ [Monitor / Display]			
[Level Gauge Adjust.]	[Adjust.]	—	
	[Level Gauge Value Reset]	—	—

✎ [Setup]: 📶 [IN/OUT]			
[Headphone Volume]	[LEVEL3]	 	
[LAN / Wi-Fi]	—	  *1	
*1 Saves the settings of [IP Address Setting (LAN)] in [LAN / Wi-Fi Setup]. However, the IP address set in [Static IP Address Setting] of [IP Address Setting (LAN)] is not saved.			
[Bluetooth]	—		
[USB Mode]	 [PC(Tether)]	 	
[HDMI / SDI Connections]	[SDI Output]	[ON]	 
	[Output Resolution(Playback)]	When [SDI Output] is set to [OFF]: [AUTO] When [SDI Output] is set to [ON]: [1080p] (It is [1080PsF] when [System Frequency] is set to [24.00Hz (CINEMA)])	 
	[LUT View Assist (HDMI)]	[OFF]	  
	[HLG View Assist (HDMI)]	[AUTO]	   
	[LUT View Assist (SDI)]	[OFF]	  
	[HLG View Assist (SDI)]	[MODE2]	   
	[Background Color(Playback)]		 
[Info Display (HDMI/SDI)]	[AUTO]	   	
[Power/Network Indicator]	[ON]	 	
[Card Access Light]	[ON]	 	

✍ [Setup]: ⚙ [Setting]		
[Save to Custom Mode]	—	 
[Load Custom Mode]	—	 
[Custom Mode Settings]	[Limit No. of Custom Mode]	[5]  
	[Edit Title]	—  
	[How to Reload Custom Mode]	—  
	[Select Loading Details]	—  
[Save/Restore Camera Setting]	[Save]	—
	[Load]	—
	[Delete]	—
	[Keep Settings While Format]	[OFF]  
[Reset]	—	—
✍ [Setup]: ⚙ [Others]		
[Clock Set]	2020. 1. 1. 0:00:00	—
[Time Zone]	GMT -5:00	
[System Frequency]	[59.94Hz (NTSC)]	 
[Device Name]	—	
[Pixel Refresh]	—	—
[Language]	—	 
[Firmware Version]	—	—
[Online Manual]	—	—
👤 [My Menu]: ✍ [Edit My Menu]		
[Add]	—	 
[Sorting]	—	—
[Delete]	—	—
[Display from My Menu]	[OFF]	 
▶ [Playback] menu: 🎬 [Playback Mode]		
[Anamorphic Desqueeze Display]	[OFF]	  
▶ [Playback] menu: 📄 [Add/Delete Info.]		
[Protect]	—	—
[Rating]	—	—
▶ [Playback] menu: ✂ [Edit Image]		
[Copy]	—	—
▶ [Playback] menu: 🖼 [Others]		
[Delete All Images]	—	—

# Specifications

The specifications are subject to change for performance enhancement.

**It is possible to record photos (still images) using software “LUMIX Tether”.**

## Digital camera body (DC-BGH1):

Information for your safety

### Power source:

12 V ==

### Power consumption:

7.9 W (when recording), 6.7 W (when playing back) [When the interchangeable lens H-ES12060 is attached.]

## Type

Type	Digital Single Lens Mirrorless camera
Recording media	SD memory card / SDHC memory card*1 / SDXC memory card*1 *1 Compliant with UHS-I/UHS-II UHS Speed Class 3, UHS-II Video Speed Class 90 Double slot recording function is available.
Lens mount	Micro Four Thirds mount

## Image sensor

Image sensor	4/3" Live MOS sensor, a total of 11,930,000 pixels, primary color filter
Effective number of pixels of the camera	10,280,000 pixels

## Latitude

13 stops ([V-Log L])

## Recording format for video

Video format	MP4 (H.264/MPEG-4 AVC, H.265/HEVC) MOV (H.264/MPEG-4 AVC, H.265/HEVC)
Audio format	MP4: AAC (2ch) MOV: LPCM (2ch, 48 kHz/16 bit)*2 *2 When an XLR Microphone Adaptor (DMW-XLR1: optional) is attached, LPCM (2ch, 48 kHz/24-bit, 96 kHz/24-bit) can be selected
Image quality for video	Refer to [Rec Quality] in this document. (➔ 56 / [Rec Quality])

## Recording format for still images

<b>File format for still images</b>	JPEG (DCF compliant, Exif 2.31 compliant)
<b>Image size (pixels)</b>	L: 3680×2760 M: 2592×1944 S: 1824×1368 (The aspect ratio is fixed to [4:3].)
<b>Image quality for photos</b>	Fine / Standard

## Focus

<b>AF type</b>	TTL type based on image detection (Contrast AF)
<b>Focus mode</b>	AF / MF
<b>AF mode</b>	Automatic detection (Face/Eye/Body/Animal) / Tracking (only for video) / 225-Area / Zone (Oval) (only for video) / 1-Area

## Exposure control

<b>Light metering system, Light metering mode</b>	1728-zone metering, multi-metering / center-weighted metering / spot metering / highlight-weighted metering (only for video)
<b>Metering range</b>	EV 0 to EV 18 (F2.0 lens, ISO100 conversion)
<b>Exposure</b>	Program AE (P) / Aperture-Priority AE (A) / Shutter-Priority AE (S) / Manual Exposure (M)
<b>Exposure compensation</b>	1/3 EV steps, $\pm 3$ EV (Videos), $\pm 5$ EV (Photos)
<b>ISO sensitivity (standard output sensitivity)</b>	AUTO / 160 to 51200, When [Extended ISO] is set: AUTO / 80 to 204800, 1/3 EV steps
<b>Dual Native ISO setting</b>	<p><b>Auto</b> Base sensitivity: 160/800 (dB display values are based on 160) AUTO / 160 to 51200 When [Extended ISO] is set: AUTO / 80 to 204800</p> <p><b>Low sensitivity</b> Base sensitivity: 160 AUTO / 160 to 800 When [Extended ISO] is set: AUTO / 80 to 800</p> <p><b>High sensitivity</b> Base sensitivity: 800 AUTO / 800 to 51200 When [Extended ISO] is set: AUTO / 800 to 204800</p>
<b>Dual Native ISO setting ([V-Log L])</b>	<p><b>Auto</b> Base sensitivity: 400/2000 (dB display values are based on 400) AUTO / 400 to 25600</p> <p><b>Low sensitivity</b> Base sensitivity: 400 AUTO / 400 to 2000</p> <p><b>High sensitivity</b> Base sensitivity: 2000 AUTO / 2000 to 25600</p>
<b>Dual Native ISO setting ([Hybrid Log Gamma])</b>	<p><b>Auto</b> Base sensitivity: 320/1600 (dB display values are based on 320) AUTO / 320 to 51200 When [Extended ISO] is set: AUTO / 320 to 204800</p> <p><b>Low sensitivity</b> Base sensitivity: 320 AUTO / 320 to 1600</p> <p><b>High sensitivity</b> Base sensitivity: 1600 AUTO / 1600 to 51200 When [Extended ISO] is set: AUTO / 1600 to 204800</p>

**White balance**

AWB / AWBc / AWBw / Daylight / Cloudy / Shade / Incandescent lights / White set 1, 2, 3, 4 / Color temperature 1, 2, 3, 4

**Shutter**

<b>Shutter speed</b>	Videos: 1/2 of a second to 1/16000 of a second Photos: 1 second to 1/16000 of a second
----------------------	---

**Zoom**

<b>Digital Zoom</b>	2x / 4x
---------------------	---------

**Display language**

[ENGLISH] / [DEUTSCH] / [FRANÇAIS] / [ITALIANO] / [ESPAÑOL] / [繁體中文] / [PORTUGUÊS] / [日本語]

**Microphone**

Stereo

**Interface**

<b>[REMOTE]</b>	Ø2.5 mm jack Terminal for generic remote control unit (A Panasonic shutter remote control (DMW-RS2) cannot be used.)
<b>[DC IN 12 V]</b>	DC 12 V (11.4 V to 12.6 V), EIAJ Type 4
<b>[MIC]</b>	Ø3.5 mm stereo mini jack
<b>Headphones</b>	Ø3.5 mm stereo mini jack
<b>LAN connector</b>	LAN terminal (RJ-45) for remote control×1, compatible with power supply by PoE+ (IEEE 802.3at compliant) <ul style="list-style-type: none"> <li>Use an IEC60950-1 or IEC62368-1 compliant PoE+ (IEEE 802.3at compliant) switching hub or power supplying device.</li> </ul>
<b>[SDI OUT]</b>	BNC terminal×1, 0.8 V [p-p], 75 Ω, 3G-SDI compatible
<b>[TC IN/OUT]</b>	BNC terminal×1
<b>[GENLOCK IN]</b>	BNC terminal×1, BBS (Black Burst sync) signal and tri-level sync signal compatible
<b>HDMI</b>	HDMI Type A
<b>USB</b>	USB Type-C™, SuperSpeed USB3.1 GEN1

**External dimensions / Mass**

<b>External dimensions</b>	Approx. 93.0 mm (W)×93.0 mm (H)×78.0 mm (D) (3.66" (W)×3.66" (H)×3.07" (D)) (excluding the projecting parts)
<b>Mass (Weight)</b>	Approx. 545 g / 1.2 lb (only camera body)

**Operating environment**

<b>Recommended operating temperature</b>	-10 °C to 40 °C (14 °F to 104 °F) <ul style="list-style-type: none"> <li>Battery performance temporarily worsens at low temperatures (-10 °C to 0 °C (14 °F to 32 °F)), reducing the available recording time.</li> </ul>
<b>Permissible relative humidity</b>	10%RH to 80%RH

**Wi-Fi**

<b>Compliance standard</b>	IEEE 802.11b/g/n (standard wireless LAN protocol)
<b>Frequency range used (central frequency)</b>	2412 MHz to 2462 MHz (1 to 11 ch)
<b>Encryption method</b>	Wi-Fi compliant WPA™/WPA2™
<b>Access method</b>	Infrastructure mode

**Bluetooth**

<b>Compliance standard</b>	Bluetooth Ver. 4.2 (Bluetooth Low Energy (BLE))
<b>Frequency range used (central frequency)</b>	2402 MHz to 2480 MHz



**AC adaptor (Panasonic SAE0011A):**

Information for your safety

**Input:**

100 V - 240 V ~ 50/60 Hz 1.2 A  
79 VA (100 V ~) - 99 VA (240 V ~)

**Output:**

12 V = 3.0 A

The symbols on this product (including the accessories) represent the following:

- ~ AC
- = DC
- Class II equipment (The construction of the product is double-insulated.)
- | ON
- ⏻ Stand-by

This camera complies with the "Design rule for Camera File system" (DCF) and "Exchangeable Image File Format" (Exif) standards established by "Japan Electronics and Information Technology Industries Association" (JEITA). The camera cannot playback files that do not comply with the DCF standard. Exif is a file format for still images which allows recording information, etc. to be added.

# Trademarks and Licenses



- Micro Four Thirds™ and Micro Four Thirds Logo marks are trademarks or registered trademarks of Olympus Corporation, in Japan, the United States, the European Union and other countries.
- Four Thirds™ and Four Thirds Logo marks are trademarks or registered trademarks of Olympus Corporation, in Japan, the United States, the European Union and other countries.
- SDXC Logo is a trademark of SD-3C, LLC.
- The terms HDMI and HDMI High-Definition Multimedia Interface, and the HDMI Logo are trademarks or registered trademarks of HDMI Licensing Administrator, Inc. in the United States and other countries.
- USB Type-C™ and USB-C™ are trademarks of USB Implementers Forum.
- Windows is either registered trademark or trademark of Microsoft Corporation in the United States and/or other countries.
- Mac, OS X and macOS are trademarks of Apple Inc., registered in the U.S. and other countries.
- App Store is a service mark of Apple Inc.
- Google, Android and Google Play are trademarks of Google LLC.
- The Bluetooth® word mark and logos are registered trademarks owned by Bluetooth SIG, Inc. and any use of such marks by Panasonic Corporation is under license. Other trademarks and trade names are those of their respective owners.
- The Wi-Fi CERTIFIED™ Logo is a certification mark of Wi-Fi Alliance®.
- The Wi-Fi Protected Setup™ Logo is a certification mark of Wi-Fi Alliance®.
- “Wi-Fi®” is a registered trademark of Wi-Fi Alliance®.
- “Wi-Fi Protected Setup™”, “WPA™”, and “WPA2™” are trademarks of Wi-Fi Alliance®.
- This product uses “DynaFont” from DynaComware Corporation. DynaFont is a registered trademark of DynaComware Taiwan Inc.
- QR Code is a registered trademark of DENSO WAVE INCORPORATED.
- Other names, company names, and product names mentioned in these instructions are trademarks or registered trademarks of the companies concerned.

This product incorporates the following software:

- (1) the software developed independently by or for Panasonic Corporation,
- (2) the software owned by third party and licensed to Panasonic Corporation,
- (3) the software licensed under the GNU General Public License, Version 2.0 (GPL V2.0),
- (4) the software licensed under the GNU LESSER General Public License, Version 2.1 (LGPL V2.1), and/or
- (5) open source software other than the software licensed under the GPL V2.0 and/or LGPL V2.1.

The software categorized as (3) - (5) are distributed in the hope that it will be useful, but WITHOUT ANY WARRANTY, without even the implied warranty of MERCHANTABILITY or FITNESS FOR A PARTICULAR PURPOSE. Please refer to the detailed terms and conditions thereof displayed by selecting [MENU/SET] ➔ [Setup] ➔ [Others] ➔ [Firmware Version] ➔ [Software info].

At least three (3) years from delivery of this product, Panasonic will give to any third party who contacts us at the contact information provided below, for a charge no more than our cost of physically performing source code distribution, a complete machine-readable copy of the corresponding source code covered under GPL V2.0 or LGPL V2.1, as well as the respective copyright notice thereof.

Contact Information: [oss-cd-request@gg.jp.panasonic.com](mailto:oss-cd-request@gg.jp.panasonic.com)

The source code and the copyright notice are also available for free in our website below.

<https://panasonic.net/cns/oss/index.html>

---

This product is licensed under the AVC Patent Portfolio License for the personal use of a consumer or other uses in which it does not receive remuneration to (i) encode video in compliance with the AVC Standard ("AVC Video") and/or (ii) decode AVC Video that was encoded by a consumer engaged in a personal activity and/or was obtained from a video provider licensed to provide AVC Video. No license is granted or shall be implied for any other use. Additional information may be obtained from MPEG LA, L.L.C.

See <http://www.mpegla.com>

# Useful Information (Only For Latin American Countries)

## Customer Service

### Customer Service Directory

Obtain products information and operative assistant; localize the closer distributor or Service Center; buy spare parts and accessories by our Web Site to Latin America or calling our Contact Center:

COUNTRY	WEB SITE	CONTACT CENTER
Panama	<a href="http://www.panasonic.com/pa/soporte/">www.panasonic.com/pa/soporte/</a>	800-7262
Colombia	<a href="http://www.panasonic.com/co/soporte/">www.panasonic.com/co/soporte/</a>	01-8000-947262
Ecuador	<a href="http://www.panasonic.com/pa/soporte/">www.panasonic.com/pa/soporte/</a>	1-800-726276
Costa Rica	<a href="http://www.panasonic.com/pa/soporte/">www.panasonic.com/pa/soporte/</a>	800-7262737
El Salvador	<a href="http://www.panasonic.com/pa/soporte/">www.panasonic.com/pa/soporte/</a>	800-7262
Guatemala	<a href="http://www.panasonic.com/pa/soporte/">www.panasonic.com/pa/soporte/</a>	1-801-811-7262
Uruguay	<a href="http://www.panasonic.com/pa/soporte/">www.panasonic.com/pa/soporte/</a>	0-800-7262
Paraguay	<a href="http://www.panasonic.com/pa/soporte/">www.panasonic.com/pa/soporte/</a>	0-800-11-7262
Chile	<a href="http://www.panasonic.com/cl/soporte/">www.panasonic.com/cl/soporte/</a>	800-390-602 022-797-5000
Peru	<a href="http://www.panasonic.com/pe/soporte/">www.panasonic.com/pe/soporte/</a>	0800-00726
Venezuela	<a href="http://www.panasonic.com/pa/soporte/">www.panasonic.com/pa/soporte/</a>	800-7262-800
Mexico	<a href="http://www.panasonic.com/mx/soporte/">www.panasonic.com/mx/soporte/</a>	800-847-7262 55-5000-1200
Argentina		0800-333-7262 0810-321-7262
Dominican Rep.	<a href="http://www.panasonic.com/pa/soporte/">www.panasonic.com/pa/soporte/</a>	809-200-8000

For Caribbean countries that speak english please enter this web site in order to find information of our products and operative assistant:

[www.panasonic.com/caribbean](http://www.panasonic.com/caribbean)