

Panasonic®

Owner's Manual

<Basic>

Digital Camera

Model No. **DC-G100**



LUMIX

Please read these instructions carefully before using this product, and save this manual for future use.

More detailed operating instructions are available in "Owner's Manual" (PDF format). To read it, download it from the website. (→3)

**Register online at <http://shop.panasonic.com/support>
(U.S. customers only)**

If you have any questions, visit:
USA : <http://shop.panasonic.com/support>
Canada : www.panasonic.ca/english/support

DVQX2040ZA
M0620KZ0



Dear Customer,
Thank you for choosing Panasonic!

You have purchased one of the most sophisticated and reliable products on the market today. Used properly, we're sure it will bring you and your family years of enjoyment. Please take time to fill in the information below. The serial number is on the tag located on the underside of your camera. Be sure to **retain this manual** as your convenient camera information source.

Date of Purchase	Dealer Phone No.
Dealer Purchased From	Model No.
Dealer Address	Serial No.

Please note that the actual controls and components, menu items, etc. of your Digital Camera may look somewhat different from those shown in the illustrations in this Owner's Manual.

Carefully observe copyright laws.

Recording of pre-recorded tapes or discs or other published or broadcast material for purposes other than your own private use may infringe copyright laws. Even for the purpose of private use, recording of certain material may be restricted.

More detailed explanations (PDF)

This document “Owner’s Manual (Basic)” provides a summary on basic operations. When sections in this “Owner’s Manual (Basic)” refer to PDF, you can find more detailed content in the “Owner’s Manual” (PDF format).

- You can find the descriptions of each function on the following pages that lists the functions of the camera.
 - List of Menu (→84)

❖ Reading the “Owner’s Manual” (PDF format)

To download the “Owner’s Manual” (PDF format) from a website, either enter the URL below directly, or scan the QR code.

- Click the desired language.

<https://panasonic.jp/support/dsc/oi/index.html?model=DC-G100&dest=P>



The URL and QR code above can also be confirmed on the monitor of the camera.

 ⇒ [] ⇒ Select [Online Manual]

Settings: [URL display]/[QR Code display]

- You will need Adobe Reader to browse or print the “Owner’s Manual” (PDF format). Download and install Adobe Reader from the following site (As of June 2020):
<http://www.adobe.com/products/acrobat/readstep2.html>

About Operating Instructions





❖ Symbols Used in This Document

Black icons show conditions in which these can be used, and gray icons show conditions in which these cannot be used.

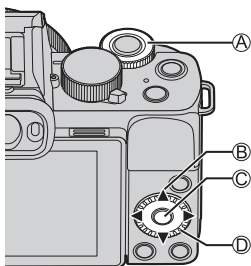
Example:  / 
Recording mode Pictures · Videos

Operating symbols







A		Front dial
B		Cursor button up/down/left/right
C		[MENU/SET] button
D		Control dial

- Other symbols, such as icons shown on the camera screen, are also used in explanations.
- This document describes the procedure for selecting menu items as follows:
Example) Set [Quality] of the [Rec] menu to .

 →  → [Quality] → Select .

Notification classification symbols

	To confirm prior to using the function
	Hints for better use of the camera and tips for recording
	Notifications and supplementary items regarding specifications
	Related information and page number

- The images and drawings of this document are an illustration to explain the functions.
- Description in these operating instructions is based on the interchangeable lens (H-FS12032).

Information for Your Safety

WARNING:

To reduce the risk of fire, electric shock or product damage,

- Do not expose this unit to rain, moisture, dripping or splashing.
- Use the recommended accessories.
- Do not remove covers.
- Do not repair this unit by yourself. Refer servicing to qualified service personnel.

The socket outlet shall be installed near the equipment and shall be easily accessible.

■ Product identification marking

Product	Location
Digital camera	Bottom
Tripod grip	Inside opened tripod legs

THE FOLLOWING APPLIES ONLY IN THE U.S.A.

FCC Note:

This equipment has been tested and found to comply with the limits for a Class B digital device, pursuant to Part 15 of the FCC Rules.

These limits are designed to provide reasonable protection against harmful interference in a residential installation. This equipment generates, uses, and can radiate radio frequency energy and, if not installed and used in accordance with the instructions, may cause harmful interference to radio communications. However, there is no guarantee that interference will not occur in a particular installation. If this equipment does cause harmful interference to radio or television reception, which can be determined by turning the equipment off and on, the user is encouraged to try to correct the interference by one or more of the following measures:

- Reorient or relocate the receiving antenna.
- Increase the separation between the equipment and receiver.
- Connect the equipment into an outlet on a circuit different from that to which the receiver is connected.
- Consult the dealer or an experienced radio/TV technician for help.

FCC Caution:

- Any unauthorized changes or modifications to this equipment would void the user's authority to operate this device.
- To assure continued compliance, follow the attached installation instructions and use only shielded interface cables with ferrite core when connecting to computer or peripheral devices.

This device complies with Part 15 of the FCC Rules. Operation is subject to the following two conditions: (1) This device may not cause harmful interference, and (2) this device must accept any interference received, including interference that may cause undesired operation.

Supplier's Declaration of Conformity

Trade name: Panasonic

Model No.: DC-G100

Responsible Party: Panasonic Corporation of North America

Two Riverfront Plaza, Newark, NJ 07102-5490

Support Contact: <http://shop.panasonic.com/support>

THE FOLLOWING APPLIES ONLY IN THE U.S.A.**How to Display Certification and Compliance Information**

Certification and compliance information for this camera can be viewed on the menu screen.



⇒ [] ⇒ Select [Approved Regulations]

Contains FCC ID: VPYLB1JS955

This transmitter must not be co-located or operated in conjunction with any other antenna or transmitter.

This equipment complies with FCC radiation exposure limits set forth for an uncontrolled environment and meets the FCC radio frequency (RF) Exposure Guidelines as this equipment has very low levels of RF energy.

Compliance with FCC requirement 15.407(c)

Data transmission is always initiated by software, which is then passed down through the MAC, through the digital and analog baseband, and finally to the RF chip. Several special packets are initiated by the MAC. These are the only ways the digital baseband portion will turn on the RF transmitter, which it then turns off at the end of the packet. Therefore, the transmitter will be on only while one of the aforementioned packets is being transmitted. In other words, this device automatically discontinues transmission in case of either absence of information to transmit or operational failure.

Frequency Tolerance: $\pm 20\text{ppm}$

THE FOLLOWING APPLIES ONLY IN CANADA.

How to Display Certification and Compliance Information

Certification and compliance information for this camera can be viewed on the menu screen.



⇒ [] ⇒ Select [Approved Regulations]

CAN ICES-3(B)/NMB-3(B)

Model: DC-G100
IC: 216A-DCG100

This device contains licence-exempt transmitter(s)/receiver(s) that comply with Innovation, Science and Economic Development Canada's licence-exempt RSS(s). Operation is subject to the following two conditions:

- (1) This device may not cause interference.
- (2) This device must accept any interference, including interference that may cause undesired operation of the device.

The available scientific evidence does not show that any health problems are associated with using low power wireless devices. There is no proof, however, that these low power wireless devices are absolutely safe. Low power Wireless devices emit low levels of radio frequency energy (RF) in the microwave range while being used. Whereas high levels of RF can produce health effects (by heating tissue), exposure of low-level RF that does not produce heating effects causes no known adverse health effects. Many studies of low-level RF exposures have not found any biological effects. Some studies have suggested that some biological effects might occur, but such findings have not been confirmed by additional research. DC-G100 has been tested and found to comply with ISED radiation exposure limits set forth for an uncontrolled environment and meets RSS-102 of the ISED radio frequency (RF) Exposure rules.

■ About the battery pack

CAUTION

Battery pack (Lithium ion battery pack)

- Use the specified unit to recharge the battery pack.
- Do not use the battery pack with equipment other than the specified unit.
- Do not get dirt, sand, liquids, or other foreign matter on the terminals.
- Do not touch the plug terminals (+ and -) with metal objects.
- Do not disassemble, remodel, heat or throw into fire.

If any electrolyte should come into contact with your hands or clothes, wash it off thoroughly with water.

If any electrolyte should come into contact with your eyes, never rub the eyes. Rinse eyes thoroughly with water, and then consult a doctor.

CAUTION

- Danger of explosion if battery is incorrectly replaced. Replace only with the type recommended by the manufacturer.
- When disposing of the batteries, please contact your local authorities or dealer and ask for the correct method of disposal.

- Do not heat or expose to flame.
- Do not leave the battery(ies) in a car exposed to direct sunlight for a long period of time with doors and windows closed.
- Do not expose to low air pressure at high altitudes.
- Do not expose to extremely low air pressure, as this may result in explosions or leakage of flammable liquids and gases.

Warning

Risk of fire, explosion and burns. Do not disassemble, heat above 60 °C (140 °F) or incinerate.

■ About the AC adaptor (supplied)

CAUTION!

To reduce the risk of fire, electric shock or product damage,

- **Do not install or place this unit in a bookcase, built-in cabinet or in another confined space. Ensure this unit is well ventilated.**

AC adaptor

This AC adaptor operates on AC between 110 V and 240 V.

But

- In the U.S.A. and Canada, the AC adaptor must be connected to a 120 V AC power supply only.
- When connecting to an AC supply outside of the U.S.A. or Canada, use a plug adaptor to suit the AC outlet configuration.

Cautions for Use

- Do not use any other USB connection cables except the supplied one.
- Do not use any other tripod grips except the supplied one or a genuine Panasonic tripod grip (DMW-SHGR1: optional).
- Use a "High Speed HDMI micro cable" with the HDMI logo.
Cables that do not comply with the HDMI standards will not work.
"High Speed HDMI micro cable" (Type D - Type A plug, up to 2 m (6.6 feet) long)
- Do not use the Stereo microphone cables with the length of 3 m (9.8 feet) or more.

Keep this unit as far away as possible from electromagnetic equipment (such as microwave ovens, TVs, video games etc.).

- If you use this unit on top of or near a TV, the pictures and/or sound on this unit may be disrupted by electromagnetic wave radiation.
- Do not use this unit near cell phones because doing so may result in noise adversely affecting the pictures and/or sound.
- Recorded data may be damaged, or pictures may be distorted, by strong magnetic fields created by speakers or large motors.
- Electromagnetic wave radiation may adversely affect this unit, disturbing the pictures and/or sound.
- If this unit is adversely affected by electromagnetic equipment and stops functioning properly, turn this unit off and remove the battery or disconnect AC adaptor. Then reinsert the battery or reconnect AC adaptor and turn this unit on.

Do not use this unit near radio transmitters or high-voltage lines.

- If you record near radio transmitters or high-voltage lines, the recorded pictures and/or sound may be adversely affected.

- To clean your camera, remove the battery, the DC coupler (DMW-DCC11: optional) or a card, or disconnect the power plug from the outlet, and wipe with a soft, dry cloth.
 - Do not press the monitor with excessive force.
 - Do not press the lens with excessive force.
 - Do not allow camera to come into contact with pesticides or volatile substances (can cause surface damage or coating to peel).
 - Do not keep rubber or plastic products in contact with the camera for a long period of time.
 - Do not use solvents such as benzine, thinner, alcohol, kitchen detergents, etc., to clean the camera, since it may deteriorate the external case or the coating may peel off.
 - Do not leave the camera with the lens facing the sun, as rays of light from the sun may cause it to malfunction.
 - Always use the supplied cords and cables.
 - Do not extend the supplied cord or cable.
 - While the camera is accessing the card (for an operation such as picture writing, reading, deletion, or formatting), do not turn off the camera or remove the battery, card, AC adaptor (DMW-AC10PP: optional) or DC coupler (DMW-DCC11: optional).
Furthermore, do not subject the camera to vibration, impact or static electricity.
 - The data on the card may be damaged or lost due to electromagnetic waves, static electricity or breakdown of the camera or the card. We recommend storing important data on a PC etc.
 - Do not format the card on your PC or other equipment. Format it on the camera only to ensure proper operation.
-

- **The battery is not charged when the camera is shipped. Charge the battery before use.**
- **The battery is a rechargeable lithium ion battery. If the temperature is too high or too low, the operating time of the battery will become shorter.**
- The battery becomes warm after using and during and after charging. The camera also becomes warm during use. This is not a malfunction.
- **Do not leave any metal items (such as clips) near the contact areas of the power plug or near the batteries.**
- Store the battery in a cool and dry place with a relatively stable temperature. (Recommended temperature: 15 °C to 25 °C (59 °F to 77 °F), Recommended humidity: 40%RH to 60%RH)
- **Do not store the battery for a long time while fully charged.** When storing the battery for a long period of time, we recommend charging it once a year. Remove the battery from the camera and store it again after it has completely discharged.

For the U.S.A. and Canada only



A lithium ion battery that is recyclable powers the product you have purchased. Please call 1-800-8-BATTERY for information on how to recycle this battery.

Contents

More detailed explanations (PDF)	3
About Operating Instructions	4
Information for Your Safety	5
1. Introduction	16
Before Use	16
Standard Accessories	18
Lenses That Can Be Used	20
Memory Cards That Can Be Used	21
Names of Parts	22
2. Getting Started	25
Attaching a Shoulder Strap	25
Charging the Battery	26
Inserting Cards (Optional)	31
Attaching a Lens	33
Adjusting the Monitor Direction and Angle	35
Setting the Clock (When Turning On for the First Time)	36
3. Basic Operations	38
Basic Recording Operations	38
Camera Setting Operations	41
Display Settings	43
Menu Operation Methods	44
Recording with the Tripod grip	47
4. Recording mode	51
Intelligent Auto Mode	51
5. Focus/Zoom	53
Selecting the Focus Mode	53
Using AF	54
Selecting the AF Mode	55
Record Using Manual Focus	56
Recording with Zoom	58
6. Drive/Image Stabilizer	59
Selecting the Drive Mode	59
Image Stabilizer	60

7. Brightness (Exposure)/Coloring/Picture effect	61
[Metering Mode]	61
Exposure Compensation	62
ISO Sensitivity	63
White Balance (WB)	65
8. Flash	67
Using a Flash	67
9. Recording Videos	68
Recording Videos	68
Creative Video Mode	71
Slow & Quick Mode	74
Video Settings (Audio)	77
10. Playing Back and Editing of Images	78
Playing Back Pictures	78
Playing Back Videos	79
Deleting Images	80
11. Camera Customization	81
Fn Buttons	81
12. Menu Guide	84
List of Menu	84
13. Connecting to Other Devices	88
Wi-Fi/Bluetooth	88
Importing Images to a PC	89
14. Materials	91
Digital Camera Accessory System	91
Specifications	92
Trademarks and Licenses	100
Limited Warranty (ONLY FOR U.S.A.)	103
Limited Warranty (ONLY FOR CANADA)	106

1. Introduction

Before Use

❖ Firmware of Your Camera/Lens

Firmware updates may be provided in order to improve camera capabilities or to add functionality. For smoother recording, we recommend updating the firmware of the camera/lens to the latest version.

- **For the latest information on the firmware or to download/update the firmware, visit the following support site:**
<https://panasonic.jp/support/global/cs/dsc/>
(English only)



- To check the firmware version of the camera/lens, attach the lens to the camera and select [Version Disp.] in the [Setup] menu.
- This document provides explanations for camera firmware version 1.0.

❖ Handling of the Camera

When using the camera, be careful not to drop it, bump it, or apply undue force. These may cause malfunction or damage to the camera and lens.

The camera is not dust resistant, splash resistant, or waterproof. Avoid using the camera in places with excessive dust or sand, or where water can come into contact with the camera.

If sand, dust, or liquids such as water droplets adhere to the monitor, wipe them off with a dry soft cloth.

- Touch operations may be incorrectly recognized.

Do not place a hand inside the camera mount.

This may cause a failure or damage because the sensor is a precision device.

❖ Condensation (When the Lens, the Viewfinder or Monitor is Fogged Up)

- Condensation occurs when there are temperature or humidity differences. Take care as this may lead to soiling, mold, and malfunctions in the lens, viewfinder, and monitor.
- If condensation occurs, turn off the camera and leave it for approx. 2 hours. The fog will disappear naturally when the temperature of the camera becomes close to the ambient temperature.

❖ Be Sure to Perform Trial Recording in Advance

Perform trial recording in advance of an important event (wedding, etc.) to check that recording can be performed normally.

❖ No Compensation Regarding Recording

Please note that compensation cannot be provided in the event that recording could not be performed due to a problem with the camera or a card.

❖ Be Careful with Regard to Copyrights

Under copyright law, you may not use the images and audio you have recorded for other than personal enjoyment without the permission of the copyright holder. Be careful because there are cases where restrictions apply to recording even for the purpose of personal enjoyment.

❖ Also Refer to the Cautions for Use in the “Owner’s Manual” (PDF format)

Refer to the “Owner’s Manual” (PDF format) for details about the following. (→3)

- Message Displays (→[PDF](#))
- Troubleshooting (→[PDF](#))

Standard Accessories

Digital camera body

(Digital camera body is referred to as **camera** in this document.)

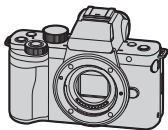

Check that all the accessories are supplied before using the camera. (Product numbers correct as of June 2020.)



Battery pack

DMW-BLG10PP

(This is indicated as **battery pack** or **battery** in the text.)

- Charge the battery before use.



USB connection cable

K1HY04YY0106

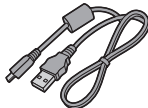

AC adaptor

SAE0012A

- This is used for charging.



Shoulder strap

VFC5167

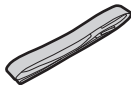

Hot shoe cover*1

SKF0106K









- **The memory card is optional.**
- Some digital camera kits may not be commercially available in some regions.
- Please dispose of all packaging appropriately.
- Keep small parts in a safe place out of the reach of children.

(For U.S.A. only)

- If accessories are lost, customers can visit us at <http://shop.panasonic.com/support> for further information about obtaining replacement parts.

(For Canada only)

- If any accessories are lost, customers in Canada should visit our support page at www.panasonic.ca/english/support for further information about obtaining replacement parts.

	DC-G100K	DC-G100V
1	 H-FS12032*1	 H-FS12032*1
2	 SYF0059	 SYF0059
3	—	 DMW-SHGR1
4	—	 DVPW1022Z

1	Interchangeable Lens (This is indicated as lens in the text.)
2	Lens Cap*2
3	Tripod grip
4	Hand strap (For the tripod grip)

*1 This is attached to the camera body at the time of purchase.

*2 This is attached to the interchangeable lens at the time of purchase.

Lenses That Can Be Used

This unit can use the dedicated lenses compatible with the Micro Four Thirds™ System lens mount specification (Micro Four Thirds mount).



You can also use a lens of any of the following standards by attaching a mount adaptor.

Lens	Mount adaptor
Four Thirds™ mount specification lens 	Mount Adaptor (DMW-MA1: optional)
Leica M Mount interchangeable lens	M Mount Adaptor (DMW-MA2M: optional)
Leica R Mount interchangeable lens	R Mount Adaptor (DMW-MA3R: optional)

❖ About the lens and functions

Depending on the lens used, certain functions, such as Auto Focus, Image Stabilizer, and zoom functions, may be disabled or operate differently.

- **Refer to catalogs/websites for most current information regarding supported lenses.**
<https://panasonic.jp/support/global/cs/dsc/>
 (English only)



- The focal length noted on the Micro Four Thirds lens is equivalent to double when converted to the 35 mm film camera. (It will be equivalent to 100 mm lens when a 50 mm lens is used.)

Memory Cards That Can Be Used

You can use the following memory cards with this camera.

- SD memory card, SDHC memory card, and SDXC memory card are referred to by the generic name of **card** in this document.

SD memory card (512 MB to 2 GB)	<ul style="list-style-type: none"> • The camera supports SDHC/SDXC memory cards compliant with UHS Speed Class 3 of the UHS-I standard. • Operation with the Panasonic cards on the left has been verified.
SDHC memory card (4 GB to 32 GB)	
SDXC memory card (48 GB to 128 GB)	

When using the following functions, use cards that have the correct SD Speed Class, UHS Speed Class and Video Speed Class.

- Speed classes are standards to guarantee the minimum speed necessary for continuous writing.

Function	[Rec Quality]	Speed Class	Example of indication
Video recording	[FHD]/[HD]	Class 4 or higher	CLASS 4 4
	[4K]	UHS Speed Class 3	U3
[4K PHOTO]/ [Post Focus]	—	Video Speed Class 30 or higher	V30



- You can prevent the writing and deleting of data by setting the write-protect switch (A) on the card to "LOCK".
- The data stored on a card may be damaged due to electromagnetic waves, static electricity or a failure of the camera or card. We recommend backing up important data.
- Keep the memory card out of reach of children to prevent swallowing.

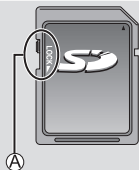

Names of Parts

Camera

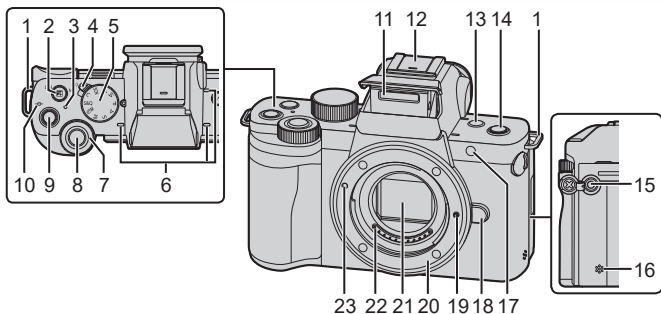

1	Shoulder strap eyelet (→25)		
2	[] (Exposure compensation) button (→62)/ Fn button (Fn1) (→81)	12	Hot shoe (hot shoe cover) • Keep the hot shoe cover out of reach of children to prevent swallowing.
3	Charging lamp (→29)/ WIRELESS connection lamp (→88)	13	[LVF] button (→43) Fn button (Fn3) (→81)
4	Camera on/off switch (→36)	14	[] ([Send Image (Smartphone)]) button/ Fn button (Fn4) (→81)
5	Mode dial (→40)	15	[MIC] socket
6	Stereo microphone • Do not block the microphone with a finger. Audio will be difficult to record.	16	Speaker
7	Front dial (→41)	17	Self-timer light/ AF assist light
8	Shutter button (→38)	18	Lens release button (→33)
9	Video rec. button (→39, 68)	19	Lens lock pin
10	[] (Recording distance reference mark)	20	Mount
11	Flash (→38, 67)	21	Sensor
		22	Contact points
		23	Lens fitting mark (→33)

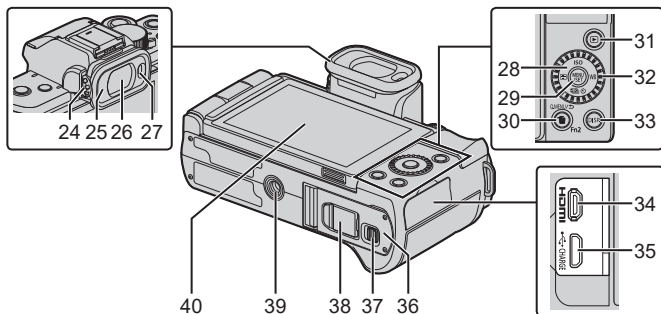

24	Diopter adjustment dial (→43)	36	Card/Battery door (→26, 31)	
25	Eye cup	37	Release lever (→26, 31)	
26	Viewfinder (→43)	38	DC Coupler cover (→91)	
27	Eye sensor (→43)		<ul style="list-style-type: none"> When using an AC adaptor, ensure that the Panasonic DC Coupler (DMW-DCC11: optional) and AC Adaptor (DMW-AC10PP: optional) are used. Always use a genuine Panasonic AC Adaptor (DMW-AC10PP: optional). 	
28	Cursor buttons (→42)/ [ISO] (ISO sensitivity) (▲) (→63)		39	Tripod mount (→48)
	[WB] (White balance) (▶) (→65)			<ul style="list-style-type: none"> If you attempt to attach a tripod with a screw length of 5.5 mm (0.22 inch) or more, you may not be able to securely fix it in place or it may damage the camera.
	[4K] (Drive mode) (▼) (→59)			40
[AF] (AF Mode) (◀) (→54)				
29	[MENU/SET] button (→42, 44)			
30	[] (Delete) button (→80)/ [Q.MENU] button/ [] (Cancel) button (→45)/ Fn button (Fn2) (→81)			
	31	[] (Playback) button (→78)		
	32	Control dial (→41)		
33	[DISP.] button			
34	[HDMI] socket			
35	[USB/CHARGE] socket (→28)			

→ • Use [Fn5] to [Fn9] (Touch Icons) (→83)

Lens

H-FS12032

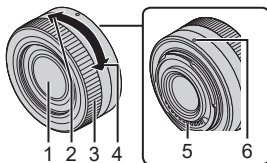

- | | |
|---|-------------------------|
| 1 | Lens surface |
| 2 | Tele |
| 3 | Zoom ring (→58) |
| 4 | Wide |
| 5 | Contact point |
| 6 | Lens fitting mark (→33) |

Tripod grip

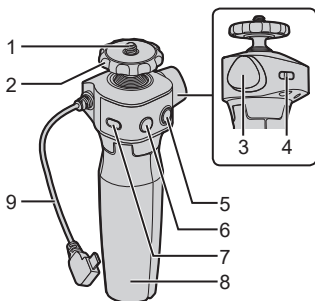

- | | |
|---|-------------------|
| 1 | Camera screw |
| 2 | Camera stand |
| 3 | Fastening knob |
| 4 | Hand strap eyelet |
| 5 | Video rec. button |
| 6 | Shutter button |
| 7 | Sleep button |
| 8 | Grip |
| 9 | Connection cable |

- For information on how to attach the camera and operate the tripod grip, refer to page 47.

2. Getting Started

Attaching a Shoulder Strap

Attach a shoulder strap to the camera with the following procedure to prevent it from dropping.

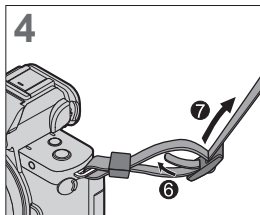
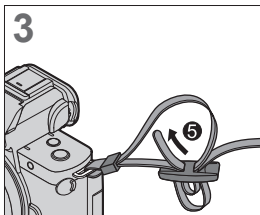
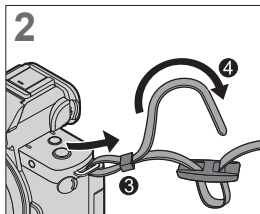
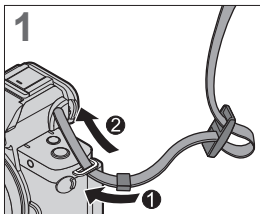

- Pull the shoulder strap and check that it will not come out.
- Attach the opposite end of the shoulder strap with the same procedure.
- Use the shoulder strap around your shoulder.
 - Do not wrap the strap around your neck.
It may result in injury or accident.
- Do not leave the shoulder strap where an infant can reach it.
 - It may result in an accident by mistakenly wrapping around the neck.

Charging the Battery

Insert the battery in the camera and charge it.

- The battery that can be used with the camera is DMW-BLG10PP. (As of June 2020)



- The battery is not charged at the time of purchase. Charge the battery before use.
- Check that this unit is turned off.

Battery Insertion

- Always use genuine Panasonic batteries (DMW-BLG10PP).
- If you use other batteries, we cannot guarantee the quality of this product.

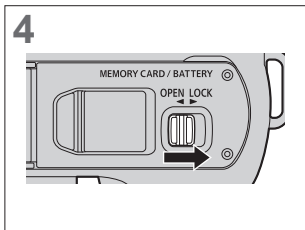
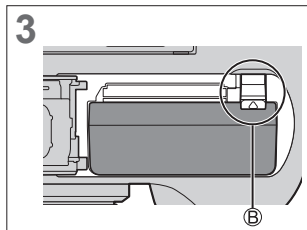
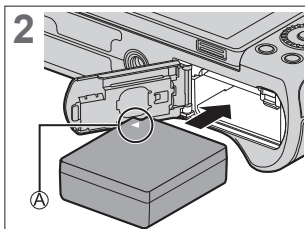
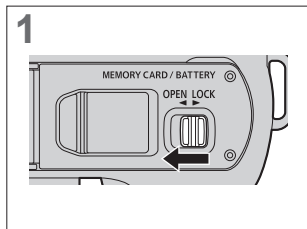

- Ⓐ Make sure to insert the battery in the correct orientation.
- Ⓑ Check that the lever is holding the battery in place.

❖ Removing the Battery

Push the lever in the direction of the arrow.

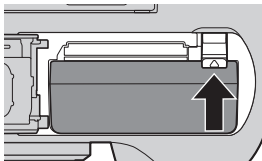

- Remove the battery after use.
(The battery will drain if left inserted in the camera for a long period of time.)
- To remove the battery, turn the camera off and wait until the LUMIX indicator on the screen goes off. (Failure to wait may cause the camera to malfunction and may damage the card or recorded data.)
- The battery becomes warm after use, during charging, and immediately after charging.
The camera also becomes warm during use. This is not a malfunction.
- Be careful when removing the battery as the battery will jump out.

Charging battery

Charging time
Approx. 190 min.

- Using the camera body and the supplied AC adaptor.
- The indicated charging time is for when the battery has been discharged completely.
The charging time may vary depending on how the battery has been used.
The charging time for the battery in hot/cold environments or a battery that has not been used for a long time may be longer than normal.



- Use the products supplied with the camera for charging.

1 Set the camera on/off switch to [OFF].

- The camera cannot be charged when it is turned on.

2 Insert the battery into the camera.

3 Connect the camera [USB/CHARGE] socket and the AC adaptor using the USB connection cable.

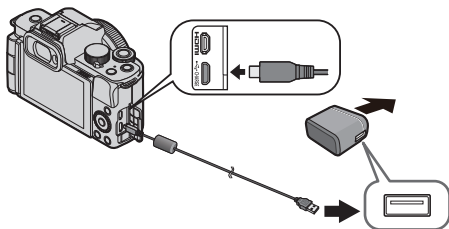

- Hold the plugs and insert them straight in or pull them straight out.
(Inserting these at an angle may cause deformation or malfunction)

4 Insert the AC adaptor into the electrical outlet.

- The charging lamp blinks red and charging begins. (→29)

❖ Charging lamp indications

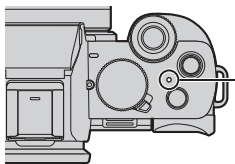

Charging lamp (Red)

On: Charging in progress

Off: Charging complete

Flashing: Charging error



- You can also charge the battery by connecting a USB device (PC, etc.) and the camera with the USB connection cable.
In that case, charging may take a while.



- Do not use any other USB connection cables except the supplied one.
This may cause malfunction.
- Do not use any other AC adaptors except the supplied one.
This may cause malfunction.
- After charging, disconnect the connection to the power source.
- When the charging lamp is blinking, the battery is not charging properly.
 - The temperature of the battery or surroundings is either too high or too low. Try charging at an ambient temperature between 10 °C and 30 °C (50 °F and 86 °F).
 - The terminals of the battery are dirty.
Remove the battery and wipe off the dirt with a dry cloth.
- Even when the camera on/off switch is set to [OFF] thus turning the camera off, it consumes power.
When the camera will not be used for a long time, remove the power plug from the electrical outlet in order to save power.

Notifications Regarding Charging

❖ Power Indications

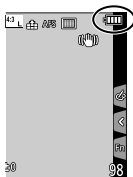

	75% or higher
	74% to 50%
	49% to 25%
	24% or below
<p>Blinking in red</p>	<p>Low battery</p> <ul style="list-style-type: none"> • Charge or replace the battery.

- The battery level indicated on the screen is approximate.



- **To ensure that safe products are used, we recommend that a genuine Panasonic battery pack is used. There is a possibility that other battery packs may lead to fire or explosion. Please be advised that we are not liable for any accident or failure occurring as a result of use of a counterfeit battery pack.**
- Do not leave any metal items (such as clips) near the contact areas of the power plug.
Otherwise, a fire and/or electric shocks may be caused by short-circuiting or the resulting heat generated.
- Do not use the AC adaptor or USB connection cables on other devices.
This may cause a malfunction.
- Do not use USB extension cables or USB conversion adaptors.
- The battery can be charged even when it still has some charge left, but it is not recommended that the battery charge be frequently topped up while the battery is fully charged.
(Since characteristic swelling may occur.)
- If there is a power outage or other problem with the electrical outlet, then charging may not complete successfully.
Reconnect the power plug.

Inserting Cards (Optional)

- Make sure that the camera is turned off.

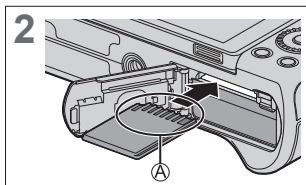
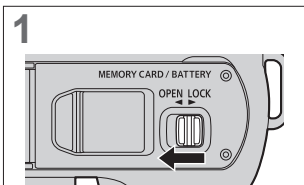

- A Do not touch the card connection contacts.

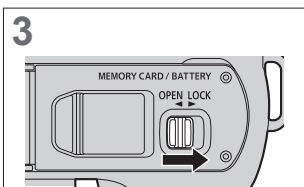

❖ Card Access Indications

The access indication displays red while the card is being accessed.



❖ Removing a Card

Push the card until it clicks and then pull the card out straight.

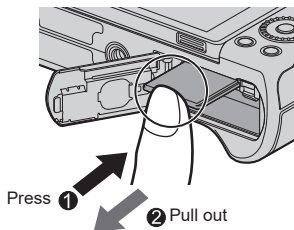



- To remove the card, turn the camera off and wait until the LUMIX indicator on the screen goes off. (Failure to wait may cause the camera to malfunction and may damage the card or recorded data.)
- The card may be warm just after the camera has been used. Be careful when removing.
- **Do not perform the following operations during access. The camera may operate incorrectly or the card and recorded images may be damaged.**
 - Turn off the camera.
 - Remove the battery or card, or disconnect the AC adaptor (optional) or DC coupler (optional).
 - Subject the camera to vibration, impacts, or static electricity.

Formatting Cards (Initialization)

Format the cards with the camera before use.



- **When a card is formatted, all of the data stored in the card is erased and cannot be restored. Save a backup of necessary data before formatting the card.**



→ [] → Select [Format]



- Do not turn off the camera or perform another operation during formatting.
- Take care not to turn off the camera while formatting is in progress.
- If the card has been formatted with a PC or other device, format it again with the camera.

Attaching a Lens



- Make sure that the camera is turned off.
- Change the lens in a location where there is not a lot of dirt and dust.
- When attaching or detaching the interchangeable lens (H-FS12032), retract the lens barrel.

Align the lens fitting marks  on the lens and camera and then rotate the lens in the direction of the arrow.

- Attach the lens by rotating it until it clicks.

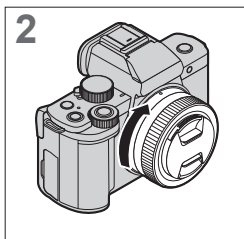
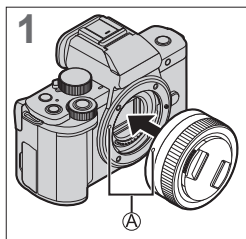

- Insert the lens straight in.

❖ Removing a Lens

- 1 Set the camera on/off switch to [OFF].
- 2 While pressing the lens release button , rotate the lens in the direction of the arrow until it stops and then remove it.

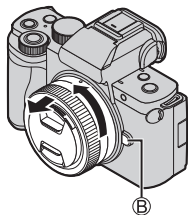

- After removing the lens, be sure to attach the body cap and the lens rear cap.

Extending/retracting the lens <when the interchangeable lens (H-FS12032) is attached>

❖ How to Extend the Lens

Rotate the zoom ring in the direction of arrow ① from position ① (the lens is retracted) to position ② <12 mm to 32 mm> to extend the lens.

- When the lens barrel is retracted, images cannot be recorded.

③ The lens is retracted

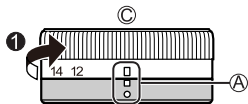

❖ How to Retract the Lens

Rotate the zoom ring in the direction of arrow ② from position ② <12 mm to 32 mm> to position ① to retract the lens.

- The zoom ring will seem to click into the 12 mm position, but continue to rotate the lens until it reaches position ①.
- When you are not recording images, we recommend that you retract the lens.

④ The lens is extended

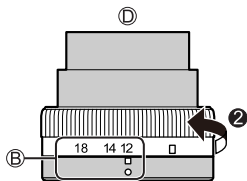

Adjusting the Monitor Direction and Angle

At the time of purchase, the monitor is stowed in the camera body. Turn the monitor surface out before use.

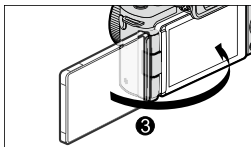
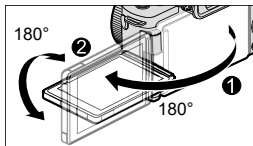

❖ Free angle shooting

You can rotate 180° towards the lens and 90° downwards.

Taking pictures at a low angle

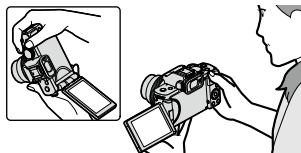

Taking pictures at a high angle

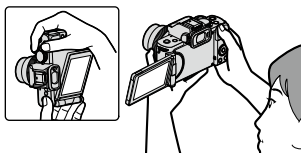

❖ Taking pictures of yourself

If you rotate the monitor as shown in the figure, the camera will switch to Self Shot Mode.

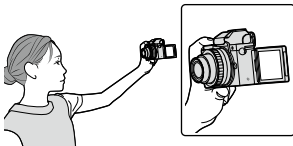

- The angles of adjustment are only guides.
- Do not apply an excessive force to the monitor. This may cause damage or malfunction.
- When not using the camera, close the monitor with the monitor surface facing in.

Setting the Clock (When Turning On for the First Time)

When you turn the camera on for the first time, a screen to set the clock and home area appears.

Be sure to set these settings before use to ensure images are recorded with the correct date and time information.

- 1 **Set the camera on/off switch to [ON].**

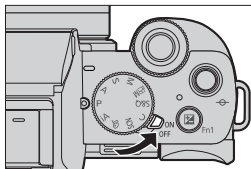

- 2 **When [Please set the language] appears, press .**

- 3 **Set the language.**



- Press ▲▼ to select the language and then press .

- 4 **When [Please set the clock] appears, press .**

- 5 **Set the clock.**

- ◀▶: Select an item (year, month, day, hour or minute).

- ▲▼: Select a value.

To set the display order  and time display format .

- Press ▶ to select the time zone [Style] and then press , the screen for setting the display order and time display format appears.

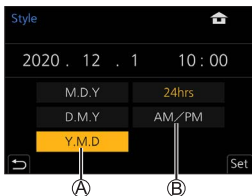
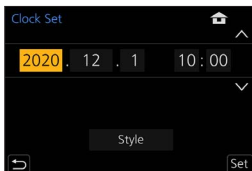

6 Confirm your selection.

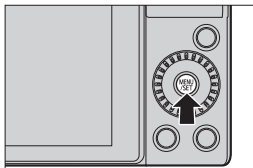

- Press .



7 When [The clock setting has been completed.] appears, press .

8 When [Please set the home area] is displayed, press .

9 Set the home area.

- Press   to select your home area and press .

- ⓐ Time difference from GMT (Greenwich Mean Time)



- When an interchangeable lens (H-FS12032) is used and the lens barrel is retracted, recording is not possible (a message will be displayed). Rotate the zoom ring to extend the lens. (→ 34)



- If the camera is used without setting the clock, it will be set to 0:00:00, January 1st, 2020.
- Clock settings are maintained for approx. 3 months using the built-in clock battery even without the battery.
(Leave the fully-charged battery in the camera for approx. 24 hours to charge the built-in battery.)



- [Clock Set] can be changed from the menu:
–  → [Clock Set]

3. Basic Operations

Basic Recording Operations

How to Hold the Camera

Hold the camera with both hands, keep your arms still at your side, and stand with your feet shoulder width apart.

- Do not block the flash, AF Assist Lamp, microphone, or speaker with your fingers or other objects.

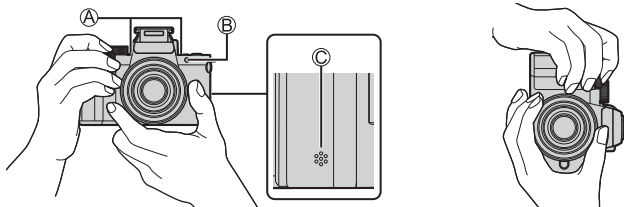

- Ⓐ Microphone
- Ⓑ AF Assist Lamp
- Ⓒ Speaker

Taking Pictures

1 Adjust the focus.

- Press the shutter button halfway (press it gently).

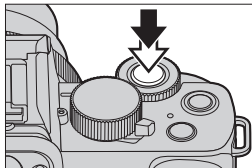

- The aperture value (A) and shutter speed (B) are displayed.
(If the aperture value and shutter speed are shown in red and flashing, you do not have the appropriate exposure, unless you are using the flash.)
- Once the subject is in focus, the focus indication (C) lights.
(When the subject is not in focus, the indication blinks.)

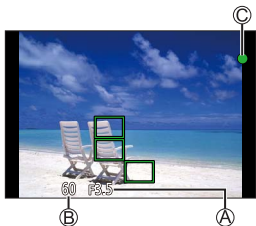

2 Start recording.

- Press the shutter button fully (press it further).

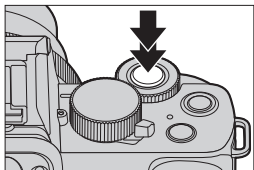

- With the default settings, you cannot take a picture until the subject is brought into focus.
If you set [Focus/Release Priority] in the [Custom] ([Focus / Release Shutter]) menu to [BALANCE] or [RELEASE], you will be able to take a picture even when the subject is not in focus.

Recording Videos

1 Start recording.

- Press the video rec. button.
- Release the video rec. button right after you press it.

2 Stop recording.



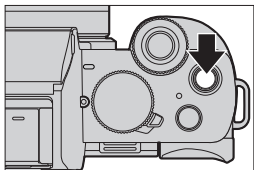

- Press the video rec. button again.

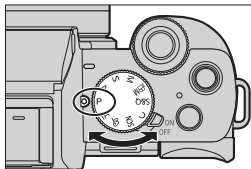

Selecting the Recording Mode

Rotate the mode dial.



iA	 Intelligent Auto mode (→51)
	 Intelligent Auto Plus mode (→52)
P	Program AE mode <ul style="list-style-type: none"> The camera automatically sets the shutter speed and aperture value for the brightness of the subject. (→PDF)
A	Aperture-Priority AE mode <ul style="list-style-type: none"> You can set the aperture value before recording. The shutter speed will be automatically set by the camera. (→PDF)
S	Shutter-Priority AE mode <ul style="list-style-type: none"> You can set the shutter speed before recording. The aperture value will be automatically set by the camera. (→PDF)
M	Manual Exposure mode <ul style="list-style-type: none"> You can take pictures by manually setting the aperture value and shutter speed. (→PDF)
 M	Creative Video mode (→71)
S&Q	Slow & Quick mode (→74)
C	Custom mode <ul style="list-style-type: none"> You can register your own settings. (→PDF)
SCN	Scene Guide mode <ul style="list-style-type: none"> This mode allows you to take pictures that match the scene being recorded. (→PDF)
	Creative Control mode <ul style="list-style-type: none"> This mode records with additional image effects. (→PDF)

Camera Setting Operations

When changing the camera settings, operate the camera using the following operation parts.

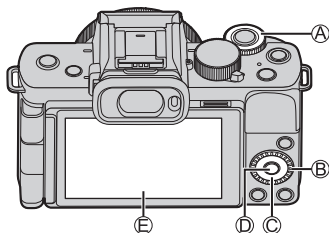

(A)	Front dial (→41)
(B)	Control dial (→41)
(C)	Cursor buttons (→42)
(D)	[MENU/SET] button (→42)
(E)	Touch screen (→42)

❖ Front Dial (☀️)/Control Dial (⚙️)

Rotate:

Selects an item or numeric value.

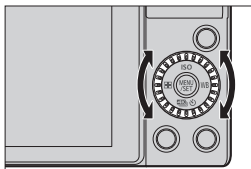
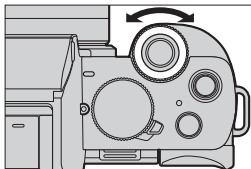

❖ Cursor Buttons (▲▼◀▶)

Press:

Selects an item or numeric value.

❖ [MENU/SET] Button (MENU/SET)

Press:

Confirms a setting.

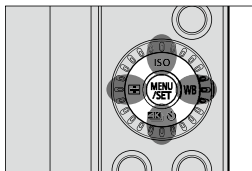

❖ Touch Screen

Operations can be performed by touching the icons, slide bars, menus, and other items displayed on the screen.

Ⓐ Touch

Operation of touching and then lifting your finger from the touch screen.

Ⓑ Drag

Operation of moving a finger while it touches the touch screen.

Ⓒ Pinch (widen/narrow)

Operations of widening the distance between two fingers (pinch out) and narrowing the distance between two fingers (pinch in) while they are touching the touch screen.

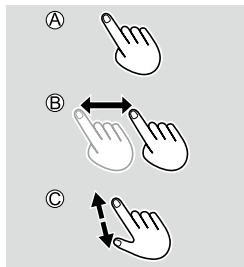

- If you will use a commercially available monitor protection sheet, observe the precautions for the sheet.
(Visibility and operability may be impaired depending on the type of monitor protection sheet.)



- Touch operations can be disabled:
[wrench icon] → [sun icon] → [Touch Settings]

Display Settings

Adjusting the Viewfinder Diopter

Rotate the diopter adjustment dial while looking through the viewfinder.

- Adjust until you can clearly see the text on the viewfinder.

Ⓐ Diopter adjustment dial

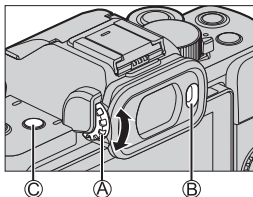

Switching Between the Monitor and Viewfinder

With the default settings, automatic viewfinder/monitor switching is set. When you look through the viewfinder, the eye sensor Ⓑ works and the camera switches from monitor display to viewfinder display.

Press [LVF] Ⓒ to switch the display.

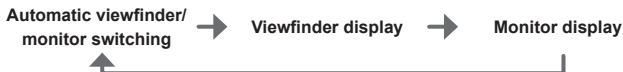

- If [LVF Display Speed] is set to [ECO 30fps] when the viewfinder is used, the camera can be operated for a longer period since battery drainage is reduced.



- In Self Shot Mode, the display automatically switches to monitor display, and the [LVF] and eye sensor are disabled.
- During video playback or slide show, automatic viewfinder/monitor switching does not work.

Menu Operation Methods

In this camera, the menu is used for setting a wide variety of functions and performing camera customizations.





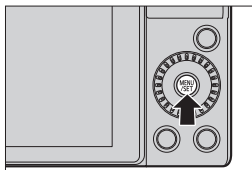

Menu operations can be performed using the cursors, dial, or by touch.

1 Display the menu.

- Press .







2 Switch the menu type.

- 1 Press .
- 2 Press   to select a tab such as .
 - You can also select the tab by rotating  or .
- 3 Press .



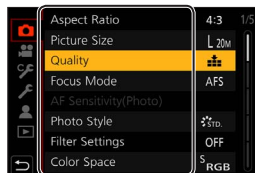

3 Select a menu item.

- Press   to select a menu item and then press .
- You can also perform the same operation by rotating  to select the menu item and then pressing .



4 Select a setting item and then confirm your selection.

- Press ▲ ▼ to select a setting item and then press .
- You can also perform the same operation by rotating  to select the setting item and then pressing .

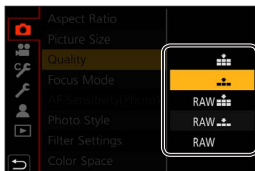

5 Close the menu.

- Press the shutter button halfway.
- You can also close the menu by pressing  several times.



• For details about menu items, refer to Menu Guide. ()

❖ Displaying Descriptions About Menu Items and Settings

If you press [DISP.] while a menu item or setting item is selected, a description about the item is displayed on the screen.



❖ Grayed Out Menu Items

Menu items that cannot be set are displayed grayed out.

In some setting conditions, the reason the setting is disabled is displayed when you press  if you select a grayed-out item.

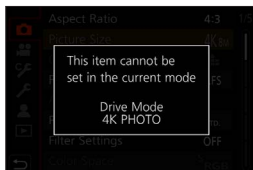

[Reset]

Return each of the following settings to the default setting:

- Recording settings
- Network settings (settings of [Wi-Fi Setup] and [Bluetooth])
- Custom settings ([Face Recog.] and [Profile Setup] settings)
- Setup/custom settings
(except for [Wi-Fi Setup], [Bluetooth], [Face Recog.] and [Profile Setup] settings)

 ⇒  ⇒ Select [Reset]



- When the setup/custom settings are reset, the following settings are also reset:
 - The [World Time] setting
 - The [Travel Date] setting (Departure date, Return date, [Location])
 - The settings of [Rotate Disp.], [Picture Sort] and [Delete Confirmation] in the [Playback] menu
- Folder numbers and clock settings will not be reset.

Recording with the Tripod grip

It can be used as a grip for recording while walking. You can take pictures or record video without operating the camera. It can also be used as a tripod.

- Use the tripod grip supplied with the DC-G100V or the tripod grip (optional: DMW-SHGR1).



- Insert the battery pack and a memory card into the camera before mounting it to the tripod grip.
- Do not use any other tripod grips except the supplied one or a genuine Panasonic tripod grip (DMW-SHGR1: optional).
- After usage, remove the tripod grip from the camera.
- Be careful not to get your finger or any other part of your body caught.
- The carrying capacity (total mass of the loading camera body, lens, battery, and other attached accessories) is 1.2 kg (2.65 lb).
(When the carrying capacity is exceeded, it may cause injuries or damage.)
- Confirm that the tripod grip is securely attached to the camera before using it.
- Do not carry the tripod grip only with the hand strap while the camera is attached.
- Depending on the camera angle or the lens and accessories attached, it may not balance and become unstable. Do not use it as a tripod when the tripod grip is in an unstable state.
- Do not carry it holding only the legs while the tripod's legs are open.

Attaching the Hand Strap

- Ⓐ Hand strap eyelet

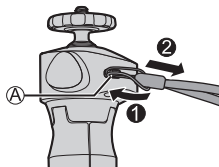

Attaching the camera to a tripod grip

- Hold the camera and tripod grip tightly, and securely attach them so that they do not drop.
- For removal, perform the steps backwards.

1 Set the Camera on/off switch to [OFF].

2 Loosen the camera stand.

- Turn the fastening knob in the direction of ①.

- ① Camera stand
- ② Fastening knob

3 Attach the camera to a tripod grip.

- Align the camera screw with the tripod mount on the camera. Turn the camera stand in the direction of ③, and tighten it firmly.

4 Lock the camera stand.

- Adjust the orientation of the camera. Turn the fastening knob in the direction of ④, and tighten it firmly.
- The camera stand can be tilted 40 degrees in any direction.

5 Connect the camera with the connection cable.

- Connect the connection cable into the camera's [USB/CHARGE] socket.
- Check the direction of the terminals and plug in/out straight holding onto the plug. (Inserting at an angle can deform the terminal and cause malfunction.)

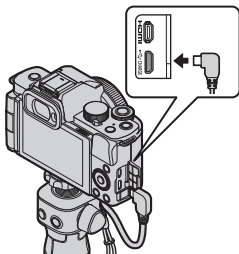
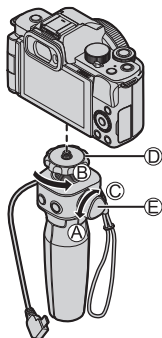

Using as a grip

To prevent dropping, be sure to attach the supplied strap and fit it to your wrist.

1 Close the tripod grip's legs, put your wrist through the hand strap and grip it.

- Slide adjuster (A), and secure the hand strap onto your wrist.
- When adjusting the direction of the camera, hold the camera with your hand and loosen the fastening knob to adjust the direction. After adjusting, securely tighten the fastening knob

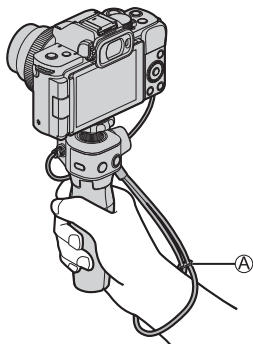

2 Press the button and record.

❖ Self-shooting style

If you attach the camera to the direction shown and rotate the monitor, you can record in Self Shot Mode.

- Refer to the "Owner's Manual" (PDF format) for details about Self Shot Mode. (→ [PDF](#))

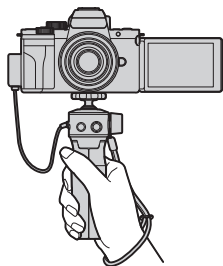

❖ Taking pictures

- 1 Focus on the subject.
 - Press the shutter button (B) halfway (press lightly).
- 2 Take a picture.
 - Press the shutter button fully (push the button all the way).

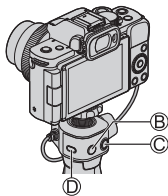

❖ Recording video

- 1 Start recording.
 - Press the video rec. button (C).
 - Immediately release the video rec. button after pressing it.
- 2 End recording.
 - Press the video rec. button again.

❖ Sleep button (D)

Press: The camera will go into a sleep (power save) status.

- This is the same state as [Sleep Mode] under [Economy]. (→PDF)
- When the camera is under a status where [Sleep Mode] does not work, the camera will not enter sleep status.
- The camera can enter sleep status even when [Sleep Mode] is set to [OFF].
- To wake the camera up from sleep, press the shutter button halfway down.

Using as a tripod

- 1 Open the legs of the tripod grip.
- 2 Place it in a level and stable place.

- When adjusting the direction of the camera, hold the camera with your hand and loosen the fastening knob to adjust the direction. After adjusting, securely tighten the fastening knob.

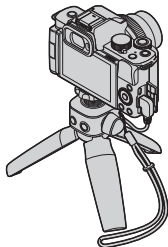

4. Recording mode

For information on the [iM] mode and [S&Q] mode (→71, 74)

For information on the [C] mode (→[PDF])

Intelligent Auto Mode



In the [iA] mode (Intelligent Auto mode), the camera detects the scene to set the optimal recording settings automatically to match the subject and recording conditions.

1 Set the mode dial to [iA].

- In default settings, the mode is set to Intelligent Auto Plus Mode.

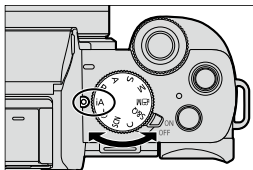

2 Aim the camera at the subject.

- When the camera detects the scene, the recording mode icon changes.
(Automatic Scene Detection)



3 Adjust the focus.

- Press the shutter button halfway.
- Once the subject is in focus, the focus indication lights.
(When the subject is not in focus, the indication blinks.)

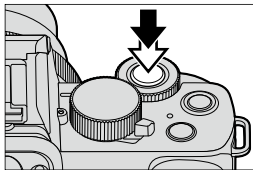

4 Start recording.

- Press the shutter button fully.



- Backlight compensation operates automatically to prevent subjects from appearing dark when there is a backlight.

❖ Intelligent Auto Plus Mode

[**iA⁺**] allows you to adjust some settings such as the brightness and color tone while also using [**iA**] for other settings so that you can record pictures more suited to your preferences.



→ [**iA**]/[**iA⁺**] → Select [Intelligent Auto Mode]

Settings: [**iA**] (Intelligent Auto Mode)/

[**iA⁺**] (Intelligent Auto Plus Mode)

❖ [AF Mode]

[AF Mode] is automatically set to [**Face/Eye**] ([Face/Eye Detection]).

- If you touch the subject, the camera switches to [**Tracking**] ([Tracking]) and the AF tracking function starts operating.
- Each press of [**AF Mode**] (◀) changes the AF mode.

❖ Flash

When recording using a flash, the camera switches to the appropriate flash mode for the recording conditions.



- When [**Red-Eye**] or [**Red-Eye**], Red-Eye Removal works.
- When Slow Sync. ([**Slow Sync.**], [**Slow Sync.**]), be careful with regard to camera shake because the shutter speed becomes slow.

5. Focus/Zoom

Selecting the Focus Mode



Select the focusing method (focus mode) to match subject movement.

Set the Focus Mode.

→ / → [Focus Mode]

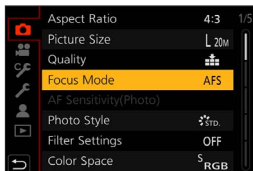

[AFS]	This is suitable for recording still subjects. When the shutter button is pressed halfway, the camera focuses once. The focus stays locked while the shutter button is pressed halfway.
[AFF]*1	This is suitable for recording subjects with movements that cannot be predicted. If the subject moves while the shutter button is pressed halfway, the focus is readjusted automatically according to the movement of the subject.
[AFC]*1	This is suitable for recording moving subjects. While the shutter button is pressed halfway, the focus is constantly adjusted according to the movement of the subject.
[MF]	Manual focusing. Use this when you want to fix the focus or avoid activating AF. (→56)

*1 This predicts the movement of the subject, maintaining focusing. (Movement prediction)

Using AF



AF (Auto Focus) refers to automatic focusing.

Select the focus mode and the AF mode appropriate for the subject and scene.

1 Set the Focus Mode. (→53)

- → [Camera/Video icon] → [Focus Mode] → [AFS]/[AFF]/[AFC]

2 Select AF mode.

- Press [] (◀) to display the AF mode selection screen, and set using . (→55)
- In []/[] mode, each press of [] (◀) switches between [] and []. (→52)

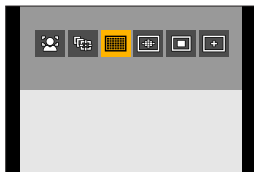

3 Press the shutter button halfway.

- The AF operates.

- Ⓐ Focus display
- Ⓑ AF area

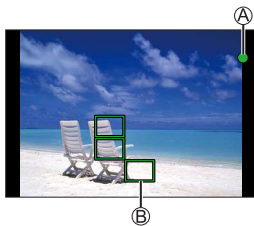

	Focus	
	In focus	Not in focus
Focus display	Lights	Blinking
AF area	Green	—
AF beep	Two beeps	—

Selecting the AF Mode



Select the focusing method to match the position and number of subjects.

1 Press (◀).

2 Select the AF mode.

- Press ◀▶ to select an item and then press .
- Selection is also possible by rotating or .

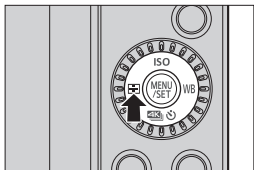

<p>[Face/Eye Detection] (→PDF)</p>	<p>The camera automatically detects the faces and eyes of subjects. When a person's eyes are detected, the eye closer to the camera will be brought into focus. The exposure will be adjusted to the face. (When [Metering Mode] is set to)</p>
<p>[Tracking] (→PDF)</p>	<p>The AF area follows the movement of the subject, maintaining focusing.</p> <p>Start tracking. Aim the AF area over the subject, and press the shutter button halfway.</p> <p>To release AF Tracking. Touch or press .</p>
<p>[49-Area] (→PDF)</p>	<p>The camera selects the most optimal AF area to focus from 49 areas.</p>
etc. Custom Multi (→ PDF)	<p>The shape of the AF area can be set freely in the 49 AF areas. The set AF area can be registered using to .</p>
<p>[1-Area] (→PDF)</p>	<p>Specify the point to be brought into focus.</p>
<p>[Pinpoint] (→PDF)</p>	<p>You can achieve a more precise focus on a small point.</p>

Record Using Manual Focus



MF (Manual Focus) refers to manual focusing.

Use this function when you want to fix the focus or when the distance between the lens and the subject is determined and you do not want to activate AF.

1 Set the Focus Mode.

- Press **MENU/SET** → **[CAMERA]** → **[Focus Mode]** → **[MF]**
- Press the shutter button halfway to return to the recording screen.

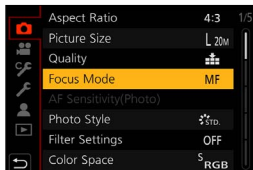

2 Press **[DISP.]** (◀).

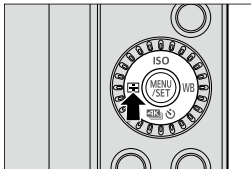

3 Select the focus point.

- Press **▲▼◀▶** to select the focus point.
- To return the point to be brought into focus to the center, press **[DISP.]**.

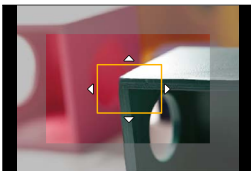

4 Confirm your selection.

- Press **MENU/SET**.
- This switches to the MF Assist screen, and shows an enlarged display.

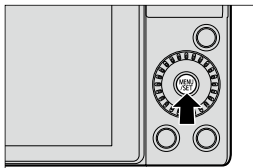

5 Adjust the focus.

The operations used to focus differ depending on the lens.

When using an interchangeable lens with no focus ring

Press **▶**: Focuses on nearby subject

Press **◀**: Focuses on distant subject

A Slide bar



- Pressing and holding **◀▶** will increase the focus speed.
- Focus can also be adjusted by dragging the slide bar.

When using an interchangeable lens with a focus ring

Rotate to **B** side: Focuses on nearby subject

Rotate to **C** side: Focuses on distant subject

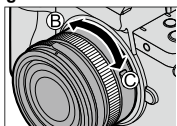

When using the interchangeable lens having a focus lever

Move to **D** side: Focuses on nearby subject

Move to **E** side: Focuses on distant subject

- The focusing speed varies depending on how far you move the focus lever.

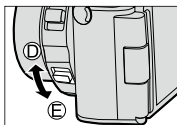

6 Close the MF Assist screen.

- Press the shutter button halfway.

7 Start recording.

- Press the shutter button fully.

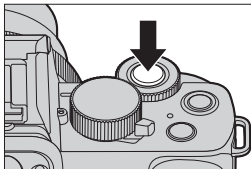

Recording with Zoom



Use the optical zoom of the lens to zoom to telephoto or wide-angle.

T : Telephoto, Enlarges distant subject

W : Wide-angle, Widens angle of view

<p>Interchangeable lens with a zoom ring</p>	<p>Rotate the zoom ring.</p>	
<p>Interchangeable lens that supports the power zoom (electrically operated zoom)</p>	<p>Move the zoom lever. (The zoom speed varies depending on how far you move the lever.)</p>	
<p>Interchangeable lens that does not support the zoom</p>	<p>The optical zoom is not available.</p>	

6. Drive/Image Stabilizer

Selecting the Drive Mode



You can switch the drive mode to Single, Burst, etc. to match the recording conditions.

1 Press [4K] (▼).

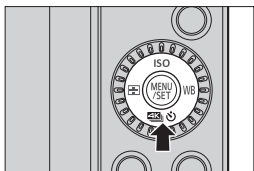

2 Select the drive mode.

- Press ◀▶ to select the drive mode and press .
- You can also select by rotating .

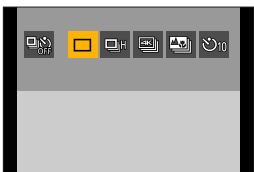

[Single]	Takes one picture each time the shutter button is pressed.
[Burst] (→ [PDF])	Takes pictures continuously while the shutter button is pressed and held.
[4K PHOTO] (→ [PDF])	When the shutter button is pressed, a picture is recorded with the 4K Photo function.
[Post Focus] (→ [PDF])	When the shutter button is pressed, the pictures are recorded with [Post Focus].
[Self Timer] (→ [PDF])	Takes pictures when the set time elapses after the shutter button is pressed.

- Select [Off] to return to [Single] (default setting).

Image Stabilizer

The camera detects jitter during recording and automatically corrects it, so you can record images with reduced jitter.

- When using a lens with an O.I.S. switch, set the switch on the lens to ON.
- When you use a lens with no connection function with the camera, [Stabilizer] cannot be selected.
- When you use a lens without the stabilizer function, [Operation Mode] cannot be selected.

Image Stabilizer Settings



Set the image stabilizer operation to match the recording situation.

→ / → Select [Stabilizer]

[Operation Mode]	Sets the stabilization movement (blur) to match the recording method (normal, panning). (→ PDF)	
[E-Stabilization (Video)]	[HIGH]	This will stabilize strong jitter. is displayed on the screen during video recording.
	[STANDARD]	This will stabilize jitter. is displayed on the screen during video recording.
	[OFF]	This will turn off the electronic stabilization (Video).
	<p>Camera shake during video recording is corrected along the vertical, horizontal, roll, pitch, and yaw axes through the combined use of the in-lens and electronic image stabilizers. (5-Axis Hybrid Image Stabilizer)</p> <ul style="list-style-type: none"> • If the recording screen icon is not indicated with or even when Panasonic interchangeable lens that supports Dual I.S.2 is being used, update the lens firmware to the latest version. For the latest information on supported lenses or to download their firmware, refer to our support site. (→16) • When using an interchangeable lens that does not support Dual I.S.2 or when [Operation Mode] is set to [OFF], (Strong) or (Standard) is displayed. 	

7. Brightness (Exposure)/ Coloring/Picture effect

[Metering Mode]



Type of optical measurement to measure brightness can be changed.

→ []/[] → Select [Metering Mode]

Multi-metering	Method in which the most suitable exposure is measured by judging the allocation of brightness on the whole screen.
Center-weighted	Method used to perform measuring which focuses on the center of the screen.
Spot	Method used to measure the extremely small part around the spot-metering target . <ul style="list-style-type: none">• When you move the AF area, the spot metering target also moves to match.

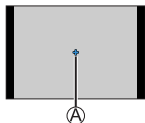

Exposure Compensation



You can compensate the exposure when the correct exposure determined by the camera is too bright or too dark.

You can adjust the exposure in 1/3 EV steps in a range of ± 5 EV.

When recording videos or recording with 4K photo or Post-Focus, the range changes to ± 3 EV.

1 Press [Z].

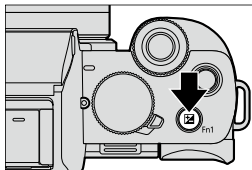

2 Compensate the exposure.

- Rotate or .

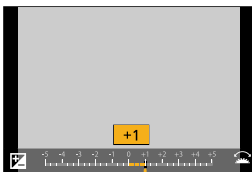

3 Confirm your selection.

- Press the shutter button halfway.

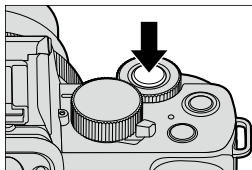



- In [M] mode, you can compensate the exposure by setting the ISO sensitivity to [AUTO].
- When the exposure compensation value falls below or exceeds ± 3 EV, the brightness of the recording screen will no longer change. Press the shutter button halfway or use AE Lock to reflect the value on the recording screen.
- The set exposure compensation value is stored even if you turn off the camera.

ISO Sensitivity



You can set light sensitivity (ISO sensitivity).

With the default settings, you can set 200 to 25600 in 1/3 EV increments.

1 Press [ISO] (▲).

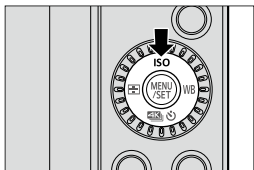

2 Select ISO sensitivity.

- Rotate or .





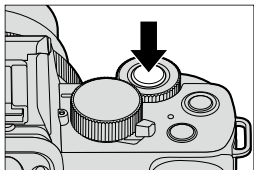

3 Confirm your selection.

- Press the shutter button halfway.



❖ **Setting Items (ISO Sensitivity)**

[AUTO]	ISO sensitivity is automatically set in a range up to 3200 depending on the brightness of a subject.
 ISO (Intelligent ISO)	ISO sensitivity is automatically set in a range up to 3200 depending on the movement and brightness of a subject.
[200] to [25600]	The ISO sensitivity is fixed at the selected value.

- When the following functions are being used, ** ISO** is not available:
 - [S] mode, [M] mode, [ PASM] mode, [S&Q] mode
 - [4K PHOTO], [Post Focus]
 - [Live View Composite]
- When the following functions are being used, the ISO sensitivity that can be set is restricted.
 - [ PASM] mode, [S&Q] mode, [4K PHOTO], [Post Focus]: [6400] (upper limit)
 - [V-Log L] ([Photo Style]): [400] (lower limit)
 - [Filter Settings]: [3200] (upper limit) (When set to [High Dynamic], the setting is fixed to [AUTO].)
 - [Live View Composite]: [200] (lower limit) (When [Extended ISO] is set to [ON], the setting will be [L.100].), [1600] (upper limit)
 - [Multi Exp.]: [200] (lower limit), [3200] (upper limit)



- During video recording, the camera operates as [AUTO] (for video). (When not in [ PASM] / [S&Q] mode)

White Balance (WB)



White balance (WB) is a function that corrects the color cast produced by the light illuminating the subject.

It corrects the colors so that white objects appear in white to make the overall color closer to what is seen by the eye.

Normally, you can use auto ([AWB], [AWBc] or [AWBw]) to obtain the optimal white balance.

Set this function when the coloring of the image is different from what you expected, or you want to change the coloring to capture the ambience.

1 Press [WB] (▶).

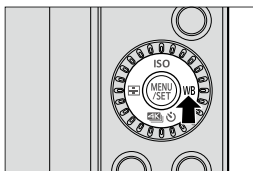

2 Select the white balance.

- Rotate or .



3 Confirm your selection.

- Press the shutter button halfway.

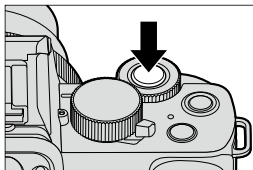

❖ **Setting Items (White Balance)**

[AWB]	Auto
[AWBc]	Auto (Reduces the reddish hue under an incandescent light source)
[AWBw]	Auto (Leaves the reddish hue under an incandescent light source)
[☀]	Clear sky
[☁]	Cloudy sky
[🏠]	Shade under a clear sky
[💡]	Incandescent light
[⚡WB]*1	Flash
[1] to [4]	Set mode 1 to 4 (→ PDF)
[K1] to [K4]	Color temperatures 1 to 4 (→ PDF)

*1 It operates as [AWB] during video recording or when recording with [4K PHOTO] or [Post Focus].

8. Flash

Refer to the “Owner’s Manual” (PDF format) for details about recording using a flash and recording with a wireless flash. (→[PDF](#))

Using a Flash



❖ Open/Close the built-in flash

Ⓐ To open the flash

Ⓑ To close the flash

- The flash setting is fixed to [] (Forced Flash Off) while the flash is closed. (Except when using an external flash)

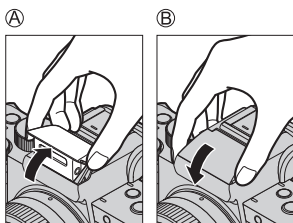

- Be careful not to catch a finger or any other part of your body or any object when you close the flash.
- Forcibly closing the flash can damage the camera.
- Be sure to close the built-in flash when not in use.
- Do not bring any objects near the flash or block the flash. Heat or light may cause the object to deform or discolor.
- Do not block the flash with your hand while it is firing.
- Do not close the flash immediately after the preliminary flash is operated prior to taking pictures for Forced ON/Red-Eye Reduction and other flash settings. If you close the flash immediately, it will cause a malfunction.
- If you record repeatedly, time may be needed to charge the flash. While the flash is charging, images will be recorded without the flash firing.
- When an External Flash is attached, it will have priority over the built-in flash. (→[PDF](#))

9. Recording Videos

Recording Videos



1 Start recording.

- Press the video rec. button.
- Release the video rec. button right after you press it.

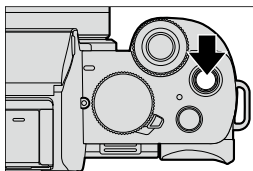

- (A) Red REC frame indicator
- (B) Recording state indicator
- (C) Remaining recording time
- (D) Elapsed recording time



2 Stop recording.

- Press the video rec. button again.



- If maintaining focus on the subject is difficult during video recording with AF, press the shutter button halfway to re-adjust the focus.

❖ [Rec Quality]



Sets the image quality of videos to be recorded.

⇒ ⇒ Select [Rec Quality]

[Rec Quality]	Picture size	Recording frame rate	Sensor output	Bit rate
[4K/100M/30p]*1	3840×2160	30p	30 fps	100 Mbps
[4K/100M/24p]*1	3840×2160	24p	24 fps	100 Mbps
[FHD/28M/60p]	1920×1080	60p	60 fps	28 Mbps
[FHD/20M/30p]	1920×1080	30p	30 fps	20 Mbps
[FHD/24M/24p]	1920×1080	24p	24 fps	24 Mbps
[HD/10M/30p]	1280×720	30p	30 fps	10 Mbps

*1 4K video



- The amount of time you can record in a single session varies depending on [Rec Quality].

When the recording time of a single session exceeds the following duration, recording stops.

- [4K/100M/30p] / [4K/100M/24p]: 10 minutes
- [FHD/28M/60p]: 20 minutes
- [FHD/20M/30p] / [FHD/24M/24p] / [HD/10M/30p]: 29 minutes and 59 seconds



- Since the camera employs the VBR recording format, the bit rate is changed automatically depending on the subject to record. As a result, video recording time is shortened when a fast-moving subject is recorded.
- When the following functions are being used, 4K video cannot be set.
 - [Miniature Effect] ([] mode)
 - HDMI output
- To record 4K videos, use a UHS Speed Class 3 card.
- When you record 4K videos, the angle of view will be narrower than videos of other sizes.
- To ensure highly accurate focus, 4K videos are recorded at reduced Auto Focus speeds. It may be difficult to focus on the subject with Auto Focus, but this is not a malfunction.

❖ Size Interval for Dividing Files

[Rec Quality]	[4K]	<p>When using an SDHC memory card: A new file will be created to continue recording if the file size exceeds 4 GB.</p> <p>When using an SDXC memory card: Even if the file size exceeds 4 GB, a single file will be recorded.</p>
	[FHD]/[HD]	A new file will be created to continue recording if the file size exceeds 4 GB.



- If an operation such as a zoom or button operation is performed during video recording, that operation sound may be recorded.
- The lens operation sound (AF and image stabilizer) may be recorded to video.
- If the operation sound of pressing the video rec. button to end recording bothers you, try the following:
 - Record the video about 3 seconds longer, and then divide the last part of the video using [Video Divide] in the [Playback] menu.
 - Use the shutter remote control function ([PDF]) for recording.
- Depending on the type of card, the card access indication may appear for a while after video recording. This is not a malfunction.



- Even when playback is performed on a supported device, situations may occur where image or sound quality is poor, recording information is not displayed correctly, or playback is not possible, for example. If you experience any of these, play them back on the camera.
- If the camera temperature rises, [] may be displayed and recording may stop. Wait until the camera cools down.

Creative Video Mode



It is possible to manually change the aperture, shutter speed and ISO sensitivity and record videos.

1 Set the mode dial to [].

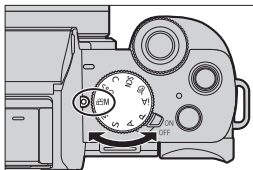

2 Set the exposure mode.

- → [] → [Exposure Mode] → [P]/[A]/[S]/[M]
- You can perform the same exposure operations as the [P]/[A]/[S]/[M] modes.
- Program Shift does not work.



3 Close the menu.

- Press the shutter button halfway.

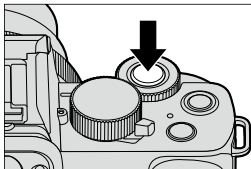

4 Start recording.

- Press the shutter button (A) or video rec. button (B).

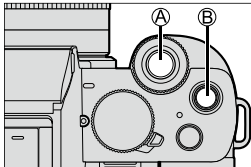

5 Stop recording.

- Press the shutter button or video rec. button again.



- It is also possible to display the selection screen by touching the Recording mode icon in recording screen.



❖ Operations During Video Recording

Change the exposure and audio settings with touch operation to prevent operation sounds from being recorded.

① Touch [📷].

- In [S&Q] mode, the icon will switch to [📷].

② Touch an icon.

T W ↕	Zoom (When using an interchangeable lens supporting power zoom)
F	Aperture value
SS	Shutter speed

☑	Exposure compensation
ISO	ISO sensitivity
🎤 *1 dB	Sound recording level adjustment (When [Sound Rec Level Adj.] is set to [MANUAL].)

*1 The icon will switch to [📷] in [S&Q] mode, but this cannot be operated during recording.

③ Drag the slide bar to set the item.

[▼]/[▲]: Changes the setting slowly.

[⏏]/[⏏]: Changes the setting quickly.

- If you touch icon (A), the screen of Step ② is redisplayed.

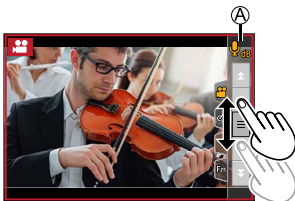

Slow & Quick Mode



Records slow-motion videos and quick-motion videos.

- A video will be recorded at [FHD] under [MP4].
- Audio is not recorded in videos.
- For operations during video recording (→73)

1 Set the mode dial to [S&Q].

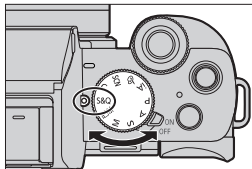

2 Set the recording settings.

- → [S&Q] →
[S&Q Exposure Mode]/
[S&Q Recording Frame Rate]/
[S&Q Effect]
- For details, refer to page 75.

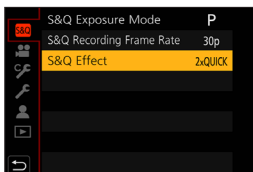

3 Close the menu.

- Press the shutter button halfway.

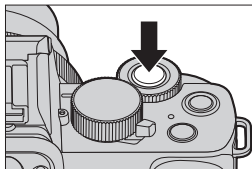

4 Start recording.

- Press the shutter button **(A)** or video rec. button **(B)**.

5 Stop recording.

- Press the shutter button or video rec. button again.

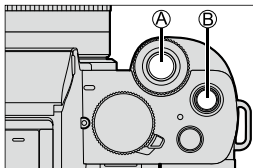

- It is also possible to display the selection screen by touching the recording mode icon in recording screen.



Slow & Quick Menu

❖ [S&Q Exposure Mode]

Select the exposure mode.

Settings: [P]/[A]/[S]/[M]

- You can perform the same exposure operations as the [P]/[A]/[S]/[M] modes.
- Program Shift does not work.

❖ [S&Q Recording Frame Rate]

Select the recording frame rate.

Settings: [60p]/[30p]

❖ [S&Q Effect]

Select the speed effect.

[8xQUICK]	Records videos sped up to about 8-times speed. Example: When set to [60p]: 8 frames/second. When set to [30p]: 4 frames/second.	Quick motion video
[4xQUICK]	Records videos sped up to about 4-times speed.	
[2xQUICK]	Records videos sped up to about 2-times speed.	
[2xSLOW]*1	Records videos slowed down to about half speed.	Slow motion video
[4xSLOW]*2	Records videos slowed down to about 1/4 speed.	

*1 When [S&Q Recording Frame Rate] is set to [60p], the angle of view becomes narrower.

*2 It can only be selected when [S&Q Recording Frame Rate] is set to [30p].
(The angle of view becomes narrower.)



- Depending on the settings, the recording screen may seem as if frames are missed.
- When the recording time of a single session exceeds the following duration, recording stops.
 - Quick motion video: 29 minutes and 50 seconds
(Example: If you record for 29 minutes and 50 seconds with [8xQUICK], the result will be a video that is approximately 4 minutes long.)
 - Slow motion video: 10 minutes
(Example: If you record for 10 minutes with [4xSLOW], the result will be a video that is approximately 40 minutes long.)



- The shutter speeds that can be set vary depending on [S&Q Recording Frame Rate], [S&Q Effect], and the focus mode.

Video Settings (Audio)

Refer to the “Owner’s Manual” (PDF format) for details about video settings. (→[PDF](#))

[Built-in Mic]



Sets the sound pickup range when using the built-in microphone.

→ → Select [Built-in Mic]

Setting	Sound pickup range
[AUTO]	When the AF mode is set to ([Face/Eye Detection]) and the camera recognizes a face, it switches to ([TRACKING])*1. In other cases, it is set to ([SURROUND]).
[SURROUND]	Picks up a wide range of sounds in all directions.
[FRONT]	Picks up sounds in front of the camera.
[TRACKING]*1	When AF mode is set to ([Face/Eye Detection]) and the camera recognizes a face, it automatically adjusts the sound pickup range according to the location of your face. In other cases, it automatically adjusts the sound pickup range according to the angle of view.
[BACK]	Picks up sounds behind the camera.

*1 If you hold the camera vertically, the setting will temporarily switch to ([FRONT]).



- When an external microphone is connected, [Built-in Mic] is not available.
- You can hide the indicator of sound pickup range (A) and sound pickup target (B) by setting [Built-in Mic Indicator] to [OFF].



- In Self Shot Mode, you can set the sound pickup range by touching the on the screen. (→[PDF](#))

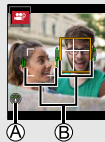

10. Playing Back and Editing of Images

This chapter explains how to play back and delete pictures and videos. It also explains editing images.



- Images recorded on devices other than this one may not be played back or edited correctly on this camera.

Playing Back Pictures

1 Display the playback screen.

- Press [▶].

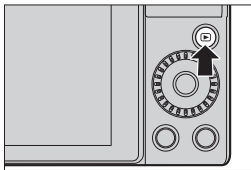

2 Select a picture.

- Select the pictures by pressing ◀▶.
- You can move continuously through images by pressing and holding ◀▶.



3 Stop playback.

- Press the shutter button halfway.
- You can also stop playback by pressing [▶].

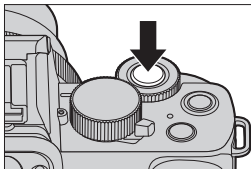

Playing Back Videos

1 Display the playback screen.

- Press [▶].

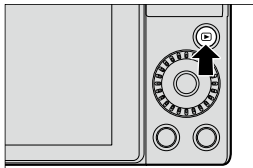

2 Select a video.

- For information about how to select images, refer to page 78.
- The [▶] video icon is displayed for a video.

Ⓐ Video recording time

- The video recording time is displayed on the screen.



3 Play back the video.

Ⓑ Elapsed playback time

- Press ▲.
- You can also start playback by touching [▶] at the center of the screen.
- Videos recorded with [Snap Movie] are played back automatically.



4 Stop playback.

- Press ▼.



- If you press [MENU/SET] during a pause, you can create a picture from a video.
- This camera has a wide dynamic range to improve the sound quality and can play a wide range of sounds. For that reason, depending on the environment recorded, the playback sound may feel small but this is not a malfunction.

Deleting Images





- Images cannot be restored once they have been deleted. Carefully confirm the images before deletion.
- If you delete a group image, all images in the group are deleted.

❖ [Delete Single]

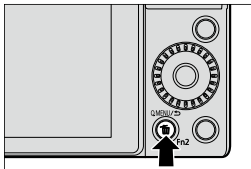
- 1 Press [] in playback state.
- 2 Press ▲▼ to select [Delete Single] and then press .



❖ [Delete Multi]

- 1 Press [] in playback state.
- 2 Press ▲▼ to select [Delete Multi] and then press .
 - 1 Press ▲▼◀▶ to select the image to delete and then press .
 - [] is displayed for the selected image.
 - If you press  again, the selection is canceled.
 - Up to 100 images can be selected.
 - 2 Press [DISP.] to delete the selected image.



- Depending on the number of images to be deleted, it may take some time to delete them.



- You can set which of [Yes] and [No] is selected initially in the confirmation screen when deleting:
 - [] ➔ [Delete Confirmation]
- You can delete all of the images on a card, or all images except those with a rating set:
 - [] ➔ [Delete All Images]

11. Camera Customization

Fn Buttons

You can register functions to the Fn (Function) buttons.
Different functions can be set for both during recording and playback.

❖ Fn Button Default Settings

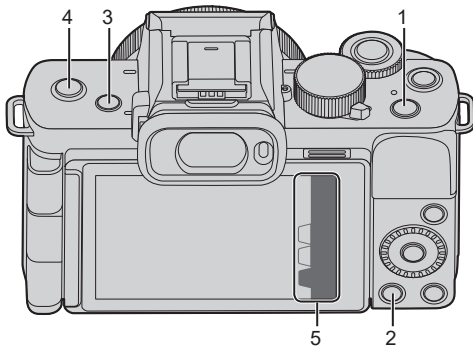

	Fn buttons	[Setting in REC mode]	[Setting in PLAY mode]
1	[Fn1]	[Exposure Comp.]	[Wi-Fi]
2	[Fn2]	[Q.MENU]	• Cannot be used as Fn buttons during playback.
3	[Fn3]	[LVF/Monitor Switch]	[LVF/Monitor Switch]
4	[Fn4]	[OFF]	[Send Image (Smartphone)]
5	[Fn5]	[Wi-Fi]	• Cannot be used as Fn buttons during playback.
	[Fn6]	[Preview]	
	[Fn7]	[Level Gauge]	
	[Fn8]	[Histogram]	
	[Fn9]	[Built-in Mic]	



Register Functions to the Fn Buttons

1 Select [Fn Button Set].

-  → [C/F] → [Sun icon] → [Fn Button Set] → [Setting in REC mode]/[Setting in PLAY mode]



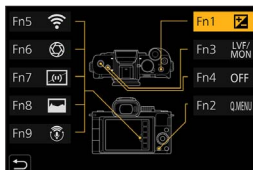

2 Select the button.

- Press ▲▼ to select the button and then press .
- Selection is also possible by rotating  or .



3 Register the function.

- Press ▲▼ to select a function and then press .
- Selection is also possible by rotating  or .
- For information on functions that can be registered. (→ [PDF](#))

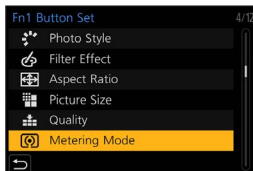



- You can also press and hold the Fn button (2 sec.) to display the screen in Step 3.
(This may not be displayed depending on the registered function and on the button type.)

Use the Fn Buttons

During recording, pressing the Fn buttons enables usage of the functions registered in [Setting in REC mode], and during playback, usage of the functions registered in [Setting in PLAY mode].

1 Press the Fn button.

2 Select a setting item.

- Press ◀▶ to select a setting item and then press .
- Selection is also possible by rotating  or .
- Display and selection methods of a setting item differ depending on the menu item.

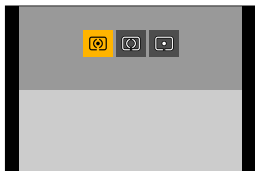

❖ Use [Fn5] to [Fn9] (Touch Icons)

During recording, you can use the Fn buttons within the Touch Tab.

① Touch .

② Touch one of [Fn5] to [Fn9].





12. Menu Guide

List of Menu

 : Menu items common to the [Rec] menu and [Motion Picture] menu. Their settings are synchronized.

 : For details, refer to the "Owner's Manual" (PDF format). (→3)

[Intelligent Auto] menu

[Intelligent Auto Mode]	→51
[iHandheld Night Shot]	→ 
[iHDR]	→ 

[Creative Video] menu

[Exposure Mode]	→71
[4K Live Cropping]	→ 

[Slow & Quick] menu

[S&Q Exposure Mode]	→75
[S&Q Recording Frame Rate]	→75
[S&Q Effect]	→76





























[Scene Guide] menu

[Scene Switch]	→ 
----------------	---

[Creative Control] menu

[Filter Effect]	→ 
[Simultaneous Record w/o Filter]	→ 











[Rec] menu

[Aspect Ratio]	→ 
[Picture Size]	→ 
[Quality]	→ 
[Focus Mode]	 →53
[AF Sensitivity(Photo)]	→ 
[Photo Style]	 → 
[Filter Settings]	 → 
[Color Space]	→ 
[Metering Mode]	 →61
[Highlight Shadow]	 → 
[i.Dynamic]	 → 
[i.Resolution]	 → 
[Flash]	→ 
[Red-Eye Removal]	→ 
[ISO Sensitivity (photo)]	→ 
[Min. Shtr Speed]	→ 
[Long Shtr NR]	→ 
[Shading Comp.]	→ 
[Diffraction Compensation]	 → 
[Stabilizer]	 →60
[Ex. Tele Conv.] ([Rec])	→ 
[Digital Zoom]	 → 



📷 [Rec] menu (Continued)



[Burst Rate]	→ PDF
[4K PHOTO]	→ PDF
[Self Timer]	 → PDF
[Time Lapse Shot]	→ PDF
[Stop Motion Animation]	→ PDF
[Live View Composite]	→ PDF
[Silent Mode]	→ PDF
[Shutter Type]	→ PDF
[Shutter Delay]	→ PDF
[Bracket]	→ PDF
[HDR]	→ PDF
[Multi Exp.]	→ PDF

👤 [Motion Picture] menu

[Rec Quality]	→ 69
[Snap Movie]	→ PDF
[Focus Mode]	 → 53
[Continuous AF]	→ PDF
[AF Custom Setting(Video)]	→ PDF
[Photo Style]	 → PDF
[Filter Settings]	 → PDF
[Luminance Level]	→ PDF
[Metering Mode]	 → 61
[Highlight Shadow]	 → PDF
[i.Dynamic]	 → PDF
[i.Resolution]	 → PDF
[ISO Sensitivity (video)]	→ PDF
[Diffraction Compensation]	 → PDF
[Stabilizer]	 → 60
[Flkr Decrease]	→ PDF
[Ex. Tele Conv.] ([Motion Picture])	→ PDF
[Digital Zoom]	 → PDF
[Picture Mode in Rec.]	→ PDF
[Self Timer]	 → PDF
[Sound Rec Level Disp.]	→ PDF
[Sound Rec Level Adj.]	→ PDF
[Wind Noise Canceller]/ [Wind Cut]	→ PDF
[Lens Noise Cut]	→ PDF
[Built-in Mic]	→ 77
[Built-in Mic Indicator]	→ PDF
[Special Mic.]	→ PDF

[Custom] menu

 [Exposure]	
[ISO Increments]	→ PDF
[Extended ISO]	→ PDF
[Exposure Comp. Reset]	→ PDF
 [Focus / Release Shutter]	
[AF/AE Lock]	→ PDF
[AF/AE Lock Hold]	→ PDF
[Shutter AF]	→ PDF
[Half Press Release]	→ PDF
[Quick AF]	→ PDF
[Eye Sensor AF]	→ PDF
[Pinpoint AF Setting]	→ PDF
[AF Assist Lamp]	→ PDF
[Direct Focus Area]	→ PDF
[Focus/Release Priority]	→ PDF
[Focus Switching for Vert / Hor]	→ PDF
[Loop Movement Focus Frame]	→ PDF
[AF Area Display]	→ PDF
[AF+MF]	→ PDF
[MF Assist]	→ PDF
[MF Assist Display]	→ PDF
 [Operation]	
[Fn Button Set]	→ 82
[ISO Displayed Setting]	→ PDF
[Exposure Comp. Disp. Setting]	→ PDF
[Q.MENU]	→ PDF
[Dial Set.]	→ PDF
[Operation Lock Setting]	→ PDF
[Focus Ring Lock]	→ PDF
[Video Rec. Button]	→ PDF
[Touch Settings]	→ PDF

 [Monitor / Display]	
[Auto Review]	→ PDF
[Monochrome Live View]	→ PDF
[Constant Preview]	→ PDF
[Live View Boost]	→ PDF
[Peaking]	→ PDF
[Histogram]	→ PDF
[Guide Line]	→ PDF
[Frame Marker]	→ PDF
[Center Marker]	→ PDF
[Highlight]	→ PDF
[Zebra Pattern]	→ PDF
[Expo.Meter]	→ PDF
[MF Guide]	→ PDF
[LVF/Monitor Disp. Set]	→ PDF
[Monitor Info. Disp.]	→ PDF
[Rec Area]	→ PDF
[Remaining Disp.]	→ PDF
[Red REC Frame Indicator]	→ PDF
[Menu Guide]	→ PDF
 [Lens / Others]	
[Lens Position Resume]	→ PDF
[Power Zoom Lens]	→ PDF
[Lens Fn Button Setting]	→ PDF
[Aperture Ring Increment]	→ PDF
[Self Timer Auto Off]	→ PDF
[Self Shot]	→ PDF
[AF After Countdown]	→ PDF
[Face Recog.]	→ PDF
[Profile Setup]	→ PDF

 **[Setup] menu**

[Online Manual]	→3
[Cust.Set Mem.]	→ PDF
[Clock Set]	→36
[World Time]	→ PDF
[Travel Date]	→ PDF
[Wi-Fi]	→ PDF
[Bluetooth]	→ PDF
[Wireless Connection Lamp]	→ PDF
[Beep]	→ PDF
[Economy]	→ PDF
[Monitor Display Speed]	→ PDF
[LVF Display Speed]	→ PDF
[Monitor Display]/[Viewfinder]	→ PDF
[Monitor Luminance]/ [LVF Luminance]	→ PDF
[Eye Sensor]	→ PDF
[USB Mode]	→ PDF
[TV Connection]	→ PDF
[Language]	→ PDF
[Version Disp.]	→ PDF
[Folder / File Settings]	→ PDF
[No.Reset]	→ PDF
[Reset]	→46
[Reset Network Settings]	→ PDF
[Pixel Refresh]	→ PDF
[Level Gauge Adjust.]	→ PDF
[Demo Mode]	→ PDF
[Approved Regulations]	→ PDF
[Format]	→32

 **[My Menu]**

[My Menu Setting]	
[Add]	→ PDF
[Sorting]	→ PDF
[Delete]	→ PDF
[Display from My Menu]	→ PDF

 **[Playback] menu**

[Slide Show]	→ PDF
[Playback Mode]	→ PDF
[Protect]	→ PDF
[Rating]	→ PDF
[Title Edit]	→ PDF
[Face Rec Edit]	→ PDF
[RAW Processing]	→ PDF
[4K PHOTO Bulk Saving]	→ PDF
[Light Composition]	→ PDF
[Sequence Composition]	→ PDF
[Clear Retouch]	→ PDF
[Text Stamp]	→ PDF
[Resize]	→ PDF
[Cropping]	→ PDF
[Rotate]	→ PDF
[Video Divide]	→ PDF
[Time Lapse Video]	→ PDF
[Stop Motion Video]	→ PDF
[Rotate Disp.]	→ PDF
[Picture Sort]	→ PDF
[Delete Confirmation]	→ PDF
[Delete All Images]	→ PDF

13. Connecting to Other Devices

Wi-Fi/Bluetooth

For details on the Wi-Fi®/Bluetooth® functions, refer to the “Owner’s Manual” (PDF format). (→[PDF](#))

❖ Checking operation of the Wi-Fi and Bluetooth functions

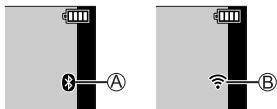

- Ⓐ The Bluetooth function is set to on, or there is a connection
(The Wi-Fi icon will be displayed when a function connecting to Wi-Fi is used after Bluetooth connection, such as [Auto Transfer].)
- Ⓑ The Wi-Fi function is set to on, or there is a connection

When image data is sent using a camera operation, [] is displayed on the monitor.

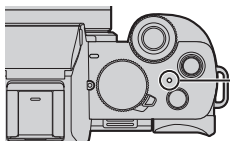

WIRELESS connection lamp (Blue)

Lit: When the Wi-Fi/Bluetooth function is ON or connected.

Blinking: When sending picture data.



- Do not remove the card or battery or move to an area without any reception while sending images.
- The camera cannot be used to connect to a public wireless LAN connection.
- We strongly recommend that you set an encryption to maintain information security.
- We recommend that you use a sufficiently charged battery when sending images.
- When the remaining battery level is low, it may not be possible to connect to or maintain communication with other devices.
(A message such as [Communication error] is displayed.)
- Images may not be completely sent depending on radio wave conditions. If the connection is terminated while sending images, images with parts that cannot be displayed may be sent.

Importing Images to a PC

Installing Software

Check the following site and then download and install the software.



- Supported OS versions as of June 2020. Supported OS versions may be changed without prior notice.

❖ PHOTOfunSTUDIO 10.0 AE

This software allows you to manage your images. For example, it allows you to import pictures and videos to your PC and then sort them by recording date, model name.

https://panasonic.jp/support/global/cs/soft/download/d_pfs10ae.html
(English only)

Download expiration: July 2025

Supported OS	Windows 10 (32-bit/64-bit) Windows 8.1 (32-bit/64-bit) • For 4K videos and 4K photos, a 64-bit version of the Windows 10/Windows 8.1 OS is required.
CPU	Pentium® 4 (2.8 GHz or higher)
Display	1024×768 or higher (1920×1080 or higher is recommended)
Installed memory	1 GB or more for 32-bit, 2 GB or more for 64-bit
Free hard disk space	450 MB or more for installing the software

❖ SILKYPIX Developer Studio SE

This software processes and edits RAW images.

<http://www.isl.co.jp/SILKYPIX/english/p/>

Supported OS	Windows	Windows 10 (64-bit recommended) Windows 8.1 (64-bit recommended)
	Mac	OS X v10.10 to v10.11 macOS 10.12 to macOS 10.15

❖ 30-Day Full Trial Version of “LoiLoScope” (Free)

<http://loilo.tv/product/20>

14. Materials

Digital Camera Accessory System

(Product numbers correct as of June 2020.)

Battery Pack	DMW-BLG10
Battery Charger*1	DMW-BTC12
DC Coupler*2	DMW-DCC11
AC Adaptor*2	DMW-AC10
Flash	DMW-FL580L, DMW-FL360L, DMW-FL200L
Tripod grip	DMW-SHGR1
LED Video Light	VW-LED1
Stereo Shotgun Microphone	DMW-MS2
Stereo Microphone	VW-VMS10
Body cap	DMW-BDC1
Mount Adaptor	DMW-MA1, DMW-MA2M, DMW-MA3R
Tripod adaptor*3	DMW-TA1

*1 Supplied with an AC adaptor and a USB connection cable.

*2 The AC adaptor (optional) can only be used with the designated Panasonic DC coupler (optional). The AC adaptor (optional) cannot be used by itself. By using them, you can perform recording and playback without worrying about the remaining battery charge.

*3 Use if the attached lens is in contact with the tripod pedestal.

- Some optional accessories may not be available in some countries.
- For lens-related optional accessories such as compatible lenses and filters, refer to our catalogs/web pages, etc.
- Refer to the "Owner's Manual" (PDF format) for details about using this camera when using optional accessories.

Specifications

The specifications are subject to change for performance enhancement.

Digital camera body (DC-G100):

Information for your safety

Power source:	8.4 V===
Power consumption:	2.9 W (when recording with the monitor), 2.0 W (when playing back with the monitor) <When using the interchangeable lens (H-FS12032)>

Type	
Type	Digital Single Lens Mirrorless camera
Recording media	SD memory card / SDHC memory card*1 / SDXC memory card*1 *1 Compliant with UHS-I UHS Speed Class 3
Lens mount	Micro Four Thirds mount
Image sensor	
Image sensor	4/3" Live MOS sensor, a total of 21,770,000 pixels, primary color filter
Effective number of pixels of the camera	20,300,000 pixels
Recording format for still images	
File format for still images	JPEG (DCF compliant, Exif 2.31 compliant) / RAW
File format for 4K photos	MP4 (H.264/MPEG-4 AVC, AAC (2ch))

Picture size (pixels)	<p>When the aspect ratio setting is [4:3] [L]: 5184×3888, [M]: 3712×2784, [S]: 2624×1968 4K photo: 3328×2496</p> <p>When the aspect ratio setting is [3:2] [L]: 5184×3456, [M]: 3712×2480, [S]: 2624×1752 4K photo: 3504×2336</p> <p>When the aspect ratio setting is [16:9] [L]: 5184×2920, [M]: 3840×2160, [S]: 1920×1080 4K photo: 3840×2160</p> <p>When the aspect ratio setting is [1:1] [L]: 3888×3888, [M]: 2784×2784, [S]: 1968×1968 4K photo: 2880×2880</p>
Quality	Fine / Standard / RAW+Fine / RAW+Standard / RAW
Recording format for video	
Video format	MP4 (H.264/MPEG-4 AVC, AAC (2ch))
Image quality for video	For details, refer to page 69.
Viewfinder	
System	Aspect ratio 4:3, 0.4 inches, approx. 3,680,000 dots equivalent, Color LCD Live Viewfinder (field of view ratio about 100%)
Monitor	
System	Aspect ratio 3:2, 3.0 inches, approx. 1,840,000 dots monitor, capacitive touch screen (field of view ratio about 100%)
Focus	
AF type	TTL type based on image detection (Contrast AF)
Focus mode	AFS / AFF / AFC / MF
AF mode	Face/Eye Detection, Tracking, 49-area-focusing, Custom Multi, 1-area-focusing, Pinpoint-focusing (Focus area selection is possible by touching.)

Exposure control	
Light metering system, Light metering mode	1728-zone metering, multi-metering / center-weighted metering / spot metering
Metering range	EV 0 to EV 18 (F2.0 lens, ISO100 conversion)
Exposure	Program AE (P) / Aperture-Priority AE (A) / Shutter-Priority AE (S) / Manual Exposure (M)
Exposure compensation	1/3 EV steps, ± 5 EV
ISO sensitivity (standard output sensitivity)	AUTO / Intelligent ISO / 200 to 25600, When [Extended ISO] is set: AUTO / 100 to 25600, 1/3 EV steps
White balance	
AWB / AWBc / AWBw / Daylight / Cloudy / Shade / Incandescent lights / Flash / White set 1, 2, 3, 4 / Color temperature 1, 2, 3, 4	
Shutter	
Format	Electronically-controlled, Single curtain focal-plane shutter
Shutter speed	<p>Pictures:</p> <p>Electronic front curtain: Time (max. approx. 60 seconds), 60 seconds to 1/500 of a second Electronic shutter: 1 second to 1/16000 of a second</p> <p>Videos:</p> <p>1/25*2 of a second to 1/16000 of a second *2 When [Exposure Mode] is set to [M] in [M] mode and focus mode is set to [MF], this can be set up to 1/2</p>

Flash	
Flash	TTL AUTO Built-in pop up flash GN 5.1 equivalent (ISO200·m) [GN 3.6 equivalent (ISO100·m)]
Flash mode	Auto, Auto/Red-Eye, Forced Flash On, Forced On/Red-Eye, Slow Sync., Slow Sync./Red-Eye, Forced Flash Off
Flash synchronization speed	Equal to or smaller than 1/50 of a second
Flash range	Approx. 0.4 m (1.3 feet) to 4.1 m (13 feet) <When the Interchangeable lens (H-FS12032) is mounted, WIDE, [ISO AUTO] is set>
Zoom	
Digital Zoom	Max. 2x
Extended tele conversion	When taking still pictures: Max. 2.0x (When a picture size of [S] is selected.) When recording video: 2.7x (FHD)/4.0x (HD)
Display language	
[ENGLISH]/[DEUTSCH]/[FRANÇAIS]/[ITALIANO]/[ESPAÑOL]/[繁體中文]/[PORTUGUÊS]/[日本語]	
Microphone / Speaker	
Microphone	Stereo
Speaker	Monaural
Interface	
[HDMI]	micro HDMI Type D
[USB/CHARGE]	USB 2.0 (High Speed)/USB 2.0 Micro-B
[MIC]	Ø 3.5 mm stereo mini jack

External dimensions / Mass	
External dimensions	Approx. 115.6 mm (W)×82.5 mm (H)×54.2 mm (D) (4.55" (W)×3.24" (H)×2.13" (D)) (excluding the projecting parts)
Mass (Weight)	Approx. 345 g/0.76 lb (with one card and the battery) Approx. 303 g/0.66 lb (only camera body)
Operating environment	
Recommended operating temperature	0 °C to 40 °C (32 °F to 104 °F)
Permissible relative humidity	10%RH to 80%RH
Wi-Fi	
Compliance standard	IEEE 802.11b/g/n (standard wireless LAN protocol)
Frequency range used (central frequency)	2412 MHz to 2462 MHz (1 to 11 ch)
Encryption method	Wi-Fi compliant WPA™/WPA2™
Access method	Infrastructure mode
Bluetooth	
Compliance standard	Bluetooth Ver. 4.2 (Bluetooth Low Energy (BLE))
Frequency range used (central frequency)	2402 MHz to 2480 MHz

AC adaptor (Panasonic SAE0012A):

Information for your safety

Input:	110 V–240 V ~ 50/60 Hz 0.2 A
Output:	5.0 V --- 1.0 A

Battery pack (lithium-ion) (Panasonic DMW-BLG10PP):

Information for your safety

Voltage/capacity:	7.2 V / 1025 mAh
--------------------------	------------------

The symbols on this product (including the accessories) represent the following:

~	AC
---	DC
	Class II equipment (The construction of the product is double-insulated.)

This camera complies with the “Design rule for Camera File system” (DCF) and “Exchangeable Image File Format” (Exif) standards established by “Japan Electronics and Information Technology Industries Association” (JEITA). The camera cannot play back files that do not comply with the DCF standard. Exif is a file format for pictures which allows recording information, etc. to be added.

Refer to the “Owner’s Manual” (PDF format) for details about the following specifications (→[PDF](#)):

- About other specifications
- Number of pictures that can be taken and available recording time with the battery
- Number of still images that can be taken and video recording time with cards

Interchangeable Lens	H-FS12032 “LUMIX G VARIO 12–32 mm/F3.5–5.6 ASPH./MEGA O.I.S.”
Focal length	f=12 mm to 32 mm (35 mm film camera equivalent: 24 mm to 64 mm)
Aperture type	7 diaphragm blades/circular aperture diaphragm
Maximum aperture	F3.5 (Wide) to F5.6 (Tele)
Minimum aperture value	F22
Lens construction	8 elements in 7 groups (3 aspherical lenses, 1 ED lens)
In focus distance	0.2 m (0.66 feet) to ∞ (from the focus distance reference line) (focal length 12 mm to 20 mm), 0.3 m (0.98 feet) to ∞ (from the focus distance reference line) (focal length 21 mm to 32 mm)
Maximum image magnification	0.13x (35 mm film camera equivalent: 0.26x)
Optical Image Stabilizer	Available
Mount	Micro Four Thirds mount
Angle of view	84° (Wide) to 37° (Tele)
Filter diameter	37 mm
Max. diameter	Ø 55.5 mm (2.2 inch)
Overall length	Approx. 24 mm (0.94 inch) (from the tip of the lens to the base side of the lens mount when the lens barrel is recessed)
Mass (Weight)	Approx. 67 g/0.15 lb
Recommended operating temperature	0 °C to 40 °C (32 °F to 104 °F)
Permissible relative humidity	10%RH to 80%RH

Tripod grip: DMW-SHGR1

Carrying capacity (Total mass of the loading camera body, lens, battery, and other attached accessories)	Maximum 1.2 kg/2.65 lb
External dimensions (Legs folded)	Approx. 53.7 mm (W)×144.7 mm (H)×45.5 mm (D) (2.11" (W)×5.70" (H)×1.79" (D)) (excluding the projecting parts)
External dimensions (Legs opened)	Approx. 150.5 mm (W)×113.7 mm (H)×133.4 mm (D) (5.93" (W)×4.48" (H)×5.25" (D)) (excluding the projecting parts)
Length of the connection cable	Approx. 160 mm (6.30")
Mass (Weight)	Approx. 102 g/0.22 lb
Recommended operating temperature	0 °C to 40 °C (32 °F to 104 °F)
Permissible relative humidity	10%RH to 80%RH

Trademarks and Licenses



- Micro Four Thirds™ and Micro Four Thirds Logo marks are trademarks or registered trademarks of Olympus Corporation, in Japan, the United States, the European Union and other countries.
- Four Thirds™ and Four Thirds Logo marks are trademarks or registered trademarks of Olympus Corporation, in Japan, the United States, the European Union and other countries.
- SDXC Logo is a trademark of SD-3C, LLC.
- The terms HDMI and HDMI High-Definition Multimedia Interface, and the HDMI Logo are trademarks or registered trademarks of HDMI Licensing Administrator, Inc. in the United States and other countries.
- HDAVI Control™ is a trademark of Panasonic Corporation.
- Adobe is a trademark or registered trademark of Adobe Systems Incorporated in the United States and/or other countries.
- Pentium is a trademark of Intel Corporation in the U.S. and/or other countries.
- Windows is either registered trademark or trademark of Microsoft Corporation in the United States and/or other countries.
- iMovie, Mac, OS X and macOS are trademarks of Apple Inc., registered in the U.S. and other countries.
- App Store is a service mark of Apple Inc.
- Google, Android and Google Play are trademarks of Google LLC.



- The Bluetooth® word mark and logos are registered trademarks owned by Bluetooth SIG, Inc. and any use of such marks by Panasonic Corporation is under license. Other trademarks and trade names are those of their respective owners.
- The Wi-Fi CERTIFIED™ Logo is a certification mark of Wi-Fi Alliance®.
- The Wi-Fi Protected Setup™ Logo is a certification mark of Wi-Fi Alliance®.
- "Wi-Fi®" is a registered trademarks of Wi-Fi Alliance®.
- "Wi-Fi Protected Setup™", "WPA™", and "WPA2™" are trademarks of Wi-Fi Alliance®.
- This product uses "DynaFont" from DynaComware Corporation. DynaFont is a registered trademark of DynaComware Taiwan Inc.
- DLNA, the DLNA Logo and DLNA CERTIFIED are trademarks, service marks, or certification marks of the Digital Living Network Alliance.
- QR Code is a registered trademark of DENSO WAVE INCORPORATED.
- Other names, company names, and product names mentioned in these instructions are trademarks or registered trademarks of the companies concerned.

This product incorporates the following software:

- (1) the software developed independently by or for Panasonic Corporation,
- (2) the software owned by third party and licensed to Panasonic Corporation,
- (3) the software licensed under the GNU General Public License, Version 2.0 (GPL V2.0),
- (4) the software licensed under the GNU LESSER General Public License, Version 2.1 (LGPL V2.1), and/or
- (5) open source software other than the software licensed under the GPL V2.0 and/or LGPL V2.1.

The software categorized as (3) - (5) are distributed in the hope that it will be useful, but WITHOUT ANY WARRANTY, without even the implied warranty of MERCHANTABILITY or FITNESS FOR A PARTICULAR PURPOSE. Please refer to the detailed terms and conditions thereof displayed by selecting [MENU/SET] → [Setup] → [Version Disp.] → [Software info].

At least three (3) years from delivery of this product, Panasonic will give to any third party who contacts us at the contact information provided below, for a charge no more than our cost of physically performing source code distribution, a complete machine-readable copy of the corresponding source code covered under GPL V2.0 or LGPL V2.1, as well as the respective copyright notice thereof.

Contact Information: oss-cd-request@gg.jp.panasonic.com

The source code and the copyright notice are also available for free in our website below.

<https://panasonic.net/cns/oss/index.html>

This product is licensed under the AVC Patent Portfolio License for the personal use of a consumer or other uses in which it does not receive remuneration to (i) encode video in compliance with the AVC Standard ("AVC Video") and/or (ii) decode AVC Video that was encoded by a consumer engaged in a personal activity and/or was obtained from a video provider licensed to provide AVC Video. No license is granted or shall be implied for any other use. Additional information may be obtained from MPEG LA, L.L.C.

See <http://www.mpegla.com>

Limited Warranty (ONLY FOR U.S.A.)

Panasonic Products Limited Warranty

Limited Warranty Coverage (For USA Only)

If your product does not work properly because of a defect in materials or workmanship, Panasonic Corporation of North America (referred to as “the warrantor”) will, for the length of the period indicated on the chart below, which starts with the date of original purchase (“warranty period”), at its option either (a) repair your product with new or refurbished parts, (b) replace it with a new or a refurbished equivalent value product, or (c) refund your purchase price. The decision to repair, replace or refund will be made by the warrantor.

Product or Part Name	Parts	Labor
Digital Camera	1 Year	1 Year
All included Accessories (Except Non-Rechargeable Batteries)	90 Days	Not Applicable
Only Non-Rechargeable Batteries	10 Days	Not Applicable

During the “Labor” warranty period there will be no charge for labor. During the “Parts” warranty period, there will be no charge for parts. This Limited Warranty excludes both parts and labor for non-rechargeable batteries, antennas, and cosmetic parts (cabinet). This warranty only applies to products purchased and serviced in the United States. This warranty is extended only to the original purchaser of a new product which was not sold “as is”.

Mail-In Service--Online Repair Request

Online Repair Request

To submit a new repair request and for quick repair status visit our Web Site at <http://shop.panasonic.com/support>.

When shipping the unit, carefully pack, include all supplied accessories listed in the Owner’s Manual, and send it prepaid, adequately insured and packed well in a carton box. When shipping Lithium Ion batteries please visit our Web Site at <http://shop.panasonic.com/support> as Panasonic is committed to providing the most up to date information. Include a letter detailing the complaint, a return address and provide a daytime phone number where you can be reached. A valid registered receipt is required under the Limited Warranty.

IF REPAIR IS NEEDED DURING THE WARRANTY PERIOD, THE PURCHASER WILL BE REQUIRED TO FURNISH A SALES RECEIPT/PROOF OF PURCHASE INDICATING DATE OF PURCHASE, AMOUNT PAID AND PLACE OF PURCHASE. CUSTOMER WILL BE CHARGED FOR THE REPAIR OF ANY UNIT RECEIVED WITHOUT SUCH PROOF OF PURCHASE.

Limited Warranty Limits and Exclusions

This warranty ONLY COVERS failures due to defects in materials or workmanship, and DOES NOT COVER normal wear and tear or cosmetic damage. The warranty ALSO DOES NOT COVER damages which occurred in shipment, or failures which are caused by products not supplied by the warrantor, or failures which result from accidents, misuse, abuse, neglect, mishandling, misapplication, alteration, faulty installation, set-up adjustments, misadjustment of consumer controls, improper maintenance, power line surge, lightning damage, modification, introduction of sand, humidity or liquids, commercial use such as hotel, office, restaurant, or other business or rental use of the product, or service by anyone other than a Factory Service Center or other Authorized Servicer, or damage that is attributable to acts of God.

THERE ARE NO EXPRESS WARRANTIES EXCEPT AS LISTED UNDER “LIMITED WARRANTY COVERAGE”.

THE WARRANTOR IS NOT LIABLE FOR INCIDENTAL OR CONSEQUENTIAL DAMAGES RESULTING FROM THE USE OF THIS PRODUCT, OR ARISING OUT OF ANY BREACH OF THIS WARRANTY.

(As examples, this excludes damages for lost time, travel to and from the servicer, loss of or damage to media or images, data or other memory or recorded content. The items listed are not exclusive, but for illustration only.)

ALL EXPRESS AND IMPLIED WARRANTIES, INCLUDING THE WARRANTY OF MERCHANTABILITY, ARE LIMITED TO THE PERIOD OF THE LIMITED WARRANTY.

Some states do not allow the exclusion or limitation of incidental or consequential damages, or limitations on how long an implied warranty lasts, so the exclusions may not apply to you.

This warranty gives you specific legal rights and you may also have other rights which vary from state to state. If a problem with this product develops during or after the warranty period, you may contact your dealer or Service Center. If the problem is not handled to your satisfaction, then write to:

Panasonic Corporation of North America
Consumer Affairs Department 8th Fl.
Two Riverfront Plaza
Newark NJ 07102-5490

PARTS AND SERVICE, WHICH ARE NOT COVERED BY THIS LIMITED WARRANTY, ARE YOUR RESPONSIBILITY.

Shop
Accessories!

for all your Panasonic gear

Go to

<http://shop.panasonic.com/support>

Get everything you need to get the most out of
your Panasonic products

Accessories & Parts for your Camera, Phone, A/V
products, TV, Computers & Networking, Personal
Care, Home Appliances, Headphones, Batteries,
Backup Chargers & more...

Customer Services Directory

For Product Information, Operating Assistance,
Parts, Owner's Manuals, Dealer and Service info
go to <http://shop.panasonic.com/support>

For the hearing or speech impaired TTY: 1- 877-833-8855

As of December 2019

Limited Warranty (ONLY FOR CANADA)

Panasonic Canada Inc.

5770 Ambler Drive, Mississauga, Ontario L4W 2T3

PANASONIC PRODUCT – LIMITED WARRANTY

Panasonic Canada Inc. warrants this product to be free from defects in material and workmanship under normal use and for a period as stated below from the date of original purchase agrees to, at its option either (a) repair your product with new or refurbished parts, (b) replace it with a new or a refurbished equivalent value product, or (c) refund your purchase price. The decision to repair, replace or refund will be made by Panasonic Canada Inc.

Digital Camera	One (1) year, parts and labour
Digital Camera Peripherals	One (1) year, parts and labour
Digital Camera Accessories	Ninety (90) days, parts and labour

This warranty is given only to the original purchaser, or the person for whom it was purchased as a gift, of a Panasonic brand product mentioned above sold by an authorized Panasonic dealer in Canada and purchased and used in Canada, which product was not sold "as is", and which product was delivered to you in new condition in the original packaging.

IN ORDER TO BE ELIGIBLE TO RECEIVE WARRANTY SERVICE HEREUNDER, A PURCHASE RECEIPT OR OTHER PROOF OF DATE OF ORIGINAL PURCHASE, SHOWING AMOUNT PAID AND PLACE OF PURCHASE IS REQUIRED

LIMITATIONS AND EXCLUSIONS

This warranty ONLY COVERS failures due to defects in materials or workmanship, and DOES NOT COVER normal wear and tear or cosmetic damage. The warranty ALSO DOES NOT COVER damages which occurred in shipment, or failures which are caused by products not supplied by Panasonic Canada Inc., or failures which result from accidents, misuse, abuse, neglect, mishandling, misapplication, alteration, faulty installation, set-up adjustments, misadjustment of consumer controls, improper maintenance, improper batteries, power line surge, lightning damage, modification, introduction of sand, humidity or liquids, commercial use such as hotel, office, restaurant, or other business or rental use of the product, or service by anyone other than a Authorized Servicer, or damage that is attributable to acts of God.

Dry cell batteries, printer ink cartridge and paper are also excluded from coverage under this warranty.

Rechargeable batteries are warranted for ninety (90) days from date of original purchase.

THIS EXPRESS, LIMITED WARRANTY IS IN LIEU OF ALL OTHER WARRANTIES, EXPRESS OR IMPLIED, INCLUDING ANY IMPLIED WARRANTIES OF MERCHANTABILITY AND FITNESS FOR A PARTICULAR PURPOSE. IN NO EVENT WILL PANASONIC CANADA INC. BE LIABLE FOR ANY SPECIAL, INDIRECT OR CONSEQUENTIAL DAMAGES RESULTING FROM THE USE OF THIS PRODUCT OR ARISING OUT OF ANY BREACH OF ANY EXPRESS OR IMPLIED WARRANTY. (As examples, this warranty excludes damages for lost time, travel to and from the Authorized Servicer, loss of or damage to media or images, data or other memory or recorded content. This list of items is not exhaustive, but for illustration only.)

In certain instances, some jurisdictions do not allow the exclusion or limitation of incidental or consequential damages, or the exclusion of implied warranties, so the above limitations and exclusions may not be applicable. This warranty gives you specific legal rights and you may have other rights which vary depending on your province or territory.

WARRANTY SERVICE

For product operation, repairs and information assistance, please visit our Support page :

www.panasonic.ca/english/support

Panasonic Corporation of North America

Two Riverfront Plaza, Newark, NJ 07102-5490

<http://shop.panasonic.com>

Panasonic Canada Inc.

5770 Ambler Drive Mississauga, Ontario L4W 2T3

www.panasonic.com

© Panasonic Corporation 2020