

Panasonic®

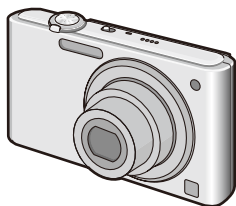

Operating Instructions for advanced features Digital Camera

Model No. **DMC-F2**



Before connecting, operating or
adjusting this product, please read the
instructions completely.



QuickTime and the QuickTime logo are trademarks or registered
trademarks of Apple Inc., used under license therefrom.

VQT2T59

Dear Customer,

Thank you for choosing Panasonic!

You have purchased one of the most sophisticated and reliable products on the market today. Used properly, we're sure it will bring you and your family years of enjoyment.

Information for Your Safety

Carefully observe copyright laws. Recording of pre-recorded tapes or discs or other published or broadcast material for purposes other than your own private use may infringe copyright laws. Even for the purpose of private use, recording of certain material may be restricted.

- Please note that the actual controls and components, menu items, etc. of your Digital Camera may look somewhat different from those shown in the illustrations in these Operating Instructions.
- SDHC Logo is a trademark.
- Microsoft product screen shot(s) reprinted with permission from Microsoft Corporation.
- Other names, company names, and product names printed in these instructions are trademarks or registered trademarks of the companies concerned.

■ **Care of the camera**

• **Do not strongly shake or bump the camera by dropping it etc.**

This unit may malfunction, recording pictures may no longer be possible or the lens or the LCD monitor may be damaged.

- We strongly recommend you do not leave the camera in your trousers pocket when you sit down or forcefully insert it into a full or tight bag etc.

Damage to the LCD monitor or personal injury may result.

• **Be particularly careful in the following places as they may cause this unit to malfunction.**

– Places with a lot of sand or dust.

– Places where water can come into contact with this unit such as when using it on a rainy day or on a beach.

• **Do not touch the lens or the sockets with dirty hands. Also, be careful not to allow liquids, sand and other foreign matter to get into the space around the lens, buttons etc.**

• **If water or seawater splashes on the camera, use a dry cloth to wipe the camera body carefully.**

■ **About Condensation (When the lens is fogged up)**

- Condensation occurs when the ambient temperature or humidity changes. Be careful of condensation since it causes lens stains, fungus and camera malfunction.























- If condensation occurs, turn the camera off and leave it for about 2 hours. The fog will disappear naturally when the temperature of the camera becomes close to the ambient temperature.

■ **Read together with the “Cautions for Use”. (P110)**

■ **About illustrations in these operating instructions**

- Please note that the appearance of the product, the illustration or the menu screen are a little different from those in actual use.

Contents

<hr/> <hr/>	
Before Use	
<hr/> <hr/>	
Information for Your Safety.....	3
Quick Guide.....	7
Standard Accessories.....	8
Names of the Components.....	9
<hr/> <hr/>	
Preparation	
<hr/> <hr/>	
Charging the Battery	11
• About the Battery (charging/ number of recordable pictures)	12
Inserting/Removing the Battery/Card (Optional)	14
About the Built-in Memory/the Card	16
Setting Date/Time (Clock Set)	18
About the Mode and Menu Operation ...	20
• Mode switching	20
• About the menu operation.....	21
• Using the quick menu.....	24
About the [SETUP] Menu	25
<hr/> <hr/>	
Basic	
<hr/> <hr/>	
Taking Pictures Using the Automatic Function (Auto Scene Mode)	28
• Scene detection	30
• About the flash	31
• Settings in AUTO Scene mode.....	31
Taking Pictures with Your Favorite Settings (Normal Picture Mode)	32
• Focusing.....	33
• When the subject is not in focus (such as when it is not in the center of the composition of the picture you want to take)	33
• Preventing jitter (camera shake).....	34
Taking Pictures with the Zoom.....	35
• Using the optical zoom/ the extended optical zoom (EZ)/ the digital zoom	35
Playing Back Pictures (Normal Playback Mode)	37
• Displaying multiple screens (Multi Playback).....	38
• Using the playback zoom	39
Deleting Pictures	40
• To delete a single picture	40
• To delete multiple pictures (up to 50) or all the pictures	41
<hr/> <hr/>	
Advanced-Shooting	
<hr/> <hr/>	
About the LCD Monitor	42
• Display in large size	43
Taking Pictures Using the Built-in Flash	44
• Switching to the appropriate flash setting.....	44
Taking Close-up Pictures.....	49
Taking Pictures with the Self-timer	50
Compensating the Exposure	51
Taking Pictures that Match the Scene being Recorded (Scene Mode)	52
•  [PORTRAIT]	53
•  [SOFT SKIN]	53
•  [SELF PORTRAIT]	53
•  [SCENERY]	54
•  [SPORTS]	54
•  [NIGHT PORTRAIT]	54
•  [NIGHT SCENERY]	55
•  [FOOD]	55
•  [PARTY]	56
•  [CANDLE LIGHT]	56
•  [BABY1] /  [BABY2]	57
•  [PET]	58
•  [SUNSET]	58
•  [HIGH SENS.]	58
•  [HI-SPEED BURST]	59
•  [FLASH BURST]	59
•  [STARRY SKY]	60
•  [FIREWORKS]	60
•  [BEACH]	61
•  [SNOW]	61
•  [AERIAL PHOTO]	61
Motion Picture Mode.....	62
Useful Functions at Travel Destinations	65
• Recording which day of the vacation you take the picture.....	65
• Recording date/time at overseas travel destinations (World time).....	68
Using the [REC] Menu.....	70

• [PICTURE SIZE].....	70
• [QUALITY].....	71
• [SENSITIVITY].....	71
• [WHITE BALANCE].....	72
• [AF MODE].....	74
• [BURST].....	76
• [DIGITAL ZOOM].....	77
• [COLOR MODE].....	77
• [AF ASSIST LAMP].....	78
• [CLOCK SET].....	78

Advanced-Viewing

Playing Back Pictures in Sequence (Slide Show).....	79
Selecting Pictures and Playing Them Back.....	82
• [FAVORITE PLAY].....	82
Playing Back Motion Pictures.....	83
Using the [PLAYBACK] Menu.....	84
• [CALENDAR].....	84
• [TITLE EDIT].....	85
• [TEXT STAMP].....	87
• [RESIZE] Reducing the picture size (number of pixels).....	89
• [ROTATE].....	90
• [FAVORITE].....	91
• [PRINT SET].....	92
• [PROTECT].....	94
• [COPY].....	95

Connecting to other equipment

Connecting to a PC.....	96
• Using a PC with an SD Memory Card slot or a card reader.....	98
Printing the Pictures.....	99
• Selecting a single picture and printing it.....	100
• Selecting multiple pictures and printing them.....	101
• Print Settings.....	102
• Using a printer with an SD Memory Card slot.....	104
Playing Back Pictures on a TV Screen.....	105
• Playing back pictures using the AV cable.....	105
• Playing back pictures on a TV with an SD Memory Card slot.....	106

Others

Screen Display.....	107
Cautions for Use.....	110
Message Display.....	115
Troubleshooting.....	118
• Battery and power source.....	118
• Shooting.....	119
• LCD monitor.....	121
• Flash.....	122
• Playback.....	122
• TV, PC and printer.....	124
• Others.....	125
Number of Recordable Pictures and Available Recording Time.....	127

Quick Guide

This is the overview of the procedure to record pictures with this camera. For each operation, be sure to refer to the corresponding pages.

1

Charge the battery. (P11)

- The battery is not charged when the camera is shipped. Charge the battery before use.

plug-in type

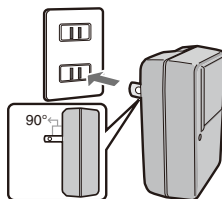

inlet type

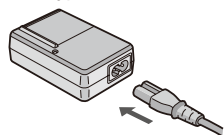

2

Insert the battery and the card.

- When you do not use the card (optional), you can record or play back pictures on the built-in memory. Refer to P17 when you use a card.

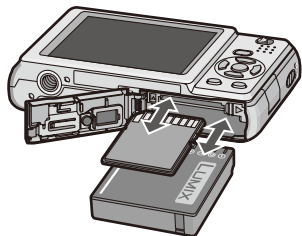

3

Turn the camera on to take pictures.

- Set the clock. (P18)

- 1 Set the recording/playback switch to [📷].
- 2 Press the shutter button to take pictures. (P29)

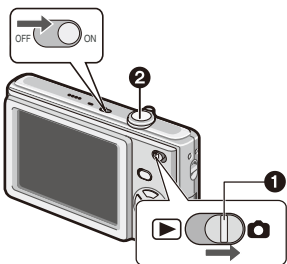

4

Play back the pictures.

- 1 Set the recording/playback switch to [▶].
- 2 Select the picture you want to view. (P37)

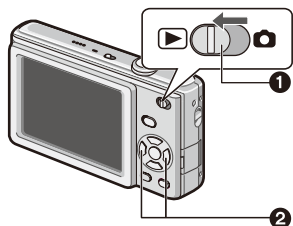

Standard Accessories

Before using your camera, check the contents.

- 1 Battery Pack
(Indicated as **battery** in the text)
Charge the battery before use.
- 2 Battery Charger
(Indicated as **charger** in the text)
- 3 AC Cable
- 4 AV Cable
- 5 USB Connection Cable
- 6 CD-ROM
 - Software:
Use it to install the software to your PC.
 - Operating Instructions
- 7 Hand Strap
- 8 Battery Case

- The accessories and their shape will differ depending on the country or area where the camera was purchased.
- SD Memory Card and SDHC Memory Card are indicated as **card** in the text.
- **Card is optional.**
You can record or play back pictures on the built-in memory when you are not using a card.
- If any of the accessories are lost, customers in the USA and Puerto Rico should contact Panasonic's parts department at 1 800 833-9626 and customers in Canada should contact 1 800 99-LUMIX (1-800-995-8649) for further information about obtaining replacement parts.

Names of the Components

- 1 Zoom lever (P35)
 - 2 Shutter button (P29)
 - 3 Camera ON/OFF switch (P18)
 - 4 Microphone (P62)
 - 5 Speaker (P25, 83)
 - 6 Self-timer indicator (P50)
AF assist lamp (P78)
 - 7 Flash (P44)
 - 8 Lens part
 - 9 Lens barrel
 - 10 LCD monitor (P42, 121)
 - 11 Recording/playback switch (P20)
 - 12 Cursor buttons
- (A) ▲ /Exposure compensation (P51)
 (B) ▼ /Macro button (P49)
 (C) ◀ /Self-timer button (P50)
 (D) ▶ /Flash mode button (P44)

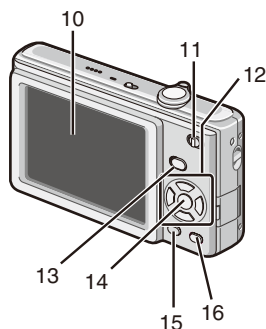
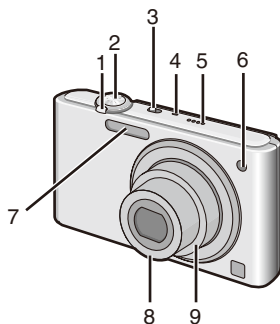

In these operating instructions, operations using the cursor buttons are described as follows.

e.g.: When you press the ▼ (🌸) button.



or

Press ▼

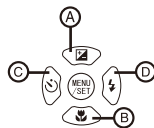

- 13 [MODE] button (P20)
- 14 [MENU/SET] button (P20)
- 15 [DISPLAY] button (P42)
- 16 [Q.MENU] (P24)/Delete (P40) button

17 Hand strap eyelet

- Attach the strap when using the camera to prevent it from dropping.

18 [AV OUT/DIGITAL] socket (P96, 99, 105)**19 Tripod receptacle**

- When you use a tripod, make sure the tripod is stable with the camera attached to it.

20 Card/Battery door (P14)**21 DC coupler cover (P15)**

- When using an AC adaptor, ensure that the Panasonic DC coupler (optional) and AC adaptor (optional) are used. For connection details, refer to P15.

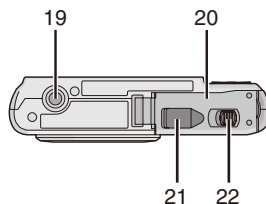
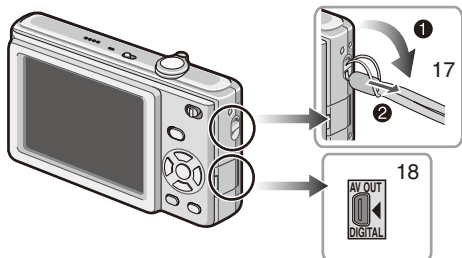
22 Release lever (P14)

Charging the Battery

■ About batteries that you can use with this unit

Supplied battery or dedicated optional batteries can be used with this camera. Refer to Basic Operating Instructions about the accessory number of the available optional batteries in your area.

It has been found that counterfeit battery packs which look very similar to the genuine product are made available to purchase in some markets. Some of these battery packs are not adequately protected with internal protection to meet the requirements of appropriate safety standards. There is a possibility that these battery packs may lead to fire or explosion. Please be advised that we are not liable for any accident or failure occurring as a result of use of a counterfeit battery pack. To ensure that safe products are used we would recommend that a genuine Panasonic battery pack is used.

- Use the dedicated charger and battery.
- The camera has a function for distinguishing batteries which can be used safely. The dedicated battery supports this function. The only batteries suitable for use with this unit are genuine Panasonic products and batteries manufactured by other companies and certified by Panasonic. (Batteries which do not support this function cannot be used). Panasonic cannot in any way guarantee the quality, performance or safety of batteries which have been manufactured by other companies and are not genuine Panasonic products.
- The battery is not charged when the camera is shipped. Charge the battery before use.
- Charge the battery with the charger indoors.
- Charge the battery in a temperature between 10 °C to 35 °C (50 °F to 95 °F). (The battery temperature should also be the same.)

1 Attach the battery paying attention to the direction of the battery.

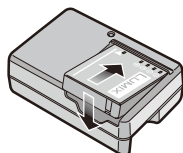

2 Connect the charger to the electrical outlet.

- Charging starts when the [CHARGE] indicator (A) lights green.
- Charging is complete when the [CHARGE] indicator (A) turns off (after approx. 100 min).

(Inlet type)

- The AC cable does not fit entirely into the AC input terminal. A gap will remain as shown on the right.

plug-in type

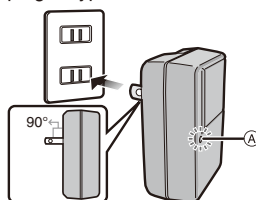

inlet type

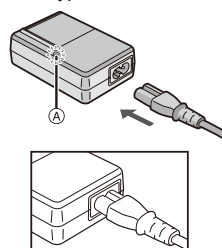



Detach the battery after charging is completed.

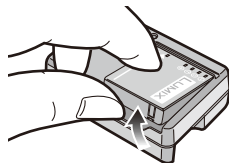

■ When the [CHARGE] indicator flashes

- The battery temperature is excessively high or low. The charging time will be longer than normal. Also, charging may not be completed.
- The terminals of the charger or the battery are dirty. In this case, wipe them with a dry cloth.

Note

- After charging is completed, be sure to disconnect the power supply device from the electrical outlet.
- The battery becomes warm after using it, and while and after charging. The camera also becomes warm during use. This is not a malfunction.
- The battery will be exhausted if left for a long period of time after being charged.
- The battery can be recharged even when it still has some charge left, but it is not recommended that the battery charge be frequently topped up while the battery is fully charged. (The battery has characteristics that will reduce its operating duration and cause the battery to swell up.)
- When the operating time of the camera becomes extremely short even after properly charging the battery, the life of the battery may have expired. Buy a new battery.
- **Do not leave any metal items (such as clips) near the contact areas of the power plug. Otherwise, a fire and/or electric shocks may be caused by short-circuiting or the resulting heat generated.**

About the Battery (charging/number of recordable pictures)

■ Battery indication

- The battery indication is displayed on the LCD monitor.
[It does not appear when you use the camera with the AC adaptor (optional) connected.]

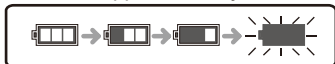

- The indication turns red and blinks if the remaining battery power is exhausted. Recharge the battery or replace it with a fully charged battery.

■ Battery life

The number of recordable pictures (By CIPA standard in Normal Picture Mode [])

	Supplied battery	Optional battery
Number of recordable pictures	Approx. 300 pictures	Approx. 390 pictures
Recording time	Approx. 150 min	Approx. 195 min

Recording conditions by CIPA standard

- Temperature: 23 °C (73.4 °F)/Humidity: 50% when the LCD monitor is on.
- Using a Panasonic SD Memory Card (32 MB)
- Starting recording 30 seconds after the camera is turned on.
- **Recording once every 30 seconds**, with full flash every second recording.
- Rotating the zoom lever from Tele to Wide or vice versa in every recording.
- Turning the camera off every 10 recordings. Leaving the camera until the battery cools down.
- CIPA is an abbreviation of [Camera & Imaging Products Association].

The number of recordable pictures varies depending on the recording interval time. If the recording interval time becomes longer, the number of recordable pictures decreases. (e.g. When recording once every 2 minutes: about 1/4 of the number when recording once every 30 seconds)

	Supplied battery	Optional battery
Playback time	Approx. 330 min	Approx. 420 min

The number of recordable pictures and playback time will vary depending on the operating conditions and storing condition of the battery.

■ Charging

	Supplied battery	Optional battery
Charging time*	Approx. 100 min	Approx. 130 min

* with the supplied charger

The charging time will vary slightly depending on the status of the battery and the conditions in the charging environment.

When the charging has been completed successfully, the [CHARGE] indicator turns off.

Note

- The battery may swell and its operating time may become shorter as the number of times it is charged increases. For long term battery use, we recommend you do not frequently charge the battery before it is exhausted.
- The performance of the battery may temporarily deteriorate and the operating time may become shorter in low temperature conditions (e.g. skiing/snowboarding).

Inserting/Removing the Battery/Card (Optional)

- Check that the camera is turned off.
- We recommend using a Panasonic card.

1 Slide the release lever in the direction of the arrow and open the card/battery door.

- Always use genuine Panasonic batteries.
- If you use other batteries, we cannot guarantee the quality of this product.

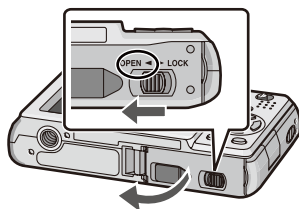

2 **Battery:** Insert it fully being careful about the direction for insert. Pull the lever **A** in the direction of the arrow to remove the battery. **Card:** Push it fully until it clicks being careful about the direction for insert. To remove the card, push the card until it clicks, then pull the card out upright.

B Do not touch the connection terminals of the card.

- The card may be damaged if it is not fully inserted.

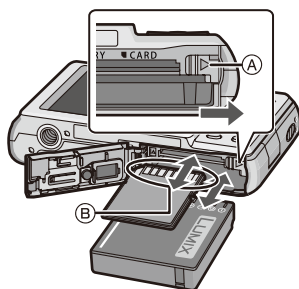

3 **1:** Close the card/battery door.
2: Slide the release lever in the direction of the arrow.

- If the card/battery door cannot be completely closed, remove the card, check its direction and then insert it again.

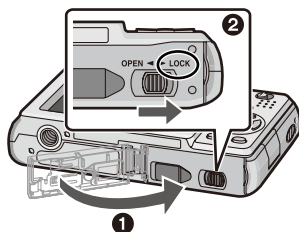

Note

- Remove the battery after use. Store the removed battery in the battery case (supplied).
- Do not remove the battery until the LCD monitor turns off as the settings on the camera may not be stored properly.
- The supplied battery is designed only for the camera. Do not use it with any other equipment.
- Before removing the card or battery, turn the camera off. (Otherwise, this unit may no longer operate normally and the card itself may be damaged or the recorded pictures may be lost.)

■ Using an AC adaptor (optional) and a DC coupler (optional) instead of the battery
 Ensure that the AC adaptor (optional) and DC coupler (optional) are purchased as a set. Do not use if sold separately.

- ① Open the card/battery door.
 - ② Insert the DC coupler, being careful of the direction.
 - ③ Close the card/battery door.
 - Ensure that the card/battery door is closed.
 - ④ Open the DC coupler cover ④.
 - If it is difficult to open the cover, open the card/battery door, and then press the coupler cover from inside to open.
 - ⑤ Plug the AC adaptor into an electrical outlet.
 - ⑥ Connect the AC adaptor ⑥ to the [DC IN] socket ⑥ of the DC coupler.
- ⑦ Align the marks, and insert.
- Ensure that only the AC adaptor and DC coupler for this camera are used. Using any other equipment may cause damage.

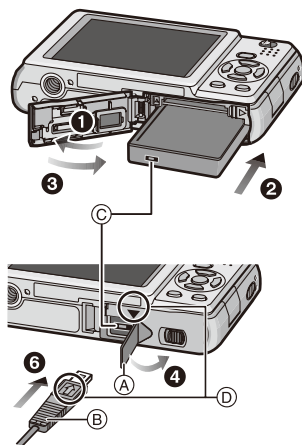

Note

- Always use a genuine Panasonic AC adaptor (optional).
- Some tripods cannot be attached when the DC coupler is connected.
- Make sure to unplug the AC adaptor when you open the card/battery door.
- If the AC adaptor and DC coupler are not necessary, then remove them from the digital camera. Also, please keep the DC coupler cover closed.
- Also read the operating instructions for the AC adaptor and DC coupler.
- If the power supply from the outlet is cut off while recording motion pictures using the DC coupler, the pictures being shot will not be recorded. Securing stable power supply or using the battery is recommended.

About the Built-in Memory/the Card

The following operations can be performed using this unit.

- When a card has not been inserted: Pictures can be recorded in the built-in memory and played back.
- When a card has been inserted: Pictures can be recorded on the card and played back.
- **When using the built-in memory**
 [IN] → [IN] (access indication^{*1})
- **When using the card**
 [→] (access indication^{*1})

^{*1} The access indication lights red when pictures are being recorded on the built-in memory (or the card).





Built-in Memory

- **Memory size: Approx. 50 MB**
- **Recordable motion pictures: QVGA (320 × 240 pixels) only**
- The built-in memory can be used as a temporary storage device when the card being used becomes full.
- You can copy the recorded pictures to a card. (P95)
- The access time for the built-in memory may be longer than the access time for a card.

Card

The following types of cards can be used with this unit.
(These cards are indicated as card in the text.)

Type of card	Characteristics
SD Memory Card (8 MB to 2 GB) (Formatted using the FAT12 or FAT16 format in compliance with the SD standard)	<ul style="list-style-type: none"> • Fast recording and writing speed • Write-Protect switch  provided (When this switch is set to the [LOCK] position, no further data writing, deletion or formatting is possible. The ability to write, delete and format data is restored when the switch is returned to its original position.) 
SDHC Memory Card (4 GB to 32 GB)^{*2} (Formatted using the FAT32 format in compliance with the SD standard)	

^{*2} The SDHC Memory Card is a memory card standard decided by the SD Association in 2006 for high capacity memory cards more than 2 GB.

You can use an SDHC Memory Card in equipment that is compatible with SDHC Memory Cards however you cannot use an SDHC Memory Card in equipment that is only compatible with SD Memory Cards. (Always read the operating instructions for the equipment being used.)

- You can only use cards with SDHC logo (indicating compliance with the SD standard) if using cards with 4 GB or more capacity.
- Please confirm the latest information on the following website.

<http://panasonic.jp/support/global/cs/dsc/>

(This Site is in English only.)

Note

- Do not turn this unit off, remove its battery or card or disconnect the AC adaptor (optional) when the access indication is lit [when pictures are being written, read or deleted or when the built-in memory or the card is being formatted (P27)]. Furthermore, do not subject the camera to vibration, impact or static electricity. The card or the data on the card may be damaged, and this unit may no longer operate normally.
If the operation stops due to vibration, impact or static electricity, operate this unit again.
- The data on the built-in memory or the card may be damaged or lost due to electromagnetic waves, static electricity or breakdown of the camera or the card. We recommend storing important data on a PC etc.
- Do not format the card on your PC or other equipment. Format it on the camera only to ensure proper operation. (P27)
- Keep the Memory Card out of reach of children to prevent swallowing.

Setting Date/Time (Clock Set)

- The clock is not set when the camera is shipped.

1 Turn the camera on.

- Ⓐ [MENU/SET] button
- Ⓑ Cursor buttons
- (When the language select screen is not displayed → step 4)

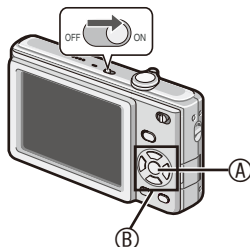

2 Press [MENU/SET].

3 Press ▲/▼ to select the language, and press [MENU/SET].

- The [PLEASE SET THE CLOCK] message appears. (This message does not appear in Playback Mode.)



4 Press [MENU/SET].

5 Press ◀/▶ to select the items (year, month, day, hour, minute, display sequence or time display format), and press ▲/▼ to set.

- Ⓒ Time at the home area
- Ⓓ Time at the travel destination (P68)
- 🗑️: Cancel without setting the clock.
- Select either [24HRS] or [AM/PM] for the time display format.
- AM/PM is displayed when [AM/PM] is selected.

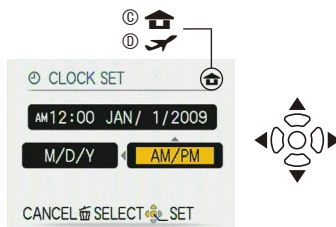

6 Press [MENU/SET].

- After completing the clock settings, turn the camera off. Then turn the camera back on, switch to Recording Mode, and check that the display reflects the settings that were performed.
- When [MENU/SET] has been pressed to complete the settings without the clock having been set, set the clock correctly by following the “Changing the clock setting” procedure (P19).

Changing the clock setting

- ① Press [MENU/SET] in Normal Picture Mode.
 - ② Press ▲/▼ to select [CLOCK SET].
 - ③ Press ► and perform steps 5 and 6 for setting.
 - ④ Press [MENU/SET] to close the menu.
- You can also set the clock in the [SETUP] menu. (P25)

Note

- The clock is displayed when [DISPLAY] is pressed several times during recording.
- The clock setting is maintained for 3 months using the built-in clock battery even without the battery. (Leave the charged battery in the unit for 24 hours to charge the built-in battery.)
- You can set the year from 2000 to 2099.
- Set the date so that the correct date is printed when you order prints or use the text stamp. (P87)
- If the clock is set, the correct date can be printed even if the date is not displayed on the screen of the camera.

About the Mode and Menu Operation

Mode switching

- 1** Slide the recording/playback switch **A** to **📷 (right)** or **▶ (left)**.
📷 : Recording Mode
▶ : Playback Mode

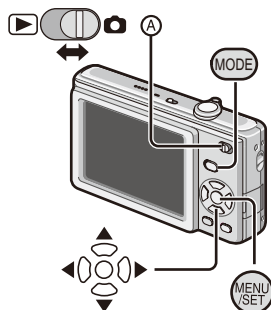



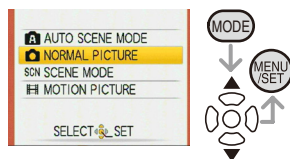

- 2** Press **[MODE]** to display the mode selection screen.
 (Example: Normal Picture Mode)





- 3** Press **▲/▼** to select a mode and press **[MENU/SET]** to close the menu.
 Refer to corresponding page for more details on each mode.

■ List of Recording Modes

 Auto Scene Mode	P28	Taking pictures easily.
 Normal Picture Mode	P32	Taking pictures in the desired setting.
 Scene Mode	P52	Taking pictures according to the scene.
 Motion Picture Mode	P62	This mode allows you to record motion pictures with audio.

■ List of Playback Modes

 Normal Play Mode	P37	Playing back the pictures normally.
 Slide Show Mode	P79	Playing back the pictures continuously.
 Favorite Play Mode	P82	Playing back the pictures set as your favorite. <ul style="list-style-type: none"> • Pictures do not appear when the [FAVORITE] is set to [OFF].



About the menu operation

The camera comes with menus that allow you to set the settings for taking pictures and playing them back just as you like.

In particular, the [SETUP] menu contains some important settings relating to the camera's clock and power. Check the settings of this menu before proceeding to use the camera.

■ In Recording Mode

■ In Playback Mode

 [REC] menu	P70 to 78	 [PLAYBACK] menu	P84 to 95
This menu lets you set the coloring, sensitivity, or number of pixels, etc. of the pictures you are recording.		This menu lets you make the protection or print settings, etc. of recorded pictures.	
 [SETUP] menu			P25 to 27
<ul style="list-style-type: none"> • This menu lets you perform the clock settings, select the operating beep tone settings and set other settings which make it easier for you to operate the camera. • Available in Recording or Playback Mode. 			

■ How to use the menu

- 1** Press [MENU/SET] to display the menu.
- You can switch menu screens by the page from any menu item by rotating the zoom lever. (Example: Selecting the Normal Picture Mode [])

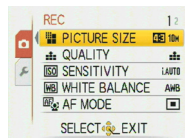

- 2** Press ▲/▼ to select a menu item. (Example: Selecting [AF MODE])
- You can move to the next page by pressing ▼ at the very bottom.

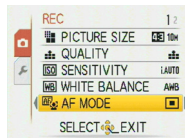

- 3** Press ►.
- Depending on the item, the settings may not appear or it may be displayed in a different way.

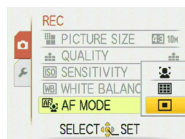

- 4** Press ▲/▼ to select a setting. (Example: Selecting [])

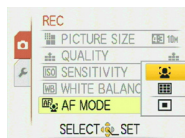

- 5** Press [MENU/SET] to confirm your setting.

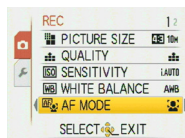

- 6** Press [MENU/SET] to close the menu.

Switching to the [SETUP] menu

When the camera shows the menu screen after step 1 on “How to use the menu” (P22):

- ① Press ◀ to move the menu icon.

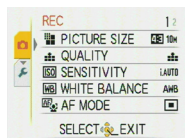

- ② Press ▼ to select the [SETUP] menu icon [⚙].



- ③ Press ▶ to move to the menu item list.
Proceed to step 2 on “How to use the menu”.

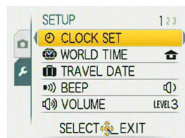

Note

- Due to the camera's specification, it may not be possible to set some of the functions or some functions may not work in some of the conditions under which the camera is used.

Using the quick menu

Using the quick menu, some of the menu items can be easily found.

- Some of the menu items cannot be set by the modes.

1 Press and hold [Q.MENU] when the camera is in the Recording Mode.

2 Press ▲/▼/◀/▶ to select the menu item and its setting and then press [MENU/SET] to close the menu.

- Ⓐ The item to be set and the setting are displayed.

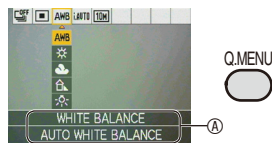

Perform these settings if you need to.

About the [SETUP] Menu

[CLOCK SET], [POWER SAVE] and [AUTO REVIEW] are important items. Check their settings before using them.

- In the Auto Scene Mode, only [CLOCK SET], [WORLD TIME], [BEEP] and [LANGUAGE] can be set.

For details on how to select the [SETUP] menu settings, refer to **P23**.

 [CLOCK SET]	Set the date and time.
---	------------------------

- Refer to **P18** for details.

 [WORLD TIME]	Set the time in your home area and travel destination. ✈ [DESTINATION]: Travel destination area 🏠 [HOME]: Your home area
--	--

- Refer to **P68** for details.

 [TRAVEL DATE]	Set the departure date and the return date of the vacation.
	[TRAVEL SETUP] [LOCATION] [OFF]/[SET] [OFF]/[SET]

- Refer to **P65** for details.

 [BEEP]	Allows you to change the volume of operational sound. 🔇 : No operational sound 🔊 : Soft operational sound 🔊 : Loud operational sound
--	---

 [VOLUME]	Allows you to adjust the volume of the speaker to any of 7 levels.
--	--

- When you connect the camera to a TV, the volume of the TV speakers does not change.

 [DISPLAY SIZE]	The icons on the screen are displayed in large size for easy viewing.
	[STANDARD]/[LARGE]

- Refer to **P43** for details.

 [POWER SAVE]	Saves the battery consumption.
	The camera is automatically turned off if the camera has not been used for the time selected on the setting. [OFF]/[2MIN.]/[5MIN.]/[10MIN.]

- Press the shutter button halfway or turn the camera off and on to cancel **[POWER SAVE]**.
- **[POWER SAVE]** is set to **[5MIN.]** in the Auto Scene Mode **[A]**.
- **[POWER SAVE]** does not work in the following cases:
 - When using the AC adaptor (optional)/When connecting to a PC or a printer/When recording or playing back motion pictures/During slide show/**[AUTO DEMO]**

 [AUTO REVIEW]	Set the length of time that the picture is displayed after taking it.
	[OFF] [1SEC.] [2SEC.] [HOLD]: The pictures are displayed until any one of the buttons is pressed. [ZOOM]: The picture is displayed for 1 second and then at 4x zoom for 1 second further.

- The Auto Review works regardless of its setting when using **[SELF PORTRAIT]**, **[HI-SPEED BURST]** and **[FLASH BURST]** in Scene Mode and **[BURST]**. However, **[ZOOM]** is disabled.
- In Auto Scene Mode **[A]**, the Auto Review function is fixed to **[2SEC.]**.
- This does not work when recording motion pictures.

 [RESET]	The [REC] or [SETUP] menu settings are reset to the initial settings.
--	---

- When the **[RESET]** setting is selected during recording, the operation that resets the lens is also performed at the same time. Despite the lens operation noise that occurs, this is not a malfunction.
- When you reset the **SETUP** settings, the following settings are also initialized:
 - Birthday and name settings in **[BABY1]/[BABY2]** and **[PET]** Mode
 - **[TRAVEL DATE]** setting
 - **[WORLD TIME]** setting
- **[FAVORITE]** is fixed to **[OFF]**.
- The folder number and the clock setting are not changed.

(Only for DMC-F2PU/DMC-F2PR)

 [VIDEO OUT]	Set to match the colour television system in each country. (Playback mode only)
	[NTSC]: Video output is set to NTSC system. [PAL]: Video output is set to PAL system.

- This will work when the AV cable is connected.

 [TV ASPECT]	Set to match the type of TV. (Playback Mode only)
	[16:9]: When connecting to a 16:9 screen TV. [4:3]: When connecting to a 4:3 screen TV.

- This will work when the AV cable is connected.

 [VERSION DISP.]	It is possible to check which version of firmware is on the camera.
---	---

 [FORMAT]	Initializes the built-in memory or card. Formatting irretrievably deletes all the data so check the data carefully before formatting.
--	---

- Use a battery with sufficient power or the AC adaptor (optional) when formatting. Do not turn the camera off when formatting.
- If a card has been inserted, only the card is formatted. To format the built-in memory, remove the card.
- If the card has been formatted on a PC or other equipment, format it on the camera again.
- It may take longer to format the built-in memory than the card.
- If the built-in memory or the card cannot be formatted, consult your nearest Service Center.

For USA and Puerto Rico assistance, please call: 1-800-211-PANA (7262) or, contact us via the web at: <http://www.panasonic.com/contactinfo>

For Canadian assistance, please call: 1-800-99-LUMIX (1-800-995-8649) or send e-mail to: lumixconciierge@ca.panasonic.com

 [LANGUAGE]	Set the language displayed on the screen.
--	---

- When you set to other language by mistake, select [] from the menu icons to set the desired language.

DEMO [AUTO DEMO]	The camera's features are displayed as a slide show. [OFF]/[ON]
------------------	--

- Press any button, such as [MENU/SET], to close [AUTO DEMO].
- [AUTO DEMO] has no TV output capability.

Recording Mode: **A**

Taking Pictures Using the Automatic Function (Auto Scene Mode)

The camera automatically sets the appropriate settings according to the subject and recording condition. This mode is recommended for beginners to take pictures easily.

- The following functions are activated automatically.
 - Scene detection/Face detection/Motion detection/Backlight Compensation
- Ⓐ Shutter button
- Ⓑ Recording/playback switch

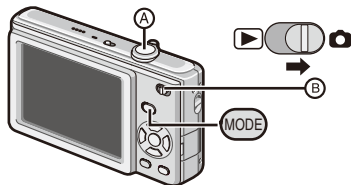

- 1** Slide the recording/playback switch to [] and press [MODE].

- 2** Press **▲/▼** to select [AUTO SCENE MODE] and then press [MENU/SET].



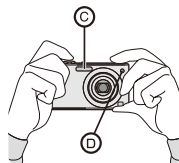

- 3** Hold this unit gently with both hands, keep your arms still at your side and stand with your feet slightly apart.

- Ⓒ Flash
- Ⓓ AF assist lamp



4

Press the shutter button halfway to focus.

- Refer to “Focusing” (P33) for details.
- The focus indication  lights green when the subject is focused.
- The AF area  is displayed around the subject's face by the face detection function. In other cases, it is displayed at the point on the subject which is in focus.
- The focus range is 5 cm (0.17 feet)(Wide)/50 cm (1.64 feet)(Tele) to ∞ .
- The maximum close-up distance (the shortest distance at which the subject can be taken) differs depending on the zoom magnification.



5

Press the shutter button fully (push it in further), and take the picture.





- The access indication (P16) lights red when pictures are being recorded on the built-in memory (or the card).

■ **When taking pictures using the flash (P44)**■ **When taking pictures using the zoom (P35)** **Note**

- Be careful not to move the camera when you press the shutter button.
- Do not cover the photo flash or the AF assist lamp with your finger or other objects.
- Do not touch the lens.

Scene detection



When the camera identifies the optimum scene, the icon of the scene concerned is displayed in blue for 2 seconds, after which its color changes to the usual red.

A →	 [i-PORTRAIT]
	 [i-SCENERY]
	 [i-MACRO]
	 [i-NIGHT PORTRAIT]
	 [i-NIGHT SCENERY]

• Only when [ A] is selected

- [ A] is set if none of the scenes are applicable, and the standard settings are set.

■ Face detection

When [ i-F] or [ i-F] is selected, the camera automatically detects a person's face, and it will adjust the focus and exposure (P74).



Note







- Due to conditions such as the ones below, a different scene may be identified for the same subject.
 - Subject conditions: When the face is bright or dark, The size of the subject, The distance to the subject, The contrast of the subject, When the subject is moving, When zoom is used
 - Recording conditions: Sunset, Sunrise, Under low brightness conditions, When the camera is shaken
- To take pictures in an intended scene, it is recommended that you take pictures in the appropriate Recording Mode.

■ The backlight compensation

Backlight refers to when light comes from the back of a subject.

In this case, the subject will become dark, so this function compensates the backlight by brightening the whole of the picture automatically.

About the flash

- When [] is selected, [], [] or [] is set depending on the type of subject and brightness.
- When [] or [] is set, the flash is activated twice.

Settings in AUTO Scene mode

Only the following functions can be set in this mode.

[REC] menu





– [PICTURE SIZE]* (P70)/[BURST] (P76)/[COLOR MODE]* (P77)

* The settings which can be set are different from when other recording modes are used.

[SETUP] menu

– [CLOCK SET]/[WORLD TIME]/[BEEP]/[LANGUAGE]

The settings of the following items are fixed.

Item	Settings
[POWER SAVE] (P26)	[5MIN.]
[AUTO REVIEW] (P26)	[2SEC.]
[FLASH] (P44)	 / 
[QUALITY] (P71)	
[SENSITIVITY] (P71)	[i.AUTO]
[WHITE BALANCE] (P72)	[AWB]
[AF MODE] (P74)	[] (Set to [] when a face cannot be detected)
[AF ASSIST LAMP] (P78)	[ON]
Self-timer (P50)	[10SEC.]/[OFF]

- The following functions cannot be used.
 - Compensating exposure/[DIGITAL ZOOM]
- The other items on the [SETUP] menu can be set in a mode such as the Normal Picture Mode. What is set will be reflected in the Auto Scene Mode.

Recording Mode: 

Taking Pictures with Your Favorite Settings

(Normal Picture Mode)

This mode allows you to take pictures freely as more options are available than Auto Scene Mode [] (P28).

- 1** Slide the recording/playback switch to [] and press [MODE].

Ⓐ Recording/playback switch

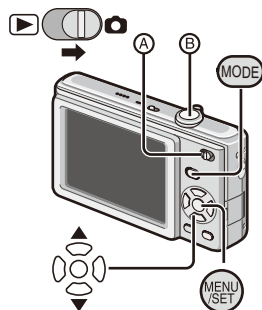

- 2** Press / to select [NORMAL PICTURE] and press [MENU/SET].

• To change the setting while taking pictures, refer to “Using the [REC] Menu”(P70).

- 3** Aim the AF area to the point you want to focus on.

- 4** Press the shutter button  halfway to focus.

- The focus indication (green) lights when the subject is focused.
- The focus range is 50 cm (1.64 feet) to ∞ .
- If pictures are to be taken at an even closer range, refer to “Taking Close-up Pictures” (P49).



- 5** Press the shutter button fully (push it in further), and take the picture.

- The access indication (P16) lights red when a picture is being recorded on the built-in memory (or the card).



- To adjust the exposure and take pictures at times when the image appears too dark (P51)
- To adjust the colors and take pictures at times when the image appears too red (P72)

Focusing

Aim the AF area at the subject, and then press the shutter button halfway.

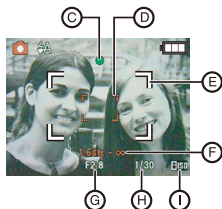

Focus	When the subject is focused	When the subject is not focused
Focus indication	On	Blinks
AF area	White→Green	White→Red
Sound	Beeps 2 times	Beeps 4 times

- Ⓒ Focus indication
- Ⓓ AF area (normal)
- Ⓔ AF area (when using the digital zoom or when it is dark)
- Ⓕ Focus range (when using the zoom)
- Ⓖ Aperture value*
- Ⓗ Shutter speed*
- Ⓙ ISO sensitivity

* If correct exposure cannot be achieved, it will be displayed in red. (However, it will not be displayed in red when the flash is used.)

When the subject is not in focus (such as when it is not in the center of the composition of the picture you want to take)

- 1 Aim the AF area at the subject, and then **press the shutter button halfway** to fix the focus and exposure.
 - 2 **Press and hold the shutter button halfway** while moving the camera as you compose the picture.
- You can repeatedly retry the actions in step 1 before pressing the shutter button fully.

We recommend that you use the Face Detection function when taking pictures of people. (P74)



■ Subjects and recording conditions which are difficult to focus

- Fast-moving subjects, extremely bright subjects or subjects without contrast
- When recording subjects through windows or near shiny objects
- When it is dark or when jitter occurs
- When the camera is too close to the subject or when taking a picture of both distant and near subjects (when the recordable range display has appeared in red).

Preventing jitter (camera shake)

When the jitter alert [] appears, use a tripod or the self-timer (P50).

- Shutter speed will be slower particularly in the following cases. Keep the camera still from the moment the shutter button is pressed until the picture appears on the screen. We recommend using a tripod.
 - Slow sync./Red-eye reduction
 - In [NIGHT PORTRAIT], [NIGHT SCENERY], [PARTY], [CANDLE LIGHT], [STARRY SKY] or [FIREWORKS] in Scene Mode

Recording Mode:   SCN 

Taking Pictures with the Zoom

Using the optical zoom/ the extended optical zoom (EZ)/ the digital zoom

You can make people and subjects appear closer with the optical zoom, and landscapes can be recorded in wide angle. To make subjects appear even closer [maximum of 7.1 \times], set the [PICTURE SIZE] to 3M or less.

Even higher levels of magnification are possible when [DIGITAL ZOOM] is set to [ON] in [REC] menu.

To make subjects appear closer use (Tele)

Rotate the zoom lever towards Tele.



To make subjects appear further away use (Wide)

Rotate the zoom lever towards Wide.



■ Types of zooms

Feature	Optical zoom	Extended optical zoom (EZ)	Digital zoom
Maximum magnification	4x	7.1x*	28.5x [including extended optical zoom 7.1x]
Picture quality	No deterioration	No deterioration	The higher the magnification level, the greater the deterioration.
Conditions	None	[PICTURE SIZE] with [EZ] (P70) is selected.	[DIGITAL ZOOM] (P77) on the [REC] menu is set to [ON].
Screen display		 Ⓐ [EZ] is displayed.	 Ⓑ The digital zoom range is displayed.*

- When using the zoom function, an estimate of the focus range will appear in conjunction with the zoom display bar. (Example : 0.5 m (1.64 feet) - ∞)

* The magnification level differs depending on [PICTURE SIZE] setting.

■ How the extended optical zoom works

When you set the picture size to [3M] (3 million pixels), the 10M (10.1 million pixels) CCD area is cropped to the center 3M (3 million pixels) area, allowing a picture with a higher zoom effect.

Note

- The Digital zoom does not operate in Auto Scene Mode [A]
- The indicated zoom magnification is an approximation.
- “EZ” is an abbreviation of “Extended Optical Zoom”.
- The optical zoom is set to Wide (1x) when the camera is turned on.
- If you use the zoom function after focusing on the subject, focus on the subject again.
- The lens barrel extends or retracts according to the zoom position. Take care not to interrupt the motion of the lens barrel while the zoom lever is rotated.
- When using the Digital zoom, we recommend using a tripod and the self-timer (P50) for taking pictures.
- The following cases cannot be used in Extended Optical Zoom:
 - [HIGH SENS.], [HI-SPEED BURST] and [FLASH BURST]/Motion Picture Mode
- The following cases cannot be used in Digital zoom:
 - [SPORTS], [BABY1]/[BABY2], [PET], [HIGH SENS.], [HI-SPEED BURST] and [FLASH BURST] in [SCENE MODE]

Playback Mode: 

Playing Back Pictures (Normal Playback Mode)

1 Slide the recording/playback switch to .

- Normal playback is set automatically in the following cases:
 - When the mode was switched to the Playback Mode.
 - When the camera was turned on while the recording/playback switch was at .

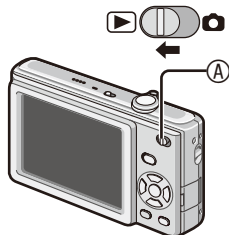







2 Press to select the picture.

- ◀: Play back the previous picture
- ▶: Play back the next picture
- Speed of picture forwarding/rewinding changes depending on the playback status.



■ Fast forwarding/Fast rewinding

Press and hold   during playback.

- The file number  and the picture number  only change one by one. Release   when the number of the desired picture appears to play back the picture.
- If you keep pressing  , the number of pictures forwarded/rewound increases.

Displaying multiple screens (Multi Playback)

Rotate the zoom lever towards [] (W).

1 screen→12 screens→30 screens→Calendar screen display (P84)

- Ⓐ Number of the selected picture and the total number of recorded pictures
- Rotate the zoom lever towards [Q] (T) to return to the previous screen.
 - Pictures are not rotated for display.



■ To return to normal playback

1 Press ▲/▼/◀/▶ to select a picture.

- An icon will be displayed depending on the recorded picture and the settings.





2 Press [MENU/SET].

- The picture that was selected will appear.

Using the playback zoom

Rotate the zoom lever towards [Q] (T) to enlarge the picture.

1×→2×→4×→8×→16×

- When you rotate the zoom lever towards [W] (W) after enlarging the picture, the magnification becomes lower.
- When you change the magnification, the zoom position indication  appears for about 1 second, and the position of the enlarged section can be moved by using ///.
- The more a picture is enlarged, the more its quality deteriorates.
- When you move the position to be displayed, the zoom position indication appears for about 1 second.



Note

- This camera complies with the DCF standard “Design rule for Camera File system” established by JEITA “Japan Electronics and Information Technology Industries Association” and with Exif “Exchangeable Image File Format”. Files which do not comply with the DCF standard cannot be played back.
- You cannot play back the audio of still pictures with audio recorded on other equipment.
- The lens barrel retracts about 15 seconds after switching from the Recording Mode to the Playback Mode.
- The Playback zoom may not operate if pictures have been recorded with other equipment.
- The Playback zoom cannot be used when playing back motion pictures.

Playback Mode:  

Deleting Pictures

Once deleted, pictures cannot be recovered.

- Pictures on the built-in memory or the card, which are being played back, will be deleted.

To delete a single picture

- 1 Select the picture to be deleted, and then press .

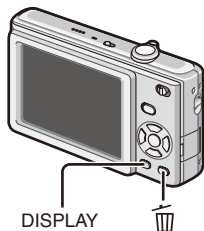

- 2 Press  to select [YES] and then press [MENU/SET].

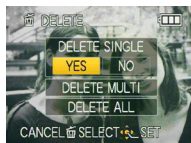

To delete multiple pictures (up to 50) or all the pictures

- 1 Press [].
- 2 Press ▲/▼ to select [DELETE MULTI] or [DELETE ALL] and then press [MENU/SET].
 - [DELETE ALL] → step 5.

- 3 Press ▲/▼/◀/▶ to select the picture and then press [DISPLAY] to set. (Repeat this step.)
 - The selected pictures appear with []. When [DISPLAY] is pressed again, the setting is canceled.

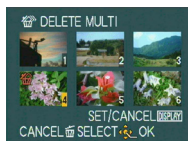

- 4 Press [MENU/SET].

- 5 Press ▲ to select [YES] and then press [MENU/SET] to set.

■ When [DELETE ALL] has been selected with the [FAVORITE] (P91) setting

The selection screen is displayed again. Select [DELETE ALL] or [ALL DELETE EXCEPT ★], press ▲ to select [YES] and delete the pictures. ([ALL DELETE EXCEPT ★] cannot be selected if no pictures have been set as [FAVORITE].)

Note

- Do not turn the camera off while deleting (while [] is displayed). Use a battery with sufficient power or the AC adaptor (optional).
- If you press [MENU/SET] while deleting pictures using [DELETE MULTI], [DELETE ALL] or [ALL DELETE EXCEPT ★], the deleting will stop halfway.
- Depending on the number of pictures to be deleted, it may take some time to delete them.
- If pictures do not conform to the DCF standard or are protected (P94), they will not be deleted even if [DELETE ALL] or [ALL DELETE EXCEPT ★] is selected.

About the LCD Monitor

Press [DISPLAY] to switch the screen to be used.

Ⓐ LCD monitor

- When the menu screen appears, the [DISPLAY] button is not activated.
- During playback zoom, while playing back motion pictures and during a slide show, you can only select “Normal display” or “No display”

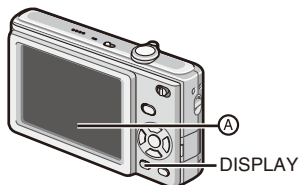

In Recording Mode

- Ⓑ Normal display
- Ⓒ No display
- Ⓓ Guideline display*

* When recording, you can refer to the guideline for composing.

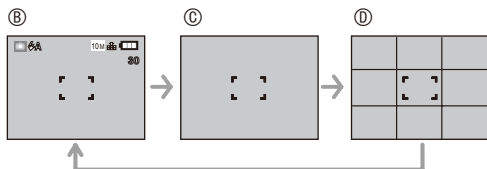

In Playback Mode

- Ⓔ Normal display
- Ⓕ Display with recording information
- Ⓖ No display

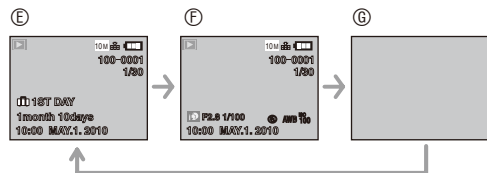

Note

- In [NIGHT PORTRAIT], [NIGHT SCENERY], [STARRY SKY] and [FIREWORKS] in Scene Mode, the guideline is gray.

Display in large size

Select [LARGE] in the [DISPLAY SIZE] in [SETUP] menu. (P25)

- In the Recording Mode, Recording Mode icon is displayed in large size.
- In the menu screen, the items you selected will be displayed in large size.

Recording Screen



Menu Screen



Recording Mode: **A**  SCN

Taking Pictures Using the Built-in Flash

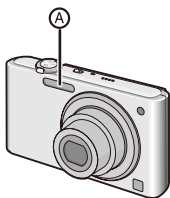

A Photo flash

- Do not cover the photo flash with your fingers or any other items.

Switching to the appropriate flash setting

Set the flash to match the recording.

1 Press **▶** [].

2 Press **▲/▼** to switch the flash setting.

- You can also press **▶** [] to switch the setting.
- For the selectable flash settings, refer to “Available flash settings by Recording Mode”. (P46)

3 Press **[MENU/SET]**.

- You can also press the shutter button halfway to finish.
- When 5 seconds pass without any operation, the setting selected at the time is automatically adopted.

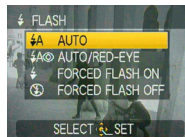

Item	Description of settings
⚡A : AUTO	The flash is automatically activated according to the recording condition.
⚡AⓄ : AUTO/Red-eye reduction *1	<p>The flash is automatically activated according to the recording condition. It is activated once before the actual recording to reduce the red-eye phenomenon (eyes of the subject appearing red in the picture) and then activated again for the actual recording.</p> <ul style="list-style-type: none"> • Use this when you take pictures of people in low lighting conditions.
⚡ : Forced Flash ON ⚡Ⓞ : Forced ON/ Red-eye reduction *1	<p>The flash is activated every time regardless of the recording conditions.</p> <ul style="list-style-type: none"> • Use this when your subject is back-lit or under fluorescent light. • The flash setting is set to [⚡Ⓞ] only when you set [PARTY] or [CANDLE LIGHT] in Scene Mode.
⚡SⓄ : Slow sync./ Red-eye reduction *1	<p>When you take a picture with a dark background landscape, this feature makes the shutter speed slow when the flash is activated, so that the dark background landscape will become bright. Simultaneously it reduces the red-eye phenomenon.</p> <ul style="list-style-type: none"> • Use this when you take pictures of people in front of a dark background. • The flash setting is set to [⚡SⓄ] only when you set [NIGHT PORTRAIT], [PARTY], or [CANDLE LIGHT] in Scene Mode.
☹ : Forced Flash OFF	<p>The flash is not activated in any recording conditions.</p> <ul style="list-style-type: none"> • Use this when you take pictures in places where the use of the flash is not permitted.

*1 The flash is activated twice. The subject should not move until the second flash is activated. Interval until the second flash depends on the brightness of the subject.

■ Available flash settings by Recording Mode

The available flash settings depend on the Recording Mode.

(○ : Available, — : Not available, ⊙ : Scene Mode initial setting)

	⚡A	⚡A⊙	⚡	⚡S⊙	⚡⊙	⊕
	○*2	—	—	—	—	○
	○	○	○	—	—	○
	○	⊙	○	—	—	○
	○	⊙	○	—	—	○
	○	⊙	○	—	—	○
	○	⊙	○	—	—	○
	—	—	—	—	—	⊙
	⊙	—	○	—	—	○
	—	—	—	⊙	—	○
	—	—	—	—	—	⊙
	○	—	○	—	—	⊙
	—	—	—	⊙	○	○
	—	—	—	○	○	○

	⚡A	⚡A⊙	⚡	⚡S⊙	⚡⊙	⊕
	○	⊙	○	—	—	○
	○	⊙	○	—	—	○
	○	—	○	—	—	⊙
	—	—	—	—	—	⊙
	○	—	○	—	—	⊙
	—	—	—	—	—	⊙
	—	—	⊙	—	—	—
	—	—	—	—	—	⊙
	—	—	—	—	—	⊙
	—	—	⊙	—	—	○
	⊙	—	○	—	—	○
	—	—	—	—	—	⊙
	—	—	—	—	—	○

*2 When [⚡A] is selected, [i⚡A], [i⚡A⊙] or [i⚡S⊙] is set depending on the type of subject and brightness.

- The flash setting may change when you change the Recording Mode. Change the flash setting again if necessary.
- The flash settings are memorized even if you switch the camera off. However, the Scene Mode flash settings return to the initial settings when you change the Scene Mode.







■ The available flash range to take pictures

- The available flash range is an approximation.

ISO sensitivity	Available flash range	
	Wide	Tele
i.AUTO	30 cm (0.99 feet) to 6.3 m (20.67 feet)	50 cm (1.64 feet) to 3.0 m (9.84 feet)
ISO80	30 cm (0.99 feet) to 1.7 m (5.85 feet)	50 cm (1.64 feet) to 0.8 m (2.62 feet)
ISO100	30 cm (0.99 feet) to 2.0 m (6.56 feet)	50 cm (1.64 feet) to 0.9 m (2.96 feet)
ISO200	40 cm (1.32 feet) to 2.8 m (9.18 feet)	50 cm (1.64 feet) to 1.3 m (4.26 feet)
ISO400	60 cm (1.97 feet) to 4.0 m (13.1 feet)	60 cm (1.96 feet) to 1.8 m (5.91 feet)
ISO800	80 cm (2.63 feet) to 5.6 m (18.4 feet)	80 cm (2.62 feet) to 2.6 m (8.53 feet)
ISO1600	115 cm (3.78 feet) to 8.0 m (26.25 feet)	90 cm (2.95 feet) to 3.7 m (12.13 feet)

- The available focus range differs depending on the Recording Mode.
- When you use the flash when you have set ISO sensitivity to [i.AUTO], ISO sensitivity automatically becomes a maximum of [ISO1000].
- The edges of the picture may appear dark if you shoot a very close subject with the flash while the zoom lever is close to the W side. Zoom in slightly if this occurs.
- In [HIGH SENS.] in Scene Mode, the ISO sensitivity is automatically adjusted between [ISO1600] and [ISO6400] and the available flash range also differs.
 - Wide: Approx. 1.15 m (3.78 feet) to approx. 16 m (52.5 feet)
 - Tele: Approx. 0.9 m (2.95 feet) to approx. 7.5 m (24.6 feet)
- In [FLASH BURST] in Scene Mode, the ISO sensitivity adjusted between [ISO100] and [ISO3200] and the available flash range also differ.
 - Wide: Approx. 30 cm (0.99 feet) to approx. 4.0 m (13.1 feet)
 - Tele: Approx. 50 cm (1.64 feet) to approx. 1.9 m (6.23 feet)

■ Shutter speed for each flash setting

Flash setting	Shutter speed (Sec.)
 : AUTO	1/30 to 1/2000
 : AUTO/ Red-eye reduction	1/30 to 1/2000
 : Forced ON	1/30 to 1/2000
 : Forced ON/Red-eye reduction	
 : Slow sync./Red-eye reduction	1/8 to 1/2000
 : Forced OFF	1/8 to 1/2000 ^{*1}

^{*1} When [i.AUTO] is set

- In both Auto Scene Mode and Scene Mode, the shutter speed changes depending on the identified scene.

Note

- Do not bring the flash too close to objects or close the flash while it is activated. The objects may be discolored by its heat or lighting.
- When you take a picture beyond the available flash range, the exposure may not be adjusted properly and the picture may become bright or dark.
- The white balance may not be properly adjusted if the photo flash is insufficient.
- When the shutter speed is fast, the flash effect may not be sufficient.
- It may take time to charge the flash if you repeat taking a picture. Take a picture after the access indication disappears.
- The red-eye reduction effect differs between people. Also, if the subject was far away from the camera or was not looking at the first flash, the effect may not be evident.

Recording Mode:  



Taking Close-up Pictures

This mode allows you to take close-up pictures of the subject, e.g. when taking pictures of flowers.

You can take pictures approaching the subject at a distance up to 5 cm (0.17 feet) from the lens by rotating the zoom lever upmost to Wide (1 x).

1

Press  [].

- Macro shooting starts and [] is displayed. To cancel the macro shooting, press  again.

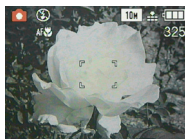

2

Take the pictures.

■ Focus range

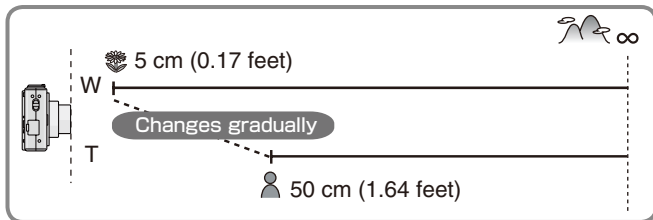

Note

- Use a tripod and the self-timer for best results.
- We recommend setting the flash to Forced Flash OFF [] when you take pictures at close range.
- When the camera lens is at a distance beyond the available range from the subject, the subject may not be focused even if the focus indication lights.
- When the subject is close to the camera, the effective focus range is significantly narrowed. Therefore, you will have difficulty in focusing on the subject if the distance between the camera and the subject is changed after focusing on the subject.
- Macro shooting gives priority to a subject close to the camera. Therefore, if the distance between the camera and the subject is more than 50 cm (1.64 feet) it takes longer to focus on it in macro shooting than normal shooting.
- When you take pictures at close range, the resolution of the periphery of the picture may decrease slightly. This is not a malfunction.

Recording Mode: **A**  SCN

Taking Pictures with the Self-timer

1 Press  [].

2 Press / to select the time.
• You can also press  [] to select.

3 Press [MENU/SET].
• You can also press the shutter button halfway to finish.
• When 5 seconds pass without any operation, the setting selected at the time is automatically adopted.

4 Press the shutter button halfway to focus and then press it fully to take a picture.
• The self-timer indicator  blinks and the shutter goes off after 10 seconds (or 2 seconds).
• If you press [MENU/SET] when the self-timer is being set, the self-timer setting is canceled.

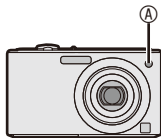

Note

- When using a tripod or in other cases, setting the self-timer to 2 seconds is a convenient way to stabilize the jitter caused by pressing the shutter button.
- When you press the button fully with one stroke, the subject is automatically focused just before the recording. In dark places, the self-timer indicator blinks and then it may turn on brightly to work as the AF assist lamp for focusing on the subject.
- We recommend using a tripod when setting the self-timer.
- The number of pictures which can be taken in [BURST] is fixed to 3.
- The number of pictures which can be taken in [FLASH BURST] in Scene Mode is fixed to 5.
- Self-timer cannot be set to 2 seconds in Auto Scene Mode.
- Self-timer cannot be set to 10 seconds in [SELF PORTRAIT] in Scene Mode.
- Self-timer cannot be used in [HI-SPEED BURST] in Scene Mode.

Recording Mode:  SCN 

Compensating the Exposure

Use this function when you cannot achieve appropriate exposure due to the difference of brightness between the subject and the background.

Underexposed



Properly exposed



Overexposed



Compensate the exposure toward positive.

Compensate the exposure toward negative.

- 1 Press **▲** [] to display [EXPOSURE] and press **◀▶** to compensate the exposure.

- Select [0 EV] to return to the original exposure.



- 2 Press [MENU/SET] to finish.

- You can also press the shutter button halfway to finish.

Note

- EV is an abbreviation of “Exposure Value”, and it is the amount of light given to the CCD according to the aperture value and the shutter speed.
- The exposure compensation value appears on the lower left of the screen.
- The exposure value is memorized even if the camera is turned off.
- The compensation range of the exposure will be limited depending on the brightness of the subject.
- You cannot compensate the exposure in [STARRY SKY] in Scene Mode.

Recording Mode: SCN

Taking Pictures that Match the Scene being Recorded (Scene Mode)

When you select a Scene Mode to match the subject and recording situation, the camera sets the optimal exposure and hue to obtain the desired picture.

1 Slide the recording/playback switch to [].

2 Press [MODE] to display the mode selection screen.

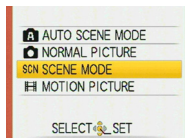

3 Press $\blacktriangle/\blacktriangledown$ to select [SCENE MODE] and then press [MENU/SET].

4 Press $\blacktriangle/\blacktriangledown/\blacktriangleleft/\blacktriangleright$ to select the Scene Mode.

- You can switch menu screens by the page from any menu item by rotating the zoom lever.



5 Press [MENU/SET] to set.

- The menu screen is switched to the recording screen in the selected Scene Mode.
- Depending on the scene mode, the setting screen appears.

■ Scene mode help [INFORMATION]

- To see explanations about the scene modes, press [DISPLAY] while a Scene Mode is selected in step 4. Press again to return to the Scene Mode menu.



Note

- To change the Scene Mode, press [MENU/SET] and \blacktriangleright , and then perform steps 4 and 5 above.
- Refer to P48 for the shutter speed.
- The flash settings return to the initial settings when you change the Scene Mode.
- The color of the picture may seem strange if you use a scene mode that is unsuitable for the shot.
- The following cannot be set in Scene Mode.
 - [SENSITIVITY]/[COLOR MODE]

 [PORTRAIT]

The person stands out with a healthier complexion.

■ Technique for Portrait Mode

To make this mode more effective:

- 1 Rotate the zoom lever to Tele as far as possible.
- 2 Move close to the subject.

Note

- Suitable for outdoors in the daytime.
- The ISO sensitivity is fixed to [ISO80].
- The initial setting for [AF MODE] is [].

 [SOFT SKIN]

The camera detects the face or skin area to achieve a smoother appearance than portrait mode. Use when taking portraits from the chest up.

■ Technique for Soft Skin Mode

To make this mode more effective:

- 1 Rotate the zoom lever to Tele as far as possible.
- 2 Move close to the subject.

Note

- Suitable for daylight shooting.
- Other flesh-colored elements are also softened.
- The effect may not be as obvious if there is not enough light.
- The ISO sensitivity is fixed to [ISO80].
- The initial setting for [AF MODE] is [].

 [SELF PORTRAIT]

For taking pictures of yourself easily.

■ Technique for Self Portrait Mode

- Press the shutter button halfway to focus. The self-timer indicator lights up when you are brought into focus. Making sure you hold the camera still, press the shutter button fully to take the picture.
- The subject is not focused when the self-timer indicator is blinking. Make sure to press the shutter button halfway again to focus.
- The recorded picture automatically appears on the LCD monitor for reviewing.
- If the picture is blurry due to the slow shutter speed, we recommend using the 2 second self-timer.

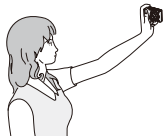

Note

- The focus range is about 30 cm (0.99 feet) to 1.2 m (3.93 feet) (Wide).
- When you select [SELF PORTRAIT], the zoom magnification is automatically moved to Wide.
- The self-timer can only be set to [OFF] or [2SEC.]. If it is set to 2 seconds, this setting will remain until the camera is turned off, the Scene Mode is changed or the camera is switched to the Playback Mode.
- The initial setting for [AF MODE] is [].

 [SCENERY]

The camera focuses on distant subjects to allow you to take pictures of wide landscapes.

 **Note**

- Flash is fixed to Forced flash OFF [].
- The focus range is 5 m (16.41 feet) to ∞ .

 [SPORTS]

Allows you to shoot fast moving subjects (e.g. outdoor sports).



 **Note**

- Suitable for daylight shooting, 5 m (16.41 feet) or more away from the subject.
- [i.AUTO] is activated.

 [NIGHT PORTRAIT]

Shoot the subject with natural brightness using the flash and slow shutter speed.

■ Technique for Night Portrait Mode

- **Use the flash.** (You can set to [ S ].)
- Due to the slow shutter speed, use a tripod and the self-timer for best results.
- Keep the subject still for about 1 second after taking a picture.
- Rotate the zoom lever to Wide (1 \times), about 1.5 m (4.93 feet) from the subject.

 **Note**

- The focus range is 1.2 m (3.94 feet) to 5 m (16.41 feet).
- When shooting in dark places, noise may become visible.
- The initial setting for [AF MODE] is [].

 [NIGHT SCENERY]

The nightscape can be recorded vividly.

■ Technique for Night Scenery Mode

- The shutter speed may slow down up to 8 seconds. We recommend using the tripod and the self-timer for best results.

 **Note**

- Flash is fixed to Forced flash OFF [].
- The focus range is 5 m (16.41 feet) to ∞ .
- The shutter may close (max. about 8 seconds) after shooting due to signal processing. This is not a malfunction.
- When shooting in dark places, noise may become visible.

 [FOOD]

Use to take pictures of food in restaurants, irrespective of the lighting, so that the natural colors of the subject come out.





 **Note**

- The focus range is 5 cm (0.17 feet) (Wide)/50 cm (1.64 feet) (Tele) to ∞ .

 [PARTY]

Use to take pictures at wedding receptions, indoor parties, etc. Both the people and the background can be shot with natural brightness using the flash and slow shutter speed.

■ Technique for Party Mode

- Use the flash. (You can set to [ S ] or [ ].)
- Use a tripod and the self-timer for best results.
- Rotate the zoom lever to Wide (1 ×), about 1.5 m (4.93 feet) from the subject.

Note

- The initial setting for [AF MODE] is [].

 [CANDLE LIGHT]

Use to get the most from the mood created by candlelight.

■ Technique for Candle Light Mode

- Don't use the flash.
- Use a tripod and the self-timer for best results.

Note

- The focus range is 5 cm (0.17 feet) (Wide)/50 cm (1.64 feet) (Tele) to ∞ .
- The initial setting for [AF MODE] is [].

 [BABY1] /  [BABY2]

This takes pictures of a baby with a healthy complexion. When you use the flash, the light from it is weaker than usual. It is possible to set different birthdays and names for [BABY1] and [BABY2]. You can select to have these appear at the time of playback, or have them stamped on the recorded image using [TEXT STAMP] (P87).

■ Birthday ([AGE])/Name setting

1 Press **▲/▼** to select [AGE] or [NAME] and then press **▶**.

2 Press **▲/▼** to select [SET] and then press [MENU/SET].

3 Enter the birthday or name.

Birthday:

◀/▶: Select the items (year/month/day).

▲/▼: Setting.

[MENU/SET]: Exit.

Name: For details on how to enter characters, read the [TITLE EDIT] section on P85.

- When the birthday or name is set, [AGE] or [NAME] is automatically set to [ON].
- If [ON] is selected when the birthday or name has not been registered, the setting screen appears automatically.

4 Press [MENU/SET] to finish.

■ To cancel [AGE] and [NAME]

Select the [OFF] setting in step 2 of the “Birthday ([AGE])/Name setting” procedure.

Note

- The age and name can be printed out using the “PHOTOfunSTUDIO” bundled software on the CD-ROM (supplied).
- If [AGE] or [NAME] is set to [OFF] even when the birthday or name has been set, the age or name will not be displayed. Before taking pictures, set [AGE] or [NAME] to [ON].
- The focus range is 5 cm (0.17 feet) (Wide)/50 cm (1.64 feet) (Tele) to ∞.
- [i.AUTO] is activated.
- If you turn on the camera in [BABY1]/[BABY2], the age and name will be displayed at the lower left of the screen for about 5 seconds, along with the current date and time.
- If the age is not properly displayed, check the clock and birthday settings.
- The birthday setting can be reset with [RESET].
- The initial setting for [AF MODE] is [].



 [PET]

Suitable for taking pictures of your pet. This allows you to set the birthday (age) and name of your pet. For details on how to set age and birthday, see [BABY1]/[BABY2]. (P57)

 **Note**

- [i.AUTO] is activated.
- The initial setting for the AF assist lamp is [OFF].
- The initial setting for [AF MODE] is [□].
- The focus range is 5 cm (0.17 feet) (Wide)/50 cm (1.64 feet) (Tele) to ∞.
- Refer to [BABY1]/[BABY2] for more details.

 [SUNSET]

Use to take pictures of the sunset. Sunset color can be reproduced vividly.

 **Note**

- Flash is fixed to Forced flash OFF [☹].
- The ISO sensitivity is fixed to [ISO80].

 [HIGH SENS.]

This mode minimizes the jitter of the subjects, and enables you to take pictures of these subjects in dimly lit rooms. (Select this for high-sensitivity processing. The sensitivity automatically switches to between [ISO1600] and [ISO6400].)

Picture size

Press ▲/▼ to select the picture size and then press [MENU/SET] to set.

- 3M (4:3), 2.5M (3:2) or 2M (16:9) is selected as the picture size.

 **Note**

- [QUALITY] is automatically fixed to [■■■].
- You can take pictures suitable for 4"×6"/10×15 cm printing.
- The focus range becomes the same as Macro Mode. [5 cm (0.17 feet) (Wide)/50 cm (1.64 feet) (Tele) to ∞]



 [HI-SPEED BURST]

This is a convenient mode for shooting rapid movement or a decisive moment.

Picture size

1 Press $\blacktriangle/\blacktriangledown$ to select the picture size and then press [MENU/SET] to set.

- 3M (4:3), 2.5M (3:2) or 2M (16:9) is selected as the picture size.

2 Take pictures.

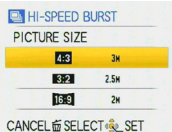

- Still pictures are taken continuously while the shutter button is pressed fully.



Maximum Burst speed	approx. 6 pictures/second
Number of recordable pictures	approx. 10 (built-in memory)/approx. 10 to 100* (card) * The maximum is 100.

- The burst speed changes according to the recording conditions.
- The number of burst recording pictures are limited by the picture-taking conditions and the type and/or status of the card used.
- The number of burst recording pictures increase immediately after formatting.

Note

- Flash is fixed to Forced flash OFF [].
- [QUALITY] is automatically fixed to [].
- You can take pictures suitable for 4"x6"/10x15 cm printing.
- The shutter speed becomes 1/8th of a second to 1/2000th of a second.
- The focus range becomes the same as in Macro Mode. [5 cm (0.17 feet) (Wide)/50 cm (1.64 feet) (Tele) to ∞]
- The focus, zoom, exposure, white balance, shutter speed and ISO sensitivity are fixed to the settings for the first picture.
- The ISO sensitivity automatically switches to between [ISO500] and [ISO800]. However, the ISO sensitivity is increased to make the shutter speed become high-speed.
- The battery will run out faster in High Speed Burst Mode than in Normal Mode.

 [FLASH BURST]

Still pictures are taken continuously with flash. It is convenient to take continuous still pictures in dark places.

Picture size and aspect ratio

1 Press $\blacktriangle/\blacktriangledown$ to select the picture size and aspect ratio and then press [MENU/SET] to set.

- 3M (4:3), 2.5M (3:2) or 2M (16:9) is selected as the picture size.

2 Take pictures.

- Still pictures are taken continuously while the shutter button is pressed fully.



Number of recordable pictures	max. 5 pictures
--------------------------------------	-----------------

Note

- [QUALITY] is automatically fixed to [].
- You can take pictures suitable for 4"x6"/10x15 cm printing.
- The focus range is 5 cm (0.17 feet) (Wide)/50 cm (1.64 feet) (Tele) to ∞ .
- The focus, zoom, exposure, shutter speed, ISO sensitivity, and flash level are fixed to the settings for the first picture.
- The shutter speed becomes 1/30th of a second to 1/2000th of a second.
- [i.AUTO] is activated, and maximum ISO sensitivity level becomes [ISO3200].
- See the Note on P48 when using the flash.

[STARRY SKY]

Take clear pictures of the night sky or other dark subjects.

■ Setting the shutter speed

Choose a shutter speed; 15, 30, or 60 seconds.

1 Press ▲/▼ to select the shutter speed and then press [MENU/SET].

- The shutter speed can also be changed in quick menu (P24).



2 Take a picture.

- The countdown screen appears. Do not move the camera. [PLEASE WAIT...] appears for the number of seconds you chose for shutter speed after the countdown. This is to process the signals.
- To cancel the shot, press [MENU/SET] while the countdown screen is displayed.



■ Technique for Starry Sky Mode

- The shutter opens for 15, 30 or 60 seconds, so use a tripod and the self-timer for best results.

Note

- Flash is fixed to Forced flash OFF [☹].
- The ISO sensitivity is fixed to [ISO80].

[FIREWORKS]

Take beautiful pictures of fireworks exploding in the night sky.

■ Technique for Fireworks Mode

- We recommend using the tripod.

Note

- This is most effective on subjects 10 m (32.81 feet) or more from the camera.
- The shutter speed becomes 1/4th of a second.
- AF area is not displayed.
- The ISO sensitivity is fixed to [ISO80].

 [BEACH]

Prevents underexposure of the subject under strong sunlight to allow you to take pictures on a beach.

 **Note**

- The initial setting for [AF MODE] is [].
- Do not touch the camera with wet hands.
- Sand or seawater may cause the camera to malfunction. Make sure that sand or seawater does not get into the lens or terminals.
- Problems caused by sand or seawater are not covered by the product warranty.

 [SNOW]

Exposure and white balance are adjusted to make the white of the snow stand out.

 [AERIAL PHOTO]

Allows you to take pictures through an airplane window.

■ Technique for Aerial photo mode



Use this technique if it is difficult to focus when taking pictures of clouds etc. Aim the camera at something with high contrast, press the shutter button halfway to fix the focus, then aim the camera at the subject and press the shutter button fully to take the picture.

 **Note**

- Flash is fixed to Forced flash OFF [].
- **Turn the camera off when taking off or landing.**
- **When using the camera, follow all instructions from the cabin crew.**
- The focus range is 5 m (16.41 feet) to ∞ .
- Be careful about the reflection from the window.

Recording Mode: 

Motion Picture Mode

- 1** Slide the recording/playback switch to [].
- 2** Press [MODE] to display the mode selection screen.
- 3** Press / to select [MOTION PICTURE] and then press [MENU/SET].

- 4** Press the shutter button halfway to focus and then press it fully to start recording.

A Audio recording

- The available recording time **B** is displayed on the top right and the elapsed recording time **C** is displayed on the bottom right of the screen.
- After pressing the shutter button fully, release it straight away. If the button is held down, the sound will not be recorded for a few seconds when recording starts.
- When the subject is focused, the focus indication lights.
- The focus and zoom are fixed to those set at the beginning of recording (for the first frame).
- The audio is also recorded through the built-in microphone. (Motion pictures cannot be recorded without audio.)

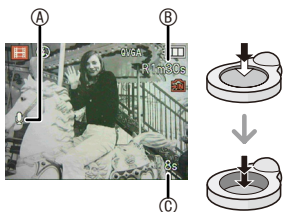

- 5** Press the shutter button fully to stop recording.

- If the built-in memory or the card becomes full in the middle of recording, the camera stops recording automatically.

Changing the settings for the picture quality

When you set the picture quality to [WVGA] or [VGA], we recommend using a high-speed card with “10MB/s” or greater displayed on the package for shooting motion pictures.

1 Press [MENU/SET].

2 Press ▲/▼ to select [REC QUALITY] and then press ►.

3 Press ▲/▼ to select the item and then press [MENU/SET].



Item	Picture size	fps	Aspect ratio
WVGA*	848 × 480 pixels	30 fps	16:9
VGA*	640 × 480 pixels	30 fps	
QVGA	320 × 240 pixels	30 fps	4:3



• fps (frame per second); This refers to the number of frames used in 1 second.

* Cannot be recorded in the built-in memory.

4 Press [MENU/SET] to close the menu.

• You can also press the shutter button halfway to close the menu.

 **Note**

- Refer to P130 for information about the available recording time.
- The remaining recordable time shown on the LCD may not decrease regularly.
- Depending on the type of card you are using, the card access indication may appear for a while after shooting motion pictures. This is normal.
- The volume of motion picture is limited to 2 GB per recording session. The maximum available recording time for up to 2 GB is displayed on the screen. (DMC-F2P/DMC-F2PC/DMC-F2PU)
- Motion pictures can be recorded continuously for up to 15 minutes. Also, continuous recording exceeding 2 GB is not possible.
Remaining time for continuous recording is displayed on the screen. (DMC-F2PR)
- When motion pictures recorded with this camera are played back on other equipment, the quality of pictures may deteriorate or it may not be possible to play them back. Also the recording information may not be displayed correctly.
- This camera has improved sound quality so motion pictures recorded on this camera cannot be played back on a Panasonic Digital Camera (LUMIX models) that was sold in June 2008 or before. (However, motion pictures recorded on previous models can be played back on this camera.)
- In Motion Picture Mode [] the following functions cannot be used.
 - []/[] in [AF MODE]
- In Motion Picture Mode, the angle of view may become narrower than in Normal Picture Mode.
- If the power supply from the outlet is cut off while recording motion pictures using the DC coupler, the pictures being shot will not be recorded. Securing stable power supply or using the battery is recommended.

Recording Mode:   SCN 

Useful Functions at Travel Destinations

Recording which day of the vacation you take the picture

If you set the departure date or the travel destination of the vacation in advance, the number of days that have passed since the departure date (which day of the vacation it is) is recorded when you take the picture. You can display the number of days that have passed when playing back the pictures and stamp it on the recorded pictures with [TEXT STAMP] (P87).

- The number of days that have passed since the departure date can be printed out using the "PHOTOfunSTUDIO" bundled software on the CD-ROM (supplied).
- Select [CLOCK SET] to set the current date and time in advance. (P18)

- 1 Select [TRAVEL DATE] from the [SETUP] menu, and then press . (P25)

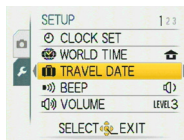



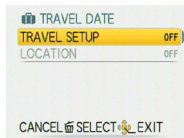

- 2 Press  to select [TRAVEL SETUP] and then press .

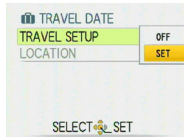

- 3 Press  to select [SET] and then press [MENU/SET].



- 4 Press , , ,  to set the departure date (year/month/day), and then press [MENU/SET].

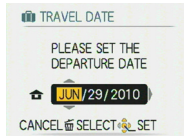

5 Press ▲/▼/◀/▶ to set the return date (year/month/day), and then press [MENU/SET].

- If you do not want to set the return date, press [MENU/SET] while the date bar is displayed.

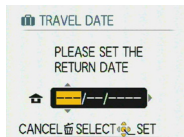

6 Press ▼ to select [LOCATION] and then press ▶.

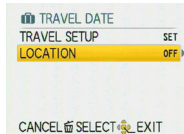

7 Press ▼ to select [SET] and then press [MENU/SET].

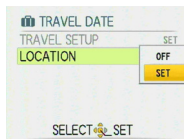

8 Enter the location.

- For details on how to enter characters, read the [TITLE EDIT] section on P85.

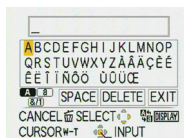

9 Press [MENU/SET] twice to close the menu.

10 Take a picture.

- The number of days that have passed since the departure date is displayed for about 5 seconds if this unit is turned on etc. after setting the travel date or when the travel date is set.
- When the travel date is set, [Camera Icon] appears on the lower right of the screen.

■ Canceling the travel date

The travel date is cleared if the current date is after the return date. If you want to cancel part way through the setting, select [OFF] in step 3 or 7 and press [MENU/SET] twice. If the [TRAVEL SETUP] is set to [OFF] in step 3, [LOCATION] will be also set to [OFF].

Note

- The [TRAVEL DATE] function is available in Auto Scene Mode; however, the setting cannot be changed.
- The travel date is calculated using the date in the clock setting and the departure date you set. If you set [WORLD TIME] to the travel destination, the travel date is calculated using the date in the clock setting and the travel destination setting.
- The travel date setting is memorized even if the camera is turned off.
- If you set a departure date and then take a picture on a date before this departure date, [-] (minus) is displayed in orange and the day of the vacation that you took the picture is not recorded.
- If you set a departure date and then change the clock setting to the date and time at the travel destination, [-] (minus) is displayed in white and the day of the vacation that you took the picture on is recorded when the travel destination date is, for example, one day before the departure date.
- If [TRAVEL DATE] is set to [OFF], the number of days that have passed since the departure date will not be recorded even if you set the travel date. Even if [TRAVEL DATE] is set to [SET] after taking the pictures, the day of the vacation you took them on is not displayed.
- The text set as [LOCATION] can be edited later with [TITLE EDIT].
- The name for [BABY1]/[BABY2] and [PET] will not be recorded when [LOCATION] is set.
- [LOCATION] cannot be recorded when taking motion pictures.

Recording date/time at overseas travel destinations (World time)

You can display the local time at the travel destinations and record them on the pictures you take.

- Select [CLOCK SET] to set the current date and time in advance. (P18)

1 Select [WORLD TIME] from the [SETUP] menu, and then press **▶**. (P25)

- When you are setting the world time for the first time, the [PLEASE SET THE HOME AREA] message appears. Press [MENU/SET], and set the home area on the screen in step 3.

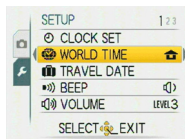

2 Press **▼** to select [HOME], and then press [MENU/SET].

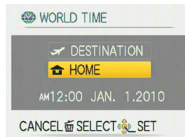

3 Press **◀/▶** to select the home area, and then press [MENU/SET].

- Ⓐ Current time
- Ⓑ Time difference from GMT (Greenwich Mean Time)
- If daylight saving time [☀] is used at the home area, press **▲**. Press **▲** again to return to the original time.
- The daylight saving time setting for the home area does not advance the current time. Advance the clock setting by one hour.

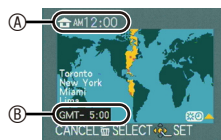

4 Press ▲ to select [DESTINATION] and then press [MENU/SET].

- Ⓒ Depending on the setting, the time at the travel destination area or the home area is displayed.

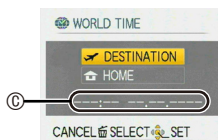

5 Press ◀▶ to select the area the travel destination is in and then press [MENU/SET] to set.

- Ⓓ Current time of the destination area
 Ⓔ Time difference
- If daylight saving time [☀️] is used at the travel destination, press ▲. (The time advances by one hour.) Press ▲ again to return to the original time.

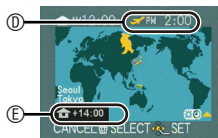

6 Press [MENU/SET] to close the menu.

Note

- Return the setting to [HOME] when the vacation is finished by performing steps 1, 2 and 3.
- If [HOME] is already set, change only the travel destination, and use.
- If you cannot find the travel destination in the areas displayed on the screen, set by the time difference from the home area.
- Now when you play photographs taken while on holiday, the travel icon [✈️] appears.





Using the [REC] Menu

[PICTURE SIZE]

For details on [REC] menu settings, refer to P21.

Set the number of pixels and aspect ratio of the pictures. Select a higher number of pixels for clearer pictures. Select a lower number of pixels to store more pictures.

Applicable modes:   SCN

Settings	Number of pixels
4:3 [10M]	3648 × 2736 pixels
4:3 [5M 	2560 × 1920 pixels
4:3 [3M 	2048 × 1536 pixels
3:2 [9M]	3648 × 2432 pixels
3:2 [2.5M ]*	2048 × 1360 pixels
16:9 [7.5M]*	3648 × 2056 pixels
16:9 [2M 	1920 × 1080 pixels

* Cannot be set in Auto Scene Mode []

: aspect ratio of a 4:3 TV or PC

: aspect ratio of a 35 mm film camera

: aspect ratio of a high-definition TV, etc.

Note

- A digital picture is made of numerous dots called pixels. The higher the numbers of pixels, the finer the picture will be when it is printed on a large piece of paper or displayed on a PC monitor.

Ⓐ Many pixels (Fine)

Ⓑ Few pixels (Rough)

* These pictures are examples to show the effect.

- [EZ] is an abbreviation of “Extended Optical Zoom”.
- The Extended Optical Zoom does not work in [HIGH SENS.], [HI-SPEED BURST] and [FLASH BURST] mode, so the picture size for [EZ] is not displayed.
- Pictures may have a mosaic-like appearance depending on the subject or the recording condition.
- Refer to P127 for the number of recordable pictures.

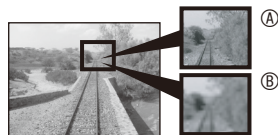

[QUALITY]

For details on [REC] menu settings, refer to P21.

Set the compression rate at which the pictures are to be stored.

Applicable modes:  SCN

: Fine (when giving priority to the picture quality)

: Standard (when giving priority to the number of pictures to be recorded without changing the number of pixels)

Note

- Refer to P127 for information about the number of recordable pictures.

[ISO] [SENSITIVITY]

For details on [REC] menu settings, refer to P21.

ISO sensitivity represents the sensitivity of the image sensor to light. If you set the ISO sensitivity higher, the camera becomes more suitable for recording in dark places.

Applicable modes: 

[i.AUTO]/[80]/[100]/[200]/[400]/[800]/[1600]

ISO sensitivity	80	← →	1600
Recording location (recommended)	When it is light (outdoors)		When it is dark
Shutter speed	Slow		Fast
Noise	Less		More







Note

- When setting to [i.AUTO], the camera detects movement of the subject and then sets the optimal ISO sensitivity and shutter speed according to movement and brightness of the subject. When the Digital zoom is [ON], the motion detection does not function.
- The ISO sensitivity automatically changes between [ISO1600] and [ISO6400] in [HIGH SENS.] mode.
- To avoid picture noise we recommend reducing the ISO sensitivity or setting [COLOR MODE] to [NATURAL]. (P77)

[WB] [WHITE BALANCE]**For details on [REC] menu settings, refer to P21.**

This function allows you to reproduce a white color closer to the tone in real life on the pictures recorded under sunlight, halogen lighting, etc. in which the white color may appear reddish or bluish.

Applicable modes:  SCN 

- [AWB]:** for auto setting (auto white balance)
-  (Daylight): for recording outdoors on a bright day
-  (Cloudy): for recording outdoors on a cloudy day
-  (Shade): for recording in shaded areas outdoors on a bright day
-  (Halogen): for recording under halogen lighting
-  (White set): for using the preset white balance
-  (White set): for using set mode with a different white balance setting

- The optimum white balance under fluorescent lights depends on the type of light, so use [AWB] or [SET].

■ Auto White Balance (AWB)

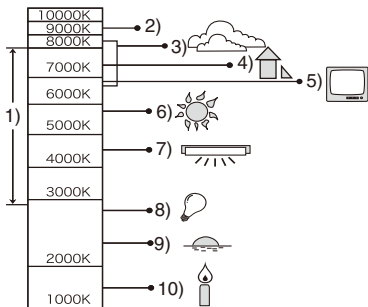

Depending on the conditions prevailing when pictures are taken, the pictures may take on a reddish or bluish tinge. Furthermore, when a multiple number of light sources are being used or there is nothing with a color close to white, Auto White Balance may not function properly. In a case like this, set the white balance to a mode other than [AWB].

- 1 The range that is controlled by the Auto White Balance adjustment mode of this camera
- 2 Blue sky
- 3 Cloudy sky (Rain)
- 4 Shade
- 5 TV screen
- 6 Sunlight
- 7 White fluorescent light
- 8 Incandescent light bulb
- 9 Sunrise and sunset
- 10 Candlelight



K=Kelvin Color Temperature

■ Setting the white balance manually (White set)

- 1 Select [SET] and then press [MENU/SET].
- 2 Aim the camera at a sheet of white paper etc. so that the frame in the center is filled by the white object only and then press [MENU/SET].
- 3 After setting, select [].



Note





- The white balance setting is memorized even if you switch the camera off, but if you change the Scene Mode, the white balance setting returns to [AWB].
- [WHITE BALANCE] is fixed to [AWB] in the following scene modes.
 - [SCENERY], [NIGHT PORTRAIT], [NIGHT SCENERY], [FOOD], [PARTY], [CANDLE LIGHT], [SUNSET], [FLASH BURST], [STARRY SKY], [FIREWORKS], [BEACH], [SNOW] and [AERIAL PHOTO] in [SCENE MODE].

 [AF MODE]

For details on [REC] menu settings, refer to P21.

This allows the focusing method that suits the positions and number of the subjects to be selected.

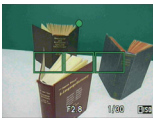
Applicable modes:  SCN

 : Face detection		<p>The camera automatically detects the person's face. The focus and exposure can then be adjusted to fit that face no matter what portion of the picture it is in. (max. 15 areas)</p>
 : 9-area-focusing		<p>The camera focuses on any of 9 focus areas. This is effective when the subject is not in the center of the screen.</p>
 : 1-area-focusing		<p>The camera focuses on the subject in the AF area on the center of the screen.</p>

■ About [] (Face detection)

The following AF area frames are displayed when the camera detects faces:

Yellow:



When the shutter button is pressed halfway, the frame turns green when the camera is focused.

White:

Displayed when more than one face is detected. Other faces that are the same distance away as faces within the yellow AF areas are also focused.

- Under certain picture-taking conditions including the following cases, the facial recognition function may fail to work, making it impossible to detect faces. [AF MODE] is switched to [].
 - When the face is not facing the camera
 - When the face is at an angle
 - When the face is extremely bright or dark
 - When there is little contrast on the faces
 - When the facial features are hidden behind sunglasses, etc.
 - When the face appears small on the screen
 - When there is rapid movement
 - When the subject is other than a human being
 - When the camera is shaking
 - When digital zoom is used



Note





- When multiple AF areas (max. 9 areas) light at the same time, the camera is focusing on all the AF areas. If you want to determine the focus position to take pictures, switch the AF Mode to 1-area-focusing mode.
- In 9-area focusing mode, AF areas are not displayed until the camera focuses on a subject.
- The camera may detect the subjects other than a person as the face. In this case, switch the AF Mode to any modes other than [] and then take a picture.
- The AF Mode cannot be set in [FIREWORKS] in Scene Mode.
- It is not possible to set [] in the following cases:
 - In [NIGHT SCENERY], [FOOD], [STARRY SKY] and [AERIAL PHOTO] in Scene Mode.

 [BURST]

For details on [REC] menu settings, refer to P21.

When you press and hold the shutter button several pictures are taken in succession.





Applicable modes:   SCN

		[OFF]		
Burst speed (pictures/second)		—	2.3*	Approx. 1.7
Number of recordable pictures		—	Max. 3	Depends on the remaining capacity of the built-in memory/card.
		—	Max. 5	

* The burst speed is constant regardless of the transfer speed of the card.

- The burst speed values given above apply when the shutter speed is 1/60 or faster and when the flash is not activated.

 **Note**

- **When the Burst Mode setting is set to []**
 - **The burst speed becomes slower halfway.** The exact timing of this depends on the type of card, the picture size and the quality.
 - You can take pictures until the capacity of the built-in memory or the card is full.
- The focus is fixed when the first picture is taken.
- When the burst speed is set to [], the exposure and white balance are fixed at the settings used for the first picture for the subsequent pictures as well. When the burst speed is set to [], they are adjusted each time you take a picture.
- When the self-timer is used, the number of recordable pictures in Burst Mode is fixed to 3.
- If you are following a moving subject while taking pictures in a place (landscape) indoors, outdoors etc. where there is a large difference between the light and shade, it may take time until the exposure is stable. If burst is used at this time, the exposure may not be optimal.
- The burst speed (pictures/second) may become slower depending on the recording environment such as in dark places, if the ISO sensitivity is high etc.
- Burst Mode is not canceled when the camera is switched off.
- If you take pictures in Burst Mode with the built-in memory, it will take time to write the picture data.
- In Burst Mode, the flash setting is fixed to Forced flash OFF [].
- Burst Mode cannot be used [HI-SPEED BURST], [FLASH BURST] and [STARRY SKY] in [SCENE MODE].

 [DIGITAL ZOOM]

For details on [REC] menu settings, refer to P21.

This can enlarge subjects even more than the optical zoom or extended optical zoom.

Applicable modes:  SCN 

[OFF]/[ON]

 **Note**

- Refer to P35 for details.
- When the Digital zoom is [ON], the motion detection does not function in [i.AUTO] setting.

 [COLOR MODE]

For details on [REC] menu settings, refer to P21.

Using these modes, the pictures can be made sharper or softer, the colors of the pictures can be turned into sepia colors or other color effects can be achieved.

Applicable modes:   

[STANDARD]: This is the standard setting.

[NATURAL]: The picture becomes softer.

[VIVID]: The picture becomes sharper.

[B/W]: The picture becomes black and white.

[SEPIA]: The picture becomes sepia.

[COOL]: The picture becomes bluish.

[WARM]: The picture becomes reddish.

 **Note**

- When you take pictures in dark places, noise may become visible. To avoid noise, we recommend setting to [NATURAL].
- You can set only [STANDARD], [B/W] or [SEPIA] in Auto Scene Mode.
- You cannot set [NATURAL] or [VIVID] in Motion Picture Mode.
- Different color modes can be set in different recording modes.

AF* [AF ASSIST LAMP]

For details on [REC] menu settings, refer to P21.

Illuminating the subject with the AF assist lamp allows the camera to focus on the subject in low light conditions.

Applicable modes:  SCN

[OFF]: The AF assist lamp does not turn on.

[ON]: When taking pictures in dark places, the AF assist lamp lights while the shutter button is pressed halfway. (Larger AF areas are now displayed.)

 **Note**

- The effective range of the AF assist lamp is 1.5 m (4.93 feet).
- When you do not want to use the AF assist lamp  (e.g. when you take a picture of animals in a dark place), set the [AF ASSIST LAMP] to [OFF]. In this case, it becomes difficult to focus on the subject.
- The AF assist lamp is fixed to [OFF] in [SELF PORTRAIT], [SCENERY], [NIGHT SCENERY], [SUNSET], [FIREWORKS] and [AERIAL PHOTO] in [SCENE MODE].



 [CLOCK SET]

For details on [REC] menu settings, refer to P21.

To set the year, month, day and time.

It functions in exactly the same way as [CLOCK SET] in the [SETUP] menu.

Playback Mode: 

Playing Back Pictures in Sequence (Slide Show)

You can play back the pictures you have taken in synchronization with music, and you can do this in sequence while leaving a fixed interval between each of the pictures.

Furthermore, you can play back only those pictures you have set as favorites as a slide show.

This playback method is recommended when you have connected the camera to a TV set to view the pictures you have taken.

1 Slide the recording/playback switch to [] and then press [MODE].

2 Press $\blacktriangle/\blacktriangledown$ to select [SLIDE SHOW] and then press [MENU/SET].

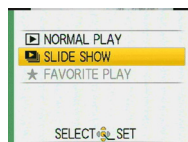

3 Press $\blacktriangle/\blacktriangledown$ to select an item and then press [MENU/SET].

[ALL]: All pictures

[FAVORITE]: Pictures set as FAVORITE (P91). (Set [FAVORITE] to [ON] and set any pictures as favorites.)

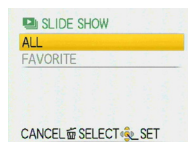

4 Press \blacktriangle to select [START] and press [MENU/SET].

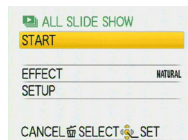

5 Press \blacktriangledown to finish the slide show.

- Normal playback resumes after the slide show finishes.

■ Operations performed during slide show

The cursor displayed during playback corresponds to ▲/▼/◀/▶.

- The menu screen is restored when [] is pressed.

- Ⓐ Play/Pause
- Ⓑ Stop
- Ⓒ Back to previous picture*
- Ⓓ Ahead to next picture*

* These operations can be performed only in the Pause Mode.

- Ⓔ Reduce volume level
- Ⓕ Increase volume level

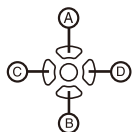

■ Changing the slide show settings

You can change the settings for slide show playback by selecting [EFFECT] or [SETUP] on the slide show menu screen.

[EFFECT]

This allows you to select the screen effects or music effects when switching from one picture to the next picture.

[NATURAL], [SLOW], [SWING], [URBAN], [OFF]

- When [URBAN] has been selected, the picture may appear in black and white as a screen effect.

[SETUP]

[DURATION] or [REPEAT] can be set.

Item	Settings
[DURATION]	[1SEC.]/[2SEC.]/[3SEC.]/[5SEC.]
[REPEAT]	[OFF]/[ON]
[MUSIC]	[OFF]/[ON]

- [DURATION] can be set only when [OFF] has been selected as the [EFFECT] setting.
- [MUSIC] cannot be set when the [EFFECT] is set to [OFF].

Note

- It is not possible to add new music effects.
- Motion pictures cannot be played back as a slide show.

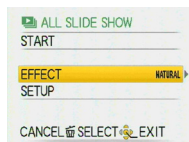

Playback Mode: ★

Selecting Pictures and Playing Them Back

★ [FAVORITE PLAY]

You can play back the pictures put in the favorites list only. (When [FAVORITE] is set to [ON] and there is more than one picture in the favorites list.)

Refer to [FAVORITE] (P91) to put a picture on your favorites list or to remove it from the list.

1 Slide the recording/playback switch to [] and then press [MODE].

2 Press ▲/▼ to select [FAVORITE PLAY] and then press [MENU/SET].

Note

- You can use only [ROTATE], [PRINT SET] or [PROTECT] in the [PLAYBACK] menu.



Playback Mode: ▶ ★

Playing Back Motion Pictures

Press ◀▶ to select a picture with a motion picture icon (such as [OVGA]), and then press ▲ to play back.

- Ⓐ The motion picture recording time
- Ⓑ Motion picture icon
- Ⓒ Motion picture playback icon

- After playback starts, the elapsed playback time is displayed on the upper right of the screen.
For example, 8 minutes and 30 seconds is displayed as [8m30s].

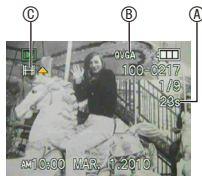

■ Operations performed during motion picture playback

The cursor displayed during playback corresponds to ▲▼◀▶.

- Ⓐ Play/Pause
- Ⓑ Stop
- Ⓒ Fast rewind, Frame-by-frame rewind*
- Ⓓ Fast forward, Frame-by-frame forward*

* These operations can be performed only in Pause Mode.

- Ⓔ Reduce volume level
- Ⓕ Increase volume level

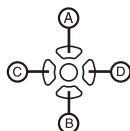

📌 Note

- Sound can be heard through the speaker. Refer to [VOLUME] (P25) for information about how to adjust the volume in the [SETUP] menu.
- The file format that can be played back with this camera is QuickTime Motion JPEG.
- Please note that the bundled software includes QuickTime to play back motion picture files created with the camera on the PC (P96).
- Some QuickTime Motion JPEG files recorded by a PC or other equipment may not be played back with this camera.
- When playing back motion pictures that have been recorded with other equipment, the quality of pictures may deteriorate or it may not be possible to play them back.
- When using a high capacity card, it is possible that fast rewinding may be slower than usual.

Playback Mode: ▶

Using the [PLAYBACK] Menu

You can use various functions in Playback Mode to rotate pictures, set protection for them etc.

- With [TEXT STAMP] or [RESIZE], a new edited picture is created. A new picture cannot be created if there is no free space on the built-in memory or the card so we recommend checking that there is free space and then editing the picture.

[CALENDAR]

You can display pictures by recording date.

1 Select [CALENDAR] on the [PLAYBACK] menu. (P21)

- You can also rotate the zoom lever several times towards  (W) to display the calendar screen. (P38)

2 Press ▲/▼/◀/▶ to select the date to be played back.

▲/▼: Select the month

◀/▶: Select the date

- If there were no pictures recorded during a month, the month is not displayed.



3 Press [MENU/SET] to display the pictures that were recorded on the selected date.

- To return to the calendar screen, press .

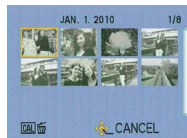

4 Press ▲/▼/◀/▶ to select a picture and then press [MENU/SET].

- The picture that was selected will appear.

Note

- The recording date of the picture selected in the playback screen becomes the date selected when the calendar screen is first displayed.
- If there are multiple pictures with the same recording date, the first picture recorded on that day is displayed.
- You can display the calendar between January 2000 and December 2099.
- If the date is not set in the camera, the recording date is set as January 1st, 2009.
- If you take pictures after setting the travel destination in [WORLD TIME], the pictures are displayed by the dates at the travel destination in calendar playback.

 [TITLE EDIT]

You can add text (comments) to pictures. After text has been registered, it can be included in prints using [TEXT STAMP] (P87). (Only alphabetical characters and symbols can be entered.)

1 Select [TITLE EDIT] on the [PLAYBACK] menu. (P21)

2 Press ▲/▼ to select [SINGLE] or [MULTI] and then press [MENU/SET].

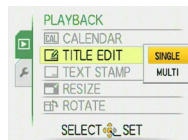

3 Select the picture, and then press [MENU/SET] to set.

- [] is displayed for pictures that have already been recorded with text in [BABY1]/[BABY2] or [PET] name settings in Scene Mode, [TRAVEL DATE] location setting or [TITLE EDIT].

[SINGLE]



Press ◀▶ to select the picture.

[MULTI]



Press ▲/▼/◀▶ to select the pictures.

For [MULTI] setting

Press [DISPLAY] to set (repeat), and then press [MENU/SET].

- The setting is canceled when [DISPLAY] is pressed again.

4 Press ▲/▼/◀▶ to select text and press [MENU/SET] to register.

- Press [DISPLAY] to switch text between [A] (capitals), [a] (small case) and [&/1] (special characters and numbers).
- The cursor at the entry position can be moved to the left with [←], and to the right with [→].
- To enter a blank, move the cursor to [SPACE] and press [MENU/SET]. To delete an entered character, move the cursor to [DELETE], and press [MENU/SET].
- To stop editing during text entry, press [EXIT].
- A maximum of 30 characters can be entered.

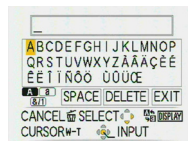

5 Press ▲/▼/◀▶ to move the cursor to [EXIT] and then press [MENU/SET] to finish text input.

6 Press [] to return to the menu screen*.

* The menu screen is automatically restored when [MULTI] is selected.

- Press [MENU/SET] to close the menu.

■ Delete the title**[SINGLE] setting**

- 1 In step 4, delete all the texts, select [EXIT], and press [MENU/SET].
- 2 Press [].
- 3 Press [MENU/SET] to close the menu.

[MULTI] setting

- 1 In step 4, delete all the texts, select [EXIT], and press [MENU/SET].
- 2 Press [MENU/SET] to close the menu.

 **Note**

- Text can be scrolled if all of the registered text does not fit on the screen.
- The name setting of [BABY1]/[BABY2] or [PET] in Scene Mode or [TRAVEL DATE] location setting can also be registered by using the operation in steps 4 and following.
- The name setting of [BABY1]/[BABY2] or [PET] in Scene Mode, [TRAVEL DATE] location setting and [TITLE EDIT] cannot be registered at the same time.
- You can print out texts (comments) using the “PHOTOfunSTUDIO” bundled software on the CD-ROM (supplied).
- You can set up to 50 pictures at one time with [MULTI].
- You cannot use [TITLE EDIT] for motion pictures, pictures protected and pictures taken with other equipment.

☐ [TEXT STAMP]

You can stamp the recording date/time, age, travel date or title onto the recorded pictures. It is suitable for regular size printing. (Pictures larger than 3M will be resized when stamping the date etc. on them.)

1 Select [TEXT STAMP] on the [PLAYBACK] menu. (P21)

2 Press ▲/▼ to select [SINGLE] or [MULTI] and press [MENU/SET].



3 Select the picture, and then press [MENU/SET] to set.

- [☑] ⓐ appears on the screen if the picture has added the text stamp.

For [MULTI] setting

Press [DISPLAY] to set (repeat), and then press [MENU/SET].

- The setting is canceled when [DISPLAY] is pressed again.



Press ◀▶ to select the picture.

Press ▲▼/◀▶ to select the pictures.

4 Press ▲/▼/◀▶ to select [SHOOTING DATE], [AGE], [TRAVEL DATE] or [TITLE], and then press [MENU/SET] to set each item.

[SHOOTING DATE]

[W/O TIME]: Stamp the year, month and date.

[WITH TIME]: Stamp the year, month, day, hour and minutes.

[AGE] (P57)

If this is set to [ON], [AGE] is stamped on the pictures.

[TRAVEL DATE]

If this is set to [ON], [TRAVEL DATE] is stamped on the pictures.

[TITLE]

Text is printed together with the image for pictures that have already been recorded with text in [BABY1]/[BABY2] or [PET] name settings in Scene Mode, [TRAVEL DATE] location setting or [TITLE EDIT].

5 Press [MENU/SET].

- If you set [TEXT STAMP] for a picture larger than 3M, the picture size will become smaller as shown below

10M / 5M → 3M

9M → 25M

75M → 2M

- The picture becomes slightly rougher.

(Example)

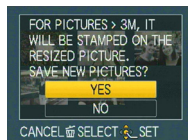

6 Press ▲ to select [YES] and press [MENU/SET].

- The message [SAVE NEW PICTURES?] appears if the picture was recorded with a picture size of 3M or less.

7 Press [] to return to the menu screen*.

- * The menu screen is automatically restored when [MULTI] is selected.
- Press [MENU/SET] to close the menu.

Note

- Note that if you use text stamp and then specify printing the date when you order prints or on a printer, both dates will be printed and may overlap.
- You can set up to 50 pictures at one time in [MULTI].
- The text may be cut off with some printers. Check before printing.
- The printed texts may be blurred on the pictures with the resolution of 0.3M.
- Date or text stamps cannot be used in the following cases:
 - Motion pictures/Pictures recorded without setting the clock or title/Pictures stamped with [TEXT STAMP]/Pictures taken with other equipment

[RESIZE] Reducing the picture size (number of pixels)

This function is useful if you want to reduce the file size of the picture in cases when it needs to be attached to an e-mail or uploaded to a website.

1 Select [RESIZE] on the [PLAYBACK] menu. (P21)

2 Press $\blacktriangle/\blacktriangledown$ to select [SINGLE] or [MULTI] and then press [MENU/SET].

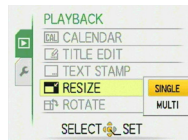

3 Select the picture(s) and size(s).

[SINGLE] setting

- Press $\blacktriangle/\blacktriangledown$ to select the picture, and then press [MENU/SET].
- Press $\blacktriangle/\blacktriangledown$ to select the size*, and then press [MENU/SET].

* Only the sizes to which the pictures can be resized are displayed.

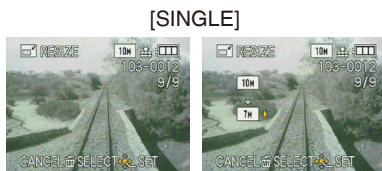

[MULTI] setting

- Press $\blacktriangle/\blacktriangledown$ to select the size, and then press [MENU/SET].

- When [DISPLAY] is pressed, an explanation of resizing is displayed.

- Press $\blacktriangle/\blacktriangledown/\blacktriangleleft/\blacktriangleright$ to select the picture, and then press [DISPLAY].

- Repeat this step for each picture, and press [MENU/SET] to set.

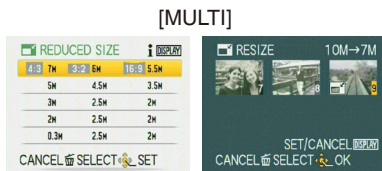

4 Press \blacktriangle to select [YES] and then press [MENU/SET].

5 Press $\left[\text{EXIT} \right]$ to return to the menu screen*.

* The menu screen is automatically restored when [MULTI] is selected.

- Press [MENU/SET] to close the menu.

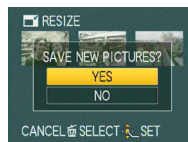

Note

- You can set up to 50 pictures at one time in [MULTI].
- You may not be able to resize pictures you have taken using other equipment.
- The picture becomes slightly rougher.
- Motion pictures or pictures stamped with [TEXT STAMP] cannot be resized.

[ROTATE]

This mode allows you to rotate pictures manually in 90° increments.

1 Select [ROTATE] on the [PLAYBACK] menu. (P21)

2 Press ◀▶ to select the picture and then press [MENU/SET].

- Motion pictures and protected pictures cannot be rotated.

3 Press ▲▼ to select the direction to rotate the picture and then press [MENU/SET].

➡	The picture rotates clockwise in increments of 90°.
⬅	The picture rotates counter-clockwise in increments of 90°.

4 Press [⏪] to return to the menu screen.

- Press [MENU/SET] to close the menu.

Note

- When you play the picture on a PC, you cannot play rotated pictures without an OS or a software compatible with Exif. Exif is the file format for still pictures, to which recording information and other data can be added, established by JEITA [Japan Electronics and Information Technology Industries Association].
- You may not be able to rotate pictures shot on other equipment.

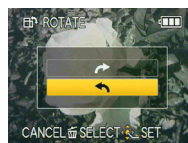
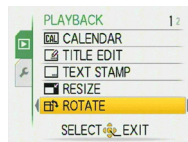

★ [FAVORITE]

You can do the following if a mark [★] has been added to pictures and they have been set as favorites.

- Play back the pictures set as favorite. ([FAVORITE PLAY])
- Play back only the pictures set as favorites as a slide show.
- Delete all the pictures not set as favorites. ([ALL DELETE EXCEPT ★])
- Print only the pictures set as favorites.

1 Select [FAVORITE] on the [PLAYBACK] menu. (P21)

2 Press ▼ to select [ON] and then press [MENU/SET].

- You cannot set pictures as favorites if [FAVORITE] is set to [OFF]. Also the favorites icon [★] will not appear when [FAVORITE] is set to [OFF] even if it was previously set to [ON].

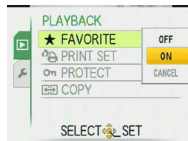

3 Press [MENU/SET] to close the menu.

4 Press ◀▶ to select a picture which you want to put on your favorites list, and then press ▼.

- Repeat the above procedure if necessary.
- [★] is added on the picture put in your favorites list.
- If you want to remove a picture from the favorites list, press ▼ again.



■ Canceling all favorites

1 Select [CANCEL] on the screen shown in step 2 and then press [MENU/SET].

2 Press ▲ to select [YES] and then press [MENU/SET].

3 Press [MENU/SET] to close the menu.

- You cannot select [CANCEL] if no picture is on your favorites list.

🔑 Note

- You can place up to 999 pictures in your favorites list.
- When printing pictures at a photo printing store, [ALL DELETE EXCEPT ★] (P41) is useful so only the pictures you want to be printed remain on the card.
- You may not be able to set pictures shot on other equipment as favorites.

 [PRINT SET]

Writes print information to media and then use the information on a DPOF compliant system. DPOF (Digital Print Order Format) is a system that allows the user to select which pictures to print, how many copies of each picture to print and whether or not to print the recording date on the pictures when using a DPOF compatible photo printer or photo printing store. For details, ask at your photo printing store.

When you want to use a photo printing store to print pictures recorded on the built-in memory, copy them to a card (P95) and then set the print setting.

For more information please visit:

http://panasonic.jp/dc/dpof_110/white_e.htm

1 Select [PRINT SET] on the [PLAYBACK] menu. (P21)

2 Press ▲/▼ to select [SINGLE] or [MULTI] and then press [MENU/SET].

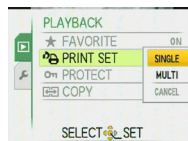

3 Select the picture, and then press [MENU/SET].

[SINGLE]

[MULTI]

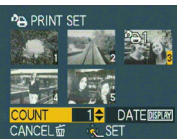

Press ◀▶ to select the picture.

Press ▲/▼/◀▶ to select the pictures.

4 Press ▲/▼ to set the number of prints, and then press [MENU/SET] to set.

- When [MULTI] has been selected, repeat steps 3 and 4 for each picture. (It is not possible to use the same setting for a multiple number of pictures.)

5 Press [] to return to the menu screen.

- Press [MENU/SET] to close the menu.

■ Canceling all the [PRINT SET] settings

1 Select [CANCEL] on the screen shown in step 2 and then press [MENU/SET].

2 Press ▲ to select [YES] and then press [MENU/SET].

3 Press [MENU/SET] to close the menu.

- You cannot select [CANCEL] if no picture has been set for printing.

■ To print the date

After setting the number of prints, set/cancel printing with the recording date by pressing [DISPLAY].

- When you go to a photo printing store for digital printing, be sure to order the printing of the date additionally if required.
- Depending on the photo printing store or the printer, the date may not be printed even if you set to print the date. For further information, ask at your photo printing store or refer to the operating instructions for the printer.
- This function is canceled if you imprint the text stamp on the picture.
- The date cannot be printed on pictures stamped with text.

**Note**

- The number of prints can be set from 0 to 999.
- With a printer supporting PictBridge, the date print settings of the printer may take precedence so check if this is the case.
- It may not be possible to use the print settings with other equipment. In this case, cancel all the settings, and reset the settings.
- If the file is not based on the DCF standard, the print setting cannot be set.

ON [PROTECT]

You can set protection for the pictures you do not want to delete to prevent them from accidental erasure.

1 Select [PROTECT] on the [PLAYBACK] menu. (P21)

2 Press ▲/▼ to select [SINGLE] or [MULTI] and then press [MENU/SET].

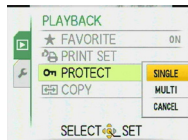

3 Select the picture, and then press [MENU/SET] to set.

When [MULTI] has been selected

- Repeat these steps for each picture.
- The settings are canceled when [MENU/SET] is pressed again.

[SINGLE]



Press ◀▶ to select the picture.

[MULTI]



Press ▲/▼/◀▶ to select the pictures.

4 Press [EXIT] to return to the menu screen.

- Press [MENU/SET] to close the menu.

■ Canceling all the [PROTECT] settings

1 Select [CANCEL] on the screen shown in step 2 and then press [MENU/SET].

2 Press ▲ to select [YES] and then press [MENU/SET].

3 Press [MENU/SET] to close the menu.

- If you press [MENU/SET] while canceling protection, the canceling will stop halfway.

📌 Note

- The protect setting may not be effective in other equipment.
- Even if you protect pictures in the built-in memory or a card, they will be deleted if the built-in memory or the card is formatted.
- Even if you do not protect pictures on an SD Memory Card or an SDHC Memory Card, they cannot be deleted when the card's Write-Protect switch is set to [LOCK].

 [COPY]

You can copy recorded picture data from the built-in memory to a card or vice versa.

1 Select [COPY] on the [PLAYBACK] menu. (P21)

2 Press ▲/▼ to select the copy destination and then press [MENU/SET].

: All the picture data in the built-in memory are copied onto the card at one time. → step 4.

: One picture at a time is copied from the card to the built-in memory. → step 3.

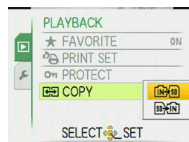

3 Press ◀▶ to select the picture and then press [MENU/SET].

4 Press ▲ to select [YES] and then press [MENU/SET].



- If you press [MENU/SET] while copying pictures from the built-in memory to the card, the copying will stop halfway.
- Do not turn the camera off before copying is finished.



5 Press [] to return the menu screen.

- Press [MENU/SET] to close the menu.
- If you copy from the built-in memory to a card, all the pictures are copied and then the screen automatically returns to the playback screen.

 **Note**

- If you copy picture data from the built-in memory to a card which does not have sufficient free space, the picture data will only be copied halfway. We recommend using a card which has more free space than the built-in memory (about 50 MB).
- In case of "", you can copy an image file even if there is already a file in the destination that has the same name (same file and folder numbers) by making a new folder. In case of "", if a picture exists with the same name as the picture to be copied in the built-in memory, it is not copied. (P98)
- It may take time to copy the picture data.
- Only pictures recorded with a Panasonic digital camera (LUMIX) will be copied. (Even if the pictures were recorded with a Panasonic digital camera, you may not be able to copy them if they were edited on a PC.)
- [PRINT SET] on the original picture data will not be copied. Set the [PRINT SET] again after copying is finished.

Connecting to a PC

You can acquire recorded pictures to a PC by connecting the camera and the PC.

- You can easily print out or mail the pictures you have imported. Use of the “PHOTOfunSTUDIO” bundled software on the CD-ROM (supplied) is a convenient way of doing this.
- Read the separate operating instructions for the supplied software for more information about the software in the CD-ROM (supplied) and how to install it.

Preparations:

Turn on the camera and the PC.

Remove the card before using the pictures in the built-in memory.

1 Connect the camera to a PC via the USB connection cable [Ⓐ] (supplied).

- Do not use any other USB connection cables except the supplied one.

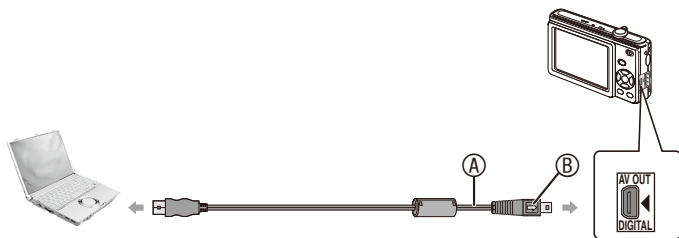

[Ⓐ] USB connection cable (supplied)

- Check the directions of the connectors, and plug them straight in or unplug them straight out. (Otherwise the connectors may be bent out of shape which will cause trouble.)

[Ⓑ] Align the marks, and insert.

- Use a battery with sufficient battery power or the AC adaptor (optional) and DC coupler (optional). If the remaining battery power becomes low while the camera and the PC are communicating, the alarm beeps.

Refer to “Disconnecting the USB connection cable safely” (P98) before disconnecting the USB connection cable. Otherwise, data may be destroyed.

2 Press ▲/▼ to select [PC], and then press [MENU/SET].

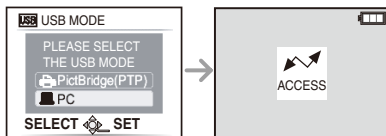

3 Double-click on [Removable Disk] in [My Computer].

- When using a Macintosh, the drive is displayed on the desktop. (“LUMIX”, “NO_NAME” or “Untitled” is displayed.)

4 Double-click [DCIM] folder.

5 Using a drag-and-drop operation, move the pictures you want to acquire or the folder storing those pictures to any different folder on the PC.

■ Disconnecting the USB connection cable safely

- Proceed with the hardware removal using “Safely Remove Hardware” on the task tray of the PC. If the icon is not displayed, check that [ACCESS] is not displayed on the LCD monitor of the digital camera before removing the hardware.

Note

- We recommend placing a soft cloth under this unit to prevent scratching.
- Turn the camera off before connecting or disconnecting the AC adaptor (optional).
- Before inserting or removing a card, turn the camera off and disconnect the USB connection cable. Otherwise, data may be destroyed.
- With the Mac OS X v10.2 or an earlier operating system, set the Write-Protect switch of the SDHC memory card to the [LOCK] position when importing pictures from an SDHC memory card.

■ Viewing the contents of the built-in memory or card (folder composition)

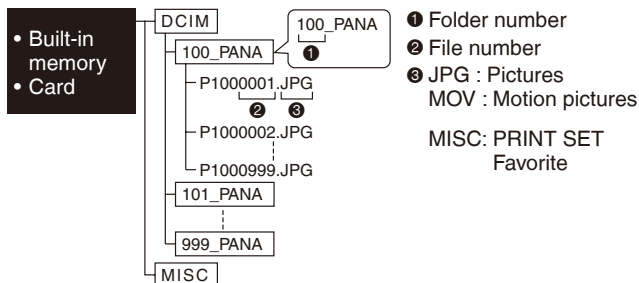

A new folder is created when pictures are taken in the following situations.

- When a card containing a folder with the same folder number has been inserted (Such as when pictures were taken using another make of camera)
- When there is a picture with file number 999 inside the folder

■ Connection in the PTP mode (Windows® XP, Windows Vista®, Windows® 7 and Mac OS X only)

Select [PictBridge (PTP)] when connecting USB cable.

Data can now be read only from the card into the PC.

- When there are 1000 or more pictures on a card, the pictures may not be imported in the PTP mode.

Using a PC with an SD Memory Card slot or a card reader

Attach the SD card according to the operating instructions of computer or card reader and perform steps 3-5 on page 97.

- You cannot use SDHC cards if the computer or card reader does not support SDHC cards.

Printing the Pictures

By connecting the camera directly to a printer supporting PictBridge via the USB connection cable (supplied), you can select the pictures to be printed or start printing on the LCD monitor.

Preparations:

Turn on the camera and the printer.

Remove the card before printing the pictures in the built-in memory.

Perform the print quality and other settings at the printer before printing the pictures.



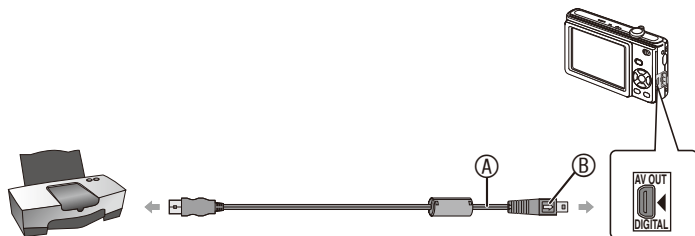

1 Connect the camera to a printer via the USB connection cable [Ⓐ] (supplied).

- Do not use any other USB connection cables except the supplied one.



[Ⓐ] USB connection cable (supplied)

- Check the directions of the connectors, and plug them straight in or unplug them straight out. (Otherwise the connectors may be bent out of shape which will cause trouble.)
- [Ⓑ] Align the marks, and insert.
- Use a battery with sufficient battery power or the AC adaptor (optional) and DC coupler (optional). If the remaining battery power becomes low while the camera and the printer are connected, the alarm beeps. If this happens when printing, stop printing at once. If not printing, disconnect the USB connection cable.
- When the camera is connected to the printer, the cable disconnect prohibit icon [] appears. Do not disconnect the USB connection cable while [] is displayed.

2

Press ▲/▼ to select [PictBridge(PTP)], and then press [MENU/SET].

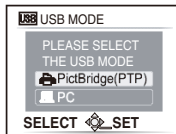

Note

- We recommend placing a soft cloth under this unit to prevent scratching.
- Turn the camera off before connecting or disconnecting the AC adaptor (optional).
- Before inserting or removing a card, turn the camera off, and disconnect the USB connection cable.
- You cannot switch between the built-in memory and the card while the camera is connected to the printer. Disconnect the USB connection cable, insert (or remove) the card and then connect the USB connection cable to the printer again.

Selecting a single picture and printing it

1

Press ◀/▶ to select the picture and then press [MENU/SET].

- A message displays for about 2 seconds.

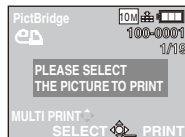

2

Press ▲ to select [PRINT START] and then press [MENU/SET].

- Refer to P102 for the items which can be set before starting to print the pictures.
- Press [MENU/SET] to cancel printing halfway.
- Disconnect the USB connection cable after printing.

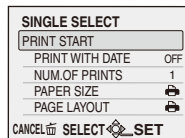

Selecting multiple pictures and printing them

1 Press ▲.

2 Press ▲/▼ to select an item and then press [MENU/SET].

- If the print check screen has appeared, select [YES], and print the pictures.

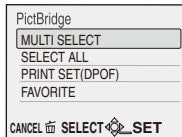

Item	Description of settings
[MULTI SELECT]	<p>Multiple pictures are selected at once for printing.</p> <ul style="list-style-type: none"> • Press ▲/▼/◀▶ to select pictures. When you press [DISPLAY], [] is displayed with the picture you selected for printing. (When you press [DISPLAY] once more, the print setting is canceled.) • Press [MENU/SET] when you finish selection.
[SELECT ALL]	Prints all stored pictures.
[PRINT SET (DPOF)]	Prints the pictures set in [PRINT SET] only. (P92)
[FAVORITE]*	Prints the pictures set as favorites only. (P91)

* Only when [FAVORITE] is at [ON] and when there are pictures set as favorites. (P91)

3 Press ▲ to select [PRINT START] and then press [MENU/SET].

- Refer to P102 for the items which can be set before starting to print the pictures.
- Press [MENU/SET] to cancel printing halfway.
- Disconnect the USB connection cable after printing.

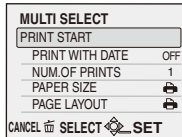

Print Settings

Select and set the items on the screen in step 2 of the “Selecting a single picture and printing it” or in step 3 of the “Selecting multiple pictures and printing them”.

- When you want to print pictures in a paper size or a layout which is not supported by the camera, set [PAPER SIZE] and [PAGE LAYOUT] to [] and then set the paper size or the layout on the printer. (For details, refer to the operating instructions of the printer.)
- When [PRINT SET (DPOF)] has been selected, the [PRINT WITH DATE] and [NUM. OF PRINTS] items are not displayed.

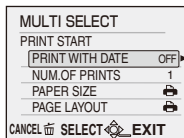

[PRINT WITH DATE]

Item	Description of settings
[OFF]	Date is not printed.
[ON]	Date is printed.

- If the printer does not support date printing, the date cannot be printed on the picture.
- Since the printer's settings may take precedence over the print with date setting, check the printer's print with date setting as well.
- When you print pictures stamped with text, set [PRINT WITH DATE] to [OFF] since the date will be printed over the stamped text if you specify printing of the date.

Note

When asking the photo shop to print the pictures

- By stamping the date using [TEXT STAMP] (P87) or setting date printing at the time of the [PRINT SET] (P92) before going to a photo shop, the dates can be printed at the photo shop.

[NUM. OF PRINTS]





You can set the number of prints up to 999.

[PAPER SIZE]

Item	Description of settings	Item	Description of settings
[]	Settings on the printer are prioritized.	[A3]	297 mm × 420 mm
[L/3.5" × 5"]	89 mm × 127 mm	[10 × 15 cm]	100 mm × 150 mm
[2L/5" × 7"]	127 mm × 178 mm	[4" × 6"]	101.6 mm × 152.4 mm
[POSTCARD]	100 mm × 148 mm	[8" × 10"]	203.2 mm × 254 mm
[16:9]	101.6 mm × 180.6 mm	[LETTER]	216 mm × 279.4 mm
[A4]	210 mm × 297 mm	[CARD SIZE]	54 mm × 85.6 mm

- Paper sizes not supported by the printer will not be displayed.

[PAGE LAYOUT] (Layouts for printing that can be set with this unit)

Item	Description of settings
	Settings on the printer are prioritized.
	1 page with no frame print
	1 page with frame print
	2 pages print on 1 page
	4 pages print on 1 page

- An item cannot be selected if the printer does not support the page layout.

■ Layout printing**When printing a picture several times on 1 sheet of paper**

For example, if you want to print the same picture 4 times on 1 sheet of paper, set [PAGE LAYOUT] to  and then set [NUM. OF PRINTS] to 4 for the picture that you want to print.

When printing different pictures on 1 sheet of paper

For example, if you want to print 4 different pictures on 1 sheet of paper, set [PAGE LAYOUT] to  and then set [NUM. OF PRINTS] to 1 for each of the 4 pictures.

Note

- The camera is receiving an error message from the printer when the  indication lights orange during printing. After finishing printing, make sure there are no problems with the printer.
- If the number of prints is high, the pictures may be printed several times. In this case, the remaining number of prints indicated may differ from the number set.

Using a printer with an SD Memory Card slot

Attach the SD card according to the operating instructions of printer.

- You cannot use SDHC cards if the printer does not support SDHC cards.

Playback Mode: 

Playing Back Pictures on a TV Screen

Playing back pictures using the AV cable

Preparations:

Set the [TV ASPECT]. (P27)

Turn this unit and the TV off.

- Do not use any other AV cables except the supplied one. (Only for DMC-F2PU/DMC-F2PR).
- Do not use any other cables except a genuine Panasonic AV cable (DMW-AVC1: optional). (Only for DMC-F2P/DMC-F2PC)

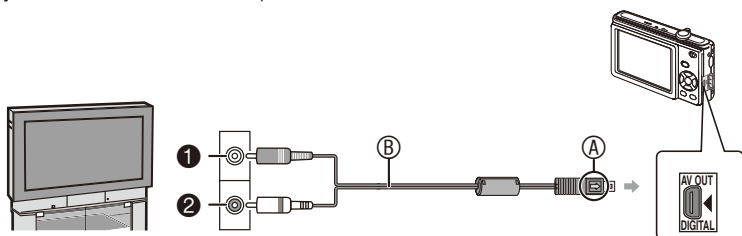

① Yellow: to the video input socket

② White: to the audio input socket

Ⓐ Align the marks, and insert.

Ⓑ AV cable

- Check the directions of the connectors, and plug them straight in or unplug them straight out. (Otherwise the connectors may be bent out of shape which will cause trouble.)

- 1** Connect the AV cable Ⓑ to the video input and the audio input sockets on the TV.
- 2** Connect the AV cable to the [AV OUT/DIGITAL] socket on the camera.
- 3** Turn the TV on and select external input.
- 4** Slide the recording/playback switch to []. Turn the camera on and play back the picture.

 **Note**

- Depending on the [PICTURE SIZE], black bands may be displayed on the top and bottom or the left and right of the pictures.
- Read the operating instructions for the TV.
- When you play back a picture vertically, it may be blurry.
- You can view pictures on TVs in other countries (regions) which use the NTSC or PAL system when you set [VIDEO OUT] in the [SETUP] menu. (Only for DMC-F2PU/DMC-F2PR)

Playing back pictures on a TV with an SD Memory Card slot

Still pictures recorded on an SD Memory Card can be played back on a TV with an SD Memory Card slot.



 **Note**

- Depending on the TV model, some pictures may not take up the whole screen.
- You cannot play motion pictures. To play back motion pictures, connect the camera to the TV with the AV cable.
- You cannot play back pictures on SDHC cards if the TV does not support these cards.

Screen Display

■ In recording

Recording in Normal Picture Mode [] (Initial setting)

- 1 Recording mode (P21)
- 2 Flash mode (P45)
- 3 Macro shooting (P49)
- 4 AF area (P29, 33)
- 5 Focus indication (P29, 33)
- 6 Picture size (P70)
- 7 Quality (P71)
- 8 Battery indication (P12)
- 9 Remaining number of recordable pictures (P127)
- 10  : Built-in memory (P16)
 : Card (P16) (appears during accessing only)
- 11 Recording indication
- 12 ISO sensitivity (P33, 71)
- 13 Shutter speed indication (P33)
- 14 Aperture value indication (P33)
- 15 Jitter alert (P34)

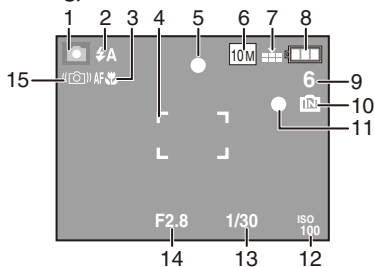

■ In recording (after settings)

16 White balance (P72)

17 ISO sensitivity (P33, 71)

18 Color mode (P77)

19 Recording Quality (P63)

20 Available recording time in Motion Picture Mode

e.g. : R 8m 30s

21 Self-timer (P50)

22 Travel date (P65)

23 Elapsed recording time (P62)

24 Name (P57, 58)

This is displayed for about 5 seconds when this unit is turned on in [BABY1]/[BABY2] or [PET] in Scene Mode.

25 Exposure compensation (P51)

26 Age (P57, 58)

- It is displayed about 5 seconds when switching to [BABY1]/[BABY2] or [PET] in Scene Mode.

27 Current date and time/Destination settings : ✈ (P69)

- It is displayed for about 5 seconds when turning the camera on, setting the clock and after switching from the [Playback] mode to the [Recording] mode.

Zoom (P35)/Extended Optical Zoom (P35)/Digital Zoom (P35):

W [] T 1 X

28 Number of days that have passed since the departure date (P65)

29 Burst (P76)

🎤 : Audio recording (P62)

30 AF assist lamp (P78) : AF*

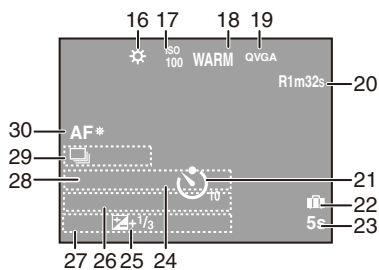

■ In playback

- 1 Playback mode (P21)
- 2 Protected picture (P94)
- 3 Favorites indicator (P91) : ★
- 4 Text stamp complete indicator (P87)
- 5 Picture size (P70)
Motion picture icon (P83)
- 6 Quality (P71)
- 7 Battery indication (P12)
- 8 Folder/File number (P98)
[M] : Built-in memory (P16)
Elapsed playback time (P83) : **8m 30s**
- 9 Picture number/Total pictures
- 10 Motion picture recording time (P83) : **8m 30s**
- 11 Compensating the Exposure (P51)
- 12 Recording information
- 13 Favorites setting (P91)
- 14 Recorded date and time
Destination settings (P68)
Name (P57, 58)
Title (P85)
- 15 Age display (P57, 58)
- 16 Number of days that have passed since the departure date (P65)
- 17 Number of prints (P92)
- 18 Motion picture playback (P83)
⚡ : Cable disconnection warning icon (P99)

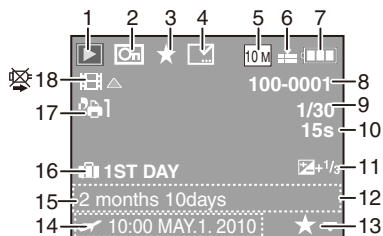

Cautions for Use

Optimal use of the camera

Take care not to drop or knock the unit or put a lot of pressure on it.

- Take care not to knock or drop the bag/case that you inserted the camera in as the shock may cause damage to the camera, lens or LCD monitor.
- Do not attach any other items to the hand strap that's included with your camera. While being stored, that item can rest against the LCD monitor and damage it.
- Do not use a paper bag as it can easily rip causing the camera to fall and be damaged.
- We strongly recommend you purchase a good camera bag/case from your local dealer to protect your camera.

Keep the camera as far away as possible from electromagnetic equipment (such as microwave ovens, TVs, video games etc.).

- If you use the camera on top of or near a TV, the pictures and sound on the camera may be disrupted by electromagnetic wave radiation.
- Do not use the camera near cell phones because doing so may result in noise adversely affecting the pictures and sound.
- Recorded data may be damaged, or pictures may be distorted, by strong magnetic fields created by speakers or large motors.
- Electromagnetic wave radiation generated by microprocessors may adversely affect the camera, disturbing the pictures and sound.
- If the camera is adversely affected by electromagnetic equipment and stops functioning properly, turn the camera off and remove the battery or disconnect AC adaptor (optional). Then reinsert the battery or reconnect AC adaptor and turn the camera on.

Do not use the camera near radio transmitters or high-voltage lines.

- If you record near radio transmitters or high-voltage lines, the recorded pictures and sound may be adversely affected.

Always use the supplied cords and cables. If you use optional accessories, use the cords and the cables supplied with them.

Do not extend the cords or the cables.

Do not spray insecticides or volatile chemicals onto the camera.

- If the camera is sprayed with such chemicals, the camera body may be damaged and the surface finish may peel off.
- Do not keep rubber or plastic products in contact with the camera for a long period of time.

Maintenance

Before cleaning the camera, remove the battery or the DC coupler (optional), or disconnect the power plug from the outlet. Then wipe the camera with a dry soft cloth.

- When the camera becomes dirty, clean it with a soft, slightly damp cloth. Then wipe the camera with a dry cloth.
- Do not use solvents such as benzine, thinner, alcohol or kitchen detergent. This can cause damage to the body of the camera and the surface may peel off.
- When using chemically treated cloth, read the instructions beforehand.
- When the LCD display becomes dirty, blow away dust and dirt with a commercially available blower brush. When the dirt is heavy, wipe it with a soft cloth such as an eyeglass cloth.

About the LCD monitor

- Do not press the LCD monitor with excessive force. Uneven colors may appear on the LCD monitor and it may malfunction.
- Do not press the LCD monitor with a sharp and hard tip such as a ballpoint pen.
- Do not scrub or press the LCD monitor with excessive force.
- If the camera is cold when you turn it on, the picture on the LCD monitor will be slightly darker than usual at first. However, the picture will return to normal brightness when the internal temperature of the camera increases.

Extremely high precision technology is employed to produce the LCD monitor screen. However there may be some dark or bright spots (red, blue or green) on the screen. This is not a malfunction. The LCD monitor screen has more than 99.99% effective pixels with a mere 0.01% of the pixels inactive or always lit. The spots will not be recorded in pictures in the built-in memory or a card.

About the Lens

- Do not press the lens with excessive force.
- Do not leave the camera with the lens facing the sun as rays of light from the sun may cause it to malfunction. Also, be careful when placing the camera outside or near a window.

Battery

The battery is a rechargeable lithium ion battery. Its ability to generate power comes from the chemical reaction that takes place inside it. This reaction is susceptible to the surrounding temperature and humidity. If the temperature is too high or too low, the operating time of the battery will become shorter.

Always remove the battery after use.

- Store the removed battery in the battery case (supplied).

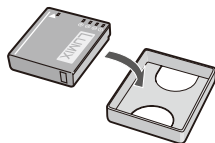

If you drop the battery accidentally, check to see if the body of the battery and the terminals are damaged.

- Inserting a damaged battery in the camera will damage the camera.

Bring charged spare batteries when going out.

- Be aware that the operating time of the battery becomes shorter in low temperature conditions such as at a ski resort.
- When you travel, do not forget to bring the battery charger (supplied) so that you can charge the battery in the country that you are traveling in.

Dispose of unusable battery.

- The battery has a limited life.
- Do not throw battery into fire because it may cause an explosion.
- An unusable battery should be discarded in accordance with battery recycling laws. Call the RBRC hotline on 1-800-822-8837 for information.

Do not allow battery terminals to come into contact with metal objects (such as necklaces, hairpins, etc.).

- This can cause short circuiting or heat generation and you may be badly burned if you touch the battery.

Charger

- If you use the battery charger near a radio, the radio reception may be disturbed.
- Keep the charger 1 m (3.28 feet) or more away from radios.
- The charger may generate whirring sounds when it is being used. This is not a malfunction.
- After use, be sure to disconnect the power supply device from the electrical outlet. (A very small amount of current is consumed if it is left connected.)
- Keep the terminals of the charger and battery clean.

Card

Do not leave the card where the temperature is high, where electromagnetic waves or static electricity are easily generated or exposed to direct sunlight.

Do not bend or drop the card.

- The card may be damaged or the recorded content may be damaged or erased.
- Store the card in the card case or the storage bag after use and when you store or carry the card.
- Do not allow dirt, dust or water to enter the terminals on the back of the card and do not touch the terminals with your fingers.

When disposing of/transferring memory cards:

If using the 'format' or 'delete' functions on your camera or computer, this only changes the file management information, and does not completely delete the data from within the memory card.

When disposing of or transferring your memory cards, we recommend physically destroying the memory card itself, or using commercially available computer data erasing software to completely delete the data from the card.

Data within memory cards should be managed responsibly.

About private information

When the name and birthday are set in [BABY1]/[BABY2] Mode, the private information is included in the picture taken.

Disclaimer

- Information containing private information may be changed or lost due to operation mistake, static electricity, accident, malfunction, or repair.
- Panasonic assumes no liability for direct/indirect damage resulting from change or loss of information including private information.

For service or transfer/disposal

- Reset the settings to protect private information. (P26)
- When images exist in the built-in memory, copy them onto the memory card (P95) and then format the built-in memory (P27).
- Remove the memory card from this camera.
- The built-in memory settings may be restored to the factory settings after being repaired.
- If the above operations are not possible due to a malfunction condition, consult the place of purchase.

For transfer/disposal of memory cards, refer to "When disposing of/transferring memory cards" (above).

When not using the camera for a long period of time

- Store the battery in a cool and dry place with a relatively stable temperature.
[Recommended temperature: 15 °C to 25 °C (59 °F to 77 °F),
Recommended humidity: 40% to 60%]
- Always remove the battery and the card from the camera.
- If the battery is left inserted in the camera, it will discharge even if the camera is turned off. If the battery continues to be left in the camera, it will discharge excessively and may become unusable even if charged.
- When storing the battery for a long period of time, we recommend charging it once a year. Remove the battery from the camera and store it again after it has completely discharged.
- We recommend storing the camera with a desiccant (silica gel) when you keep it in a closet or a cabinet.

About the picture data

- Recorded data may be damaged or lost if the camera breaks down due to inappropriate handling. Panasonic will not be liable for any damage suffered due to loss of recorded data.

About tripods

- When you use a tripod, make sure the tripod is stable when this unit is attached to it.
- You may not be able to remove the card and battery when using a tripod.
- Make sure that the screw on the tripod is not at an angle when attaching or detaching the camera. You may damage the screw on the camera if you use excessive force when turning it. Also, the camera body and the rating label may be damaged or scratched if the camera is attached too tightly to the tripod.
- Read the operating instructions for the tripod carefully.
- Some tripods cannot be attached when the DC coupler (optional) and AC adaptor is connected.

Message Display

Confirmation messages or error messages will be displayed on the screen in some cases. The major messages are described below as examples.

[THIS MEMORY CARD IS LOCKED]

- The Write-Protect switch on the SD Memory Card and the SDHC Memory Card are moved to [LOCK]. Move the switch back to unlock it. (P17)

[NO VALID PICTURE TO PLAY]

- Record a picture or insert a card with a recorded picture and then play it.

[THIS PICTURE IS PROTECTED]

- Delete the picture after canceling the protect setting. (P94)

[THIS PICTURE CANNOT BE DELETED]/[SOME PICTURES CANNOT BE DELETED]

- Pictures not based on the DCF standard cannot be deleted.
 - If you want to delete some pictures, format the card after saving necessary data on a PC etc. (P27)

[NO ADDITIONAL SELECTIONS CAN BE MADE]

- The number of pictures, which can be set at one time when [MULTI] has been selected for [DELETE MULTI] (P41), [FAVORITE] (P91), [TITLE EDIT] (P85), [TEXT STAMP] (P87) or [RESIZE] (P89) has been exceeded.
 - Reduce the number of pictures set, and then repeat the operation.
- More than 999 favorites have been set.

[CANNOT BE SET ON THIS PICTURE]

- [TITLE EDIT], [TEXT STAMP] or [PRINT SET] cannot be set for pictures not based on the DCF standard.

[NOT ENOUGH SPACE ON BUILT-IN MEMORY]/[NOT ENOUGH MEMORY ON THE CARD]

- There is no space left on the built-in memory or the card.
 - When you copy pictures from the built-in memory to the card (batch copy), the pictures are copied until the capacity of the card becomes full.

[SOME PICTURES CANNOT BE COPIED]/[COPY COULD NOT BE COMPLETED]

- The following pictures cannot be copied.
 - When a picture with the same name as the picture to be copied exists in the copy destination. (When copying pictures from the card to the built-in memory)
 - Files not based on the DCF standard.
- Moreover, pictures recorded or edited by other equipment may not be copied.

[BUILT-IN MEMORY ERROR FORMAT BUILT-IN MEMORY?]

- This message will be displayed when you format the built-in memory on a PC.
 - Format the built-in memory on the camera again. (P27) The data on the built-in memory will be deleted.

[MEMORY CARD ERROR FORMAT THIS CARD?]

- This card has a format which is not recognized by the camera.
 - Format the card again with the camera after saving necessary data on a PC etc. (P27)

[PLEASE TURN CAMERA OFF AND THEN ON AGAIN]/[SYSTEM ERROR]

- This message appears when the camera is not operating properly.
 - Turn the camera off and on. If the message persists, contact the dealer or your nearest Service Center.

[MEMORY CARD PARAMETER ERROR]/[THIS MEMORY CARD CANNOT BE USED]

- Use a card compatible with this camera. (P17)
- You can only use an SDHC Memory Card if using cards with 4 GB or more capacity.

[MEMORY CARD ERROR PLEASE CHECK THE CARD]

- Failed access to the card.
 - Insert the card again.
 - Insert a different card.

**[READ ERROR PLEASE CHECK THE CARD]/
[WRITE ERROR PLEASE CHECK THE CARD]**

- It has failed to read or write data.
 - Turn the camera off and remove the card. Insert the card again, turn the power on, and try to read or write the data again.
- The card may be broken.
 - Insert a different card.

**[MOTION RECORDING WAS CANCELLED DUE TO THE LIMITATION OF THE
WRITING SPEED OF THE CARD]**

- When you set the picture quality to [WVGA] or [VGA], we recommend using a high-speed card with "10 MB/s" or greater displayed on the package.
- If the operation stops even if you use the card with memory size of 10 MB/s or greater, this means the data-writing speed has lowered. We recommend backing up the data and formatting the card. (P27)
- Depending on the type of SD Memory Card or SDHC Memory Card, motion picture recording may stop in the middle.

[A FOLDER CANNOT BE CREATED]

- A folder cannot be created because there are no remaining folder numbers that can be used. (P98)
 - Format the card after saving necessary data on a PC etc. (P27)

[PICTURE IS DISPLAYED FOR 4:3 TV]/[PICTURE IS DISPLAYED FOR 16:9 TV]

- The AV cable is connected to the camera.
 - Press [MENU/SET] if you want to delete this message at once.
 - Select [TV ASPECT] in the [SETUP] menu to change the TV aspect. (P27)
- This message also appears when the USB connection cable is connected to the camera only. In this case, connect the other end of the USB connection cable to a PC or a printer. (P96, 99)

[PRINTER BUSY]/[PLEASE CHECK THE PRINTER]

- The printer cannot print.
 - Check the printer.

[NO BATTERY POWER REMAINS]

- The remaining battery power is low.
 - Charge the battery.

[THIS BATTERY CANNOT BE USED]

- The battery cannot be recognized by the camera.
 - Use a genuine Panasonic battery. If this message is displayed even when a genuine Panasonic battery is used, contact the dealer or your nearest Service Center.
- The battery cannot be recognized as its terminal is dirty.
 - Remove any dirt etc. from the terminal.

Troubleshooting

First, try out the following procedures (P118–126).

If the problem is not resolved, **it may be improved by selecting [RESET] (P26) on the [SETUP] menu when taking pictures.**

Battery and power source

The camera cannot be operated even when it is turned on.

- Is the battery inserted correctly? (P14)
- The battery is exhausted.

The LCD monitor turns off while the camera is turned on.

- Is [POWER SAVE] (P26) mode active?
→ Press the shutter button halfway to cancel this mode.
- The battery is exhausted.

The camera turns off soon after turning it on.

- The battery is exhausted.
- If you leave the camera on, the battery will become exhausted.
→ Turn the camera off frequently by using [POWER SAVE] (P26) Mode etc.

The [CHARGE] lamp flashes.

- Is the temperature of the battery excessively high or low? If it is, it will take longer than usual to charge the battery or charging may remain incomplete.
- Are the terminals of the charger or battery dirty?
→ Wipe off the dirt using a dry cloth.

Shooting

The picture cannot be recorded.

- Is the mode correctly set? (P20)
- Is there any memory capacity left on the built-in memory or the card?
 - Before recording, delete some pictures. (P40)

The recorded pictures are pale.

- The picture can become whitish if there is dirt e.g. fingerprints on the lens.
 - If the lens is dirty, turn on the camera, eject the lens barrel (P9) and gently wipe the lens surface with a soft dry cloth.

The area around where the pictures were taken becomes dark.

- Was this picture taken with the flash at the close range when the zoom is near [W] (1×)?
 - Zoom in a little, and then take the pictures. (P35)

The recorded picture is too bright or dark.

- Check that the exposure is correctly compensated. (P51)

2 or 3 pictures are taken at one time.

- Set other than [HI-SPEED BURST] (P59), [FLASH BURST] (P59) in Scene Mode or set [BURST] (P76) to [OFF].

The subject is not focused properly.

- The focus range varies depending on the Recording Mode.
 - Set the proper Recording Mode for the distance to the subject.
- Is the subject out of the focus range? (P29, 32 and 49)
- Have you taken a picture with jitter? (P34)

The recorded picture is blurred.

- The shutter speed becomes slower when pictures are taken in dark places so hold the camera firmly with both hands to take the pictures. (P28)
- When taking pictures at a slow shutter speed, use a tripod or the self-timer. (P50)
- When you do not use the Digital Zoom, set it to [OFF] and the sensitivity to [i.AUTO]. (P71)

The recorded picture looks rough. Noise appears on the picture.

- Is the ISO sensitivity high or the shutter speed slow? (When set to [i.AUTO], ISO sensitivity increases for indoor and other shooting occasions.)
 - Reduce ISO sensitivity. (P71)
 - Set [COLOR MODE] to [NATURAL]. (P77)
 - Improve the ambient light.
- In [HIGH SENS.], [HI-SPEED BURST] and [FLASH BURST] mode, the resolution of the recorded picture decreases slightly because of high sensitivity processing. This is not a malfunction.

The brightness or the hue of the recorded picture is different from the actual scene.

- If recording under fluorescent light, the brightness or the hue may change slightly when the shutter speed becomes fast. This occurs due to the characteristics of fluorescent light. It is not a malfunction.

A reddish vertical line (smear) appears on the LCD monitor during picture-taking.

- This is a characteristic of CCD, and it appears when the subject has a bright part. Some unevenness may occur in the surrounding areas, but this is not a malfunction. It is recorded in motion pictures but is not recorded on still pictures.
- It is recommended that you take pictures while taking care not to expose the screen to sunlight or any other source of strong light.



Motion picture recording stops in the middle.

- Depending on the type of the card, recording may stop in the middle.
 - When you set the picture quality to [WVGA] or [VGA], we recommend using a high-speed card with "10 MB/s" or greater displayed on the package.
 - If the recording stops even if you use the card of 10 MB/s or faster, this means the data-writing speed became lowered. We recommend backing up the data and formatting (P27) the card.

Recorded image may be warped, or nonexistent color is surrounding the subject.

- It is possible that the subject may be warped slightly, or the borders get colored, depending on the zoom magnification, due to the characteristics of the lens. Also, the peripherals of the image might look warped because the perspective is enhanced when the wide angle is used. This is not a malfunction.

LCD monitor

The LCD monitor turns off although the camera is turned on.

- When the camera is not operated for a while, [POWER SAVE] is activated. (P26)
[This does not happen when using the AC adaptor (optional).] If the remaining battery power is low, it may take longer for the flash to be charged, and the time during which the LCD monitor is turned off may become longer.

The LCD monitor darkens during use.

- This camera automatically charges for flash recording and may darken the LCD monitor for efficient charge. The monitor may darken in the following cases;
 - Just after turning the camera ON
 - Just after setting to Recording Mode
 - When adjusting the zoom or pointing the camera toward dark sideThe LCD monitor lights up again to return to recording-ready condition after charging for flash.

The LCD monitor becomes darker or brighter for a moment.

- This phenomenon appears when pressing the shutter button halfway to set the aperture value and does not affect the recorded pictures.
- This phenomenon also appears when the brightness changes when the camera is zoomed or moved. This is because of operation of the automatic aperture of the camera, and it is not a malfunction.

The LCD monitor flickers indoors.

- The LCD monitor may flicker for a few seconds after turning the camera on indoors under fluorescent light. This is not a malfunction.

Black, red, blue and green dots appear on the LCD monitor.

- This is not a malfunction. These pixels do not affect the recorded pictures.

Noise appears on the LCD monitor.

- In dark places, noise may appear to maintain the brightness of the LCD monitor. This does not affect the pictures you are recording.

Uneven colors come on the LCD monitor.

- If you press the LCD monitor with excessive force, uneven colors may appear on it.

Flash

Flash is not activated.

- Is the flash setting set to Forced OFF []?
→ Change the flash setting. (P44)
- Flash Mode is not available when [BURST] (P76) in [REC] menu has been set.
- Flash is not available depending on Scene Mode. (P46)

The flash is activated several times.

- The flash is activated twice when Red-eye Reduction (P45) has been set.
- Has [FLASH BURST] (P59) in Scene Mode been set?

Playback

The picture being played back is rotated and displayed in an unexpected direction.

- Use [ROTATE]. (P90)

The picture is not played back.

- Is the recording/playback switch set to playback []? (P20)
- Is there a picture on the built-in memory or the card?
→ The pictures on the built-in memory appear when a card is not inserted. The picture data on the card appears when a card is inserted.
- Is this a picture whose file name has been changed in the PC? If it is, it cannot be played back by this unit.

The recorded pictures are not displayed.

- Has [FAVORITE PLAY] been set for playback?
→ Change to [NORMAL PLAY]. (P21)

The folder number and the file number are displayed as [—] and the screen turns black.

- Is this a non-standard picture, a picture which has been edited using a PC or a picture which was taken by another make of digital camera?
- Did you remove the battery immediately after picture-taking or did you take the picture using the battery with a low remaining charge?
→ Format the card to delete the pictures mentioned above. (P27)
(Other pictures will be deleted as well and it will not be possible to restore them. Therefore, check well before formatting.)

With a calendar search, pictures are displayed on dates differing from the actual dates on which the pictures were taken.

- Is the clock in the camera set properly? (P18)
- When pictures edited using a PC or pictures taken by other equipment are searched, they may be displayed on dates differing from the actual dates on which the pictures were taken.

White round spots like soap bubbles appear on the recorded picture.

- If you take a picture with the flash in a dark place or indoors, white round spots may appear on the picture caused by the flash reflecting of particles of dust in the air. This is not a malfunction. A characteristic of this is that the number of round spots and their position differ in every picture.

**[THUMBNAIL IS DISPLAYED] appears on the screen.**

- Is it a picture that has been recorded with other equipment? In such cases, these pictures may be displayed with a deteriorated picture quality.

A clicking sound is recorded in the motion pictures.

- This unit automatically adjusts the aperture during motion picture recording. At such times, a clicking sound is heard, and this sound may be recorded on the motion pictures. This is not a malfunction.

TV, PC and printer**The picture does not appear on the television.**

- Is the camera connected to the TV correctly?
→ Set the TV to Video Input Mode. (P105)

The display areas on the TV screen and the camera's LCD monitor are different.

- Depending on the TV model, the pictures may be extended horizontally or vertically or they may be displayed with their edges cut off.

The motion pictures cannot be played back on a TV.

- Are you trying to play back the motion pictures by directly inserting the card in the card slot of the TV?
→ Connect the camera to the TV with the AV cable, and then play back the motion pictures on the camera. (P83, 105)

The picture size does not fit the TV screen.

- Check the [TV ASPECT] setting on this unit. (P27)

The picture cannot be transferred when the camera is connected to a PC.

- Is the camera connected to the PC correctly?
- Is the camera recognized by the PC correctly?
→ Select [PC] when connecting. (P97)

The card is not recognized by the PC. (The built-in memory is recognized.)

- Disconnect the USB connection cable. Connect it again while the card is inserted in the camera.

The picture cannot be printed when the camera is connected to a printer.

- Is the camera connected to the printer correctly?
- Pictures cannot be printed using a printer which does not support PictBridge.
→ Select [PictBridge(PTP)] when connecting. (P100)

The ends of the pictures are cut at printing.

- When using a printer with a trimming or borderless printing function, cancel this function before printing. (For details, refer to the operating instructions for the printer.)
- When you order photo studios to print pictures, ask the photo studio if the 16:9 pictures can be printed.

Others**An unreadable language was selected by mistake.**

- Press [MENU/SET], select the [SETUP] menu icon [] and then select the [] icon to set the desired language. (P27)

When the shutter button is pressed halfway, a red lamp turns on sometimes.

- In dark places, the AF assist lamp (P78) lights red to make it easier to focus on a subject.

The AF assist lamp does not turn on.

- Is [AF ASSIST LAMP] on the [REC] menu set to [ON]? (P78)
- The AF assist lamp does not turn on in bright places.

The camera becomes warm.

- The surface of the camera may become warm during use. This does not affect the performance or quality of the camera.

The lens clicks.

- When brightness has changed due to the zoom or the movement of the camera or other, the lens may click and the picture on the screen may be drastically changed: however, the pictures are not affected. The sound is caused by automatic adjustment of the aperture. It is not a malfunction.

The clock is reset.

- If you do not use the camera for a long time, the clock setting may be reset.
→ When the message [PLEASE SET THE CLOCK] appears, set the clock again. (P18)

When pictures are taken using the zoom, they are slightly distorted and the areas around the subject contain colors which are not actually present.

- It is possible that the subject may be warped slightly or the borders get colored, depending on the zoom magnification, but this is not a malfunction.

Zooming stops instantaneously.

- When using the Extended Optical Zoom, the zooming action will stop temporarily near [W]. This is not a malfunction.

File numbers are not created in order.

- Certain operations cause pictures to be saved in folders with different numbers. (P98)

The file numbers are recorded in ascending order.

- If the battery is inserted or removed without first turning the camera's power off, the folder and file numbers for the pictures taken will not be stored in the memory. When the power is then turned back on and pictures are taken, they may be stored under file numbers which should have been assigned to previous pictures.

[AGE] is not displayed correctly.

- Check the clock (P18) and birthday settings (P57, 58).

The lens barrel is retracted.

- The lens barrel retracts about 15 seconds after switching from Recording Mode to Playback Mode.









If the camera is left for a while, [DEMO MODE] is suddenly started.





- This is an auto demo to introduce this unit. Press any button to return to the previous screen.





Number of Recordable Pictures and Available Recording Time

- The number of recordable pictures and the available recording time are an approximation. (These vary depending on the recording conditions and the type of card.)
- The number of recordable pictures and the available recording time vary depending on the subjects.

■ Number of recordable pictures

Picture size		4:3 [10M] (3648 × 2736 pixels)		4:3 [5M ] (2560 × 1920 pixels)		4:3 [3M ] (2048 × 1536 pixels)	
							
Built-in Memory (Approx. 50 MB)		9	20	20	40	31	62
Card	32 MB	5	11	11	23	18	36
	64 MB	11	24	24	48	38	75
	128 MB	24	49	50	99	78	150
	256 MB	48	97	98	190	150	290
	512 MB	97	190	195	380	300	590
	1 GB	195	380	390	770	600	1180
	2 GB	390	770	790	1530	1220	2360
	4 GB	770	1520	1560	3010	2410	4640
	6 GB	1180	2320	2380	4580	3660	7050
	8 GB	1580	3100	3180	6130	4910	9440
	12 GB	2380	4680	4810	9260	7400	14240
	16 GB	3180	6250	6410	12350	9880	19000
32 GB	6390	12540	12870	24780	19820	38120	

Picture size		3:2 [9M] (3648 × 2432 pixels)		3:2 [2.5M ] (2048 × 1360 pixels)	
Quality					
Built-in Memory (Approx. 50 MB)		11	22	36	69
Card	32 MB	6	12	20	40
	64 MB	13	27	43	83
	128 MB	27	55	88	165
	256 MB	54	105	170	330
	512 MB	105	210	340	650
	1 GB	210	430	680	1310
	2 GB	440	870	1360	2560
	4 GB	870	1720	2680	5020
	6 GB	1320	2620	4070	7640
	8 GB	1770	3500	5450	10230
	12 GB	2680	5290	8230	15430
	16 GB	3580	7050	10980	20590
	32 GB	7180	14160	22020	41300

Picture size		16:9 [7.5M] (3648 × 2056 pixels)		16:9 [2M ] (1920 × 1080 pixels)	
Quality					
Built-in Memory (Approx. 50 MB)		13	26	47	91
Card	32 MB	7	15	27	53
	64 MB	15	32	57	105
	128 MB	33	65	115	220
	256 MB	65	125	220	430
	512 MB	125	250	450	860
	1 GB	250	510	900	1720
	2 GB	520	1020	1800	3410
	4 GB	1030	2010	3540	6700
	6 GB	1560	3050	5390	10190
	8 GB	2090	4090	7220	13640
	12 GB	3160	6170	10890	20580
	16 GB	4220	8230	14530	27450
	32 GB	8470	16520	29150	55070

■ Available recording time (In Motion Picture Mode)

Picture quality setting		WVGA	VGA	QVGA
Built-in Memory (Approx. 50 MB)		—	—	1 min 37 s
Card	32 MB	16 s	17 s	56 s
	64 MB	37 s	39 s	1 min 58 s
	128 MB	1 min 18 s	1 min 22 s	4 min
	256 MB	2 min 35 s	2 min 40 s	7 min 50 s
	512 MB	5 min 10 s	5 min 20 s	15 min 40 s
	1 GB	10 min 20 s	10 min 50 s	31 min 20 s
	2 GB	21 min 20 s	22 min 10 s	1 h 4 min
	4 GB	41 min 50 s	43 min 40 s	2 h 5 min
	6 GB	57 min	1 h 6 min	3 h 11 min
	8 GB	1 h 25 min	1 h 28 min	4 h 15 min
	12 GB	1 h 55 min	2 h 14 min	6 h 26 min
16 GB	2 h 52 min	2 h 59 min	8 h 35 min	
32 GB	5 h 45 min	5 h 59 min	17 h 13 min	

(DMC-F2P/DMC-F2PC/DMC-F2PU)

- The volume of motion picture is limited to 2 GB per recording session. The maximum available recording time for up to 2 GB only is displayed on the screen.

(DMC-F2PR)

- Motion pictures can be recorded continuously for up to 15 minutes. Also, continuous recording exceeding 2 GB is not possible.
Remaining time for continuous recording is displayed on the screen.



Note

- The number of recordable pictures and the available recording time displayed on the LCD monitor may not decrease in order.
- The Extended Optical Zoom does not work in [HIGH SENS.], [HI-SPEED BURST] and [FLASH BURST] mode so the picture size for [EZ] is not displayed.