

# Panasonic®

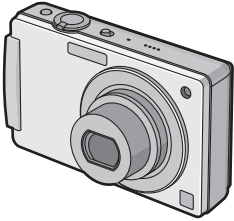

## Operating Instructions

Digital Camera

Model No. **DMC-FX580**



Before connecting, operating or adjusting this product,  
please read the instructions completely.



For USA and Puerto Rico assistance, please call: 1-800-211-PANA(7262) or,  
contact us via the web at: <http://www.panasonic.com/contactinfo>

For Canadian assistance, please call: 1-800-99-LUMIX (1-800-995-8649) or  
send e-mail to: [lumixconcierge@ca.panasonic.com](mailto:lumixconcierge@ca.panasonic.com)



VQT1Y62

**Dear Customer,  
Thank you for choosing Panasonic!**

You have purchased one of the most sophisticated and reliable products on the market today. Used properly, we're sure it will bring you and your family years of enjoyment. Please take time to fill in the information below. The serial number is on the tag located on the underside of your Camera. Be sure to **retain this manual** as your convenient Camera information source. Please note that the actual controls and components, menu items, etc. of your Digital Camera may look somewhat different from those shown in the illustrations in these Operating Instructions.

**Carefully observe copyright laws.**

- Recording of pre-recorded tapes or discs or other published or broadcast material for purposes other than your own private use may infringe copyright laws. Even for the purpose of private use, recording of certain material may be restricted.

Model No. \_\_\_\_\_

Serial No. \_\_\_\_\_



A lithium ion battery that is recyclable powers the product you have purchased. Please call 1-800-8-BATTERY for information on how to recycle this battery.

## Information for Your Safety

### **WARNING:**

- TO REDUCE THE RISK OF FIRE, ELECTRIC SHOCK OR PRODUCT DAMAGE,**
- **DO NOT EXPOSE THIS APPARATUS TO RAIN, MOISTURE, DRIPPING OR SPLASHING AND THAT NO OBJECTS FILLED WITH LIQUIDS, SUCH AS VASES, SHALL BE PLACED ON THE APPARATUS.**
  - **USE ONLY THE RECOMMENDED ACCESSORIES.**
  - **DO NOT REMOVE THE COVER (OR BACK); THERE ARE NO USER SERVICEABLE PARTS INSIDE. REFER SERVICING TO QUALIFIED SERVICE PERSONNEL.**

THE SOCKET OUTLET SHALL BE INSTALLED NEAR THE EQUIPMENT AND SHALL BE EASILY ACCESSIBLE.

Product Identification Marking is located on the bottom of units.

**THE FOLLOWING APPLIES ONLY IN CANADA.**

This Class B digital apparatus complies with Canadian ICES-003.

**THE FOLLOWING APPLIES ONLY IN THE U.S.A.****FCC Note:**

This equipment has been tested and found to comply with the limits for a Class B digital device, pursuant to Part 15 of the FCC Rules. These limits are designed to provide reasonable protection against harmful interference in a residential installation. This equipment generates, uses, and can radiate radio frequency energy and, if not installed and used in accordance with the instructions, may cause harmful interference to radio communications. However, there is no guarantee that interference will not occur in a particular installation. If this equipment does cause harmful interference to radio or television reception, which can be determined by turning the equipment off and on, the user is encouraged to try to correct the interference by one or more of the following measures:

- Reorient or relocate the receiving antenna.
- Increase the separation between the equipment and receiver.
- Connect the equipment into an outlet on a circuit different from that to which the receiver is connected.
- Consult the dealer or an experienced radio/TV technician for help.

**FCC Caution:** To assure continued compliance, follow the attached installation instructions and use only shielded interface cables with ferrite core when connecting to computer or peripheral devices.

Any changes or modifications not expressly approved by the party responsible for compliance could void the user's authority to operate this equipment.

**Declaration of Conformity**

Trade Name: Panasonic

Model No.: DMC-FX580

Responsible party: Panasonic Corporation of North America One Panasonic Way,  
Secaucus, NJ 07094

Support Contact: Panasonic Consumer Electronics Company 1-800-211-PANA (7262)

This device complies with Part 15 of the FCC Rules. Operation is subject to the following two conditions: (1) This device may not cause harmful interference, and (2) this device must accept any interference received, including interference that may cause undesired operation.



## ■ About the battery pack

### CAUTION

Battery pack (Lithium ion battery pack)

- Use the specified unit to recharge the battery pack.
- Do not use the battery pack with equipment other than the specified unit.
- Do not get dirt, sand, liquids, or other foreign matter on the terminals.
- Do not touch the plug terminals (+ and -) with metal objects.
- Do not disassemble, remodel, heat or throw into fire.

If any electrolyte should come into contact with your hands or clothes, wash it off thoroughly with water.

If any electrolyte should come into contact with your eyes, never rub the eyes. Rinse eyes thoroughly with water, and then consult a doctor.

### CAUTION

Danger of explosion if battery is incorrectly replaced. Replace only with the same or equivalent type recommended by the manufacturer. Dispose of used batteries according to the manufacturer's instructions.

- Do not heat or expose to flame.
- Do not leave the battery(ies) in an automobile exposed to direct sunlight for a long period of time with doors and windows closed.

### Warning

Risk of fire, explosion and burns. Do not disassemble, heat above 60 °C (140 °F) or incinerate.

## ■ About the battery charger

### CAUTION!

**DO NOT INSTALL OR PLACE THIS UNIT IN A BOOKCASE, BUILT-IN CABINET OR IN ANOTHER CONFINED SPACE. ENSURE THE UNIT IS WELL VENTILATED. TO PREVENT RISK OF ELECTRIC SHOCK OR FIRE HAZARD DUE TO OVERHEATING, ENSURE THAT CURTAINS AND ANY OTHER MATERIALS DO NOT OBSTRUCT THE VENTILATION VENTS.**

### Battery charger

This battery charger operates on AC between 110 V and 240 V.

But

- In the U.S.A. and Canada, the battery charger must be connected to a 120 V AC power supply only.
- When connecting to an AC supply outside of the U.S.A. or Canada, use a plug adaptor to suit the AC outlet configuration.

## ■ Care of the camera

- **Do not strongly shake or bump the camera by dropping or hitting it. Do not subject to strong pressure.**  
The camera may malfunction, recording pictures may become impossible, or the lens, the LCD monitor or the external case may be damaged.
- We strongly recommend you do not leave the camera in your trousers pocket when you sit down or forcefully insert it into a full or tight bag etc.  
Damage to the LCD monitor or personal injury may result.
- Do not attach any other items to the hand strap that's included with your camera. While being stored, that item can rest against the LCD monitor and damage it.
- **Be particularly careful in the following places as they may cause this unit to malfunction.**
  - Places with a lot of sand or dust.
  - Places where water can come into contact with this unit such as when using it on a rainy day or on a beach.
- **Do not touch the lens or the sockets with dirty hands. Also, be careful not to allow liquids, sand and other foreign matter to get into the space around the lens, buttons etc.**
- **This camera is not waterproof. If water or seawater splashes on the camera, use a dry cloth to wipe the camera body carefully.**  
**If the unit does not operate normally, please contact the dealer where you purchased the camera or the repair service center.**



## ■ About Condensation (When the lens and LCD monitor are fogged up)

- Condensation occurs when the ambient temperature or humidity changes. Be careful of condensation since it causes lens and LCD monitor stains, fungus and camera malfunction.
- If condensation occurs, turn the camera off and leave it for about 2 hours. The fog will disappear naturally when the temperature of the camera becomes close to the ambient temperature.

## ■ Read together with the “Cautions for Use”. (P114)

-If you see this symbol-

### Information on Disposal in other Countries outside the European Union

This symbol is only valid in the European Union.

If you wish to discard this product, please contact your local authorities or dealer and ask for the correct method of disposal.



# Contents

## Before Use

Information for Your Safety .....	2
Quick Guide .....	8
Standard Accessories .....	9
Names of the Components .....	10
How to Use the Touch Panel .....	12
• What can be done by touch operation .....	13

## Preparation

Charging the Battery .....	14
• About the Battery (charging/number of recordable pictures) .....	15
Inserting and Removing the Card (optional)/the Battery .....	16
About the Built-in Memory/the Card .....	18
Setting Date/Time (Clock Set) .....	19
• Changing the clock setting .....	20
Setting the Menu .....	20
• Setting menu items .....	21
• Using the quick menu .....	22
About the Setup Menu .....	23
Selecting the [REC] Mode .....	28

## Basic

Taking pictures using the automatic function ([A]: Intelligent Auto Mode) .....	29
• Scene detection .....	30
• Face Recognition .....	31
• About the flash .....	31
• Settings in Intelligent Auto Mode .....	31
Taking pictures with your favorite settings ([P]: Program AE Mode) .....	32
• Focusing .....	33
• When the subject is not in focus (such as when it is not in the center of the composition of the picture you want to take) .....	33
• Preventing jitter (camera shake) .....	34
• Direction detection function .....	34
Taking Pictures with the Zoom .....	34
• Using the Optical Zoom/Using the Extended Optical Zoom (EZ)/Using the Digital Zoom .....	34
• Using the Easy zoom .....	36
Playing back Pictures ([NORMAL PLAY]) .....	37
• Using the Touch Zoom .....	37
• Switching the [PLAYBACK] Mode .....	38

Deleting Pictures .....	40
• To delete a single picture .....	40
• To delete multiple pictures (up to 50) or all the pictures .....	40

## Advanced (Recording pictures)

About the LCD Monitor .....	41
Taking Pictures using the Built-in Flash .....	43
• Switching to the appropriate flash setting .....	43
• Adjust the flash output .....	45
Taking Close-up Pictures .....	46
Taking Pictures with the Self-timer .....	47
Taking Pictures with Focus and Exposure Set on Subject (Touch AF/AE) .....	48
Taking Pictures with Set Aperture ([A]: Aperture-priority AE) .....	49
Taking Pictures with Set Shutter Speed ([S]: Shutter-priority AE) .....	50
Taking Pictures with Exposure Set Manually ([M]: Manual exposure) .....	51
Compensating the Exposure .....	53
Taking Pictures using Auto Bracket/Color Bracket .....	54
• Auto Bracket .....	54
• Color Bracket .....	55
Taking pictures that match the scene being recorded (Scene Mode) .....	55
• Registering scenes in Scene Mode ([MS]: My Scene Mode) .....	55
• Selecting the Scene Mode for each recording ([SM]: Scene Mode) .....	56
• [PORTRAIT] .....	57
• [SOFT SKIN] .....	57
• [TRANSFORM] .....	57
• [SELF PORTRAIT] .....	58
• [SCENERY] .....	58
• [PANORAMA ASSIST] .....	58
• [SPORTS] .....	59
• [NIGHT PORTRAIT] .....	59
• [NIGHT SCENERY] .....	59
• [FOOD] .....	60
• [PARTY] .....	60
• [CANDLE LIGHT] .....	60
• [BABY1]/[BABY2] .....	60
• [PET] .....	61
• [HIGH SENS.] .....	61
• [HI-SPEED BURST] .....	62
• [FLASH BURST] .....	62
• [STARRY SKY] .....	63
• [FIREWORKS] .....	63
• [SUNSET] .....	64
• [BEACH] .....	64
• [SNOW] .....	64
• [AERIAL PHOTO] .....	64

• [PIN HOLE] .....	65
• [FILM GRAIN] .....	65
Motion Picture Mode .....	66
Taking a picture with Face Recognition function .....	67
• Face Recognition functions .....	67
• Face settings .....	68
Useful Functions at Travel Destinations .....	70
• Recording which Day of the Vacation You Take the Picture .....	70
• Recording Dates/Times at Overseas Travel Destinations (World Time) .....	72
Using the [REC] Mode Menu .....	73
• [PICTURE SIZE] .....	73
• [QUALITY] .....	74
• [ASPECT RATIO] .....	74
• [INTELLIGENT ISO] .....	75
• [SENSITIVITY] .....	75
• [ISO LIMIT SET] .....	75
• [WHITE BALANCE] .....	76
• [FACE RECOG.] .....	77
• [AF MODE] .....	78
• [QUICK AF] .....	79
• [METERING MODE] .....	79
• [I.EXPOSURE] .....	80
• [BURST] .....	80
• [DIGITAL ZOOM] .....	81
• [COLOR EFFECT] .....	81
• [PICT.ADJ.] .....	81
• [STABILIZER] .....	82
• [MIN. SHTR SPEED] .....	82
• [AUDIO REC.] .....	83
• [AF ASSIST LAMP] .....	83
• [CLOCK SET] .....	83

## Advanced (Playback)

Playing Back Pictures in Sequence (Slide Show) .....	84
Displaying Multiple Pictures ([MULTI PLAYBACK]) .....	86
Displaying Pictures by Recording Date ([CALENDAR]) .....	87
Playing Back Pictures on the Dual Display ([DUAL PLAY]) .....	88
Selecting Pictures and Playing them Back ([CATEGORY PLAY]/[FAVORITE PLAY]) .....	89
• [CATEGORY PLAY] .....	89
• [FAVORITE PLAY] .....	90
Organizing pictures ([EASY ORG.]) .....	90
• [FAVORITE] .....	91
• [EDIT] .....	92
• [DELETE] .....	98

Playing Back Motion Pictures/ Pictures with Audio .....	98
• Motion pictures .....	98
• Pictures with audio .....	99
Using the [PLAYBACK] mode menu .....	100
• [EDIT] .....	100
• [ROTATE DISP.] .....	100
• [PRINT SET] .....	100
• [AUDIO DUB.] .....	102
• [FACE RECOG.] .....	102
• [COPY] .....	103

## Connecting to other equipment

Connecting to a PC .....	104
Printing the Pictures .....	106
• Selecting a single picture and printing it .....	107
• Selecting multiple pictures and printing them .....	107
• Print Settings .....	108
Playing Back Pictures on a TV Screen .....	110
• Playing back pictures using the AV cable (supplied) .....	110
• Playing back pictures on a TV with an SD Memory Card slot .....	110
• Playing back on the TV with component socket .....	111

## Others

Screen Display .....	112
Cautions for Use .....	114
Message Display .....	117
Troubleshooting .....	119
Number of Recordable Pictures and Available Recording Time .....	127
Specifications .....	130
Digital Camera Accessory System .....	134
Digital Camera Accessory Order Form (For USA and Puerto Rico Customers) .....	135
Request for Service Notice (For USA and Puerto Rico Only) .....	136
Limited Warranty (For USA and Puerto Rico Only) .....	137
Customer Services Directory (United States and Puerto Rico) .....	139
Précautions à prendre (pour le Canada) .....	140
Index .....	142

## Quick Guide

This is an overview of how to record and play back pictures with the camera. For each step, be sure to refer to the pages indicated in brackets.

### 1 Charge the battery. (P14)

- The battery is not charged when the camera is shipped. Charge the battery before use.

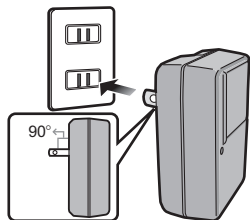

### 2 Insert the battery and the card. (P16)

- When you do not use the card, you can record or play back pictures on the built-in memory. (P18) Refer to P18 when you use a card.

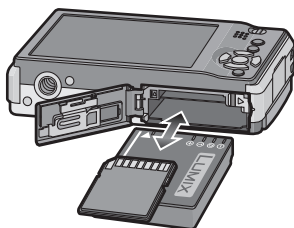

### 3 Turn the camera on to take pictures.

- 1 Slide the [REC]/[PLAYBACK] selector switch to [iA/📷].
- 2 Press the shutter button to take pictures. (P29)

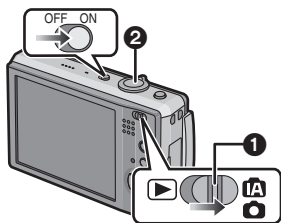

### 4 Play back the pictures.

- 1 Slide the [REC]/[PLAYBACK] selector switch to [▶].
- 2 Select the picture you want to view. (P37)

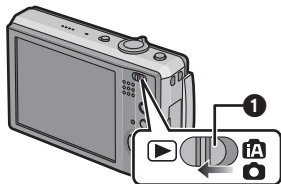



## Standard Accessories

Check that all the accessories are included before using the camera.

- 1 Battery Pack  
(Indicated as **battery** in the text)  
Charge the battery before use.
- 2 Battery Charger  
(Indicated as **charger** in the text)
- 3 USB Connection Cable
- 4 AV Cable
- 5 CD-ROM
  - Software:  
Use it to install the software to your PC.
- 6 Hand Strap
- 7 Battery Case
- 8 Stylus pen







- SD Memory Card, SDHC Memory Card and MultiMediaCard are indicated as **card** in the text.

- **The card is optional.**

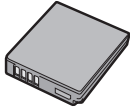
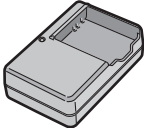
**You can record or play back pictures on the built-in memory when you are not using a card.**

- For information about optional accessories, refer to the "Digital Camera Accessory System". (P134)

- If any accessories are lost, customers in the USA and Puerto Rico should contact Panasonic's parts department at 1 800 833-9626 and customers in Canada should contact 1 800 99-LUMIX (1-800-995-8649) for further information about obtaining replacement parts.

<p>1</p>  <p>DMW-BCF10PP</p>	<p>2</p>  <p>DE-A59B</p>
<p>3</p>  <p>K1HA08AD0003</p>	<p>4</p>  <p>K1HA08CD0020</p>
<p>5</p> 	<p>6</p>  <p>VFC4304</p>
<p>7</p>  <p>VGQ0D56</p>	<p>8</p>  <p>VGQ0C14</p>

## Names of the Components

- 1 Flash (P43)
- 2 Lens (P5, 115)
- 3 Self-timer indicator (P47)/  
AF assist lamp (P83)

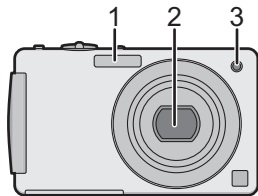

- 4 Touch panel/LCD monitor (P12, 41, 112)
- 5 Status indicator (P17, 25, 29)
- 6 [MENU/SET] button (P19)
- 7 [DISPLAY] button (P41)
- 8 [Q.MENU] (P22)/Delete (P40) button
- 9 [MODE] button (P28)
- 10 [REC]/[PLAYBACK] selector switch (P20)

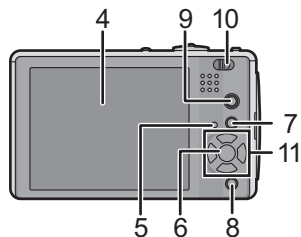

### 11 Cursor buttons

- (A): ▲/Exposure compensation (P53)/  
Flash output adjustment (P45)/Auto  
bracket (P54)/Color bracket (P55)
- (B): ▼/Macro Mode (P46)
- (C): ◀/Self-timer (P47)
- (D): ▶/Flash setting (P43)

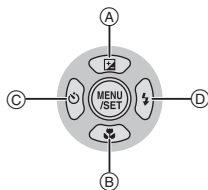

In these operating instructions, the cursor buttons are described as shown in the figure below or described with ▲/▼/◀/▶.  
e.g.: When you press the ▼ (down) button

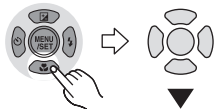

or

Press ▼

- 12 Camera ON/OFF switch (P19)
- 13 Zoom lever (P34)
- 14 Speaker (P98)
- 15 Microphone (P66, 83, 102)
- 16 Shutter button (P29, 66)
- 17 [E.ZOOM] button (P36)

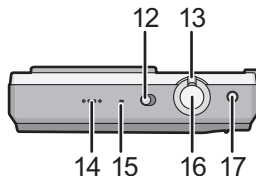

- 18 Hand strap eyelet
  - Be sure to attach the hand strap when using the camera to ensure that you will not drop it.
- 19 Lens barrel
- 20 [COMPONENT OUT] socket (P111)
- 21 [AV OUT/DIGITAL] socket (P104, 106, 110)

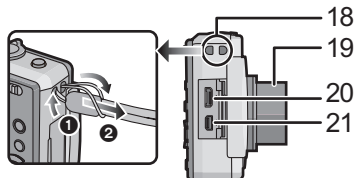

- 22 Tripod receptacle
  - When you use a tripod, make sure the tripod is stable when the camera is attached to it.
- 23 Card/Battery door (P16)
- 24 Release lever (P16)
- 25 DC coupler cover (P17)
  - When using an AC adaptor, ensure that the Panasonic DC coupler (DMW-DCC4; optional) and AC adaptor (DMW-AC5PP; optional) are used. For connection details, refer to P17.

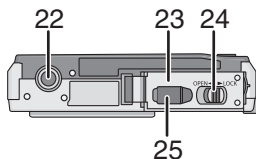

## How to Use the Touch Panel

You can operate by directly touching the LCD monitor (touch panel) with your finger. It is easier to use the stylus pen (supplied) for detailed operation such as title editing or if it is hard to operate with your fingers.

### ■ Touch

To touch and release the touch panel.

It is used to select icon or picture.

- It may not operate properly when multiple icons are touched simultaneously, so try to touch the center of the icon.

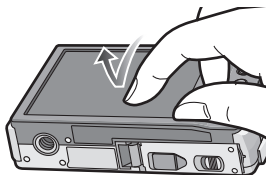

### ■ Drag

A movement performed without releasing the touch panel. It is used to change the range of displayed picture, or switch the screen with the scroll bar.

- If you select the wrong icon, you can drag to the correct icon, and release your finger.

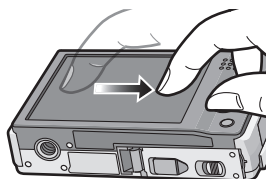

### 🔗 Note

- This touch panel detects pressure. **Touch a little stronger** if you have a commercially available protection sheet affixed.
- If you use a commercially available liquid crystal protection sheet, please follow the instructions that accompany the sheet. (Some liquid crystal protection sheets may impair visibility or operability.)
- Touch panel will not operate if the hand holding the unit is touching the touch panel.
- Do not press on the LCD monitor with hard pointed tips, such as ball point pens.
- Do not operate with your fingernails.
- Wipe the LCD monitor with dry soft cloth when it gets dirty.
- Do not scratch or press the LCD monitor too hard.

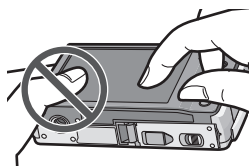

### About the Stylus pen

- Only use the supplied stylus pen.
- Do not place it where small children can reach.
- Do not place the stylus pen on the LCD monitor when storing. LCD monitor may break when the stylus pen is pressed strongly against the LCD monitor.

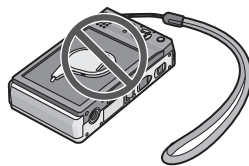

## What can be done by touch operation

Following are examples of what can be done by touch operation.

### When recording

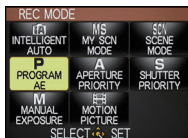

**Select [REC] Mode (P28)**  
**Select Scene Mode (P55)**  
 [REC] Mode can be selected by using the touch panel.

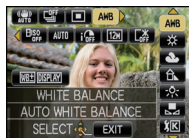

**Quick Menu (P22)**  
 Menu can be set using the touch panel.

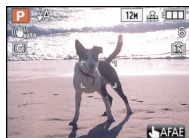

**Touch AF/AE (P48)**  
 It is possible to set the focus and exposure to the subject specified on the touch panel.



**Aperture Value Set (P49, 51)**  
**Shutter Speed Set (P50, 51)**  
**Exposure Compensation (P49, 50)**  
 Setting for aperture value etc. can be set by touching the set bars displayed on the screen.

### When playing back

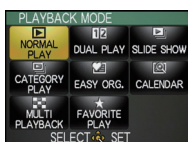

**Select [PLAYBACK] Mode (P38)**  
 [PLAYBACK] Mode can be selected by using the touch panel.

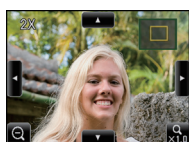

**Picture Playback Touch Zoom (P37)**  
 A picture can be forwarded/rewound or enlarged in playback by touching the screen.



**[EASY ORG.] (P90)**  
 Picture editing can be done by using the touch panel.



**[SLIDE SHOW] (P84)**  
 Setting for slide show can be done by using the touch panel.

### Note

- On the touch operation screen, when a cursor button display (A) appears, it is possible to operate using ▲/▼/◀/▶ of the cursor button.
- Menu items cannot be set with touch operation. Set with the cursor button.

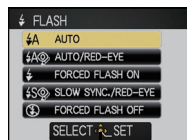

(A)

## Charging the Battery

### ■ About batteries that you can use with this unit

The battery that can be used with this unit is DMW-BCF10PP.

It has been found that counterfeit battery packs which look very similar to the genuine product are made available to purchase in some markets. Some of these battery packs are not adequately protected with internal protection to meet the requirements of appropriate safety standards. There is a possibility that these battery packs may lead to fire or explosion. Please be advised that we are not liable for any accident or failure occurring as a result of use of a counterfeit battery pack. To ensure that safe products are used we would recommend that a genuine Panasonic battery pack is used.

- Use the dedicated charger and battery.
- This unit has a function that can distinguish useable batteries. Exclusive batteries (DMW-BCF10PP) are supported by this function. (Conventional batteries not supported by this function cannot be used.)
- The battery is not charged when the camera is shipped. Charge the battery before use.
- Charge the battery with the charger indoors.
- Charge the battery in a temperature between 10 °C to 35 °C (50 °F to 95 °F). (The battery temperature should also be the same.)

- 1 Attach the battery paying attention to the direction of the battery.**

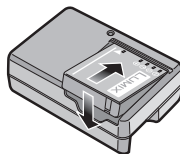

- 2 Connect the charger to the electrical outlet.**

- Charging starts when the [CHARGE] indicator (A) lights green.
- Charging is complete when the [CHARGE] indicator (A) turns off (after approx. 130 min maximum).

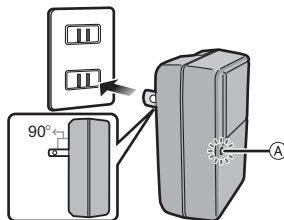

- 3 Detach the battery after charging is completed.**

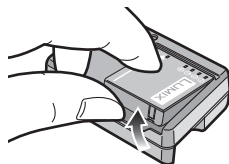

### ■ When the [CHARGE] indicator flashes

- The battery temperature is excessively high or low. The charging time will be longer than normal. Also, charging may not be completed.
- The terminals of the charger or the battery are dirty. In this case, wipe them with a dry cloth.



#### Note

- After charging is completed, be sure to disconnect the power supply device from the electrical outlet.
- The battery becomes warm after use it and during and after charging. The camera also becomes warm during use. This is not a malfunction.
- The battery will become exhausted if left for a long period of time after being charged.
- The battery can be recharged even when it still has some charge left, but it is not recommended that the battery charge be frequently topped up while the battery is fully charged. (The battery has characteristics that will reduce its operating duration and cause the battery to swell up.)
- When the operating time of the camera becomes extremely short even after properly charging the battery, the life of the battery may have expired. Buy a new battery.
- **Do not leave any metal items (such as clips) near the contact areas of the power plug. Otherwise, a fire and/or electric shocks may be caused by short-circuiting or the resulting heat generated.**

## About the Battery (charging/number of recordable pictures)

### ■ Battery indication

The battery indication is displayed on the LCD monitor.

[It does not appear when you use the camera with the AC adaptor (DMW-AC5PP; optional) connected.]



- The indication turns red and blinks if the remaining battery power is exhausted. (The status indicator blinks when the LCD monitor turns off.) Recharge the battery or replace it with a fully charged battery.

### ■ The battery life

<b>Number of recordable pictures</b>	<b>Approx. 350 pictures</b>	By CIPA standard in Program AE Mode
<b>Recording time</b>	<b>Approx. 175 min</b>	

### Recording conditions by CIPA standard

- CIPA is an abbreviation of [Camera & Imaging Products Association].
  - Temperature: 23 °C (73.4 °F)/Humidity: 50% when LCD monitor is on.\*
  - Using a Panasonic SD Memory Card (32 MB).
  - Using the supplied battery.
  - Starting recording 30 seconds after the camera is turned on. (When the optical image stabilizer function is set to [AUTO].)
  - **Recording once every 30 seconds** with full flash every second recording.
  - Rotating the zoom lever from Tele to Wide or vice versa in every recording.
  - Turning the camera off every 10 recordings and leaving it until the temperature of the battery decreases.
- \* The number of recordable pictures decreases in Auto Power LCD Mode and Power LCD Mode. (P23)

**The number of recordable pictures varies depending on the recording interval time. If the recording interval time becomes longer, the number of recordable pictures decreases. [e.g. When recording once every 2 minutes, the number of recordable pictures decreases to about 87.]**

<b>Playback time</b>	<b>Approx. 360 min</b>
----------------------	------------------------

**The number of recordable pictures and playback time** will vary depending on the operating conditions and storing condition of the battery.

## ■ Charging

### Charging time

Approx. 130 min maximum

Charging time and **number of recordable pictures** with the optional battery pack (DMW-BCF10PP) are the same as above.

**The charging time** will vary slightly depending on the status of the battery and the conditions in the charging environment.

When the charging has been completed successfully, the [CHARGE] indicator turns off.

### Note

- The battery may swell and its operating time may become shorter as the number of times it is charged increases. For long term battery use, we recommend you do not frequently charge the battery before it is exhausted.
- The performance of the battery may temporarily deteriorate and the operating time may become shorter in low temperature conditions (e.g. skiing/snowboarding).

## Inserting and Removing the Card (optional)/the Battery

- Check that this unit is turned off.
- We recommend using a Panasonic card.

### 1 Slide the release lever in the direction of the arrow and open the card/battery door.

- Always use genuine Panasonic batteries (DMW-BCF10PP).
- If you use other batteries, we cannot guarantee the quality of this product.

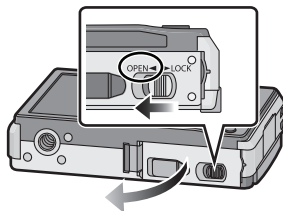

### 2 Battery: Insert until it is locked by the lever <sup>Ⓐ</sup> being careful about the direction you insert it. Pull the lever <sup>Ⓐ</sup> in the direction of the arrow to remove the battery.

**Card:** Push it fully until it clicks, being careful about the direction in which you insert it. To remove the card, push the card until it clicks, then pull the card out upright.

- Ⓐ: Do not touch the connection terminals of the card.
- The card may become damaged if it is not fully inserted.

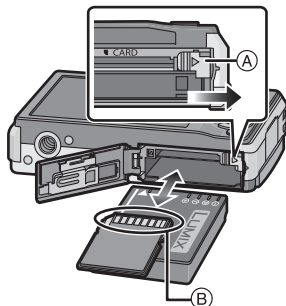



### 3 ①: Close the card/battery door.

### ②: Slide the release lever in the direction of the arrow.

- If the card/battery door cannot be completely closed, remove the card, check its direction and then insert it again.

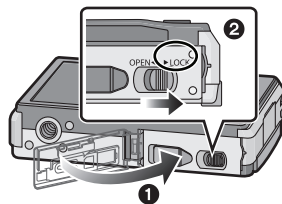

### Note

- Remove the battery after use. Store the removed battery in the battery case (supplied).
- Do not remove the battery until the LCD monitor and the status indicator (green) turn off as the settings on the camera may not be stored properly.
- The supplied battery is designed only for the camera. Do not use it with any other equipment.
- Before removing the card or battery, turn the camera off, and wait until the status indicator has gone off completely. (Otherwise, this unit may no longer operate normally and the card itself may be damaged or the recorded pictures may be lost.)

### ■ Using an AC adaptor (optional) and a DC coupler (optional) instead of the battery

Ensure that the AC adaptor (DMW-AC5PP; optional) and DC coupler (DMW-DCC4; optional) are purchased in a set. Do not use if sold separately.

- ① Open the card/battery door.
- ② Insert the DC coupler, being careful of the direction.
- ③ Close the card/battery door.
  - Ensure that the card/battery door is closed.
- ④ Open the DC coupler cover (A).
- ⑤ Plug the AC adaptor into an electrical outlet.
- ⑥ Connect the AC adaptor (B) to the [DC IN] socket (C) of the DC coupler.

⑦ Align the marks, and insert.

- Ensure that only the AC adaptor and DC coupler for this camera are used. Using any other equipment may cause damage.

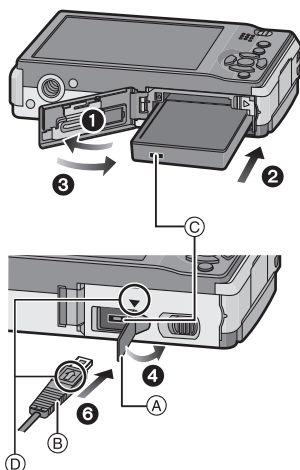



### Note

- Always use a genuine Panasonic AC adaptor (DMW-AC5PP; optional).
- Some tripods cannot be attached when the DC coupler is connected.
- This unit cannot be stood upright when the AC adaptor is connected. When placing it down and operating, we recommend placing it on a soft cloth.
- Make sure to unplug the AC adaptor when you open the card/battery door.
- If the AC adaptor and DC coupler are not necessary, then remove them from the digital camera. Also, please keep the DC coupler cover closed.
- Also read the operating instructions for the AC adaptor and DC coupler.
- For information about optional accessories, refer to the "Digital Camera Accessory System". (P134)

## About the Built-in Memory/the Card

The following operations can be performed using this unit.

- **When a card has not been inserted: Pictures can be recorded in the built-in memory and played back.**
- **When a card has been inserted: Pictures can be recorded on the card and played back.**
- **When using the built-in memory**  
 (access indication\*)
- **When using the card**  
 (access indication\*)



\* The access indication lights red when pictures are being recorded on the built-in memory (or the card).

### Built-in Memory

- **Memory size: Approx. 40 MB**
- **Recordable motion pictures: QVGA (320×240 pixels) only**
- The built-in memory can be used as a temporary storage device when the card being used becomes full.
- You can copy the recorded pictures to a card. (P103)
- The access time for the built-in memory may be longer than the access time for a card.

### Card

The following types of cards can be used with this unit.

(These cards are indicated as **card** in the text.)

Type of card	Characteristics
<b>SD Memory Card (8 MB to 2 GB)</b> (Formatted using the FAT12 or FAT16 format in compliance with the SD standard)	<ul style="list-style-type: none"> <li>• Fast recording and writing speed.</li> <li>• Write-Protect switch (A) provided. (When this switch is set to the [LOCK] position, no further data writing, deletion or formatting is possible. The ability to write, delete and format data is restored when the switch is returned to its original position.)</li> </ul> 
<b>SDHC Memory Card (4 GB to 32 GB)*</b> (Formatted using the FAT32 format in compliance with the SD standard)	
<b>MultiMediaCard</b>	<ul style="list-style-type: none"> <li>• Still pictures only.</li> </ul>

\* The SDHC Memory Card is a memory card standard decided by the SD Association in 2006 for high capacity memory cards more than 2 GB.

\* You can use an SDHC Memory Card in equipment that is compatible with SDHC Memory Cards however you cannot use an SDHC Memory Card in equipment that is only compatible with SD Memory Cards. (Always read the operating instructions for the equipment being used.)

• You can only use cards with SDHC logo (indicating compliance with the SD standard) if using cards with 4 GB or more capacity.

• Please confirm the latest information on the following website.

<http://panasonic.co.jp/pavc/global/cs>

(This Site is English only.)

### Note

- Do not turn this unit off, remove its battery or card, or disconnect the AC adaptor (DMW-AC5PP; optional) when the access indication is lit [when pictures are being written, read or deleted, or the built-in memory or the card is being formatted (P27)]. Furthermore, do not subject the camera to vibration, impact or static electricity. The card or the data on the card may be damaged, and this unit may no longer operate normally. If operation fails due to vibration, impact or static electricity, perform the operation again.
- The data on the built-in memory or the card may be damaged or lost due to electromagnetic waves, static electricity or breakdown of the camera or the card. We recommend storing important data on a PC etc.
- Do not format the card on your PC or other equipment. Format it on the camera only to ensure proper operation. (P27)
- Keep the Memory Card out of reach of children to prevent swallowing.

## Setting Date/Time (Clock Set)

- The clock is not set when the camera is shipped.

### 1 Turn the camera on.

- The [PLEASE SET THE CLOCK] message appears. (This message does not appear in [PLAYBACK] Mode.)

- (A) [MENU/SET] button
- (B) Cursor buttons

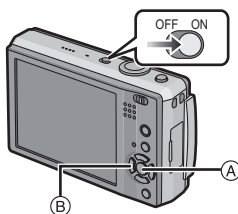

### 2 Press [MENU/SET].



### 3 Press ◀/▶ to select the items (year, month, day, hour, minute, display sequence or time display format), and press ▲/▼ to set.

- (A): Time at the home area
- (B): Time at the travel destination (P72)
- ⌫: Cancel without setting the clock.

- Select either [24HRS] or [AM/PM] for the time display format.
- AM/PM is displayed when [AM/PM] is selected.
- When [AM/PM] is selected as the time display format, midnight is displayed as AM 12:00 and noon is displayed as PM 12:00. This display format is common in North America and elsewhere.

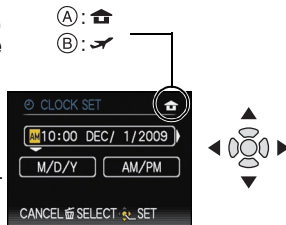

### 4 Press [MENU/SET] to set.

- After completing the clock settings, turn the camera off. Then turn the camera back on, switch to Recording Mode, and check that the display reflects the settings that were performed.
- When [MENU/SET] has been pressed to complete the settings without the clock having been set, set the clock correctly by following the "Changing the clock setting" procedure below.

## Changing the clock setting

Select **[CLOCK SET]** in the **[REC]** or **[SETUP]** menu, and press **▶**. (P21)

- It can be changed in steps **3** and **4** to set the clock.
- **The clock setting is maintained for 3 months using the built-in clock battery even without the battery.** (Leave the charged battery in the unit for 24 hours to charge the built-in battery.)

### Note

- The clock is displayed when **[DISPLAY]** is pressed several times during recording.
- You can set the year from 2000 to 2099.
- If the clock is not set, the correct date cannot be printed when you stamp the date on the pictures with **[TEXT STAMP]** (P96) or order a photo studio to print the pictures.
- If the clock is set, the correct date can be printed even if the date is not displayed on the screen of the camera.



## Setting the Menu

The camera comes with menus that allow you to set the settings for taking pictures and playing them back just as you like and menus that enable you to have more fun with the camera and use it more easily.

In particular, the **[SETUP]** menu contains some important settings relating to the camera's clock and power. Check the settings of this menu before proceeding to use the camera.

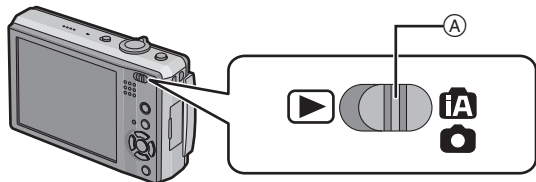
(A) **[REC]/[PLAYBACK]** selector switch



▶ <b>[PLAYBACK]</b> Mode menu (P100 to 103)	📷 <b>[REC]</b> Mode menu (P73 to 83)
<ul style="list-style-type: none"> <li>• This menu lets you copy the pictures, settings convenient when printing (DPOF), etc., of recorded pictures.</li> </ul> 	<ul style="list-style-type: none"> <li>• This menu lets you set the coloring, sensitivity, aspect ratio, number of pixels and other aspects of the pictures you are recording.</li> </ul> 

### ⚙️ **[SETUP]** menu (P23 to 27)

- This menu lets you perform the clock settings, select the operating beep tone settings and set other settings which make it easier for you to operate the camera.
- The **[SETUP]** menu can be set from either the **[REC MODE]** or **[PLAYBACK MODE]**.



### Note

Due to the camera's specifications, it may not be possible to set some of the functions. Some functions may not work in some of the conditions under which the camera is used.

## Setting menu items

This section describes how to select the program AE Mode settings, and the same setting can be used for the [PLAYBACK] menu and [SETUP] menu as well.

Example: Setting [AF MODE] from [ ] to [ ] in the program AE Mode

### 1 Turn the camera on.

- (A) [MENU/SET] button
- (B) [REC]/[PLAYBACK] selector switch
- (C) [MODE] button

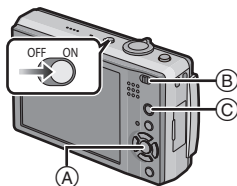

### 2 Slide the [REC]/[PLAYBACK] selector switch to [P/A], and then press [MODE].

- When selecting the [PLAYBACK] Mode menu settings, set the [REC]/[PLAYBACK] selector switch to [▶], and proceed to step 4.

### 3 Touch [PROGRAM AE].

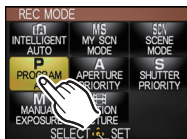

### 4 Press [MENU/SET] to display the menu.

- Menu item cannot be set with touch operation. Set with the cursor buttons.
- You can switch menu screens from any menu item by rotating the zoom lever.



## Switching to the [SETUP] menu

### 1 Press ◀.



### 2 Press ▼ to select the [SETUP] menu icon [⌂].

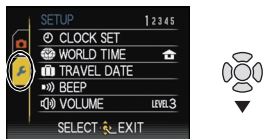

### 3 Press ▶.

- Select a menu item next and set it.

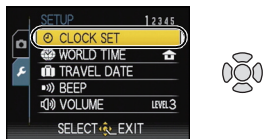

**5 Press ▲/▼ to select [AF MODE].**

- Select the item at the very bottom, and press ▼ to move to the second screen.

**6 Press ►.**

- Depending on the item, its setting may not appear or it may be displayed in a different way.

**7 Press ▲/▼ to select [AMB].****8 Press [MENU/SET] to set.****9 Press [MENU/SET] to close the menu.**

### Using the quick menu

By using the quick menu, some of the menu settings can be easily found.

- Some of the menu items cannot be set by the Modes.
- Advanced settings for the following items can be performed by pressing [DISPLAY].  
– [WHITE BALANCE] (P76)/[STABILIZER] (P82)

**1 Press and hold [Q.MENU] when recording.****2 Touch the menu item and the setup.**

- (A) Item
- (B) Settings
- (C) The items to be set and the settings are displayed.

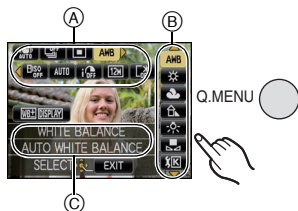

Perform these settings if you need to.

## About the Setup Menu

[CLOCK SET], [AUTO REVIEW] and [ECONOMY] are important items. Check their settings before using them.

• In the Intelligent Auto Mode, only [CLOCK SET], [WORLD TIME], [BEEP] and [LANGUAGE] can be set. **For details on how to select the [SETUP] menu settings, refer to P21.**

 [CLOCK SET]	Setting Date/Time.
---	--------------------

• Refer to P19 for details.

 [WORLD TIME]	Set the time in your home area and travel destination.
	✈ [DESTINATION]: Travel destination area  🏠 [HOME]: Your home area

• Refer to P72 for details.

 [TRAVEL DATE]	Set the departure date and the return date of the vacation.	
	[TRAVEL SETUP] [OFF]/[SET]	[LOCATION] [OFF]/[SET]

• Refer to P70 for details.

))) [BEEP]	This allows you to set the beep and shutter sound.	
	))) [BEEP LEVEL]: [🔇] (Muted) [🔊] (Low) [🔊] (High)	🎵 [SHUTTER VOL.]: [🔇] (Muted) [🔊] (Low) [🔊] (High)
	🎵 [BEEP TONE]: [🎵1]/[🎵2]/[🎵3]	🎵 [SHUTTER TONE]: [🎵1]/[🎵2]/[🎵3]

 [VOLUME]	Adjust the volume of the speaker to any of 7 levels.
---	--

• When you connect the camera to a TV, the volume of the TV speakers does not change.

 [MONITOR]	Adjust the brightness of the LCD monitor in 7 steps.
---	--

 [LCD MODE]	These menu settings make it easier to see the LCD monitor when you are in bright places.
	[OFF] [A*] [AUTO POWER LCD]: The brightness is adjusted automatically depending on how bright it is around the camera. [□*] [POWER LCD]: The LCD monitor becomes brighter and easier to see even when taking pictures outdoors.

- The brightness of the pictures displayed on the LCD monitor is increased so some subjects may appear different from actuality on the LCD monitor. However, this does not affect the recorded pictures.
- The LCD monitor automatically returns to normal brightness after 30 seconds when recording in Power LCD Mode. Press any button to make the LCD monitor bright again.
- If the screen is difficult to see because of light from the sun etc. shining on it, use your hand or another object to block the light.
- The number of recordable pictures decreases in Auto Power LCD Mode and Power LCD Mode.
- [AUTO POWER LCD] cannot be selected in Playback Mode.
- [LCD MODE] cannot be used when the component cable is connected.

A/A [DISPLAY SIZE]	Change the display size of some icons and menu screens.	
	[STANDARD]/[LARGE]	

GUIDE LINE	Set the pattern of the guidelines displayed when taking pictures. You can also set whether or not to have the recording information displayed when the guidelines are displayed. (P41)	
	[REC. INFO.]: [OFF]/[ON]	[PATTERN]: [ ]/[ ]

- The [PATTERN] setting is fixed to [ ] in the Intelligent Auto Mode.

HISTOGRAM	This allows you to set either to display or not display the histogram. (P42)	
	[OFF]/[ON]	

HL [HIGHLIGHT]	When the auto review function is activated, white saturated areas appear blinking in black and white.	
	[OFF]/[ON]	

- If there are any white saturated areas, we recommend compensating the exposure towards negative (P53) referring to the histogram (P42) and then taking the picture again. It may result in a better quality picture.
- There may be white saturated areas if the distance between the camera and the subject is too close when taking pictures with the flash. If [HIGHLIGHT] is set to [ON] in this case, the area directly illuminated by the photo flash will become white saturated and appear blinking in black and white.

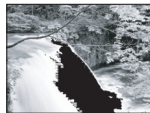

[ON]



[OFF]

















ECO [ECONOMY]	The camera is automatically turned off if the camera has not been used for the time selected on the setting. Also, it will turn off the LCD monitor automatically when not in use to prevent discharge of the battery.
	 <b>[POWER SAVE]:</b> The camera is automatically turned off if the camera has not been used for the time selected on the setting. <b>[OFF]/[2MIN.]/[5MIN.]/[10MIN.]</b>
	 <b>[AUTO LCD OFF]:</b> When taking pictures, the LCD monitor is automatically turned off if the camera has not been used for the time selected on the setting. <b>[OFF]/[15SEC.]/[30SEC.]</b>

- Press the shutter button halfway or turn the camera off and on to cancel [POWER SAVE].
- [POWER SAVE] is set to [5MIN.] in the Intelligent Auto Mode.
- [POWER SAVE] is fixed to [2MIN.] when [AUTO LCD OFF] is set to [15SEC.] or [30SEC.].
- The status indicator lights while the LCD monitor is turned off. Press any button to turn on the LCD monitor again.
- [AUTO LCD OFF] does not work while operating menu or touch zoom.
- [POWER SAVE] cannot be used in the following cases.
  - When using the AC adaptor
  - When connecting to a PC or a printer
  - When recording or playing back motion pictures
  - During a slide show
  - [AUTO DEMO]
- [AUTO LCD OFF] cannot be used in the following cases.
  - When using the AC adaptor
  - When connecting to a PC or a printer
  - While the self-timer is set
  - While recording motion pictures
  - While the menu screen is displayed
  - [AUTO DEMO]

 <b>[AUTO REVIEW]</b>	Set the length of time that the picture is displayed after taking it.
	<b>[OFF]</b>
	<b>[1SEC.]</b>
	<b>[2SEC.]</b>
	<b>[HOLD]:</b> The pictures are displayed until any one of the buttons is pressed.
	<b>[ZOOM]:</b> The picture is displayed for 1 second and then enlarged 4× and displayed for 1 more second.

- The auto review function is activated regardless of its setting when using auto bracket (P54)/color bracket (P55), [HI-SPEED BURST] (P62) and [FLASH BURST] (P62) in Scene Mode, Burst Mode (P80) and when recording still pictures with audio (P83). (The pictures cannot be enlarged.)
- In Intelligent Auto Mode, the auto review function is fixed to [2SEC.].
- [AUTO REVIEW] does not work in Motion Picture Mode.

 <b>[NO.RESET]</b>	Reset the file number of the next recording to 0001.
<ul style="list-style-type: none"> <li>• The folder number is updated and the file number starts from 0001. (P105)</li> <li>• A folder number between 100 and 999 can be assigned. When the folder number reaches 999, the number cannot be reset. We recommend formatting the card (P27) after saving the data on a PC or elsewhere.</li> <li>• To reset the folder number to 100, format the built-in memory or the card first and then use this function to reset the file number. A reset screen for the folder number will then appear. Select [YES] to reset the folder number.</li> </ul>	
 <b>[RESET]</b>	The [REC] or [SETUP] menu settings are reset to the initial settings.
<ul style="list-style-type: none"> <li>• When the [RESET] setting is selected during recording, the operation that resets the lens is also performed at the same time. You will hear the sound of the lens operating but this is normal and not indicative of malfunctioning.</li> <li>• When the [REC] Mode settings are reset, data registered with [FACE RECOG.] will be also reset, too.</li> <li>• When [SETUP] menu settings are reset, the following settings are also reset. In addition, [ROTATE DISP.] (P100) in [PLAYBACK] Mode menu is set to [ON]. <ul style="list-style-type: none"> <li>– The birthday and name settings for [BABY1]/[BABY2] (P60) and [PET] (P61) in Scene Mode.</li> <li>– The settings of [TRAVEL DATE] (P70) (departure date, return date, location)</li> <li>– The [WORLD TIME] (P72) setting.</li> </ul> </li> <li>• The folder number and the clock setting are not changed.</li> </ul>	
 <b>[USB MODE]</b>	<p>Select the USB communication system after or before connecting the camera to your PC or your printer with the USB connection cable (supplied).</p> <p> <b>[SELECT ON CONNECTION]:</b> Select either [PC] or [PictBridge(PTP)] if you connected the camera to a PC or a printer supporting PictBridge.</p> <p> <b>[PictBridge(PTP)]:</b> Set after or before connecting to a printer supporting PictBridge.</p> <p> <b>[PC]:</b> Set after or before connecting to a PC.</p>
<ul style="list-style-type: none"> <li>• When [PC] is selected, the camera is connected via the "USB Mass Storage" communication system.</li> <li>• When [PictBridge(PTP)] is selected, the camera is connected via the "PTP (Picture Transfer Protocol)" communication system.</li> </ul>	
 <b>[TV ASPECT]</b>	<p>Set to match the type of TV. (Playback Mode only)</p> <p> <b>[16:9]:</b> When connecting to a 16:9 screen TV.</p> <p> <b>[4:3]:</b> When connecting to a 4:3 screen TV.</p>
<ul style="list-style-type: none"> <li>• This will work when the AV cable is connected.</li> </ul>	
 <b>[TOUCH GUIDE]</b>	<p>Set the guide screen including Touch AF/AE or Touch Zoom, choosing whether or not to display it.</p> <p><b>[OFF]/[ON]</b></p>
 <b>[VERSION DISP.]</b>	<p>It is possible to check which version of firmware is on the camera.</p> <div data-bbox="770 1224 969 1362" style="border: 1px solid black; padding: 5px;">  </div>

 <b>[FORMAT]</b>	The built-in memory or card is formatted. <b>Formatting irretrievably deletes all the data so check the data carefully before formatting.</b>
--	---

- Use a battery with sufficient battery power or the AC adaptor (DMW-AC5PP; optional) and DC coupler (DMW-DCC4; optional) when formatting. Do not turn the camera off during formatting.
- If a card has been inserted, only the card is formatted. To format the built-in memory, remove the card.
- If the card has been formatted on a PC or other equipment, format it on the camera again.
- It may take longer to format the built-in memory than the card.
- If the built-in memory or the card cannot be formatted, consult your nearest Service Center.

For USA and Puerto Rico assistance, please call:  
1-800-211-PANA(7262) or, contact us via the web at:  
<http://www.panasonic.com/contactinfo>

For Canadian assistance, please call:  
1-800-99-LUMIX (1-800-995-8649) or  
send e-mail to: [lumixconclerge@ca.panasonic.com](mailto:lumixconclerge@ca.panasonic.com)

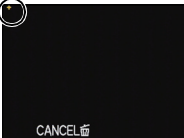
 <b>[CALIBRATION]</b>	<p>Adjust the position of the touch panel if a different item gets selected from what you touched or touch operation does not respond.</p> <ol style="list-style-type: none"> <li><b>1 Press [MENU/SET].</b></li> <li><b>2 Touch the orange [+] mark displayed on the screen in order with the stylus pen (supplied) (5 places).</b> <ul style="list-style-type: none"> <li>• A message is displayed once the position is set.</li> </ul> </li> <li><b>3 Press [MENU/SET] to finish.</b></li> </ol> 
--	---

- Calibration is not done if correct position is not touched. Touch the [+] mark again.

 <b>[LANGUAGE]</b>	<p>Set the language displayed on the screen.</p> <p><b>[ENGLISH]/[DEUTSCH]*/[FRANÇAIS]*/[ESPAÑOL]/ [ITALIANO]*/[繁體中文]*/[日本語]*</b></p> <p>* Not displayed on DMC-FX580P</p>
---	--

- If you set a different language by mistake, select  from the menu icons to set the desired language.

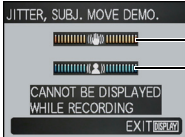
<b>DEMO [DEMO MODE]</b>	<p>The camera automatically detects jitter and the movement of the subject and displays these on the indicator. ([JITTER, SUBJ. MOVE DEMO.]) The camera's features are displayed as slide shows. ([AUTO DEMO])</p> <p><b>[JITTER, SUBJ. MOVE DEMO.]</b></p> <p>(A) Jitter detection demonstration (B) Movement detection demonstration</p>  <p><b>[AUTO DEMO]:</b> <b>[OFF]</b> <b>[ON]</b></p>
-------------------------	--

- In Playback Mode, [JITTER, SUBJ. MOVE DEMO.] cannot be displayed.
- Press [DISPLAY] to close [JITTER, SUBJ. MOVE DEMO.]. Press [MENU/SET] to close [AUTO DEMO].
- [JITTER, SUBJ. MOVE DEMO.] is an approximation.
- [AUTO DEMO] has no TV output capability even when it is in Playback Mode.

## Mode switching

## Selecting the [REC] Mode

When the [REC] Mode is selected, the camera can be set to the Intelligent Auto Mode in which the optimal settings are established in line with the subject to be recorded and the recording conditions, or to the Scene Mode which enables you to take pictures that match the scene being recorded.

### 1 Turn the camera on.

- (A) [REC]/[PLAYBACK] selector switch
- (B) [MODE] button

### 2 Slide the [REC]/[PLAYBACK] selector switch to [iA/O].

### 3 Press [MODE].

### 4 Touch the Mode.

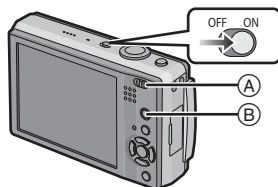

#### ■ List of [REC] Modes

##### **iA** Intelligent Auto Mode (P29)

The subjects are recorded using settings automatically selected by the camera.

##### **P** Program AE Mode (P32)

The subjects are recorded using your own settings.

##### **A** Aperture-Priority AE Mode (P49)

The subjects are recorded with set aperture.

##### **S** Shutter-Priority AE Mode (P50)

The subjects are recorded with set shutter speed.

##### **M** Manual Exposure Mode (P51)

The subjects are recorded with set aperture and shutter speed.

##### **MS** My Scene Mode (P55)

Pictures are taken using previously registered recording scenes.

##### **SCN** Scene Mode (P55)

This allows you to take pictures that match the scene being recorded.

##### **MOTION PICTURE** Motion Picture Mode (P66)

This mode allows you to record motion pictures with audio.

#### **Note**

- When the mode has been switched from [PLAYBACK] Mode to [REC] Mode, the previously set [REC] Mode will be set.

[REC] Mode: **iA**

## Taking pictures using the automatic function

**iA**: Intelligent Auto Mode

The camera will set the most appropriate settings to match the subject and the recording conditions so we recommend this mode for beginners or those who want to leave the settings to the camera and take pictures easily.

- The following functions are activated automatically.
  - Scene detection/[STABILIZER]/[INTELLIGENT ISO]/Face detection/[QUICK AF]/[I.EXPOSURE]/Digital Red-eye Correction/Backlight Compensation
- The status indicator **3** lights when you turn this unit on **2**. (It turns off after about 1 second.)
  - 1**: Shutter button

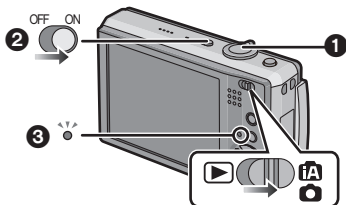

- Slide the [REC]/[PLAYBACK] selector switch to **[iA/📷]**, and then press [MODE].

- Touch [INTELLIGENT AUTO].



- Hold this unit gently with both hands, keep your arms still at your side and stand with your feet slightly apart.

- A** Flash
- B** AF assist lamp

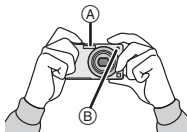

- Press the shutter button halfway to focus.

- The focus indication **1** (green) lights when the subject is focused.
- The AF area **2** is displayed around the subject's face by the face detection function. In other cases, it is displayed at the point on the subject which is in focus.
- The focus range is 5 cm (0.17 feet) (Wide)/1 m (3.28 feet) (Tele) to ∞.
- The maximum close-up distance (the shortest distance at which the subject can be taken) differs depending on the zoom magnification.

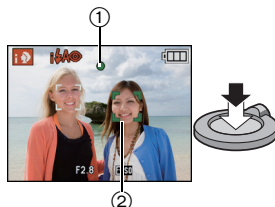



## 5 Press the shutter button fully (push it in further), and take the picture.

- The access indication (P18) lights red when pictures are being recorded on the built-in memory (or the card).

- When taking pictures using the flash (P43)
- When taking pictures using the zoom (P34)
- When taking pictures using Touch AF/AE (P48)

### Note

- Be careful not to move the camera when you press the shutter button.
- Do not cover the flash or the AF assist lamp with your fingers or other objects.
- Do not touch the front of the lens.

## Scene detection

When the camera identifies the optimum scene, the icon of the scene concerned is displayed in blue for 2 seconds, after which its color changes to the usual red.

	[i- PORTRAIT]	
	[i- SCENERY]	
	[i- MACRO]	
	[i- NIGHT PORTRAIT]	• Only when [A] is selected
	[i- NIGHT SCENERY]	• Only when [S] is selected
	[i- BABY]*	

- [iA] is set if none of the scenes are applicable, and the standard settings are set.
- If a tripod is used, for instance, and the camera has judged that camera shake is minimal when the Scene Mode has been identified as [iS], the shutter speed will be set to a maximum of 8 seconds. Take care not to move the camera while taking pictures.
- Most appropriate scene is selected for the touched subject during Touch AF/AE (P48).
- When [FACE RECOG.] is set to [ON], and the face similar to the registered face is detected, [R] is displayed in the top right of [iP], [iS] and [iN].
- \* When [FACE RECOG.] is set to [ON], [iB] will be displayed for birthdays of registered faces already set only when the face of a person 3 years old or younger is detected.

### Face detection

When [iP], [iS] or [iN] is selected, the camera automatically detects a person's face, and it will adjust the focus and exposure (P78).

### Note

- Due to conditions such as the ones below, a different scene may be identified for the same subject.
  - Subject conditions: When the face is bright or dark, The size of the subject, The distance to the subject, The contrast of the subject, When the subject is moving, When zoom is used
  - Recording conditions: Sunset, Sunrise, Under low brightness conditions, When the camera is shaken
- For best results, it is recommended that you take pictures in the appropriate Recording Mode.



### The Backlight Compensation

Backlight refers to light which comes from the back of a subject.

In this case, the subject will become dark, so this function compensates the backlight by brightening the whole picture automatically.

## Face Recognition

Face of the person that is taken often can be registered along with information such as name and birthday.

When a picture is taken with [FACE RECOG.] turned [ON], it will search for the face similar to the registered face, setting the focus and exposure preferentially. The camera will also remember the face during the face recognition, and detect the face that the picture is taken for many times automatically, displaying the face recognition registration screen. (P67)

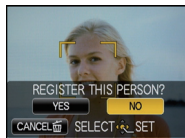

### Note

- [FACE RECOG.] will find a face similar to the registered face, and does not guarantee secure recognition of a person.
- Faces with similar distinctive features such as those of parents and children or siblings may not be correctly recognized.
- Face Recognition may take more time to select and recognize distinctive facial features than regular face detection.

## About the flash

- When [iA] is selected, [iA], [iA] or [iS] is set depending on the type of subject and brightness.
- When [iA] or [iS] is set, digital red-eye correction (P44) is enabled, and the flash is activated twice.

## Settings in Intelligent Auto Mode

- Only the following functions can be set in this mode.

### [REC] Mode menu

– [PICTURE SIZE]\* (P73)/[BURST] (P80)/[COLOR EFFECT]\* (P81)/[FACE RECOG.] (P67)

- \* The settings which can be selected are different from when other [REC] Modes are used.

### [SETUP] menu

– [CLOCK SET]/[WORLD TIME]/[BEEP]/[LANGUAGE]

- The settings of the following items are fixed.

Item	Settings
[GUIDE LINE] (P24)	([REC. INFO.]: [OFF])
[ECONOMY] ([POWER SAVE]) (P25)	[5MIN.]
[AUTO REVIEW] (P25)	[2SEC.]
Flash (P43)	
Self-timer (P47)	10 seconds/off
[QUALITY] (P74)	
[INTELLIGENT ISO] (P75)	ISO MAX 1600
[WHITE BALANCE] (P76)	[AWB]
[METERING MODE] (P79)	
[AF MODE] (P78)	(Set to  when a face cannot be detected)
[QUICK AF] (P79)	[ON]
[I.EXPOSURE] (P80)	[STANDARD]
[STABILIZER] (P82)	[AUTO]
[AF ASSIST LAMP] (P83)	[ON]

- The following functions cannot be used.
  - [AUTO LCD OFF]/[EXPOSURE]/[AUTO BRACKET]/[COLOR BRACKET]/flash output adjustment/White balance fine adjustment/[DIGITAL ZOOM]/[PICT.ADJ.]/[MIN. SHTR SPEED]/[AUDIO REC.]/[HISTOGRAM]
- The other items on the [SETUP] menu can be set in the mode such as the Program AE Mode. What is set will be reflected in the Intelligent Auto Mode.

[REC] Mode: **P**

## Taking pictures with your favorite settings

(**P**: Program AE Mode)

The camera automatically sets the shutter speed and the aperture value according to the brightness of the subject.

You can take pictures with greater freedom by changing various settings in [REC] menu.

- Slide the [REC]/[PLAYBACK] selector switch to , and then press [MODE].

- (A) [MODE] button  
(B) [REC]/[PLAYBACK] selector switch

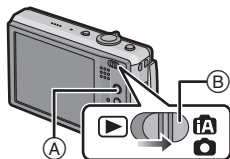

- Touch [PROGRAM AE].

- To change the setting while taking pictures, refer to "Using the [REC] Mode Menu" (P73).

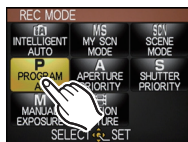



**3** Aim the AF area at the point you want to focus on.

**4** Press the shutter button halfway to focus.

- The focus indication (green) lights when the subject is focused.
- The focus range is 50 cm (1.64 feet) (Wide)/1 m (3.28 feet) (Tele) to ∞.
- If pictures are to be taken at an even closer range, refer to "Taking Close-up Pictures" (P46).



**5** Press the halfway pressed shutter button fully to take a picture.

- The access indication lights (P18) red when pictures are being recorded on the built-in memory (or the card).



■ To adjust the exposure and take pictures at times when the image appears too dark (P53)

■ To adjust the colors and take pictures at times when the image appears too red (P76)

## Focusing

Aim the AF area at the subject, and then press the shutter button halfway.

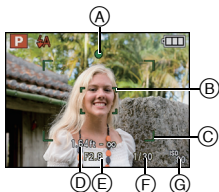

Focus	When the subject is focused	When the subject is not focused
Focus indication	On	Blinks
AF area	White → Green	White → Red
Sound	Beeps 2 times	Beeps 4 times

(A) Focus indication

(B) AF area (normal)

(C) AF area (when using the digital zoom or when it is dark)

(D) Focus range

(E) Aperture value\*

(F) Shutter speed\*

(G) ISO sensitivity



\* If correct exposure cannot be achieved, it will be displayed in red.  
(However, it will not be displayed in red when the flash is used.)

**When the subject is not in focus (such as when it is not in the center of the composition of the picture you want to take)**

- 1 Aim the AF area at the subject, and then **press the shutter button halfway** to fix the focus and exposure.
- 2 **Press and hold the shutter button halfway** while moving the camera as you compose the picture.



## ■ Types of zooms

Feature	Optical zoom	Extended optical zoom (EZ)	Digital zoom
Maximum magnification	5×	9.8×*	20× [including optical zoom 5×] 39.1× [including extended optical zoom 9.8×]
Picture quality	No deterioration	No deterioration	The higher the magnification level, the greater the deterioration.
Conditions	None	[PICTURE SIZE] with <b>[EZ]</b> (P73) is selected.	[DIGITAL ZOOM] (P81) on the [REC] menu is set to [ON].
Screen display		 A <b>[EZ]</b> is displayed.	 B The digital zoom range is displayed.

- When using the zoom function, an estimate of the focus range will appear in conjunction with the zoom display bar. (Example: 0.5 m (1.64 ft.) –∞)

\*The magnification level differs depending on [PICTURE SIZE] and [ASPECT RATIO] setting.

### ■ Extended optical zoom mechanism

When you set the picture size to **[3M]** (3 million pixels), the 12M (12.1 million pixels) CCD area is cropped to the center 3M (3 million pixels) area, allowing a picture with a higher zoom effect.

### ● Note

- The digital zoom cannot be set when **[IA]** has been selected.
- The indicated zoom magnification is an approximation.
- “EZ” is an abbreviation of “Extended Optical Zoom”.
- The optical zoom is set to Wide (1×) when the camera is turned on.
- If you use the zoom function after focusing on the subject, focus on the subject again.
- The lens barrel extends or retracts according to the zoom position. Take care not to interrupt the motion of the lens barrel while the zoom lever is rotated.
- When using the digital zoom, [STABILIZER] may not be effective.
- When using the digital zoom, we recommend using a tripod and the self-timer (P47) for taking pictures.
- The extended optical zoom cannot be used in the following cases.
  - In Macro Zoom Mode
  - In [TRANSFORM], [HIGH SENS.], [HI-SPEED BURST], [FLASH BURST], [PIN HOLE] or [FILM GRAIN] in Scene Mode
  - In Motion Picture Mode
- [DIGITAL ZOOM] cannot be used in the following cases.
  - In [TRANSFORM], [SPORTS], [BABY1]/[BABY2], [PET], [HIGH SENS.], [HI-SPEED BURST], [FLASH BURST], [PIN HOLE] or [FILM GRAIN] in Scene Mode
  - When [INTELLIGENT ISO] is set

## Using the Easy zoom

It automatically zooms to Tele (maximum zoom position). The zoom magnification differs depending on the picture size that is set.

### Press [E.ZOOM].

You can further extend the zoom to the digital zoom range by pressing [E.ZOOM] again when [DIGITAL ZOOM] (P81) is set to [ON].

#### • When the maximum picture size has been set:

The zoom stops once at the maximum zoom position of the optical zoom. (①)  
When [E.ZOOM] is pressed again, zooming proceeds as far as the maximum zoom position of the extended optical zoom. (②)

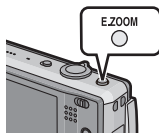

- Ⓐ Optical zoom
- Ⓑ Extended optical zoom
- Ⓒ Digital zoom

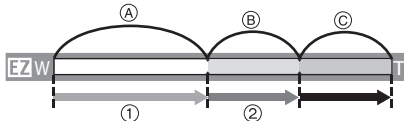

The colors of the zoom bars and the picture size change, and the picture size changes temporarily as shown below.

Aspect ratio	Picture size
4:3	[ 12M ] → [ 3M ]
3:2	[ 10.5M ] → [ 2.5M ]
16:9	[ 9M ] → [ 2M ]

### ■ To return to Wide using the easy zoom

Press [E.ZOOM] at Tele (the maximum zoom position).



- Zoom returns to Wide.
- When the zoom position returns to Wide while the maximum picture size is set, the picture size which was changed in the extended optical zoom range now returns to what it was originally. Also, the picture size returns to what it was originally when the zoom position has been returned to the optical zoom range using the zoom lever.



#### Note

- Press [E.ZOOM] firmly until the zoom function is activated.

[PLAYBACK] Mode: 

## Playing back Pictures ([NORMAL PLAY])

### 1 Slide the [REC]/[PLAYBACK] selector switch **(A)** to **[▶]**.

- Normal playback is set automatically in the following cases.
  - When the mode is switched from the [REC] to [PLAYBACK].
  - When the camera is turned on while the [REC]/[PLAYBACK] selector switch is at **[▶]**.

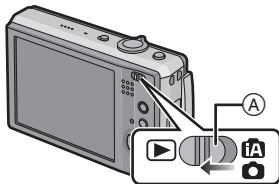

### 2 Forward or rewind the image by dragging **(P12)** the screen horizontally.

**Forward:** drag from left to right

**Rewind:** drag from right to left

**(A)** File number

**(B)** Picture number

- It is also possible to forward or rewind the image by pressing **◀/▶** of the cursor button.
- Speed of picture forwarding/rewinding changes depending on the playback status.



### ■ Fast forwarding/Fast rewinding Press and hold **◀/▶** of the cursor button.

**◀:** Fast rewind

**▶:** Fast forward

- The file number and the picture number only change one by one. Release **◀/▶** when the number of the desired picture appears to play back the picture.
- If you keep pressing **◀/▶**, the number of pictures forwarded/rewound increases.

## Using the Touch Zoom

### 1 Touch the part to enlarge.

1× → 2× → 4× → 8× → 16×

- Portion that is touched will be enlarged.
- Picture can be enlarged also by rotating the zoom lever toward **[Q]** (T).



## 2 Move the position to be displayed by dragging the picture (P12).

- When you move the position to be displayed, the zoom position indication (A) appears for about 1 second.
- Position of the enlarged part can be also moved by touching the [▲]/[▼]/[◀]/[▶], or pressing ▲/▼/◀/▶ of the cursor button.
- Picture will return to the original size (1×) by touching [Q<sub>x1.0</sub>].
- Also, when you touch [Q] or rotate the zoom lever towards [W], the magnification becomes lower.

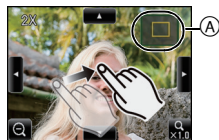

### Note

- This camera complies with the DCF standard “Design rule for Camera File system” established by JEITA “Japan Electronics and Information Technology Industries Association” and with Exif “Exchangeable Image File Format”. Files which do not comply with the DCF standard cannot be played back.
- The more a picture is enlarged, the more its quality deteriorates.
- The lens barrel retracts about 15 seconds after switching from [REC] Mode to [PLAYBACK] Mode.
- If you want to save the enlarged picture, use the trimming function. (P93)
- Touch zoom function may not work with pictures recorded by other equipment.
- Touch zoom cannot be used during motion picture playback or pictures with audio playback.

## Switching the [PLAYBACK] Mode

### 1 Press [MODE] during playback.

- (A) [MODE] button

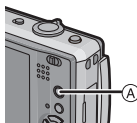

### 2 Touch the mode.



**■ List of [PLAYBACK] Modes** **[NORMAL PLAY] (P37)**

All the pictures are played back.

 **[SLIDE SHOW] (P84)**

The pictures are played back in sequence.

 **[MULTI PLAYBACK] (P86)**

Multiple pictures are played back on one screen.

 **[CALENDAR] (P87)**

Pictures are played back by the date recorded.

 **[DUAL PLAY] (P88)**

Playing Back Pictures on the Dual Display

 **[CATEGORY PLAY] (P89)**

The pictures grouped together in categories are played back.

 **[FAVORITE PLAY] (P90)\***

Your favorite pictures are played back.

\* [FAVORITE PLAY] cannot be selected if there is no picture set as [FAVORITE].

 **[EASY ORG.] (P90)**

Pictures can be edited/deleted by the touch panel.

[PLAYBACK] Mode: 

## Deleting Pictures

Once deleted, pictures cannot be recovered.

- Pictures on the built-in memory or the card which are being played back will be deleted.

### To delete a single picture

- 1 Select the picture to be deleted, and then press .

Ⓐ  button

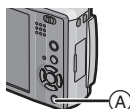

- 2 Touch [DELETE SINGLE].

- 3 Touch [YES].

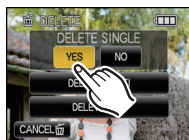

### To delete multiple pictures (up to 50) or all the pictures

- 1 Press .

- 2 Touch [DELETE MULTI] or [DELETE ALL].

• [DELETE ALL] → step 5.

- 3 Touch the picture to be deleted.  
(repeat this step)

•  appears on the selected pictures. Touching again cancels the setting.

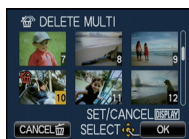

- 4 Touch [OK].

- 5 Touch [YES].

■ When [DELETE ALL] has been selected with the [FAVORITE] (P91) setting

The selection screen is displayed again. Select [DELETE ALL] or [ALL DELETE EXCEPT ★], select [YES] and delete the pictures.

#### Note

- Do not turn the camera off while deleting (while  is displayed). Use a battery with sufficient battery power or the AC adaptor (DMW-AC5PP; optional) and DC coupler (DMW-DCC4; optional).
- If you press [MENU/SET] while deleting pictures using [DELETE MULTI], [DELETE ALL] or [ALL DELETE EXCEPT ★], the deleting will stop halfway.
- Depending on the number of pictures to be deleted, it may take some time to delete them.
- If pictures do not conform to the DCF standard or are protected (P97), they will not be deleted even if [DELETE ALL] or [ALL DELETE EXCEPT ★] is selected.



# About the LCD Monitor

Press [DISPLAY] to change.

- (A) LCD monitor
- (B) [DISPLAY] button

• When the menu screen appears, the [DISPLAY] button is not activated.

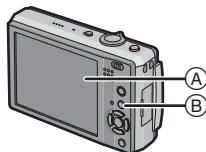

## In Recording Mode

- (C) Normal display\*1
- (D) No display\*3
- (E) No display (Recording guideline)\*1, 2, 3

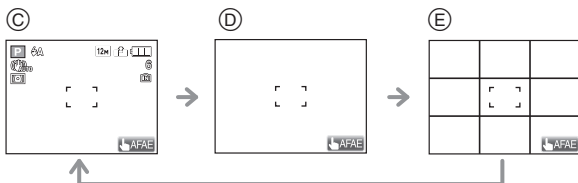

## In Playback Mode

- (F) Normal display
- (G) Display with recording information\*1
- (H) No display

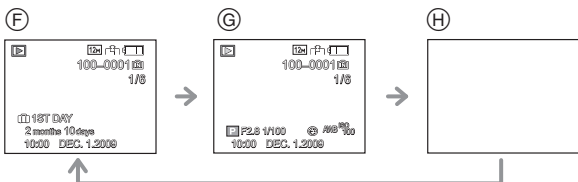

\*1 If the [HISTOGRAM] in [SETUP] menu is set to [ON], histogram will be displayed.

\*2 Set the pattern of the guidelines displayed by setting [GUIDE LINE] in [SETUP] menu. You can also set whether or not to have the recording information displayed when the guidelines are displayed.

\*3 If no operation is performed for a certain period of time, the touch icon will disappear.



## Note

• In [NIGHT PORTRAIT], [NIGHT SCENERY], [STARRY SKY] and [FIREWORKS] in Scene Mode, the guideline is gray. (P55)

## Recording guideline

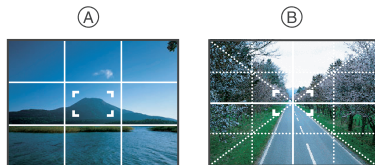
When you align the subject on the horizontal and vertical guidelines or the cross point of these lines, you can take pictures with well-designed composition by viewing the size, the slope and the balance of the subject.



- (A) : This is used when dividing the entire screen into 3×3 for taking pictures with a well-balanced composition.
- (B) : This is used when you want to position the subject at the exact center of the screen.

## ■ About the Histogram

A histogram is a graph that displays brightness along the horizontal axis (black to white) and the number of pixels at each brightness level on the vertical axis.

It allows you to easily check a picture's exposure.

### Examples of histogram

- ① Properly Exposed
  - ② Underexposed
  - ③ Overexposed
- \* Histogram

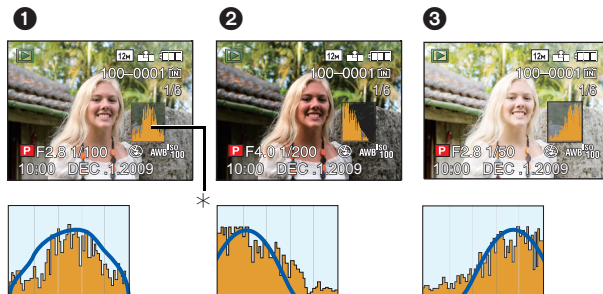

### Note

- When the recorded picture and the histogram do not match each other under the following conditions, the histogram is displayed in orange.
  - When the manual exposure assistance is other than  $[\pm 0EV]$  during exposure compensation or in the Manual Exposure Mode
  - When the flash is activated
  - In [STARRY SKY] or [FIREWORKS] in Scene Mode (P55)
  - When the brightness of the screen is not correctly displayed in dark places
  - When the exposure is not adequately adjusted
- The histogram is an approximation in Recording Mode.
- The histogram of a picture may not match in Recording Mode and Playback Mode.
- The histogram displayed in this camera does not match histograms displayed by picture editing software used in PCs, etc.
- Histograms are not displayed in the following cases.
  - Intelligent Auto Mode
  - Motion Picture Mode
  - [DUAL PLAY]
  - [EASY ORG.]
  - [CALENDAR]
  - [MULTI PLAYBACK]
  - Touch zoom
  - When the component cable is connected

[REC] Mode: **TA PASM MS SCN**

## Taking Pictures using the Built-in Flash

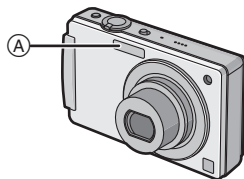

### A Photo flash

Do not cover it with your fingers or other objects.

## Switching to the appropriate flash setting

Set the flash to match the recording.

**1** Press ► [**⚡**].



**2** Touch the item.

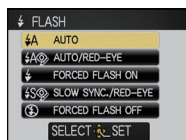

- For information about flash settings that can be selected, refer to “Available flash settings by Recording Mode”. (P44)
- You can also press the shutter button halfway to finish.
- The menu screen disappears after about 5 seconds. At this time, the selected item is automatically set.



Item	Description of settings
<b>⚡A: AUTO</b>	The flash is automatically activated when the recording conditions make it necessary.
<b>⚡A⊙: AUTO/Red-eye reduction*</b>	The flash is automatically activated when the recording conditions make it necessary. It is activated once before the actual recording to reduce the red-eye phenomenon (eyes of the subject appearing red in the picture) and then activated again for the actual recording. <ul style="list-style-type: none"> <li>• Use this when you take pictures of people in low lighting conditions.</li> </ul>
<b>⚡: Forced flash ON</b> <b>⚡⊙: Forced ON/Red-eye reduction*</b>	The flash is activated every time regardless of the recording conditions. <ul style="list-style-type: none"> <li>• <b>Use this when your subject is back-lit or under fluorescent light.</b></li> <li>• <b>The flash setting is set to [<b>⚡⊙</b>] only when you set [PARTY] or [CANDLE LIGHT] in Scene Mode. (P55)</b></li> </ul>
<b>⚡S⊙: Slow sync./Red-eye reduction*</b>	If you take a picture with a dark background landscape, this feature will slow the shutter speed when the flash is activated so that the dark background landscape will become bright. Simultaneously it reduces the red-eye phenomenon. <ul style="list-style-type: none"> <li>• <b>Use this when you take pictures of people in front of a dark background.</b></li> </ul>
<b>⊕: Forced flash OFF</b>	The flash is not activated in any recording conditions. <ul style="list-style-type: none"> <li>• <b>Use this when you take pictures in places where the use of the flash is not permitted.</b></li> </ul>

\* The flash is activated twice. The subject should not move until the second flash is activated. Interval until the second flash depends on the brightness of the subject.

### ■ About the digital red-eye correction























When the flash is used with the Red-eye reduction ([, [, [] selected, it will automatically detect and correct the red-eye in the image data.























\* It may not be able to correct the red-eye depending on the recording conditions. It may also correct objects other than red-eye.

### ■ Available flash settings by Recording Mode

The available flash settings depend on the Recording Mode.

(○: Available, —: Not available, ●: Scene Mode initial setting)

						
	○*	—	—	—	—	○
	○	○	○	○	—	○
	○	○	○	○	—	○
	○	○	○	—	—	○
	○	○	○	—	—	○
	○	●	○	—	—	○
	○	●	○	—	—	○
	○	●	○	—	—	○
	○	●	○	—	—	○
	○	●	○	—	—	○
	—	—	—	—	—	●
	—	—	—	—	—	●
	●	—	○	—	—	○
	—	—	—	●	—	○
	—	—	—	—	—	●
	○	—	○	—	—	●
	—	—	—	●	○	○

						
	—	—	—	○	○	●
	○	●	○	—	—	○
	○	●	○	—	—	○
	○	—	○	—	—	●
	○	—	○	—	—	●
	—	—	—	—	—	●
	—	—	●	—	—	—
	—	—	—	—	—	●
	—	—	—	—	—	●
	—	—	—	—	—	●
	—	—	●	—	—	○
	●	—	○	—	—	○
	—	—	—	—	—	●
	●	—	○	—	—	○
	●	—	○	—	—	○
	—	—	—	—	—	○

\* When [] is selected, [, [] or [] is set depending on the type of subject and brightness.

- The flash setting may change if the Recording Mode is changed. Set the flash setting again if necessary.
- The flash setting is memorized even if the camera is turned off. However, the Scene Mode flash setting is reset to the initial setting when the Scene Mode is changed.

## ■ The available flash range to take pictures

- The available flash range is an approximation.

ISO sensitivity	Available flash range	
	Wide	Tele
<b>AUTO</b>	60 cm (1.97 feet) to 6.0 m (19.7 feet)	1.0 m (3.28 feet) to 2.8 m (9.18 feet)
<b>ISO80</b>	60 cm (1.97 feet) to 1.7 m (5.58 feet)	1.0 m (3.28 feet)
<b>ISO100</b>	60 cm (1.97 feet) to 1.9 m (6.23 feet)	1.0 m (3.28 feet)
<b>ISO200</b>	60 cm (1.97 feet) to 2.7 m (8.85 feet)	1.0 m (3.28 feet) to 1.2 m (3.94 feet)
<b>ISO400</b>	60 cm (1.97 feet) to 3.8 m (12.5 feet)	1.0 m (3.28 feet) to 1.8 m (5.91 feet)
<b>ISO800</b>	80 cm (2.62 feet) to 5.4 m (17.7 feet)	1.0 m (3.28 feet) to 2.5 m (8.20 feet)
<b>ISO1600</b>	1.15 m (3.77 feet) to 7.7 m (25.3 feet)	1.0 m (3.28 feet) to 3.6 m (11.8 feet)

- In [HIGH SENS.] (P61) in Scene Mode, the ISO sensitivity automatically switches to between [ISO1600] and [ISO6400] and the available flash range also differs.

Wide: Approx. 1.15 m (3.77 feet) to approx. 15.4 m (50.5 feet)

Tele: Approx. 1.0 m (3.28 feet) to approx. 7.3 m (24.0 feet)

- In [FLASH BURST] (P62) in Scene Mode, the ISO sensitivity automatically switches to between [ISO100] and [ISO3200] and the available flash range also differs.

Wide: Approx. 60 cm (1.97 feet) to approx. 4.0 m (13.1 feet)

Tele: Approx. 1.0 m (3.28 feet) to approx. 1.9 m (6.23 feet)

## Adjust the flash output

Adjust the flash output when the subject is small, or the reflectivity is very high or low.

### 1 Press ▲ (⏏) several times to display [FLASH].

### 2 Touch the slide bar.

- You can adjust from [-2 EV] to [+2 EV] in steps of [1/3 EV].
- Select [0 EV] to return to the original flash output.

### 3 Touch [EXIT].

- You can also close the menu by pressing the shutter button halfway.



### Note

- When the flash output is adjusted, the flash output value appears on the upper left of the screen.
- The flash output setting is memorized even if the camera is turned off.
- The flash output adjustment cannot be used while in [SCENERY]/[PANORAMA ASSIST]/[NIGHT SCENERY]/[SUNSET]/[HI-SPEED BURST]/[FLASH BURST]/[STARRY SKY]/[FIREWORKS]/[AERIAL PHOTO] in Scene Mode.

## ■ Shutter speed for each flash setting

Flash setting	Shutter speed (Sec.)	Flash setting	Shutter speed (Sec.)
⚡	1/30*1 to 1/2000	⚡	1*1 to 1/2000 1 or 1/4 to 1/2000*2
⚡			
⚡		⊕	

\*1 It may vary depending on the [MIN. SHTR SPEED] setting (P82).

\*2 When Intelligent ISO is set (P75)

- \*2: The shutter speed becomes a maximum of 1 second in the following cases.
  - When the optical image stabilizer is set to [OFF].

- When the camera has determined that there is little jitter when the optical image stabilizer is set to [MODE1], [MODE2] or [AUTO].
- In Intelligent Auto Mode, shutter speed changes depending on the identified scene.
- There will be differences in the above shutter speeds in the Scene Modes.

### Note

- If you bring the flash too close to an object, the object may become distorted or discolored by the heat or light from the flash.
- When you take a picture beyond the available flash range, the exposure may not be adjusted properly and the picture may become too light or too dark.
- When the flash is being charged, the flash icon blinks red, and you cannot take a picture even when you press the shutter button fully. **When [AUTO LCD OFF] is set, the LCD monitor turns off and the status indicator lights.**
- The white balance may not be properly adjusted if the flash level is insufficient for the subject.
- When the shutter speed is fast, the flash effect may not be sufficient.
- It may take time to charge the flash if you repeat taking a picture. Take a picture after the access indication disappears.
- The red-eye reduction effect differs between people. If the subject was far away from the camera or was not looking at the first flash, the effect may not be evident.

[REC] mode: **PASM** 

## Taking Close-up Pictures

This mode allows you to take close-up pictures of a subject, e.g. when taking pictures of flowers. You can take pictures of a subject as close as 5 cm (0.17 feet) from the lens by rotating the zoom lever upmost to Wide (1×). (AF Macro Mode)

You can take a picture with the digital zoom up to 3× while maintaining the distance to the subject for the extreme Wide position [5 cm (0.17 feet)]. (Macro Zoom Mode)

### 1 Press ▼ [].



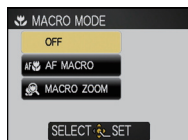

### 2 Touch the item.

- You can also press the shutter button halfway to finish.
- The menu screen disappears after about 5 seconds. At this time, the selected item is automatically set.



### 3 Press the shutter button halfway to focus and then press it fully to take the picture.

- Ⓐ Focus range
- [] is displayed during AF Macro Mode and [] is displayed during Macro Zoom Mode.
- To cancel, select the [OFF] in step 2.
- Zoom range, focus range, and zoom magnification are displayed during zooming. Zoom range will be displayed in blue (digital zoom range) during Macro Zoom Mode.

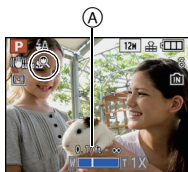

## Focus range in AF Macro Mode

- \* The focus range changes in steps.

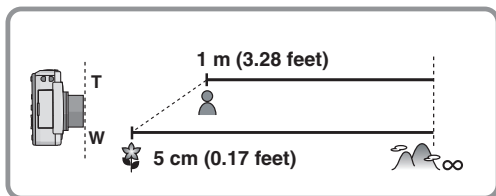

- Focus range will be 5 cm (0.17 feet) to  $\infty$  during Macro Zoom Mode regardless of the zoom position.

### Note

- We recommend using a tripod and the self-timer.
- We recommend setting the flash to  $\text{☺}$  when you take pictures at close range.
- If the distance between the camera and the subject is beyond the focus range of the camera, the picture may not be properly focused even if the focus indication lights.
- When a subject is close to the camera, the effective focus range is significantly narrowed. Therefore, if the distance between the camera and the subject is changed after focusing on the subject, it may become difficult to focus on it again.
- Macro Mode gives priority to a subject close to the camera. Therefore, if the distance between the camera and the subject is more than 1 m (3.28 feet) it takes longer to focus on it.
- When you take pictures at close range, the resolution of the periphery of the picture may decrease slightly. This is not a malfunction.
- The image quality when recording in [MACRO ZOOM] is poorer than during normal recording.
- The extended optical zoom will not function when [MACRO ZOOM] is set.

[REC] Mode: **IA PASM MS SCN**

## Taking Pictures with the Self-timer

**1** Press  $\blacktriangleleft$  [⏸].



**2** Touch the item.

- You can also press the shutter button halfway to finish.
- The menu screen disappears after about 5 seconds. At this time, the selected item is automatically set.

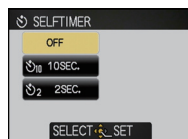

### 3 Press the shutter button halfway to focus and then press it fully to take the picture.

- The self-timer indicator (A) blinks and the shutter is activated after 10 seconds (or 2 seconds).
- If you press [MENU/SET] while the self-timer is set, the self-timer setting is canceled.

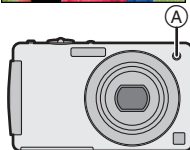

#### Note

- When using a tripod etc., setting the self-timer to 2 seconds is a convenient way to avoid the jitter caused by pressing the shutter button.
- When you press the shutter button once fully, the subject is automatically focused just before recording. In dark places, the self-timer indicator will blink and then turn on operating as an AF assist lamp (P83) to allow the camera to focus on the subject.
- We recommend using a tripod when recording with the self-timer.
- The number of pictures which can be taken in [BURST] is fixed to 3.
- The number of pictures which can be taken in [FLASH BURST] in Scene Mode is fixed to 5.
- Self-timer cannot be set to 2 seconds in Intelligent Auto Mode.
- Self-timer cannot be set to 10 seconds in [SELF PORTRAIT] in Scene Mode.
- Self-timer cannot be used while in [HI-SPEED BURST] in Scene Mode.

[REC] Mode: **IA PASM MS SCN**

## Taking Pictures with Focus and Exposure Set on Subject (Touch AF/AE)

It is possible to set the focus and exposure to the subject specified on the touch panel. Focus will keep following the subject automatically even if it moves. (Dynamic tracking)

### 1 Touch [L/AF/AE].

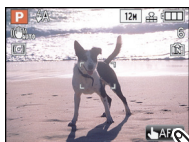

### 2 Touch the subject.

- AF area will be displayed when the subject is recognized, and the focus and exposure will follow the movement of the subject. (Dynamic tracking)
- Touch AF/AE is canceled by touching [CANCEL].

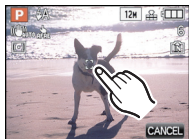



- 3** Press the shutter button halfway to focus and then press it fully to take the picture.

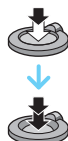

### Note

- Failure of touch AF/AE, loss of the subject while dynamic tracking, or tracking of another subject may occur depending on the recording conditions in the following cases.
  - When the subject is too small
  - When the recording location is too dark
  - When the subject is moving too fast
  - When another subject or background is similar in color to the subject.
  - When jitter is occurring
  - When using the zoom
- If Touch AF/AE fails, AF area will flash in red, and disappear. Touch the screen again.
- [AF MODE] will be recorded in [H] when touch AF/AE and dynamic tracking do not work.
- Frame showing touch possible area is displayed when you touch outside the possible area. The touch is invalid when it is outside the touch possible area.
- The most appropriate scene is selected for the touched subject in the Intelligent Auto Mode.
- Only focus can be adjusted during manual exposure.
- [QUICK AF] and [FACE RECOG.] will not operate during touch AF/AE.
- Touch AF/AE will not work in the following cases.
  - [PANORAMA ASSIST]/[STARRY SKY]/[FIREWORKS]/[PIN HOLE]/[FILM GRAIN] in Scene Mode.
  - When it is set to [B/W], [SEPIA], [COOL], and [WARM] in [COLOR EFFECT].
  - In Motion Picture Mode

[REC] Mode: **A**

## Taking Pictures with Set Aperture

(**A**: Aperture-priority AE)

Set the aperture value to a higher number when you want a sharp focus background. Set the aperture value to a lower number when you want a soft focus background.

- 1** Slide the [REC]/[PLAYBACK] selector switch to [**A**], and then press [MODE].
- 2** Touch [APERTURE PRIORITY].
- 3** Touch the aperture set bar.

(A) Aperture Set Bar

(B) Exposure Compensation Set Bar

- Exposure (P53) can be compensated by touching the exposure compensation set bar. Touch the exposure compensation value you want to set.



## ■ Aperture-priority AE

Available Aperture Value (W) (Per 1/3 EV)			Shutter Speed (Sec)
F8.0			8 to 1/2000
F7.1	F6.3	F5.6	8 to 1/1600
F5.0	F4.5	F4.0	8 to 1/1300
F3.5	F3.2	F2.8	8 to 1/1000

- Depending on the zoom magnification, some of the aperture values cannot be selected.

### 4 Take the pictures.

#### Note

- Slide bar can be hidden (P52).
- Brightness of the LCD monitor may differ from the actual picture recorded. Please confirm in playback Mode.
- If the exposure is not adequate, the aperture value and the shutter speed turn red when the shutter button is pressed halfway.
- Set the aperture value larger if it is too bright, and set the aperture value smaller if it is too dark.
- We recommend using a tripod when the shutter speed is slow.

[REC] Mode: **S**

## Taking Pictures with Set Shutter Speed

(**S**: Shutter-priority AE)

When you want to take a sharp picture of a fast moving subject, set to a faster shutter speed. When you want to create a trail effect, set to a slower shutter speed.

**1** Slide the [REC]/[PLAYBACK] selector switch to **[A/O]**, and then press [MODE].

**2** Touch [SHUTTER PRIORITY].

**3** Touch the shutter speed set bar.

- (A) Shutter Speed Set Bar
- (B) Exposure Compensation Set Bar

- Exposure (P53) can be compensated by touching the exposure compensation set bar. Touch the exposure compensation value you want to set.



## ■ Shutter-priority AE

Available Shutter Speed (Sec) (Per 1/3 EV)				Aperture Value (W)
8	6	5	4	F2.8 to F8.0
3.2	2.5	2	1.6	
1.3	1	1/1.3	1/1.6	
1/2	1/2.5	1/3.2	1/4	
1/5	1/6	1/8	1/10	
1/13	1/15	1/20	1/25	
1/30	1/40	1/50	1/60	
1/80	1/100	1/125	1/160	
1/200	1/250	1/320	1/400	
1/500	1/640	1/800	1/1000	
1/1300				F4.0 to F8.0
1/1600				F5.6 to F8.0
1/2000				F8.0

## 4 Take the pictures.

### Note

- Slide bar can be hidden (P52).
- Brightness of the LCD monitor may differ from the actual picture recorded. Confirm in Playback Mode.
- If the exposure is not adequate, the aperture value and the shutter speed turn in red when the shutter button is pressed halfway.
- We recommend using a tripod when the shutter speed is slow.

[REC] Mode: **M**

## Taking Pictures with Exposure Set Manually

(**M**): Manual exposure)

Determine the exposure by manually setting the aperture value and the shutter speed.

**1** Slide the [REC]/[PLAYBACK] selector switch to **[A/📷]**, and then press **[MODE]**.

**2** Touch **[MANUAL EXPOSURE]**.

**3** Touch the aperture set bar **(A)** or shutter speed set bar **(B)**.

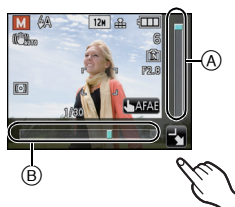

## Manual exposure

Available Aperture Value (W) (Per 1/3 EV)	Available Shutter Speed (Sec) (Per 1/3 EV)
F2.8 to F3.5	60 to 1/1000
F4.0 to F5.0	60 to 1/1300
F5.6 to F7.1	60 to 1/1600
F8.0	60 to 1/2000

- Depending on the zoom magnification, some of the aperture values cannot be selected.



### 4 Press the shutter button halfway.

- The manual exposure assistance  appears for about 10 seconds to indicate the exposure.
- Set the aperture value and the shutter speed again when the exposure is not adequate.



### 5 Take the pictures.

## Manual Exposure Assistance

	The exposure is adequate.
	Set to faster shutter speed or larger aperture value.
	Set to slower shutter speed or smaller aperture value.

- Manual exposure assistance is an approximation. It is recommended to record by confirming in Playback Mode.

### Note

- Brightness of the LCD monitor may differ from the actual picture recorded. Please confirm in Playback Mode.
- If the exposure is not adequate, the aperture value and the shutter speed turn red when the shutter button is pressed halfway.

## Hide the slide bar

Slide bar can be hidden by touching .

Touch the aperture value, shutter speed or exposure display to change the settings.

- Slide bar will be hidden during Touch AF/AE as well.



[REC] Mode: **PAS** MS SCN

## Compensating the Exposure

Use this function when you cannot achieve correct exposure due to the difference in brightness between the subject and the background. Look at the following examples.

### Underexposed



Compensate the exposure towards positive.

### Properly exposed



### Overexposed

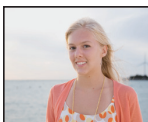

Compensate the exposure towards negative.

**1** Press ▲ [ ] until [EXPOSURE] appears.



**2** Touch the slide bar.

- Select [0 EV] to return to the original exposure.



**3** Touch [EXIT].

- You can also press the shutter button halfway to finish.

### Note

- EV is an abbreviation of [Exposure Value]. It refers to the amount of light given to the CCD by the aperture value and the shutter speed.
- The exposure compensation value appears on the lower left of the screen.
- The set exposure value is memorized even if the camera is turned off.
- The compensation range of the exposure will be limited depending on the brightness of the subject.
- Exposure can also be compensated by touching the exposure compensation set bar when in aperture-priority AE or shutter-priority AE.
- Exposure compensation cannot be used when in [STARRY SKY] in Scene Mode.

# Taking Pictures using Auto Bracket/ Color Bracket

## Auto Bracket

[REC] Mode: **PASM MS SCN**

In this mode, 3 pictures are automatically recorded in the selected exposure compensation range each time the shutter button is pressed. You can select the picture with the desired exposure from the 3 pictures with different exposures.

**With auto bracket  $\pm 1$  EV**

1st picture



$\pm 0$  EV

2nd picture



-1 EV

3rd picture



+1 EV

- 1 Press  $\blacktriangle$  [Z] several times to display [AUTO BRACKET].



- 2 Touch the slide bar.

- When you do not use auto bracket, select [OFF] (0).



- 3 Touch [EXIT].

- You can also press the shutter button halfway to finish.

## Color Bracket

[REC] Mode: **PASM**

Pressing the shutter button once allows you to take 3 pictures in black and white/standard/sepia.

**1** Press **▲** [] several times to display **[AUTO BRACKET]** and touch **[DISPLAY]**.

- Touching **[DISPLAY]** allows you to switch between auto bracket and color bracket.

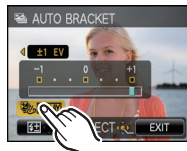
**2** Touch **[◀]/[▶]** to display **[B/W/STANDARD/SEPIA]**.**3** Touch **[EXIT]**.

- You can also press the shutter button halfway to finish.

**Note**

- When setting auto bracket, [] appears on the screen, and when setting color bracket, [] appears on the screen.
- When taking pictures using auto bracket after setting the exposure compensation range, the pictures taken are based on the selected exposure compensation range. When the exposure is compensated, the exposure compensation value appears on the lower left of the screen.
- The exposure may not be compensated with auto bracket depending on the brightness of the subject.
- The auto bracket/color bracket setting is canceled if you turn the camera off or **[POWER SAVE]** is activated.
- When auto bracket/color bracket is set, the auto review function is activated regardless of the auto review setting. (The picture is not enlarged.) You cannot set the auto review function in the **[SETUP]** menu.
- In shutter-priority AE and manual exposure, if the shutter speed is set to longer than 1 second auto bracket is disabled.
- **[☺]** is set for the flash when auto bracket/color bracket is set.
- **Burst is canceled when auto bracket/color bracket is set.**
- **The one set last will take precedence. (auto bracket and color bracket cannot be set simultaneously.)**
- Auto Bracket cannot be used when in **[TRANSFORM]**, **[PANORAMA ASSIST]**, **[HI-SPEED BURST]**, **[FLASH BURST]**, **[STARRY SKY]**, **[PIN HOLE]** and **[FILM GRAIN]** in Scene Mode.

[REC] Mode: **MS SCN****Taking pictures that match the scene being recorded (Scene Mode)**

When you select a Scene Mode to match the subject and recording situation, the camera sets the optimal exposure and hue to obtain the desired picture.

**Registering scenes in Scene Mode (MS: My Scene Mode)**

In **[MY SCN MODE]**, you can register the Scene Mode you use most frequently as one of the Recording Mode.

**1** Slide the [REC]/[PLAYBACK] selector switch to **[A/O]**, and then press **[MODE]**.

**2** Touch **[MY SCN MODE]**.

- When My Scene Mode has been registered, the registered Scene Mode is displayed instead of **[MY SCN MODE]**.



**3** Touch the Scene Mode to select.

- Menu screen can be switched by touching **[◀]/[▶]** in left and right of the screen.
- The menu screen is switched to the recording screen in the selected Scene Mode.
- The selected Scene Mode is registered as My Scene Mode, so that the next time you are recording, you can select it from **[REC MODE]**.

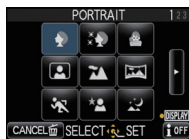

### ■ About the information feature **[i]**

- If the information is **[ON]**, explanations about the selected Scene Mode will be displayed when the Scene Mode is touched in step **3**.

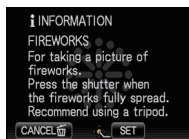

### ■ Changing My Scene Mode

- 1** Press **[SCN]** in My Scene Mode recording screen.
- 2** Touch the Scene Mode.

#### Selecting the Scene Mode for each recording (**[SCN]**: Scene Mode)

In **[SCENE MODE]**, you can select the Scene Mode each time you make a recording.

- 1** In step **2** above, touch **[SCENE MODE]**.
- 2** Touch the Scene Mode.

- The recording screen for the selected Scene Mode will be displayed.
- Touching the **[SCN]** in the recording screen of the Scene Mode will return to the menu screen of the Scene Modes.

### Note

- The Scene Mode flash setting is reset to the initial setting when the Scene Mode is changed.
- When you take a picture with a Scene Mode that is not adequate for the purpose, the hue of the picture may differ from the actual scene.
- The following items cannot be set in Scene Mode because the camera automatically adjusts them to the optimal setting.
  - **[INTELLIGENT ISO]/[SENSITIVITY]/[ISO LIMIT SET]/[METERING MODE]/[I.EXPOSURE]/[COLOR EFFECT]/[PICT.ADJ.]/[MIN. SHTR SPEED]/[COLOR BRACKET]**
- Touch **AF/AE** can be used except for following Scene Modes.
  - **[PANORAMA ASSIST]/[STARRY SKY]/[FIREWORKS]/[PIN HOLE]/[FILM GRAIN]**
- **[I.EXPOSURE]** is activated automatically except for following Scene Modes.
  - **[PANORAMA ASSIST]/[NIGHT SCENERY]/[FOOD]/[PET]/[HI-SPEED BURST]/[STARRY SKY]/[FIREWORKS]/[SNOW]/[AERIAL PHOTO]/[PIN HOLE]/[FILM GRAIN]**



- Shutter speed for Scene Modes, except [PANORAMA ASSIST], [SPORTS], [NIGHT PORTRAIT], [NIGHT SCENERY], [CANDLE LIGHT], [BABY 1]/[BABY 2], [PET], [FLASH BURST], [STARRY SKY] and [FIREWORKS], will be from 1/8th of a second to 1/2000th of a second.

## [PORTRAIT]

When taking pictures of people outdoors during the daytime, this mode allows you to improve the appearance of the persons concerned and make their skin tones look healthier.

### ■ Technique for Portrait Mode

To make this mode more effective:

- 1 Rotate the zoom lever to maximum Tele position.
- 2 Move close to the subject to make this mode more effective.

### Note

- The initial setting for [AF MODE] is [].

## [SOFT SKIN]

When taking pictures of people outdoors during the daytime, this mode enables the texture of their skin to appear even softer than with [PORTRAIT]. (It is effective when taking pictures of people from the chest up.)

### ■ Technique for Soft Skin Mode

To make this mode more effective:

- 1 Rotate the zoom lever to maximum Tele position.
- 2 Move close to the subject to make this mode more effective.

### Note

- If a part of the background etc. is a color close to skin color, this part is also smoothed.
- This mode may not be effective when there is insufficient brightness.
- The initial setting for [AF MODE] is [].

## [TRANSFORM]

Subject can be recorded either slim or stretched, and at the same time, skin can be recorded smoothly.





### 1 Touch the level of transform.

- It can be set from the quick menu (P22).

### 2 Take pictures.



### Note

- [PICTURE SIZE] and [ASPECT RATIO] are fixed as given below.
  - [] for [4:3], [] for [3:2] and [] for [16:9]
- [QUALITY] is automatically fixed to [].
- You can take pictures suitable for 4"×6"/10×15 cm printing.
- The initial setting for [AF MODE] is [].
- It cannot be used without notifying the copyright owner, except when enjoying in private.
- Do not use the material against the public order and morals, or to offend someone.
- Do not use the material against the object's interest.

## [SELF PORTRAIT]

Select this to take pictures of yourself.

### ■ Technique for Self Portrait Mode

- Press the shutter button halfway to focus. The self-timer indicator lights up when you are brought into focus. Making sure you hold the camera still, press the shutter button fully to take the picture.
- The subject is not focused when the self-timer indicator is blinking. Make sure to press the shutter button halfway again to focus.
- The recorded picture automatically appears on the LCD monitor for reviewing.
- If the picture is blurry due to the slow shutter speed, we recommend using the 2 second self-timer.



### Note

- The focus range is about 30 cm (0.99 feet) to 1.2 m (3.94 feet) (Wide).
- You can take a picture of yourself with audio (P83). If you do this, the self-timer indicator will light up while recording the audio.
- The zoom magnification is automatically moved to Wide (1×).
- The self-timer can only be set to off or 2 seconds. If it is set to 2 seconds, this setting will remain until the camera is turned off, the Scene Mode is changed or [REC] Mode or [PLAYBACK] Mode is selected.
- The Stabilizer Function Mode is fixed to [MODE2]. (P82)
- The initial setting for [AF MODE] is [].

## [SCENERY]

This allows you to take pictures of a wide landscape.

### Note

- The flash setting is fixed to [].
- The focus range is 5 m (16.4 feet) to ∞.

## [PANORAMA ASSIST]

You can take pictures with connections suitable for creating panorama images.

### ■ Setting the recording direction

#### 1 Touch the direction to take picture.

- The horizontal/vertical guideline will be displayed.

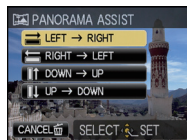

#### 2 Take the picture.

- You can retake the picture by selecting [RETAKE].



#### 3 Touch [NEXT].

- You can also press the shutter button halfway to set the menu.
- Part of the recorded image is displayed as transparent image.

#### 4 Take picture after moving the camera horizontally or vertically so the transparent image overlaps

- When taking the third and later pictures, repeat steps 3 and 4.
- You can retake the picture by selecting [RETAKE].

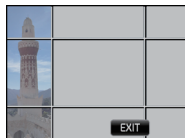

#### 5 Touch [EXIT].

##### Note

- The flash setting is fixed to [☺].
- The focus, zoom, exposure, white balance, shutter speed and ISO sensitivity are fixed to the settings for the first picture.
- The shutter may remain closed (max. about 8 sec.) after taking the picture because of signal processing. This is not a malfunction.
- We recommend using a tripod.
- The recorded images can be combined into panorama pictures using the software "ArcSoft Panorama Maker" on the CD-ROM (supplied).

### [SPORTS]

Set here when you want to take pictures of sports scenes or other fast-moving events.

##### Note

- This mode is suitable for taking pictures of subjects at distances of 5 m (16.4 feet) or more.
- [INTELLIGENT ISO] is activated, and maximum ISO sensitivity level becomes [ISO1600].

### [NIGHT PORTRAIT]

This allows you to take pictures of a person and the background with near real-life brightness.

#### ■ Technique for Night Portrait Mode

- Use the flash. (You can set to [48] 1.)
- Since the shutter speed becomes slower, we recommend using a tripod and the self-timer for taking pictures.
- Ask the subject not to move while taking a picture.
- We recommend rotating the zoom lever to Wide (1×) and being about 1.5 m (4.92 feet) from the subject when taking a picture.

##### Note

- The focus range is 80 cm (2.62 feet) (Wide)/1.2 m (3.94 feet) (Tele) to 5 m (16.4 feet).
- The shutter may remain closed (max. about 8 sec.) after taking the picture because of signal processing. This is not a malfunction.
- Noise may become visible when you take pictures in dark places.
- The initial setting for [AF MODE] is [AF].

### [NIGHT SCENERY]

This allows you to take vivid pictures of the nightscape.

#### ■ Technique for Night Scenery Mode

- When the camera is set to [STABILIZER] and there is little jitter, or if [STABILIZER] is set to [OFF], shutter speed may slow down up to 8 seconds. We recommend using the tripod and the self-timer for taking a picture.

##### Note

- The flash setting is fixed to [☺].
- The focus range is 5 m (16.4 feet) to ∞.
- The shutter may remain closed (max. about 8 sec.) after taking the picture because of signal processing. This is not a malfunction.
- Noise may become visible when you take pictures in dark places.

 [FOOD]

This mode allows you to take pictures of food with a natural hue without being affected by the ambient light in restaurants, etc.

 **Note**

- The focus range is 5 cm (0.17 feet) (Wide)/1 m (3.28 feet) (Tele) to ∞.

 [PARTY]

Select this when you want to take pictures at a wedding reception, an indoor party etc. This allows you to take pictures of people and the background with near real-life brightness.

**■ Technique for Party Mode**

- **Use the flash.** (You can set to [⚡S] or [⚡]).
- We recommend using a tripod and the self-timer for taking pictures.
- We recommend rotating the zoom lever to Wide (1×) and being about 1.5 m (4.92 feet) from the subject when taking pictures.

 **Note**

- The initial setting for [AF MODE] is [⊙].

 [CANDLE LIGHT]

This mode allows you to take pictures with a candle-lit atmosphere.

**■ Technique for Candle Light Mode**

- This is more effective when taking pictures without using the flash.
- We recommend using a tripod and the self-timer for taking pictures.

 **Note**

- The focus range is 5 cm (0.17 feet) (Wide)/1 m (3.28 feet) (Tele) to ∞.
- The shutter may remain closed (max. about 1 sec.) after taking the picture because of signal processing. This is not a malfunction.
- The initial setting for [AF MODE] is [⊙].

 [BABY1] /  [BABY2]

This takes pictures of a baby with a healthy complexion. When you use the flash, the light from it is weaker than usual.

It is possible to set different birthdays and names for [BABY1] and [BABY2]. You can select to have these appear at the time of playback, or have them stamped on the recorded image using [TEXT STAMP] (P96).

**■ Birthday/Name setting**

- 1 Touch [SET] of [AGE] or [NAME].
- 2 Enter the birthday/name

**Birthday:** Touch [▲]/[▼] for each item to set year/month/day, and touch [SET].

**Name:** For details on how to enter characters, read the [TITLE EDIT] section on P94.



- When the birthday or name is set, [AGE] or [NAME] is automatically set to [ON].
- If [ON] is selected when the birthday or name has not been registered, the setting screen appears automatically.

- 3 Touch [SET] to finish.

## ■ To cancel [AGE] and [NAME]

Select the [OFF] setting in step 1 of the "Birthday/Name setting" procedure.

### Note

- The age and name can be printed out using the "PHOTOfunSTUDIO" bundled software on the CD-ROM (supplied).
- If [AGE] or [NAME] is set to [OFF] even when the birthday or name has been set, the age or name will not be displayed. Before taking pictures, set [AGE] or [NAME] to [ON].
- The focus range is 5 cm (0.17 feet) (Wide)/1 m (3.28 feet) (Tele) to ∞.
- [INTELLIGENT ISO] is activated, and maximum ISO sensitivity level becomes [ISO1600].
- If the camera is turned on with [BABY1]/[BABY2] set, the age and name are displayed at the lower left of the screen for about 5 seconds, along with the current date and time.
- If the age is not properly displayed, check the clock and birthday settings.
- The birthday setting and name setting can be reset with [RESET].
- The initial setting for [AF MODE] is [].

## [PET]

Select this when you want to take pictures of a pet such as a dog or a cat.

You can set your pet's birthday and name. You can select to have these appear at the time of playback, or have them stamped on the recorded image using [TEXT STAMP] (P96).

For information about [AGE] or [NAME], refer to [BABY1]/[BABY2] on P60.

### Note

- The initial setting for the AF assist lamp is [OFF].
- The initial setting for [AF MODE] is [].
- Refer to [BABY1]/[BABY2] for other information about this mode.

## [HIGH SENS.]

This mode minimizes the jitter of the subjects, and enables you to take pictures of these subjects in dimly lit rooms. (Select this for high-sensitivity processing. The sensitivity automatically switches to between [ISO1600] and [ISO6400].)

## ■ Picture size and aspect ratio

### 1 Touch the picture size and aspect ratio to select.

- 3M (4:3), 2.5M (3:2) or 2M (16:9) is selected as the picture size.

### 2 Take pictures.

### Note

- [QUALITY] is automatically fixed to [].
- You can take pictures suitable for 4"×6"/10×15 cm printing.
- The focus range is 5 cm (0.17 feet) (Wide)/1 m (3.28 feet) (Tele) to ∞.

 [HI-SPEED BURST]

This is a convenient mode for shooting rapid movement or a decisive moment.

■ **Picture size and aspect ratio**

**1 Touch [SPEED PRIORITY] or [IMAGE PRIORITY].**

**2 Touch the picture size and aspect ratio to select.**

- 3M (4:3), 2.5M (3:2) or 2M (16:9) is selected as the picture size.

**3 Take pictures.**

- Still pictures are taken continuously while the shutter button is pressed fully.

<b>Maximum Burst speed</b>	approx. 10 pictures/second (Speed priority) approx. 6 pictures/second (Image priority)
<b>Number of recordable pictures</b>	approx. 15 to 100

- The burst speed changes according to the recording conditions.
- The number of burst recording pictures are limited by the picture-taking conditions and the type and/or status of the card used.
- The number of burst recording pictures increase immediately after formatting.



**Note**

• **The flash setting is fixed to [☺].**

• [QUALITY] is automatically fixed to [..+].

• You can take pictures suitable for 4"×6"/10×15 cm printing.

• The focus range is 5 cm (0.17 feet) (Wide)/1 m (3.28 feet) (Tele) to ∞.

• The focus, zoom, exposure, white balance, shutter speed and ISO sensitivity are fixed to the settings for the first picture.

• The ISO sensitivity is automatically adjusted. Note, however, that the ISO sensitivity is set high to achieve a high shutter speed.

• Depending on the operating conditions, it may take time to take the next picture if you repeat taking a picture.

 [FLASH BURST]

Still pictures are taken continuously with flash. It is convenient to take continuous still pictures in dark places.

■ **Picture size and aspect ratio**

**1 Touch the picture size and aspect ratio to select.**

- 3M (4:3), 2.5M (3:2) or 2M (16:9) is selected as the picture size.

**2 Take pictures.**

- Still pictures are taken continuously while the shutter button is pressed fully.

<b>Number of recordable pictures</b>	max. 5 pictures
--------------------------------------	-----------------



**Note**

• [QUALITY] is automatically fixed to [..+].

• You can take pictures suitable for 4"×6"/10×15 cm printing.

• The shutter speed becomes 1/30th of a second to 1/2000th of a second.

• The focus range is 5 cm (0.17 feet) (Wide)/1 m (3.28 feet) (Tele) to ∞.

• The focus, zoom, exposure, shutter speed, ISO sensitivity, and flash level are fixed to the settings for the first picture.

• [INTELLIGENT ISO] is activated, and maximum ISO sensitivity level becomes [ISO3200].

• See the Note on P46 when using the flash.

## [STARRY SKY]

This allows you to take vivid pictures of a starry sky or a dark subject.

### ■ Setting the shutter speed

Select a shutter speed of [15 SEC.], [30 SEC.] or [60 SEC.].

#### 1 Touch the number of seconds to select.

- It is also possible to change the number of seconds using the quick menu. (P22)

#### 2 Take pictures.

- Press the shutter button fully to display the countdown screen. Do not move the camera after this screen is displayed. When countdown finishes, [PLEASE WAIT...] is displayed for the same length of time as the set shutter speed for signal processing.
- Press [MENU/SET] to stop taking the picture while the countdown screen is displayed.

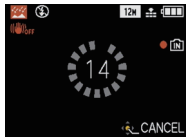

### ■ Technique for Starry Sky Mode

- The shutter opens for 15, 30 or 60 seconds. Be sure to use a tripod. We also recommend taking pictures with the self-timer.

#### Note

- The flash setting is fixed to [☹].
- The optical image stabilizer function is fixed to [OFF].
- ISO sensitivity is fixed to [ISO80].

## [FIREWORKS]

This mode allows you to take beautiful pictures of fireworks exploding in the night sky.

### ■ Technique for Fireworks Mode

- Since the shutter speed becomes slower, we recommend using a tripod.

#### Note

- The flash setting is fixed to [☹].
- This mode is most effective when the subject is 10 m (32.8 feet) or more away.
- The shutter speed becomes the following.
  - When [OFF] is set on the optical image stabilizer function: Fixed to 2 seconds
  - When [AUTO], [MODE1] or [MODE2] is set on the optical image stabilizer function: 1/4th of a second or 2 seconds (The shutter speed becomes 2 seconds only when the camera has determined that there is little jitter such as when using a tripod etc.)
  - You can change the shutter speed by compensating the exposure.
- The AF area is not displayed.
- ISO sensitivity is fixed to [ISO80].

 [SUNSET]

Select this when you want to take pictures of sunset view. This allows you to take vivid pictures of the red color of the sun.

 **Note**

- The flash setting is fixed to [☺].

 [BEACH]

This allows you to take even more vivid pictures of the blue color of the sea, sky etc. It also prevents underexposure of people under strong sunlight.

 **Note**

- The initial setting for [AF MODE] is [∞].
- Do not touch the camera with wet hands.
- Sand or seawater will cause the camera to malfunction. Make sure that sand or seawater does not get into the lens or the terminals.
- Problems caused by sand or seawater are not covered by the product warranty.

 [SNOW]

This allows you to take pictures that show the snow as white as possible at a ski resort or a snow-covered mountain.

 [AERIAL PHOTO]

This mode allows you to take pictures through an airplane window.

**■ Technique for Aerial Photo Mode**

- We recommend using this technique if it is difficult to focus when taking pictures of clouds etc. Aim the camera at something with high contrast, press the shutter button halfway to fix the focus and then aim the camera at the subject and press the shutter button fully to take the picture.

 **Note**

- The flash setting is fixed to [☺].
- The focus range is 5 m (16.4 feet) to ∞.
- Turn the camera off when taking off or landing.
- When using the camera, follow all instructions from the cabin crew.
- Be careful about the reflection from the window.



 [PIN HOLE]

Picture is taken darker and with soft focus around the subjects.

■ **Picture size and aspect ratio**

- 1 Touch the picture size and aspect ratio to select.**
  - 3M (4:3), 2.5M (3:2) or 2M (16:9) is selected as the picture size.
- 2 Take pictures.**

 **Note**

- [QUALITY] is automatically fixed to [..].
- You can take pictures suitable for 4"×6"/10×15 cm printing.
- The focus range is 5 cm (0.17 feet) (Wide)/1 m (3.28 feet) (Tele) to ∞.
- Face detection may not operate normally in the dark areas around the edges of the screen.

 [FILM GRAIN]

Picture is taken with a grainy texture as though blasted with sand.

■ **Picture size and aspect ratio**

- 1 Touch the picture size and aspect ratio to select.**
  - 3M (4:3), 2.5M (3:2) or 2M (16:9) is selected as the picture size.
- 2 Take pictures.**

 **Note**

- [QUALITY] is automatically fixed to [..].
- You can take pictures suitable for 4"×6"/10×15 cm printing.
- ISO sensitivity is fixed to [ISO1600].
- The focus range is 5 cm (0.17 feet) (Wide)/1 m (3.28 feet) (Tele) to ∞.



[REC] mode: 

## Motion Picture Mode

**1** Slide the [REC]/[PLAYBACK] selector switch to , and then press [MODE].

**2** Touch [MOTION PICTURE].

**3** Press the shutter button halfway to focus and then press it fully to start recording.

(A) Audio recording

- The available recording time (B) is displayed on the top right and the elapsed recording time (C) is displayed on the bottom right of the screen.
- After pressing the shutter button fully, release it straight away. If the button is held down, the sound will not be recorded for a few seconds when recording starts.
- When the subject is focused, the focus indication lights.
- The focus and zoom are fixed to the setting when recording starts (the first frame).
- The audio is also recorded simultaneously from the built-in microphone on this unit. (Motion pictures cannot be recorded without audio.)

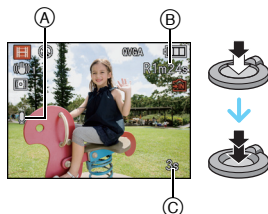

**4** Press the shutter button fully to stop recording.



- If the built-in memory or the card becomes full in the middle of recording, the camera stops recording automatically.

### Changing the settings for the recording quality

- When you set the recording quality to [HD], [WVGA] or [VGA], we recommend using a high-speed card with "10MB/s" or greater displayed on the package.

**1** Press [MENU/SET].

**2** Press / to select [REC QUALITY] and then press .

**3** Press / to select the item and then press [MENU/SET].

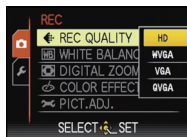

Item	Picture size	fps	Aspect ratio
HD *	1280×720 pixels	30	16:9
WVGA *	848×480 pixels	30	
VGA *	640×480 pixels	30	4:3
QVGA	320×240 pixels	30	

- [HD] can be enjoyed on the TV as high quality motion picture by using the component cable (DMW-HDC2; optional). Refer to “Playing back on the TV with component socket” (P111) for details.
- \*Cannot be recorded in the built-in memory.

#### 4 Press [MENU/SET] to close the menu.

- You can also press the shutter button halfway to close the menu.

#### Note

- **The flash setting is fixed to [☺].**
- Refer to P129 for information about the available recording time.
- The available recording time displayed on the screen may not decrease regularly.
- Depending on the type of the card, the card access indication may appear for a while after recording motion pictures. This is not a malfunction.
- Motion pictures can be recorded continuously up to 2 GB. The maximum available recording time for up to 2 GB only is displayed on the screen.
- When motion pictures recorded with the camera are played back on other equipment, the quality of the picture and sound may deteriorate and it may not be possible to play them back. Also the recording information may not be displayed correctly.
- Sound from motion pictures or pictures with audio recorded by this camera cannot be played back by older models of Panasonic digital camera (LUMIX) launched before July 2008.
- In Motion Picture Mode, the following functions cannot be used.
  - Touch AF/AE
  - Direction detection function
- In the Motion Picture Mode, [AF MODE] is fixed to [AF], [STABILIZER] to [MODE1].
- This unit does not support recording motion pictures on MultiMediaCards.
- Compared to still pictures, motion pictures may have a narrow angle of view.

[REC] mode: **IA PASM MIS SCN**

## Taking a picture with Face Recognition function

For details on [REC] mode menu settings, refer to P21.

### Face Recognition functions

Following [FACE RECOG.] functions will work when [FACE RECOG.] in [REC] mode menu is set to [ON].

- It will search for the face similar to the registered face, setting the focus and exposure preferentially.
- If a name is set for a registered face, the name is displayed when the camera detects the registered face.
- The camera will remember the face during the face recognition when the [AUTO REGISTRATION] is set to [ON], and detect the face that the picture is taken for many times automatically, displaying the face recognition registration screen.
- It is possible to display the name during playback, or only display image with that name with [CATEGORY PLAY]. (P89)



## Face settings

Up to 6 face images can be registered together with information such as name and birthday. It makes the recognition easier by registering multiple images of same person.

### ■ Registering from the [REC] mode menu

**1** Select [FACE RECOG.] on the [REC] mode menu and then press **▶**. (P21)

**2** Press **▲/▼** to select [SET] and then press [MENU/SET].



**3** Press **▲/▼** to select [MEMORY] and then press [MENU/SET].

- A list of registered people is displayed when there are 6 people already registered. Select the person to be replaced. Information of the person that was replaced will be deleted.

- To edit a face that is already registered, select [EDIT], select the person to edit, and perform the operation from step 6.



**4** Take the picture adjusting the face with the guide.

- The faces of subjects other than people (pets, etc.) cannot be registered.
- Take a picture of a face from the front

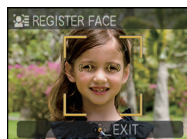

**5** Press **◀** to select [YES] and then press [MENU/SET].

## 6 Touch the item.

- [NAME]: The name can be registered.  
For details on how to enter characters, read the [TITLE EDIT] section on P94
- (A) Face image

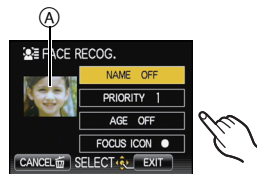

Edit screen

- [PRIORITY]: The focus and exposure are preferentially adjusted for higher-priority faces. The priority can be changed in following operation. Touch the position of priority you would like to move.
- [AGE]: Set the Year/Month/Day by touching [▲]/[▼] for each item, and touch [SET].
- [FOCUS ICON]: The focus icon that is displayed when the focus is set can be changed. Select and touch the focus icon.

- Face image can be retaken by touching (A) in the edit screen. Return to step 4 by touching [YES].

## 7 Touch [EXIT].

### ■ Registering from the automatic registration screen

When the [AUTO REGISTRATION] is set to [ON] in step 3 of the “Face settings”, the registration screen will display automatically after taking the picture of a face that has high number of appearance.

(If the same face is photographed 5 times, the camera will automatically display the registration screen. This function will not work if the Burst, Auto Bracket or Color Bracket is set.)

- 1 Press ◀ to select [YES] and then press [MENU/SET].
  - Selection screen is displayed again when [NO] is selected, and when [YES] is selected with ◀, [AUTO REGISTRATION] will be set to [OFF].

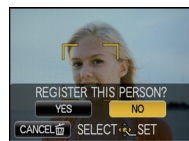

- 2 Use the operation in Step 6 and following in “Face settings”.

- Automatic register screen is not displayed when there are 6 people already registered.

### ■ Deleting information for registered faces

- 1 In Step 3 of “Face settings”, press to select [DELETE] and then press [MENU/SET].
- 2 Touch the image of the person to cancel.
- 3 Touch [YES].

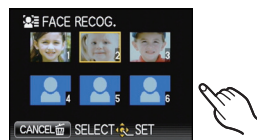

### Note

- [AF MODE] is fixed to [AF].
- Face Recognition may not be possible or may not recognize faces correctly even for registered faces in the following instances, depending on the facial expression and environment.
  - When the face is not facing the camera
  - When the face is at an angle
  - When the face is extremely bright or dark
  - Hidden by sunglasses, glasses reflecting light, hair, hat, etc.
  - When the face appears small on the screen
  - The entire face is not in the screen
  - When distinctive facial features have changed with age
  - Facial expression is very different
  - When there is little contrast on the faces
  - When there is rapid movement
  - When the camera is shaking
  - When digital zoom is used
- After pressing the shutter halfway down, a different person's picture information may be added when the camera is turned to a different subject to photograph.
- When a person who is registered is not recognized, correct by re-registering.
- [FACE RECOG.] can be used in the following Scene Modes.
  - [PORTRAIT]/[SOFT SKIN]/[SELF PORTRAIT]/[SCENERY]/[SPORTS]/[NIGHT PORTRAIT]/[PARTY]/[CANDLE LIGHT]/[BABY1]/[BABY2]/[PET]/[SUNSET]/[HIGH SENS.]/[BEACH]/[SNOW]/[PIN HOLE]
- Name registered with [FACE RECOG.] does not display for an image with names set in [BABY1]/[BABY2] and [PET] of the Scene Mode, [LOCATION] in travel date, or characters set in [TITLE EDIT].
- Software "PHOTOfunSTUDIO" in the CD-ROM (supplied) allows to check information of up to 3 people registered in one picture.

[REC] mode: 

## Useful Functions at Travel Destinations

### Recording which Day of the Vacation You Take the Picture

For details on the [SETUP] menu settings, refer to P21.

If you set the departure date or the travel destination of the vacation in advance, the number of days that have passed since the departure date (which day of the vacation it is) is recorded when you take the picture. You can display the number of days that have passed when playing back the pictures and stamp it on the recorded pictures with [TEXT STAMP] (P96).

- The number of days that have passed since the departure date can be printed out using the "PHOTOfunSTUDIO" bundled software on the CD-ROM (supplied).
- Select [CLOCK SET] to set the current date and time in advance. (P19)

- 1 Select [TRAVEL DATE] from the [SETUP] menu, and then press .

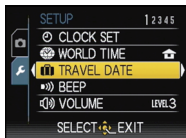

- 2 Press  to select [TRAVEL SETUP] and then press .

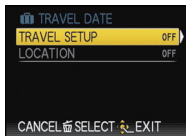

**3** Press **▼** to select [SET] and then press [MENU/SET].

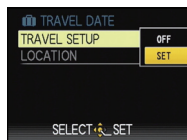

**4** Press **▲/▼/◀/▶** to set the departure date (year/month/day), and then press [MENU/SET].

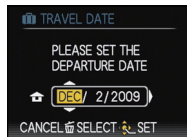

**5** Press **▲/▼/◀/▶** to set the return date (year/month/day), and then press [MENU/SET].

- If you do not want to set the return date, press [MENU/SET] while the date bar is displayed.

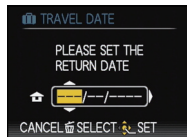

**6** Press **▼** to select [LOCATION] and then press **▶**.

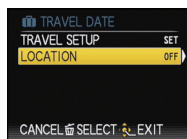

**7** Press **▼** to select [SET] and then press [MENU/SET].

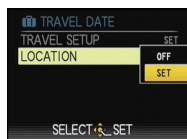

**8** Enter the location.

- 1 Press **▲/▼/◀/▶** to select text and then press [MENU/SET] to register.
  - 2 Press **▲/▼/◀/▶** to move the cursor to [EXIT] and then press [MENU/SET] to end text input.
- Press [DISPLAY] to switch text between [A] (capitals), [a] (lower case) and [&/1] (special characters and numbers).

**9** Press [MENU/SET] twice to close the menu.

**10** Take a picture.

- The number of days that have passed since the departure date is displayed for about 5 seconds if this unit is turned on etc. after setting the travel date or when the travel date is set.
- When the travel date is set, [ ] appears on the lower right of the screen.

#### ■ Canceling the travel date

The travel date is automatically canceled if the current date is after the return date. If you want to cancel the travel date before the end of the vacation, select [OFF] on the screen shown in step **3** or **7** and then press [MENU/SET] twice. If the [TRAVEL SETUP] is set to [OFF] in step **3**, [LOCATION] will be also set to [OFF].

## Note

- The travel date is calculated using the date in the clock setting and the departure date you set. If you set [WORLD TIME] (P72) to the travel destination, the travel date is calculated using the date in the clock setting and the travel destination setting.
- The travel date setting is memorized even if the camera is turned off.
- If [TRAVEL DATE] is set to [OFF], the number of days that have passed since the departure date will not be recorded even if you set the travel date or the return date. Even if [TRAVEL DATE] is set to [SET] after taking the pictures, which day of the vacation you took them is not displayed.
- If you set a departure date and then take a picture on a date before this departure date, [-] (minus) is displayed in orange and the day of the vacation on which you took the picture is not recorded.
- If the travel date is displayed as [-] (minus) in white, there is a time difference that involves date change between the [HOME] and [DESTINATION]. (It will be recorded)
- The text set as [LOCATION] can be edited later with [TITLE EDIT].
- The names for [BABY1]/[BABY2] and [PET] will not be recorded when [LOCATION] is set.
- [LOCATION] cannot be recorded when taking motion pictures.
- Intelligent Auto Mode cannot be set. Setting of other Recording Mode will be reflected.

## Recording Dates/Times at Overseas Travel Destinations (World Time)

For details on the [SETUP] menu settings, refer to P21.

You can display the local times at the travel destinations and record them on the pictures you take.

- Select [CLOCK SET] to set the current date and time in advance. (P19)

### 1 Select [WORLD TIME] from the [SETUP] menu, and then press ►.

- When first using the camera after purchasing it, the [PLEASE SET THE HOME AREA] message appears. Press [MENU/SET], and set the home area on the screen in step 3.

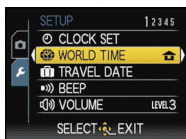

### 2 Press ▼ to select [HOME], and then press [MENU/SET].

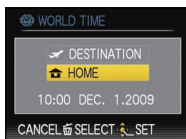

### 3 Press ◀/▶ to select the home area, and then press [MENU/SET].

- Ⓐ Current time
- Ⓑ Time difference from GMT (Greenwich Mean Time)
- If daylight saving time [☀/☿] is used at the home area, press ▲. Press ▲ again to return to the original time.
- The daylight saving time setting for the home area does not advance the current time. Advance the clock setting by one hour.



### 4 Press ▲ to select [DESTINATION] and then press [MENU/SET] to set.

- Ⓒ Depending on the setting, the time at the travel destination area or the home area is displayed.

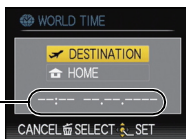



**5** Press **◀▶** to select the area the travel destination is in and then press **[MENU/SET]** to set.

Ⓓ Current time of the destination area

Ⓔ Time difference

- If daylight saving time [**☀**] is used at the travel destination, press **▲**. (The time advances by one hour.) Press **▲** again to return to the original time.

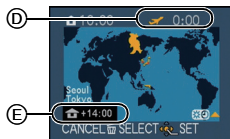

**6** Press **[MENU/SET]** to close the menu.

#### Note

- Return the setting to [HOME] when the vacation is finished by performing steps **1**, **2** and **3**.
- If [HOME] is already set, change only the travel destination, and use.
- If you cannot find the travel destination in the areas displayed on the screen, set by the time difference from the home area.
- The travel destination icon [**✈**] appears when playing back pictures taken at the travel destination.

## Using the [REC] Mode Menu

### **[PICTURE SIZE]**

For details on [REC] mode menu settings, refer to **P21**.

Set the number of pixels. The higher the numbers of pixels, the finer the detail of the pictures will appear even when they are printed onto large sheets.

Applicable modes: **IA PASM MS SCN**

■ When the aspect ratio is **[4:3]**.

\* This item cannot be set in the Intelligent Auto Mode.

<b>12M</b> (12M)	4000×3000 pixels
<b>8M</b> (8M <b>3/4</b> )*	3264×2448 pixels
<b>5M</b> (5M <b>3/4</b> )	2560×1920 pixels
<b>3M</b> (3M <b>3/4</b> )	2048×1536 pixels
<b>2M</b> (2M <b>3/4</b> )*	1600×1200 pixels
<b>0.3M</b> (0.3M <b>3/4</b> )*	640×480 pixels

■ When the aspect ratio is **[3:2]**.

<b>10.5M</b> (10.5M)	4000×2672 pixels
<b>7M</b> (7M <b>3/4</b> )*	3264×2176 pixels
<b>4.5M</b> (4.5M <b>3/4</b> )*	2560×1712 pixels
<b>2.5M</b> (2.5M <b>3/4</b> )*	2048×1360 pixels

## ■ When the aspect ratio is [16:9].

<b>9M</b> (9M)*	4000×2248 pixels
<b>6M</b> (6M <del>3Z</del> )*	3264×1840 pixels
<b>3.5M</b> (3.5M <del>3Z</del> )*	2560×1440 pixels
<b>2M</b> (2M <del>3Z</del> )	1920×1080 pixels

### Note

- “EZ” is an abbreviation of “Extended Optical Zoom”.
- A digital picture is made of numerous dots called pixels. The higher the numbers of pixels, the finer the picture will be when it is printed on a large piece of paper or displayed on a PC monitor.

- (A) Many pixels (Fine)  
(B) Few pixels (Rough)

\*These pictures are examples to show the effect.

- If you change the aspect ratio, set the picture size again.
- The extended optical zoom does not work when macro zoom is set or in [TRANSFORM], [HIGH SENS.], [HI-SPEED BURST], [FLASH BURST], [PIN HOLE] or [FILM GRAIN] in Scene Mode so the picture size for [~~3Z~~] is not displayed.
- Pictures may appear mosaic depending on the subject and the recording conditions.
- Refer to P127 for information about the number of recordable pictures.

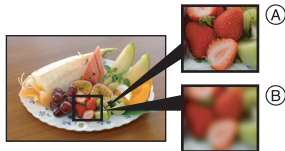

## 📊 [QUALITY]

For details on [REC] mode menu settings, refer to P21.

Set the compression rate at which the pictures are to be stored.

Applicable modes: **PASM** **MS** **SCN**

[📊]: Fine (when giving priority to the picture quality)

[📉]: Standard (when using the standard picture quality and increasing the number of pictures to be recorded without changing the number of pixels)

### Note

- Refer to P127 for information about the number of recordable pictures.

## 📏 [ASPECT RATIO]

For details on [REC] mode menu settings, refer to P21.

This allows you to select the aspect ratio of the pictures to suit printing or the playback method.

Applicable modes: **PASM** **MS** **SCN**

[4:3]: [ASPECT RATIO] of a 4:3 TV

[3:2]: [ASPECT RATIO] of a 35 mm film camera

[16:9]: [ASPECT RATIO] of a high-definition TV, etc.

[4:3]



[3:2]

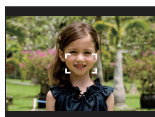

[16:9]



### Note

- The ends of the recorded pictures may be cut at printing so check before printing. (P124)

## ISO [INTELLIGENT ISO]

For details on [REC] mode menu settings, refer to P21.

The camera automatically sets the optimum ISO sensitivity and shutter speed to suit the movement of the subject and brightness of the scene to minimize the jitter of the subject.

Applicable modes: **PA**

[OFF]/[ON]

### Note

- Depending on the brightness and how fast the subject is moving, jitter may not be avoided.
- Movements may not be detected when a moving subject is small, when a moving subject is at the edge of the screen or when a subject has moved at the very moment when the shutter button was pressed fully.
- When [INTELLIGENT ISO] is [ON], the maximum ISO sensitivity is limited to the value set in [ISO LIMIT SET]. When [ISO LIMIT SET] is set to [AUTO], the ISO limit is set automatically up to a maximum of [ISO1600].

## ISO [SENSITIVITY]

For details on [REC] mode menu settings, refer to P21.

This allows the sensitivity to light (ISO sensitivity) to be set. Setting to a higher figure enables pictures to be taken even in dark places without the resulting pictures coming out dark.

Applicable modes: **PASM**

[AUTO]/[80]/[100]/[200]/[400]/[800]/[1600]

ISO sensitivity	80  1600	
Recording location (recommended)	When it is light (outdoors)	When it is dark
Shutter speed	Slow	Fast
Noise	Less	Increased

### Note

- When setting to [AUTO], ISO sensitivity is automatically adjusted to the maximum of the value set in [ISO LIMIT SET] (excluding [AUTO]).
- The setting is not available when [INTELLIGENT ISO] is being used. ([i ISO] is displayed.)
- If picture noise becomes a problem, we recommend that you take pictures after lowering the ISO sensitivity level, increasing the setting for [NOISE REDUCTION] under [PICT.ADJ.], or lowering the setting for each of the items other than [NOISE REDUCTION]. (P81)

## ISO [ISO LIMIT SET]

For details on [REC] mode menu settings, refer to P21.

Most appropriate sensitivity within the range set will be set depending on the brightness of the subject.

Applicable modes: **PASM**

[AUTO]/[200]/[400]/[800]/[1600]

- The upper limit of the ISO sensitivity can be set.
- The higher the value set for the ISO sensitivity, the more the jitter is reduced but the greater the amount of picture noise.

### Note

- This will work when the [SENSITIVITY] is set to [AUTO] or when the Intelligent ISO is set to [ON].
- When [SENSITIVITY] is set to [AUTO], and [ISO LIMIT SET] is set to [AUTO], the ISO sensitivity is automatically set to a maximum of [ISO400] ([ISO1000] when the flash is used) according to the brightness.

## WB [WHITE BALANCE]

For details on [REC] mode menu settings, refer to P21.

In sunlight, under incandescent lights or in other such conditions where the color of white takes on a reddish or bluish tinge, this item adjusts to the color of white which is closest to what is seen by the eye in accordance with the light source.

Applicable modes: **PASMMS SCN**

[AWB]: Automatic adjustment

: When taking pictures outdoors under a clear sky

: When taking pictures outdoors under a cloudy sky

: When taking pictures outdoors in the shade

: When taking pictures under incandescent lights

: When using the preset white balance

[SETK]: When using the preset color temperature setting

- The optimal white balance will differ depending on the type of halogen lighting being recorded under so use [AWB] or .
- The white balance setting is memorized even if the camera is turned off. (However, the white balance setting for a Scene Mode returns to [AWB] when the Scene Mode is changed.)
- In the Scene Modes listed below, white balance is fixed to [AWB].
  - [SCENERY]/[NIGHT PORTRAIT]/[NIGHT SCENERY]/[FOOD]/[PARTY]/[CANDLE LIGHT]/[SUNSET]/[FLASH BURST]/[STARRY SKY]/[FIREWORKS]/[BEACH]/[SNOW]/[AERIAL PHOTO]/[FILM GRAIN]

### ■ Setting the white balance manually

This will set the values for the white balance. Use it in accordance with the recording conditions.

- 1 Select and then press **▶**.
- 2 Aim the camera at a sheet of white paper etc. so that the frame in the center is filled by the white object only and then press [MENU/SET].



### ■ Finely adjusting the white balance

You can finely adjust the white balance when you cannot acquire the desired hue by setting the white balance.

- It can be set from the quick menu (P22).

- 1 Select [WHITE BALANCE] and then press **▶**
  - Press **▶** again if or [SETK] is selected.
- 2 Touch within the frame to finely adjust.
  - You can finely adjust also by touching [G+]/[M-]/[A]/[B], or pressing **▲/▼/◀/▶** of the cursor button.
    - ◀ : A (AMBER: ORANGE)
    - ▶ : B (BLUE: BLUISH)
    - ▲ : G+ (GREEN: GREENISH)
    - ▼ : M- (MAGENTA: REDDISH)



- 3 Touch [SET].

- If you finely adjust the white balance to A (amber), the white balance icon on the LCD monitor will change to orange. If you finely adjust the white balance to B (blue), the white balance icon on the LCD monitor will change to blue.
- If you finely adjust the white balance to G+ (green) or M- (magenta), [+ ] (green) or [- ] (magenta) appears beside the white balance icon on the LCD monitor.
- Select the center point if you are not finely adjusting the white balance.
- You can finely adjust the white balance independently for each white balance item.
- The white balance fine adjustment setting is reflected in the picture when using the flash.
- The white balance fine adjustment setting is memorized even if the camera is turned off.
- The white balance fine adjustment level returns to the standard setting (center point) in the following cases.
  - When you reset the white balance in [WB]
  - When you reset the color temperature manually in [SET/K]
- White balance fine adjustment cannot be set for [B/W], [SEPIA], [COOL] and [WARM] in [COLOR EFFECT].

### Auto white balance

Depending on the conditions prevailing when pictures are taken, the pictures may take on a reddish or bluish tinge. Furthermore, when a multiple number of light sources are being used or there is nothing with a color close to white, auto white balance may not function properly. In a case like this, set the white balance to a mode other than [AWB].

1 Auto white balance will work within this range.

- 2 Blue sky
- 3 Cloudy sky (Rain)
- 4 Shade
- 5 TV screen
- 6 Sunlight
- 7 White fluorescent light
- 8 Incandescent light bulb
- 9 Sunrise and sunset
- 10 Candlelight

K=Kelvin Color Temperature

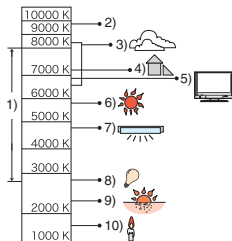

### Setting the color temperature

You can set the color temperature manually for taking natural pictures in different lighting conditions. The color of light is measured as a number in degrees Kelvin. As the color temperature becomes high the picture becomes bluish and as the color temperature becomes low the picture becomes reddish.

1 Select [SET/K] and then press ►.

2 Touch the color temperature setting bar.

- It is also possible to set the values by touching [▲]/[▼] or pressing ▲/▼ of the cursor button.
- You can set a color temperature from [2500K] to [10000K].

3 Touch [SET].

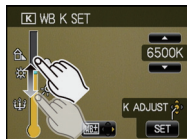

### [FACE RECOG.]

For details on [REC] mode menu settings, refer to P21.

Specify a person's face and use the face recognition functions.

Applicable modes: [TA] [PASM] [MS] [SCN]

[OFF]/[ON]/[SET]

### Note

- Refer to P67 for details.

## AF [AF MODE]

**For details on [REC] mode menu settings, refer to P21.**

This allows the focusing method that suits the positions and number of the subjects to be selected.

**Applicable modes:** PASM MS SCN

[👤]: Face detection	The camera automatically detects the person's face. The focus and exposure can then be adjusted to fit the face no matter what portion of the picture it is in. (max. 15 areas)
[📷]: 11-area-focusing	The camera focuses on any of 11 focus areas. This is effective when the subject is not in the center of the screen.
[📷]: 1-area-focusing (High speed)	The camera quickly focuses on the subject in the AF area on the center of the screen.
[📷]: 1-area-focusing	The camera focuses on the subject in the AF area on the center of the screen.
[📷]: Spot-focusing	The camera focuses on a limited narrow area in the screen.

### Note

- The camera is focusing on all the AF areas when multiple AF areas (max. 11 areas) light at the same time in [📷]. If you want to determine the focus position to take pictures, switch the AF mode to [📷], [📷] or [📷].
- If the AF mode is set to [📷], the AF area is not displayed until the picture is brought into focus.
- Switch the AF mode to [📷] or [📷] if it is difficult to focus using [📷].
- The camera may detect the subjects other than a person as the face. In this case, switch the AF mode to any modes other than [👤] and then take a picture.
- It will be fixed to [👤] when the [FACE RECOG.] is set to [ON].
- The AF mode cannot be set in [FIREWORKS] in Scene Mode.
- It is not possible to set [👤] in the following cases.
  - In [PANORAMA ASSIST], [NIGHT SCENERY], [FOOD], [STARRY SKY] and [AERIAL PHOTO] in Scene Mode.

### About [👤]

The following AF area frames are displayed when the camera detects the faces.

Yellow:

When the shutter button is pressed halfway, the frame turns green when the camera is focused.

White:

Displayed when more than one face is detected. Other faces that are the same distance away as faces within the yellow AF areas are also focused.

- Under certain picture-taking conditions including the following cases, the facial recognition function may fail to work, making it impossible to detect faces. [AF MODE] is switched to [📷].
  - When the face is not facing the camera
  - When the face is at an angle
  - When the face is extremely bright or dark
  - When there is little contrast on the faces
  - When the facial features are hidden behind sunglasses, etc.
  - When the face appears small on the screen
  - When there is rapid movement
  - When the subject is other than a human being
  - When the camera is shaking
  - When digital zoom is used

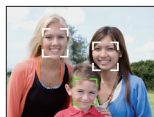

## ■ About [QAF]

- You can focus on the subject more quickly than in other AF modes.
- The picture may stop moving for a moment before being brought into focus when you press the shutter button halfway. This is not a malfunction.

## QAF [QUICK AF]

For details on [REC] mode menu settings, refer to P21.

As long as the camera is held steady, the camera will automatically adjust the focus and focus adjustment will then be quicker when the shutter is pressed. This is useful at times when, for instance, you do not want to miss a picture-taking opportunity.

Applicable modes: **PASM** **MS** **SCN**

[OFF]/[ON]

### Note

- When [ON] is set, [QAF] is displayed on the screen.
- It does not operate during Touch AF/AE.
- [QUICK AF] can not be set with [NIGHT PORTRAIT], [NIGHT SCENERY], [STARRY SKY], [FIREWORKS] in Scene Mode.

## [METERING MODE]

For details on [REC] mode menu settings, refer to P21.

Type of optical measurement to measure brightness can be changed.

Applicable modes: **PASM**

[M]: Multiple

This is the method in which the camera measures the most suitable exposure by judging the allocation of brightness on the whole screen automatically. Usually, we recommend using this method.

[C]: Center weighted

This is the method used to focus on the subject on the center of the screen and measure the whole screen evenly.

[S]: Spot

This is the method to measure the subject in the spot metering target **(A)**.

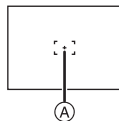

### Note

- Metering mode is fixed to [M] in Intelligent Auto Mode.
- When [M] is selected and [AF MODE] is set to [AF], the camera will adjust the exposure to suit the person's face.



## [I.EXPOSURE]

For details on [REC] mode menu settings, refer to P21.

Contrast and exposure will be adjusted automatically when there is a big difference in brightness between the background and subject, to bring the image close to how you see.

**Applicable modes:** **PASM**  
[OFF]/[LOW]/[STANDARD]/[HIGH]

### Note





- When it is set to [LOW], [STANDARD] or [HIGH],  is displayed on the screen.
- Even when the [SENSITIVITY] is set to [ISO80]/[ISO100], [SENSITIVITY] may be set higher than [ISO80]/[ISO100] if the picture is taken with [I.EXPOSURE] set to valid.
- Compensation effect may not be achieved depending on the conditions.
-  in the screen turns to yellow when [I.EXPOSURE] is in effect.

## [BURST]

For details on [REC] mode menu settings, refer to P21.

Pictures are taken continuously while the shutter button is pressed.  
Select the ones you really like from among the pictures you have taken.

**Applicable modes:**  **PASM**  



		[OFF]		
<b>Burst speed (pictures/second)</b>		—	approx. 2.3*	approx. 1.8
<b>Number of recordable pictures</b>		—	max. 3	Depends on the remaining capacity of the built-in memory/card.
		—	max. 5	

\* The burst speed is constant regardless of the transfer speed of the card.

- The burst speed values given above apply when the shutter speed is 1/60 or faster and when the flash is not activated.

### Note

#### • When the Burst Mode setting is set to Unlimited

- **The burst speed becomes slower halfway.** The exact timing of this depends on the type of card, the picture size and the quality.
- You can take pictures until the capacity of the built-in memory or the card is full.
- The focus is fixed when the first picture is taken.
- When the burst speed is set to , the exposure and white balance are fixed at the settings used for the first picture for the subsequent pictures as well. When the burst speed is set to , they are adjusted each time you take a picture.
- When the self-timer is used, the number of recordable pictures in Burst Mode is fixed to 3.
- If you are following a moving subject while taking pictures in a place (landscape) indoors, outdoors etc. where there is a large difference between the light and shade, it may take time until the exposure is stable. If burst is used at this time, the exposure may not become optimal.
- The burst speed (pictures/second) may become slower depending on the recording environment such as in dark places, if the ISO sensitivity is high, etc.
- Burst Mode is not canceled when the camera is switched off.
- If you take pictures in Burst Mode with the built-in memory, it will take time to write the picture data.
-  is set for the flash when burst is set.
- **Auto bracket/color bracket is canceled when burst is set.**
- Burst cannot be used in [TRANSFORM], [PANORAMA ASSIST], [HI-SPEED BURST], [FLASH BURST], [STARRY SKY], [PIN HOLE] or [FILM GRAIN] in Scene Mode.



 [DIGITAL ZOOM]

For details on [REC] mode menu settings, refer to P21.

This can enlarge subjects even more than the optical zoom or extended optical zoom.

Applicable modes: **P A S M** MS SCN REI

[OFF]/[ON]

 **Note**

- Refer to P34 for details.
- If camera shake (jitter) is a problem during zooming, it is recommended that [STABILIZER] be set to [AUTO] or [MODE 1].
- The setting is fixed to [ON] in Macro Zoom Mode.

 [COLOR EFFECT]

For details on [REC] mode menu settings, refer to P21.

Setting color effects for the recorded pictures.

Applicable modes: **I A P A S M** REI

- [OFF]: This is the standard setting.
- [B/W]: The picture becomes black and white.
- [SEPIA]: The picture becomes sepia.
- [COOL]: The picture becomes bluish.
- [WARM]: The picture becomes reddish.

 **Note**

- When in Intelligent Auto Mode, only [B/W] or [SEPIA] can be selected.
- The Intelligent Auto Mode is set separately from the other Recording Modes.
- [COLOR EFFECT] becomes disabled when color effect is set.

 [PICT.ADJ.]

For details on [REC] mode menu settings, refer to P21.

Adjusting the picture quality for the recorded pictures.

Applicable modes: **P A S M**

[CONTRAST]:

- [+]: Increases the difference between the brightness and the darkness in the picture.
- [-]: Decreases the difference between the brightness and the darkness in the picture.

[SHARPNESS]:

- [+]: The picture is sharply defined.
- [-]: The picture is softly focused.

[SATURATION]:

- [+]: The colors in the picture become vivid.
- [-]: The colors in the picture become natural.

[NOISE REDUCTION]:

- [+]: The noise reduction effect is enhanced.  
Picture resolution may deteriorate slightly.
- [-]: The noise reduction effect is reduced.  
You can obtain pictures with higher resolution.

### Note

- When you take pictures in dark places, picture noise may become noticeable. If picture noise becomes a problem, we recommend that you take pictures after increasing the setting for [NOISE REDUCTION] or lowering the setting for each of the items other than [NOISE REDUCTION].

## [STABILIZER]

For details on [REC] mode menu settings, refer to P21.

Using one of these modes, jitter during picture taking is detected, and the camera automatically compensates for the jitter, enabling jitter-free images to be taken.

Applicable modes: **PASM** **MS** **SCN**

[OFF]

[AUTO]: The optimum jitter compensation is selected depending on the condition.

[MODE1]: Jitter is always compensated during [REC] mode.

[MODE2]: The jitter is compensated for when the shutter button is pressed.

### Note

- The stabilizer function may not be effective in the following cases.
  - When there is a lot of jitter.
  - When the zoom magnification is high.
  - In digital zoom range.
  - When taking pictures while following a moving subject.
  - When the shutter speed becomes slower to take pictures indoors or in dark places.
- Be careful of camera jitter when you press the shutter button.
- The setting is fixed to [MODE2] with [SELF PORTRAIT] in Scene Mode and to [OFF] in [STARRY SKY] in Scene Mode.
- The setting is fixed to [MODE1] in Motion Picture Mode.

## [MIN. SHTR SPEED]

For details on [REC] mode menu settings, refer to P21.

You can take a picture brightly in dark places by setting [MIN. SHTR SPEED] slower. Also, you can set it faster to reduce the blur of the subject.

Applicable modes: **P**

[1/250]/[1/125]/[1/60]/[1/30]/[1/15]/[1/8]/[1/4]/[1/2]/[1]

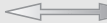
Minimum shutter speed setting	1/250		1
Brightness	Darker		Brighter
Jitter	Less		More



### Note

- This should usually be set to [1/8] to take pictures. (When you select a minimum shutter speed other than [1/8], **[MIN]** appears on the screen.)
- Setting [MIN. SHTR SPEED] to slower speed might increase the chance of jitter, so we recommend using a tripod and the self-timer for taking pictures.
- Setting [MIN. SHTR SPEED] to faster speed might make the picture darker, so we recommend recording the picture in well-lit area. If correct exposure cannot be achieved, **[MIN]** will flash in red when the shutter button is pressed halfway.
- The setting is not available when [INTELLIGENT ISO] is being used.

## [AUDIO REC.]

For details on [REC] mode menu settings, refer to P21.

Audio can be recorded simultaneously with the image. You can record the conversation during the shooting or the situation as a memo.

Applicable modes: **PASMMS**  

**[OFF]:** Audio will not be recorded.

**[ON]:**  is displayed on the screen.  
Audio will be recorded as soon as the image is recorded.  
(It will stop in 5 seconds.)

- If you press [MENU/SET] during audio recording, the audio recording is canceled.

### Note

- Audio is recorded from the built-in microphone on the camera.
- Audio recorded with this unit may not playback on other equipment.
- Sound from motion pictures or pictures with audio recorded by this camera cannot be played back by older models of Panasonic digital camera (LUMIX) launched before July 2008.
- [AUDIO REC.] cannot be set in the following cases.
  - When auto bracket/color bracket has been set
  - When the Burst Mode is set
  - [PANORAMA ASSIST], [HI-SPEED BURST], [FLASH BURST] and [STARRY SKY] in Scene Mode

## AF\* [AF ASSIST LAMP]

For details on [REC] mode menu settings, refer to P21.

Illuminating the subject makes it easier for the camera to focus when recording in low light conditions that make focusing difficult.

Applicable modes: **PASMMS**  

**[OFF]:** The AF assist lamp does not turn on.

**[ON]:** When taking pictures in dark places, the AF assist lamp lights while the shutter button is pressed halfway. (Larger AF areas are now displayed.)

### Note

- The effective range of the AF assist lamp is 1.5 m (4.92 feet).
- When you do not want to use the AF assist lamp  (e.g. when taking pictures of animals in dark places), set the [AF ASSIST LAMP] to [OFF]. In this case, it will become more difficult to focus on the subject.
- [AF ASSIST LAMP] is fixed to [OFF] in [SELF PORTRAIT], [SCENERY], [NIGHT SCENERY], [SUNSET], [FIREWORKS] and [AERIAL PHOTO] in Scene Mode.

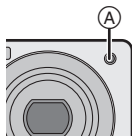

## [CLOCK SET]

For details on [REC] mode menu settings, refer to P21.

To set the year, month, day and time.

It functions in exactly the same way as [CLOCK SET] (P23) in the [SETUP] menu.

[PLAYBACK] mode: 

## Playing Back Pictures in Sequence (Slide Show)

You can play back the pictures you have taken in synchronisation with music, and you can do this in sequence while leaving a fixed interval between each of the pictures. Furthermore, you can play back the pictures grouped together by category or play back only those pictures you have set as favorites as a slide show.

This playback method is recommended when you have connected the camera to a TV set to view the pictures you have taken.

**1** Slide the [REC]/[PLAYBACK] selector switch to [, and then press [MODE].

**2** Touch [SLIDE SHOW].



**3** Touch the item.

- [ALL]:** Every picture is played back as a slide show.
- [FAVORITE]:** Pictures with [] are played back as a slide show. It can be selected only if there are pictures already set as [FAVORITE].
- [CATEGORY]:** Touch the category to playback. Selected category will be played back as a slide show.

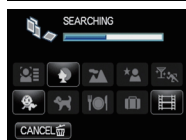

**4** Touch [START].

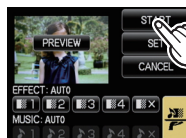

**5** Touch [EXIT] to finish the slide show.

- Normal playback resumes after the slide show finishes.

## ■ Operations performed during slide show

### 1 Display control panel by touching screen.

- If no operation is done for 2 seconds, it will return to original status.

(A) Control panel

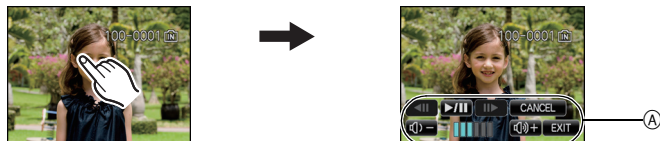

### 2 Operate control panel by touching.

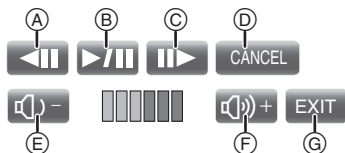

(A) Back to previous picture\*

(B) Play/Pause

(C) Ahead to next picture\*

(D) Return to slide show set screen

(E) Reduce volume level

(F) Increase volume level

(G) Exit slide show

\* These operations can be performed only in the Pause Mode.

## ■ Changing the slide show settings

You can change the settings for [EFFECT] and [MUSIC] during the slide show playback on the slide show set screen.

### [EFFECT]

This allows you to select the screen effect when switching from one picture to the next.

[NATURAL], [SLOW], [SWING], [URBAN], [OFF]

- When [URBAN] has been selected, the picture may appear in black and white as a screen effect.

### [MUSIC]

The following music can be selected to play during slide show playback:

[NATURAL], [SLOW], [SWING], [URBAN], [OFF]

- [PREVIEW] ([AUTO]) can be used only if [CATEGORY] is selected. It will be played back with [EFFECT] and [MUSIC] set for each category automatically.
- Preview screen is displayed when [PREVIEW] is touched. Touch [CANCEL] to cancel the preview.
- [MUSIC] with the same name will be set for the selected [EFFECT]. Select [MUSIC] after selecting [EFFECT].

### [SET]

[DURATION] or [REPEAT] etc. can be set.

Item	Settings
[DURATION]	1SEC/2SEC/3SEC/5SEC
[REPEAT]	ON/OFF
[AUDIO]	ON/OFF

- [DURATION] can be set only when [EFFECT] is set to [OFF].

- [AUDIO] will be displayed only when the [MUSIC] is set to [OFF]. Audio will be played along with the still picture with audio by setting the [AUDIO] to [ON].

### Note

- It is not possible to add new music effects.

### Slide show set screen



[PLAYBACK] mode: 

## Displaying Multiple Pictures ([MULTI PLAYBACK])

**1** Slide the [REC]/[PLAYBACK] selector switch to , and then press [MODE].



**2** Touch [MULTI PLAYBACK].

(A) Number of the selected picture and the total number of recorded pictures

(B) Slide bar

• You can also turn the zoom lever several times toward  (W) to switch to multiple screen.

**3** Touch the picture to select.

• The screen can be switched to 12 screens by touching  and to 30 screens by touching .

• Screen can be switched by dragging the slide bar up or down (P12).

• The screen can be switched gradually by dragging the screen up or down (P12).



[PLAYBACK] mode: 

## Displaying Pictures by Recording Date

### ([CALENDAR])

You can display pictures by recording date.

**1** Slide the [REC]/[PLAYBACK] selector switch to , and then press [MODE].

**2** Touch [CALENDAR].

- You can also turn the zoom lever for several times toward  (W) to switch to calendar screen.

**3** Touch the date to play back.

- (A): Previous month
- (B): Next month

- If there were no pictures recorded during a month, that month is not displayed.

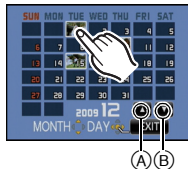

**4** Touch the picture to select.

- (C): Slide bar

- It will return to normal playback by touching [EXIT].
- Screen can be switched by dragging the slide bar up or down (P12).
- The screen can be switched gradually by dragging the screen up or down (P12).



#### Note

- The recording date of the picture selected in the playback screen becomes the date selected when the calendar screen is first displayed.
- If there are multiple pictures with the same recording date, the first picture recorded on that day is displayed.
- You can display the calendar between January 2000 and December 2009.
- If the date is not set in the camera, the recording date is set as January 1st, 2009.
- If you take pictures after setting the travel destination in [WORLD TIME], the pictures are displayed by the dates at the travel destination in calendar playback.

[PLAYBACK] mode: 

## Playing Back Pictures on the Dual Display ([DUAL PLAY])

You can display two recorded pictures on the screen to compare them.

**1** Slide the [REC]/[PLAYBACK] selector switch to , and then press [MODE].

**2** Touch [DUAL PLAY].



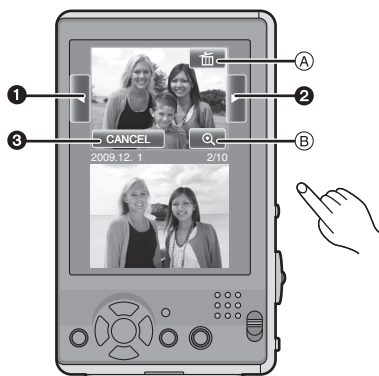

- You cannot select [DUAL PLAY] if there are no recorded pictures or only 1 recorded picture.

**3** Touch a picture to select from above or below.



- 1** The previous picture is displayed.
- 2** The next picture is displayed.
- 3** It will return to [PLAYBACK] Mode selection screen.

- A** Delete (P40, 98)
- B** Touch zoom (P37)

- A picture can be selected also by pressing ///.
- Pictures cannot be scrolled by dragging.
- You cannot display the same picture on the dual display at the same time.

### Note

- [PLAYBACK] mode menu (P100) and [SETUP] menu cannot be used.
- When [ROTATE DISP.] is set to [ON], pictures which were recorded with the camera held vertically will be displayed vertically.



[PLAYBACK] mode: 

## Selecting Pictures and Playing them Back

### ([CATEGORY PLAY]/[FAVORITE PLAY])

#### [CATEGORY PLAY]

This mode allows you to search images by Scene Mode or other categories (such as [PORTRAIT], [SCENERY] or [NIGHT SCENERY]) and sort the pictures into each of the categories. You can then play back the pictures in each category.





**1** Slide the [REC]/[PLAYBACK] selector switch to , and then press [MODE].



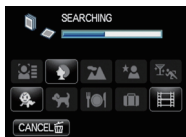



**2** Touch [CATEGORY PLAY].

**3** Touch the category to playback.

- A category can be played back only if it contains a picture.
- It may take time to search the picture files if there are a lot on the card or the built-in memory.
- If you touch [CANCEL] during searching, it will stop halfway.
- Pictures are sorted into the categories shown below.



[CATEGORY]	Recording information e.g. Scene Modes
	[FACE RECOG.]*
	[PORTRAIT], [i-PORTRAIT], [SOFT SKIN], [TRANSFORM], [SELF PORTRAIT], [NIGHT PORTRAIT], [i-NIGHT PORTRAIT], [BABY1]/[BABY2], [i-BABY]
	[SCENERY], [i-SCENERY], [SUNSET], [AERIAL PHOTO]
	[NIGHT PORTRAIT], [i-NIGHT PORTRAIT], [NIGHT SCENERY], [i-NIGHT SCENERY], [STARRY SKY]

[CATEGORY]	Recording information e.g. Scene Modes
	[SPORTS], [PARTY], [CANDLE LIGHT], [FIREWORKS], [BEACH], [SNOW], [AERIAL PHOTO]
	[BABY1]/[BABY2], [i-BABY]
	[PET]
	[FOOD]
	[TRAVEL DATE]
	[MOTION PICTURE]

- \* Playback by selecting and touching the picture of the person you desire to playback. Face Recognition may not be possible or may not recognize faces correctly even for registered faces, depending on the facial expression and environment.

## [FAVORITE PLAY]

Pictures that are set as [FAVORITE] (P91) can be played back. (Only if there are pictures already set as [FAVORITE])

**1** Slide the [REC]/[PLAYBACK] selector switch to [▶], and then press [MODE].

**2** Touch [FAVORITE PLAY].

**Note**

• You can use only [EDIT], [ROTATE DISP.], [PRINT SET] or [AUDIO DUB.] in the [PLAYBACK] menu.

[PLAYBACK] mode: [▶]

## Organizing pictures ([EASY ORG.]

Favorite setting of the picture, editing and deleting can be done easily by using the touch panel.

**1** Slide the [REC]/[PLAYBACK] selector switch to [▶], and then press [MODE].

**2** Touch [EASY ORG.].

## ■ [EASY ORG.] Screen



- (A) The previous picture is displayed.
- (B) The next picture is displayed.
- (C) Items
- (D) Thumbnail
- (E) Return to normal playback.
- (F) The main image

• Picture can be forwarded/rewound also by pressing ◀/▶.

Items	
★	[FAVORITE] (P91)
📄	[RESIZE] (P92)
	[TRIMMING] (P93)
	[LEVELING] (P94)
	[TITLE EDIT] (P94)
	[TEXT STAMP] (P96)
	[PROTECT] (P97)
🗑️	[DELETE] (P98)

**Note**

- With [TEXT STAMP], [RESIZE], [TRIMMING] or [LEVELING] a new edited picture is created. A new picture cannot be created if there is no free space on the built-in memory or the card so we recommend checking that there is free space and then editing the picture.
- [PLAYBACK] mode menu (P100) and [SETUP] menu cannot be used.

## ★ [FAVORITE]

You can do the following if a mark has been added to pictures and they have been set as favorites.

- Play back only the pictures set as favorites. ([FAVORITE PLAY])
- Play back the pictures set as favorites only as a slide show.
- Delete all the pictures not set as favorites. ([ALL DELETE EXCEPT★])

**1 Touch [★].****2 Touch the image from the thumbnail at the bottom of the screen, and touch the main image.**

- Repeat the step to set more than 2 images.
- Setting is canceled by touching the same picture again.

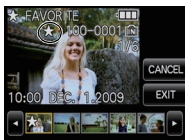
**3 Touch [EXIT].****■ Canceling all the [FAVORITE] settings**

- 1 Touch [CANCEL] in step 2.**
- 2 Touch [YES].**

**Note**

- You can set up to 999 pictures as favorites.
- When printing pictures at a photo printing store, [ALL DELETE EXCEPT★] (P40) is useful so only the pictures you want to be printed remain on the card.
- You may not be able to set pictures taken with other equipment as favorites.
- You can perform, check and cancel the settings of images as favorites using the "PHOTOfunSTUDIO" bundled software on the CD-ROM (supplied).



## [RESIZE] Reducing the picture size (number of pixels)

We recommend resizing to [0.3M] if you want to attach a picture to an e-mail or use it on a website. (Pictures set to the minimum number of pixels for [ASPECT RATIO] cannot be further reduced in size.)

**1** Touch .

**2** Touch [RESIZE].

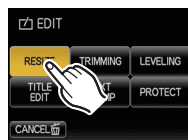

**3** Touch the picture size.

- Only the sizes to which the pictures can be resized is displayed.

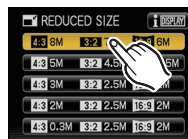

**4** Touch the image from the thumbnail at the bottom of the screen, and touch the main image.

- Repeat the step to set more than 2 images.
- Up to 50 pictures can be selected at once.
- Selection will be canceled by touching the same picture again.
- Selection of all pictures will be canceled by touching [CANCEL].



**5** Touch [OK].

**6** Touch [YES].

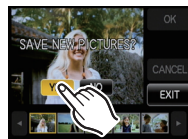

### Note

- The picture quality of the resized picture will deteriorate.
- It may not be possible to resize pictures recorded with other equipment.
- Motion pictures, pictures with audio, and pictures stamped with [TEXT STAMP] cannot be resized.

## [TRIMMING]

You can enlarge and then clip the important part of the recorded picture.

**1** Touch the image from the thumbnail at the bottom of the screen.

**2** Touch .



**3** Touch [TRIMMING].



**4** Select the part to be trimmed.

Touch : Enlarge

Touch : Reduce

Drag (P12): Move

• The zoom lever and cursor buttons can also be used.

Reduction



Enlargement



Move the position



**5** Touch [SET].

**6** Touch [YES].

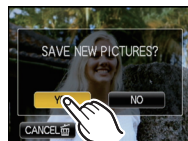

**Note**

- Depending on the cut size, the picture size of the trimmed picture may become smaller than that of the original picture.
- The picture quality of the trimmed picture will deteriorate.
- It may not be possible to trim pictures recorded with other equipment.
- Motion pictures, pictures with audio, and pictures stamped with [TEXT STAMP] cannot be trimmed.

## [LEVELING]

Minute tilting of the image can be adjusted.

**1** Touch the image from the thumbnail at the bottom of the screen.

**2** Touch [↖].



**3** Touch [LEVELING].

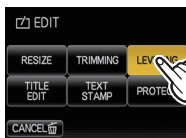

**4** Touch [↻]/[↺] to adjust the tilting, and then touch [SET].

↻: clockwise

↺: counter-clockwise

•Up to 2° can be adjusted.



**5** Touch [YES].

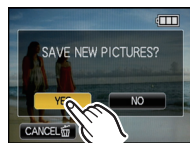

**Note**

- Quality of image may become coarse when leveling is performed.
- Recorded pixels may decrease compared to original image when leveling is performed.
- Leveling may not be performed on images recorded with other equipment.
- Motion pictures, pictures with audio, and pictures stamped with [TEXT STAMP] cannot be leveled.

## [TITLE EDIT]

You can add text (comments) to pictures. After text has been registered, it can be included in prints using [TEXT STAMP] (P96). (Only alphabetic characters and symbols can be entered.) Names set in [BABY1]/[BABY2] and [PET] in Scene Mode and [LOCATION] in travel date are also recorded as the titles.

You can use the stylus pen (supplied) if it is hard to operate with your fingers.

**1** Touch [↖].

## 2 Touch [TITLE EDIT].

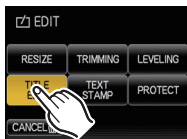

## 3 Touch the image from the thumbnail at the bottom of the screen, and touch the main image.

- Repeat the step to set more than 2 images.
- Up to 50 pictures can be selected at once.
- Selection will be canceled by touching the same picture again.
- Selection of all pictures will be canceled by touching [CANCEL].



## 4 Touch [OK].

## 5 Enter characters.

- Touch [ABC] to switch text between [A] (capitals), [a] (small case), and [&/1] (special characters/numbers).
- The cursor at the entry position can be moved to the left with touching [←], and to the right with touching [→].
- To enter a blank, touch [ ], or to delete an entered character, touch [DELETE].
- To stop editing at any time during text entry, touch [CANCEL].
- A maximum of 30 characters can be entered. (Maximum of 9 characters when setting names in [FACE RECOG.] )

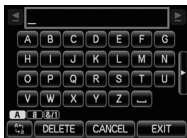

## 6 Touch [EXIT].

### ■ Delete the title

- 1 In step 5, delete all the texts.
- 2 Touch [EXIT].

### 📌 Note

- Text can be scrolled if all of the registered text does not fit on the screen.
- The name setting of [FACE RECOG.] or [BABY1]/[BABY2] and [PET] in Scene Mode or [LOCATION] in travel date can also be registered by using the operation in steps 5 and following.
- The name setting of [BABY1]/[BABY2] and [PET] in Scene Mode, [LOCATION] in travel date and [TITLE EDIT] cannot be registered at the same time.
- You can print out texts (comments) using the "PHOTOfunSTUDIO" bundled software on the CD-ROM (supplied).
- You cannot use title edit for the following pictures.
  - Motion pictures
  - Protected pictures
  - Pictures recorded with other equipment

## [TEXT STAMP]

You can stamp the recording date/time, age, travel date or title onto the recorded pictures. It is suitable for regular size printing. (Pictures with a picture size larger than [3M] will be resized when stamping the date etc. on them.)

**1** Touch .

**2** Touch [TEXT STAMP].



**3** Touch the image from the thumbnail at the bottom of the screen, and touch the main image.

- Repeat the step to set more than 2 images.
- Up to 50 pictures can be selected at once.
- Selection will be canceled by touching the same picture again.
- Selection of all pictures will be canceled by touching [CANCEL].

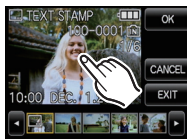

**4** Touch [OK].

**5** Touch [SHOOTING DATE], [AGE], [TRAVEL DATE], or [TITLE] to set each item by touching it.

**[SHOOTING DATE]**

**[W/OTIME]:** Stamp the year, month and date.

**[WITHTIME]:** Stamp the year, month, day, hour and minutes.

**[AGE] (P60)**

If this is set to [ON], [AGE] is stamped on the pictures.

**[TRAVEL DATE]**

If this is set to [ON], [TRAVEL DATE] is stamped on the pictures.

**[TITLE]**

Text is printed together with the image for pictures that have already been recorded with text in [FACE RECOG.] or [BABY1]/[BABY2] and [PET] name settings in Scene Mode, [LOCATION] in travel date or [TITLE EDIT].

**6** Touch [SET].

- If you set [TEXT STAMP] for a picture with a picture size larger than [3M], the picture size will become smaller as shown below.



Aspect ratio setting	Picture size
4:3	12M / 8M / 5M → 3M
3:2	10.5M / 7M / 4.5M → 2.5M
16:9	9M / 6M / 3.5M → 2M

- The picture becomes slightly rougher.

## 7 Touch [YES].

### Note

- When you print pictures stamped with text, the date will be printed over the stamped text if you specify printing of the date at the photo shop or on the printer.
- Depending on the printer being used, some characters may be cut at printing. Check before printing.
- When text is stamped onto the [0.3M] pictures, it is difficult to read it.
- Text and dates cannot be stamped on the pictures in the following cases.
  - Motion pictures
  - Pictures with audio
  - Pictures recorded without setting the clock and title
  - Pictures that were previously stamped with [TEXT STAMP]
  - Pictures recorded with other equipment

## [PROTECT]

You can set protection for pictures you do not want to be deleted by mistake.

## 1 Touch [ ].

## 2 Touch [PROTECT].



## 3 Touch the image from the thumbnail at the bottom of the screen, and touch the main image.

- Repeat the step to set more than 2 images.
- Setting is canceled by touching the same picture again.



## 4 Touch [EXIT].

**■ Canceling all the [PROTECT] settings**

- 1 Touch [CANCEL] in step 3.
- 2 Touch [YES].

**Note**

- The protect setting may not be effective on other equipment.
- Even if you protect pictures in the built-in memory or a card, they will be deleted if the built-in memory or the card is formatted.
- Even if you do not protect pictures on an SD Memory Card or an SDHC Memory Card, they cannot be deleted when the card's Write-Protect switch is set to [LOCK].

**[DELETE]****Once deleted, pictures cannot be recovered.**

- Delete the pictures on the card while the card is inserted in the camera.
- Refer to P40 to delete multiple or all pictures.

- 1 Touch the image from the thumbnail at the bottom of the screen, and touch [ ].

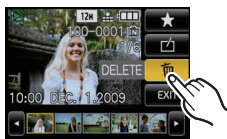

- 2 Touch [YES].

[PLAYBACK] mode:

**Playing Back Motion Pictures/Pictures with Audio****Motion pictures****Select motion picture [ ] and touch [ ] to play back.**

- (A) The motion picture recording time  
(B) Motion picture icon

- After playback starts, the elapsed playback time is displayed on the upper right of the screen.  
For example, 8 minutes and 30 seconds is displayed as [8m30s].

**■ Operations performed during motion picture playback**

- 1 Display control panel by touching screen.

- If no operation is performed for 2 seconds, it will return to original status.

- 2 Operate control panel by touching.

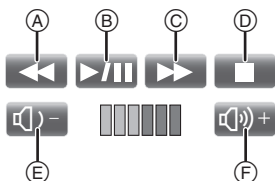
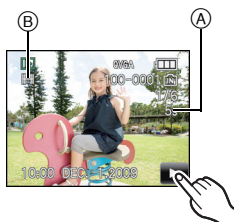

- (A) Fast rewind, Frame-by-frame rewind\*  
(B) Play/Pause  
(C) Fast forward, Frame-by-frame forward\*  
(D) Stop  
(E) Reduce volume level  
(F) Increase volume level  
\* These operations can be performed only in the Pause Mode.

## Pictures with audio

### Select still picture with audio [ ] and touch [ ] to play back.

(A) Still picture with audio icon

- Refer to [AUDIO REC.] (P83) and [AUDIO DUB.] (P102) for information about how to create still pictures with audio.

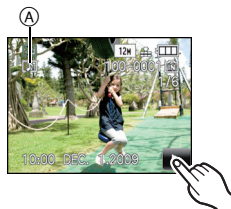

### Note

- Sound can be heard through the speaker. Refer to [VOLUME] (P23) for information about how to adjust the volume in the [SETUP] menu.
- The file format that can be played back with this camera is QuickTime Motion JPEG.
- Please note that the bundled software includes QuickTime to play back motion picture files created with the camera on the PC.
- Some QuickTime Motion JPEG files recorded by a PC or other equipment may not play back on the camera.
- If you play back motion pictures that have been recorded with other equipment, the picture quality may deteriorate or the pictures may not play back.
- Pictures with audio recorded with other equipment may not playback on this unit.
- When using a high capacity card, it is possible that fast rewinding may be slower than usual.

[PLAYBACK] mode: 

## Using the [PLAYBACK] mode menu

You can use various functions in playback mode to rotate pictures, copy them, etc.



This is same function as [EDIT] in [EASY ORG.] (P92).



This mode allows you to automatically display pictures vertically if they were recorded holding the camera vertically.

### 1 Select [ROTATE DISP.] on the [PLAYBACK] mode menu. (P21)

### 2 Press $\blacktriangledown$ to select [ON] and then press [MENU/SET].

- The pictures are displayed without being rotated when you select [OFF].
- Refer to P37 for information about how to play back pictures.

### 3 Press [MENU/SET] to close the menu.



#### Note

- When you play back pictures on a PC, they cannot be displayed in the rotated direction unless the OS or software is compatible with Exif. Exif is a file format for still pictures which allows recording information etc. to be added. It was established by "JEITA (Japan Electronics and Information Technology Industries Association)".
- It may not be possible to rotate pictures that have been recorded with other equipment.
- The display is not rotated during multi playback (P86) or [CALENDAR] (P87).



DPOF "Digital Print Order Format" is a system that allows the user to select which pictures to print, how many copies of each picture to print and whether or not to print the recording date on the pictures when using a DPOF compatible photo printer or photo printing store. For details, ask at your photo printing store.

When you want to use a photo printing store to print pictures recorded on the built-in memory, copy them to a card (P103) and then set the print setting.

For more information visit:

[http://panasonic.jp/dc/dpof\\_110/white\\_e.htm](http://panasonic.jp/dc/dpof_110/white_e.htm)

### 1 Select [PRINT SET] on the [PLAYBACK] mode menu. (P21)

### 2 Press $\blacktriangle/\blacktriangledown$ to select [SINGLE] or [MULTI] and then press [MENU/SET].



- 3** Select the picture, and then press [MENU/SET].

[SINGLE]

[MULTI]



Press ◀/▶ to select the picture.



Press ▲/▼/◀/▶ to select the pictures.

- 4** Press ▲/▼ to set the number of prints, and then press [MENU/SET] to set.

- When [MULTI] has been selected, repeat steps 3 and 4 for each picture. (It is not possible to use the same setting for a multiple number of pictures.)

- 5** Press [⏪] to return to the menu screen.

- Press [MENU/SET] to close the menu.

#### ■ Canceling all the [PRINT SET] settings

- 1 Select [CANCEL] on the screen shown in step 2 and then press [MENU/SET].
- 2 Press ▲ to select [YES] and then press [MENU/SET].
- 3 Press [MENU/SET] to close the menu.

- You cannot select [CANCEL] if not even one picture has been set for printing.

#### ■ To print the date

After setting the number of prints, set/cancel printing with the recording date by pressing [DISPLAY].

- When you go to a photo printing store for digital printing, be sure to order the printing of the date additionally if required.
- Depending on the photo printing store or the printer, the date may not be printed even if you set to print the date. For further information, ask at your photo printing store or refer to the operating instructions for the printer.
- The date cannot be printed on pictures stamped with text.

#### 📌 Note

- The number of prints can be set from 0 to 999.
- With a printer supporting PictBridge, the date print settings of the printer may take precedence so check if this is the case.
- It may not be possible to use the print settings with other equipment. In this case, cancel all the settings, and reset the settings.
- If the file is not based on the DCF standard, the print setting cannot be set.

## [AUDIO DUB.]

You can add the audio after taking a picture.

**1** Select **[AUDIO DUB.]** on the **[PLAYBACK]** mode menu. (P21)

**2** Press **◀/▶** to select the picture and then press **[MENU/SET]** to start audio recording.

- The message **[OVERWRITE AUDIO DATA?]** screen appears when audio has already been recorded. Press **▲** to select **[YES]** and then press **[MENU/SET]** to start audio recording. (The original audio is overwritten.)
- Audio is recorded from the built-in microphone on the camera.
- If you press **[⏏]**, the audio dubbing is canceled.



**3** Press **[MENU/SET]** to stop recording.

- It will automatically stop after recording about 10 seconds without pressing **[MENU/SET]**.



**4** Press **[⏏]** to return to the menu screen.

- Press **[MENU/SET]** to close the menu.

### Note

- Audio dubbing may not work properly on pictures recorded by other equipment.
- Audio dubbing does not work on motion pictures and protected pictures.
- Sound from motion pictures or pictures with audio recorded by this camera cannot be played back by older models of Panasonic digital camera (LUMIX) launched before July 2008.

## [FACE RECOG.]

All the information regarding the **[FACE RECOG.]** of the selected image will be cleared.

**1** Select **[FACE RECOG.]** on the **[PLAYBACK]** mode menu. (P21)

**2** Press **◀/▶** to select the picture and then press **[MENU/SET]**

**3** Press **▲** to select **[YES]** and then press **[MENU/SET]**.

**4** Press **[⏏]** to return to the menu screen.

- Press **[MENU/SET]** to close the menu.

### Note

- Cleared information regarding the **[FACE RECOG.]** cannot be restored.
- Images Cleared of **[FACE RECOG.]** will not be categorized for **[FACE RECOG.]** for **[CATEGORY PLAY]**.
- Clearing of **[FACE RECOG.]** cannot be done of the protected image.

## ↔ [COPY]

You can copy the data of the pictures you have taken from the built-in memory to a card or from a card to the built-in memory.

### 1 Select [COPY] on the [PLAYBACK] mode menu. (P21)

### 2 Press ▲/▼ to select the copy destination and then press [MENU/SET].

: All the picture data in the built-in memory are copied onto the card at one time. → step 4.

: One picture at a time is copied from the card to the built-in memory. → step 3.



### 3 Press ◀▶ to select the picture and then press [MENU/SET].

### 4 Press ▲ to select [YES], and then press [MENU/SET].



- If you press [MENU/SET] while copying pictures from the built-in memory to the card, the copying will stop halfway.
- Do not turn the camera off at any point during the copying process.



### 5 Press [EXIT] to return to the menu screen.

- Press [MENU/SET] to close the menu.
- If you copy from the built-in memory to a card, all the pictures are copied and then the screen automatically returns to the playback screen.

#### Note

- If you copy picture data from the built-in memory to a card which does not have sufficient free space, the picture data will only be copied halfway. We recommend using a card which has more free space than the built-in memory (about 40 MB).
- If a picture exists with the same name (folder number/file number) as the picture to be copied in the copy destination when  is selected, a new folder is created and the picture is copied. If a picture exists with the same name (folder number/file number) as the picture to be copied in the copy destination when  is selected, that picture is not copied. (P118)
- It may take time to copy the picture data.
- Only pictures recorded with a Panasonic digital camera (LUMIX) will be copied. (Even if the pictures were recorded with a Panasonic digital camera, you may not be able to copy them if they were edited with a PC.)
- Print settings on the original picture data will not be copied. Set the print settings again after copying is finished.

## Connecting to a PC

You can acquire recorded pictures to a PC by connecting the camera and the PC.

- You can easily print out or e-mail the pictures you have imported. Use of the "PHOTOFunSTUDIO" bundled software on the CD-ROM (supplied) is a convenient way of doing this.
- Read the separate operating instructions for the supplied software for more information about the software in the CD-ROM (supplied) and how to install it.

Preparations:

Turn on the camera and the PC.

Remove the card before using the pictures in the built-in memory.

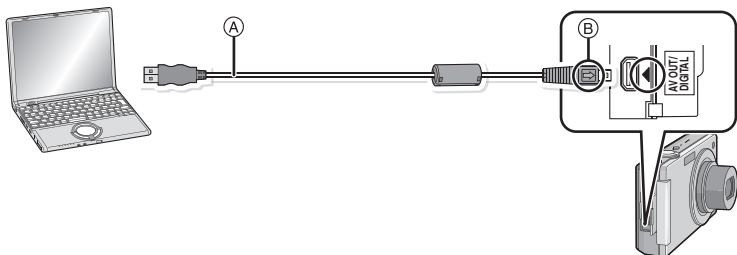

**A** USB connection cable (supplied)

- Check the directions of the connectors, and plug them straight in or unplug them straight out. (Otherwise the connectors may be bent out of shape which will cause trouble.)

**B** Align the marks, and insert.

- Use a battery with sufficient battery power or the AC adaptor (DMW-AC5PP; optional) and DC coupler (DMW-DCC4; optional). If the remaining battery power becomes low while the camera and the PC are communicating, the status indicator blinks and the alarm beeps. Refer to "Disconnecting the USB connection cable safely" (P105) before disconnecting the USB connection cable. Otherwise, data may be destroyed.

**1**

**Connect the camera to a PC via the USB connection cable **A** (supplied).**

- Do not use any other USB connection cables except the supplied one. Use of cables other than the supplied USB connection cable may cause malfunction.

**2**

**Press **▲/▼** to select [PC], and then press [MENU/SET].**

- If [USB MODE] (P26) is set to [PC] in the [SETUP] menu in advance, the camera will be automatically connected to the PC without displaying the [USB MODE] selection screen. Since there is no need to set this each time you connect to the PC, it is convenient.
- When the camera has been connected to the PC with [USB MODE] set to [PictBridge(PTP)], a message may appear on the PC's screen. Select [Cancel] to close the screen, and disconnect the camera from the PC. Then set [USB MODE] to [PC] again.

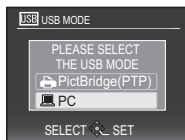



**3 Double-click on [Removable Disk] in [My Computer].**

- When using a Macintosh, the drive is displayed on the desktop. (“LUMIX”, “NO\_NAME” or “Untitled” is displayed.)

**4 Double-click [DCIM] folder.****5 Using a drag-and-drop operation, move the pictures you want to acquire or the folder storing those pictures to any different folder on the PC.****■ Disconnecting the USB connection cable safely**

- Proceed with the hardware removal using “Safely Remove Hardware” on the task tray of the PC. If the icon is not displayed, check that [ACCESS] is not displayed on the LCD monitor of the digital camera before removing the hardware.

**Note**

- This unit cannot be stood upright when the AC adaptor is connected. When placing it down and operating, we recommend placing it on a soft cloth.
- Turn the camera off before connecting or disconnecting the AC adaptor (DMW-AC5PP; optional).
- Before inserting or removing a card, turn the camera off and disconnect the USB connection cable. Otherwise, data may be destroyed.

**■ Viewing the contents of the built-in memory or card using the PC (folder composition)**

- Built-in memory
- Card

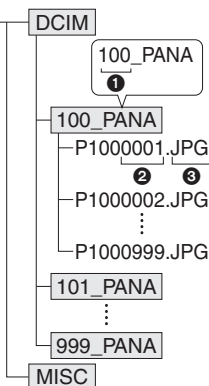

- ① Folder number
- ② File number
- ③ JPG: Pictures  
MOV: Motion pictures  
MISC: DPOF print  
Favorite

A new folder is created when pictures are taken in the following situations.

- After [NO.RESET] (P26) in the [SETUP] menu has been executed
- When a card containing a folder with the same folder number has been inserted (Such as when pictures were taken using another make of camera)
- When there is a picture with file number 999 inside the folder

■ **Connection in the PTP mode (Windows® XP, Windows Vista® and Mac OS X only)**

Set [USB MODE] to [PictBridge(PTP)].

Data can now be read only from the card into the PC.

- When there are 1000 or more pictures on a card, the pictures may not be imported in the PTP mode.

## Printing the Pictures

If you connect the camera to a printer supporting PictBridge, you can select the pictures to be printed out and start printing on the camera's LCD monitor.

Preparations:

Turn on the camera and the printer.

Remove the card before printing the pictures in the built-in memory.

Perform the print quality and other settings at the printer before printing the pictures.

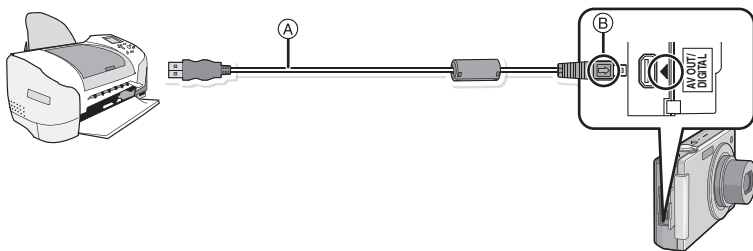

Ⓐ USB connection cable (supplied)

- Check the directions of the connectors, and plug them straight in or unplug them straight out. (Otherwise the connectors may be bent out of shape which will cause trouble.)

Ⓑ Align the marks, and insert.

- Use a battery with a sufficient battery power or the AC adaptor (DMW-AC5PP; optional) and DC coupler (DMW-DCC4; optional). If the remaining battery power becomes low while the camera and the printer are connected, the status indicator blinks and the alarm beeps. If this happens during printing, stop printing at once. If not printing, disconnect the USB connection cable.

### 1 Connect the camera to a printer via the USB connection cable Ⓐ (supplied).

- When the camera is connected to the printer, the cable disconnect prohibit icon [⊘] appears. Do not disconnect the USB cable while [⊘] is displayed.

### 2 Press ▲/▼ to select [PictBridge(PTP)], and then press [MENU/SET].

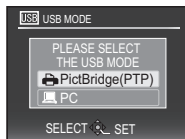

**Note**

- This unit cannot be stood upright when the AC adaptor is connected. When placing it down and operating, we recommend placing it on a soft cloth.
- Do not use any other USB connection cables except the supplied one.  
Use of cables other than the supplied USB connection cable may cause malfunction.
- Turn the camera off before connecting or disconnecting the AC adaptor (DMW-AC5PP; optional).
- Before inserting or removing a card, turn the camera off, and disconnect the USB connection cable.
- You cannot switch between the built-in memory and the card while the camera is connected to the printer. Disconnect the USB connection cable, insert (or remove) the card and then connect the USB connection cable to the printer again.

**Selecting a single picture and printing it**

- 1** Press **◀/▶** to select the picture and then press **[MENU/SET]**.

- The message disappears in about 2 seconds.



- 2** Press **▲** to select **[PRINT START]** and then press **[MENU/SET]**.

- Refer to P108 for the items which can be set before starting to print the pictures.
- Press **[MENU/SET]** to cancel printing halfway.
- Disconnect the USB connection cable after printing.

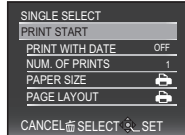
**Selecting multiple pictures and printing them**

- 1** Press **▲**.

- 2** Press **▲/▼** to select an item and then press **[MENU/SET]**.

- If the print check screen has appeared, select **[YES]**, and print the pictures.

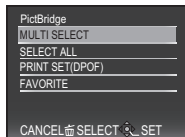

Item	Description of settings
<b>[MULTI SELECT]</b>	Multiple pictures are printed at one time. • Press <b>▲/▼/◀/▶</b> to select the pictures, and then when <b>[DISPLAY]</b> is pressed, <b>[ ]</b> appears on the pictures to be printed. (When <b>[DISPLAY]</b> is pressed again, the setting is canceled.) • After the pictures have been selected, press <b>[MENU/SET]</b> .
<b>[SELECT ALL]</b>	Prints all the stored pictures.
<b>[PRINT SET (DPOF)]</b>	Prints the pictures set in <b>[PRINT SET]</b> only. (P100)
<b>[FAVORITE]*</b>	Prints the pictures set as favorites only. (P91)

\* Only when there are pictures already set as **[FAVORITE]** (P91).

### 3 Press ▲ to select [PRINT START] and then press [MENU/SET].

- Refer to "Print Settings" (P108) for the items which can be set before starting to print the pictures.
- Press [MENU/SET] to cancel printing.
- Disconnect the USB connection cable after printing.

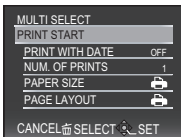

## Print Settings

Select and set the items both on the screen in step 2 of the "Selecting a single picture and printing it" and in step 3 of the "Selecting multiple pictures and printing them" procedures.

- When you want to print pictures in a paper size or a layout which is not supported by the camera, set [PAPER SIZE] or [PAGE LAYOUT] to and then set the paper size or the layout on the printer. (For details, refer to the operating instructions of the printer.)
- When [PRINT SET (DPOF)] has been selected, the [PRINT WITH DATE] and [NUM. OF PRINTS] items are not displayed.

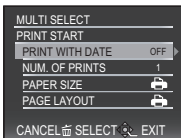

## [PRINT WITH DATE]

Item	Description of settings
[OFF]	Date is not printed.
[ON]	Date is printed.

- If the printer does not support date printing, the date cannot be printed on the picture.
- Since the printer's settings may take precedence over the print with date setting, check the printer's print with date setting as well.
- When printing images with a text stamp, please remember to set print with date to [OFF] or the date will print on top.

### Note

#### When asking the photo shop to print the pictures

- By stamping the date using [TEXT STAMP] (P96) or setting date printing at the time of the [PRINT SET] (P100) setting before going to a photo shop, the dates can be printed at the photo shop.

## [NUM. OF PRINTS]





You can set the number of prints up to 999.

## [PAPER SIZE]

Item	Description of settings
	Settings on the printer are prioritized.
[L/3.5"×5"]	89 mm×127 mm
[2L/5"×7"]	127 mm×178 mm
[POSTCARD]	100 mm×148 mm
[16:9]	101.6 mm×180.6 mm
[A4]	210 mm×297 mm
[A3]	297 mm×420 mm
[10×15cm]	100 mm×150 mm
[4"×6"]	101.6 mm×152.4 mm
[8"×10"]	203.2 mm×254 mm
[LETTER]	216 mm×279.4 mm
[CARD SIZE]	54 mm×85.6 mm

- Paper sizes not supported by the printer will not be displayed.

## [PAGE LAYOUT] (Layouts for printing that can be set with this unit)

Item	Description of settings
	Settings on the printer are prioritized.
	1 picture with no frame on 1 page
	1 picture with a frame on 1 page
	2 pictures on 1 page
	4 pictures on 1 page

- An item cannot be selected if the printer does not support the page layout.

### Layout printing

#### When printing a picture several times on 1 sheet of paper

For example, if you want to print the same picture 4 times on 1 sheet of paper, set [PAGE LAYOUT] to  and then set [NUM. OF PRINTS] to 4 for the picture that you want to print.

#### When printing different pictures on 1 sheet of paper

For example, if you want to print 4 different pictures on 1 sheet of paper, set [PAGE LAYOUT] to  and then set [NUM. OF PRINTS] to 1 for each of the 4 pictures.

#### Note

- The camera is receiving an error message from the printer when the  indication lights orange during printing. After finishing printing, make sure there are no problems with the printer.
- If the number of prints is high, the pictures may be printed several times. In this case, the remaining number of prints indicated may differ from the number set.

[PLAYBACK] mode: 

## Playing Back Pictures on a TV Screen

### Playing back pictures using the AV cable (supplied)

Preparations:

Set the [TV ASPECT]. (P26)

Turn this unit and the TV off.

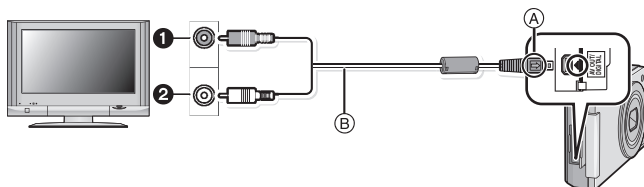

① Yellow: to the video input socket

② White: to the audio input socket

(A) Align the marks, and insert.

(B) AV cable (supplied)

• Check the directions of the connectors, and plug them straight in or unplug them straight out. (Otherwise the connectors may be bent out of shape which will cause trouble.)

**1** Connect the AV cable (B) (supplied) to the video input and the audio input sockets on the TV.

**2** Connect the AV cable to the [AV OUT] socket on the camera.

**3** Turn the TV on and select external input.

**4** Turn the camera on.

#### Note

- Depending on the [ASPECT RATIO], black bands may be displayed on the top and bottom or the left and right of the pictures.
- Do not use any other AV cables except the supplied one.
- Read the operating instructions for the TV.
- When you play back a picture vertically, it may be blurry.
- You cannot operate if you touch the Touch icon displayed on the TV screen.

### Playing back pictures on a TV with an SD Memory Card slot

Still pictures recorded on an SD Memory Card can be played back on a TV with an SD Memory Card slot.

#### Note

- Depending on the TV model, pictures may not be displayed on the full screen.
- Motion pictures cannot be played back. To play back motion pictures, connect the camera to the TV with the AV cable (supplied).
- You cannot play back pictures on SDHC cards if the TV does not support these cards.
- You may not be able to play back MultiMediaCards.

## Playing back on the TV with component socket

You can enjoy high quality pictures and motion pictures on the TV by connecting the camera with the TV using component cable (DMW-HDC2: optional).

Component output is output as 1080i. Connect with a TV compatible with the 1080i.

Preparations: Turn this unit and the TV off.

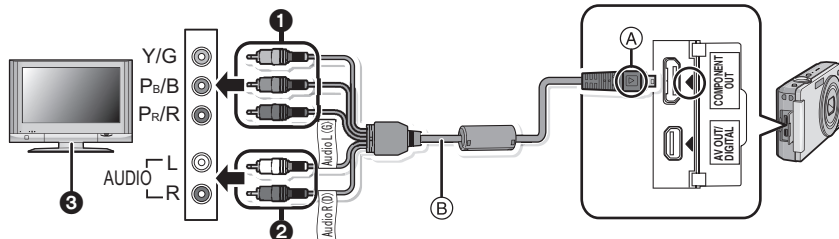

- ❶ Component Plugs: Connect the plugs to the component video input sockets on the TV with same color. (Indication on the TV might be different.)
  - ❷ Audio Pin Plugs: to the audio input socket
  - ❸ TV with component socket
  - Ⓐ Align the marks, and insert.
  - Ⓑ Component cable (DMW-HDC2: optional)
- Check the directions of the connectors, and plug them straight in or unplug them straight out. (Otherwise the connectors may be bent out of shape which will cause trouble.)



- ❶ **Connect the component cable ❷ (DMW-HDC2; optional) to the component input and the audio input sockets on the TV.**
- ❷ **Connect the component cable to the [COMPONENT OUT] socket on the camera.**
- ❸ **Turn on the TV and switch to component input.**
- ❹ **Turn the camera on.**

### Note

- Depending on the [ASPECT RATIO], bands may be displayed on the top and bottom or the left and right of the pictures.
- Do not use any other cables except a genuine Panasonic component cable (DMW-HDC2; optional).
- Audio will be output as monaural.
- When you play back a picture vertically, it may be blurry.
- Image may not be displayed on the LCD monitor when the component cable is connected.
- When pictures are displayed, they may not be displayed properly depending on the type of TV.
- Read the operating instructions for the TV.
- The following functions cannot be used when the component cable is connected.
  - [LCD MODE]/[HISTOGRAM]/[CALIBRATION]/[AUTO DEMO]/[EDIT]/[AUDIO DUB.]/[FACE RECOG.]/[COPY]/[MULTI] settings of [PRINT SET]/[DELETE MULTI]/[EASY ORG.]/[DUAL PLAY]





- 34 Burst (P80)/: Auto bracket (P54)/:Color bracket (P55)/: Audio recording (P83)
- 35 Quick AF (P79)/AF\*: AF assist lamp (P83)
- 36 Number of days that have passed since the travel date (P70)
- 37 Self-timer mode (P47)
- \*1 This is displayed for about 5 seconds when this unit is turned on in [BABY1]/[BABY2] or [PET] in Scene Mode.
- \*2 This is displayed for about 5 seconds when the camera is turned on, after setting the clock and after switching from playback mode to Recording Mode.

## ■ In playback

- 1 Playback mode (P37)
- 2 Protected picture (P97)
- 3 Favorites (P91)
- 4 Stamped with text indication (P96)
- 5 Picture size (P73)
- 6 Motion picture icon (P98)
- 7 Quality (P74)
- 8 Battery indication (P15)
- 8 Folder/File number (P105)
- 8 Built-in memory (P18)
- 8 Elapsed playback time (P98): 8m30s
- 9 Picture number/Total pictures
- 10 Motion picture recording time (P98): 8m30s
- 11 Histogram (P24, 42)
- 12 Exposure compensation (P53)
- 13 Recording information (P41)
- 14 Playback (Motion picture, Still picture with audio) (P98)
- 15 Recorded date and time/Travel destination setting (P72)/Name (P60, 69)/Location (P70)/Title (P94)
- 16 Age (P60)
- 17 Number of days that have passed since the travel date (P70)
- 18 Power LCD (P23)
- 19 Number of prints (P100)
- 20 Still picture with audio (P98)
- : Motion picture (P98)
- Cable disconnection prohibit icon (P106)

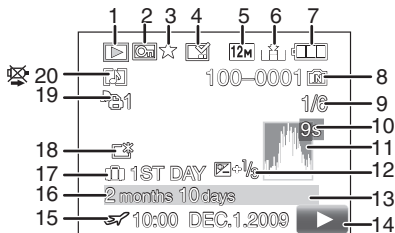

## Cautions for Use

### Optimal use of the camera

#### **Take care not to drop or knock the unit or put a lot of pressure on it.**

- Take care not to knock or drop the bag/case that you inserted the camera in, as the shock may cause damage to the camera, lens or LCD monitor.
- Do not attach any other items to the hand strap that's included with your camera. While being stored, that item can rest against the LCD monitor and damage it.
- Do not use a paper bag as it can easily rip, causing the camera to fall and be damaged.
- We strongly recommend you purchase a good camera bag/case from your local dealer to protect your camera.

#### **Keep the camera as far away as possible from electromagnetic equipment (such as microwave ovens, TVs, video games etc.).**

- If you use the camera on top of or near a TV, the pictures and sound on the camera may be disrupted by electromagnetic wave radiation.
- Do not use the camera near cell phones because doing so may result in noise adversely affecting the pictures and sound.
- Recorded data may be damaged, or pictures may be distorted, by strong magnetic fields created by speakers or large motors.
- Electromagnetic wave radiation generated by microprocessors may adversely affect the camera, disturbing the pictures and sound.
- If the camera is adversely affected by electromagnetic equipment and stops functioning properly, turn the camera off and remove the battery or disconnect AC adaptor (DMW-AC5PP; optional). Then reinsert the battery or reconnect AC adaptor and turn the camera on.

#### **Do not use the camera near radio transmitters or high-voltage lines.**

- If you record near radio transmitters or high-voltage lines, the recorded pictures and sound may be adversely affected.

#### **Always use the supplied cords and cables. If you use optional accessories, use the cords and the cables supplied with them.**

#### **Do not extend the cords or the cables.**

#### **Do not spray the camera with insecticides or volatile chemicals.**

- If the camera is sprayed with such chemicals, the body of the camera may be damaged and the surface finish may peel off.
- Do not keep rubber or plastic products in contact with the camera for a long period of time.

### Cleaning

#### **Before cleaning the camera, remove the battery or the DC coupler (DMW-DCC4; optional), or disconnect the power plug from the outlet. Then wipe the camera with a dry soft cloth.**

- When the camera is soiled badly, it can be cleaned by wiping the dirt off with a wrung wet cloth, and then with a dry cloth.
- Do not use solvents such as benzene, thinner, alcohol, kitchen detergents, etc., to clean the camera, since it may deteriorate the external case or the coating may peel off.
- When using a chemical cloth, be sure to follow the accompanying instructions.

### About the LCD monitor

- Do not press the LCD monitor with excessive force. Uneven colors may appear on the LCD monitor and it may malfunction.

- If the camera is cold when you turn it on, the picture on the LCD monitor will be slightly darker than usual at first. However, the picture will return to normal brightness when the internal temperature of the camera increases.

Extremely high precision technology is employed to produce the LCD monitor screen. However there may be some dark or bright spots (red, blue or green) on the screen. This is not a malfunction. The LCD monitor screen has more than 99.99% effective pixels with a mere 0.01% of the pixels inactive or always lit. The spots will not be recorded on pictures on the built-in memory or a card.

### About the Lens

- Do not press against the lens with excessive force.
- Do not leave the camera with the lens facing the sun, as rays of light from the sun may cause it to malfunction. Also, be careful when placing the camera outside or near a window.

### Battery

**The battery is a rechargeable lithium ion battery. Its ability to generate power comes from the chemical reaction that takes place inside it. This reaction is susceptible to the surrounding temperature and humidity. If the temperature is too high or too low, the operating time of the battery will become shorter.**

#### **Always remove the battery after use.**

- Store the removed battery in the battery case (supplied).

#### **If you drop the battery accidentally, check to see if the body of the battery and the terminals are damaged.**

- Inserting a damaged battery in the camera will damage the camera.

#### **Bring charged spare batteries when going out.**

- Be aware that the operating time of the battery becomes shorter in low temperature conditions such as at a ski resort.
- When you travel, do not forget to bring the battery charger (supplied) so that you can charge the battery in the country that you are traveling in.

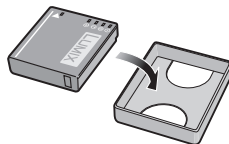

#### **Dispose of unusable battery.**

- The battery has a limited life.
- Do not throw the battery into fire because it may cause an explosion.
- The unusable battery should be discarded in accordance with battery recycling laws. Call the RBRC hotline at 1-800-822-8837 for information.

#### **Do not allow battery terminals to come into contact with metal objects (such as necklaces, hairpins etc.).**

- This can cause short circuiting or heat generation and you may be badly burned if you touch a battery.

### Charger

- If you use the battery charger near a radio, the radio reception may be disturbed.
- Keep the charger 1 m (3.28 feet) or more away from radios.
- The charger may generate whirring sounds when it is being used. This is not a malfunction.
- After use, be sure to disconnect the power supply device from the electrical outlet. (A very small amount of current is consumed if it is left connected.)
- Keep the terminals of the charger and battery clean.

## Card

**Do not leave the card where the temperature is high, where electromagnetic waves or static electricity are easily generated or exposed to direct sunlight.**

**Do not bend or drop the card.**

- The card may be damaged or the recorded content may be damaged or deleted.
- Put the card in the card case or the storage bag after use and when storing or carrying the card.
- Do not allow dirt, dust or water to get into the terminals on the back of the card and do not touch the terminals with your fingers.

**Notice for when transferring to another party, or disposing of the memory card**

- “Format” or “delete” using the camera or a PC will only modify the file management information, and it will not erase the data in the memory card completely.

It is recommended to physically destroy the memory card or use the commercially available computer data deletion software to completely erase the data in the memory card before transferring to another party or disposing.

Management of data in the memory card is the responsibility of the user.

## About the personal information

If a name or birthday is set for [BABY1]/[BABY2]/face recognition function, this personal information is kept in the camera and included in the recorded image.

### Disclaimer

- Information including personal information may be altered or vanish due to erroneous operation, effect of static electricity, accident, malfunction, repair, or other handlings. Please note in advance that Panasonic is not liable in any way for any direct or indirect damage from the alteration or vanishing of information or personal information.

**When requesting a repair, transferring to another party or disposing**

- Reset the settings to protect the personal information. (P26)
- If there are pictures stored in the built-in memory, copy them into the memory card (P103) before formatting the built-in memory (P27) as needed.
- Remove the memory card from the camera when requesting a repair.
- Built-in memory and settings may return to factory default when camera is repaired.
- Please contact the dealer where you purchased the camera or your nearest Service Center if above operations are not possible due to malfunction.

**When transferring to another party, or disposing of the memory card, please refer to “Notice for when transferring to another party, or disposing of the memory card” on P116.**

## When not using the camera for a long period of time

- Store the battery in a cool and dry place with a relatively stable temperature: [Recommended temperature: 15 °C to 25 °C (59 °F to 77 °F), Recommended humidity: 40% to 60%]
- Always remove the battery and the card from the camera.
- If the battery is left inserted in the camera, it will discharge even if the camera is turned off. If the battery continues to be left in the camera, it will discharge excessively and may become unusable even if charged.
- When storing the battery for a long period of time, we recommend charging it once a year. Remove the battery from the camera and store it again after it has completely discharged.
- We recommend storing the camera with a desiccant (silica gel) when you keep it in a closet or a cabinet.

## About the picture data

- Recorded data may be damaged or lost if the camera breaks down due to inappropriate handling. Panasonic will not be liable for any damage suffered due to loss of recorded data.

## About tripods

- When you use a tripod, make sure the tripod is stable when this unit is attached to it.
- You may not be able to remove the card or the battery when using a tripod.
- Make sure that the screw on the tripod is not at an angle when attaching or detaching the camera. You may damage the screw on the camera if you use excessive force when turning it. Also, the camera body and the rating label may be damaged or scratched if the camera is attached too tightly to the tripod.
- Read the operating instructions for the tripod carefully.
- Some tripods cannot be attached when the DC coupler (DMW-DCC4; optional) and AC adaptor (DMW-AC5PP; optional) are connected.

## Message Display

Confirmation messages or error messages will be displayed on the screen in some cases. The major messages are described below as examples.

### [THIS MEMORY CARD IS LOCKED]

- The Write-Protect switch on the SD Memory Card and the SDHC Memory Card are moved to [LOCK]. Move the switch back to unlock it. (P18)

### [NO VALID PICTURE TO PLAY]

- Record a picture or insert a card with a recorded picture and then play it.

### [THIS PICTURE IS PROTECTED]

- Delete the picture after canceling the protect setting. (P97)

### [THIS PICTURE CANNOT BE DELETED]/[SOME PICTURES CANNOT BE DELETED]

- Pictures not based on the DCF standard cannot be deleted.
  - If you want to delete some pictures, format the card after saving necessary data on a PC etc. (P27)

### [NO ADDITIONAL SELECTIONS CAN BE MADE]

- The number of pictures, which can be set at one time when [MULTI] has been selected for [DELETE MULTI] (P40), [FAVORITE] (P91), [TITLE EDIT] (P94), [TEXT STAMP] (P96) or [RESIZE] (P92) has been exceeded.
  - Reduce the number of pictures set, and then repeat the operation.
- More than 999 favorites have been set.

### [CANNOT BE SET ON THIS PICTURE]

- [TITLE EDIT], [TEXT STAMP] or [PRINT SET] cannot be set for pictures not based on the DCF standard.

### [NOT ENOUGH SPACE ON BUILT-IN MEMORY]/[NOT ENOUGH MEMORY ON THE CARD]

- There is no space left on the built-in memory or the card.
  - When you copy pictures from the built-in memory to the card (batch copy), the pictures are copied until the capacity of the card becomes full.

### **[SOME PICTURES CANNOT BE COPIED]/[COPY COULD NOT BE COMPLETED]**

- The following pictures cannot be copied.
  - When a picture with the same name as the picture to be copied exists in the copy destination. (Only when copying from a card to the built-in memory.)
  - Files not based on the DCF standard.
- Moreover, pictures recorded or edited by other equipment may not be copied.

### **[BUILT-IN MEMORY ERROR FORMAT BUILT-IN MEMORY?]**

- This message will be displayed when you format the built-in memory on a PC.
  - Format the built-in memory on the camera again. (P27) The data on the built-in memory will be deleted.

### **[MEMORY CARD ERROR FORMAT THIS CARD?]**

- This card has a format which is not recognized by the camera.
  - Format the card again with the camera after saving necessary data on a PC etc. (P27)

### **[PLEASE TURN CAMERA OFF AND THEN ON AGAIN]/[SYSTEM ERROR]**

- This message appears when the camera is not operating properly.
  - Turn the camera off and on. If the message persists, contact the dealer or your nearest Service Center.

### **[MEMORY CARD PARAMETER ERROR]**

- Use a card compatible with this unit. (P18)
- You can only use an SDHC Memory Card if using cards with 4 GB or more capacity.

### **[MEMORY CARD ERROR PLEASE CHECK THE CARD]**

- An error has occurred accessing the card.
  - Insert the card again.
  - Insert a different card.

### **[READ ERROR/WRITE ERROR PLEASE CHECK THE CARD]**

- It has failed to read or write data.
  - Remove the card after turning the power [OFF]. Insert the card again, turn the power on, and try to read or write the data again.
- The card may be broken.
  - Insert a different card.

### **[MOTION RECORDING WAS CANCELLED DUE TO THE LIMITATION OF THE WRITING SPEED OF THE CARD]**

- When you set the recording quality to [HD], [wVGA] or [VGA], we recommend using a high-speed card with "10MB/s" or greater displayed on the package.
- In the event that it stops even after using a "10MB/s" card or higher, the data writing speed has deteriorated so it is recommended to make a backup and then format (P27).
- Depending on the type of SD Memory Card or SDHC Memory Card, motion picture recording may stop in the middle.

**[A FOLDER CANNOT BE CREATED]**

- A folder cannot be created because there are no remaining folder numbers that can be used. (P105)
  - Format the card after saving necessary data on a PC etc. (P27) If you execute [NO.RESET] in the [SETUP] menu after formatting, the folder number is reset to 100. (P26)

**[PICTURE IS DISPLAYED FOR 4:3 TV]/[PICTURE IS DISPLAYED FOR 16:9 TV]**

- The AV cable is connected to the camera.
  - Press [MENU/SET] if you want to delete this message at once.
  - Select [TV ASPECT] in the [SETUP] menu if you want to change the TV aspect. (P26)
- This message also appears when the USB connection cable is connected to the camera only. In this case, connect the other end of the USB connection cable to a PC or a printer. (P104, 106)

**[PRINTER BUSY]/[PLEASE CHECK THE PRINTER]**

- The printer cannot print.
  - Check the printer.

**[NO BATTERY POWER REMAINS]**

- The remaining battery power is low.
  - Charge the battery.

**[THIS BATTERY CANNOT BE USED]**

- The battery cannot be recognized by the camera.
  - Use a genuine Panasonic battery. If this message is displayed even when a genuine Panasonic battery is used, contact the dealer or your nearest Service Center.
- The battery cannot be recognized as its terminal is dirty.
  - Remove any dirt etc. from the terminal.

## Troubleshooting

First, try out the following procedures (P119–126).

If the problem is not resolved, it may be improved by selecting [RESET] (P26) on the [SETUP] menu when taking pictures.

### Battery and power source

**The camera cannot be operated even when it is turned on.**

- The battery is not inserted correctly. (P16)
- The battery is exhausted.

**The LCD monitor turns off while the camera is turned on.**

- Is [AUTO LCD OFF] (P25) of the [ECONOMY] mode active?
  - Press the shutter button halfway to cancel these modes.
- The battery is exhausted.

**The camera turns off immediately after it is turned on.**

- The battery is exhausted.
- If you leave the camera on, the battery will be exhausted.
  - Turn the camera off frequently by using the [ECONOMY] mode etc. (P25)

**The [CHARGE] lamp flashes.**

- Is the temperature of the battery excessively high or low? If it is, it will take longer than usual to charge the battery or charging may remain incomplete.
- Are the terminals of the charger or battery dirty?
  - Wipe off the dirt using a dry cloth.

**Recording****The picture cannot be recorded.**

- Is the [REC]/[PLAYBACK] selector switch at the [PA/ ] setting? (P20)
- Is there any memory remaining on the built-in memory or the card?
  - Delete the pictures which are not necessary to increase the available memory. (P40, 98)

**The recorded picture is whitish.**

- The picture can become whitish if there is dirt e.g. fingerprints on the lens.
  - If the lens is dirty, turn on the camera, eject the lens barrel (P11) and gently wipe the lens surface with a soft dry cloth.

**The area around where the pictures were taken becomes dark.**

- Was this picture taken with the flash at the close range when the zoom was near [W] (1×)?
  - Zoom in a little, and then take the pictures. (P34)
- Is this a picture taken in [PIN HOLE] in Scene Mode?

**The recorded picture is too bright or dark.**

- Check that the exposure is correctly compensated. (P53)
- Setting the [MIN. SHTR SPEED] to faster speed might make the picture darker.
  - Set the [MIN. SHTR SPEED] to slower speed.

**2 or 3 pictures are taken at one time.**

- Set auto bracket (P54)/color bracket (P55), [HI-SPEED BURST] (P62), [FLASH BURST] (P62) in Scene Mode or [BURST] (P80) of the [REC] mode menu to [OFF].

**The subject is not focused properly.**

- The focus range varies depending on the Recording Mode.
  - Set to the proper mode for the distance to the subject.
- The subject is beyond the focus range of the camera. (P33)
- There is camera shake (jitter) or the subject is moving slightly. (P34)

**The recorded picture is blurred.****The optical image stabilizer is not effective.**

- The shutter speed becomes slower when pictures are taken in dark places so hold the camera firmly with both hands to take the pictures. (P29)
- When taking pictures at a slow shutter speed, use the self-timer. (P47)

**Taking pictures using auto bracket/color bracket is not possible.**

- Is the number of recordable pictures 2 or less?



### The recorded picture looks rough. Noise appears on the picture.

- Is the ISO sensitivity high or the shutter speed slow? (ISO sensitivity is set to [AUTO] when the camera is shipped. Therefore, when taking pictures indoors etc. noise will appear.)
  - Decrease the ISO sensitivity. (P75)
  - Increase the setting for [NOISE REDUCTION] in [PICT.ADJ.] or lower the setting for each of the items other than [NOISE REDUCTION]. (P81)
  - Take pictures in bright places.
- Has [HIGH SENS.] or [HI-SPEED BURST] in the Scene Mode been set? If so, the resolution of the recorded picture decreases slightly because of high sensitivity processing, but this is not a malfunction.

### The brightness or the hue of the recorded picture is different from the actual scene.

- If recording under fluorescent light, the brightness or the hue may change slightly when the shutter speed becomes fast. This occurs due to the characteristics of fluorescent light. It is not a malfunction.

### A reddish vertical line (smear) appears on the LCD monitor during picture-taking.

- This is a characteristic of CCDs, and it appears when the subject has a bright part. Some unevenness may occur in the surrounding areas, but this is not a malfunction. It is recorded in motion pictures but is not recorded on still pictures.
- It is recommended that you take pictures while taking care not to expose the screen to sunlight or any other source of strong light.

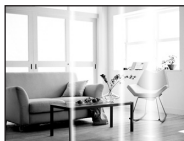

### Motion picture recording stops in the middle.

- Depending on the type of the card, recording may stop in the middle.
  - When you set the recording quality to [HD], [wVGA] or [VGA], we recommend using a high-speed card with "10MB/s" or greater displayed on the package.
  - In the event that it stops even after using a "10MB/s" card or higher, the data writing speed has deteriorated so it is recommended to make a backup and then format (P27).
- Are you using a MultiMediaCard? This unit does not support MultiMediaCards.

### Dynamic tracking does not work even after touching the subject.

- Touch a subject-specific color if the subject has a different color from the periphery. (P48)

## Lens

### Recorded image may be warped, or nonexistent color is surrounding the subject.

- It is possible that the subject may be warped slightly, or the borders get colored, depending on the zoom magnification, due to the characteristics of the lens. Also, the peripherals of the image might look warped because the perspective is enhanced when the wide angle is used. This is not a malfunction.

## LCD monitor

### The LCD monitor turns off although the camera is turned on.

- The LCD monitor turns off and the status indicator lights when [AUTO LCD OFF] (P25) is selected for the [ECONOMY] mode.  
[This does not happen when using the AC adaptor (DMW-AC5PP; optional).]  
If the remaining battery power is low, it may take longer for the flash to be charged, and the time during which the LCD monitor is turned off may become longer.

### The LCD monitor becomes darker or brighter for a moment.

- This phenomenon appears when you press the shutter button halfway to set the aperture value and does not affect the recorded pictures.
- This phenomenon also appears when the brightness changes when the camera is zoomed or when the camera is moved. This is because of operation of the automatic aperture of the camera, and it is not a malfunction.

### The LCD monitor flickers indoors.

- The LCD monitor may flicker for a few seconds after turning the camera on indoors under fluorescent light. This is not a malfunction.

### The LCD monitor is too bright or dark.

- Adjust the brightness of the screen. (P23)
- [POWER LCD] is activated. (P23)

### Black, red, blue and green dots appear on the LCD monitor.

- This is not a malfunction.  
These pixels do not affect the recorded pictures.

### Noise appears on the LCD monitor.

- In dark places, noise may appear to maintain the brightness of the LCD monitor. This does not affect the pictures you are recording.

## Flash

### The flash is not activated.

- Is the flash setting set to [☺]?  
→ Change the flash setting. (P43)
- Flash mode is not available when auto bracket (P54)/color bracket (P55) or [BURST] (P80) in [REC] mode menu has been set.

### Flash is activated several times.

- The flash is activated twice when red-eye reduction (P43) has been set.
- Has [FLASH BURST] (P62) in Scene Mode been set?

## Playback

### The picture being played back is rotated and displayed in an unexpected direction.

- [ROTATE DISP.] (P100) is set to [ON].

### The picture is not played back.

- Is the [REC]/[PLAYBACK] selector switch set to [▶]? (P37)
- Is there a picture on the built-in memory or the card?
  - The pictures on the built-in memory appear when a card is not inserted. The picture data on the card appears when a card is inserted.
- Is this a picture whose file name has been changed in the PC? If it is, it cannot be played back by this unit.

### The recorded pictures are not displayed.

- Has [CALENDAR], [CATEGORY PLAY] or [FAVORITE PLAY] been set for playback?
  - Change to [NORMAL PLAY]. (P37)

### The folder number and the file number are displayed as [—] and the screen turns black.

- Is this a non-standard picture, a picture which has been edited using a PC or a picture which was taken by another make of digital camera?
- Did you remove the battery immediately after picture-taking or did you take the picture using a battery with a low remaining charge?
  - Format the data to delete the pictures mentioned above. (P27)  
(Other pictures will be deleted as well and it will not be possible to restore them. Therefore, check well before formatting.)

### With a calendar search, pictures are displayed on dates differing from the actual dates on which the pictures were taken.

- Is the clock in the camera set properly? (P19)
- When pictures edited using a PC or pictures taken by other equipment are searched, they may be displayed on dates differing from the actual dates on which the pictures were taken.

### White round spots like soap bubbles appear on the recorded picture.

- If you take a picture with the flash in a dark place or indoors, white round spots may appear on the picture caused by the flash reflecting of particles of dust in the air. This is not a malfunction. A characteristic of this is that the number of round spots and their position differ in every picture.



### Red part of the recorded image has changed color to black.

- When the flash is set to red-eye reduction ([⚡], [⚡], [⚡]) and if you take a picture of subject with red color surrounded by a skin tone color, that red part may be corrected to black by the digital red-eye reduction function.
  - It is recommended to take picture with flash mode set to [⚡A], [⚡], or [⊕].

### [THUMBNAIL IS DISPLAYED] appears on the screen.

- Is it a picture that has been recorded with other equipment? In such cases, these pictures may be displayed with a deteriorated picture quality.

### **A clicking sound is recorded in the motion pictures.**

- This unit automatically adjusts the aperture during motion picture recording. At such times, a clicking sound is heard, and this sound may be recorded on the motion pictures. This is not a malfunction.

## **TV, PC and printer**

### **The picture does not appear on the television.**

- Is the camera connected to the TV correctly?  
→ Set the TV input to External Input Mode.
- Output from the [COMPONENT OUT] socket is not possible when it is connected to the PC or the printer.  
→ Connect it only to the TV.

### **The display areas on the TV screen and the camera's LCD monitor are different.**

- Depending on the TV model, the pictures may be extra horizontally or vertically or they may be displayed with their edges cut off.

### **The motion pictures cannot be played back on a TV.**

- Are you trying to play back the motion pictures by directly inserting the card in the card slot of the TV?  
→ Connect the camera to the TV with the AV cable (supplied), or with the component cable (DMW-HDC2; optional), and then play back the motion pictures on the camera. (P110, 111)

### **The picture is not displayed fully on the TV.**

- Check [TV ASPECT] setting. (P26)

### **The picture cannot be transferred when the camera is connected to a PC.**

- Is the camera connected to the PC correctly?
- Is the camera recognized by the PC correctly?  
→ Set to [PC] in [USB MODE]. (P26, 104)

### **The card is not recognized by the PC. (The built-in memory is recognized.)**

- Disconnect the USB connection cable. Connect it again while the card is inserted in the camera.

### **The picture cannot be printed when the camera is connected to a printer.**

- Pictures cannot be printed using a printer which does not support PictBridge.  
→ Set to [PictBridge(PTP)] in [USB MODE]. (P26, 106)

### **The ends of the pictures are cut at printing.**

- When using a printer with a trimming or borderless printing function, cancel this function before printing. (For details, refer to the operating instructions for the printer.)
- When you order photo studios to print pictures, ask the photo studio if the pictures can be printed with both ends.

## Others

### An unreadable language was selected by mistake.

→ Press [MENU/SET], select the [SETUP] menu icon [🔧] and then select the [🌐] icon to set the desired language. (P27)

### A red lamp sometimes turns on when the shutter button is pressed halfway.

- In dark places, the AF assist lamp (P83) lights red to make it easier to focus on a subject.

### The AF assist lamp does not turn on.

- Is [AF ASSIST LAMP] on the [REC] mode menu set to [ON]? (P83)
- The AF assist lamp does not turn on in bright places.

### The camera becomes warm.

- The surface of the camera may become warm during use. This does not affect the performance or quality of the camera.

### The lens clicks.

- When the brightness changes due to zoom or camera movement etc., the lens may click and the picture on the screen may drastically change. However, the picture is not affected. The sound is caused by the automatic adjustment of the aperture. This is not a malfunction.

### The clock is reset.

- If you do not use the camera for a long time, the clock may be reset.  
→ When the message [PLEASE SET THE CLOCK] appears, set the clock again. When you take a picture before setting the clock, [AM12:00 0. 0. 0] is recorded. (P19)

### When pictures are taken using the zoom, they are slightly distorted and the areas around the subject contain colors which are not actually present.

- At some magnification levels, the pictures taken are slightly distorted or the outlines and other areas in the pictures taken are colored, but this is not a malfunction.

### Zooming stops instantaneously.

- When using the extended optical zoom, the zooming action will stop temporarily near [W]. This is not a malfunction.

### Zoom does not go up to maximum magnification.

- Is the camera set to Macro Zoom Mode? (P46)  
Maximum zoom during Macro Zoom Mode is 3× digital zoom.

### The file numbers are not recorded consecutively.

- When you perform an operation after taking a certain action, the pictures may be recorded in folders with different numbers from the ones used prior to the operation. (P105)

**The file numbers are recorded in ascending order.**

- If the battery was inserted or removed without first turning the camera's power off, the folder and file numbers for the pictures taken will not be stored in the memory. When the power is then turned back on and pictures are taken, they may be stored under file numbers which should have been assigned to previous pictures.

**[AGE] is not displayed correctly.**

- Check the clock (P19) and birthday settings (P60).

**The lens barrel is retracted.**

- The lens barrel retracts about 15 seconds after switching from [REC] mode to [PLAYBACK] mode.

**A different thing gets selected from what you touched.**

→ Perform the calibration (P27).









**When the camera is left alone, the slide show is suddenly displayed.**





- This is the [AUTO DEMO] to introduce the features of the camera. Press a button to return the camera to the original screen.









## Number of Recordable Pictures and Available Recording Time

- The number of recordable pictures and the available recording time are an approximation. (These vary depending on the recording conditions and the type of card.)
- The number of recordable pictures and the available recording time varies depending on the subjects.

### ■ Number of recordable pictures

Aspect ratio		4:3							
Picture size		12M		8M (EZ)		5M (EZ)		3M (EZ)	
Quality									
<b>Built-in Memory</b> (Approx. 40 MB)		6	12	8	18	13	26	28	54
<b>Card</b>	32 MB	3	8	5	11	8	16	18	35
	64 MB	8	17	12	24	18	35	37	73
	128 MB	17	35	25	50	37	72	77	145
	256 MB	35	70	50	98	73	140	150	290
	512 MB	70	135	99	195	145	280	300	580
	1 GB	140	280	200	390	290	560	600	1160
	2 GB	290	560	400	790	590	1130	1220	2360
	4 GB	570	1110	800	1560	1170	2230	2410	4640
	6 GB	860	1690	1220	2380	1780	3390	3660	7050
	8 GB	1160	2270	1630	3180	2380	4540	4910	9440
	12 GB	1750	3420	2460	4810	3590	6860	7400	14240
16 GB	2340	4570	3290	6410	4790	9150	9880	19000	
32 GB	4690	9170	6600	12870	9620	18350	19820	38120	

Aspect ratio		4:3			
Picture size		2 M (EZ)		0.3M (EZ)	
Quality					
Built-in Memory (Approx. 40 MB)		45	84	200	320
Card	32 MB	29	54	130	200
	64 MB	60	110	270	420
	128 MB	120	220	550	860
	256 MB	240	440	1080	1690
	512 MB	470	880	2150	3350
	1 GB	950	1770	4310	6710
	2 GB	1920	3610	8780	12290
	4 GB	3770	7090	17240	24130
	6 GB	5730	10790	26210	36700
	8 GB	7670	14440	35080	49120
	12 GB	11570	21790	52920	74090
	16 GB	15440	29060	70590	98830
32 GB	30970	58310	141620	198270	

Aspect ratio		8:9							
Picture size		10.5M		7 M (EZ)		4.5 M (EZ)		2.5 M (EZ)	
Quality									
Built-in Memory (Approx. 40 MB)		6	13	9	19	20	40	31	60
Card	32 MB	4	8	6	12	12	25	20	39
	64 MB	9	18	13	26	27	53	42	81
	128 MB	19	38	27	53	55	105	87	165
	256 MB	38	76	54	105	105	210	170	320
	512 MB	77	150	105	210	210	420	330	640
	1 GB	155	300	210	420	430	850	670	1280
	2 GB	310	620	440	850	890	1700	1360	2560
	4 GB	620	1210	860	1670	1740	3350	2680	5020
	6 GB	940	1850	1310	2540	2650	5090	4070	7640
	8 GB	1260	2480	1760	3410	3550	6820	5450	10230
	12 GB	1900	3740	2660	5140	5360	10290	8230	15430
	16 GB	2540	4990	3550	6860	7160	13720	10980	20590
32 GB	5100	10010	7130	13760	14360	27530	22020	41300	



Aspect ratio		16:9							
Picture size		9 M		6 M (EZ)		3.5 M (EZ)		2 M (EZ)	
Quality									
<b>Built-in Memory</b> (Approx. 40 MB)		7	15	10	21	24	46	41	79
<b>Card</b>	32 MB	4	9	6	13	15	30	27	51
	64 MB	10	21	14	28	32	62	56	105
	128 MB	21	43	29	58	66	125	110	210
	256 MB	43	85	59	110	125	240	220	420
	512 MB	86	165	115	220	250	490	440	830
	1 GB	170	340	230	450	510	990	880	1670
	2 GB	350	680	470	930	1040	1980	1800	3410
	4 GB	690	1350	940	1820	2040	3890	3540	6700
	6 GB	1060	2060	1430	2770	3100	5910	5390	10190
	8 GB	1410	2750	1910	3720	4160	7920	7220	13640
	12 GB	2140	4160	2890	5610	6270	11950	10890	20580
	16 GB	2850	5550	3860	7480	8370	15940	14530	27450
32 GB	5720	11130	7740	15010	16800	31970	29150	55070	

#### ■ Available recording time (when recording motion pictures)

Recording quality setting		HD	WVGA	VGA	QVGA
<b>Built-in Memory</b> (Approx. 40 MB)		—	—	—	1 min 27 s
<b>Card</b>	32 MB	4 s	16 s	17 s	56 s
	64 MB	12 s	37 s	39 s	1 min 58 s
	128 MB	29 s	1 min 18 s	1 min 22 s	4 min 00 s
	256 MB	59 s	2 min 35 s	2 min 40 s	7 min 50 s
	512 MB	2 min 00 s	5 min 10 s	5 min 20 s	15 min 40 s
	1 GB	4 min 00 s	10 min 20 s	10 min 50 s	31 min 20 s
	2 GB	8 min 20 s	21 min 20 s	22 min 10 s	1 h 4 min
	4 GB	16 min 30 s	41 min 50 s	43 min 40 s	2 h 5 min
	6 GB	25 min 10 s	57 min 00 s	1 h 6 min	3 h 11 min
	8 GB	33 min 40 s	1 h 25 min	1 h 28 min	4 h 15 min
	12 GB	50 min 50 s	1 h 55 min	2 h 14 min	6 h 26 min
	16 GB	1 h 8 min	2 h 52 min	2 h 59 min	8 h 35 min
32 GB	2 h 16 min	5 h 45 min	5 h 59 min	17 h 13 min	

- \* Motion pictures can be recorded continuously up to 2 GB.  
The maximum available recording time for up to 2 GB only is displayed on the screen.

#### Note

- The number of recordable pictures and the available recording time displayed on the screen may not decrease in order.
- This unit does not support recording motion pictures on MultiMediaCards.
- The extended optical zoom does not work when [MACRO ZOOM] is set or in [TRANSFORM], [HIGH SENS.], [HI-SPEED BURST], [FLASH BURST], [PIN HOLE], and [FILM GRAIN] in Scene Mode so the picture size for [EZ] is not displayed.

## Specifications

**Digital Camera:** Information for your safety

<b>Power Source:</b>	DC 5.1 V
<b>Power Consumption:</b>	1.3 W (When recording) 0.6 W (When playing back)

<b>Camera effective pixels:</b>	12,100,000 pixels
<b>Image sensor:</b>	1/2.33" CCD, total pixel number 12,700,000 pixels, Primary color filter
<b>Lens:</b>	Optical 5×zoom, f=4.4 mm to 22 mm (35 mm film camera equivalent: 25 mm to 125 mm)/F2.8 to F5.9
<b>Digital zoom:</b>	Max. 4×
<b>Extended optical zoom:</b>	Max. 9.8×
<b>Focus:</b>	Normal, AF Macro, Macro zoom, Touch AF/AE, Face detection, 11-area-focusing, 1-area-focusing (High speed), 1-area-focusing, Spot-focusing, Touched area (during Touch AF/AE)
<b>Focus range:</b>	Normal: 50 cm (1.64 feet) (Wide)/1 m (3.28 feet) (Tele) to ∞ Macro/Intelligent auto: 5 cm (0.17 feet) (Wide)/1 m (3.28 feet) (Tele) to ∞ Scene Mode: There may be differences in the above settings.
<b>Shutter system:</b>	Electronic shutter+Mechanical shutter
<b>Motion picture recording:</b>	1280×720 pixels (30 frames/second, only when using a Card)/ 848×480 pixels (30 frames/second, only when using a Card)/ 640×480 pixels (30 frames/second, only when using a Card)/ 320×240 pixels (30 frames/second) With audio
<b>Burst recording</b>	
<b>Burst speed:</b>	Approx. 2.3 pictures/second (Normal), Approx. 1.8 pictures/second (Unlimited)
<b>Number of recordable pictures:</b>	Max. 5 pictures (Standard), max. 3 pictures (Fine), Depends on the remaining capacity of the built-in memory or the card (Unlimited). (Performance in burst recording is only with SD Memory Card/SDHC Memory Card. MultiMediaCard performance will be less.)

**Hi-speed burst****Burst speed:**

Approx. 10 pictures/second (Speed priority)

Approx. 6 pictures/second (Image priority)

(3M (4:3), 2.5M (3:2) or 2M (16:9) is selected as the picture size.)

**Number of recordable****pictures:**

Approx. 15 to 100

**ISO sensitivity:**

AUTO/80/100/200/400/800/1600

[HIGH SENS.] mode: 1600 to 6400

**Shutter speed:**

60 seconds to 1/2000th of a second

[STARRY SKY] mode: 15 seconds, 30 seconds, 60 seconds

**White balance:**

Auto white balance/Daylight/Cloudy/Shade/Incandescent lights/

White set/Color temperature setting

**Exposure (AE):**

Program AE (P)/Aperture-priority AE (A)/Shutter-priority AE (S)/

Manual exposure (M)

Exposure compensation (1/3 EV Step, -2 EV to +2 EV)

**Metering mode:**

Multiple/Center weighted/Spot

**LCD monitor:**

3.0" TFT LCD

**Flash:**

(Approx. 230,000 dots) (field of view ratio about 100%)

Flash range: [ISO AUTO]

Approx. 60 cm (1.97 feet) to 6.0 m (19.7 feet) (Wide)

AUTO, AUTO/Red-eye reduction, Forced flash ON (Forced ON/

Red-eye reduction), Slow sync./Red-eye reduction, Forced

flash OFF

**Microphone:**

Monaural

**Speaker:**

Monaural

**Recording media:**

Built-in Memory (Approx. 40 MB)/SD Memory Card/SDHC

Memory Card/MultiMediaCard (Still pictures only)

**Picture size****Still picture:**

When the aspect ratio setting is [4:3]

4000×3000 pixels, 3264×2448 pixels, 2560×1920 pixels,

2048×1536 pixels, 1600×1200 pixels, 640×480 pixels

When the aspect ratio setting is [3:2]

4000×2672 pixels, 3264×2176 pixels, 2560×1712 pixels,

2048×1360 pixels

When the aspect ratio setting is [16:9]

4000×2248 pixels, 3264×1840 pixels, 2560×1440 pixels,

1920×1080 pixels

**Motion pictures:**

1280×720 pixels (Only when using a Card)/

848×480 pixels (Only when using a Card)/

640×480 pixels (Only when using a Card)/

320×240 pixels

**Quality:**

Fine/Standard

**Recording file format**

- Still Picture:** JPEG (based on "Design rule for Camera File system", based on "Exif 2.21" standard)/DPOF corresponding
- Pictures with audio:** JPEG (based on "Design rule for Camera File system", based on "Exif 2.21" standard)+"QuickTime" (pictures with audio)
- Motion pictures:** "QuickTime Motion JPEG" (motion pictures with audio)

**Interface**

- Digital:** "USB 2.0" (High Speed)
- Analog video/audio:** NTSC, Component  
Audio line output (monaural)

**Terminal**

- [COMPONENT OUT]:** Dedicated jack (10 pin)
- [AV OUT/DIGITAL]:** Dedicated jack (8 pin)

**Dimensions:**

Approx. 94.9 mm (W)×57.1 mm (H)×21.9 mm (D)  
[3 3/4" (W)×2 1/4" (H)×7/8" (D)]  
(excluding the projecting parts)

**Mass (weight)**

Approx. 145 g/5.11 oz (excluding card and battery)  
Approx. 167 g/5.89 oz (with card and battery)

**Operating temperature:**

0 °C to 40 °C (32 °F to 104 °F)

**Operating humidity:**







10% to 80%

**Language select:**

[ENGLISH]/[ESPAÑOL] (DMC-FX580P)  
[ENGLISH]/[DEUTSCH]/[FRANÇAIS]/[ESPAÑOL]/[ITALIANO]/  
[繁體中文]/[日本語] (DMC-FX580PC)

**Battery Charger****(Panasonic DE-A59B):** Information for your safety**Input:** 110 V to 240 V ~ 50/60 Hz, 0.2 A**Output:** CHARGE 4.2 V = 0.65 A**Equipment mobility:** Movable**Battery Pack  
(lithium-ion)****(Panasonic  
DMW-BCF10PP):** Information for your safety**Voltage/capacity****(Minimum):** 3.6 V/940 mAh

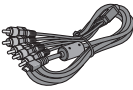
## Digital Camera Accessory System

Accessory#	Illustration	Description
DMW-BCF10PP		Battery Pack
DMW-AC5PP		AC Adaptor*
DMW-DCC4		DC Coupler*
DMW-CHTZ3		Semi Hard Case
DMW-HDC2		Component Cable
RP-SDV32GU1K RP-SDV16GU1K RP-SDM12GU1K RP-SDV08GU1K RP-SDM06GU1K RP-SDM04GU1K RP-SDV04GU1K RP-SDM02GU1A RP-SDV02GU1A RP-SDR01GU1A		32 GB SDHC Memory Card 16 GB SDHC Memory Card 12 GB SDHC Memory Card 8 GB SDHC Memory Card 6 GB SDHC Memory Card 4 GB SDHC Memory Card 4 GB SDHC Memory Card 2 GB SD Memory Card 2 GB SD Memory Card 1 GB SD Memory Card

\* Ensure that the AC adaptor (DMW-AC5PP; optional) and DC coupler (DMW-DCC4; optional) are purchased as a set. Do not use if sold separately.

- Refer to P15 for information about the battery charging time and the number of recordable pictures.
- NOTE: Accessories and/or model numbers may vary between countries. Consult your local dealer.

# Digital Camera Accessory Order Form

(For USA and Puerto Rico Customers)

Please photocopy this form when placing an order.

1. Digital Camera Model # \_\_\_\_\_

2. Items Ordered

Accessory #	Description	Price Each	Quantity	Total Price
Subtotal				
Your State & Local Sales Tax				
Shipping & Handling				6.95
Total Enclosed				

3. Method of payment (check one)

- Check of Money Order enclosed (NO C.O.D.SHIPMENTS)
- VISA                      Credit Card # \_\_\_\_\_
- MasterCard              Expiration Date \_\_\_\_\_
- Discover                    Customer Signature \_\_\_\_\_

Make Check or Money Order to: PANASONIC ACCESSORIES

(Please do not send cash)

4. Shipping information (UPS delivery requires complete street address)

Ship To:

Mr.

Mrs.

Ms. \_\_\_\_\_

First                                      Last

Phone#:

Day (    ) \_\_\_\_\_

Street Address

Night (    ) \_\_\_\_\_

City                                      State      Zip

TO OBTAIN ANY OF OUR DIGITAL CAMERA ACCESSORIES YOU CAN DO ANY OF THE FOLLOWING:

VISIT YOUR LOCAL PANASONIC DEALER

OR

CALL PANASONIC'S ACCESSORY ORDER LINE AT 1-800-332-5368

[6 AM-6 PM M-F, PACIFIC TIME]

OR

MAIL THIS ORDER TO: PANASONIC SERVICE AND TECHNOLOGY COMPANY  
ACCESSORY ORDER OFFICE

20421 84th Avenue South Kent, WA. 98032

In CANADA, please contact your local Dealer for more information about accessories.

## Request for Service Notice (For USA and Puerto Rico Only)

Please photocopy this form when making a request for service notice.

In the unlikely event this product needs service.

**Request for Service Notice:**  
**(USA and Puerto Rico Only)**

- Please include your **proof of purchase.**  
(Failure to do so will delay your repair.)
- To further speed your repair, please provide an explanation of what wrong with the unit and any symptom it is exhibiting.

---

---

---

---

Mail this completed form and your Proof of Purchase along with your unit to:  
Panasonic Camera and Digital Service Center  
1590 Touhy Ave.  
Elk Grove Village, IL 60007



## Limited Warranty (For USA and Puerto Rico Only)

PANASONIC CONSUMER ELECTRONICS COMPANY, DIVISION OF PANASONIC CORPORATION OF NORTH AMERICA

One Panasonic Way, Secaucus, New Jersey 07094

### Panasonic Digital Still Camera Limited Warranty

#### Limited Warranty Coverage

If your product does not work properly because of a defect in materials or workmanship, Panasonic Consumer Electronics Company (referred to as "the warrantor") will, for the length of the period indicated on the chart below, which starts with the date of original purchase ("warranty period"), at its option either (a) repair your product with new or refurbished parts, or (b) replace it with a new or refurbished product. The decision to repair or replace will be made by the warrantor.

PRODUCT OR PART NAME	PARTS	LABOR
<b>DIGITAL STILL CAMERA</b> (EXCEPT ITEMS LISTED BELOW)	<b>1 (ONE) YEAR</b>	<b>1 (ONE) YEAR</b>
<b>CCD</b>	<b>6 (SIX) MONTHS</b>	<b>90 (NINETY) DAYS</b>
<b>RECHARGEABLE BATTERY PACK</b> (IN EXCHANGE FOR DEFECTIVE BATTERY PACK)	<b>90 (NINETY) DAYS</b>	<b>NOT APPLICABLE</b>
<b>SD MEMORY CARD</b> (IN EXCHANGE FOR DEFECTIVE SD CARD)	<b>90 (NINETY) DAYS</b>	<b>NOT APPLICABLE</b>

During the "Labor" warranty period there will be no charge for labor. During the "Parts" warranty period, there will be no charge for parts. You must carry-in or mail-in your product during the warranty period. If non-rechargeable batteries are included, they are not warranted. This warranty only applies to products purchased and serviced in the United States or Puerto Rico. This warranty is extended only to the original purchaser of a new product which was not sold "as is". A purchase receipt or other proof of the original purchase date is required for warranty service.

## **Carry-In or Mail-In Service**

For Carry-In or Mail-In Service in the United States and Puerto Rico call 1-800-211-PANA (7262).

This warranty ONLY COVERS failures due to defects in materials or workmanship, and DOES NOT COVER normal wear and tear or cosmetic damage. The warranty ALSO DOES NOT COVER damages which occurred in shipment, or failures which are caused by products not supplied by the warrantor, or failures which result from accidents, misuse, abuse, neglect, mishandling, misapplication, alteration, faulty installation, set-up adjustments, misadjustment of consumer controls, improper maintenance, power line surge, lightning damage, modification, or commercial use (such as in a hotel, office, restaurant, or other business), rental use of the product, service by anyone other than a Factory Service center or other Authorized Servicer, or damage that is attributable to acts of God.

**THERE ARE NO EXPRESS WARRANTIES EXCEPT AS LISTED UNDER "LIMITED WARRANTY COVERAGE". THE WARRANTOR IS NOT LIABLE FOR INCIDENTAL OR CONSEQUENTIAL DAMAGES RESULTING FROM THE USE OF THIS PRODUCT, OR ARISING OUT OF ANY BREACH OF THIS WARRANTY.** (As examples, this excludes damages for lost time, travel to and from the servicer, loss of media or images, data or other memory content. The items listed are not exclusive, but are for illustration only.) **ALL EXPRESS AND IMPLIED WARRANTIES, INCLUDING THE WARRANTY OF MERCHANTABILITY, ARE LIMITED TO THE PERIOD OF THE LIMITED WARRANTY.**

Some states do not allow the exclusion or limitation of incidental or consequential damages, or limitations on how long an implied warranty lasts, so the exclusions may not apply to you.

This warranty gives you specific legal rights and you may also have other rights which vary from state to state. If a problem with this product develops during or after the warranty period, you may contact your dealer or Service center. If the problem is not handled to your satisfaction, then write to the warrantor's Consumer Affairs Department at the addresses listed for the warrantor.

**PARTS AND SERVICE WHICH ARE NOT COVERED BY THIS LIMITED WARRANTY ARE YOUR RESPONSIBILITY.**

## Customer Services Directory

(United States and Puerto Rico)

Obtain Product Information and Operating Assistance; locate your nearest Dealer or Service Center; purchase Parts and Accessories; or make Customer Service and Literature requests by visiting our Web Site at:

<http://www.panasonic.com/help>

or, contact us via the web at:

<http://www.panasonic.com/contactinfo>

You may also contact us directly at:

1-800-211-PANA (7262),

Monday-Friday 9 am-9 pm; Saturday-Sunday 10 am-7 pm, EST

For hearing or speech impaired TTY users, TTY :1-877-833-8855

### ***Accessory Purchases (United States and Puerto Rico)***

Purchase Parts, Accessories and Instruction Books online for all Panasonic Products by visiting our Web Site at:

<http://www.pstc.panasonic.com>

or, send your request by E-mail to:

[npcparts@us.panasonic.com](mailto:npcparts@us.panasonic.com)

You may also contact us directly at:

1-800-332-5368 (Phone) 1-800-237-9080 (Fax Only)

(Monday - Friday 9 am to 9 pm, EST.)

PANASONIC SERVICE AND TECHNOLOGY COMPANY

20421 84th Avenue South, Kent, WA 98032

(We Accept Visa, MasterCard, Discover Card, American Express, and Personal Checks)

For hearing or speech impaired TTY users, TTY :1-866-605-1277

### ***Product Repairs (United States and Puerto Rico)***

#### **Centralized Factory Service Center**

Panasonic Camera and Digital Service Center

1590 Touhy Ave.

MAIL TO :

Elk Grove Village, IL 60007

Please carefully pack and ship, prepaid and insured, to the Elk Grove Village Centralized Factory Service Center.

As of October 2008

## Précautions à prendre (pour le Canada)

### AVERTISSEMENT :

POUR RÉDUIRE LES RISQUES D'INCENDIE, DE CHOC ÉLECTRIQUE OU DE DOMMAGES À L'APPAREIL,

- N'EXPOSEZ PAS CET APPAREIL À LA PLUIE, À L'HUMIDITÉ, À L'ÉGOUTTEMENT OU AUX ÉCLABOUSSEMENTS, ET NE PLACEZ SUR L'APPAREIL AUCUN OBJET REMPLI DE LIQUIDE, COMME PAR EXEMPLE DES VASES.
- UTILISEZ EXCLUSIVEMENT LES ACCESSOIRES RECOMMANDÉS.
- NE RETIREZ PAS LE COUVERCLE (OU LE PANNEAU ARRIÈRE) ; IL N'Y A AUCUNE PIÈCE RÉPARABLE PAR L'UTILISATEUR À L'INTÉRIEUR. CONFIEZ TOUTE RÉPARATION À UN TECHNICIEN DE SERVICE QUALIFIÉ.

LA PRISE DE COURANT DOIT SE TROUVER À PROXIMITÉ DE L'APPAREIL ET ÊTRE FACILEMENT ACCESSIBLE.

La plaque signalétique se trouve sur le dessous des appareils.

### ■ À propos du bloc-batterie

#### ATTENTION

Batterie (batterie au lithium-ion)

- Utilisez l'unité spécifiée pour recharger la batterie.
  - N'utilisez la batterie avec aucun autre appareil que l'appareil spécifiée.
  - Évitez le contact des saletés, du sable, du liquide ou autres corps étrangers avec les bornes.
  - Ne touchez pas les bornes des fiches (+ et -) avec des objets métalliques.
  - Évitez de démonter, remodeler, chauffer ou jeter au feu.
- Si de l'électrolyte entre en contact avec vos mains ou vos vêtements, lavez-les avec beaucoup d'eau.
- Si de l'électrolyte pénètre dans vos yeux, ne les frottez pas.
- Rincez-vous les yeux avec beaucoup d'eau, puis consultez un médecin.

#### ATTENTION

Danger d'explosion si la batterie/pile n'est pas remplacée correctement. Remplacez-la uniquement par une batterie/pile identique ou du même type recommandée par le fabricant.

Suivez les instructions du fabricant pour jeter les batteries/piles usées.

- N'exposez pas la batterie à la chaleur et tenez-la éloignée de toute flamme.
- Ne laissez pas la ou les batteries dans un véhicule exposé au soleil avec vitres et portes fermées pendant une longue période de temps.

#### Avertissement

Risque d'incendie, d'explosion et de brûlures. Ne pas démonter, chauffer à plus de 60 °C (140 °F) ou incinérer.

## ■ À propos du chargeur de batterie

### ATTENTION!

**NE PAS INSTALLER CET APPAREIL DANS UNE BIBLIOTHÈQUE, UNE ARMOIRE OU TOUT AUTRE ESPACE CONFINÉ. S'ASSURER QUE LA VENTILATION DE L'APPAREIL EST ADÉQUATE. AFIN D'ÉVITER TOUT RISQUE DE CHOC ÉLECTRIQUE OU D'INCENDIE DÙ À UN SURCHAUFFEMENT, S'ASSURER QUE RIDEAUX OU TOUT OBJET QUELCONQUE NE BOUCHENT LES ÉVÉNEMENTS D'AÉRATION DE L'APPAREIL.**

### Chargeur de batterie

Ce chargeur fonctionne sur le secteur entre 110 V et 240 V.

Toutefois

- Aux États-Unis et au Canada, le chargeur doit être branché sur une prise secteur de 120 V seulement.
- Lors du branchement à une prise secteur à l'extérieur des États-Unis ou du Canada, utilisez un adaptateur conforme à la configuration de la prise secteur.

- Assurez-vous d'utiliser un adaptateur secteur de marque Panasonic (DMW-AC5PP; en option).
- Assurez-vous d'utiliser une batterie de marque Panasonic (DMW-BCF10PP).
- Si vous utilisez d'autres batteries, nous ne pouvons pas garantir la qualité de ce produit.
- N'utilisez pas d'autres câbles de connexion USB à l'exception de celui fourni.
- N'utilisez pas d'autres câbles AV à l'exception de celui fourni.
- Conservez la carte mémoire hors de portée des enfants afin qu'ils ne puissent pas l'avaler.

### Évitez d'approcher l'appareil photo de tout équipement magnétisé (four à micro-ondes, téléviseur, équipement de jeux vidéo, etc.).

- Si vous utilisez l'appareil photo à proximité d'un téléviseur, les radiations électromagnétiques pourraient nuire au son et à l'image.
- N'utilisez pas l'appareil photo à proximité d'un téléphone cellulaire; cela pourrait entraîner un bruit nuisible à l'image et au son.
- Le puissant champ magnétique de haut-parleurs ou de moteurs peut endommager les données enregistrées et distordre les images.
- Les ondes électromagnétiques émises par un microprocesseur peuvent nuire à l'appareil photo numérique et perturber l'image et le son.
- Advenant le cas où le fonctionnement de l'appareil serait dérangé par un champ magnétique, coupez le contact, retirez la batterie ou débranchez l'adaptateur secteur (modèle DMW-AC5PP; en option) pour ensuite soit remettre la batterie en place, soit rebrancher l'adaptateur. Remettez l'appareil en marche.

### N'utilisez pas l'appareil photo à proximité d'un émetteur radio ou de lignes à haute tension.

- L'utilisation de l'appareil photo à proximité d'un émetteur radio ou de lignes à haute tension pourrait nuire à l'image ou au son.

Cet appareil numérique de la classe B est conforme à la norme NMB-003 du Canada.

# Index

## A

AC Adaptor .....	17, 104, 106
Access Indication .....	18
Adjusting Flash Output .....	45
Aerial Photo Mode .....	64
AF Assist Lamp .....	83
AF Macro Mode .....	46
AF Mode .....	78
Aperture-priority AE .....	49
Aspect Ratio .....	74, 127
Audio Dubbing .....	102
Audio Recording .....	66, 83
Auto Bracket .....	54
Auto Demonstration .....	27
Auto LCD Off .....	25
Auto Power LCD .....	23
Auto Review .....	25
Auto White Balance .....	77
AV cable .....	110
Available Recording Time .....	129

## B

Baby Mode .....	60
Backlight Compensation .....	30
Battery .....	14, 15, 16
Battery Case .....	115
Beach Mode .....	64
Beep .....	23
Brightness of the LCD Monitor .....	23
Built-in Flash .....	43
Built-in Memory .....	18
Burst .....	80

## C

Calendar .....	87
Calibration .....	27
Candle Light Mode .....	60
Card .....	16, 18
Category .....	89
Center Weighted .....	79
Charger .....	115
Charging .....	14, 15
Cleaning .....	114
Clock Set .....	19, 23, 83
Color Bracket .....	55
Color Effect .....	81
Color Temperature Setting .....	77
Component Cable .....	111
Condensation .....	5
Copy .....	103

## D

Date Printing .....	101, 108
DC Coupler .....	17
DCF standard .....	38
Deleting Pictures .....	40, 98

Demo Mode .....	27
Digital Red-eye Correction .....	44
Digital Zoom .....	34, 81
Display Size .....	24
Dual Play .....	88

## E

Easy Organize .....	90
Easy Zoom .....	36
Economy Mode .....	25
Exposure Compensation .....	53
Extended Optical Zoom .....	34
EZ .....	34, 35, 73, 127

## F

Face Detection .....	30, 78
Face Recognition .....	31, 67, 77
Favorite .....	91
Favorite Play .....	90
File Number .....	26, 105, 113
Film Grain Mode .....	65
Fine .....	74
Fireworks Mode .....	63
Flash Burst Mode .....	62
Focus .....	33, 48
Focus Icon .....	69
Folder Composition .....	105
Folder Number .....	26, 105, 113
Food Mode .....	60
Formatting .....	27

## G

Guide Line .....	24, 41
------------------	--------

## H

High Sensitivity Mode .....	61
Highlight Display .....	24
Hi-speed burst Mode .....	62
Histogram .....	24, 42

## I

Intelligent Auto Mode .....	29
Intelligent Exposure .....	80
Intelligent ISO .....	75
ISO Sensitivity .....	75

## J

Jitter .....	34
--------------	----

## L

Language Setting .....	27
Layout .....	109
LCD Mode .....	23
LCD Monitor .....	41, 112
Leveling .....	94

**M**

Macro Mode .....	46
Macro Zoom Mode .....	46
Manual exposure .....	51
Manual Exposure Assistance .....	52
Metering Mode .....	79
Minimum Shutter Speed .....	82
Motion Picture Mode .....	66
Multi Playback .....	86
Multiple .....	79
My Scene Mode .....	55

**N**

Night Portrait Mode .....	59
Night Scenery Mode .....	59
NO.RESET .....	26
Normal Play .....	37
Number of Prints .....	108
Number of Recordable Pictures .....	15, 127

**O**

Optical Image Stabilizer .....	82
Optical Zoom .....	34

**P**

Panorama Assist Mode .....	58
Paper Size .....	109
Party Mode .....	60
PC .....	26
Personal Information .....	116
Pet Mode .....	61
PictBridge .....	106
Picture Adjustment .....	81
Picture Size .....	73, 127
Pictures with Audio .....	99
Pin Hole Mode .....	65
Playback Pictures on TV .....	110, 111
Playing Back Motion Pictures .....	98
Portrait Mode .....	57
Power LCD .....	23
Power Save .....	25
Print Setting .....	100
Program AE mode .....	32
Protect .....	97

**Q**

Quality .....	74, 127
Quick AF .....	79
Quick Menu .....	22

**R**

Recording Quality Setting (Motion Picture Mode) .....	66
Reset of Setting .....	26
Resizing .....	92
Rotate Display .....	100

**S**

Scene Detection .....	30
Scene Mode .....	55
Scenery Mode .....	58
Self Portrait Mode .....	58
Self-timer .....	47
Setup Menu .....	23
Shutter Volume .....	23
Shutter-priority AE .....	50
Slide Show .....	84
Snow Mode .....	64
Soft Skin Mode .....	57
Sound .....	23
Sports Mode .....	59
Spot .....	79
Spot-focusing .....	78
Standard .....	74
Starry Sky Mode .....	63
Status Indicator .....	25, 29
Stylus Pen .....	12
Sunset Mode .....	64

**T**

Text Stamp .....	96
Thumbnail .....	123
Title Edit .....	94
Touch AF/AE .....	48
Touch Guide .....	26
Touch Panel .....	12
Touch Zoom .....	37
Transform mode .....	57
Travel Date .....	23, 70
Trimming .....	93
Tripods .....	117
TV Aspect .....	26

**U**

USB Connection Cable .....	104, 106
USB Mode .....	26

**V**

Version Display .....	26
Volume of Speakers .....	23

**W**

White Balance .....	76
White Balance Fine Adjustment .....	76
White Set .....	76
World Time .....	23, 72

**Z**

Zoom .....	34
------------	----

- SDHC Logo is a trademark.
- QuickTime and the QuickTime logo are trademarks or registered trademarks of Apple Inc., used under license therefrom.
- Microsoft product screen shot(s) reprinted with permission from Microsoft Corporation.
- Other names, company names, and product names printed in these instructions are trademarks or registered trademarks of the companies concerned.



Panasonic Consumer Electronics Company,  
Division of Panasonic Corporation of North America  
One Panasonic Way, Secaucus, NJ 07094

Panasonic Canada Inc.  
5770 Ambler Drive, Mississauga, Ontario, L4W 2T3

© Panasonic Corporation 2009



Printed in Japan  
VQT1Y62  
F0109TU0 ( 800 Ⓐ)

