

Panasonic®

Operating Instructions

Digital Camera

Model No. **DMC-FZ18**

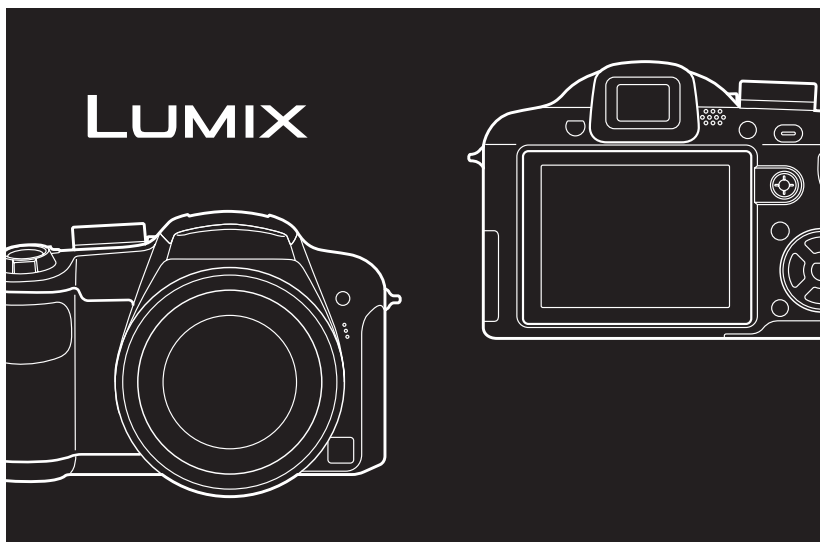
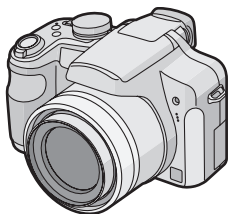

Before connecting, operating or adjusting this product, please read the instructions completely.

LEICA
DC VARIO-ELMARIT

For USA assistance, please call: 1-800-272-7033 or send e-mail to : digitalstillcam@us.panasonic.com

For Canadian assistance, please call: 1-800-99-LUMIX (1-800-995-8649) or
send e-mail to: lumixconclerge@ca.panasonic.com



VQT1F83

**Dear Customer,
Thank you for choosing Panasonic!**

You have purchased one of the most sophisticated and reliable products on the market today. Used properly, we're sure it will bring you and your family years of enjoyment. Please take time to fill in the information on the below.

The serial number is on the tag located on the underside of your Camera. Be sure to **retain this manual** as your convenient Camera information source.

Model No. _____

Serial No. _____

Information for Your Safety

WARNING:

TO REDUCE THE RISK OF FIRE, ELECTRIC SHOCK OR PRODUCT DAMAGE,

- **DO NOT EXPOSE THIS APPARATUS TO RAIN, MOISTURE, DRIPPING OR SPLASHING AND THAT NO OBJECTS FILLED WITH LIQUIDS, SUCH AS VASES, SHALL BE PLACED ON THE APPARATUS.**
- **USE ONLY THE RECOMMENDED ACCESSORIES.**
- **DO NOT REMOVE THE COVER (OR BACK); THERE ARE NO USER SERVICEABLE PARTS INSIDE. REFER SERVICING TO QUALIFIED SERVICE PERSONNEL.**

Carefully observe copyright laws. Recording of pre-recorded tapes or discs or other published or broadcast material for purposes other than your own private use may infringe copyright laws. Even for the purpose of private use, recording of certain material may be restricted.



A lithium ion battery that is recyclable powers the product you have purchased. Please call 1-800-8-BATTERY for information on how to recycle this battery.

- Please note that the actual controls and components, menu items, etc. of your Digital Camera may look somewhat different from those shown in the illustrations in these Operating Instructions.
- SDHC Logo is a trademark.
- Leica is a registered trademark of Leica Microsystems IR GmbH.
- Elmarit is a registered trademark of Leica Camera AG.
- Other names, company names, and product names printed in these instructions are trademarks or registered trademarks of the companies concerned.

THE SOCKET OUTLET SHALL BE INSTALLED NEAR THE EQUIPMENT AND SHALL BE EASILY ACCESSIBLE.

CAUTION

Danger of explosion if battery is incorrectly replaced. Replace only with the same or equivalent type recommended by the manufacturer. Dispose of used batteries according to the manufacturer's instructions.

Warning

Risk of fire, explosion and burns. Do not disassemble, heat above 60 °C (140 °F) or incinerate.

Product Identification Marking is located on the bottom of units.

THE FOLLOWING APPLIES ONLY IN CANADA.

This Class B digital apparatus complies with Canadian ICES-003.

THE FOLLOWING APPLIES ONLY IN THE U.S.A.

FCC Note:

This equipment has been tested and found to comply with the limits for a Class B digital device, pursuant to Part 15 of the FCC Rules. These limits are designed to provide reasonable protection against harmful interference in a residential installation. This equipment generates, uses, and can radiate radio frequency energy and, if not installed and used in accordance with the instructions, may cause harmful interference to radio communications. However, there is no guarantee that interference will not occur in a particular installation. If this equipment does cause harmful interference to radio or television reception, which can be determined by turning the equipment off and on, the user is encouraged to try to correct the interference by one or more of the following measures:

- Reorient or relocate the receiving antenna.
- Increase the separation between the equipment and receiver.
- Connect the equipment into an outlet on a circuit different from that to which the receiver is connected.
- Consult the dealer or an experienced radio/TV technician for help.

FCC Caution: To assure continued compliance, follow the attached installation instructions and use only shielded interface cables with ferrite core when connecting to computer or peripheral devices.

Any changes or modifications not expressly approved by the party responsible for compliance could void the user's authority to operate this equipment.

Declaration of Conformity

Trade Name: Panasonic
Model No.: DMC-FZ18
Responsible party: Panasonic Corporation of North America
One Panasonic Way, Secaucus, NJ 07094
Support Contact: Panasonic Consumer Electronics Company
1-800-272-7033

This device complies with Part 15 of the FCC Rules. Operation is subject to the following two conditions: (1) This device may not cause harmful interference, and (2) this device must accept any interference received, including interference that may cause undesired operation.



-If you see this symbol-

Information on Disposal in other Countries outside the European Union

This symbol is only valid in the European Union.

If you wish to discard this product, please contact your local authorities or dealer and ask for the correct method of disposal.



■ About the battery pack

CAUTION

Battery pack (Lithium ion battery pack)

- Use the specified unit to recharge the battery pack.
- Do not use the battery pack with equipment other than the specified unit.
- Do not get dirt, sand, liquids, or other foreign matter on the terminals.
- Do not touch the plug terminals (+ and -) with metal objects.
- Do not disassemble, remodel, heat or throw into fire.

If any electrolyte should come into contact with your hands or clothes, wash it off thoroughly with water.

If any electrolyte should come into contact with your eyes, never rub the eyes. Rinse eyes thoroughly with water, and then consult a doctor.

■ About the battery charger

CAUTION!

DO NOT INSTALL OR PLACE THIS UNIT IN A BOOKCASE, BUILT-IN CABINET OR IN ANOTHER CONFINED SPACE. ENSURE THE UNIT IS WELL VENTILATED. TO PREVENT RISK OF ELECTRIC SHOCK OR FIRE HAZARD DUE TO OVERHEATING, ENSURE THAT CURTAINS AND ANY OTHER MATERIALS DO NOT OBSTRUCT THE VENTILATION VENTS.

Battery charger

This battery charger operates on AC between 110 V and 240 V.

But

- In the U.S.A. and Canada, the battery charger must be connected to a 120 V AC power supply only.
- When connecting to an AC supply outside of the U.S.A. or Canada, use a plug adaptor to suit the AC outlet configuration.

■ Care of the camera

- **Do not strongly shake or bump the camera by dropping it etc.**
This unit may malfunction, recording pictures may no longer be possible or the lens or the LCD monitor may be damaged.
- Retract the lens before carrying the camera or playing back pictures.
- **Be particularly careful in the following places as they may cause this unit to malfunction.**
 - Places with a lot of sand or dust.
 - Places where water can come into contact with this unit such as when using it on a rainy day or on a beach.
- **Do not touch the lens or the sockets with dirty hands. Also, be careful not to allow liquids to get into the space around the lens, buttons etc.**
- **If water or seawater splashes on the camera, use a dry cloth to wipe the camera body carefully.**

■ About Condensation (When the lens or the Viewfinder is fogged up)

- Condensation occurs when the ambient temperature or humidity changes. Be careful of condensation since it causes lens stains, fungus and camera malfunction.
- If condensation occurs, turn the camera off and leave it for about 2 hours. The fog will disappear naturally when the temperature of the camera becomes close to the ambient temperature.

■ Read together with the “Cautions for Use”. (P120)

■ About cards that can be used in this unit

You can use an SD Memory Card, an SDHC Memory Card and a MultiMediaCard.

- When the term **card** is used in these operating instructions this refers to the following types of Memory Cards.
 - SD Memory Card (8 MB to 2 GB)
 - SDHC Memory Card (4 GB)
 - MultiMediaCard (still pictures only)

More specific information about memory cards that can be used with this unit.

- You can only use an SDHC Memory Card if using cards with 4 GB or more capacity.
- A 4 GB Memory Card without an SDHC logo is not based on the SD Standard and will not work in this product.

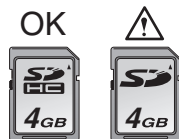

Please confirm the latest information on the following website.

<http://panasonic.co.jp/pavc/global/cs>
(This Site is English only.)

Contents

Before Use

Information for Your Safety	2
-----------------------------------	---

Preparation

Standard Accessories	8
Names of the Components	8
Attaching the Lens Cap/Strap	10
Attaching the Lens Hood	11
Quick Guide	12
Charging the Battery with the Charger ...	13
About the Battery (charging/number of recordable pictures)	13
Inserting and Removing the Card (optional)/the Battery	15
About the Built-in Memory/the Card (optional)	16
Setting Date/Time (Clock Set)	17
• Changing the clock setting	17
About the Mode Dial	18
Setting the Menu	19
About the Setup Menu	20
LCD Monitor/Viewfinder Display/ Switching the LCD Monitor/Viewfinder Display	23

Basic

Taking Pictures	25
Taking pictures using the automatic function (Intelligent Auto Mode)	28
Taking Pictures with the Zoom	30
• Using the Optical Zoom	30
• Using the Extended Optical Zoom (EZ)	31
• Using the Digital Zoom Further extending the zoom	31
Checking the Recorded Picture (Review)	32
Playing back/Deleting Pictures	33

Advanced (Recording pictures)

About the LCD Monitor/Viewfinder	36
• Changing the information displayed	36
• Brightening the LCD Monitor	39
Taking Pictures using the Built-in Flash	40
Taking Pictures with the Self-timer	44
Compensating the Exposure	45
Taking Pictures using Auto Bracket	46
Taking Pictures using Burst Mode	47
Taking Close-up Pictures	48
Aperture-priority AE	50
Shutter-priority AE	50
Manual exposure	51
Aperture Value and Shutter Speed	52
Taking Pictures with Manual Focus	52
Registering Personal Menu Settings (Registering custom settings)	55
Taking pictures in Custom mode	56
Taking expressive portraits and landscape pictures (Advanced scene mode)	57
• [PORTRAIT]	57
• [SCENERY]	58
• [SPORTS]	58
• [NIGHT PORTRAIT]	58
Taking pictures that match the scene being recorded (Scene mode)	59
• [FOOD]	60
• [PARTY]	60
• [CANDLE LIGHT]	60
• [SUNSET]	61
• [HIGH SENS.]	61
• [BABY1]/[BABY2]	61
• [PET]	62
• [PANNING]	62
• [STARRY SKY]	63
• [FIREWORKS]	64
• [BEACH]	65
• [SNOW]	65
• [AERIAL PHOTO]	65
Motion Picture Mode	65

Recording which Day of the Vacation You Take the Picture	67
Displaying the Time at the Travel Destination (World Time)	69
Using the [REC] Mode Menu	71
• [W.BALANCE].....	72
• [WB ADJUST.].....	73
• [INTELLIGENT ISO]	74
• [SENSITIVITY].....	75
• [ASPECT RATIO]	75
• [PICT.SIZE]/[QUALITY]	76
• [AUDIO REC.].....	77
• [METERING MODE].....	78
• [AF MODE]	78
• [STABILIZER]	81
• [CONT.AF].....	82
• [AF ASSIST LAMP].....	82
• [AF/AE LOCK].....	83
• [COL.EFFECT]	83
• [PICT.ADJ.].....	84
• [FLIP ANIM.]	84
• [CONVERSION].....	86

Advanced (Playback)

Displaying Multiple Screens (Multi Playback)	88
Displaying Pictures by Recording Date (Calendar Playback)	89
Using the Playback Zoom.....	90
Playing Back Motion Pictures/Pictures with Audio	91
Creating still pictures from a motion picture	92
Using the [PLAY] mode menu	93
• [SLIDE SHOW]	94
• [CATEGORY].....	95
• [ROTATE DISP.]/[ROTATE]	97
• [FAVORITE].....	98
• [TITLE EDIT].....	99
• [TEXT STAMP]	101
• [DPOF PRINT]	103
• [PROTECT].....	104
• [AUDIO DUB.]	105
• [RESIZE].....	106
• [TRIMMING].....	107

• [ASPECT CONV.].....	108
• [COPY].....	109
• [FORMAT].....	110

Connecting to other equipment







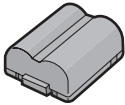
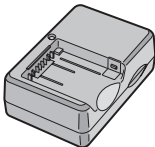

Connecting to a PC.....	111
Printing the Pictures.....	113
Playing Back Pictures on a TV Screen	117

Others

Using the MC Protector/ND Filter	118
Screen Display	118
Cautions for Use	120
Message Display	123
Troubleshooting	125
Number of Recordable Pictures and Available Recording Time	130
Specifications.....	134
Digital Camera Accessory System.....	137
Digital Camera Accessory Order Form (For USA Customers)	138
Request for Service Notice (For USA Only)	139
Limited Warranty (For USA Only)	140
Customer Services Directory (For USA Only)	142
Précautions à prendre (pour le Canada)	143
Index	145

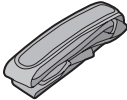
Standard Accessories

Check that all the accessories are included before using the camera.

<p>1</p>  <p>CGR-S006A</p>	<p>2</p>  <p>DE-A43B</p>
<p>3</p>  <p>K1HA08CD0013</p>	<p>4</p>  <p>K1HA08CD0014</p>
<p>5</p> 	<p>6</p>  <p>VFC4269</p>
<p>7</p>  <p>VYK2E94</p>	
<p>8</p>  <p>(A): VYQ4123 (B): VYQ4122</p>	<p>9</p>  <p>VYQ4124</p>

- 1 Battery Pack
(Indicated as **battery** in the text)
- 2 Battery Charger
(Indicated as **charger** in the text)
- 3 USB Connection Cable
- 4 AV Cable
- 5 CD-ROM
 - Software

- 6 Shoulder Strap
- 7 Lens Cap/Lens Cap String
- 8 Lens Hood
 - (A): Silver
 - (B): Black
- 9 Hood Adaptor

- SD Memory Card, SDHC Memory Card and MultiMediaCard are indicated as **card** in the text.
- **The card is optional.**
You can record or play back pictures on the built-in memory when you are not using a card.
- For information about optional accessories, refer to the "Digital Camera Accessory System". (P137)

Names of the Components

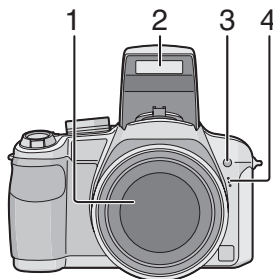

- 1 Lens (P121)
- 2 Flash (P40)
- 3 Self-timer indicator (P44)
AF assist lamp (P82)
- 4 Microphone (P66, 78, 105)

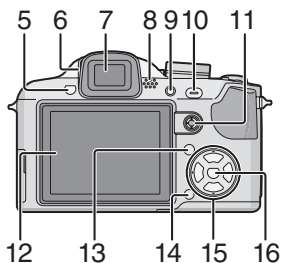

- 5 Flash open button (P40)
- 6 Diopter adjustment dial (P37)
- 7 Viewfinder (P36, 118)
- 8 Speaker (P91)
- 9 [EVF/LCD] button (P36)
- 10 [AF/AE LOCK] button (P83)
- 11 Joystick (P27, 33, 50, 51)

In these operating instructions, the operations using the joystick are described as illustrated below shown.
e.g.: When you tilt the joystick right



e.g.: When you press the center of the joystick



- 12 LCD monitor (P36, 118)
- 13 [DISPLAY/LCD MODE] button (P36, 39)
- 14 Delete button (P33)/
Single or burst mode button (P47)
- 15 Cursor buttons
 - ◀/Self-timer button (P44)
 - ▼/[REV] button (P32)
 - ▶/Flash setting button (P40)
 - ▲/Exposure compensation (P45)/
Auto bracket (P46)/Flash output
adjustment (P43)/
Backlight compensation in intelligent
auto mode (P29) button

In these operating instructions, operations using the cursor button are described with illustrations below.
e.g.: When you press the ▼ button

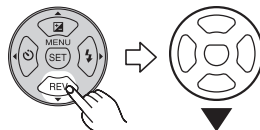

- 16 [MENU/SET] button (P17)

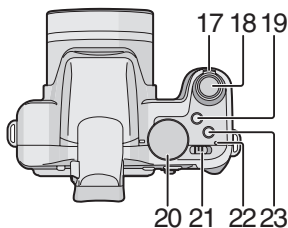

- 17 Zoom lever (P30)
- 18 Shutter button (P25, 65)
- 19 AF macro/Focus switch button (P48, 54)
- 20 Mode dial (P18)
- 21 Camera ON/OFF switch (P17)
- 22 Power lamp (P25)
- 23 [AF/MF] button (P52)

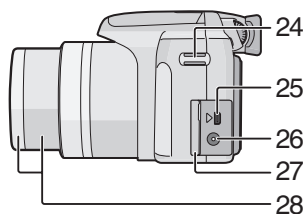

- 24 Strap eyelet
- 25 [DIGITAL/AV OUT] socket (P111, 113, 117)

26 [DC IN] socket (P111, 113)

- Always use a genuine Panasonic AC adaptor (DMW-AC7PP; optional).
- This camera cannot charge the battery even though the AC adaptor (DMW-AC7PP; optional) is connected to it.

27 Terminal door

28 Lens barrel (P118)

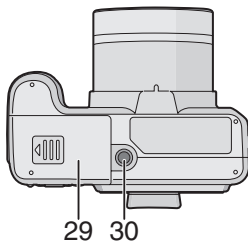

29 Card/Battery door (P15)

30 Tripod receptacle

- When you use a tripod, make sure the tripod is stable when the camera is attached to it.

Attaching the Lens Cap/Strap

■ Lens Cap (supplied)

1 Pass the string through the hole on the lens cap.

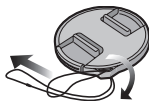

2 Pass the same string through the hole on the camera.

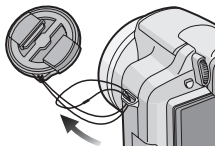

3 Attach the lens cap.

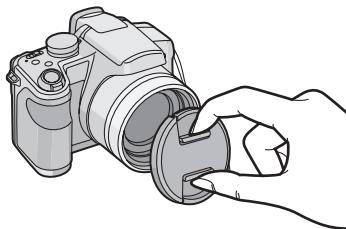

- When you turn the camera off, carry the camera or play back the pictures, attach the lens cap to protect the surface of the lens.
- Detach the lens cap before turning on the camera in the recording mode.
- Be careful not to lose the lens cap.

■ Strap (supplied)

1 Pass the strap through the hole at the strap eyelet.

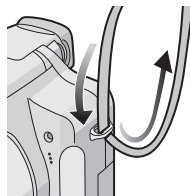

2 Pass the strap through the stopper and fasten the strap.

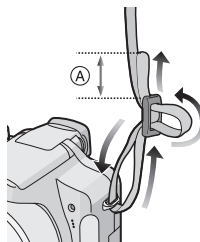

(A): Pull the strap 2 cm or more.



- Attach the strap to the other side of the camera being careful not to twist it.
- Check that the strap is firmly attached to the camera.
- Attach the strap so that the “LUMIX” LOGO is on the outside.
- We recommend attaching the strap when using the camera to prevent it from dropping.

Attaching the Lens Hood

In bright sunlight or backlight, the lens hood will minimize lens flare and ghosting. The lens hood cuts off excess lighting and improves the picture quality.

- Check that the camera is turned off.
- Close the flash.

1 Securely attach the hood adaptor (supplied) so that it is all the way into the lens barrel.

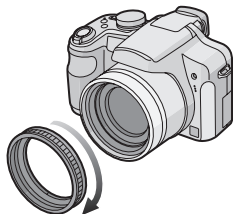

- Do not tighten the hood adaptor too much.

2 Place the camera upside down, align the mark on the lens hood with the mark (A) on the camera and then insert the lens hood.

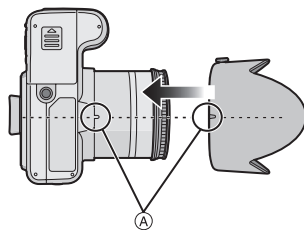

- Make sure the screw is loose and then attach the lens hood.

3 Tighten the screw.

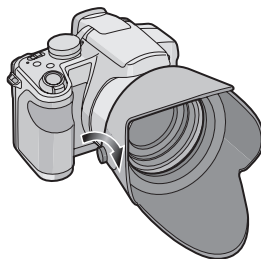

- Do not tighten the screw too much.

■ Removing the hood adaptor

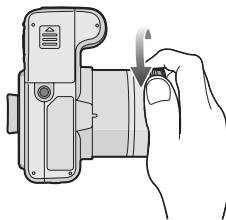

- Grasp the base of the hood adaptor to remove it.



- You cannot attach the lens hood the opposite way.
- When taking pictures with flash with the lens hood attached, the lower portion of the photo may turn dark (vignetting effect) and the control of the flash may be disabled because the photo flash may be obscured by the lens hood. We recommend detaching the lens hood.
- When using the AF assist lamp in the dark, detach the lens hood.
- For details on how to attach the MC protector and the ND filter, refer to P118.
- You cannot attach the tele conversion lens and the close-up lens when the hood adaptor is attached.
- For information about [CONVERSION], refer to P86.
- If any accessories are lost, customers in the USA should contact Panasonic's parts department at 1 800 833-9626 and customers in Canada should contact 1 800 99-LUMIX (1-800-995-8649) for further information about obtaining replacement parts.

Quick Guide

This is an overview of how to record and play back pictures with the camera. For each step, be sure to refer to the pages indicated in brackets.

1 Charge the battery. (P13)

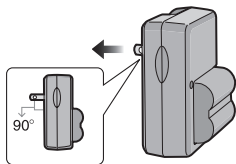

- The battery is not charged when the camera is shipped. Charge the battery before use.

2 Insert the battery and the card. (P15)

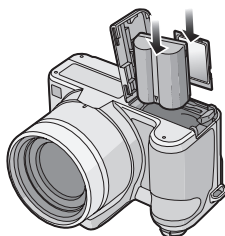

- When you do not use the card, you can record or play back pictures on the built-in memory. (P16) Refer to P16 when you use a card.

3 Turn the camera on to take pictures. (P17)

- Set the clock. (P17)

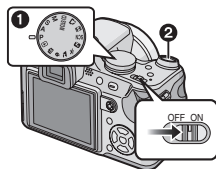

- 1 Set the mode dial to [P].
- 2 Press the shutter button to take pictures. (P25)

4 Play back the pictures. (P33)

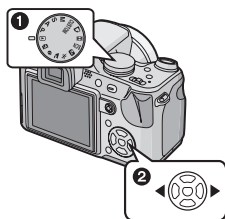

- 1 Set the mode dial to [▶].
- 2 Select the picture you want to view. (P33)

Charging the Battery with the Charger

The battery is not charged when the camera is shipped. Charge the battery before use.

1 Insert the battery terminals and attach the battery to the charger.

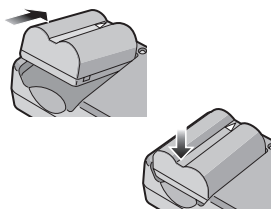

2 Connect the charger to the electrical outlet.

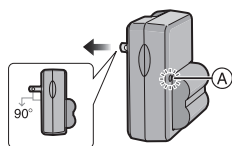

- Charging starts when the [CHARGE] indicator (A) lights green.
- Charging is complete when the [CHARGE] indicator (A) turns off (after about 120 minutes).
- When the [CHARGE] indicator flashes, read P14.

3 Detach the battery after charging is completed.

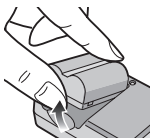

- After charging is completed, be sure to disconnect the power supply device from the electrical outlet.
- The battery becomes warm after using it and during and after charging. The camera also becomes warm during use. This is not a malfunction.
- The battery will be exhausted if left for a long period of time after being charged. Recharge the battery when it is exhausted.
- The battery can be charged even if it is not fully discharged.
- **Use the dedicated charger and battery.**
- **Charge the battery with the charger indoors.**
- **Do not disassemble or modify the charger.**
- **Do not leave any metal items (such as clips) near the contact areas of the power plug. Otherwise, a fire and/or electric shocks may be caused by short-circuiting or the resulting heat generated.**

About the Battery

(charging/number of recordable pictures)

■ The battery life

The number of recordable pictures (By CIPA standard in program AE mode [P])

Number of recordable pictures	Approx. 400 pictures (Approx. 200 min)
-------------------------------	--

Recording conditions by CIPA standard

- Temperature: 23 °C (73.4 °F)/ Humidity: 50% when LCD monitor is on.*
- Using a Panasonic SD Memory Card (16 MB).
- Using the supplied battery.

- Starting recording 30 seconds after the camera is turned on. (When the optical image stabilizer function is set to [MODE1].)
- Recording once every 30 seconds** with full flash every second recording.
- Rotating the zoom lever from Tele to Wide or vice versa in every recording.
- Turning the camera off every 10 recordings and leaving it until the temperature of the battery decreases.
 - * The number of recordable pictures decreases in Auto power LCD mode, Power LCD mode and High angle mode (P39).
- CIPA is an abbreviation of [Camera & Imaging Products Association].

The number of recordable pictures varies depending on the recording interval time. If the recording interval time becomes longer, the number of recordable pictures decreases. [e.g. When recording once every 2 minutes, the number of recordable pictures decreases to about 100.]

The number of recordable pictures when using the Viewfinder
(Recording conditions comply with CIPA standard.)

Number of recordable pictures	Approx. 400 pictures (Approx. 200 min)
--------------------------------------	---

Playback time when using the LCD monitor

Playback time	Approx. 420 min
----------------------	-----------------

The number of recordable pictures and playback time will vary depending on the operating conditions and storing condition of the battery.

■ Charging

Charging time	Approx. 120 min
----------------------	-----------------

Charging time and number of recordable pictures with the optional battery pack (CGR-S006A) are the same as above.

- The [CHARGE] indicator lights when charging starts.

■ When the [CHARGE] indicator flashes

- The battery is over discharged (discharged excessively). In a while, [CHARGE] indicator will light up and normal charging will start.
- The battery temperature is excessively high or low. The charging time will be longer than normal. Also, charging may not be completed.
- The terminals of the charger or the battery are dirty. In this case, wipe them with a dry cloth.
- When the operating time of the camera becomes extremely short even after properly charging the battery, the life of the battery may have expired. Buy a new battery.

■ Charging conditions

- Charge the battery in a temperature between 10 °C to 35 °C (50 °F to 95 °F). (The battery temperature should also be the same.)
- The performance of the battery may temporarily deteriorate and the operating time may become shorter in low temperature conditions (e.g. skiing/ snowboarding).
- The battery may swell and its operating time may become shorter as the number of times it is charged increases. For long term battery use, we recommend you do not frequently charge the battery before it is exhausted.

Inserting and Removing the Card (optional)/the Battery

- Check that this unit is turned off.
- Close the flash.
- Prepare a card. (optional)
- You can record or play back pictures on the built-in memory when you are not using a card.

1 Slide the card/battery door to open it.

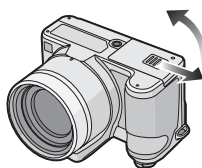

- Always use genuine Panasonic batteries (CGR-S006A).
- If you use other batteries, we cannot guarantee the quality of this product.

2 Battery:

Insert it fully being careful about the direction you insert it.

Pull the lever **A** in the direction of the arrow to remove the battery.

Card:

Push it fully until it clicks being careful about the direction you insert it.

To remove the card, push the card until it clicks, then pull the card out upright.

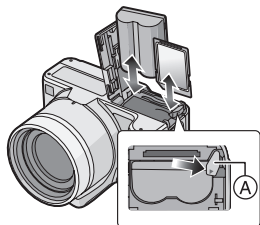

- Do not touch the connection terminals of the card.
- The card may be damaged if it is not fully inserted.

3 ①:

Close the card/battery door.

②:

Slide the card/battery door to the end and then close it firmly.

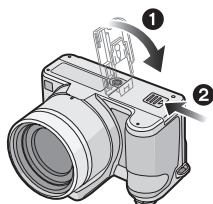

- If the card/battery door cannot be completely closed, remove the card, check its direction and then insert it again.



- Remove the battery after use.
- Do not remove the battery with the camera turned on since the settings on the camera may not be stored properly.
- The supplied battery is designed only for the camera. Do not use it with any other equipment.
- Do not insert or remove the battery or the card while this unit is turned on. The data on the built-in memory or the card may be damaged. Be particularly careful while the built-in memory or the card is being accessed. (P24)
- We recommend using a Panasonic card.

About the Built-in Memory/the Card (optional)

The built-in memory can be used as a temporary storage device when the card being used becomes full.

You can copy the recorded pictures to a card. (P109)

■ Built-in Memory []

You can record or play back pictures with the built-in memory. (The built-in memory cannot be used when a card is inserted.)

- The built-in memory capacity is about 27 MB.
- Picture size is fixed to QVGA (320×240 pixels) when recording motion pictures to the built-in memory.

■ Card []

When a card is inserted, you can record or play back pictures on a card.

■ Card (optional)

- The SD Memory Card, SDHC Memory Card and MultiMediaCard are small, lightweight, removable external cards. Read P5 for information about cards that can be used in this unit.
- The SDHC Memory Card is a memory card standard decided by the SD Association in 2006 for high capacity memory cards more than 2 GB.
- The reading/writing speed of an SD Memory Card and an SDHC Memory Card is fast. Both types of card are equipped with a Write-Protect switch  that prevents writing and formatting the card. (If the switch is slid to the [LOCK] side, it is not possible to write or delete data on the card and format it. When the

switch is slid to the other side, these functions become available.)

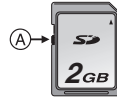

- This unit (SDHC compatible equipment) is compatible with SD Memory Cards based on SD Memory Card Specifications and formatted in FAT12 system and FAT16 system. It is also compatible with SDHC Memory Cards based on SD Memory Card Specifications and formatted in FAT32 system.
- You can use an SDHC Memory Card in equipment that is compatible with SDHC Memory Cards however you cannot use an SDHC Memory Card in equipment that is only compatible with SD Memory Cards. (Always read the operating instructions for the equipment being used. If you also order a photo studio to print pictures, ask the photo studio before printing.) (P5)
- Refer to P130 for information about the number of recordable pictures and the available recording time for each Card.
- We recommend using High Speed SD Memory Cards/SDHC Memory Cards when recording motion pictures.



- The data on the built-in memory or the card may be damaged or lost due to electromagnetic waves, static electricity or breakdown of the camera or the card. We recommend storing important data on a PC etc.
- Do not format the card on your PC or other equipment. Format it on the camera only to ensure proper operation. (P110)
- Keep the Memory Card out of reach of children to prevent swallowing.

Setting Date/Time (Clock Set)



Initial setting

The clock is not set so the following screen appears when you turn the camera on.

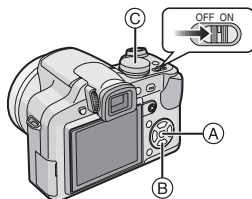

- (A) [MENU/SET] button
- (B) Cursor buttons
- (C) Mode dial

1 Press [MENU/SET].

2 Press ▲/▼/◀/▶ to select the date and time.

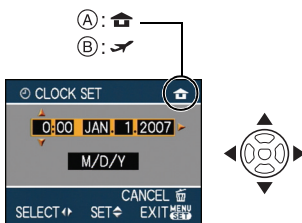

- (A) Time at the home area
- (B) Time at the travel destination (P69)
- ◀/▶: Select the desired item.
- ▲/▼: Set the display order for the date and time.
- [CANCEL]: Cancel without setting the clock.

3 Press [MENU/SET] to set.

- Turn the camera off after setting the clock. Then set the mode dial to a recording mode to turn the camera on and check whether or not the clock setting is correct.

Changing the clock setting

- 1 Press [MENU/SET].
- 2 Press ▲/▼ to select [CLOCK SET].
- 3 Press ▶ and then perform steps 2 and 3 to set the clock.
- 4 Press [MENU/SET] to close the menu.
 - You can also set the clock in the [SETUP] menu. (P20)



- When a fully charged battery has been inserted for more than 24 hours, charging of the built-in battery for the clock is completed so the clock setting will be stored (in the camera) for at least 3 months even if the battery is removed. (If you insert a battery that is not sufficiently charged, the length of time that the clock setting is stored may become less.) However the clock setting is canceled after this time. In this case, set the clock again.
- You can set the year from 2000 to 2099. The 24-hour system is used.
- If the clock is not set, the correct date cannot be printed when you stamp the date on the pictures with [TEXT STAMP] (P101) or order a photo studio to print the pictures.
- If the clock is set, the correct date can be printed even if the date is not displayed on the screen of the camera.

3 Press ▲/▼ to select the setting.

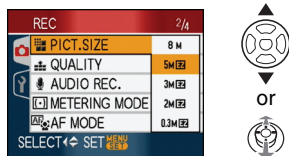

4 Press [MENU/SET] to set.

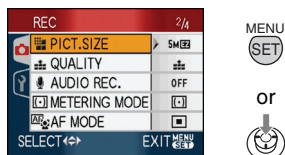

■ Closing the menu screen

Press [MENU/SET].

- When the mode dial is set to [P] / [A] / [S] / [M] / [C] / [H] / [SCN] / [+] / [-] / [Z] / [V] / [TA], you can also close the menu screen by pressing the shutter button halfway or press the center of the joystick to finish.

■ Switching to the [SETUP] menu

1 Press ◀ on a menu screen.

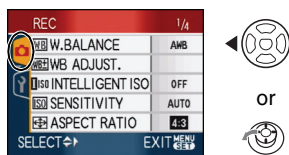

2 Press ▼ to select the [SETUP] menu icon.



3 Press ▶.

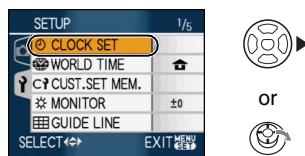

- Select a menu item next and set it.

About the Setup Menu

- Set items as required.
- Select [RESET] to return the settings to the initial settings at the time of purchase. (P22)
- [CLOCK SET], [AUTO REVIEW] and [POWER SAVE] are important items. Check their settings before using them.

🕒 [CLOCK SET] (P17)

(Changing the date and time.)

Press [MENU/SET] to display the [SETUP] menu and select the item to set. (P19)
Change date and time.

🖼️ [AUTO REVIEW]

(Displaying the recorded picture.)

Press [MENU/SET] to display the [SETUP] menu and select the item to set. (P19)
Set the length of time that the picture is displayed after taking it.

[OFF]

[1SEC.]

[3SEC.]

[ZOOM]: The picture is displayed for 1 second and then enlarged 4× and displayed for 1 more second.

- The auto review function is not activated in motion picture mode [H].
- The auto review function is activated regardless of its setting when using the auto bracket (P46) and burst (P47) modes, as well as when recording still

pictures with audio (P77). (The pictures are not enlarged.)

- When the quality is set to [RAW] or [RAW+JPEG], the auto review function works until the end of recording onto the card. (The picture is not enlarged.)
- The auto review setting is disabled when using auto bracket or burst mode, in motion picture mode [], when [AUDIO REC.] is set to [ON] or when the quality is set to [RAW] or [RAW+JPEG].
- In intelligent auto mode [], the auto review function is fixed to [1SEC.].

[POWER SAVE]

(Turning off this unit automatically.)

Press [] to display the [SETUP] menu and select the item to set. (P19)

Power save mode is activated (the camera is automatically turned off to save the battery life) if the camera has not been used for the time selected on the setting.

[1MIN.], [2MIN.], [5MIN.], [10MIN.], [OFF]

- Press the shutter button halfway or turn this unit off and on to cancel power save mode.
- In intelligent auto mode [], power save mode is fixed to [5MIN.].
- Power save mode is not activated in the following cases.
 - When using the AC adaptor (DMW-AC7PP; optional)
 - When connecting to a PC or a printer
 - When recording or playing back motion pictures
 - During a slide show

[WORLD TIME] (P69)

Press [] to display the [SETUP] menu and select the item to set. (P19)

Set the time in your home area and travel destination.

[]: Travel destination area

[]: Your home area

[CUST. SET MEM.]

Press [] to display the [SETUP] menu and select the item to set. (P19)

The current camera settings are registered in [C1], [C2] or [C3]. (P55)
[C1], [C2], [C3]

[MONITOR/VIEWFINDER]

Press [] to display the [SETUP] menu and select the item to set. (P19)

You can adjust the brightness of the monitor or the Viewfinder in 7 steps.

[GUIDE LINE]

Press [] to display the [SETUP] menu and select the item to set. (P19)

Set the pattern of the guide lines displayed when taking pictures.

You can also set whether or not to have the recording information and histogram displayed when the guide lines are displayed. (P36, 38)

[REC. INFO.]: [ON]/[OFF]

[HISTOGRAM]: [ON]/[OFF]

[PATTERN]: []/[]

- In intelligent auto mode [], the guide lines and histogram are not displayed.

[TRAVEL DATE] (P67)

Press [] to display the [SETUP] menu and select the item to set. (P19)

Set the departure date and the return date of the vacation.

[SET], [OFF]

[PLAY ON LCD] (P37)

Press [] to display the [SETUP] menu and select the item to set. (P19)

If you selected the Viewfinder in a recording mode, the display will automatically switch to the LCD monitor when reviewing or playing back the pictures.

[ON], [OFF]

 **[ZOOM RESUME]**

Press [] to display the [SETUP] menu and select the item to set. (P19)

The zoom position is stored when this unit is turned off. When this unit is turned on again, the zoom automatically returns to the position it was at when this unit was turned off. (P30)

[ON], [OFF]

**MF_A [MF ASSIST] (P52)
(Recording mode only)**

Press [] to display the [SETUP] menu and select the item to set. (P19)

In manual focus, the assistance screen appears on the center of the screen to facilitate focusing on the subject.

[MF1]: The center of the screen is enlarged. You can adjust the focus while determining the composition of the whole of the screen.

[MF2]: The center of the screen is enlarged over the whole screen. This is convenient for adjusting the focus in wide angle shots for which changes in focus are difficult to grasp.

[OFF]: The screen is not enlarged.

■)) [BEEP]

Press [] to display the [SETUP] menu and select the item to set. (P19)

This allows you to set the beep.

[]: No operation sound

[]: Soft operation sound

[]: Loud operation sound

 [AF BEEP]

Press [] to display the [SETUP] menu and select the item to set. (P19)

This allows you to set the AF beep.

[]: No AF beep

[]: Soft AF beep

[]: Loud AF beep

 **[SHUTTER]**

Press [] to display the [SETUP] menu and select the item to set. (P19)

This allows you to set the shutter sound.

[]: No shutter sound

[]: Soft shutter sound

[]: Loud shutter sound

 **[VOLUME]**

Press [] to display the [SETUP] menu and select the item to set. (P19)

The volume of speakers can be adjusted in 7 steps from level 6 to 0.

- When you connect the camera to a TV, the volume of the TV speakers does not change.

 **[NO.RESET]**

Press [] to display the [SETUP] menu and select the item to set. (P19)

Reset the file number of the next recording to 0001.

- The folder number is updated and the file number starts from 0001. (P112)
- A folder number between 100 and 999 can be assigned. When the folder number reaches 999, the number cannot be reset. We recommend formatting the card after saving the data on a PC or elsewhere.
- To reset the folder number to 100, format (P110) the built-in memory or the card first and then use this function to reset the file number. A reset screen for the folder number will then appear. Select [YES] to reset the folder number.

 **[RESET]**

Press [] to display the [SETUP] menu and select the item to set. (P19)

The [REC], [CUST. SET MEM.] or [SETUP] menu settings are reset to the initial settings.

- [FAVORITE] (P98) is fixed to [OFF] and [ROTATE DISP.] (P97) is fixed to [ON].
- If the [SETUP] menu settings are reset, the following settings are also reset.

- The birthday and name settings for [BABY1]/[BABY2] (P61) and [PET] (P62) in scene mode.
- The number of days that have passed since the departure date in [TRAVEL DATE]. (P67)
- The [WORLD TIME] (P69) setting.
- [ZOOM RESUME] (P30)
- The folder number and the clock setting are not changed.

[VIDEO OUT]

(Playback mode only)

Press [] to display the [SETUP] menu and select the item to set. (P19)
Set to match the color television system in each country.

- [NTSC]:** Video output is set to NTSC system.
- [PAL]:** Video output is set to PAL system.

[TV ASPECT]

(Playback mode only) (P117)

Press [] to display the [SETUP] menu and select the item to set. (P19)
Set to match the type of TV.







- [16:9]:** When connecting to a 16:9 screen TV.
- [4:3]:** When connecting to a 4:3 screen TV.

[m/ft] (P52)

Press [] to display the [SETUP] menu and select the item to set. (P19)
Change the unit displayed for the focus distance in manual focus.

- [m]:** The distance is displayed in metres.
- [ft]:** The distance is displayed in feet.

[SCN] [SCENE MENU] (P57, 60)

Press [] to display the [SETUP] menu and select the item to set. (P19)
Set the screen that will appear when the mode dial is set to [] / [] / [] / [] / [] / [].



[AUTO]: The advanced scene mode or [SCENE MODE] menu screen appears.

[OFF]: The recording screen in the currently selected advanced scene mode or scene mode appears.

[DIAL DISPLAY]

Press [] to display the [SETUP] menu and select the item to set. (P19)
Set whether or not to show the mode dial display when the mode dial is rotated.
[ON], [OFF]

[LANGUAGE]

Press [] to display the [SETUP] menu and select the item to set. (P19)
Set the language displayed on the screen. [ENGLISH], [DEUTSCH], [FRANÇAIS], [ESPAÑOL], [ITALIANO], [中文]*, [日本語]
* Not displayed on DMC-FZ18P
• If you set a different language by mistake, select [] from the menu icons to set the desired language.

LCD Monitor/ Viewfinder Display/ Switching the LCD Monitor/Viewfinder Display

■ Screen display in program AE mode [] (at the time of purchase)

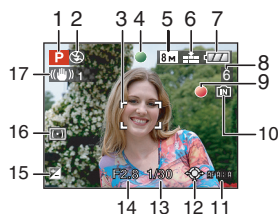

1 Recording mode

- 2 Flash mode (P40)
- 3 AF area (P25)
 - The AF area displayed is bigger than usual when taking pictures in dark places.
- 4 Focus (P25)
- 5 Picture size (P76)
- 6 Quality (P76)
 - : Jitter alert (P27)
- 7 Battery indication



- The indication turns red and blinks if the remaining battery power is exhausted. Recharge the battery or replace it with a fully charged battery.
- It does not appear when you use the camera with the AC adaptor (DMW-AC7PP; optional) connected.

- 8 Number of recordable pictures (P130)
- 9 Recording state
- 10 Built-in memory/Card
 - The access indication lights red when pictures are being recorded on the built-in memory (or the card).
 - When using the built-in memory



- When using the card



- Do not do the following when the access indication lamps lights. The card or the data on the card may be damaged and this unit may no longer operate normally.
 - Turn this unit off.
 - Remove the battery or the card (when using a card).
 - Shake or bump this unit.
 - Disconnect the AC adaptor (DMW-AC7PP; optional). (when using the AC adaptor)
- Do not do the above when pictures are being read or deleted or the built-in memory (or the card) is being formatted (P110).

- The access time for the built-in memory may be longer than the access time for a card.
- 11 AF area selection (P80)
 - 12 Joystick operation (P27, 33, 50, 51)
 - 13 Shutter speed (P25)
 - 14 Aperture value (P25)
 - If the exposure is not adequate, the aperture value and the shutter speed turn red. (They do not turn red when the flash is activated.)
 - 15 Exposure compensation (P45)
 - 16 Metering mode (P78)
 - 17 Optical Image Stabilizer (P81)



- Refer to P118 for information about other screen displays.

■ Switching the screen display

You can change the screen display by pressing [DISPLAY]. This allows you to display information while taking pictures such as the picture size or the number of recordable pictures or take pictures without displaying any information. Refer to P36 for details.

Taking Pictures



The camera automatically sets the shutter speed and the aperture value according to the brightness of the subject.

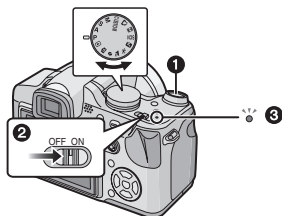

- The power lamp **3** lights when you turn this unit on **2**.
(**1**: Shutter button)

1 Hold this unit gently with both hands, keep your arms still at your side and stand with your feet slightly apart.

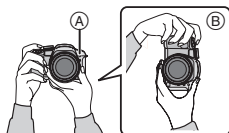

- (A) AF assist lamp
- (B) When holding the camera vertically

2 Aim the AF area at the point you want to focus on.

3 Press the shutter button halfway to focus.

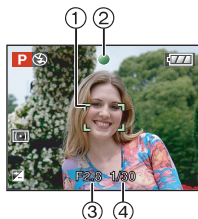

- The focus indication **2** lights green and the AF area **1** turns from white to green.
(**3**: Aperture value, **4**: Shutter speed)
- The subject is not focused in the following cases.
 - The focus indication blinks (green).
 - The AF area turns white to red or there is no AF area.
 - The focus sound beeps 4 times.
- If the subject is not in focus, an estimate of the focus range will appear in red at the bottom of the screen.
- If the distance is beyond the focus range, the picture may not be properly focused even if the focus indication lights.

4 Press the halfway pressed shutter button fully to take a picture.



- When you press the shutter button, the LCD monitor may become bright or dark for a moment however the recorded picture will not be affected.
- Be careful not to move the camera when you press the shutter button.
- Do not cover the microphone or the AF assist lamp with your fingers or other objects.
- Do not touch the front of the lens.
- When taking pictures, make sure your footing is stable and there is no danger of colliding with another person, a ball etc.

■ Exposure (P45)

- The exposure is automatically adjusted to the appropriate exposure on this unit (AE=Auto Exposure). However, depending on the recording conditions such as when there is backlight, the recorded picture will be dark.

In this case, compensate the exposure. This allows you to take bright pictures.

■ Focusing (P26, 48, 54)

• The picture is automatically focused on this unit (AF=Auto Focus). However, the picture may not be properly focused in the following cases. The focus range is 30 cm (0.98 feet) to ∞ (Wide), 2 m (6.56 feet) to ∞ (Tele).

- When there are both near and distant subjects in a scene.
- When there is dirt or dust on glass between the lens and the subject.
- When there are illuminated or glittering objects around the subject.
- When taking a picture in dark places.
- When the subject is moving fast.
- When the scene has low contrast.
- When recording a very bright subject.
- When taking close-up pictures of a subject.
- When jitter occurs.

Try using prefocus, the AF/AE lock technique or [AF MACRO].

For information on the face detection function, read P78.

■ Color (P72, 73)

• The color of the subject will differ if the color of the light surrounding it differs such as when the light comes from sunlight or halogen lighting. However, this unit automatically adjusts the hue to one close to real life. (auto white balance)

Set the white balance if you want to change the hue you get with auto white balance.

Adjust the white balance finely for additional white balance adjustment.

■ When you want to take a picture of a subject outside the AF area (AF/AE Lock)

When recording a picture of people with a composition like the following picture, you will not be able to focus the camera on the

subject because the people are outside the AF area.



In this case,

- ① Aim the AF area at the subject.
 - ② **Press the shutter button halfway to fix the focus and the exposure.**
 - The focus indication lights when the subject is focused.
 - ③ **Press and hold the shutter button halfway while moving the camera as you compose the picture.**
 - ④ Press the shutter button fully.
- You can repeatedly retry AF/AE lock before pressing the shutter button fully.

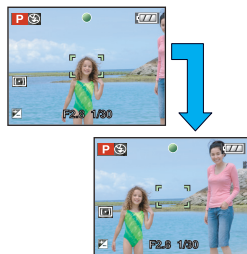

We recommend that you use the face detection function when taking pictures of people. (P78)

■ Direction detection function

Pictures recorded with the camera held vertically are played back vertically (rotated). (Only when [ROTATE DISP] (P97) is set to [ON])

- Pictures may not be displayed vertically if they were taken with the camera aimed up or down.
- Pictures cannot be displayed vertically when recording motion pictures or creating flip animations.

- Program shift is canceled and the camera returns to normal program AE mode if more than 10 seconds pass after program shift is activated. However, the program shift setting is memorized.
- Depending on the brightness of the subject, program shift may not be activated.

Taking pictures using the automatic function (Intelligent Auto Mode)



The camera will set the most appropriate settings to match the subject and the recording conditions so we recommend this mode for beginners or those who want to leave the settings to the camera and take pictures easily.

The following functions work automatically in the intelligent auto mode [**IA**].

■ Stabilizer function (P81)

Jitter is detected and stabilized.

■ Intelligent ISO sensitivity (P74)

The camera will automatically set the appropriate ISO sensitivity and the shutter speed to the movement of the subject and the surrounding brightness.

■ Face detection (P78)

The camera can automatically detect a person's face and will adjust the focus and exposure to fit that face no matter what portion of the picture it is in.

■ Scene detection

The camera will distinguish the scene that matches the subject and the recording conditions.

([**IA**]) is set if none of the scenes are applicable.)

Determined scene

: [i- PORTRAIT]

: [i- SCENERY]

: [i- MACRO]

: [i- NIGHT PORTRAIT]

: [i- NIGHT SCENERY]

- The camera may distinguish different scenes for the same subject depending on the recording conditions.

■ Continuous AF (P82)

In order for the camera to adjust the focus as normal without pressing the shutter button halfway, focus adjustment is quicker when the shutter is pressed.

■ Changing the settings

Press [MENU/SET] to display the [REC] mode menu or the [SETUP] menu, and then select the item to set. (P19)

Items that can be set

Menu	Item
[REC] mode menu	[ASPECT RATIO] (P75)
	[PICT.SIZE] (P76)
	[STABILIZER] (P81)
	[COL.EFFECT] (P83)
[SETUP] menu	[CLOCK SET] (P17)
	[WORLD TIME] (P69)
	[TRAVEL DATE] (P67)
	[BEEP] (P22)
	[LANGUAGE] (P23)

- The available settings for the following items will differ when used with other [REC] modes.
 - [PICT.SIZE]
 - [STABILIZER]
 - [COL.EFFECT]
- The settings for [CLOCK SET], [WORLD TIME], [TRAVEL DATE], [BEEP], and [LANGUAGE] in the intelligent auto mode [**IA**] will also be reflected in other [REC] modes.

- The settings for [CLOCK SET], [WORLD TIME], [MONITOR/VIEWFINDER], [TRAVEL DATE], [ZOOM RESUME], [BEEP], [AF BEEP], [SHUTTER], [NO.RESET], [DIAL DISPLAY], and [LANGUAGE] in the [SETUP] menu (P20) will also be reflected in the intelligent auto mode [iA].

■ Other settings in intelligent auto mode [iA]

In intelligent auto mode [iA], other settings are fixed as follows. For more information about each setting, refer to the page indicated.

- [AUTO REVIEW] (P20): [1SEC.]
- [POWER SAVE] (P21): [5MIN.]
- Self-timer (P44): 10 seconds
- [W.BALANCE] (P72): [AWB]
- [QUALITY] (P76): [] (0.3M EZ): set to []
- [AF MODE] (P78): [] (Set to [] when a face cannot be detected)
- [CONT.AF] (P82): [ON]
- [AF ASSIST LAMP] (P82): [ON]
- [METERING MODE] (P78): []
- You cannot use the following functions.
 - [GUIDE LINE]
 - Exposure compensation
 - Flash output adjustment
 - Auto bracket
 - [D.ZOOM]
 - Out-of-frame display
- You cannot set the following items.
 - [ZOOM RESUME]
 - [CONVERSION]

■ Focus range in intelligent auto mode [iA]

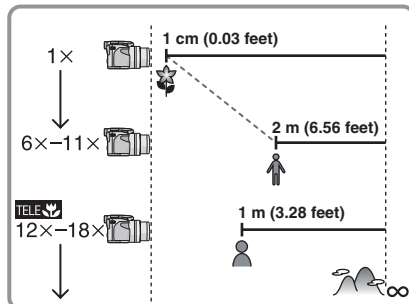

- The indicated zoom magnification is an approximation.
- The zoom magnification values will change when using the extended optical zoom.
- Refer to P49 for the tele-macro.

■ The Backlight Compensation

Backlight refers to when light comes from the back of a subject.

In this case, the subject, such as a person, will become dark so this function compensates the backlight by brightening the whole of the picture.

Press ▲.

- When the backlight compensation function is activated, [] (compensating backlight ON indication (A)) appears. Press ▲ again to cancel this function.

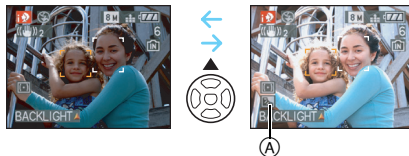



- It is possible to select either AUTO [A] or Forced OFF [OFF] depending upon whether the flash is open or closed. When AUTO [A] is selected, AUTO [A], AUTO/Red-eye reduction [A] or Slow sync./Red-eye reduction [S] is set depending on the type of subject and brightness.
- When AUTO [A] is selected, [i-NIGHT SCENERY] scene mode is not identified.
- When Forced OFF [OFF] is selected, [i-NIGHT PORTRAIT] scene mode is not identified.
- If a tripod is used, for instance, and the camera has judged that camera shake is minimal when the scene mode has been identified as [i-NIGHT SCENERY], the shutter speed will be set to a maximum of 8 seconds. Take care not to move the camera while taking pictures.

Taking Pictures with the Zoom

Using the Optical Zoom



You can make people and objects appear closer and landscapes can be recorded in wide angle with the 18× optical zoom. (35 mm film camera equivalent: 28 mm to 504 mm)

■ To make subjects appear closer use (Tele)

Rotate the zoom lever towards Tele.



■ To make subjects appear further away use (Wide)

Rotate the zoom lever towards Wide.



■ Changing the zoom speed

You can operate the zoom at 2 speeds depending on the rotation angle of the zoom lever.

The zoom speed becomes slower when the rotation angle is small and the zoom speed becomes faster when the rotation angle is large.

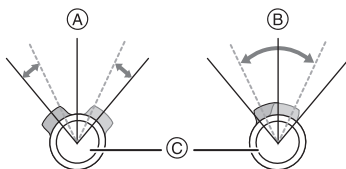

- (A) Fast
- (B) Slow
- (C) Zoom lever

■ Storing the zoom position (Zoom resume)

If [ZOOM RESUME] (P22) in the [SETUP] menu is set to [ON], the zoom position is stored when this unit is turned off. When this unit is turned on again, the zoom position automatically returns to the position it was at when this unit was turned off.

- The focus position is not stored.



- If you use the zoom function after focusing on the subject, focus on the subject again.
- The indicated zoom magnification is an approximation.
- The lens barrel extends or retracts according to the zoom position. Take care not to interrupt the motion of the lens barrel while the zoom lever is rotated.

- When you rotate the zoom lever, you may hear some sound from the camera or the camera may shake. This is not a malfunction.
- When using the zoom function, an estimate of the focus range will appear in conjunction with the zoom display bar. (Example: 0.99 ft. – ∞)

Using the Extended Optical Zoom (EZ)



This camera has a 18× optical zoom. However, if the picture size is not set to the highest setting for each aspect ratio [4:3 / 3:2 / 16:9], a maximum of 28.7× optical zoom can be achieved with no picture quality deterioration.

Extended optical zoom mechanism

When you set the picture size to [3M] (3M EZ) (3 million pixels), the 8M (8.1 million pixels) CCD area is cropped to the center 3M (3 million pixels) area, allowing a picture with a higher zoom effect.

Picture size and maximum zoom magnification

(○: Available, —: Not available)

Aspect ratio (P75)	Picture size (P76)	Maximum zoom magnification (Tele)	Extended optical zoom
4:3	8M (8M)	18×	—
3:2	7M (7M)		
16:9	6M (6M)		
4:3	5M (5M EZ)	23×	○
3:2	4.5M (4.5M EZ)		
16:9	3.5M (3.5M EZ)		

4:3	3M (3M EZ)	28.7×	○
	2M (2M EZ)		
	0.3M (0.3M EZ)		
3:2	2.5M (2.5M EZ)		
16:9	2M (2M EZ)		



- “EZ” is an abbreviation of “Extended optical Zoom”.
- If you set a picture size that activates the extended optical zoom, the extended optical zoom icon [EZ] is displayed on the screen when you use the zoom function.
- The on-screen zoom indication may not change consecutively if you rotate the zoom lever near the Tele position when the extended optical zoom is used. This is not a malfunction.
- The indicated zoom magnification is an approximation.
- In [HIGH SENS.] in scene mode, the extended optical zoom does not work.

Using the Digital Zoom Further extending the zoom



A maximum of 72× zoom can be achieved with the 18× optical zoom and the 4× digital zoom when [D.ZOOM] is set to [ON] in the [REC] mode menu. However, if a picture size that can use extended optical zoom is selected, a maximum of 115× zoom can be achieved with the 28.7× extended optical zoom and the 4× digital zoom.

Menu operation

1 Press [MENU/SET].

- When in advanced scene mode or scene mode, select the [REC] mode menu () and then press ►.

2 Press ▲/▼ to select [D.ZOOM] and then press ►.

3 Press **▼** to select [ON] and then press [MENU/SET].

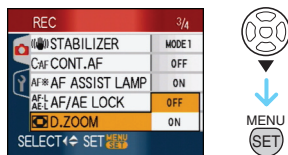

4 Press [MENU/SET] to close the menu.

- You can also press the shutter button halfway to close the menu.

■ Entering the digital zoom range

The on-screen zoom indication may momentarily stop moving when you rotate the zoom lever to the extreme Tele position. You can enter the digital zoom range by continuously rotating the zoom lever to Tele or releasing the zoom lever once and then rotating it to Tele again.

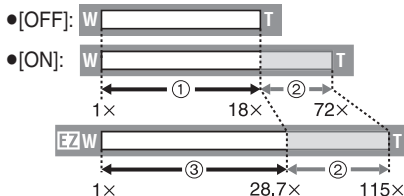

(When using the digital zoom and the extended optical zoom [[3M]] (3M EZ) at the same time)

- ① Optical zoom
- ② Digital zoom
- ③ Extended optical zoom



- A big AF area (P78) is displayed when using the digital zoom. Also, the stabilizer function may not be effective.
- In digital zoom, the larger the picture the lower the picture quality.
- When using the digital zoom, we recommend using a tripod and the self-timer (P44) for taking pictures.

- The indicated zoom magnification is an approximation.
- The digital zoom is temporarily set to [OFF] in the following cases.
 - When the quality is set to [RAW] or [RAW+JPEG] (P76)
- The digital zoom does not work in the following cases:
 - In intelligent auto mode [iA]
 - In [INDOOR PORTRAIT] in [PORTRAIT] mode
 - In [NORMAL SPORTS], [OUTDOOR SPORTS] and [INDOOR SPORTS] in [SPORTS] mode
 - In [HIGH SENS.], [BABY1]/[BABY2] and [PET] in scene mode
 - When [INTELLIGENT ISO] is set to [ON]

Checking the Recorded Picture (Review)



You can check the recorded pictures while still in [REC] mode.

1 Press **▼** [REV].

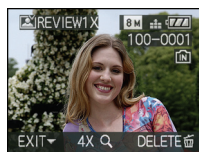

- The last recorded picture appears for about 10 seconds.
- Review is canceled when the shutter button is pressed halfway or the **▼** [REV] is pressed again.
- You can change the information displayed during review by pressing [DISPLAY].

2 Press ◀/▶ to select the picture.



- ◀: Play back the previous picture
- ▶: Play back the next picture

■ Enlarging the picture

1 Rotate the zoom lever towards [Q] [T].

- Rotate the zoom lever to [Q] [T] for a 4× magnification and then rotate it even more for a 8× magnification. When you rotate the zoom lever towards [W] after enlarging the picture, the magnification becomes lower.

2 Press ▲/▼/◀/▶ to move the position.



- When you change the magnification or the position to be displayed, the zoom position indication (A) appears for about 1 second.
- When you press ◀/▶ on the joystick, you can scroll through subsequent and previous images at the enlarged picture size.

■ Deleting the recorded picture during Review (Quick deletion)

A single picture, multiple pictures or all the pictures can be deleted during review.

Refer to P33 to 35 for information about how to delete pictures.



- When [ROTATE DISP.] is set to [ON], pictures recorded holding the camera vertically are played back vertically (rotated).

Playing back/Deleting Pictures



The picture data on the built-in memory is played back or deleted when a card is not inserted. The picture data on the card is played back or deleted when a card is inserted.

Once deleted, pictures cannot be recovered. Check the pictures one by one and delete unwanted pictures.

■ Playing back pictures

Press ◀/▶ to select the picture.



- ◀: Play back the previous picture
- ▶: Play back the next picture

■ Fast forwarding/Fast rewinding Press and hold ◀/▶ during playback.

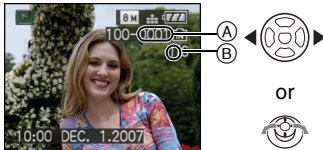

◀: Fast rewind

▶: Fast forward

- The file number (A) and the picture number (B) only change one by one. Release ◀/▶ when the number of the desired picture appears to play back the picture.
- If you keep pressing ◀/▶, the number of pictures forwarded/rewound increases.
- In review playback in recording mode and in multi playback (P88), the pictures can only be forwarded or rewound one by one.



- This camera is based on the DCF standard "Design rule for Camera File system" which was established by the "JEITA (Japan Electronics and Information Technology Industries Association)".
- The LCD monitor may not be able to display the details of the recorded pictures. You can use the playback zoom (P90) to check the details of the pictures.
- If you play back pictures that have been recorded with other equipment, the picture quality may deteriorate. (The pictures are displayed as [THUMBNAIL IS DISPLAYED] on the screen.)
- If you change a folder name or file name on your PC, the pictures may not play back on the camera.
- If you play back a non-standard file, the folder/file number is indicated by [—] and the screen may turn black.
- The lens barrel retracts about 15 seconds after switching from [REC] mode to [PLAY] mode.

- Depending on the subject, an interference fringe may appear on the screen. This is called moire. This is not a malfunction.

■ To delete a single picture

1 Press [] while the picture is being played back.

2 Press ▲ to select [YES] and then press [MENU/SET].



- While the picture is being deleted, [] appears on the screen.

■ To delete [MULTI DELETE]/ [ALL DELETE]

1 Press [] twice.

2 Press ▲/▼ to select [MULTI DELETE] or [ALL DELETE] and then press [MENU/SET].



- [MULTI DELETE] → step 3.
- [ALL DELETE] → step 5.
- [ALL DELETE EXCEPT ★] (When [FAVORITE] (P98) is set only) → step 5.
(However, this cannot be selected if none of the pictures have [★] displayed.)

3 Press ◀/▶ to select the picture and then press ▼ to set.

(Only when selecting [MULTI DELETE])

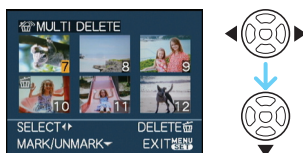

- Repeat the above procedure.
- [] appears on the selected pictures. If ▼ is pressed again, the setting is canceled.
- The icon [] blinks red if the selected picture is protected and cannot be deleted. Cancel the protect setting and then delete the picture. (P104)

4 Press [].

5 Press ▲ to select [YES] and then press [MENU/SET] to set.

(Screen when selecting [MULTI DELETE])

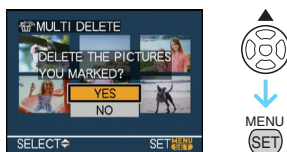

- When you delete pictures, only pictures in either of the built-in memory or the card can be deleted. (You cannot delete pictures in both the built-in memory and the card at the same time.)
- [DELETE ALL PICTURES ON THE BUILT-IN MEMORY?] or [DELETE ALL PICTURES ON THE MEMORY CARD?] is displayed when using [ALL DELETE] and [DELETE ALL EXCEPT ★?] is displayed when using [ALL DELETE EXCEPT ★].

- If you press [MENU/SET] while deleting pictures using [ALL DELETE] or [ALL DELETE EXCEPT ★], the deleting will stop halfway.



- Do not turn off the camera while deleting.
- When deleting pictures, use a battery with sufficient battery power or the AC adaptor (DMW-AC7PP; optional).
- It is possible to delete up to 50 pictures at one time using [MULTI DELETE].
- The greater the number of pictures the longer it takes to delete them.
- If there are pictures that are protected [] (P104), do not conform to the DCF standard or are in a card with the Write-Protect switch slid to the [LOCK] side, they are not deleted even if [ALL DELETE] or [ALL DELETE EXCEPT ★] is selected.

About the LCD Monitor/Viewfinder

Changing the information displayed

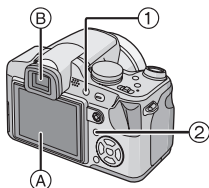

① Switching the LCD monitor/Viewfinder
Press [EVF/LCD] to switch the monitor screen.

- Ⓐ LCD monitor (LCD)
- Ⓑ Viewfinder (EVF)

•When the LCD monitor turns on, the Viewfinder turns off (and vice versa).

② Selecting the screen to be used
Press [DISPLAY] to change the display.

•When the menu screen appears, the [DISPLAY] is not activated. During playback zoom (P90), while playing back motion pictures (P91) and during a slide show (P94), you can only select “Normal display Ⓒ” or “No display Ⓙ”.

In recording mode

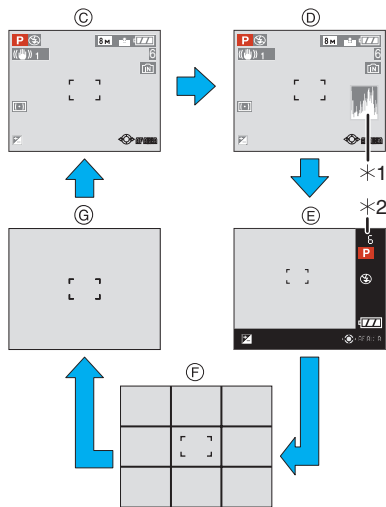

- Ⓒ Normal display
- Ⓓ Display with histogram
- Ⓔ Out-of-frame display
- Ⓕ No display (Recording guide line)*3
- Ⓖ No display

*1 Histogram

*2 When the number of pictures remaining is more than 1000 or the time remaining in motion picture mode is more than 1000 seconds, [+9999] is displayed.

*3 Set the pattern of the guide lines displayed by setting [GUIDE LINE] in [SETUP] menu. You can also set whether or not to have the recording information and histogram displayed when the guide lines are displayed.

In playback mode

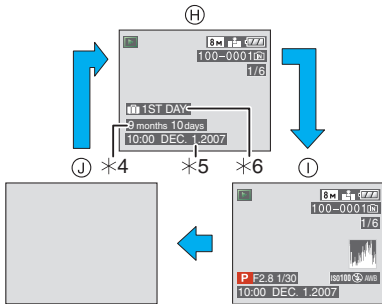

- (H) Normal display
- (I) Display with recording information and histogram
- (J) No display
- *4 Displayed if birthday setting and [AGE] were set to [ON] in [BABY1]/[BABY2] (P61) or [PET] (P62) in scene mode before taking pictures.
- *5 When characters are registered under [BABY1]/[BABY2] (P61) or [PET] (P62) name settings in scene mode, [TITLE EDIT] (P99) in [PLAY] mode menu, the recorded date and time appears after the registered characters are displayed for a few seconds.
- *6 The number of days that have passed since the travel date are displayed if you set [TRAVEL DATE] (P67) before taking pictures.



- With [NIGHT PORTRAIT] mode (P58) and [STARRY SKY] or [FIREWORKS] in scene mode (P59), the guide lines will be shown in gray.

Out-of-frame display

Recording information is displayed on the bottom and right edges of the screen. You can therefore concentrate on the subject when taking pictures without being obstructed by information displayed on the screen.

Diopter adjustment

Adjust the diopter to suit your vision so that you can see the Viewfinder clearly.

- Press [EVF/LCD] to display the viewfinder.

Look at the display on the Viewfinder and rotate the diopter adjustment dial to where the screen is clearest.

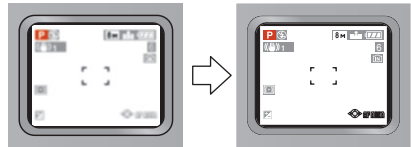
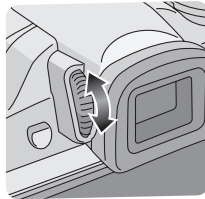

Monitor priority

When [PLAY ON LCD] is set to [ON] on the [SETUP] menu (P21), the LCD monitor is turned on in the following cases.



You can save the time it would take to switch the display to the LCD monitor even when using the Viewfinder to record.

- When switching from recording mode to playback mode.
- When reviewing pictures. (P32)
- When turning the camera on in playback mode.

■ Recording guide line

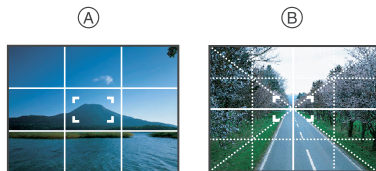
When you place the subject on the horizontal and vertical guide lines or the cross point of these lines, you can take pictures with well-designed composition by viewing the size, the slope and the balance of the subject.



- (A) : This is used when dividing the entire screen into 3×3 for taking pictures with a well-balanced composition.
- (B) : This is used when you want to position the subject at the exact center of the screen.

■ Histogram

A histogram is a graph that displays brightness along the horizontal axis (black to white) and the number of pixels at each brightness level on the vertical axis. It allows you to easily check a picture's exposure.

• It is very useful if manual adjustments of the lens aperture and shutter speed are available, especially in those situations where automatic exposure may be difficult due to uneven lighting. Using the histogram feature allows you to get the maximum performance from your camera.

- (A) When the values are concentrated on the left, the picture is under exposed.
- (B) When the values are distributed evenly, the exposure is proper and the brightness is well-balanced.
- (C) When the values are concentrated on the right, the picture is overexposed.

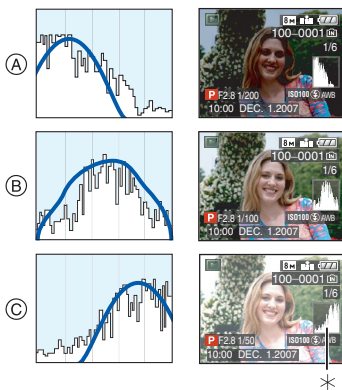

Examples of histogram



- (A) Under Exposed
- (B) Properly Exposed
- (C) Overexposed
- * Histogram



• **When the recorded picture and the histogram do not match each other under the following conditions, the histogram is displayed in orange.**

- When the manual exposure assistance is other than $[\pm 0EV]$ during exposure compensation or in the manual exposure mode
- When the flash is activated
- In [STARRY SKY] or [FIREWORKS] in scene mode (P59)
- When the flash is closed
 - When the brightness of the screen is not correctly displayed in dark places
 - When the exposure is not adequately adjusted
- The histogram is an approximation in recording mode.
- The histogram of a picture may not match in recording mode and playback mode.
- The histogram displayed in this camera does not match histograms displayed by picture editing software used in PCs etc.
- The histogram does not appear during the following.
 - Intelligent auto mode 
 - Motion picture mode 

- Multi playback
- Calendar playback
- Playback zoom

Brightening the LCD Monitor



1 Press [LCD MODE] for 1 second.

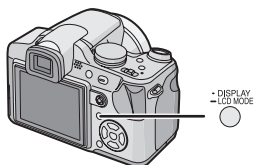

2 Press ▲/▼ to select a mode.

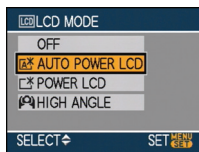

<p>[A*]: [AUTO POWER LCD]</p>	<p>The Power LCD is automatically activated in bright places such as outdoors etc. When the Power LCD is activated, [A] changes to [A*].</p>
<p>[*]: [POWER LCD]</p>	<p>The LCD monitor becomes brighter and easier to see even when taking pictures outdoors.</p>

[Q]:
[HIGH
ANGLE]

The LCD monitor is easier to see when taking pictures with the camera held high above your head. This is useful when you cannot get close to the subject because there is a person in the way. (However it becomes more difficult to see when looked at straight on.)



[OFF]

The LCD monitor returns to the normal brightness.

3 Press [MENU/SET].



- Ⓐ The [AUTO POWER LCD] icon ([A*]), [POWER LCD] icon ([*]) or [HIGH ANGLE] icon ([Q]) appears.

■ Canceling setting

If you press and hold [LCD MODE] again for 1 second the screen shown in step 2 is displayed. Select [OFF] to cancel a setting.



- High angle mode is also canceled if you turn the camera off or power save mode is activated.

- The brightness of the pictures displayed on the LCD monitor screen are increased in Auto power LCD, Power LCD and High angle modes. Therefore, some subjects may look different on the LCD monitor. However, this does not affect the recorded pictures.
- The LCD monitor automatically returns to normal brightness after 30 seconds when recording in Power LCD mode. Press any button to make the LCD monitor bright again.
- If the screen is difficult to see because of light from the sun etc. shining on it, use your hand or another object to block the light.
- Auto power LCD mode or High angle mode is not activated in the following cases.
 - In playback mode [▶]
 - In print mode [🖨️]
 - While the menu screen is displayed
 - While the review screen is displayed

Taking Pictures using the Built-in Flash

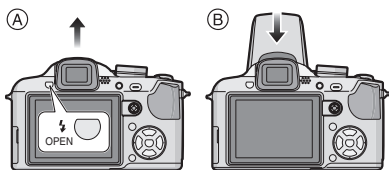

A To open the flash

Press the flash open button.

B To close the flash

Press the flash until it clicks.

- Be sure to close the flash when not in use.
- The flash setting is fixed to Forced OFF [🚫] while the flash is closed.

Switching to the appropriate flash setting

Set the flash to match the recording.

1 Press ▶ [⚡].

2 Press ▲/▼ to select a mode.

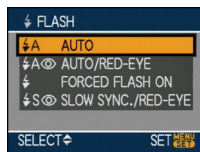

- You can also press ▶ [⚡] to select.
- For information about flash settings that can be selected, refer to “Available flash settings by recording mode”. (P41)

3 Press [MENU/SET].

- You can also press the shutter button halfway or press the center of the joystick to finish.
- The menu screen disappears after about 5 seconds. At this time, the selected item is automatically set.

⚡A : AUTO



The flash is automatically activated when the recording conditions make it necessary.

⚡A👁️ : AUTO/Red-eye reduction*

The flash is automatically activated when the recording conditions make it necessary.

It is activated once before the actual recording to reduce the red-eye phenomenon (eyes of the subject appearing red in the picture) and then activated again for the actual recording.

- Use this when you take pictures of people in low lighting conditions.

reduction [] or Slow sync./
Red-eye reduction [] is set
depending on the type of subject and
brightness.

- The flash setting may change if the recording mode is changed. Set the flash setting again if necessary.
- The flash setting is memorized even if the camera is turned off. However, the advanced scene mode or the scene mode flash setting is reset to the initial setting when the advanced scene mode or the scene mode is changed.

■ The available flash range to take pictures

ISO sensitivity	Available flash range
[AUTO]	Wide
	30 cm (0.98 feet) to 6.0 m (19.7 feet)
	Tele
[ISO100]	Wide
	30 cm (0.98 feet) to 3.0 m (9.84 feet)
	Tele
[ISO200]	Wide
	40 cm (1.31 feet) to 4.2 m (13.8 feet)
	Tele
[ISO400]	Wide
	60 cm (1.97 feet) to 6.0 m (19.7 feet)
	Tele
[ISO800]	Wide
	80 cm (2.62 feet) to 8.5 m (27.9 feet)
	Tele
	Wide
	1.0 m (3.28 feet) to 4.0 m (13.1 feet)
	Tele
	Wide
	1.0 m (3.28 feet) to 7.1 m (23.3 feet)
	Tele
	Wide
	1.15 m (3.77 feet) to 12.1 m (39.7 feet)
	Tele
	Wide
	1.0 m (3.28 feet) to 8.0 m (26.3 feet)
	Tele

[ISO1250]	Wide
	1.0 m (3.28 feet) to 10.7 m (35.1 feet)
	Tele
[ISO1600]	Wide
	1.15 m (3.77 feet) to 12.1 m (39.7 feet)
	Tele
	Wide
	1.0 m (3.28 feet) to 8.0 m (26.3 feet)
	Tele

- The available flash range is an approximation.
- In [HIGH SENS.] (P61) in scene mode, the ISO sensitivity automatically switches to between [ISO1600] and [ISO6400] and the available flash range also differs.
Wide:
Approx. 1.15 m (3.77 feet) to approx. 24.2 m (79.4 feet)
Tele:
Approx. 1 m (3.28 feet) to approx. 16.1 m (52.8 feet)
- The available focus range differs depending on the recording mode. (P134)
- When the flash is used at the intelligent ISO (P74) setting, the ISO sensitivity is increased automatically to maximum ISO sensitivity level.
- When the flash is used at the ISO sensitivity [AUTO] setting, the ISO sensitivity is increased automatically to the maximum [ISO400] level.

■ Shutter speed for each flash setting

Flash setting	Shutter speed (Sec.)
A : AUTO	1/30 to 1/2000
A : AUTO/Red-eye reduction	
ON : Forced ON	1/30 to 1/2000
ON : Forced ON/Red-eye reduction	
S : Slow sync./Red-eye reduction	1 to 1/2000 1/8 to 1/2000*
OFF : Forced OFF	1 to 1/2000 (In program AE mode)

* [PARTY] (P60) in scene mode

- Refer to P52 for the Aperture-priority AE, Shutter-priority AE or Manual exposure mode.
- There will be differences in the above shutter speeds in the following advanced scene mode or scene modes.
 - [NIGHT SCENERY]:
8 seconds to 1/2000th of a second
 - [STARRY SKY]:
15 seconds, 30 seconds, 60 seconds
 - [FIREWORKS]:
1/4th of a second, 2 seconds
- In intelligent auto mode [], shutter speed changes depending on the identified scene.

■ Adjusting flash output

Adjust the flash output when the subject is small or reflection ratio is extremely high or low.

1 Press several times until [FLASH] appears and then press to set the flash output.

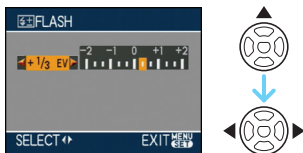

- Select [0] to return to the original flash output.

2 Press [MENU/SET] to finish.

- You can adjust from [-2 EV] to [+2 EV] in steps of [1/3 EV].
- When the flash output is adjusted, the flash output value appears on the upper left of the screen.
- The flash output setting is memorized even if the camera is turned off.
- The flash output cannot be adjusted in the following cases:
 - In intelligent auto mode []
 - In motion picture mode []
 - In [SCENERY] mode
 - In [NIGHT SCENERY], [ILLUMINATIONS] or [CREATIVE NIGHT SCENERY] in [NIGHT PORTRAIT] mode
 - In [SUNSET], [STARRY SKY], [FIREWORKS] or [AERIAL PHOTO] in scene mode



- **Do not look directly at the flash at close range when it is activated.**
- **Do not bring the flash too close to objects or close the flash while it is activated. The objects may be discolored by its heat or lighting.**
- If you press the shutter button halfway when the flash is activated, the flash icon turns red.
- When you take a picture beyond the available flash range, the exposure may not be adjusted properly and the picture may become bright or dark.
- The white balance may not be properly adjusted if the flash level is insufficient for the subject. (P72)

- When the shutter speed is fast, the flash effect may not be sufficient.
- It may take time to charge the flash if you repeat taking a picture. Take a picture after the access indication disappears.
- When the flash is being charged, the flash icon blinks red, and you cannot take a picture even when you press the shutter button fully.
- **When taking a picture with the flash, we recommend removing the lens hood. In some cases it may not allow the scene to be illuminated properly.**
- Do not close the flash soon after the flash is activated prior to taking pictures due to AUTO/Red-eye reduction etc. It causes a malfunction.
- The red-eye reduction effect differs between people. Also, if the subject was far away from the camera or was not looking at the first flash, the effect may not be evident.
- When using a tele conversion lens (optional) or a close-up lens (optional), the built-in flash setting is fixed to Forced OFF [☺].
- When you set burst mode or auto bracket, only 1 picture is recorded for every flash activated.

Taking Pictures with the Self-timer



1 Press ◀ [Ⓢ].

2 Press ▲/▼ to select a mode.

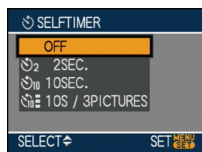

- You can also press ◀ [Ⓢ] to select.
- If you set [10S/3PICTURES], after 10 seconds the camera takes 3 pictures at about 2 second intervals.

3 Press [MENU/SET].

- You can also press the shutter button halfway or press the center of the joystick to finish.
- The menu screen disappears after about 5 seconds. At this time, the selected item is automatically set.

4 Press the shutter button halfway to focus and then press it fully to take the picture.



- (A) Press the shutter button halfway to focus.
- (B) Press the shutter button fully to take the picture.
 - The self-timer indicator (C) blinks and the shutter is activated after 10 seconds (or 2 seconds).
 - When [10S/3PICTURES] is selected, the self-timer indicator blinks again after the first and the second pictures are taken and the shutter is activated 2 seconds after it blinks.

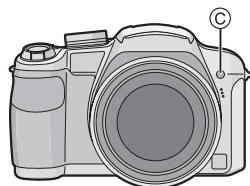

- If you press [MENU/SET] while the self-timer is set, the self-timer setting is canceled.



- When using a tripod etc., setting the self-timer to 2 seconds is a convenient way to avoid the jitter caused by pressing the shutter button.
- When you press the shutter button once fully, the subject is automatically focused just before recording. In dark places, the self-timer indicator will blink and then may turn on brightly operating as an AF assist lamp (P82) to allow the camera to focus on the subject.
- In intelligent auto mode [iA], the self-timer is fixed to 10 seconds.
- When you set the self-timer to [2SEC.] or [10SEC.] in burst mode, the camera starts taking pictures 2 or 10 seconds after the shutter button is pressed. The number of pictures taken at one time is fixed to 3.
- We recommend using a tripod when recording with the self-timer.
- Depending on the recording conditions, the recording interval may become more than 2 seconds when [10S/3PICTURES] is selected.
- The flash output may not be constant when [10S/3PICTURES] is selected.
- You cannot select [10S/3PICTURES] when auto bracket is set.
- You cannot use the following functions when [10S/3PICTURES] is selected.
 - Burst mode
 - [AUDIO REC.]

Compensating the Exposure



Use this function when you cannot achieve appropriate exposure due to the difference in brightness between the subject and the background. Look at the following examples.

Under exposed

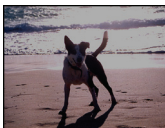

Compensate the exposure towards positive.



Properly exposed

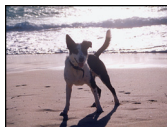

Overexposed



Compensate the exposure towards negative.

■ Operation with the joystick

Select [Z] with ◀ on the joystick and then compensate the exposure with ▲/▼.

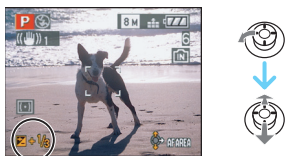

- You can compensate from [-2 EV] to [+2 EV] in steps of [1/3 EV].
- Select [Z] only to return to the original exposure (0 EV).

■ Operation with the cursor buttons

1 Press ▲ [Z] until [EXPOSURE] appears, compensate the exposure with ◀/▶.



- You can compensate from [-2 EV] to [+2 EV] in steps of [1/3 EV].
- Select [0 EV] to return to the original exposure.

2 Press [MENU/SET] to finish.

• You can also press the shutter button halfway to finish.



- EV is an abbreviation of [Exposure Value]. It refers to the amount of light given to the CCD by the aperture value and the shutter speed.
- The exposure compensation value appears on the lower left of the screen.
- The set exposure value is memorized even if the camera is turned off.

- The compensation range of the exposure will be limited depending on the brightness of the subject.
- Exposure compensation is not available in the following case.
 - [STARRY SKY] in scene mode

Taking Pictures using Auto Bracket



In this mode, 3 pictures are automatically recorded in the selected exposure compensation range each time the shutter button is pressed. You can select the picture with the desired exposure from the 3 pictures with different exposures.

1 Press ▲ [Z] several times until [AUTO BRACKET] appears, set the compensation range of the exposure with ◀/▶.

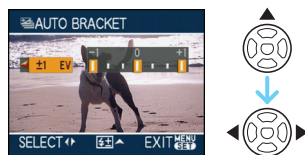

- You can select [OFF] (0), [±1/3 EV], [±2/3 EV] or [±1 EV].
- When you do not use auto bracket, select [OFF] (0).

2 Press [MENU/SET] to finish.

• You can also press the shutter button halfway to finish.



- When setting auto bracket, the auto bracket icon  appears on the screen.
- When taking pictures using auto bracket after setting the exposure compensation range, the pictures taken are based on the selected exposure compensation range. When the exposure is compensated, the exposure compensation value appears on the lower left of the screen.
- The auto bracket setting is canceled if you turn the camera off or power save mode is activated.
- When setting auto bracket and burst mode simultaneously, auto bracket will be performed.
- When auto bracket is set, the auto review function is activated regardless of the auto review setting. (The picture is not enlarged.) You cannot set the auto review function in the [SETUP] menu.
- When auto bracket is activated, [AUDIO REC.] cannot be used.
- The exposure may not be compensated with auto bracket depending on the brightness of the subject.
- In shutter-priority AE and manual exposure, if the shutter speed is set to more than 1 second auto bracket is disabled.
- When the flash is activated or the number of recordable pictures is 2 or less, you can take only 1 picture.
- You cannot use the following functions.
 - [STARRY SKY] in scene mode
 - When the quality is set to [RAW] or [RAW+JPEG]

Taking Pictures using Burst Mode



- 1 Press and hold the single or burst mode button until [BURST SHOOTING] appears.

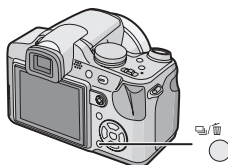

- 2 Press ▲/▼ to select a mode.

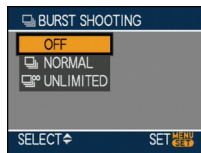

- You can also press the single or burst mode button to select.





- 3 Press [MENU/SET].

- You can also press the shutter button halfway or press the center of the joystick to finish.
- The menu screen disappears after about 5 seconds. At this time, the selected item is automatically set.

- 4 Take a picture.

- Hold down the shutter button fully to activate the burst mode.

■ Number of pictures recorded in burst mode



	Burst speed (pictures/second)	Number of recordable pictures (pictures)	
			
	3*	max. 4	max. 7
	approx. 2	Depends on the remaining capacity of the built-in memory/card.	

* The burst speed is constant regardless of the transfer speed of the card.

- The number of pictures indicated is when the shutter speed is faster than 1/60 and the flash is not activated.
- The burst speed (pictures/second) may become slower depending on the recording environment such as in dark places, if the ISO sensitivity is high etc.
- If you take pictures in burst mode with the built-in memory, it will take time to write the picture data.



• When the burst mode setting is set to Unlimited

- **The burst speed becomes slower halfway.** The exact timing of this depends on the type of card, the picture size and the quality.
- You can take pictures until the capacity of the built-in memory or the card is full.
- The focus is fixed when the first picture is taken.
- The exposure and the white balance vary depending on the burst mode setting. When burst mode is set to [], they are fixed to the values set for the first picture. When the burst speed is set to [], they are adjusted each time you take a picture.
- If you are following a moving subject while taking pictures in a place (landscape) indoors, outdoors etc. where there is a large difference between the light and shade, it may take time until the exposure is stable. If burst is used at this time, the exposure may not become optimal.

- When the self-timer is used, the number of recordable pictures in burst mode is fixed to 3.
- Burst mode is not canceled when the camera is switched off.
- When auto bracket and burst mode are set simultaneously, auto bracket will be performed.
- When burst mode is set, the auto review function is activated regardless of the auto review setting. (The picture is not enlarged.) You cannot set the auto review function in the [SETUP] menu.
- When burst mode is activated, [AUDIO REC.] cannot be used.
- When the flash is activated, you can take only 1 picture.
- Burst mode settings are not available in the following cases.
 - When the quality is set to [RAW] or [RAW+JPEG]
 - [STARRY SKY] and [BEACH] in scene mode

Taking Close-up Pictures



This mode allows you to take close-up pictures of a subject, e.g. when taking pictures of flowers. You can take pictures of a subject as close as 1 cm (0.03 feet) from the lens by rotating the zoom lever upmost to Wide (1×).

As you rotate the zoom lever towards Tele, the distance from the subject that you can take close-up pictures increases in steps up to a maximum of 2 m (6.56 feet). (6× to 11×)

Press the AF macro/focus switch button.

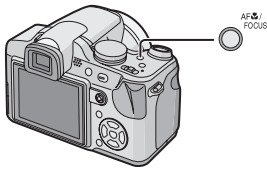

- The AF macro icon [] appears.

Focus range

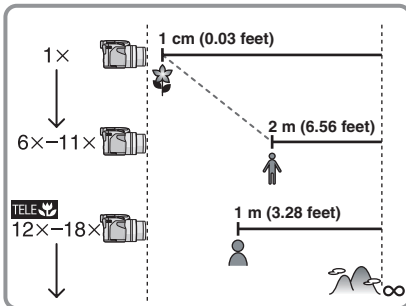

- The indicated zoom magnification is an approximation.
- The zoom magnification values will change when using the extended optical zoom.

Tele-macro function



If you zoom to a magnification of 12 \times to 18 \times (close to Tele), you can take a picture of an object that is only 1 m (3.28 feet) from the lens. (The tele-macro icon [] appears.) It is convenient when taking close-up pictures of flowers blooming near the ground while standing up or when

taking close-up pictures of insects from a distant position.



- We recommend using a tripod and the self-timer in macro mode.
- When a subject is close to the camera, the effective focus range (depth of field) is significantly narrowed. Therefore, if the distance between the camera and the subject is changed after focusing on the subject, it may become difficult to focus on it again.
- In tele macro mode, the depth of field is narrowed and camera jitter occurs easier than usual. Therefore, when you cannot use a tripod, we recommend taking pictures with a brightness equivalent to having the aperture value set to F4.0 or a higher number and the shutter speed is set to 1/125th of a second or faster to keep the depth of field and the performance of the stabilizer function.
- If the distance between the camera and the subject is beyond the focus range of the camera, the picture may not be properly focused even if the focus indication lights.
- AF Macro gives priority to a subject close to the camera. Therefore, if the distance between the camera and the subject is more than 1 m (3.28 feet) it takes longer to focus than in program AE mode [**P**].
- The available flash range is about 30 cm (0.98 feet) to 6.0 m (19.7 feet) (Wide). (When the ISO sensitivity is set to [AUTO].) We recommend setting the flash to Forced OFF [] when you take pictures at close range.
- If you focus on the subject at 2 m (6.56 feet) or less distant position with tele-macro function when setting the optical zoom magnification in 18 \times and then rotate the zoom lever for setting the optical zoom magnification to 11 \times or less, the subject becomes unfocused.
- When you take pictures at close range, the resolution of the periphery of the picture may decrease slightly. This is not a malfunction.

- If the lens becomes dirty with fingerprints or dust, the lens may not be able to focus on the subject correctly.

Aperture-priority AE



Set the aperture value to a higher number when you want a sharp focus background. Set the aperture value to a lower number when you want a soft focus background.

1 Tilt the joystick towards ▲/▼ to set the aperture value.

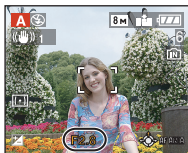

2 Take a picture.

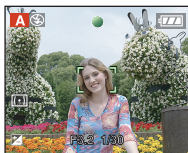

- Refer to P52 for the available aperture values and the shutter speed.
- Set the aperture value to a higher number when the subject is too bright. Set the aperture value to a lower number when the subject is too dim.
- The brightness of the LCD monitor/Viewfinder and the recorded pictures may differ. Check the pictures using the review function or playback mode.
- The aperture value and the shutter speed displayed on the screen turn red when the exposure is not adequate.

Shutter-priority AE



When you want to take a sharp picture of a fast moving subject, set with a faster shutter speed. When you want to create a trail effect, set to a slower shutter speed.

1 Tilt the joystick towards ▲/▼ to set the shutter speed.

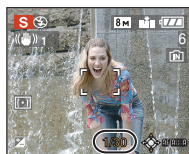

2 Take a picture.

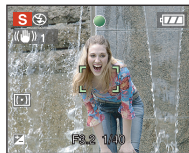

- Refer to P52 for the available aperture values and the shutter speed.
- The brightness of the LCD monitor/Viewfinder may differ from the brightness of the actual pictures. Check the pictures using the review function or playback mode.
- You cannot set the following items in Shutter-priority AE.
 - Slow sync./Red-eye reduction [⚡👁️]
 - [INTELLIGENT ISO]
- The aperture value and the shutter speed displayed on the screen turn red when the exposure is not adequate.
- We recommend using a tripod when the shutter speed is slow.

Manual exposure



Determine the exposure by manually setting the aperture value and the shutter speed.

- 1 Tilt the joystick towards ▲/▼/◀/▶ to set the aperture value and the shutter speed.**



	Set the aperture value and the shutter speed.
	Switch between the aperture value and the shutter speed.

- 2 Press the shutter button halfway.**

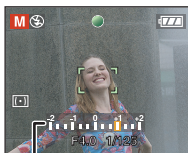

A



- The manual exposure assistance (A) appears for about 10 seconds to indicate the exposure.
- Set the aperture value and the shutter speed again when the exposure is not adequate.

- 3 Take the picture.**

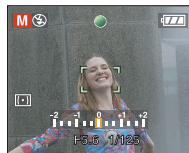

Manual Exposure Assistance

	The exposure is adequate.
	Set to faster shutter speed or larger aperture value.
	Set to slower shutter speed or smaller aperture value.

- The manual exposure assistance is an approximation. We recommend checking the pictures after taking them using the review function.



- Refer to P52 for the available aperture values and the shutter speed.
- The brightness of the LCD monitor/Viewfinder may differ from the brightness of the actual pictures. Check the pictures using the review function or playback mode.
- If the exposure is not adequate, the aperture value and the shutter speed turn red when the shutter button is pressed halfway.
- You cannot set the following items in manual exposure.
 - Slow sync./Red-eye reduction [⚡ S👁]
 - [INTELLIGENT ISO]
 - [AUTO] in ISO sensitivity (The ISO sensitivity is automatically set to [ISO100] when you switch from [AUTO] to Manual exposure.)
 - Exposure compensation

Aperture Value and Shutter Speed

Aperture-priority AE

Available Aperture Value (Per 1/3 EV)			Shutter Speed (Sec)
F8.0			8 to 1/2000
F7.1	F6.3	F5.6	8 to 1/1600
F5.0	F4.5	F4.0	8 to 1/1300
F3.6	F3.2	F2.8	8 to 1/1000

Shutter-priority AE

Available Shutter Speed (Sec) (Per 1/3 EV)		Aperture Value
8	6	F2.8 to F8.0
5	4	
3.2	2.5	
2	1.6	
1.3	1	
1/1.3	1/1.6	
1/2	1/2.5	
1/3.2	1/4	
1/5	1/6	
1/8	1/10	
1/13	1/15	
1/20	1/25	
1/30	1/40	
1/50	1/60	
1/80	1/100	
1/125	1/160	
1/200	1/250	
1/320	1/400	
1/500	1/640	
1/800	1/1000	
1/1300		F4.0 to F8.0
1/1600		F5.6 to F8.0
1/2000		F8.0

Manual exposure

Available Aperture Value (Per 1/3 EV)	Available Shutter Speed (Sec) (Per 1/3 EV)
F2.8 to F3.6	60 to 1/1000
F4.0 to F5.0	60 to 1/1300
F5.6 to F7.1	60 to 1/1600
F8.0	60 to 1/2000



- The aperture values given in the table above are values when the zoom lever is rotated to Wide.
- Depending on the zoom magnification, some of the aperture values cannot be selected.

Taking Pictures with Manual Focus



Use this function when you want to fix the focus or when the distance between the lens and the subject is determined and you do not want to activate auto focus.

1 Press and hold [AF/MF].

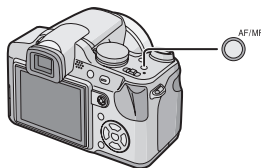

- The MF icon [**MF**] appears.

2 Tilt the joystick towards ▲/▼ to focus on the subject.

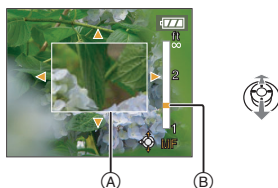

- Ⓐ MF assistance
- Ⓑ Focus range

- MF assistance disappears about 2 seconds after you stop operating the joystick.
- Focus range disappears about 5 seconds after you stop operating the joystick.

3 Take the picture.



MF ASSIST

If you tilt the joystick towards ▲/▼ when [MF ASSIST] is set to [MF1] or [MF2], MF assistance is activated and the screen is enlarged. This allows you to focus on the subject more easily.

1 Press [MENU/SET] and then press ◀.

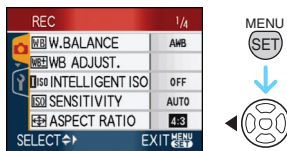

2 Press ▼ to select the [SETUP] menu icon [Y] and then press ▶.

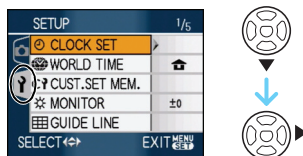

3 Press ▲/▼ to select [MF ASSIST] and then press ▶.

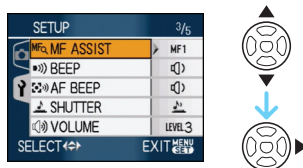

4 Press ▲/▼ to select [MF1] or [MF2] and then press [MENU/SET].

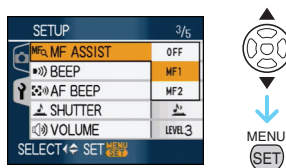

[MF1]	The center of the screen is enlarged. You can adjust the focus while determining the composition of the whole of the screen.
[MF2]	The center of the screen is enlarged over the whole screen. This is convenient for adjusting the focus in wide angle shots for which changes in focus are difficult to grasp.
[OFF]	The screen is not enlarged.

5 Press [MENU/SET] to close the menu.

- You can also close the menu by pressing the shutter button halfway.
- You can also use the joystick to perform steps **2** to **5**.

■ Technique for Manual focus

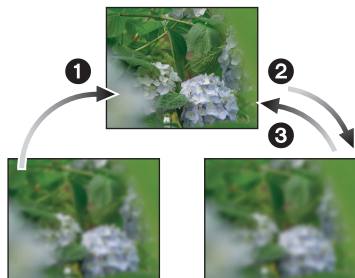

- 1 Tilt the joystick towards ▲/▼.
- 2 Tilt it a little more.
- 3 Tilt the joystick in the opposite direction to finely focus on the subject.

■ One shot AF

You can focus on the subject with auto focus by selecting [MF] with [AF/MF] and then pressing the AF macro/focus switch button.

This is convenient for prefocus.

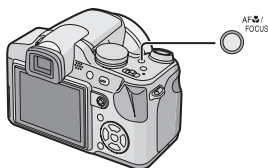

■ Prefocus

This is a technique for focusing in advance on the point the pictures will be taken when it is difficult to focus on the subject with auto focus due to its quick motion. (e.g. [PANNING] (P62) in scene mode)

This function is suitable when the distance between the camera and the subject is certain.

■ Changing the zoom area

The magnified area can be changed while the screen is expanded using MF Assist. This is convenient when you want to change the focus position to take pictures.

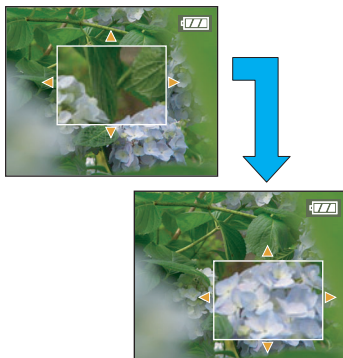

- 1 Display MF Assist with ▲/▼ on the joystick.
 - 2 Change the expanded area with the cursor buttons ▲/▼/◀/▶.
 - The expansion is canceled after approximately 2 seconds.
- The following will return the MF assistance to the original position.
 - Switching the focus to [AF].
 - When one shot AF is used
 - Changing the picture size or aspect.
 - Turning the camera off.



- You can also use manual focus while in motion picture mode [H], but the focus cannot be adjusted during recording.
- If you focus on the subject in Wide and then rotate the zoom lever to Tele, the focus may not be adequate. In this case, focus on the subject again.
- The MF assistance does not appear when using the digital zoom.

- The distance to the subject displayed on the screen in manual focus is an approximation of the focus position. Remember that the distance is an approximation when taking a picture.
- Use the MF assistance screen for a final check of the focus.
- After canceling power save mode, focus on the subject again.
- The following function cannot be set when manual focus is set.
– [CONT.AF]

Registering Personal Menu Settings (Registering custom settings)



Select the desired recording mode and the desired menu settings and then save them in [C1], [C2] or [C3].

- Set to the mode dial to the desired mode and select the desired menu settings in advance.

1 Press [MENU/SET] and then press ◀.

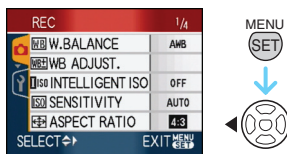

2 Press ▼ to select the [SETUP] menu icon [⌘] and then press ▶.

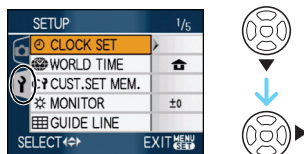

3 Press ▲/▼ to select [CUST. SET MEM.] and then press ▶.



4 Press ▲/▼ to select [C1], [C2] or [C3] and then press [MENU/SET].

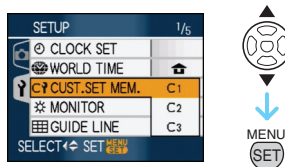

5 Press ▲ to select [YES] and then press [MENU/SET].

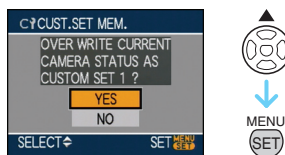

- When [YES] is selected, the settings that were previously stored are overwritten.
- You cannot save the following menu items because they affect other recording modes.
 - [CLOCK SET]
 - [TRAVEL DATE]

- [RESET]
- [NO.RESET]
- [BABY1]/[BABY2] or [PET] birthday and name settings in scene mode

6 Press [MENU/SET] to close the menu.

Taking pictures in Custom mode



You can select one of your own custom settings to suit the picture-taking conditions and other factors from among the registered patterns you have saved as custom settings ahead of time.

1 Press ▲/▼ to select [C1]SET1, [C2]SET2 or [C3]SET3.



- Press ► to display the settings for each menu item. (Press ◀ to return to the selection screen.)

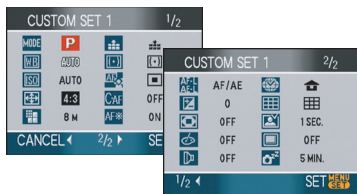

- Only the main menu items are displayed.

2 Press [MENU/SET] to enter the settings.



MENU
SET

- (A) Saving of the selected custom settings is displayed on the screen.

■ When changing the menu settings

Even if the menu settings are changed temporarily with [C1]SET1, [C2]SET2] or [C3]SET3 selected, what has been registered will remain unchanged. To change what has been registered, overwrite the registered data using [CUST. SET MEM.] (P55) on the setup menu.



- You cannot register the settings of the following menu items as a custom mode. If they are changed, other recording modes will also be affected.
 - [BABY1]/[BABY2] or [PET] birthday and name settings in scene mode
 - [TRAVEL DATE], [ZOOM RESUME], [SCENE MENU], and [DIAL DISPLAY] in the [SETUP] menu
- At the time of purchase, the initial settings for the program AE mode [P] are registered in [C1]SET1, [C2]SET2] or [C3]SET3].

Taking expressive portraits and landscape pictures (Advanced scene mode)



In this mode, you can take quality pictures of such subjects as people, sporting events and activities, scenery, and people in night scenes in accordance with the surrounding conditions.

1 Press ▲/▼ to select the advanced scene mode.

(Screen when selecting [P])

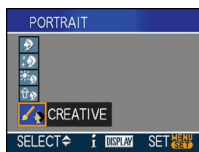

2 Press [MENU/SET] to set.

- You can also press the center of the joystick to set.
- The menu screen is switched to the recording screen in the selected advanced scene mode.
- Press [MENU/SET] and then perform steps 1 and 2 to change the advanced scene mode.

■ About the information I

- If you press [DISPLAY] when selecting an advanced scene mode in step 1, explanations about each advanced scene mode are displayed. (If you press [DISPLAY] again, the screen returns to the screen shown in step 1.)

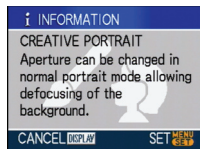

[PORTRAIT]

The person stands out from the background and has a healthier complexion.

[NORMAL PORTRAIT]

Shades the background and photographs skin color beautifully.

[SOFT SKIN]

Makes the skin surface appear especially smooth.

[OUTDOOR PORTRAIT]

Prevents faces from appearing dark when shooting outside.

[INDOOR PORTRAIT]

Sets the ISO sensitivity setting to the appropriate setting to prevent blurring of photo subject for indoor photography.

[CREATIVE PORTRAIT]

You can change the amount of background blurring by changing the aperture value (P50).

■ Technique for Portrait mode

To increase the effectiveness of this mode:

- 1 Rotate the zoom lever as far as possible to Tele.
- 2 Move close to the subject to make this mode more effective.



- In [INDOOR PORTRAIT], the [INTELLIGENT ISO] operates, and the maximum ISO sensitivity level becomes [ISO400]. In other modes, the ISO sensitivity is fixed to [ISO100].
- In [NORMAL PORTRAIT], [SOFT SKIN], and [CREATIVE PORTRAIT], you can set the white balance.
- When [SOFT SKIN] is selected, if a part of the background etc. is a color close to skin color, this part is also smoothed.
- When [SOFT SKIN] is selected, this mode may not be effective when there is insufficient brightness.
- The initial setting for [AF MODE] is [AF-ON].

[SCENERY]

This allows you to take pictures of a wide landscape.

[NORMAL SCENERY]

The focus adjusts onto far away subjects as a priority.

[NATURE]

The best setting for shooting natural scenery.

[ARCHITECTURE]

This setting takes sharp photographs of architecture. The guide lines are displayed. (P38)

[CREATIVE SCENERY]

The shutter speed (P50) can be changed in the [NORMAL SCENERY] setting.



- The focus range is 5 m (16.4 feet) to ∞.
- The flash setting is fixed to Forced OFF [OFF].
- The setting on the AF assist lamp is disabled.
- The white balance cannot be set.

[SPORTS]

Set here when you want to take pictures of sports scenes or other fast-moving events.

[NORMAL SPORTS]

Controls the ISO sensitivity while stopping movement with a high shutter speed.

[OUTDOOR SPORTS]

Fast shutter speed for stopping movement when taking photographs outdoors in good weather.

[INDOOR SPORTS]

Increases the ISO sensitivity and increases the shutter speed to prevent blurring for indoor photography.

[CREATIVE SPORTS]

The shutter speed (P50) can be changed in the [NORMAL SPORTS] setting.



- This mode is suitable for taking pictures of subjects at distances of 5 m (16.4 feet) or more.
- [INTELLIGENT ISO] operates for all settings except for [CREATIVE SPORTS].
- You can set the white balance when [NORMAL SPORTS] or [CREATIVE SPORTS] is selected.
- Digital zoom cannot be used except for [CREATIVE SPORTS].

[NIGHT PORTRAIT]

This allows you to take pictures of a person and the background with near real-life brightness.

[NIGHT PORTRAIT]

Uses when taking photographs of people with night scenery as a background.

[NIGHT SCENERY]

Night scenery is vividly photographed with the maximum 8 second slow shutter.

[ILLUMINATIONS]

Illuminations are photographed beautifully.

**[CREATIVE NIGHT SCENERY]**

The aperture value (P50) can be changed in the [NIGHT SCENERY] setting.

■ Technique for Night portrait mode

- **Open the flash when [NIGHT PORTRAIT] is selected.**
- Since the shutter speed becomes slower, we recommend using a tripod and the self-timer for taking pictures.
- When [NIGHT PORTRAIT] is selected, keep the subject still for about 1 second after taking the picture.
- When [NIGHT PORTRAIT] is selected, we recommend rotating the zoom lever to Wide (1×) and being about 1.5 m (4.92 feet) from the subject when taking a picture.



- The range in which the focus is adjusted is shown below.
 - [NIGHT PORTRAIT]: 1.2 m (3.94 feet) to 5 m (16.4 feet)
 - [NIGHT SCENERY]/[CREATIVE NIGHT SCENERY]/[ILLUMINATIONS]: 5 m (16.4 feet) to ∞
 (For information on the available flash range, see P42.)
- The shutter may remain closed (max. about 8 sec.) after taking the picture because of signal processing. This is not a malfunction.
- Noise may become visible when you take pictures in dark places.
- The flash cannot be set for settings except for [NIGHT PORTRAIT].
- When [NIGHT PORTRAIT] is selected, the flash settings become Slow sync./ Red-eye reduction [], and the flash is activated every time.
- When [NIGHT SCENERY] or [CREATIVE NIGHT SCENERY] is selected, [SENSITIVITY] is fixed to [ISO100].
- The continuous AF setting is disabled.
- The white balance cannot be set.
- When [NIGHT PORTRAIT] is selected, the initial setting for [AF MODE] is [].

Taking pictures that match the scene being recorded (Scene mode)



When you select a scene mode to match the subject and recording situation, the camera sets the optimal exposure and hue to obtain the desired picture.

- Refer to P60 to 65 and “About the information ” for details about each scene mode.

1 Press /// to select the scene mode.

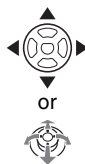





2 Press [MENU/SET] to set.

- You can also press the center of the joystick to set.
- The menu screen is switched to the recording screen in the selected scene mode.
- Press [MENU/SET], press , and perform steps 1 and 2 to change the scene mode.

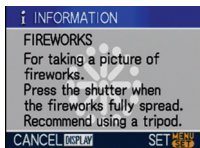
■ About the information

- If you press [DISPLAY] when selecting a scene mode in step 1, explanations about each scene mode are displayed. (If you press [DISPLAY] again, the screen returns to the [SCENE MODE] menu.)



- The flash setting is memorized even if the camera is turned off. However, the scene mode flash setting is reset to the initial setting when the scene mode is changed.
- When you take a picture with a scene mode that is not adequate for the purpose, the hue of the picture may differ from the actual scene.
- When [MENU/SET] is pressed and the menu screen is displayed, [SCN] is selected in the [SCENE MODE] menu. You can set each of the settings by pressing  and selecting [REC] mode menu  or [SETUP] menu .
- The following items cannot be set in scene mode because the camera automatically adjusts them to the optimal setting.
 - [INTELLIGENT ISO]
 - [SENSITIVITY]
 - [METERING MODE]
 - [COL.EFFECT]
 - [PICT.ADJ.]

[FOOD]

Press [] to display the [SCENE MODE] menu and select a scene mode. (P59)
This mode allows you to take pictures of food with a natural hue without being affected by the ambient light in restaurants etc.



- The focus range is 5 cm (0.16 feet) (Wide)/2 m (6.56 feet) (Tele) to ∞.

60

VQT1F83

- The white balance cannot be set.





[PARTY]

Press [] to display the [SCENE MODE] menu and select a scene mode. (P59)
Select this when you want to take pictures at a wedding reception, an indoor party etc. This allows you to take pictures of people and the background with near real-life brightness.

■ Technique for Party mode

- **Open the flash.**
- We recommend using a tripod and the self-timer for taking pictures.
- We recommend rotating the zoom lever to Wide (1×) and being about 1.5 m (4.92 feet) from the subject when taking pictures.



- The flash setting can be set to Slow sync./ Red-eye reduction [ ] or Forced ON/ Red-eye reduction [ ].
- The white balance cannot be set.
- The initial setting for [AF MODE] is [].





[CANDLE LIGHT]

Press [] to display the [SCENE MODE] menu and select a scene mode. (P59)
This mode allows you to take pictures with a candle-lit atmosphere.

■ Technique for Candle light mode

- If you make the most of the candle light, you can take successful pictures without using the flash.
- We recommend using a tripod and the self-timer for taking pictures.



- The focus range is 5 cm (0.16 feet) (Wide)/2 m (6.56 feet) (Tele) to ∞.
- The flash setting can be set to Slow sync./ Red-eye reduction [ ] or Forced ON/ Red-eye reduction [ ].
- The white balance cannot be set.
- The initial setting for [AF MODE] is [].

 [SUNSET]

Press [MENU] to display the [SCENE MODE] menu and select a scene mode. (P59)
Select this when you want to take pictures of a sunset. This allows you to take vivid pictures of the red color of the sun.



- The flash setting is fixed to Forced OFF [OFF].
- The setting on the AF assist lamp is disabled.
- The white balance cannot be set.

 [HIGH SENS.]

Press [MENU] to display the [SCENE MODE] menu and select a scene mode. (P59)
Select this for high-sensitivity processing. The sensitivity automatically switches to between [ISO1600] and [ISO6400].

Picture size and aspect ratio

Press ▲/▼ to select the picture size and aspect ratio and then press [MENU/SET] to set.

- The picture size becomes 3M (4:3), 2.5M (3:2) or 2M (16:9).

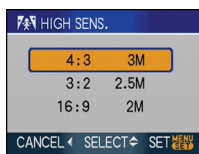

- [QUALITY] is automatically fixed to [].
- The resolution of the recorded picture decreases because of high sensitivity processing. This is not a malfunction.
- The focus range is 5 cm (0.16 feet) (Wide)/2 m (6.56 feet) (Tele) to ∞.
- You can take pictures suitable for 4"×6"/10×15 cm printing.
- You can set the flash to AUTO [A] or Forced ON [ON].
- When the flash is used, it becomes relatively easier for "orbs" (the

phenomenon caused by the light reflecting on dust in the air) to appear.

- The extended optical zoom and digital zoom cannot be used.



[BABY1]/[BABY2]

Press [MENU] to display the [SCENE MODE] menu and select a scene mode. (P59)
This takes pictures of a baby with a healthy complexion. When you use the flash, the light from it is weaker than usual. It is possible to set different birthdays and names for [BABY1] and [BABY2]. You can select to have these appear at the time of playback, or have them stamped on the recorded image using [TEXT STAMP] (P101).

- The age of the baby can be printed out using the [LUMIX Simple Viewer] or [PHOTOfunSTUDIO-viewer-] software on the CD-ROM (supplied). To print out the baby's name, use [PHOTOfunSTUDIO-viewer-]. [For details on printing, refer to the operating instructions (PDF file) of the software.]

Birthday/Name setting

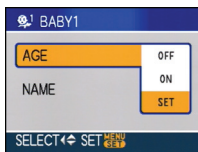

- 1 Press ▲/▼ to select [AGE] or [NAME] and then press ►.
- 2 Press ▲/▼ to select [SET] and then press [MENU/SET].
- 3 Enter the birthday or name.
 - Birthday:
 - ◀/▶: Select the items (year/month/day).
 - ▲/▼: Setting. [MENU/SET]: Exit.
 - Name:
 - For details on how to enter characters, read the [TITLE EDIT] section on P99.

- When the birthday or name is set, [AGE] or [NAME] is automatically set to [ON].

■ Display the age/name

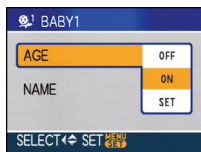

- 1 Press ▲/▼ to select [AGE] or [NAME] and then press ►.
- 2 Press ▲/▼ to select [ON] and then press [MENU/SET].
 - If [ON] is selected when the birthday or name has not been registered, the setting screen appears automatically.
 - **If [AGE] or [NAME] is set to [OFF] even when the birthday or name has been set, the age or name will not be displayed. Before taking pictures, set [AGE] or [NAME] to [ON].**



- The focus range is 5 cm (0.16 feet) (Wide)/2 m (6.56 feet) (Tele) to ∞.
- [INTELLIGENT ISO] is activated, and maximum ISO sensitivity level becomes [ISO400], in [BABY1]/[BABY2].
- If the camera is turned on with [BABY1]/[BABY2] set, the age and name are displayed on screen for about 5 seconds, along with the current date and time.
- The age display style differs depending on the language setting in the recording mode.
- If the age is not properly displayed, check the clock and birthday settings.
- If the quality is set to [RAW] or [RAW+JPEG] and pictures are taken, the name is not registered on the pictures.
- The birthday setting and name setting can be reset with [RESET].
- Digital zoom cannot be used.
- The initial setting for [AF MODE] is [AF-ON].

[PET]

Press [MENU] to display the [SCENE MODE] menu and select a scene mode. (P59)
Select this when you want to take pictures of a pet such as a dog or a cat.
You can set your pet's birthday and name. You can select to have these appear at the time of playback, or have them stamped on the recorded image using [TEXT STAMP] (P101).

- The age of the pet can be printed out using the [LUMIX Simple Viewer] or [PHOTOfunSTUDIO-viewer-] software on the CD-ROM (supplied). To print out the pet's name, use [PHOTOfunSTUDIO-viewer-]. [For details on printing, refer to the operating instructions (PDF file) of the software.] For information about [AGE] or [NAME], refer to [BABY1]/[BABY2] on P61.



- The initial setting for the AF assist lamp is [OFF]. (P82)
- Years prior to 2000 cannot be selected for the [AGE] setting.
- [INTELLIGENT ISO] is activated, and maximum ISO sensitivity level becomes [ISO800], in [PET].
- The initial setting for the AF mode is [AF-ON].
- Refer to [BABY1]/[BABY2] for other information about this mode.

[PANNING]

Press [MENU] to display the [SCENE MODE] menu and select a scene mode. (P59)
When you move the camera to follow a subject moving in one direction such as a runner or car, the background becomes a blur and the subject stays focused. This effect is called "panning". This mode allows you to obtain this effect easier.

■ Technique for Panning mode

To obtain good pictures in panning mode, move the camera in a horizontal plane as you take the pictures.

- We recommend that you do not follow the subject with the camera alone, but stand facing the subject with shoulders squared, and follow it using your entire body, while twisting at the waist.
- Once the subject is in front of you, press the shutter button. Do not stop moving the camera even after you press the shutter button.

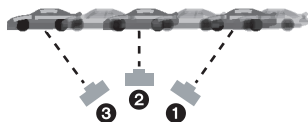

- 1 Move the camera smoothly while following the subject in the viewfinder.
 - 2 Press the shutter button while you are moving the camera.
 - 3 Move the camera continuously.
- We recommend the following:
 - Using the Viewfinder.
 - Selecting a subject with quick motion.
 - Using prefocus.
 - Use this mode with burst mode. (You can then select the best pictures from all the pictures taken.)

■ Setting the shutter speed

- 1 Press $\blacktriangle/\blacktriangledown$ to select [SHUTTER-PRIORITY] and press [MENU/SET].

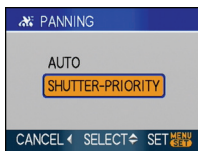

- It is also possible to select this using the quick setting (P71).
- If you select [AUTO], it will not be possible to select the shutter speed.

- 2 Set the shutter speed using $\blacktriangle/\blacktriangledown$ on the joystick.



- The shutter speed in panning mode becomes slower to achieve the panning effect. As a result, jitter can easily occur.
- The panning function does not work well in the following situations.
 - During very bright days in summer. We recommend using an ND filter (DMW-LND46; optional). (P118)
 - When the shutter speed is faster than 1/100th.
 - When you move the camera too slowly because the subject is moving slowly. (The background will not become a blur.)
 - When the camera cannot follow the subject well
- You cannot set the stabilizer function mode to [MODE2]. When you set it to [MODE1], only vertical jitters can be compensated in panning mode.
- The settings on the continuous AF and the AF assist lamp are disabled.
- The white balance cannot be set.

[STARRY SKY]

Press [MENU/SET] to display the [SCENE MODE] menu and select a scene mode. (P59)
This allows you to take vivid pictures of a starry sky or a dark subject.

■ Setting the shutter speed

Select a shutter speed of [15 SEC.], [30 SEC.] or [60 SEC.].

- Press ▲/▼ to select the number of seconds and then press [MENU/SET].

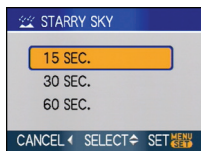

- It is also possible to change the number of seconds using the quick setting (P71).

- Take pictures.

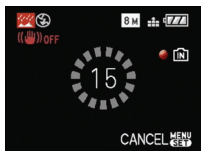

- Press the shutter button fully to display the countdown screen. Do not move the camera after this screen is displayed. When countdown finishes, [PLEASE WAIT...] is displayed for the same length of time as the set shutter speed for signal processing.
- Press [MENU/SET] to stop taking the picture while the countdown screen is displayed.

■ Technique for Starry sky mode

- The shutter opens for 15, 30 or 60 seconds. Be sure to use a tripod. We also recommend taking pictures with the self-timer.
- We recommend using prefocus (P54) to focus in advance on a subject, such as a bright star or a distant light, that is easy to focus on.



- The LCD monitor automatically becomes darker.
- Histograms are always displayed in orange.
- The flash setting is fixed to Forced OFF [☹].
- The optical image stabilizer function is fixed to [OFF].

- The following functions cannot be used.
 - [EXPOSURE]
 - [AUTO BRACKET]
 - [BURST]
 - [W.BALANCE]
 - [AUDIO REC.]
 - [CONT.AF]

■ [FIREWORKS]

Press [MENU] to display the [SCENE MODE] menu and select a scene mode. (P59)
This mode allows you to take beautiful pictures of fireworks exploding in the night sky.

■ Technique for Fireworks mode

We recommend performing the following steps to prefocus on the point the pictures will be taken so that you do not miss taking pictures of the fireworks when they are fired.

- Aim the camera at an object, such as a distant light, that is about the same distance from the camera as the point where the fireworks will rise.
 - Press the shutter button halfway until the focus indication (P25) lights.
 - Press the [AF/MF] to select [MF]. (P52)
 - Aim the camera in the direction that the fireworks will be fired and wait.
 - Press the shutter button fully to take the picture when the fireworks are fired.
- If zoom was used, the focus position will not be correct. Perform steps 2 to 5 again.
 - We recommend using a tripod.



- The focus range is 5 m (16.4 feet) to ∞ in AF mode. (We recommend performing steps 1 to 5 for prefocus.)
- The shutter speed becomes the following.
 - When [OFF] is set on the optical image stabilizer function: Fixed to 2 seconds
 - When [MODE1] or [MODE2] is set on the optical image stabilizer function: 1/4th of a second or 2 seconds (The shutter speed becomes 2 seconds only when the camera has determined that

there is little jitter such as when using a tripod etc.)

- You can change the shutter speed by compensating the exposure.
- Histograms are always displayed in orange.
- The flash setting is fixed to Forced OFF [☹].
- The setting on the continuous AF and the AF assist lamp are disabled.
- The white balance cannot be set.

[BEACH]

Press [MENU] to display the [SCENE MODE] menu and select a scene mode. (P59)
This allows you to take even more vivid pictures of the blue color of the sea, sky etc. It also prevents under exposure of people under strong sunlight.



- Do not touch the camera with wet hands.
- Sand or seawater will cause the camera to malfunction. Make sure that sand or seawater does not get into the lens or the terminals.
- Problems caused by sand or seawater are not covered by the product warranty.
- The white balance cannot be set.
- The initial setting for [AF MODE] is [☹].

[SNOW]

Press [MENU] to display the [SCENE MODE] menu and select a scene mode. (P59)
This allows you to take pictures that show the snow as white as possible at a ski resort or a snow-covered mountain.



- The white balance cannot be set.

[AERIAL PHOTO]

Press [MENU] to display the [SCENE MODE] menu and select a scene mode. (P59)
This mode allows you to take pictures through an airplane window.

■ Technique for Aerial photo mode

- We recommend using this technique if it is difficult to focus when taking pictures of clouds etc. Aim the camera at something with high contrast, press the shutter button halfway to fix the focus and then aim the camera at the subject and press the shutter button fully to take the picture.



- The focus range is 5 m (16.4 feet) to ∞.
- **Turn the camera off when taking off or landing.**
- **When using the camera, follow all instructions from the cabin crew.**
- Be careful about the reflection from the window.
- The flash setting is fixed to Forced OFF [☹].
- The setting on the AF assist lamp is disabled.
- The white balance cannot be set.

Motion Picture Mode



- 1 Press the shutter button halfway to focus and then press it fully to start recording.

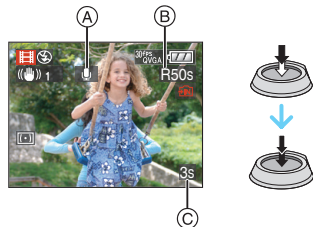

- Audio recording
- The available recording time **B** is displayed on the top right and the elapsed recording time **C** is displayed on the bottom right of the screen.
- When the subject is focused, the focus indication lights.

- The focus, zoom and aperture value are fixed to the setting when recording starts (the first frame).
- The audio is also recorded simultaneously from the built-in microphone on this unit. (Motion pictures cannot be recorded without audio.)
- When using the stabilizer function, it is fixed to [MODE1].

2 Press the shutter button fully to stop recording.

- If the built-in memory or the card becomes full in the middle of recording, the camera stops recording automatically.

■ Changing the settings for the aspect ratio and the picture quality

1 Press [MENU/SET].

2 Press ▲/▼ to select [ASPECT RATIO] and then press ►.

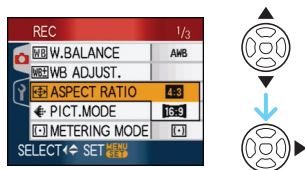

3 Press ▲/▼ to select the item and then press [MENU/SET].

4 Press ▲/▼ to select [PICT.MODE] and then press ►.

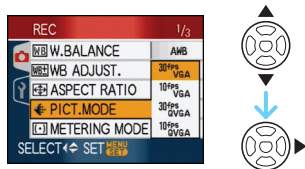

5 Press ▲/▼ to select the item and then press [MENU/SET].

If you selected [4:3] on the screen shown in step 2

Item	Picture size	fps
[30fpsVGA]	640×480 pixels	30
[10fpsVGA]		10
[30fpsQVGA]	320×240 pixels	30
[10fpsQVGA]		10

If you selected [16:9] on the screen shown in step 2

Item	Picture size	fps
[30fps16:9]	848×480 pixels	30
[10fps16:9]		10

- fps “frames per second”; This refers to the number of frames used in 1 second.
- You can record smoother motion pictures with “30 fps”.
- You can record longer motion pictures with “10 fps” although the picture quality is lower.
- The file size with [10fpsQVGA] is small so it is suitable for e-mails.
- **You can only record motion pictures to the built-in memory when the [ASPECT RATIO] is [4:3] and the picture size is [30fpsQVGA] or [10fpsQVGA] (320×240 pixels).**

6 Press [MENU/SET] to close the menu.

- You can also press the shutter button halfway to close the menu.



- Refer to P132 for information about the available recording time.
- The available recording time displayed on the LCD monitor/Viewfinder may not decrease regularly.
- This unit does not support recording motion pictures on MultiMediaCards.
- When you set the picture quality to [30fpsVGA] or [30fps16:9], we recommend using a high speed SD Memory Card with “10MB/s” or greater displayed on the package.
- Depending on the type of the card, recording may stop in the middle.

- **We recommend using Panasonic's SD Memory Cards/SDHC Memory Cards.**
- Depending on the type of the card, the card access indication may appear for a while after recording motion pictures. This is not a malfunction.
- Motion pictures can be recorded continuously up to 2 GB.
The maximum available recording time for up to 2 GB only is displayed on the screen.
- When motion pictures recorded with the camera are played back on other equipment, the quality of the picture and sound may deteriorate and it may not be possible to play them back. Also the recording information may not be displayed correctly.
- In motion picture mode [**M**], the following functions cannot be used.
 - [**AF**] in the AF mode
 - Direction detection function
 - Review function
 - [MODE2] on the optical image stabilizer function
- The bundled software includes QuickTime to play back motion picture files recorded with the camera on the PC.

Recording which Day of the Vacation You Take the Picture



If you set the departure date of the vacation in advance, the number of days that have passed since the departure date (which day of the vacation it is) is recorded when you take the picture. You can display the number of days that have passed when playing back the pictures and stamp it on the recorded pictures with [TEXT STAMP] (P101).

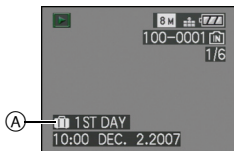

- Ⓐ The number of days that have passed since the departure date
- The number of days that have passed since the departure date can be printed on each picture by using the software [LUMIX Simple Viewer] or [PHOTOfunSTUDIO-viewer-] in the CD-ROM (supplied). [For printing the pictures, refer to the operating instructions (PDF file) of the software.]

■ **Setting the departure/return date**
(e.g.: The following are examples of the screen in program AE mode [**P**].)

1 Press [MENU/SET] and then press **◀.**

2 Press **▼ to select the [SETUP] menu icon [**⌵**] and then press **▶**.**

3 Press **▲/▼ to select [TRAVEL DATE] and then press **▶**.**

4 Press **▼ to select [SET] and then press [MENU/SET].**

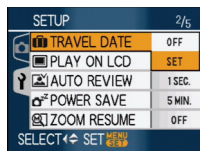

5 Press ▲/▼/◀/▶ to set the departure date and then press [MENU/SET].



- ◀/▶: Select the desired item.
- ▲/▼: Set the year, month and date.

6 Press ▲/▼/◀/▶ to set the return date and then press [MENU/SET].



- ◀/▶: Select the desired item.
- ▲/▼: Set the year, month and date.
 - The travel date is automatically canceled if the current date is after the return date.
 - If you do not want to set the return date, press [MENU/SET] while the date bar is displayed.

7 Press [MENU/SET] to close the menu.

8 Take a picture.



- (A) The number of days that have passed since the departure date
 - The number of days that have passed since the departure date is displayed for

about 5 seconds if this unit is turned on etc. after setting the travel date or when the travel date is set.

- When the travel date is set, [] appears on the lower right of the screen. (It is not displayed if the current date is after the return date.)

■ Canceling the travel date

The travel date is automatically canceled if the current date is after the return date. If you want to cancel the travel date before the end of the vacation, select [OFF] on the screen shown in step 4 and then press [MENU/SET] twice.



- The travel date is calculated using the date in the clock setting and the departure date you set. If you set [WORLD TIME] (P69) to the travel destination, the travel date is calculated using the date in the clock setting and the travel destination setting.
- The travel date setting is memorized even if the camera is turned off.
- If you set a departure date and then take a picture on a date before this departure date, [-] (minus) is displayed in orange and the day of the vacation that you took the picture is not recorded.
- If you set a departure date and then change the clock setting to the date and time at the travel destination, [-] (minus) is displayed in white and the day of the vacation that you took the picture is recorded when the travel destination date is, for example, one day before the departure date.
- If [TRAVEL DATE] is set to [OFF], the number of days that have passed since the departure date will not be recorded even if you set the travel date or the return date. Even if [TRAVEL DATE] is set to [SET] after taking the pictures, which day of the vacation you took them is not displayed.
- Set the clock if the message [PLEASE SET THE CLOCK] appears.

Displaying the Time at the Travel Destination (World Time)



If you set your home area and the travel destination area when traveling abroad etc., the local time at the travel destination area can be displayed on the screen and recorded on the pictures taken.

- Select [CLOCK SET] to set the current date and time in advance. (P17)

1 Press [MENU/SET] and then press ◀.

2 Press ▼ to select the [SETUP] menu icon [⌂] and then press ▶.

3 Press ▲/▼ to select [WORLD TIME] and then press ▶.



- If you are setting the world time for the first time, the message [PLEASE SET THE HOME AREA] appears. If this message appears, press [MENU/SET] and then set home area from the screen shown in step 2 in "Setting the home area [HOME]".

■ Setting the home area [HOME]

(Perform steps 1, 2 and 3.)

- 1** Press ▼ to select [HOME] and then press [MENU/SET] to set.

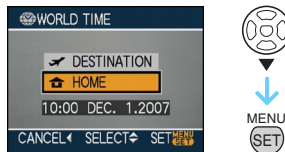

- 2** Press ◀/▶ to select your home area and then press [MENU/SET] to set.



- The current time is displayed on the top left of the screen and the time difference from GMT "Greenwich Mean Time" is displayed on the bottom left of the screen.
- If daylight saving time [☀] is used at the home area, press ▲. Press ▲ again to return to the original time.
- The daylight saving time setting for the home area does not advance the current time. Advance the clock setting by one hour.

■ Finishing setting the home area

- If you are setting the home area for the first time, the screen returns to the screen shown in step 1 of "Setting the home area [HOME]" after you press [MENU/SET] to set your home area. Press ◀ to return to the screen shown in step 3 and then press [MENU/SET] to close the menu.
- If you are setting the home area for the second time etc., the screen returns to the screen shown in step 3 after you press [MENU/SET] to set your home area. Press [MENU/SET] again to close the menu.

■ Setting the travel destination area

(Perform steps **1**, **2** and **3**.)

- 1** Press **▲** to select [DESTINATION] and then press [MENU/SET] to set.



- A** Depending on the setting, the time at the travel destination area or the home area is displayed.
- If you are setting the travel destination area for the first time, the date and time are displayed as shown in the screen above.
- 2** Press **◀/▶** to select the area the travel destination is in and then press [MENU/SET] to set.

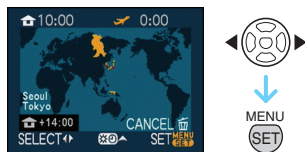

- The current time at the selected travel destination area is displayed on the top right of the screen and the time difference from the home area is displayed at the bottom left of the screen.
 - If daylight saving time [**☼**] is used at the travel destination, press **▲**. (The time advances by one hour.) Press **▲** again to return to the original time.
- 3** Press [MENU/SET] to close the menu.



- The icon changes from [**🏠**] to [**✈️**] after setting the travel destination.



- Return the setting to [HOME] when the vacation is finished by performing steps **1**, **2**, **3** and then steps **1** and **2** of "Setting the home area [HOME]". (P69)
- If you cannot find the travel destination in the areas displayed on the screen, set by the time difference from the home area.
- The travel destination icon [**✈️**] appears when playing back pictures taken at the travel destination.

Using the [REC] Mode Menu



Increase the variety of pictures you can take by setting color effect, picture adjustment etc. The menu items that can be set differ depending on the recording mode.

■ Setting from the menu screen

Press [MENU/SET] to display the [REC] mode menu and then select the item to set. (P19)

Items that can be set

(Recording in program AE mode [P])

Menu screen	Item
1/4	[WB] : [W.BALANCE] (P72)
	[WB±] : [WB ADJUST.] (P73)
	[ISO] : [INTELLIGENT ISO] (P74)
	[ISO] : [SENSITIVITY] (P75)
	[AR] : [ASPECT RATIO] (P75)
2/4	[PICT.SIZE] : [PICT.SIZE] (P76)
	[QUALITY] : [QUALITY] (P76)
	[AUDIO REC.] : [AUDIO REC.] (P77)
	[METERING MODE] : [METERING MODE] (P78)
	[AF MODE] : [AF MODE] (P78)
3/4	[STABILIZER] : [STABILIZER] (P81)
	[CONT.AF] : [CONT.AF] (P82)
	[AF ASSIST LAMP] : [AF ASSIST LAMP] (P82)
	[AF/AE LOCK] : [AF/AE LOCK] (P83)
	[D.ZOOM] : [D.ZOOM] (P31)

4/4	[COL.EFFECT] : [COL.EFFECT] (P83)
	[PICT.ADJ.] : [PICT.ADJ.] (P84)
	[FLIP ANIM.] : [FLIP ANIM.] (P84)
	[CONVERSION] : [CONVERSION] (P86)
	[CLOCK SET] : [CLOCK SET] (P17)

■ Using the quick setting

- You can use the joystick to easily set the following items when recording.
(Recording in program AE mode [P])
 - [STABILIZER]
 - [AF MODE]
 - [METERING MODE]
 - [W.BALANCE]
 - [SENSITIVITY]
 - [PICT.SIZE]
 - [QUALITY]

1 Keep pressing the joystick when recording.



2 Tilt the joystick towards ▲/▼/◀/▶ to select the menu item and the setting and then press the center of the joystick to finish.

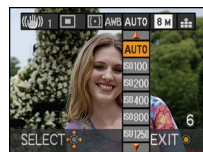

- The [] (White Set) setting does not appear when the quick setting.

[W.BALANCE]

Adjusting the hue for a more natural picture



Press [MENU] to display the [REC] mode menu and select the item to set. (P71)
This function allows you to reproduce a white color close to real life in pictures recorded under sunlight, halogen lighting etc. in which the white color may appear reddish or bluish. Select a setting that matches the recording conditions.

[AWB] (Auto white balance)	for auto setting
 (Daylight)	for recording outdoors on a bright day
 (Cloudy)	for recording outdoors on a cloudy day
 (Shade)	for recording outdoors in the shade on a bright day
 (Flash)*	for recording with the flash only
 (Halogen)	for recording under halogen lighting
 (White set 1)	for using the preset white balance
 (White set 2)	
 (White set)	for setting the white balance again

* Cannot be selected when the motion picture mode [H] is set.

The optimal white balance will differ depending on the type of halogen lighting being recorded under so use [AWB] or [WHITE SET].

■ Auto white balance

The available white balance range is shown in the following illustration. When you take a picture beyond the available white balance range, the picture may appear

reddish or bluish. Even within the confines of the range, the auto white balance may not operate properly if there are many light sources or there is no color close to white. In these cases, set the white balance to a mode other than [AWB].

- 1 Auto white balance will work within this range.
- 2 Blue sky
- 3 Cloudy sky (Rain)
- 4 Shade
- 5 TV screen
- 6 Sunlight
- 7 White fluorescent light
- 8 Incandescent light bulb
- 9 Sunrise and sunset
- 10 Candlelight

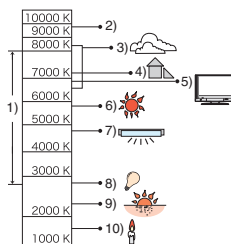

K=Kelvin Color Temperature

■ Setting the white balance manually

- 1 Select [WHITE SET] and then press [MENU/SET].
- 2 Select [WHITE SET 1] or [WHITE SET 2] and then press [MENU/SET].



- You can also use the joystick to select or set.

- 3 Aim the camera at a sheet of white paper etc. so that the frame in the center is filled by the white object only and then press [MENU/SET] or press the center of the joystick.



- 4 Press [MENU/SET] twice to close the menu.
- You can also press the shutter button halfway or press the center of the joystick to finish.



- When you take a picture with the flash, the white balance may not be properly adjusted if the flash level is insufficient for the subject.
- The white balance setting is memorised even if the camera is turned off. However, the white balance setting for the advanced scene mode or the scene mode returns to [AWB] when the advanced scene mode or the scene mode is changed.
- The white balance cannot be set in the following cases.
 - In [OUTDOOR PORTRAIT] and [INDOOR PORTRAIT] in [PORTRAIT] mode
 - In [SCENERY] mode
 - In [OUTDOOR SPORTS] and [INDOOR SPORTS] in [SPORTS] mode
 - In [NIGHT PORTRAIT] mode
 - In [FOOD], [PARTY], [CANDLE LIGHT], [SUNSET], [PANNING], [STARRY SKY], [FIREWORKS], [BEACH], [SNOW] and [AERIAL PHOTO] in scene mode

[WB ADJUST.] Finely adjusting the white balance



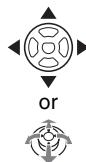
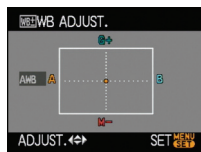

Press [MENU] to display the [REC] mode menu and select the item to set. (P71)
You can adjust the white balance finely when you cannot acquire the desired hue by setting the white balance.

1 Press ▲/▼/◀/▶ to finely adjust the white balance.



- ◀: A (AMBER: ORANGE)
- ▶: B (BLUE: BLUISH)
- ▲: G+ (GREEN: GREENISH)
- ▼: M- (MAGENTA: REDDISH)

2 Press [MENU/SET] to finish.

- You can also press the center of the joystick to finish.
- If you finely adjust the white balance to A (amber), the white balance icon on the LCD monitor/Viewfinder will change to orange. If you finely adjust the white balance to B (blue), the white balance icon on the LCD monitor/Viewfinder will change to blue.
- If you finely adjust the white balance to G+ (green) or M- (magenta), [+] (e.g.: ) or [-] (e.g.: ) appears beside the white balance icon on the LCD monitor/Viewfinder.
- Select the center point if you are not finely adjusting the white balance.



- You can finely adjust the white balance independently for each white balance item.
- The white balance fine adjustment setting is reflected in the picture when using the flash.
- You cannot finely adjust the white balance when [COL.EFFECT] (P83) is set to [B/W], [SEPIA], [COOL] or [WARM].
- The white balance fine adjustment setting is memorized even if the camera is turned off.
- The fine adjustment levels in [] or [] return to the standard setting (center point) if you reset the white balance in [SET].
- You cannot finely adjust the white balance in the following cases.
 - In [OUTDOOR PORTRAIT] and [INDOOR PORTRAIT] in [PORTRAIT] mode
 - In [SCENERY] mode
 - In [OUTDOOR SPORTS] and [INDOOR SPORTS] in [SPORTS] mode
 - In [NIGHT PORTRAIT] mode
 - In [FOOD], [PARTY], [CANDLE LIGHT], [SUNSET], [PANNING], [STARRY SKY], [FIREWORKS], [BEACH], [SNOW] and [AERIAL PHOTO] in scene mode

[INTELLIGENT ISO]

ISO Automatically setting the optimal ISO sensitivity and shutter speed



- Press [MENU/SET] to display the [REC] mode menu and select the item to set. (P71)
The camera will automatically set the optimal ISO sensitivity and the shutter speed to the movement of the subject and the surrounding brightness.
- One of the following maximum ISO sensitivity levels can be selected. The higher the value set for the ISO sensitivity, the more the jitter is reduced but the greater the amount of picture noise.

Item	Settings
OFF	Intelligent ISO does not work.
ISO MAX 400	The ISO sensitivity automatically increases up to the set value according to the movement and brightness of the subject.
ISO MAX 800	
ISO MAX 1600	

- Jitter is avoided when taking pictures indoors of a moving subject by increasing the ISO sensitivity and making the shutter speed faster.



1/125 ISO800

- Noise is avoided when taking pictures indoors of a subject with no movement by decreasing the ISO sensitivity.



1/30 ISO200

- When you press the shutter button halfway, [ISO] (A) appears. When you press the shutter button fully, the shutter speed and the ISO sensitivity appear for a while.



- When the flash is activated, the ISO sensitivity is automatically increased to maximum ISO sensitivity level.
- Depending on the brightness and how fast the subject is moving, jitter may not be avoided.

- The camera may not be able to detect the movement of the subject in the following cases.
 - When the moving subject is small
 - When the moving subject is at the edge of the screen
 - When the subject starts moving the instant the shutter button is pressed fully
- If picture noise becomes a problem, we recommend that you take pictures after lowering the maximum ISO sensitivity level, increasing the setting for [NOISE REDUCTION] under [PICT.ADJ.], or lowering the setting for each of the items other than [NOISE REDUCTION]. (P84)
- The digital zoom cannot be used.

ISO

[SENSITIVITY]

Setting the light sensitivity

P A S M C

Press [MENU] to display the [REC] mode menu and select the item to set. (P71)
ISO is a measure of sensitivity to light. The higher the sensitivity is set, the less light is needed to take a picture so the camera becomes more suitable for recording in dark places.

- When setting to [AUTO], the ISO sensitivity is automatically adjusted from [ISO100] to [ISO200] according to the brightness. (It can be adjusted from [ISO100] to [ISO400] when using the flash.)

ISO sensitivity	100 ← → 1600	
Use in bright places (e.g. outdoors)	Suitable	Not suitable
Use in dark places	Not suitable	Suitable
Shutter speed	Slow	Fast
Noise	Less	Increased



- The ISO sensitivity cannot be set to [AUTO] in Manual exposure.
- The sensitivity automatically switches to between [ISO1600] and [ISO6400] in [HIGH SENS.] in scene mode.
- If picture noise becomes a problem, we recommend that you take pictures after lowering the maximum ISO sensitivity level, increasing the setting for [NOISE REDUCTION] under [PICT.ADJ.], or lowering the setting for each of the items other than [NOISE REDUCTION]. (P84)
- The setting is not available when [INTELLIGENT ISO] is being used. ([ISO] is displayed)
- For information on the shutter speed, refer to P52.



**[ASPECT RATIO]**

Setting the aspect ratio of pictures



Press [MENU] to display the [REC] mode menu and select the item to set. (P71)
By changing the aspect ratio, you can select an angle of view that matches the subject.

4:3	Select to take pictures with the same aspect ratio as a 4:3 TV or a PC monitor.

3:2	<p>Select to take pictures with the same 3:2 aspect ratio as 35 mm film.</p> 
16:9	<p>This is suitable for landscapes etc. where a wide view is preferable. This is also suitable for playing back pictures on a wide-screen TV, high-definition TV etc.</p> 



- In motion picture mode [M], you cannot select [3:2].
- The ends of the recorded pictures may be cut at printing. (P128)

[PICT.SIZE]/[QUALITY]
Setting a picture size and quality that match your use of the pictures



Press [MENU] to display the [REC] mode menu and select the item to set. (P71)
A digital picture is made of numerous dots called pixels. Although you cannot see the difference on the camera's screen, the more pixels the finer the picture will be when it is printed on a large piece of paper or displayed on a PC monitor. Picture quality refers to the compression rate when saving digital pictures.

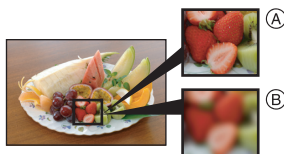

- (A) Many pixels (Fine)
(B) Few pixels (Rough)
* These pictures are examples to show the effect.

■ Number of pixels

You can print pictures more clearly when a large picture size [8M] (8M) is selected. When a smaller picture size [0.3M] (0.3M EZ) is selected, you can record more pictures and attach them to an e-mail or post them on a website because their file size is small.

■ When the aspect ratio is [4:3].

8M (8M)	3264×2448 pixels
5M (5M EZ)	2560×1920 pixels
3M (3M EZ)	2048×1536 pixels
2M (2M EZ)*	1600×1200 pixels
0.3M (0.3M EZ)	640×480 pixels

- * This item cannot be set in the intelligent auto mode [iA].

■ When the aspect ratio is [3:2].

7M (7M)	3264×2176 pixels
4.5M (4.5M EZ)	2560×1712 pixels
2.5M (2.5M EZ)	2048×1360 pixels

■ When the aspect ratio is [16:9].

6M (6M)	3264×1840 pixels
3.5M (3.5M EZ)	2560×1440 pixels
2M (2M EZ)	1920×1080 pixels

Quality

	Fine (Low compression): This gives priority to picture quality. Picture quality will be high.
	Standard (High compression): This gives priority to the number of recordable pictures. Standard quality pictures are recorded.
RAW	RAW file: Set to process images in high-resolution on a PC. The maximum picture size for each aspect ratio setting is fixed to (([8M])/([7M])/([6M])).
RAW+JPEG *	RAW+JPEG file: In addition to the [RAW] settings, a standard-equivalent JPEG image is simultaneously created.

- * If you delete a RAW file from the camera, the corresponding JPEG image will also be deleted.
- [RAW] images are recorded with a smaller data volume than [RAW+JPEG].
 - The following functions can be used for [RAW+JPEG].
 - [CATEGORY]
 - [FAVORITE]
 - [DPOF PRINT]
 - You can print pictures directly from the camera on a PictBridge compatible printer (P113).
 - You can enjoy more advanced picture editing if you use RAW files. You can save RAW files in a file format (JPEG, TIFF etc.) that can be displayed on your PC etc., develop them and edit them using the software “SILKYPIX Developer Studio” by Ichikawa Soft Laboratory on the CD-ROM (supplied).



- The number of pixels that can be selected differs depending on the aspect ratio. If you change the aspect ratio, set the picture size.
- “EZ” is an abbreviation of “Extended optical Zoom”.

- The extended optical zoom does not work in [HIGH SENS.] in scene mode so the picture size for [EZ] is not displayed.
- Pictures may appear mosaic depending on the subject and the recording conditions.
- Refer to P130 for information about the number of recordable pictures.
- If a RAW picture is recorded with the built-in memory, it will take time to write the picture data.
- **[QUALITY] settings cannot be set in intelligent auto mode ([IA]).**
- The quality cannot be set to [RAW] or [RAW+JPEG] in [HIGH SENS.] in scene mode.
- You cannot select the following functions when the quality is set to [RAW] or [RAW+JPEG].
 - [D.ZOOM]
 - Auto bracket
 - Burst mode
 - [AUDIO REC.]
 - [TITLE EDIT]
 - [TEXT STAMP]
 - [AUDIO DUB.]
 - [RESIZE]
 - [TRIMMING]
 - [ASPECT CONV.]

[AUDIO REC.] Recording still pictures with audio



Press [MENU] to display the [REC] mode menu and select the item to set. (P71)
You can record audio with the still picture if this is set to [ON]. This means you can record the conversation that took place when you were recording or an explanation of the picture.

- appears on the screen when you set [AUDIO REC.] to [ON].
- Focus on the subject and press the shutter button to start recording. Recording will automatically stop about 5 seconds later. There is no need to press and hold the shutter button.

- Audio is recorded from the built-in microphone on the camera.
- If you press [MENU/SET] during audio recording, the audio recording is canceled. The audio is not recorded.



- You cannot take pictures with audio in the following cases:
 - Auto bracket
 - Burst mode
 - When the quality is set to [RAW] or [RAW+JPEG]
 - [STARRY SKY] in scene mode
- You cannot use the following functions with pictures with audio.
 - [TEXT STAMP]
 - [RESIZE]
 - [TRIMMING]
 - [ASPECT CONV.]

[METERING MODE]



Deciding the method to measure brightness

PASMC

Press [MENU] to display the [REC] mode menu and select the item to set. (P71)
You can switch to the following metering modes.

[]	<p>Multiple: This is the method in which the camera measures the most suitable exposure by judging the allocation of brightness on the whole screen automatically. Usually, we recommend using this method.</p>
[]	<p>Center weighted: This is the method used to focus on the subject on the center of the screen and measure the whole screen evenly.</p>



Spot:
This is the method to measure the subject in the spot metering target (A).

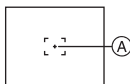

- Metering mode is fixed to multiple [] in intelligent auto mode [].
- When multiple [] is selected and the AF mode is set to [], the camera will adjust the exposure to suit the person's face.



[AF MODE]

Setting the focus method

PASMC

Press [MENU] to display the [REC] mode menu and select the item to set. (P71)
Select the mode that matches the recording conditions and the composition.



Face detection:

The camera automatically detects the person's face. The focus and exposure can then be adjusted to fit that face no matter what portion of the picture it is in.



Multi-area focusing:

The camera focuses on any of the selected areas. This is effective when the subject is not in the center of the screen.



3-area-focusing (High speed):

The camera quickly focuses on any of 3 focus areas points – left, right or center.

This is effective when the subject is not in the center of the screen.

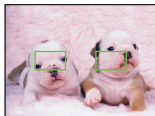

1-area-focusing (High speed):

The camera quickly focuses on the subject in the AF area on the center of the screen.

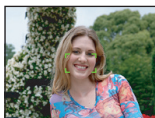

1-area-focusing:

The camera focuses on the subject in the AF area on the center of the screen.

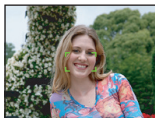

Spot-focusing:

The camera focuses on a limited narrow area in the screen.



■ About face detection

This function detects a person's face in the image area so that the focus can be adjusted properly. This is particularly effective in preventing errors such as when the focus is on the background when taking a commemorative photograph.

- When the camera detects a person's face, the following color AF area is displayed.

Yellow:

When the shutter button is pressed halfway, the frame turns green when the camera is focused.

White:

Displayed when more than one face is detected. Other faces that are the same distance away as faces within the yellow AF areas are also focused.

- Up to 15 AF areas are displayed.

- Under certain picture-taking conditions including the following cases, the facial detection function may fail to work, making it impossible to detect faces. [AF MODE] is switched to .
 - When the face is not facing the camera
 - When the face is at an angle
 - When the face is extremely bright or dark

- When there is little contrast on the faces
- When the facial features are hidden behind sunglasses, etc.
- When the face appears small on the screen
- When there is rapid movement
- When the subject is other than a human being
- When the camera is shaking
- When digital zoom is used









■ About or

- You can focus on the subject more quickly than other AF modes.
- The picture may stop moving for a moment before being brought into focus when you press the shutter button halfway. This is not a malfunction.



- The AF area displayed is bigger than usual when taking pictures in dark places or when using the digital zoom.



- The camera is focusing on all the AF areas when multiple AF areas (max. 5 areas) light at the same time. The focus position is not predetermined. It is set to a position automatically determined by the camera at the time of focusing. If you want to determine the focus position to take pictures, switch the AF mode to ,  or .
- If the AF mode is set to  or , the AF area is not displayed until the picture is brought into focus.
- Switch the AF mode to  or  if it is difficult to focus using .

- It is not possible to set [⦿] in the following cases.
 - In [NIGHT SCENERY], [ILLUMINATIONS] and [CREATIVE NIGHT SCENERY] in [NIGHT PORTRAIT] mode.
 - In [FOOD], [PANNING], [STARRY SKY], [FIREWORKS] and [AERIAL PHOTO] in scene mode.
 - In motion picture mode [H].
- The camera may detect the subjects other than a person as the face. In this case, switch the AF mode to any modes other than [⦿] and then take a picture.

■ About AF area selection

You can select the AF area when [H], [H], [H] or [⦿] is selected.

- 1 Set the focus to AF or AF macro.
- 2 Select AF area with ► on the joystick and then press the center of the joystick.



- 3 Move the AF area with the cursor buttons or ▲/▼/◀/▶ on the joystick.

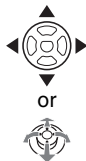

- 4 Press [MENU/SET] or press the center of the joystick to set.

When selecting [H], [H] or [⦿]

You can select 1 AF area from the 11 areas.

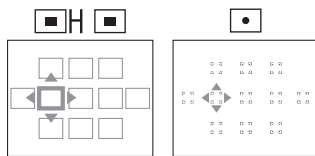

When selecting [H]

You can select AF areas as shown in the following illustration by tilting the joystick towards ▲/▼/◀/▶.

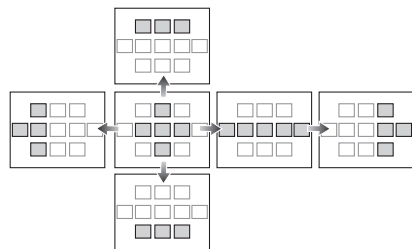

- The spot metering target can also be moved to match the AF area when using [⦿].
- The following operations will return the AF area to the previous position.
 - When the mode dial is set to intelligent auto mode [iA]
 - When the power save mode is activated
 - When this unit is turned off

[CONT.AF]

CAF *Continuously focusing on a subject*



Press **[MENU]** to display the [REC] mode menu and select the item to set. (P71)
This mode allows you to compose a picture more easily by always focusing on the subject.

The time required for focusing when the shutter button is pressed halfway will be reduced when the AF mode is set to **[AF]**, **[AF]** or **[AF]**.

- The **[CAF]** indication appears when it is set to [ON].



- The battery will be consumed faster than usual.
- It may take time to focus on the subject if you rotate the zoom lever from Wide to Tele or suddenly change the subject from a distant one to a nearby one.
- Press the shutter button halfway again when it is difficult to focus on the subject.
- The [CONT.AF] setting is fixed to [ON] in the intelligent auto mode **[iA]** and fixed to [OFF] when either [NIGHT PORTRAIT] mode, or [PANNING], [STARRY SKY] or [FIREWORKS] in scene mode, as well as during manual focusing.

[AF ASSIST LAMP]

AF* *Focusing in low light conditions becomes easier*



Press **[MENU]** to display the [REC] mode menu and select the item to set. (P71)
Illuminating the subject makes it easier for the camera to focus when recording in low light conditions that make focusing difficult.

- If the AF assist lamp is set to [ON], an AF area with a size wider than usual is displayed and the AF assist lamp **(A)** turns on when you press the shutter button halfway in dark places etc.

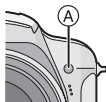

[ON]	The AF assist lamp turns on in low light conditions. At this time, the AF assist lamp icon [AF*] appears on the screen. The effective range of the AF assist lamp is 1.5 m (4.92 feet).
[OFF]	The AF assist lamp does not turn on.



- Be careful about the following when using the AF assist lamp.
 - Do not look at the AF assist lamp at close range.
 - Detach the lens hood.
 - Do not cover the AF assist lamp with your fingers or other objects.
- When you do not want to use the AF assist lamp (e.g. when taking pictures of animals in dark places), set the [AF ASSIST LAMP] to [OFF]. In this case, it will become more difficult to focus on the subject.
- The setting for [AF ASSIST LAMP] is fixed to [ON] in intelligent auto mode **[iA]**.
- A vignetting effect may appear on the circumference of the AF assist lamp because the AF assist lamp may be obscured by the lens, however, this does not cause a problem with the performance of the camera.
- The setting for the [AF ASSIST LAMP] is fixed to [OFF] in [SCENERY] mode, [NIGHT SCENERY], [ILLUMINATIONS] or [CREATIVE NIGHT SCENERY] in [NIGHT PORTRAIT] mode, and [SUNSET], [PANNING], [FIREWORKS] or [AERIAL PHOTO] in scene mode.
- The initial setting for [PET] in scene mode is [OFF].

[AF/AE LOCK] Fixing the focus and exposure



Press [MENU] to display the [REC] mode menu and select the item to set. (P71)
This is a technique for setting the focus and the exposure in advance when the subject is outside the focus area or when the contrast is too sharp and the appropriate exposure cannot be achieved.

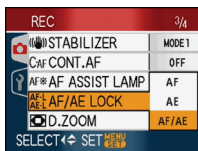

■ When [AF] is selected (Fixing the focus only)

- 1 Aim the AF area at the subject.
- 2 Press [AF/AE LOCK] to fix the focus.
 - Press [AF/AE LOCK] again to cancel it.
 - The AF lock indication [AF-L] lights when the subject is focused.
- 3 Move the camera to compose the picture and then press the shutter fully.

■ When [AE] is selected (Fixing the exposure only)

- 1 Aim the AF area at the subject.
- 2 Press [AF/AE LOCK] to fix the exposure.
 - Press [AF/AE LOCK] again to cancel it.
 - The AE lock indication [AE-L], the aperture value and the shutter speed appear when the exposure is set.
- 3 Move the camera to compose the picture and then press the shutter fully.

■ When [AF/AE] is selected (Fixing the focus and the exposure)

- 1 Aim the AF area at the subject.

- 2 Press [AF/AE LOCK] to fix the focus and the exposure.
 - Press [AF/AE LOCK] again to cancel it.
 - When the subject is focused and the exposure is set, the AF/AE lock indication [AF-L], the aperture value and the shutter speed appear.
- 3 Move the camera to compose the picture and then press the shutter fully.



- The exposure is set, even if the brightness of the subject changes.
- The subject can be focused again by pressing the shutter button halfway even when AE is locked.
- Program shift can be set even when AE is locked.
- The AF/AE lock function cannot be used in the intelligent auto mode [iA], advanced scene mode or scene mode.
- The AE lock function cannot be used in the Manual exposure mode, advanced scene mode or scene mode.

[COL.EFFECT]



Setting color effects for the recorded pictures



Press [MENU] to display the [REC] mode menu and select the item to set. (P71)
Select a color effect that matches the recording conditions and your image of the recording.

[OFF]	This is the standard setting.
[B/W]	The picture becomes black and white.
[SEPIA]	The picture becomes sepia.
[COOL]	The picture becomes bluish.
[WARM]	The picture becomes reddish.



- When in intelligent auto mode [iA], only [B/W] or [SEPIA] can be selected.

[PICT.ADJ.]

Adjusting the picture quality for the recorded pictures

P A S M C

Press [MENU] to display the [REC] mode menu and select the item to set. (P71)
Select an effect that matches the recording situation and your image of the recording.

[CONTRAST]	
[+]	Increases the difference between the brightness and the darkness in the picture.
[-]	Decreases the difference between the brightness and the darkness in the picture.

[SHARPNESS]	
[+]	The picture is sharply defined.
[-]	The picture is softly focused.

[SATURATION]	
[+]	The colors in the picture become vivid.
[-]	The colors in the picture become natural.

[NOISE REDUCTION]	
[+]	The noise reduction effect is enhanced. Picture resolution may deteriorate slightly.
[-]	The noise reduction effect is reduced. You can obtain pictures with higher resolution.



- When you take pictures in dark places, picture noise may become noticeable. If picture noise becomes a problem, we recommend that you take pictures after increasing the setting for [NOISE REDUCTION] or lowering the setting for each of the items other than [NOISE REDUCTION].

[FLIP ANIM.]

Connecting images to create a motion picture file

P A S M C SCN

Press [MENU] to display the [REC] mode menu and select the item to set. (P71)
This camera allows you to create motion picture files up to 20 seconds long by connecting images recorded in flip animation mode.

Example:
When capturing images of the subject in sequence moving the camera little by little and aligning the images, the subject looks as if it is moving.

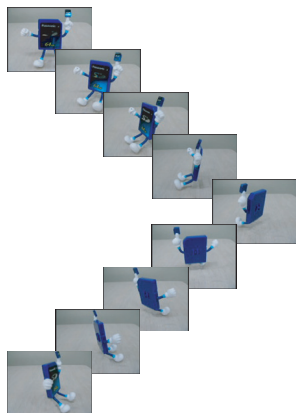

- You can play back created flip animations with the same method used to play back motion pictures. (P91)

1 Press ▲/▼ to select [FLIP ANIM.] and then press ►.

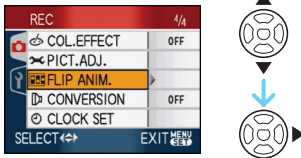

2 Select [PICTURE CAPTURE] and then press ►.



- The picture size is 320×240 pixels.

3 Press the shutter button and capture the images one frame at a time.



- You can check the recorded image with ▼ and the previous or following image with ◀/▶.
- Delete unnecessary images with the [DEL].
- You can record up to 100 pictures. The number of recordable pictures displayed is an approximation.

4 Press [MENU/SET], press ▲/▼ to select [CREATE MOTION PICTURE] and then press ►.

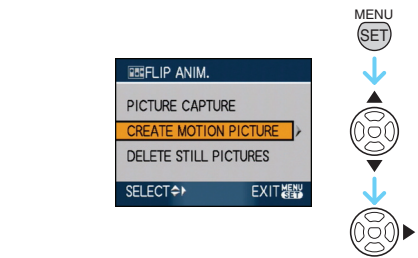

5 Select [FRAME RATE] and then press ►.

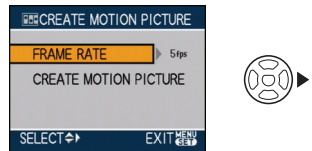

6 Press ▲/▼ to select [5fps] or [10fps] and then press [MENU/SET].

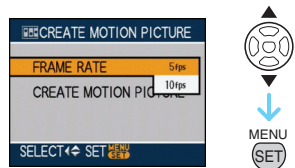

[5fps]	5 frames/sec.
[10fps]	10 frames/sec. (The motion pictures become smoother.)

7 Press ▼ to select [CREATE MOTION PICTURE], press ► and then create a flip animation.

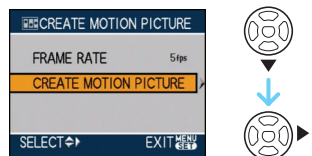

- The file number appears after creating a flip animation.
- Press [MENU/SET] three times to close the menu after creating the flip animation.

■ Deleting all still images used to create flip animation

When selecting [DELETE STILL PICTURES] in [FLIP ANIM.] menu, a confirmation screen appears. Select [YES] with ▲ and then press [MENU/SET].



- You cannot use the direction detection function, burst mode, auto bracket and [AUDIO REC.].
- The images in each frame do not appear in normal review.
- If you execute [CREATE MOTION PICTURE], flip animation is made from all pictures recorded for flip animation. Delete unnecessary pictures.
- Audio cannot be recorded.
- You cannot record audio using the audio dubbing. (P105)
- Playback may not be possible on other equipment. You may also hear noise during playback on other equipment which does not have a mute function.



[CONVERSION]

Using an optional lens



- Press [MENU/SET] to display the [REC] mode menu and select the item to set. (P71)
- The tele conversion lens (DMW-LT55; optional) allows you to record even more close-up pictures (1.7× more). The close-up lens (DMW-LC55; optional) allows you to take close-up pictures of a small subject.
- The lens adaptor (DMW-LA3; optional) is necessary to attach a tele conversion lens or close-up lens.

1 Remove the lens cap, lens hood and hood adaptor.

2 Attach the lens adaptor (DMW-LA3; optional).

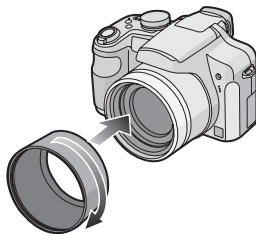

- Conversion lens cannot be used together with the ND filter (DMW-LND46; optional) and the MC protector (DMW-LMC46; optional). Always detach the ND filter or MC protector before attaching the conversion lens.
- Rotate the lens slowly and carefully.

3 Attach the tele conversion lens or close-up lens.

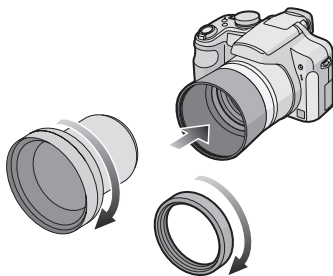

- You cannot attach a tele conversion lens or the close-up lens to the hood adaptor (supplied).

4 Turn the camera on, press ▲/▼ to select [CONVERSION] and then press ►.

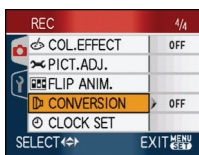

5 Press ▲/▼ to set to [17] or [0] and then press [MENU/SET].

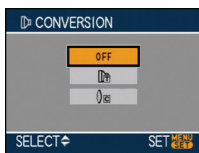

[OFF]	When you do not attach the conversion lens.
[17]	When you attach the tele conversion lens.
[0]	When you attach the close-up lens.

- Press the shutter button halfway or press [MENU/SET] to close the menu after finishing the setting.

■ Zoom magnification when a lens is attached

	Magnification
Tele conversion lens	9× to 18×*
Close-up lens	2× to 18×

- * The actual magnification when using the digital zoom and the extended optical zoom becomes 1.7× the displayed magnification.
- This is the magnification when using the highest resolution.

■ Recordable range when using a conversion lens

When attaching the tele conversion lens

- The recordable range when using the tele conversion lens is from 5.5 m (18.0 feet) to ∞.

When attaching the close-up lens

	Wide	Tele
Normal	20 cm (0.66 feet) to 50 cm (1.64 feet)	40 cm (1.31 feet) to 50 cm (1.64 feet)
Macro	14 cm (0.46 feet) to 50 cm (1.64 feet)	40 cm (1.31 feet) to 50 cm (1.64 feet)
Tele Macro	—	33 cm (1.08 feet) to 50 cm (1.64 feet)



- When there is dirt (water, oil, and fingerprints, etc.) on the surface of the lens, the image may be affected. Lightly wipe the surface of the lens with a soft, dry cloth before and after taking pictures.
- Ensure that [CONVERSION] is set to [OFF] when not using a conversion lens.
- When using the tele conversion lens or close-up lens:
 - The built-in flash cannot be activated.
 - If you set [CONVERSION] to [OFF], the performance of the tele conversion lens or close-up lens will not be optimal.
- When using the tele conversion lens:
 - We recommend using a tripod.
 - The stabilizer function may not work sufficiently.
 - The focus indication may light due to the jitter even if the subject is not focused.
 - The time required for focusing may become longer than usual.
- If you set [CONVERSION] to [17] or [0], you cannot use the built-in flash or AF assist lamp.
- Read the operating instructions of the conversion lens for details.

Displaying Multiple Screens (Multi Playback)



1 Rotate the zoom lever towards [] [W] to display multiple screens.

(Screen when 9 screens are displayed)



- [] : 1 screen → 9 screens → 25 screens → Calendar screen display (P89)
- Rotate the zoom lever towards [Q] [T] to return to the previous screen.

2 Press ▲/▼/◀/▶ to select a picture.

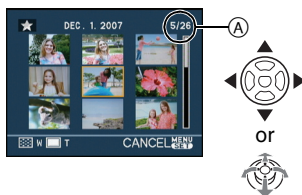

- (A) Number of the selected picture and the total number of recorded pictures
- Depending on the recorded picture and the setting, the following icons will appear.
 - [★] (Favorites)
 - [] (Motion picture)
 - [] ([BABY1]/[BABY2]/[PET] in scene mode)
 - [] (Travel date)
 - [] (Travel destination)
 - [] (Flip animation)
 - [] (Pictures stamped with [TITLE EDIT])

– [] (Pictures stamped with [TEXT STAMP])

■ Example of 25 screens



■ To return to normal playback

Rotate towards [Q] [T] or press [MENU/SET].

- The picture that was selected will appear.

■ To delete a picture during multi playback

- 1 Press ▲/▼/◀/▶ to select a picture and then press [].
- 2 Press ▲ to select [YES].
- 3 Press [MENU/SET].



- The recording information etc. on the LCD monitor/Viewfinder cannot be deleted in multi playback even if you press [DISPLAY].
- Pictures will not be displayed in the rotated direction even if [ROTATE DISP.] is set to [ON]. (P97)

Displaying Pictures by Recording Date

(Calendar Playback)



You can display pictures by recording date using the calendar playback function.

1 Rotate the zoom lever several times towards [] (W) to display the calendar screen.



- The recording date of the picture selected in the playback screen becomes the date selected when the calendar screen is first displayed.
- If there are multiple pictures with the same recording date, the first picture recorded on that day is displayed.

2 Press ▲/▼/◀/▶ to select the date to be played back.

- ▲/▼: Select the month
- ◀/▶: Select the date

- If there were no pictures recorded during a month, the month is not displayed.

3 Press [MENU/SET] to display the pictures that were recorded on the selected date.



- Rotate the zoom lever towards [] (W) to return to the calendar screen.

4 Press ▲/▼/◀/▶ to select a picture and then press [MENU/SET].

- The picture that was selected will appear.

■ To return to the 1 screen playback screen

After the calendar screen is displayed, rotate the zoom lever towards [Q] [T] to display 25 screens, 9 screens and the 1 screen.



- The pictures are displayed without being rotated even if you set [ROTATE DISP.] to [ON]. (P97)
- You can display the calendar between January 2000 and December 2099.
- If the recording date of the picture selected in 25 screen multi playback is not between January 2000 and December 2099, the camera displays it in the oldest recording date in the calendar.
- Pictures edited on a PC or other equipment will be displayed with dates different from the actual recording dates.
- If the date is not set in the camera, the recording date is set as January 1st, 2007.
- If you take pictures after setting the travel destination in [WORLD TIME], the pictures are displayed by the dates at the travel destination in calendar playback.
- You can also select or set by using the joystick.

Using the Playback Zoom



1 Rotate the zoom lever towards [Q] [T] to enlarge the picture.

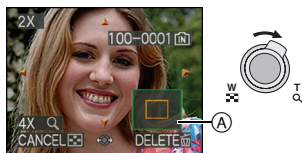

- Q: 1X → 2X → 4X → 8X → 16X
- When you rotate the zoom lever towards [Q] [W] after enlarging the picture, the magnification becomes lower. When you rotate the zoom lever towards [Q] [T], the magnification becomes higher.
- When you change the magnification, the zoom position indication (A) appears for about 1 second so that you can check the position of the enlarged section.

2 Press ▲/▼/◀/▶ to move the position.

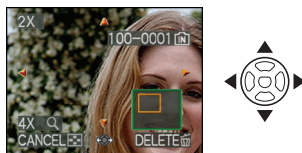

- When you move the position to be displayed, the zoom position indication appears for about 1 second.

■ To delete a picture during the playback zoom

- 1 Press [DELETE].
- 2 Press ▲ to select [YES].
- 3 Press [MENU/SET].

■ Selecting pictures while they are enlarged (during playback zoom)

Press ◀/▶ on the joystick after performing step 1 or 2.



- You can also delete the recording information etc. on the LCD monitor/Viewfinder during playback zoom by pressing [DISPLAY].
- The more a picture is enlarged, the more its quality deteriorates.
- If you want to save the enlarged picture, use the trimming function. (P107)
- The playback zoom may not operate if pictures have been recorded with other equipment.
- The zoom position returns to the center in the following pictures.
 - Images with different aspect ratios
 - Images with different numbers of recorded pixels
 - Images with a different rotation direction (when [ROTATE DISP.] is set to [ON])

Playing Back Motion Pictures/Pictures with Audio



■ Motion pictures

Press ◀▶ to select a picture with a motion picture icon [30fps VGA] / [10fps VGA] / [30fps QVGA] / [10fps QVGA] / [30fps 16:9] / [10fps 16:9] and then press ▼ to play back.

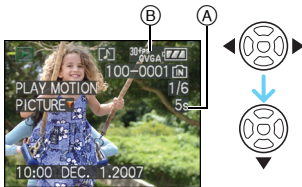

(A) The motion picture recording time

(B) Motion picture icon

• After playback starts, the elapsed playback time is displayed on the bottom right of the screen.
For example, 8 minutes and 30 seconds is displayed as [8m30s].

• The cursor displayed during playback is the same as ▲/▼/◀/▶.



Stopping motion picture playback

Press ▼.

Fast forwarding/Fast rewinding

Press and hold ◀▶ during motion picture playback.

◀: Fast rewind

▶: Fast forward

• The camera returns to normal motion picture playback when ◀▶ is released.

To pause

Press ▲ during motion picture playback.

• Press ▲ again to cancel pause.

Frame-by-frame forwarding/rewinding

Press ◀▶ while pausing.

■ Pictures with audio

Press ◀▶ to select a picture with the audio icon [] and then press ▼ to play back.

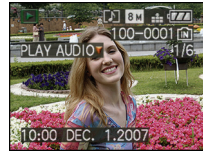

• Refer to [AUDIO REC.] (P77) and [AUDIO DUB.] (P105) for information about how to create still pictures with audio.



• Sound can be heard through the speaker. Refer to [VOLUME] (P22) for information about how to adjust the volume in the [SETUP] menu.

• The file format that can be played back with this camera is QuickTime Motion JPEG.

• Please note that the bundled software includes QuickTime to play back motion picture files created with the camera on the PC. (P111)

• Some QuickTime Motion JPEG files recorded by a PC or other equipment may not play back on the camera.

• If you play back motion pictures that have been recorded with other equipment, the picture quality may deteriorate or the pictures may not play back.

• When using a high capacity card, it is possible that fast rewinding may be slower than usual.

• You cannot use the following functions with motion pictures and pictures with audio.

– Playback zoom

(While playing back or pausing motion pictures and while playing audio)

– [TITLE EDIT]/[ROTATE DISP.]/[ROTATE]/[AUDIO DUB.] (Motion pictures only)

- [TEXT STAMP]/[RESIZE]/[TRIMMING]/[ASPECT CONV.]

Creating still pictures from a motion picture



You can create a single still picture (with 1 screen or 9 screens) from a recorded motion picture. This is effective in moving scenes when you want to look carefully at the movement of a sports person etc.

- 1 Press ◀/▶ to select a picture with a motion picture icon [30fps VGA] / [10fps VGA] / [30fps QVGA] / [10fps QVGA] / [30fps 16:9] / [10fps 16:9] and then press ▼ to play back.**

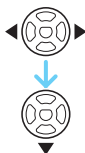

- 2 Press ▲ to pause motion picture playback.**



- Press ▲ again to return to motion picture playback.
- Press ◀/▶ while paused to move forward frame-by-frame.
- If you press the shutter button, you can save the displayed still pictures as one single picture. (Perform step **3**)

- Saving a single still picture with 9 screens from the motion picture**
- Rotate the zoom lever towards [W] to display the 9 screens playback screen.

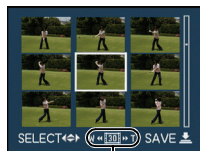

(A)

- Rotate the zoom lever further towards [W] to switch to [16:] / [10:] / [5:] (A).

- When a motion picture with [30fps VGA], [30fps QVGA] or [30fps 16:9] was selected**

The recorded motion picture is created using 30 still picture frames per second.

- [30:] All the frames of the recorded motion picture are displayed as still pictures (1/30th second intervals)
- [16:] 1 frame is skipped/every second frame is displayed as a still picture (1/15th second intervals)
- [10:] 2 frames are skipped/every third frame is displayed as a still picture (1/10th second intervals)
- [5:] 5 frames are skipped/every sixth frame is displayed as a still picture (1/5th second intervals)

- When a motion picture with [10fps VGA], [10fps QVGA] or [10fps 16:9] was selected**

The recorded motion picture is created using 10 still picture frames per second.

- [10:] All the frames of the recorded motion picture are displayed as still pictures (1/10th second intervals)
- [5:] 1 frame is skipped/every second frame is displayed as a still picture (1/5th second intervals)

- You can move forward frame-by-frame by pressing **▲/▼/◀/▶**.
▲/▼: Move forward/backward 3 frames at a time.
◀/▶: Move forward/backward 1 frame at a time.

3 Press the shutter button.

- The message [SAVE THESE NINE PICTURES AS ONE SINGLE PICTURE ?] appears. Also, the message [SAVE AS A SINGLE PICTURE ?] appears if you saved the picture in step 2.

4 Press **▲** to select [YES] and then press [MENU/SET].



- The nine pictures are saved as one single picture.

■ To stop using the 9 screens playback screen

After the 9 screens playback screen is displayed, rotate the zoom lever several times towards [Q] [T] or press [MENU/SET]. The screen returns to the paused motion picture playback screen.

■ Picture size

Item	1 picture	9 pictures
[30fpsVGA]	0.3 M	2 M
[10fpsVGA]	0.3 M	2 M
[30fpsQVGA]	0.3 M	1 M
[10fpsQVGA]	0.3 M	1 M
[30fps16:9]	2 M	2 M
[10fps16:9]	2 M	2 M

- [QUALITY] is fixed to [].



- You may not be able to save still pictures from a motion picture taken on other equipment.

Using the [PLAY] mode menu



You can use various functions in playback mode to rotate pictures, set protection for them etc.

1 Press [MENU/SET].

2 Press **▲/▼** to select the menu item and then press **▶**.



(A)

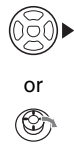

- Press **▼** at (A) to switch to the next menu screen.
- You can switch menu screens from any menu item by rotating the zoom lever.
- After performing steps 1 and 2, refer to the description of the menu item in the operating instructions and then set it.**

Items that can be set

Menu screen	Item
1/3	: [SLIDE SHOW] (P94)
	: [CATEGORY] (P95)
	: [ROTATE DISP.] (P97)
	: [ROTATE] (P97)
	: [FAVORITE] (P98)
2/3	: [TITLE EDIT] (P99)
	: [TEXT STAMP] (P101)
	: [DPOF PRINT] (P103)
	: [PROTECT] (P104)
	: [AUDIO DUB.] (P105)
3/3	: [RESIZE] (P106)
	: [TRIMMING] (P107)
	: [ASPECT CONV.] (P108)
	: [COPY] (P109)
	: [FORMAT] (P110)

- With [TEXT STAMP], [RESIZE], [TRIMMING] or [ASPECT CONV.], a new edited picture is created. A new picture cannot be created if there is no free space on the built-in memory or the card so we recommend checking that there is free space and then editing the picture.

[SLIDE SHOW]

Playing back pictures in order for a fixed duration

Press to display the [PLAY] mode menu and select the item to set. (P93)
This is recommended when playing back pictures on a TV screen. You can skip unwanted pictures if [FAVORITE] (P98) has been set. Also, you can play back a recorded category slide show (P96).

1 Press / to select [ALL], [] or [] and then press [MENU/SET].



[ALL]	Displays all pictures.
[★]	Displays only those pictures that have been set as favorites (P98).
[]	Displays only if a category slide show is recorded in [CATEGORY] (P95).

- [] appears only when [FAVORITE] is set to [ON]. If none of the pictures have [] displayed, you cannot select [] even if [FAVORITE] is set to [ON].
- You cannot select [] if a category slide show is not recorded.

2 Press to select [START] and then press [MENU/SET].

(Screen when [ALL] is selected)

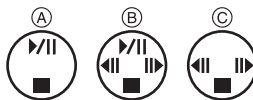
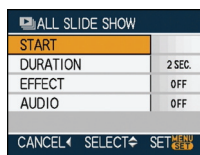

- The cursor displayed during a slide show (A) or while a slide show is paused (B) or during [MANUAL] slide show (C) is the same as //◀/▶.
- Press to pause the slide show. Press again to cancel pause.
- Press ◀/▶ while paused to display the previous or next picture. (However, the selected effect is disabled.)

3 Press ▼ to finish.

■ Setting the audio, duration and effect

Select [DURATION], [EFFECT] or [AUDIO] on the screen shown in step 2 and set.

[DURATION]	<p>Can be set to [1SEC.], [2SEC.], [3SEC.], [5SEC.] or [MANUAL] (manual playback).</p> <ul style="list-style-type: none"> You can only select [MANUAL] when [★] or [] has been selected in step 1. Press ◀▶ to display the previous or next picture when [MANUAL] is selected.
[EFFECT]	<p>A slide show effect can be selected.</p> <p>[OFF]: No effect</p> <p>□: New pictures slide across the screen.</p> <p>▒: Current pictures fade out and new pictures fade in.</p> <p>▒: New pictures gradually fill the screen from the center.</p> <p>[MIX]: An effect is selected at random.</p> <ul style="list-style-type: none"> If you set [DURATION] to [MANUAL] the settings in [EFFECT] are disabled.
[AUDIO]	<p>If set to [ON], the audio of the pictures with audio is played back.</p>



- If you set [AUDIO] to [ON] and then play back a picture with audio, the next picture will be displayed after the audio has finished.
- You cannot play back motion pictures and use power save in a slide show. (However, the setting for power save mode is fixed to [10MIN.] while pausing a slide show or playing back a manual slide show.)



[CATEGORY] Searching by recording information



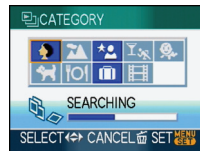



Press [MENU] to display the [PLAY] mode menu and select the item to set. (P93)
This mode allows you to search the recording information in scene modes etc. ([PORTRAIT], [SCENERY], [NIGHT SCENERY] etc.) and sort the pictures into different categories. You can then play back the pictures in each category normally or as a slide show.

Press ▶ to search the categories.



- If a picture is found in a category, the category icon turns blue.
- It may take time to search the picture files if there are a lot on the card or the built-in memory.
- If you press [] while searching, the searching will stop halfway.
- Pictures are sorted into the categories shown below.

[CATEGORY]	Recording information e.g. scene modes
 (Portrait etc.)	[PORTRAIT] mode, [i-PORTRAIT], [NIGHT PORTRAIT], [i-NIGHT PORTRAIT], [BABY1]/[BABY2]
 (Scenery etc.)	[SCENERY] mode, [i-SCENERY], [SUNSET], [AERIAL PHOTO]
 (Night scenery etc.)	[NIGHT PORTRAIT] mode, [i-NIGHT PORTRAIT], [i-NIGHT SCENERY], [STARRY SKY]

 (Event)	[SPORTS] mode, [PARTY], [CANDLE LIGHT], [PANNING], [FIREWORKS], [BEACH], [SNOW], [AERIAL PHOTO]
	[BABY1]/[BABY2]
	[PET]
	[FOOD]
	[TRAVEL DATE]
	[MOTION PICTURE], [FLIP ANIM.]

1 Press $\blacktriangle/\blacktriangledown/\blacktriangleleft/\blacktriangleright$ to select the category to play back and then press [MENU/SET] to set.



2 Press $\blacktriangleleft/\blacktriangleright$ to select the picture.



- Rotate the zoom lever towards $\left[\begin{array}{|c|c|} \hline \square & \square \\ \hline \end{array} \right]$ [W] to display 9 screens and rotate the zoom lever towards $\left[\begin{array}{|c|} \hline \square \\ \hline \end{array} \right]$ [T] to enlarge the picture up to 16 \times .
- You can record pictures as favorites by pressing \blacktriangle if [FAVORITE] is set to [ON].
- Pictures cannot be deleted during category playback even if you press $\left[\begin{array}{|c|} \hline \square \\ \hline \end{array} \right]$.

3 Press [MENU/SET] twice to close the menu.

■ Playing back a slide show

1 Press $\blacktriangle/\blacktriangledown/\blacktriangleleft/\blacktriangleright$ to select the category to play back and then press [DISPLAY].

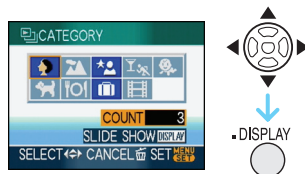

2 Press \blacktriangle to select [START] and then press [MENU/SET].

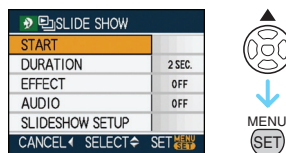

- Press \blacktriangle during a slide show to pause it. Press \blacktriangle again to cancel pause.
- Press $\blacktriangleleft/\blacktriangleright$ while paused to display the previous or next picture.
- Refer to P95 for information about setting [DURATION], [EFFECT] and [AUDIO].

3 Press \blacktriangledown to finish the slide show.

4 Press [MENU/SET] twice to close the menu.

■ Recording a slide show

If you record a category slide show, you can play it back by selecting $\left[\begin{array}{|c|} \hline \square \\ \hline \end{array} \right]$ in [SLIDE SHOW] on P94.

1 Press **▼** to select [SLIDESHOW SETUP] and then press [MENU/SET].

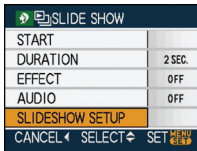

2 Press **▲** to select [YES] and then press [MENU/SET].



- You can only record one category slide show on one card. If a category slide show has already been recorded, the message [A CATEGORY SLIDESHOW ALREADY EXISTS. OVERWRITE?] appears.
- If there are 1000 or more pictures, you can make a slide show with up to 999 pictures.

3 Press **◀** to return to the category playback screen.

- Press [**⏪**] and then press [MENU/SET] to close the menu.



- You cannot play back motion pictures as a slide show.
- Still pictures created from a motion picture (P92) cannot be played back from the motion pictures category [**MOV**] in category playback.
- Pictures that were taken with the [QUALITY] set to [RAW] cannot be played using [CATEGORY].

▶ [ROTATE DISP.]/[ROTATE]

To display the picture rotated

Press [**MENU/SET**] to display the [PLAY] mode menu and select the item to set. (P93) This mode allows you to automatically display pictures vertically if they were recorded holding the camera vertically or rotate pictures manually in 90° steps.

■ Rotate display

(The picture is automatically rotated and displayed.)

1 Press **▼** to select [ON] and then press [MENU/SET].



- The pictures are displayed without being rotated when you select [OFF].
- Refer to P33 for information about how to play back pictures.

2 Press [MENU/SET] to close the menu.

■ Rotate

(The picture is rotated manually.)

1 Press **◀▶** to select the picture and then press **▼**.

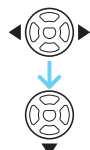

- The [ROTATE] function is disabled when [ROTATE DISP.] is set to [OFF].
- Motion pictures and protected pictures cannot be rotated.

2 Press ▲/▼ to select the direction to rotate the picture and then press [MENU/SET].



	The picture rotates clockwise in steps of 90°.
	The picture rotates counter-clockwise in steps of 90°.

3 Press [MENU/SET] twice to close the menu.



- If you take pictures when aiming the camera up or down, it may not be possible to display the pictures vertically.
- The picture may be slightly blurred when the camera is connected to the TV with the AV cable (supplied) and played back vertically.
- When you play back pictures on a PC, they cannot be displayed in the rotated direction unless the OS or software is compatible with Exif. Exif is a file format for still pictures which allows recording information etc. to be added. It was established by “JEITA (Japan Electronics and Information Technology Industries Association)”.
- Rotated pictures are displayed rotated when they are played back in review playback and playback zoom however are displayed without being rotated when they are played back in multi playback.
- It may not be possible to rotate pictures that have been recorded with other equipment.

★ [FAVORITE] Setting your favorite pictures

Press [MENU/SET] to display the [PLAY] mode menu and select the item to set. (P93) You can do the following if a mark has been added to pictures and they have been set as favorites.

- Delete all the pictures not set as favorites. ([ALL DELETE EXCEPT ★])
- Play back the pictures set as favorites only as a slide show.

1 Press ▼ to select [ON] and then press [MENU/SET].



- You cannot set pictures as favorites if [FAVORITE] is set to [OFF]. Also the favorites icon [★] will not appear when [FAVORITE] is set to [OFF] even if it was previously set to [ON].
- You cannot select [CANCEL] if none of the pictures have [★] displayed.

2 Press [MENU/SET] to close the menu.

3 Press ◀▶ to select the picture then press ▲.

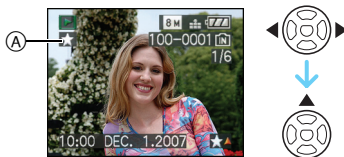

- Repeat the above procedure.
- If ▲ is pressed while the [★] favorites icon (A) is displayed, [★] is cleared, and the favorites setting is canceled.
- You can set up to 999 pictures as favorites.

■ Deleting all favorites

- 1 Select [CANCEL] on the screen shown in step 1 and then press [MENU/SET].
- 2 Press ▲ to select [YES] and then press [MENU/SET].
- 3 Press [MENU/SET] to close the menu.



- When printing pictures at a photo printing store, [ALL DELETE EXCEPT ★] (P34) is useful so only the pictures you want to be printed remain on the card.
- Use [LUMIX Simple Viewer] or [PHOTOfunSTUDIO-viewer-] on the CD-ROM (supplied), to set, confirm or delete favorites. [For details, refer to the operating instructions (PDF file) of the software.]
- You may not be able to set pictures taken with other equipment as favorites.
- Pictures that were taken with the [QUALITY] set to [RAW] cannot be set to [FAVORITE].

[TITLE EDIT] Adding text (comments) to pictures

Press [MENU] to display the [PLAY] mode menu and select the item to set. (P93) You can add text (comments) to pictures. After text has been registered, it can be included in prints using [TEXT STAMP] (P101). (Only alphabetic characters and symbols can be entered.)

Press ▲/▼ to select [SINGLE] or [MULTI] and then press [MENU/SET].

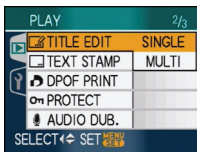

■ Single setting

1 Press ◀▶ to select a picture and then press ▼.

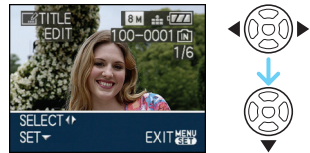

- The title edit icon [] is displayed for pictures that have already been recorded with text in [BABY1]/[BABY2] (P61) or [PET] (P62) name settings in scene mode or [TITLE EDIT].

2 Press ▲/▼/◀▶ to input the text (comments) and then press [MENU/SET] to register the text.

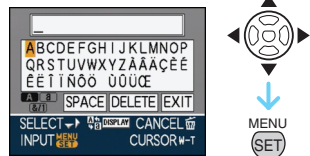

- Refer to the P100 for an example of the text entry.
- Press [DISPLAY] to switch text between [A] (capitals), [a] (small case) and [&/1] (special characters and numbers).
- The cursor at the entry position can be moved to the left with [◀], and to the right with [▶].
- To enter a blank, move the cursor to [SPACE], and press [MENU/SET].
- To stop editing at any time during text entry, press [EXIT].
- To delete an entered character, move the cursor to [DELETE], and press [MENU/SET].
- A maximum of 30 characters can be entered.

3 Press **▲/▼/◀/▶** to move the cursor to [EXIT] and then press [MENU/SET] to end text input.

4 Press [MENU/SET] twice to close the menu.

- You can also use the joystick to perform steps **1** to **4**.

■ Multi setting

1 Press **◀/▶** to select the picture and then press **▼** to SET/CANCEL.

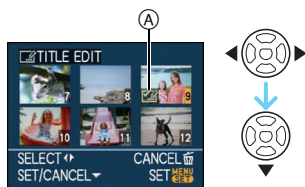

[SET]	The [TITLE EDIT] icon (A) appears.
[CANCEL]	The [TITLE EDIT] icon (A) disappears.

- Repeat this step.
- Titles cannot be changed or deleted in [MULTI].

2 Press [MENU/SET].

- After performing step **2**, perform step **2** onwards in “Single setting” (P99).

■ Delete the title (for [SINGLE] only)

- 1** In step **2** when [SINGLE] (P99) is selected, delete all the texts, select [EXIT], and press [MENU/SET].
- 2** Press [MENU/SET] twice to close the menu.

Example of text entry

In case of entering [LUMIX]:

- 1** Press **▲/▼/◀/▶** to move the cursor to [L] and then press [MENU/SET].
- 2** Press **▲/▼/◀/▶** to move the cursor to [U] and then press [MENU/SET].
- 3** Press **▲/▼/◀/▶** to move the cursor to [M] and then press [MENU/SET].
- 4** Press **▲/▼/◀/▶** to move the cursor to [I] and then press [MENU/SET].
- 5** Press **▲/▼/◀/▶** to move the cursor to [X] and then press [MENU/SET].



- Registered text can be displayed on the screen of this unit.
- Text can be scrolled if all of the registered text does not fit on the screen.
- [BABY1]/[BABY2] (P61) or [PET] (P62) name settings in scene mode can also be registered by using the operation in steps **2** and **3** when [SINGLE] (P99) is selected.
- The name setting of [BABY1]/[BABY2] (P61) or [PET] (P62) in scene mode and [TITLE EDIT] cannot be registered at the same time.
- You can use the software [PHOTOfunSTUDIO-viewer-] on the CD-ROM (supplied) to print the text (comments). [For details, refer to the operating instructions (PDF file) of the software.]
- You can set up to 50 pictures at one time with [MULTI].
- You cannot use title edit for the following pictures.
 - Pictures recorded when the quality is set to [RAW] or [RAW+JPEG]
 - Pictures recorded with other equipment
 - Motion pictures
 - Protected pictures

[TEXT STAMP]

Stamping text, dates and other registered information on recorded pictures

Press [MENU] to display the [PLAY] mode menu and select the item to set. (P93) Registered text, recorded date, age and travel dates can be stamped onto recorded pictures.

It is suitable for regular size printing. (Pictures with a picture size larger than [3M] will be resized when stamping the date etc. on them.)

Press ▲/▼ to select [SINGLE] or [MULTI] and then press [MENU/SET].

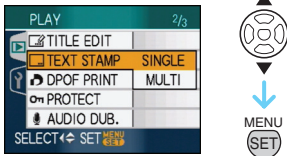

- Text and dates cannot be stamped on the following pictures.
 - Pictures recorded without setting the clock
 - Pictures recorded when the quality is set to [RAW] or [RAW+JPEG]
 - Pictures recorded with other equipment
 - Pictures that were previously stamped with [TEXT STAMP]
 - Motion pictures
 - Pictures with Audio

■ Single setting

1 Press ◀/▶ to select the picture and then press ▼.

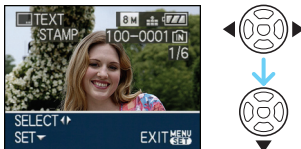

2 Press ▲/▼/◀/▶ to select [SHOOTING DATE], [AGE], [TRAVEL DATE] or [TITLE] and then press [MENU/SET] to set each item.

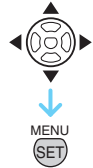
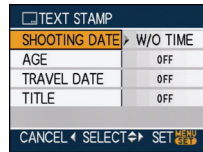

• [SHOOTING DATE]

[W/O TIME]	Stamp the year, month and date.
[WITH TIME]	Stamp the year, month, day, hour and minutes.

• [AGE]

If this is set to [ON], the age is stamped on pictures recorded when the camera was set to [AGE].

• [TRAVEL DATE]

If this is set to [ON], the travel date is stamped on pictures recorded when [TRAVEL DATE] was set to [ON].

• [TITLE]

Text is printed together with the image for pictures that have already been recorded with text in [BABY1]/[BABY2] (P61) or [PET] (P62) name settings in scene mode or [TITLE EDIT].

3 Press [MENU/SET].

- If you set [TEXT STAMP] for a picture with a picture size larger than [3M], the picture size will become smaller as shown below.

Aspect ratio setting	Picture size
4:3	8M / 5M → 3M
3:2	7M / 4.5M → 2.5M
16:9	6M / 3.5M → 2M

- The picture becomes slightly rougher.

4 Press ▲/▼ to select [YES] or [NO] and then press [MENU/SET].

(The screen shown appears when you select a picture recorded with a [8M] picture size.)



- The message [DELETE ORIGINAL PICTURE?] appears if the picture was recorded with a picture size [3M] or less.
- The picture is overwritten when you select [YES]. Pictures stamped with text cannot be restored once they are overwritten.
- A picture stamped with text is newly created when you select [NO].
- If the original picture is protected, you cannot overwrite it. Select [NO] and newly create the picture stamped with text.

5 Press [MENU/SET] twice to close the menu.

- The text stamp icon [] (A) appears on screen if the picture is stamped with text.
- Use playback zoom to check added text and dates information (B).

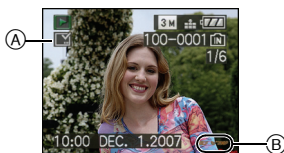

Multi setting

1 Press ◀▶ to select the picture and then press ▼ to SET/CANCEL.

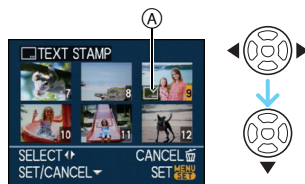

[SET]	The [TEXT STAMP] icon (A) appears.
[CANCEL]	The [TEXT STAMP] icon (A) disappears.

- Repeat this step.

2 Press [MENU/SET].

- After performing step 2, perform step 2 onwards in "Single setting" (P101).



- When you print pictures stamped with text, the date will be printed over the stamped text if you specify printing of the date at the photo shop or on the printer.
- We recommend that you use text stamping when there is plenty of space in the built-in memory or the card.
- You can set up to 50 pictures at one time in [MULTI].
- If you select [YES] in step 4 when the pictures selected under [MULTI] include protected pictures, a message appears and only the protected pictures cannot be stamped with text.
- Depending on the printer being used, some characters may be cut at printing. Check before printing.
- You cannot use the following functions if text has been stamped on the picture.
 - [TEXT STAMP]
 - The [PRINT WITH DATE] setting for DPOF print
 - [RESIZE]

- [TRIMMING]
- [ASPECT CONV.]
- When text is stamped onto the [0.3M] pictures, it is difficult to read it.

[DPOF PRINT]**Setting the picture to print and the number of prints**

Press [MENU] to display the [PLAY] mode menu and select the item to set. (P93) DPOF "Digital Print Order Format" is a system that allows the user to select which pictures to print, how many copies of each picture to print and whether or not to print the recording date on the pictures when using a DPOF compatible photo printer or photo printing store. For details, ask at your photo printing store.

When you want to use a photo printing store to print pictures recorded on the built-in memory, copy them to a card (P109) and then set the DPOF setting.

For more information visit:
http://panasonic.jp/dc/dpof_110/white_e.htm

Press ▲/▼ to select [SINGLE], [MULTI] or [CANCEL] and then press [MENU/SET].

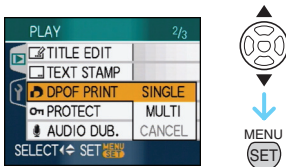

- You cannot select [CANCEL] if there are no prints that have been set in the DPOF print settings.

Single setting

1 Press ◀▶ to select the picture to print and then press ▲/▼ to set the number of prints.

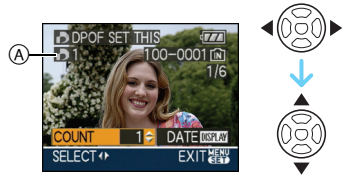

- The number of prints icon [] (A) appears.
- The number of prints can be set from 0 to 999. The DPOF print setting is canceled when the number of prints is set to [0].

2 Press [MENU/SET] twice to close the menu.

Multi setting

1 Press ◀▶ to select the picture to print and then press ▲/▼ to set the number of prints.

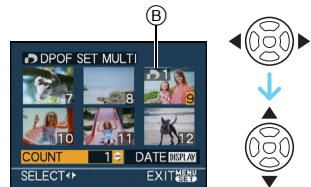

- The number of prints icon [] (B) appears.
- Repeat the above procedure. (You cannot set all the pictures at one time.)
- The number of prints can be set from 0 to 999. The DPOF print setting is canceled when the number of prints is set to [0].

2 Press [MENU/SET] twice to close the menu.

■ To cancel all settings

1 Press **▲** to select [YES] and then press [MENU/SET].

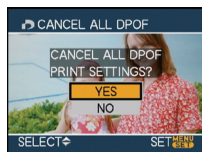

2 Press [MENU/SET] to close the menu.

- DPOF print settings on the built-in memory are canceled when a card is not inserted. DPOF print settings on the card are canceled when a card is inserted.

■ To print the date

After setting the number of prints, set/cancel printing with the recording date by pressing [DISPLAY].

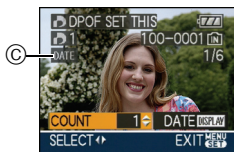

- The date print icon [DATE] © appears.
- When you go to a photo printing store for digital printing, be sure to order the printing of the date additionally if required.
- Depending on the photo printing store or the printer, the date may not be printed even if you set to print the date. For further information, ask at your photo printing store or refer to the operating instructions for the printer.
- The date cannot be printed on pictures stamped with text.
- If you set [TEXT STAMP] for pictures that have been set for date printing, the date printing setting is canceled.



- DPOF is an abbreviation of "Digital Print Order Format". This feature allows you to write print information to media and then use the information on a DPOF-compliant system.
- DPOF print setting is a convenient function when printing pictures with a printer that supports PictBridge. The date printing setting on the printer may take priority over the date printing setting on the camera. Check the date printing setting on the printer also. (P113)
- Some DPOF information set by other equipment cannot be used. In such cases, delete all of the DPOF information and then set it again with this camera.
- If the file is not based on the DCF standard, the DPOF print setting cannot be set.
- Pictures that were taken with the [QUALITY] set to [RAW] cannot be printed using DPOF print.

[PROTECT]

Preventing accidental erasure of pictures

Press [MENU] to display the [PLAY] mode menu and select the item to set. (P93)
You can set protection for pictures you do not want to be deleted by mistake.

Press **▲/▼** to select [SINGLE], [MULTI] or [CANCEL] and then press [MENU/SET].

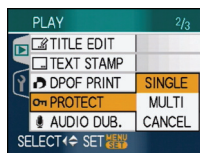

■ Single setting

1 Press ◀▶ to select the picture and then press ▼ to SET/CANCEL.



[SET]	The protect icon [] (A) appears.
[CANCEL]	The protect icon [] (A) disappears.

2 Press [MENU/SET] twice to close the menu.

■ Multi setting/To cancel all settings

Perform the same operation as in "[DPOF PRINT]". (P103 to 104)



- If you press [MENU/SET] while canceling protection, the canceling will stop halfway.
- The protect setting may not be effective on other equipment.
- If you want to delete protected pictures, cancel their protection.
- Even if you protect pictures in the built-in memory or a card, they will be deleted if the built-in memory or the card is formatted.
- Even if you do not protect pictures on an SD Memory Card or an SDHC Memory Card, they cannot be deleted when the card's Write-Protect switch (B) is set to [LOCK].



- The following functions cannot be used with protected pictures.
 - [ROTATE]

- [AUDIO DUB.]
- [TITLE EDIT]

[AUDIO DUB.] Adding audio after taking pictures

Press [MENU] to display the [PLAY] mode menu and select the item to set. (P93)
You can add the audio after taking a picture.

1 Press ◀▶ to select the picture and then press ▼ to start audio recording.

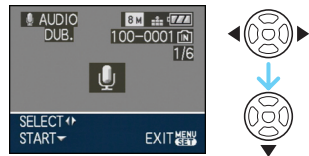

- The message [OVERWRITE AUDIO DATA?] screen appears when audio has already been recorded. Press ▲ to select [YES] and then press [MENU/SET] to start audio recording. (The original audio is overwritten.)
- Audio dubbing cannot be used with the following pictures.
 - Motion pictures
 - Protected pictures
 - Pictures recorded when the quality is set to [RAW] or [RAW+JPEG]

2 Press ▼ to stop recording.



- The audio recording stops automatically if ▼ is not pressed after about 10 seconds.

3 Press [MENU/SET] twice to close the menu.



- Audio dubbing may not work properly on pictures recorded by other equipment.

[RESIZE] Making the picture size smaller

Press [MENU] to display the [PLAY] mode menu and select the item to set. (P93)
We recommend resizing to [0.3M] if you want to attach a picture to an e-mail or use it on a website.

1 Press [LEFT]/[RIGHT] to select the picture and then press [DOWN].



2 Press [LEFT]/[RIGHT] to select the size and then press [DOWN].

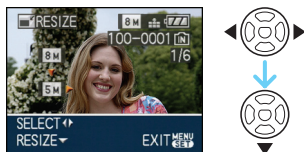

- Sizes smaller than the recorded picture are displayed.

Aspect ratio setting	Picture size
4:3	5M / 3M / 2M / 0.3M
3:2	4.5M / 2.5M
16:9	3.5M / 2M

- The message [DELETE ORIGINAL PICTURE?] appears.

3 Press [UP]/[DOWN] to select [YES] or [NO] and then press [MENU/SET].



- The picture is overwritten when you select [YES]. Resized pictures cannot be restored when they are overwritten.
- A resized picture is newly created when you select [NO].
- If the original picture is protected, you cannot overwrite it. Select [NO] and newly create a resized picture.

4 Press [MENU/SET] twice to close the menu.



- The following pictures cannot be resized.

Aspect ratio setting	Picture size
4:3	0.3M
3:2	2.5M
16:9	2M

- Pictures recorded when the quality is set to [RAW] or [RAW+JPEG]
- Motion pictures
- Flip animation
- Pictures with audio
- Pictures stamped with [TEXT STAMP]
- It may not be possible to resize pictures recorded with other equipment.

[TRIMMING]

Enlarging a picture and trimming it

Press [MENU/SET] to display the [PLAY] mode menu and select the item to set. (P93)
You can enlarge and then clip the important part of the recorded picture.

1 Press [LEFT]/[RIGHT] to select the picture and then press [DOWN].



- The following pictures cannot be trimmed.
 - Pictures recorded when the quality is set to [RAW] or [RAW+JPEG]
 - Motion pictures
 - Flip animation
 - Pictures with audio
 - Pictures stamped with [TEXT STAMP]

2 Enlarge or decrease the parts to be trimmed with the zoom lever.



3 Press [UP]/[DOWN]/[LEFT]/[RIGHT] to move the position of the part to be trimmed.



4 Press the shutter button.

- The message [DELETE ORIGINAL PICTURE?] appears.

5 Press [UP]/[DOWN] to select [YES] or [NO] and then press [MENU/SET].



- The picture is overwritten when you select [YES]. The trimmed pictures cannot be restored when they are overwritten.
- A trimmed picture is newly created when you select [NO].
- When the original picture is protected, you cannot overwrite it. Select [NO] and newly create a trimmed picture.

6 Press [MENU/SET] twice to close the menu.



- Depending on the cut size, the picture size of the trimmed picture may become smaller than that of the original picture.
- The picture quality of the trimmed picture will deteriorate.
- It may not be possible to trim pictures recorded with other equipment.

[ASPECT CONV.]

 Changing the aspect ratio of a 16:9 picture

Press [**MENU/SET**] to display the [PLAY] mode menu and select the item to set. (P93)
You can convert pictures taken with a [16:9] aspect ratio to a [3:2] or a [4:3] aspect ratio.

1 Press ▲/▼ to select [3:2] or [4:3] and then press [MENU/SET].

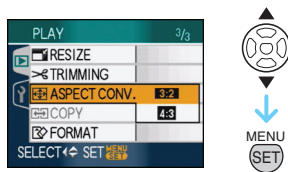

- The following pictures cannot be converted.
 - Pictures recorded when the quality is set to [RAW] or [RAW+JPEG]
 - Motion pictures
 - Flip animation
 - Pictures with audio
 - Pictures stamped with [TEXT STAMP]

2 Press ◀/▶ to select a picture and then press ▼.



- If you select and set a picture with an aspect ratio other than [16:9], the message [CANNOT BE SET ON THIS PICTURE] is displayed on the screen.

3 Press ◀/▶ to determine the horizontal position and press the shutter button to set.



- Use ▲/▼ to set the frame position for pictures rotated vertically.
- The message [DELETE ORIGINAL PICTURE?] appears.

4 Press ▲/▼ to select [YES] or [NO] and then press [MENU/SET].



- The picture is overwritten when you select [YES]. If you convert the aspect ratio of a picture and then overwrite it, you cannot restore it.
- A picture with the converted aspect ratio is newly created when you select [NO].
- When the original picture is protected, you cannot overwrite it. Select [NO] and newly create a picture with the converted aspect ratio.

5 Press [MENU/SET] twice to close the menu.



- After converting the aspect ratio, the picture size may become larger than that of the original picture.
- Files that do not conform to the DCF standard cannot be converted.
- You may not be able to convert pictures taken on other equipment.

**[COPY]****Copying the picture data**

Press [MENU/SET] to display the [PLAY] mode menu and select the item to set. (P93)
You can copy recorded picture data from the built-in memory to a card or vice versa.

1 Press ▲/▼ to select the copy destination and then press [MENU/SET].

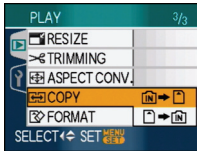

- [IN] → []:

All the picture data in the built-in memory are copied onto the card at one time. → step 3.

- [] → [IN]:

One picture at a time is copied from the card to the built-in memory. → step 2.

2 Press ◀/▶ to select the picture and then press ▼.

(Only when selecting [] → [IN])

3 Press ▲ to select [YES] and then press [MENU/SET].

(The illustration shows the screen when pictures are copied from the built-in memory to a card.)

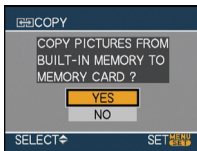

- The message [COPY THIS PICTURE TO BUILT-IN MEMORY?] appears when you copy pictures from the card to the built-in memory.
- If you press [MENU/SET] while copying pictures from the built-in memory to the card, the copying will stop halfway.

- Do not turn the camera off or perform any other operations before copying is finished. The data on the built-in memory or the card may be damaged or lost.

4 Press [MENU/SET] several times to close the menu.

- If you copy from the built-in memory to a card, all the pictures are copied and then the screen automatically returns to the playback screen.



- If you copy picture data from the built-in memory to a card which does not have sufficient free space, the picture data will only be copied halfway. We recommend using a card which has more free space than the built-in memory (about 27 MB).
- If a picture exists with the same name (folder number/file number) as the picture to be copied in the copy destination when [IN] → [] is selected, a new folder is created and the picture is copied. If a picture exists with the same name (folder number/file number) as the picture to be copied in the copy destination when [] → [IN] is selected, that picture is not copied.
- It may take time to copy the picture data.
- Only pictures recorded with a Panasonic digital camera (LUMIX) will be copied. (Even if the pictures were recorded with a Panasonic digital camera, you may not be able to copy them if they were edited with a PC.)
- DPOF settings on the original picture data will not be copied. Set the DPOF settings again after copying is finished. (P103)

[FORMAT]**Initializing the built-in memory or a card**

Press [MENU/SET] to display the [PLAY] mode menu and select the item to set. (P93)
Usually, it is not necessary to format the built-in memory and the card.
Format them when the message [BUILT-IN MEMORY ERROR] or [MEMORY CARD ERROR] appears.

Press ▲ to select [YES] and then press [MENU/SET].

(The illustration shows the screen when the built-in memory is formatted.)

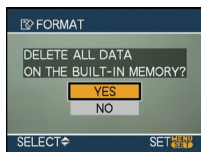

- When a card is not inserted, you can format the built-in memory. When a card is inserted, you can format the card.
- If you press [MENU/SET] while formatting the built-in memory, the formatting will stop halfway. (However, all the pictures will be deleted.)



- Formatting irretrievably deletes all the data including any protected pictures. Check the data carefully before formatting.
- If the card has been formatted on a PC or other equipment, format it on the camera again.
- Use a battery with sufficient battery power or the AC adaptor (DMW-AC7PP; optional) when formatting.
- Do not turn the camera off during formatting.
- It may take longer to format the built-in memory than the card. (Max. about 15 sec.)

- You cannot format an SD Memory Card or an SDHC Memory Card when the card's Write-Protect switch (A) is set to [LOCK].



- If the built-in memory or the card cannot be formatted, consult your nearest Service Center.

For USA assistance, please call: 1-800-272-7033
or send e-mail to : digitalstillcam@us.panasonic.com

For Canadian assistance, please call:
1-800-99-LUMIX (1-800-995-8649) or
send e-mail to: lumixconcierge@ca.panasonic.com

Connecting to a PC



You can acquire recorded pictures to a PC by connecting the camera and the PC. The software [LUMIX Simple Viewer] or [PHOTOfunSTUDIO-viewer-] (for Windows®) in the CD-ROM (supplied) allows you to easily acquire pictures recorded with the camera to a PC, print them and send them by e-mail.

If you use "Windows 98/98SE", install the USB driver and then connect it to the computer.

Read the separate operating instructions for the supplied software for more information about the software in the CD-ROM (supplied) and how to install it.

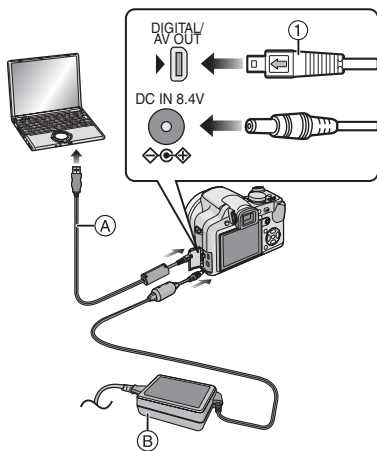

- (A) USB connection cable (supplied)
 (B) AC adaptor (DMW-AC7PP; optional)
- Use a battery with sufficient battery power or the AC adaptor (DMW-AC7PP; optional).
 - Turn the camera off before inserting or removing the cable for the AC adaptor (DMW-AC7PP; optional).

- Set the camera to a mode other than [] mode.

1 Turn on the camera and the PC.

2 Connect the camera to a PC via the USB connection cable (A) (supplied).

- Connect the USB connection cable with the [←] mark facing the [→] mark on the [DIGITAL] socket.
- Hold the USB connection cable at ① and insert straight in or take straight out. (If you forcibly insert the USB connection cable at a slant or upside down you can deform the connection terminals and damage the camera or the connected equipment.)

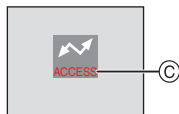

- © This message appears during data transfer.

[Windows]

The drive appears in the [My Computer] folder.

- If you are connecting the camera to a PC for the first time, the required driver is installed automatically so that the camera can be recognized by "Windows Plug and Play". The drive then appears on the [My Computer] folder.

[Macintosh]

The drive is displayed on the screen.

- The drive is displayed as [LUMIX] when you connect the camera with no card inserted.
- The drive is displayed as [NO_NAME] or [Untitled] when you connect the camera with a card inserted.

■ About motion picture playback on a PC

Use the software "QuickTime" in the CD-ROM (supplied) to play back motion pictures recorded on this camera on a PC.

- If you use “Windows 98/98SE/Me”, download “QuickTime 6.5.2 for Windows” from the following site, and install it. <http://www.apple.com/support/downloads/quicktime652forwindows.html>
- This software is installed as standard on a “Macintosh OS”.

Folder Composition

Folders are displayed as shown in the following illustration.

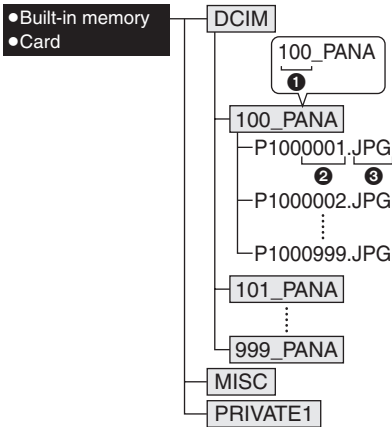

- ① Folder number
- ② File number
- ③ JPG: Pictures
- MOV: Motion pictures
- RAW: Pictures in RAW files
- MISC: DPOF print
Favorite
Category slide show
- PRIVATE1: Pictures recorded in
flip animation function

- The data for up to 999 pictures recorded by the camera can be included in 1 folder. If the number of pictures exceeds 999, another folder is created.
- To reset the file number or the folder number, select [NO.RESET] in the [SETUP] menu.

Conditions under which a different folder number is used

In the following cases, the picture is not recorded in the same folder as the previously recorded picture. It is recorded in a folder with a new number.

- ① When the folder just recorded to contains a picture file with the number 999 in it (example: P1000999.JPG).
- ② When the card just recorded to contains, for example, a folder with the number 100 [100_PANA] in it and that card is removed and replaced with a card that has a folder with the number 100 in it recorded by a camera from a different maker (100XXXXX, with XXXXX being the name of the maker) and then a picture is recorded.
- ③ When recording after selecting [NO.RESET] from the [SETUP] menu. (Pictures will be recorded to a new folder with a number sequential to the folder recorded to immediately before. By using [NO.RESET] on a card that does not contain folders or pictures, such as one just formatted, the folder number can be reset to 100.)

About the PTP connection



If the OS is “Windows XP”, “Windows Vista” or “Mac OS X”, you can connect in PTP mode if you set the camera to [] mode and then connect to your PC.

- Pictures can only be read on the camera. They cannot be written to a card or deleted.
- When there are 1000 or more pictures on a card, the pictures may not be imported.



- Do not use any other USB connection cables except the supplied one.
- Do not disconnect the USB connection cable while [ACCESS] is displayed.
- When there are many pictures on the built-in memory or the card, it may take some time to transfer them.
- You may not be able to play back motion pictures on the built-in memory or the card

correctly when the camera is connected to a PC. Import the motion picture files to the PC and then play them back.

- If battery power is exhausted while the camera and the PC are communicating, the recorded data may be damaged. When you connect the camera to the PC, use a battery with sufficient battery power or the AC adaptor (DMW-AC7PP; optional).
- If the remaining battery power becomes low while the camera and the PC are communicating, the alarm beeps. In this case, stop the communication at once on the PC.
- **When connecting the camera to a "Windows 2000" OS PC with the USB connection cable, do not replace the card while the camera and the PC are connected. The information on the card may be damaged. Use "Safely Remove Hardware" in the task tray on your PC when replacing the card.**
- Pictures edited or rotated with a PC may be displayed in black in playback mode, multi playback and calendar playback.
- Read the operating instructions for the PC.
- If a card is not inserted when the camera is connected to the PC, you can edit or access the pictures on the built-in memory. If a card is inserted, you can edit or access the pictures on it.
- You cannot switch between the built-in memory and the card while the camera is connected to the PC. When you want to switch between the built-in memory and the card, disconnect the USB connection cable, insert (or remove) the card and then connect the USB connection cable to the PC again.
- The message [PLEASE RE-CONNECT THE PRINTER.] appears if you change the mode dial to print mode [] while this unit is connected to a PC. If connecting the printer again, change the mode to a mode other than [] and then check that no data is being transferred. ([ACCESS] appears on the LCD monitor of this unit while data is being transferred.)

Printing the Pictures



By connecting the camera directly to a printer supporting PictBridge via the USB connection cable (supplied), you can select the pictures to print and start printing on the camera's screen.

Set print settings such as the print quality on the printer beforehand. (Read the printer operating instructions.)

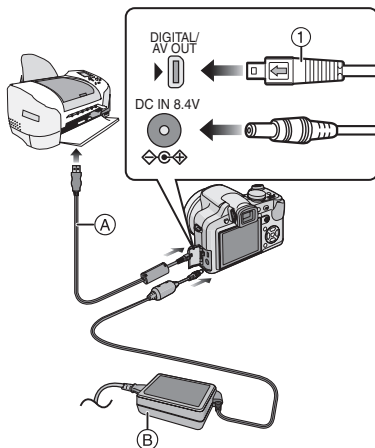

- Ⓐ USB connection cable (supplied)
- Ⓑ AC adaptor (DMW-AC7PP; optional)
- It may take time to print some pictures. Use a battery with sufficient battery power or the AC adaptor (DMW-AC7PP; optional) when you connect to a printer.
- Turn the camera off before inserting or removing the cable for the AC adaptor (DMW-AC7PP; optional).

1 Turn on the camera and the printer.

2 Set the mode dial to [].

3 Connect the camera to a printer via the USB connection cable Ⓐ (supplied).

- Connect the USB connection cable with the [◀] mark facing the [▶] mark on the [DIGITAL] socket.
- Hold the USB connection cable at ① and insert straight in or take straight out.



- If the mode dial is not set to [] when the camera is connected to the printer, disconnect the USB connection cable, set the mode dial to [] and then connect the USB connection cable again. (Depending on the printer, it may be necessary to turn it off and then on again.)
- Do not use any other USB connection cables except the supplied one.
- If a card is not inserted when the camera is connected to the printer, you can access the picture data on the built-in memory. If a card is inserted, you can access the picture data on it.
- You cannot switch between the built-in memory and the card while the camera is connected to the printer. When you want to switch between the built-in memory and the card, disconnect the USB connection cable, insert (or remove) the card and then connect the USB connection cable to the printer again.
- If you want to print the age in [BABY1]/[BABY2] or [PET] in scene mode or the number of days that have been passed since the departure date in [TRAVEL DATE], use the software [LUMIX Simple Viewer] or [PHOTOfunSTUDIO-viewer-] in the CD-ROM (supplied) and print from the PC. To print the name of [BABY1]/[BABY2] or [PET] or text (comments) which has been entered using [TITLE EDIT], use [PHOTOfunSTUDIO-viewer-]. For details, refer to the operating instructions (PDF file) of the software.
- To find out more about PictBridge compliant printers, contact your local dealer.

■ Selecting a single picture and printing it

- 1 Press ◀▶ to select the picture and then press [MENU/SET].

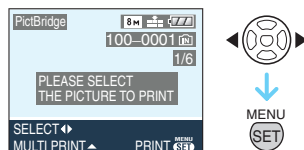

- The message disappears in about 2 seconds.

- 2 Press ▲ to select [PRINT START] and then press [MENU/SET].

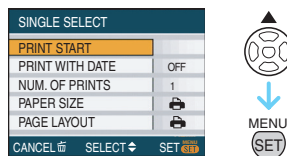

- Press [MENU/SET] to cancel printing halfway.

3 Disconnect the USB connection cable after printing.

■ Selecting multiple pictures and printing them

- 1 Press ▲.

- 2 Press ▲/▼ to select an item and then press [MENU/SET].

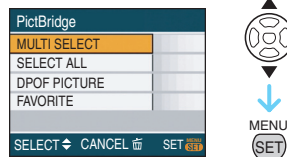

[MULTI SELECT]	Multiple pictures are printed at one time. • After selecting [MULTI SELECT], press ◀/▶ to select the pictures to print and then press ▼. The icon [] appears on the pictures to be printed. (Press ▼ again to cancel the setting.) Press [MENU/SET] after finishing the setting.
[SELECT ALL]	Prints all the stored pictures.
[DPOF PICTURE]	Prints the pictures set in [DPOF] only.
[FAVORITE]*	Prints the pictures set as favorites only.

* This only appears when [FAVORITE] is set to [ON]. (However if none of the pictures have [★] displayed, you cannot select it even if [FAVORITE] is set to [ON].)

3 Press ▲ to select [PRINT START] and then press [MENU/SET].

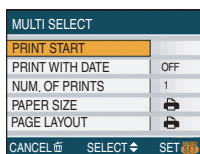

- [PRINT WITH DATE] and [NUM. OF PRINTS] are not displayed when [DPOF PICTURE] is set.
- The [DPOF SET] is displayed when [DPOF PICTURE] is selected. If you selected [DPOF SET], refer to P103 and set them.
- Press [MENU/SET] to cancel printing.

- When you select [MULTI SELECT], [SELECT ALL] or [FAVORITE], a print confirmation screen appears. Select [YES] and print the pictures.
- The message [PRINTING ## PICTURE(S) DO YOU WANT TO PROCEED ?] appears on the print confirmation screen if the number of prints is more than 1000.

4 Disconnect the USB connection cable after printing.

■ Setting date printing, the number of prints, the paper size and the page layout

Select and set each item in step 3.

- When you want to print pictures in a paper size or a layout which is not supported by the camera, set [PAPER SIZE] or [PAGE LAYOUT] to [] and then set the paper size or the layout on the printer. (For details, refer to the operating instructions of the printer.)

• [PRINT WITH DATE]

[OFF]	Date is not printed.
[ON]	Date is printed.

- If the printer does not support date printing, the date cannot be printed on the picture.

• [NUM. OF PRINTS]

Set the number of prints.

- You can set up to 999 prints.

• [PAPER SIZE]

(Paper sizes that can be set with this unit)

The paper sizes are displayed on pages 1/2 and 2/2. Press ▼ to select.





1/2	
	Settings on the printer are prioritized.
[L/3.5"×5"]	89 mm×127 mm
[2L/5"×7"]	127 mm×178 mm
[POSTCARD]	100 mm×148 mm
[A4]	210 mm×297 mm

2/2*	
[CARD SIZE]	54 mm×85.6 mm
[10×15cm]	100 mm×150 mm
[4"×6"]	101.6 mm×152.4 mm
[8"×10"]	203.2 mm×254 mm
[LETTER]	216 mm×279.4 mm

* These items cannot be displayed when the printer does not support the paper sizes.

• [PAGE LAYOUT]

(Layouts for printing that can be set with this unit)

	Settings on the printer are prioritized.
	1 picture with no frame on 1 page
	1 picture with a frame on 1 page
	2 pictures on 1 page
	4 pictures on 1 page

• An item cannot be selected if the printer does not support the page layout.

■ Setting the date printing with the DPOF print in advance

We recommend setting DPOF date printing with [DPOF PRINT] (P104) in advance when the printer supports it. If you select [DPOF PICTURE], printing starts and the recording date is printed.

■ Layout printing





• When printing a picture several times on 1 sheet of paper

For example, if you want to print the same picture 4 times on 1 sheet of paper, set [PAGE LAYOUT] to  and then set [NUM. OF PRINTS] to 4 for the picture that you want to print.

• When printing different pictures on 1 sheet of paper

For example, if you want to print 4 different pictures on 1 sheet of paper, set [PAGE LAYOUT] to  and then set [COUNT] in [DPOF PRINT] (P103) to 1 for each of the 4 pictures.



- Do not disconnect the USB connection cable when the cable disconnection warning icon  is displayed. (Depending on the printer, the icon may not be displayed.)
- If the remaining battery power becomes low while the camera and the printer are connected, the alarm beeps. If this happens during printing, press [MENU/SET] and stop printing at once. If not printing, disconnect the USB connection cable.
- The camera is receiving an error message from the printer when the  indication lights orange during printing. After finishing printing, make sure there are no problems with the printer.
- If the total number of DPOF prints or the number of DPOF pictures printed is high, pictures may be printed several times. The remaining number of prints indicated may differ from the number set. This is not a malfunction.
- With date printing, the setting on the printer may take priority over the setting on the camera. Check the date print setting on the printer also.
- The message [USB MODE CHANGED. PLEASE REMOVE THE USB CABLE.] appears if you change the mode dial to a mode other than  while the camera and the printer are connected. Set the mode dial to  again and then disconnect the USB connection cable. If this happens during printing, stop printing and then disconnect the USB connection cable.
- When the pictures in RAW files are to be printed, the JPEG pictures recorded simultaneously by the camera will be printed. If JPEG pictures do not exit, RAW file pictures cannot be printed.

Playing Back Pictures on a TV Screen



■ Playing back pictures using the AV cable (supplied)

- Set the [TV ASPECT].
- Turn this unit and the TV off.

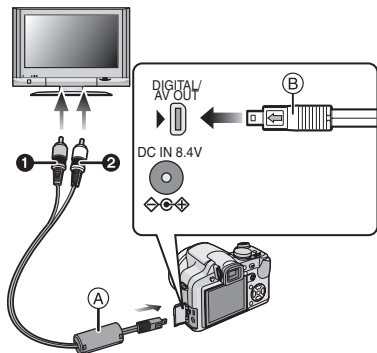

1 Connect the AV cable (A) (supplied) to the [AV OUT] socket on the camera.

- Connect the AV cable with the [←] mark facing the [▶] mark on the [AV OUT] socket.
- Hold the AV cable at (B) and insert straight in or take straight out.

2 Connect the AV cable to the video input and the audio input sockets on the TV.

- ① Yellow: to the video input socket
- ② White: to the audio input socket

3 Turn the TV on and select external input.

4 Turn the camera on.



- Depending on the aspect setting, black bands may be displayed on the top and bottom or the left and right of the pictures.
- Do not use any other AV cables except the supplied one.
- Audio playback is monaural.
- Read the operating instructions for the TV.
- When you play back a picture vertically, it may be blurry.
- You can view pictures on TVs in other countries (regions) which use the NTSC or PAL system when you set [VIDEO OUT] in the [SETUP] menu.
- Even if you set [VIDEO OUT] to [PAL], the output signal will still be NTSC in the recording mode.

■ Playing back pictures on a TV with an SD Memory Card slot

Still pictures recorded on an SD Memory Card can be played back on a TV with an SD Memory Card slot.



- Depending on the TV model, pictures may not be displayed on the full screen.
- Motion pictures cannot be played back. To play back motion pictures, connect the camera to the TV with the AV cable (supplied).
- You may not be able to play back MultiMediaCards.

Using the MC Protector/ND Filter

The MC protector (DMW-LMC46; optional) is a transparent filter which affects neither the colors nor the amount of light, so it can always be used to protect the camera's lens.

The ND filter (DMW-LND46; optional) reduces the amount of light to approximately 1/8th (equal to adjusting the aperture value 3 increments) without affecting the color balance.

Close the flash, turn on the digital camera, rotate the zoom lever to Tele and then attach the MC protector/ND filter with the lens barrel on the digital camera extended. When attaching or removing the MC protector/ND filter, hold the ring at the end of the lens barrel with your hand so it does not rotate and then rotate the MC protector/ND filter slowly and surely to attach or remove it.

Attach the MC protector ① or ND filter ② with the lens extended.

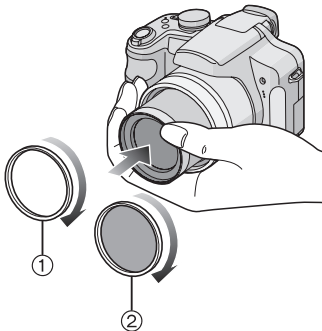

- Do not attach the MC protector and ND filter at the same time.
- If the MC protector/ND filter are tightened too much, you may not be able to remove them. Do not tighten them too much.

- If the MC protector/ND filter are dropped, they may be destroyed. Be careful not to drop them when attaching them to the camera.
- Be careful not to get a fingerprint, dirt, etc. on the MC protector or ND filter when it is attached, otherwise the focus may be adjusted to the lens, resulting in the subject being out of focus.
- MC="Multi-coated"
ND="Neutral Density"

Screen Display

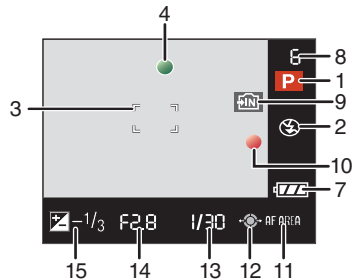
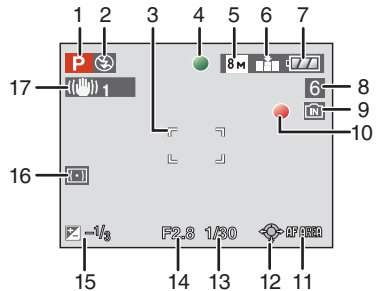

In recording

Recording in program AE mode [P] (Initial setting)

- 1 Recording mode
- 2 Flash mode (P40)
- 3 AF area (P25)
- 4 Focus (P25)
- 5 Picture size (P76)

- 6 Quality (P76)
In Motion picture mode (P65)
: Jitter alert (P27)
- 7 Battery indication (P24)
- 8 Number of recordable pictures (P130)
Available recording time
(P65):
- 9 Built-in memory (P16, 23)
: Card (P16, 23)
- 10 Recording state
- 11 AF area selection (P80)
MF operation (P52)
- 12 Joystick operation (P27, 33, 50, 51)
- 13 Shutter speed (P25)
: Intelligent ISO (P74)
- 14 Aperture value (P25)
- 15 Exposure compensation (P45)
- 16 Metering mode (P78)
- 17 Optical image stabilizer (P81)

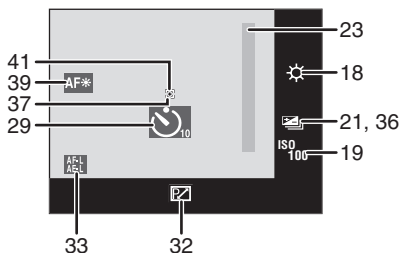
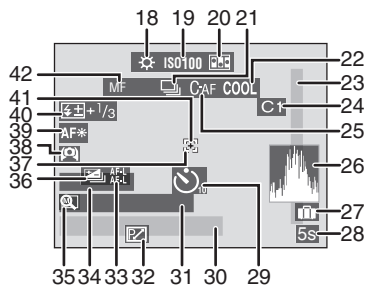

In recording (after settings)

- 18 White balance (P72)
White balance fine adjustment (P73)
- 19 ISO sensitivity (P75)
: Maximum ISO sensitivity level (P74)
- 20 Flip animation (P84)
- 21 Burst (P47)
: Audio recording (P65, 77)
- 22 Color effect mode (P83)
- 23 Focus range (P52)
- 24 Custom setting (P55)
- 25 Continuous AF (P82)
- 26 Histogram (P38)
- 27 Travel date (P67)
- 28 Elapsed recording time (P65)
- 29 Self-timer mode (P44)
- 30 Current date and time/
Travel destination setting (P69):
- This is displayed for about 5 seconds when the camera is turned on, after setting the clock and after switching from playback mode to recording mode.
- Zoom (P30)/Extended optical zoom (P31)/Digital zoom (P31):
- Operation for backlight compensation (P29):
- 31 Age (P61)
•This is displayed for about 5 seconds when this unit is turned on in [BABY1]/[BABY2] or [PET] in scene mode.
- 32 Program shift (P27)
- 33 AF/AE lock (P83)
- 34 Number of days that have passed since the travel date (P67)
Name (P61)
•This is displayed for about 5 seconds when this unit is turned on in [BABY1]/[BABY2] or [PET] in scene mode.

- 35 Zoom resume (P30)
: Conversion lens (P86)
: Backlight compensation (P29)
- 36 Auto bracket (P46)
- 37 Spot AF area (P78)
- 38 High angle mode (P39)
: Auto power LCD mode (P39)
: Power LCD mode (P39)
- 39 AF assist lamp (P82)
: Tele macro (P49)
- 40 Flash output adjustment (P43)
- 41 Spot metering target (P78)
- 42 MF (P52)
: AF macro (P48)

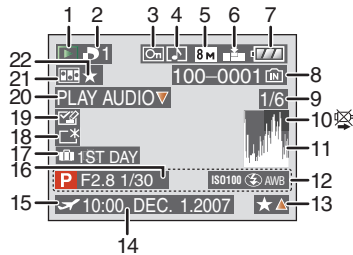

In playback

- 1 Playback mode (P33)
- 2 Number of DPOF prints (P103)
- 3 Protected picture (P104)
- 4 Picture with audio/Motion pictures (P91)
- 5 Picture size (P76)
- 6 Quality (P76)
 In Motion picture mode (P91)

30FPS	VGA	10FPS	VGA	30FPS	QVGA	10FPS	QVGA	(4:3)
30FPS	16:9	10FPS	16:9					(16:9)
- 7 Battery indication (P24)
- 8 Folder/File number (P112)
 Built-in memory (P16)
: Card (P16)
- 9 Picture number/Total pictures

- 10 Cable disconnection warning icon (P116)
 Motion picture recording time (P91): **8m30s**
- 11 Histogram (P38)
- 12 Recording information
- 13 Favorites settings (P98)
 Elapsed playback time (P91): **8m30s**
- 14 Recorded date and time
 Name (P61)
 Title (P99)
- 15 Travel destination setting (P69)
- 16 Age (P61)
- 17 Number of days that have passed since the travel date (P67)
- 18 Power LCD mode (P39)
- 19 Title edit completed display (P99)
- 20 Audio playback (P91)
 Motion picture mode (P91):
PLAY MOTION
PICTURE
- 21 Flip animation (P84)
: Stamped with text indication (P101)
- 22 Favorites (P98)

Cautions for Use

■ Optimal use of the camera

Take care not to drop or knock the unit or put a lot of pressure on it.

- Take care not to knock or drop the bag/case that you inserted the camera in as the shock may cause damage to the camera, lens or LCD monitor.
- Do not use a paper bag as it can easily rip causing the camera to fall and be damaged.
- We strongly recommend you purchase a good camera bag/case from your local dealer to protect your camera.

Keep the camera as far away as possible from electromagnetic equipment (such as microwave ovens, TVs, video games etc.).

- If you use the camera on top of or near a TV, the pictures and sound on the camera may be disrupted by electromagnetic wave radiation.
- Do not use the camera near cell phones because doing so may result in noise adversely affecting the pictures and sound.
- Recorded data may be damaged, or pictures may be distorted, by strong magnetic fields created by speakers or large motors.
- Electromagnetic wave radiation generated by microprocessors may adversely affect the camera, disturbing the pictures and sound.
- If the camera is adversely affected by electromagnetic equipment and stops functioning properly, turn the camera off and remove the battery or disconnect AC adaptor (DMW-AC7PP; optional). Then reinsert the battery or reconnect AC adaptor and turn the camera on.

Do not use the camera near radio transmitters or high-voltage lines.

- If you record near radio transmitters or high-voltage lines, the recorded pictures and sound may be adversely affected.

**Always use the supplied cords and cables. If you use optional accessories, use the cords and the cables supplied with them.
Do not extend the cords or the cables.**

Do not spray the camera with insecticides or volatile chemicals.

- If the camera is sprayed with such chemicals, the body of the camera may be damaged and the surface finish may peel off.
- Do not keep rubber or plastic products in contact with the camera for a long period of time.

Do not use benzine, thinner or alcohol for cleaning the camera.

- Before cleaning the camera, remove the battery or disconnect the AC adaptor (DMW-AC7PP; optional) from the electrical outlet.
- The body of the camera may be damaged and the surface finish may peel off.
- Wipe the camera with a soft, dry cloth.
- Do not use kitchen detergent or a chemically treated cloth.

■ About the LCD monitor/Viewfinder

- **Do not press the LCD monitor with excessive force. Uneven colors may appear on the LCD monitor and it may malfunction.**
- If the camera is cold when you turn it on, the picture on the LCD monitor/Viewfinder will be slightly darker than usual at first. However, the picture will return to normal brightness when the internal temperature of the camera increases.

Extremely high precision technology is employed to produce the LCD monitor/Viewfinder screen. However there may be some dark or bright spots (red, blue or green) on the screen. This is not a malfunction. The LCD monitor/Viewfinder screen has more than 99.99% effective pixels with a mere 0.01% of the pixels inactive or always lit. The spots will not be recorded on pictures on the built-in memory or a card.

■ About the Lens

- Do not press the lens with excessive force.
- Do not leave the camera with the lens facing the sun as rays of light from the sun may cause it to malfunction. Also, be careful when placing the camera outside or near a window.
- When there is dirt (water, oil, and fingerprints, etc.) on the surface of the lens, the picture may be affected. Lightly wipe the surface of the lens with a soft, dry cloth before and after taking pictures.

■ Battery

The battery is a rechargeable lithium ion battery. Its ability to generate power comes from the chemical reaction that takes place inside it. This reaction is susceptible to the surrounding temperature and humidity. If the temperature is too high or too low, the operating time of the battery will become shorter.

Always remove the battery after use.

If you drop the battery accidentally, check to see if the body of the battery and the terminals are damaged.

- Inserting a damaged battery in the camera will damage the camera.

Bring charged spare batteries when going out.

- Be aware that the operating time of the battery becomes shorter in low temperature conditions such as at a ski resort.
- When you travel, do not forget to bring the battery charger (supplied) so that you can charge the battery in the country that you are travelling in.

Dispose of unusable battery.

- The battery has a limited life.
- Do not throw the battery into fire because it may cause an explosion.
- The unusable battery should be discarded in accordance with battery recycling laws. Call the RBRC hotline at 1-800-822-8837 for information.

Do not allow battery terminals to come into contact with metal objects (such as necklaces, hairpins etc.).

- This can cause short circuiting or heat generation and you may be badly burned if you touch a battery.

■ Charger

- If you use the battery charger near a radio, the radio reception may be disturbed.
- Keep the charger 1 m (3.28 feet) or more away from radios.

- The charger may generate whirring sounds when it is being used. This is not a malfunction.
- After use, be sure to disconnect the power supply device from the electrical outlet. (A very small amount of current is consumed if it is left connected.)
- Keep the terminals of the charger clean.

■ Card

Do not leave the card where the temperature is high, where electromagnetic waves or static electricity are easily generated or exposed to direct sunlight.

Do not bend or drop the card.

- The card may be damaged or the recorded content may be damaged or deleted.
- Put the card in the card case or the storage bag after use and when storing or carrying the card.
- Do not allow dirt, dust or water to get into the terminals on the back of the card and do not touch the terminals with your fingers.

■ When not using the camera for a long period of time

- Store the battery in a cool and dry place with a relatively stable temperature. [Recommended temperature: 15 °C to 25 °C (59 °F to 77 °F), Recommended humidity: 40% to 60%]
- Always remove the battery and the card from the camera.
- If the battery is left inserted in the camera, it will discharge even if the camera is turned off. If the battery continues to be left in the camera, it will discharge excessively and may become unusable even if charged.
- When storing the battery for a long period of time, we recommend charging it once a year. Remove the battery from the camera and store it again after it has completely discharged.
- We recommend storing the camera with a desiccant (silica gel) when you keep it in a closet or a cabinet.

■ About the picture data

- Recorded data may be damaged or lost if the camera breaks down due to inappropriate handling. Panasonic will not be liable for any damage suffered due to loss of recorded data.

■ About tripods

- When you use a tripod, make sure the tripod is stable when this unit is attached to it.
- You may not be able to remove the card or the battery when using a tripod.
- Make sure that the screw on the tripod is not at an angle when attaching or detaching the camera. You may damage the screw on the camera if you use excessive force when turning it. Also, the camera body and the rating label may be damaged or scratched if the camera is attached too tightly to the tripod.
- Read the operating instructions for the tripod carefully.

Message Display

Confirmation messages or error messages will be displayed on the screen in some cases.

The major messages are described below as examples.

[THIS MEMORY CARD IS LOCKED]

The Write-Protect switch on the SD Memory Card and the SDHC Memory Card are moved to [LOCK]. Move the switch back to unlock it. (P16, 105, 110)

[NO VALID PICTURE TO PLAY]

Record a picture or insert a card with a recorded picture and then play it.

[THIS PICTURE IS PROTECTED]

Delete or overwrite the picture after canceling the protect setting. (P104)

**[THIS PICTURE CANNOT BE DELETED]/
[SOME PICTURES CANNOT BE DELETED]**

Pictures not based on the DCF standard cannot be deleted. If you want to delete

some pictures, format the card after saving necessary data on a PC etc. (P110)

[NO ADDITIONAL DELETE SELECTIONS CAN BE MADE]

You have exceeded the number of pictures that can be set at one time with [MULTI DELETE] (P34) or [MULTI] in [TEXT STAMP] (P101)/[TITLE EDIT] (P99). Either delete the picture or stamp the entered text or dates onto the picture, then retry the operation.

More than 999 favorites have been set.

[CANNOT BE SET ON THIS PICTURE]

[TITLE EDIT], [TEXT STAMP] or DPOF cannot be set for pictures not based on the DCF standard.

[NOT ENOUGH SPACE ON BUILT-IN MEMORY]/[NOT ENOUGH MEMORY ON THE CARD]

There is no space left on the built-in memory or the card.

- When you copy pictures from the built-in memory to the card (batch copy), the pictures are copied until the capacity of the card becomes full.

[SOME PICTURES CANNOT BE COPIED]/[COPY COULD NOT BE COMPLETED]

The following pictures cannot be copied.

- When a picture with the same name as the picture to be copied exists in the copy destination.

(Only when copying from a card to the built-in memory.)

- Files not based on the DCF standard. Moreover, pictures recorded or edited by other equipment may not be copied.

**[BUILT-IN MEMORY ERROR
FORMAT BUILT-IN MEMORY?]**

This message will be displayed when you formatted the built-in memory on a PC. Format the built-in memory on the camera again. (P110) The data on the built-in memory will be deleted.

**[MEMORY CARD ERROR
FORMAT THIS CARD?]**

The card format cannot be recognized by the camera. Format the card again with the camera after saving necessary data on a PC etc. (P110)

**[PLEASE TURN CAMERA OFF AND
THEN ON AGAIN]**

This message appears when the camera did not operate properly because force was applied to the lens by a hand or other object, or the hood adaptor is not securely attached. Turn the camera off and on. If the message is still displayed, contact the dealer or your nearest Service Center.

[MEMORY CARD PARAMETER ERROR]

Use a card compatible with this unit. (P5, 16)

- You can only use an SDHC Memory Card if using cards with 4 GB or more capacity.

**[MEMORY CARD ERROR
PLEASE CHECK THE CARD]**

- An error has occurred accessing the card. Insert the card again.

[READ ERROR]**[PLEASE CHECK THE CARD]**

An error has occurred reading the data. Insert the card again. Make sure the card is inserted properly and then play back again.

[WRITE ERROR]**[PLEASE CHECK THE CARD]**

An error has occurred writing the data. Turn the camera off and remove the card. Insert the card again and turn the camera on. Make sure the camera is turned off before removing or inserting the card to avoid damage.

**[MOTION RECORDING WAS
CANCELLED DUE TO THE LIMITATION
OF THE WRITING SPEED OF THE
CARD]**

- When you set the picture quality to [30fpsVGA] or [30fps16:9], we recommend using a High Speed SD Memory Card with "10MB/s" or greater displayed on the package.

- Depending on the type of SD Memory Card or SDHC Memory Card, motion picture recording may stop in the middle.

[A FOLDER CANNOT BE CREATED]

A folder cannot be created because there are no remaining folder numbers that can be used. (P112)



Format the card after saving necessary data on a PC etc. (P110)

If you execute [NO.RESET] in the [SETUP] menu after formatting, the folder number is reset to 100. (P22)

**[PICTURE IS DISPLAYED FOR 4:3 TV/
PICTURE IS DISPLAYED FOR 16:9 TV]**

- The AV cable is connected to the camera. Press [MENU/SET] if you want to delete this message at once.
- Select [TV ASPECT] in the [SETUP] menu if you want to change the TV aspect. (P23)
- This message also appears when the USB connection cable is connected to the camera only. In this case, connect the other end of the USB connection cable to a PC or a printer. (P111, 113)

[PLEASE RE-CONNECT THE PRINTER.]

This message will be displayed if you change the mode dial to print mode [], while this unit is connected to a PC. If connecting the printer again, change the mode to a mode other than [] and then check that no data is being transferred. ([ACCESS] appears on the LCD monitor while data is being transferred.)

**[USB MODE CHANGED. PLEASE
REMOVE THE USB CABLE.]**

This message will be displayed if you change the mode dial to a mode other than print mode [] while this unit and the printer are connected.

Set the mode dial to [] again and then disconnect the USB connection cable. If printing, stop the printing and then disconnect the USB connection cable.

**[PRINTER BUSY]/[PLEASE CHECK THE
PRINTER]**

The printer cannot print. Check the printer.

Troubleshooting

If you return the menu settings to the initial settings at the time of purchase, the condition may improve.

Select [RESET] in the [SETUP] menu. (P22)

■ Battery and power source

1: The camera cannot be operated even when it is turned on.

- Is the battery inserted correctly?
 - Check the direction of the battery. (P15)
- Is the battery sufficiently charged?
 - Use a battery that has been sufficiently charged.

2: The LCD monitor turns off while the camera is turned on.

- Does the picture appear on the Viewfinder?
 - Press [EVF/LCD] to switch to LCD monitor display.
- Is power save mode (P21) activated?
 - Press the shutter button halfway to cancel these modes.
- Is the battery exhausted?
 - Use a battery that has been sufficiently charged.

3: The camera turns off immediately after it is turned on.

- Is the battery charge insufficient to operate the camera?
 - Use a battery that has been sufficiently charged.
 - If you leave the camera on, the battery will be exhausted. Turn the camera off frequently by using power save mode (P21) etc.

■ Recording

1: The picture cannot be recorded.

- Is the mode dial correctly set?
- Is there any memory remaining on the built-in memory or the card?
 - Before recording, delete some pictures. (P33)

2: The recorded picture is whitish. The lens is dirty

- The picture can become whitish if there is dirt e.g. fingerprints on the lens. If the lens is dirty, turn the camera off, retract the lens barrel (P10) and gently wipe the lens surface with a soft dry cloth.

3: The recorded picture is too bright or dark.

- Check that the exposure is correctly compensated. (P45)

4: 2 or 3 pictures are taken at one time.

- Is auto bracket (P46) or burst mode (P47) set?
- Is the self-timer set to [10S/3PICTURES]? (P44)

5: The subject is not focused properly.

- The focus range varies depending on the recording mode. Rotate the mode dial to set the proper mode for the distance to the subject.
- Is the subject beyond the focus range of the camera? (P25, 29, 49)
- Have you taken a picture with jitter?
- Did you take the picture after pressing the shutter button halfway? The subject is not focused until the shutter button is pressed halfway. (However, this excludes intelligent auto mode [iA].)

6: The recorded picture is blurred. The optical image stabilizer is not effective.

- The shutter speed will become slower and the optical image stabilizer function may not work properly when taking pictures especially in dark places. In this case, we recommend holding the camera firmly with both hands when taking pictures. (P25) We recommend using a tripod and the self-timer (P44) when taking pictures with a slow shutter speed.

7: The recorded picture looks rough. Noise appears on the picture.

- Is the ISO sensitivity high or the shutter speed slow?
(ISO sensitivity is set to [AUTO] when the camera is shipped. Therefore, when taking pictures indoors etc. the ISO sensitivity increases.)
– Decrease the ISO sensitivity. (P75)
– Increase the setting for [NOISE REDUCTION] in [PICT.ADJ.] or lower the setting for each of the items other than [NOISE REDUCTION]. (P84)
- Take pictures in bright places.
- In [HIGH SENS.] (P61) in scene mode, the resolution of the recorded picture decreases slightly because of high sensitivity processing.
This is not a malfunction.

8: The brightness or the hue of the recorded picture is different from the actual scene.

- If recording under fluorescent light, the brightness or the hue may change slightly when the shutter speed becomes fast. This occurs due to the characteristics of fluorescent light. It is not a malfunction.

9: A reddish vertical line appears on the LCD monitor when the shutter button is pressed halfway or when recording motion pictures.

- This is a phenomenon called smear. It is a characteristic of CCD and appears when the subject has a bright part. Black or green vertical lines may also appear or uneven colors may appear around the smear. This is not a malfunction. It is recorded in motion pictures but is not recorded on still pictures.



10: When the shutter button is pressed halfway, the image becomes a still image for that instant.

- Is 3-area focusing (High speed) or 1-area focusing (High speed) selected as the AF mode? (P78)

11: Zoom does not work as usual.

- Is [CONVERSION] set to [] or []? (P86)

12: Motion picture recording stops in the middle.

- Are you using a MultiMediaCard?
– This unit does not support MultiMediaCards.
- When you set the picture quality to [30fpsVGA] or [30fps16:9], we recommend using a High Speed SD Memory Card with “10MB/s” or greater displayed on the package.
- Depending on the type of the card, recording may stop in the middle.

■ LCD monitor/Viewfinder

1: The LCD monitor/Viewfinder becomes darker or brighter for a moment.

- This phenomenon appears when you press the shutter button halfway to set the aperture value and does not affect the recorded pictures.

2: The LCD monitor flickers indoors.

- The LCD monitor may flicker for a few seconds after turning the camera on indoors under fluorescent light.
This is not a malfunction.

3: The LCD monitor/Viewfinder is too bright or dark.

- Adjust the brightness of the screen. (P21)
- Is the power LCD function or high angle mode activated?

4: The picture is not displayed on the LCD monitor.

- Does the picture appear on the Viewfinder?
– Press [EVF/LCD] button to switch to LCD monitor display.

5: Black, red, blue and green dots appear on the LCD monitor.

- These pixels do not affect the recorded pictures.
This is not a malfunction. (P121)

6: Noise appears on the LCD monitor.

- In dark places, noise may appear to maintain the brightness of the LCD monitor.
This does not affect the pictures you are recording.

7: Distortion in the LCD monitor.

- When holding the edge of the LCD monitor, there may be some distortion, however this is not a malfunction. Moreover, this has no effect on the pictures taken or playback.

■ Flash

1: The flash is not activated.

- Is the flash closed?
– Press the flash open button to open the flash. (P40)
- The flash is not activated in motion picture mode [H] or when the [SCENERY] mode, [NIGHT SCENERY], [ILLUMINATIONS] or [CREATIVE NIGHT SCENERY] in [NIGHT PORTRAIT] mode, or [SUNSET], [STARRY SKY], [FIREWORKS] or [AERIAL PHOTO] in scene mode are selected.

2: The flash is activated 2 times.

- When you select red-eye reduction (P40), the flash is activated once before the actual recording to reduce the red-eye phenomenon (eyes of the subject appearing red in the picture) and then activated again for the actual recording.

■ Playback

1: The picture being played back is rotated and displayed in an unexpected direction.

The camera has a function that automatically rotates the display of pictures recorded holding the camera vertically. (If you take pictures when aiming the camera up or down, the

camera may recognize that it is being held vertically.)

- You can display the pictures without being rotated when [ROTATE DISP.] (P97) is set to [OFF].
- You can rotate pictures with the [ROTATE] function. (P97)

2: The picture is not played back.

- Is the mode dial set to playback [▶]?
- Is there a picture on the built-in memory or the card?
The pictures on the built-in memory appears when a card is not inserted. The picture data on the card appears when a card is inserted. (P16)

3: The folder number and the file number are displayed as [—] and the screen turns black.

- Is the picture edited with a PC or recorded with a digital camera from another manufacturer?
This may also happen if the battery is removed immediately after recording or if recording with a exhausted battery.
– Format the data to delete the pictures mentioned above. (P110) (Formatting irretrievably deletes all data including the other pictures. Check the data carefully before formatting.)

4: The picture is displayed with a date different from the actual recording date in calendar playback.

- Was the picture edited with a PC or recorded with a digital camera from another manufacturer?
This kind of picture may be displayed with a date different from the actual recording date in calendar playback. (P89)
- Is the clock in the camera set properly? (P17)
For example, if the clock setting on the camera is different from the date and time set on the PC and you acquire pictures recorded with the camera to the PC and then write them back to the card, the pictures may be displayed with dates different from the actual recording dates in calendar playback etc.

5: White round spots like soap bubbles appear on the recorded picture.

- If you take a picture with the flash in a dark place or indoors, white orbs may appear in the picture because the flash reflects off particles of dust in the air. This is not a malfunction. This is identifiable from the number of round spots and their locations, which will differ in every picture.
- A characteristic of this is that the number of round spots and their position differ in every picture.



■ TV, PC and printer

1: The picture does not appear on the television.

- Is the camera connected to the TV correctly?
- Set the TV input to external input mode.

2: The display areas on the TV screen and the camera's LCD monitor are different.

Depending on the TV model, the area display may be smaller so the picture may be stretched horizontally or vertically and the top and bottom or left and right of the picture may be cut off when it is displayed. This is due to the TV specifications and is not a malfunction.

3: The motion pictures cannot be played back on a TV.

- Are you trying to play back the motion pictures by directly inserting the card in the card slot of the TV?
 - Connect the camera to the TV with the AV cable (supplied) and then play back the pictures on the camera. (P117)

4: The picture is not displayed fully on the TV.

- Set the aspect of the TV on the camera. (P23)

5: The picture cannot be transferred when the camera is connected to a PC.

- Is the camera connected to the PC correctly?
- Is the camera recognized by the PC correctly?

6: The card is not recognized by the PC.

- (The built-in memory is recognized.)
- Disconnect the USB connection cable. Connect it again while the card is inserted in the camera.

7: The picture cannot be printed when the camera is connected to a printer.



- Does the printer support PictBridge?
- Reset the mode to []. (P113)

8: The ends of the pictures are cut at printing.

- When using a printer with a trimming or borderless printing function, cancel this function before printing. (For details, refer to the operating instructions for the printer.)
- When you order photo studios to print pictures, ask the photo studio if the pictures can be printed with both ends.

■ Others

1: An unreadable language was selected by mistake.

- Press [MENU/SET], select the [SETUP] menu icon [] and then select the [] icon to set the desired language. (P23)

2: The camera will make sounds caused by internal mechanical movement when it is shaken.

- The sound arises when the lens moves. This is not a malfunction.

3: The setting for the auto review function is disabled.

- Are you taking pictures using auto bracket (P46)? Is the camera in burst mode (P47) or motion picture mode [] (P65)? Is [AUDIO REC.] set to [ON] (P77)?
 - In these cases, you cannot set the auto review function in the [SETUP] menu.

4: A red lamp sometimes turns on when the shutter button is pressed halfway.

- In dark places, the AF assist lamp (P82) lights red to make it easier to focus on a subject.

5: The AF assist lamp does not turn on.

- Is [AF ASSIST LAMP] on the [REC] mode menu set to [ON]? (P82)
- Are you taking pictures in dark places?
 - The AF assist lamp does not turn on in bright places.
- The AF assist lamp does not turn on when either [SCENERY] mode, [NIGHT SCENERY], [ILLUMINATIONS] or [CREATIVE NIGHT SCENERY] in [NIGHT PORTRAIT] mode, or [SUNSET], [PANNING], [FIREWORKS] or [AERIAL PHOTO] is selected in scene mode.

6: The camera becomes warm.

- The surface of the camera may become warm during use. This does not affect the performance or quality of the camera.

7: The lens clicks.

- When the brightness changes due to zoom or camera movement etc., the lens may click and the picture on the screen may drastically change. However, the picture is not affected. The sound is caused by the automatic adjustment of the aperture. This is not a malfunction.

8: The clock is reset.

- If you do not use the camera for a long time, the clock may be reset. When the message [PLEASE SET THE CLOCK] appears, set the clock again. (P17)
- When you take a picture before setting the clock, [0:00 0. 0. 0] is recorded.

9: The displayed picture is slightly distorted.

- Depending on the zoom magnification, the recorded picture is slightly distorted. This is called distortion aberration. The closer you get to the subject to take pictures of in wide angle, the more

distorted the picture you take is. However this is not a malfunction.

10: Colors appear on the picture which were not found in the actual scene.

- Depending on the zoom magnification, the picture may have some colored fringes around the subject. This is called chromatic aberration and may be more visible when recording distant subjects. However this is not a malfunction.

11: The file numbers are not recorded consecutively.

- When you perform an operation after taking a certain action, the pictures may be recorded in folders with different numbers from the ones used prior to the operation. (P112)

12: The file numbers are recorded in ascending order.

- If the battery is inserted or removed when the camera is not turned off, the recorded folder numbers are lost. However if you turn the camera on again and record pictures, the recorded folder numbers are different from the prior recorded folder numbers.

13: The picture is displayed in black.

- Pictures edited or rotated with a PC may be displayed in black in playback mode (P33), multi playback (P88) and calendar playback (P89).

14: The lens barrel is retracted.

- The lens barrel retracts about 15 seconds after switching from [REC] mode to [PLAY] mode.

15: The ring at the end of the lens barrel turns.

- This is constructed to turn when attaching or detaching a filter so that the lens is protected.





Number of Recordable Pictures and Available Recording Time





- The number of recordable pictures and the available recording time are an approximation. (These vary depending on the recording conditions and the type of card.)
- The number of recordable pictures and the available recording time varies depending on the subjects.

■ Number of recordable pictures (Still picture)

Aspect ratio		4:3					
Picture size		8M (8M): (3264×2448 pixels)				5M (5M EZ): (2560×1920 pixels)	
Quality		RAW	RAW+JPEG				
Built-in Memory (Approx. 27 MB)		1	1	6	13	10	21
Card	16 MB	0	0	2	6	5	10
	32 MB	1	1	6	14	11	23
	64 MB	3	3	14	30	24	48
	128 MB	7	6	30	61	50	99
	256 MB	14	12	61	120	98	190
	512 MB	27	24	120	240	195	380
	1 GB	56	50	240	480	390	770
	2 GB	110	100	490	970	790	1530
4 GB	220	200	970	1910	1560	3010	

Aspect ratio		4:3					
Picture size		3M (3M EZ): (2048×1536 pixels)		2M (2M EZ): (1600×1200 pixels)		0.3M (0.3M EZ): (640×480 pixels)	
Quality							
Built-in Memory (Approx. 27 MB)		16	32	26	52	130	210
Card	16 MB	8	16	13	27	68	110
	32 MB	18	36	29	58	145	230
	64 MB	38	75	61	120	290	480
	128 MB	78	150	125	240	600	970
	256 MB	150	290	240	470	1170	1900
	512 MB	300	590	480	940	2320	3770
	1 GB	600	1180	970	1880	4640	7550
	2 GB	1220	2360	1920	3610	8780	12290
4 GB	2410	4640	3770	7090	17240	24130	

Aspect ratio		3:2					
Picture size		7M (7M): (3264×2176 pixels)				4.5M (4.5M EZ): (2560×1712 pixels)	
Quality		RAW	RAW+ JPEG				
Built-in Memory (Approx. 27 MB)		1	1	7	14	11	23
Card	16 MB	0	0	3	7	5	12
	32 MB	1	1	7	16	13	26
	64 MB	3	3	16	33	27	54
	128 MB	8	7	34	69	56	110
	256 MB	15	14	68	135	110	210
	512 MB	31	28	135	260	210	430
	1 GB	62	56	270	530	440	860
	2 GB	125	110	550	1070	890	1700
4 GB	250	220	1080	2110	1740	3350	

Aspect ratio		3:2		16:9			
Picture size		2.5M (2.5M EZ): (2048×1360 pixels)		6M (6M): (3264×1840 pixels)			
Quality				RAW	RAW+ JPEG		
Built-in Memory (Approx. 27 MB)		18	36	2	1	8	17
Card	16 MB	9	18	1	0	4	8
	32 MB	20	40	2	1	9	19
	64 MB	43	83	4	4	20	40
	128 MB	88	165	9	8	41	81
	256 MB	170	330	18	16	81	155
	512 MB	340	650	36	33	160	310
	1 GB	680	1310	73	66	320	630
	2 GB	1360	2560	150	130	650	1270
4 GB	2680	5020	290	260	1280	2510	

Aspect ratio		16:9			
Picture size		35M (3.5M EZ): (2560×1440 pixels)		2M (2M EZ): (1920×1080 pixels)	
Quality					
Built-in Memory (Approx. 27 MB)		14	28	25	48
Card	16 MB	7	14	12	25
	32 MB	15	31	27	53
	64 MB	32	64	57	105
	128 MB	66	130	115	220
	256 MB	130	250	230	430
	512 MB	250	510	450	860
	1 GB	520	1020	910	1720
	2 GB	1040	2040	1800	3410
	4 GB	2040	4020	3540	6700

■ Available recording time (when recording motion pictures)

Aspect ratio		4:3				16:9	
Picture quality setting		30fps VGA	10fps VGA	30fps QVGA	10fps QVGA	30fps 16:9	10fps 16:9
Built-in Memory (Approx. 27 MB)		–	–	53 s	2 min 40 s	–	–
Card	16 MB	6 s	26 s	26 s	1 min 22 s	5 s	22 s
	32 MB	17 s	58 s	59 s	2 min 55 s	14 s	50 s
	64 MB	39 s	2 min	2 min	6 min	33 s	1 min 45 s
	128 MB	1 min 23 s	4 min 10 s	4 min 10 s	12 min 20 s	1 min 11 s	3 min 35 s
	256 MB	2 min 45 s	8 min 10 s	8 min 10 s	24 min	2 min 20 s	7 min
	512 MB	5 min 30 s	16 min 20 s	16 min 20 s	47 min 50 s	4 min 40 s	14 min
	1 GB	11 min	32 min 50 s	32 min 50 s	1 h 35 min	9 min 20 s	28 min 10 s
	2 GB	22 min 30 s	1 h 7 min	1 h 7 min	3 h 15 min	19 min 20 s	57 min 30 s
	4 GB*	44 min 20 s	2 h 11 min	2 h 11 min	6 h 22 min	38 min	1 h 53 min

- * Motion pictures can be recorded continuously up to 2 GB.
The maximum available recording time for up to 2 GB only is displayed on the screen.



-
- If you set the quality to [RAW] or [RAW+JPEG], the picture size is fixed to the maximum picture size for each aspect ratio.
 - The number of recordable pictures and the available recording time displayed on the LCD monitor/Viewfinder may not decrease in order.
 - This unit does not support recording motion pictures on MultiMediaCards.
 - The extended optical zoom does not work in [HIGH SENS.] in scene mode so the picture size for [EZ] is not displayed.

Specifications

Digital Camera: Information for your safety

Power Source:	DC 8.4 V
Power Consumption:	1.5 W (When recording with LCD Monitor) 1.5 W (When recording with Viewfinder) 0.7 W (When playing back with LCD Monitor) 0.7 W (When playing back with Viewfinder)

Camera effective pixels:	8,100,000 pixels
Image sensor:	1/2.5" CCD, total pixel number 8,320,000 pixels, Primary color filter
Lens:	Optical 18× zoom, f=4.6 mm to 82.8 mm (35 mm film camera equivalent: 28 mm to 504 mm)/F2.8 to F4.2
Digital zoom:	Max. 4×
Extended optical zoom:	(Except for the maximum picture size for each aspect ratio) Max. 28.7×
Focus:	Normal/AF Macro/Manual focus, Face detection/ Multi-area-focusing/3-area-focusing (High speed)/ 1-area-focusing (High speed)/1-area-focusing/Spot-focusing
Focus range:	AF: 30 cm (0.98 feet) (Wide)/2 m (6.56 feet) (Tele) to ∞ AF Macro/MF/Intelligent auto: 1 cm (0.03 feet) (Wide)/2 m (6.56 feet) (Tele) to ∞ However, 1 m (3.28 feet) to ∞ for 12× to 18× zoom
Shutter system:	Electronic shutter+Mechanical shutter
Motion picture recording:	When the aspect ratio setting is [4:3] 640×480 pixels (only when using a Card)/320×240 pixels When the aspect ratio setting is [16:9] 848×480 pixels (only when using a Card) 30 frames/second, 10 frames/second with audio
Burst recording	
Burst speed:	3 pictures/second (Normal), Approx. 2 pictures/second (Unlimited)
Number of recordable pictures:	Max. 7 pictures (Standard), max. 4 pictures (Fine), Depends on the remaining capacity of the card (Unlimited). (Performance in burst recording is only with SD Memory Card/SDHC Memory Card. MultiMediaCard performance will be less.)
ISO sensitivity:	AUTO/ 100/200/400/800/1250/1600 [HIGH SENS.] in scene mode: 1600 to 6400

Shutter speed:	60 seconds to 1/2000th of a second [STARRY SKY] in scene mode: 15 seconds, 30 seconds, 60 seconds Motion picture mode: 1/30th of a second to 1/13000th of a second
White balance:	AUTO/Daylight/Cloudy/Shade/Flash/Halogen/White set1/White set2
Exposure (AE):	Program AE (P)/Aperture-priority AE (A)/Shutter-priority AE (S)/Manual exposure (M) Exposure compensation (1/3 EV Step, -2 EV to +2 EV)
Metering mode:	Multiple/Center weighted/Spot
LCD monitor:	2.5" low-temperature polycrystalline TFT LCD (Approx. 207,000 pixels) (field of view ratio about 100%)
Viewfinder:	Color LCD Viewfinder (Approx. 188,000 pixels) (field of view ratio about 100%) (with diopter adjustment -4 to +4 diopter)
Flash:	Built-in pop up flash Flash range: [ISO AUTO] Approx. 30 cm (0.98 feet) to 6 m (19.7 feet) (Wide) AUTO, AUTO/Red-eye reduction, Forced ON (Forced ON/Red-eye reduction), Slow sync./Red-eye reduction, Forced OFF
Microphone:	Monaural
Speaker:	Monaural
Recording media:	Built-in Memory (Approx. 27 MB)/SD Memory Card/SDHC Memory Card/MultiMediaCard (Still pictures only)
Picture size	
Still picture:	When the aspect ratio setting is [4:3] 3264×2448 pixels, 2560×1920 pixels, 2048×1536 pixels, 1600×1200 pixels, 640×480 pixels When the aspect ratio setting is [3:2] 3264×2176 pixels, 2560×1712 pixels, 2048×1360 pixels When the aspect ratio setting is [16:9] 3264×1840 pixels, 2560×1440 pixels, 1920×1080 pixels
Motion pictures:	When the aspect ratio setting is [4:3] 640×480 pixels (Only when using a Card), 320×240 pixels When the aspect ratio setting is [16:9] 848×480 pixels (Only when using a Card)
Quality:	Fine/Standard/RAW/RAW+JPEG
Recording file format	
Still Picture:	JPEG (based on "Design rule for Camera File system", based on "Exif 2.21" standard)/RAW, DPOF corresponding
Picture with audio:	JPEG (based on "Design rule for Camera File system", based on "Exif 2.21" standard)+ "QuickTime" (picture with audio)
Motion pictures:	"QuickTime Motion JPEG" (motion pictures with audio)

Interface

Digital:	“USB 2.0” (Full Speed)
Analog video/audio:	NTSC/PAL Composite (Switched by menu), Audio line output (monaural)

Terminal

[DIGITAL/AV OUT]:	Dedicated jack (8 pin)
[DC IN]:	Type 3 jack

Dimensions:	Approx. 117.6 mm (W)×75.3 mm (H)×88.2 mm (D) [4 5/8" (W)×2 15/16" (H)×3 1/2" (D)] (excluding the projecting parts)
--------------------	--

Mass (Weight):	Approx. 360 g/12.7 oz (excluding card and battery), Approx. 407 g/14.4 oz (with card and battery)
-----------------------	--

Operating temperature:	0 °C to 40 °C (32 °F to 104 °F)
-------------------------------	---------------------------------

Operating humidity:	10% to 80%
----------------------------	------------

Battery Charger

(Panasonic DE-A43B):	Information for your safety
-----------------------------	-----------------------------

Input:	110 V to 240 V ~ 50/60 Hz, 0.15 A
Output:	CHARGE 8.4 V --- 0.43 A







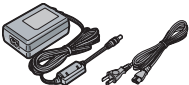

Equipment mobility:	Movable
----------------------------	---------

**Battery Pack
(lithium-ion)**

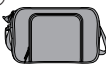
(Panasonic CGR-S006A):	Information for your safety
-----------------------------------	-----------------------------

Voltage/capacity:	7.2 V, 710 mAh
--------------------------	----------------

Digital Camera Accessory System

Accessory#	Figure	Description
CGR-S006A		Lithium Ion Battery
DMW-AC7PP		AC Adaptor*1
(A): DMW-CZS7 (B): DMW-CZ18	(A)  (B) 	(A): Soft Case*2 (B): Soft Bag
(C): DMW-LMC46 (D): DMW-LND46	(C)  (D) 	(C): MC Protector (D): ND Filter
DMW-LT55		Tele Conversion Lens*3
DMW-LC55		Close-up Lens*3
DMW-LA3		Lens Adaptor
RP-SDM04GU1K RP-SDV04GU1K RP-SDM02GU1A RP-SDV02GU1A RP-SDR01GU1A RP-SDV01GU1A RP-SDK512U1A RP-SDR512U1A		4 GB SDHC Memory Card 4 GB SDHC Memory Card 2 GB SD Memory Card 2 GB SD Memory Card 1 GB SD Memory Card 1 GB SD Memory Card 512 MB SD Memory Card 512 MB SD Memory Card

*1 The battery cannot be charged with the AC adaptor. Use the supplied charger.

*2 Cameras cannot be stored with the lens hood attached.

*3 The lens adaptor (DMW-LA3; optional) is necessary to attach a tele conversion lens or close-up lens.

• Refer to P13 for information about the battery charging time and the number of recordable pictures.

• NOTE: Accessories and/or model numbers may vary between countries. Consult your local dealer.

Digital Camera Accessory Order Form

(For USA Customers)

Please photocopy this form when placing an order.

1. Digital Camera Model # _____

2. Items Ordered

Accessory #	Description	Price Each	Quantity	Total Price
Subtotal				
Your State & Local Sales Tax				
Shipping & Handling				6.95
Total Enclosed				

3. Method of payment (check one)

- Check of Money Order enclosed (NO C.O.D.SHIPMENTS)
- VISA Credit Card # _____
- MasterCard Expiration Date _____
- Discover Customer Signature _____

Make Check or Money Order to: PANASONIC ACCESSORIES

(Please do not send cash)

4. Shipping information (UPS delivery requires complete street address)

Ship To:

Mr.

Mrs.

Ms.

First

Last

Phone#:

Day () _____

Street Address

Night () _____

City

State

Zip

TO OBTAIN ANY OF OUR DIGITAL CAMERA ACCESSORIES YOU CAN DO ANY OF THE FOLLOWING:

VISIT YOUR LOCAL PANASONIC DEALER

OR

CALL PANASONIC'S ACCESSORY ORDER LINE AT 1-800-332-5368

[6 AM-6 PM M-F, PACIFIC TIME]

OR

MAIL THIS ORDER TO: PANASONIC SERVICE AND TECHNOLOGY COMPANY

ACCESSORY ORDER OFFICE

20421 84th Avenue South Kent, WA. 98032

In CANADA, please contact your local Dealer for more information about accessories.

Request for Service Notice (For USA Only)

Please photocopy this form when making a request for service notice.

In the unlikely event this product needs service.

Request for Service Notice: (USA Only)

- Please include your **proof of purchase**.
(Failure to do so will delay your repair.)
 - To further speed your repair, please provide an explanation of what wrong with the unit and any symptom it is exhibiting.
-
-
-
-

Mail this completed form and your Proof of Purchase along with your unit to:
Panasonic Camera and Digital Service Center
1590 Touhy Ave.
Elk Grove Village, IL 60007

Limited Warranty (For USA Only)

PANASONIC CONSUMER ELECTRONICS COMPANY, DIVISION OF
 PANASONIC CORPORATION OF NORTH AMERICA
 One Panasonic Way, Secaucus, New Jersey 07094
 PANASONIC PUERTO RICO, INC.
 Ave. 65 de Infantería, Km. 9.5, San Gabriel Industrial Park, Carolina, Puerto
 Rico 00985

Panasonic Digital Still Camera Limited Warranty

Limited Warranty Coverage

If your product does not work properly because of a defect in materials or workmanship, Panasonic Consumer Electronics Company or Panasonic Puerto Rico, Inc. (collectively referred to as “the warrantor”) will, for the length of the period indicated on the chart below, which starts with the date of original purchase (“warranty period”), at its option either (a) repair your product with new or refurbished parts, or (b) replace it with a new or refurbished product. The decision to repair or replace will be made by the warrantor.

PRODUCT OR PART NAME	PARTS	LABOR
DIGITAL STILL CAMERA (EXCEPT ITEMS LISTED BELOW)	1 (ONE) YEAR	1 (ONE) YEAR
CCD	6 (SIX) MONTHS	90 (NINETY) DAYS
RECHARGEABLE BATTERY PACK (IN EXCHANGE FOR DEFECTIVE BATTERY PACK)	90 (NINETY) DAYS	NOT APPLICABLE
SD MEMORY CARD (IN EXCHANGE FOR DEFECTIVE SD CARD)	90 (NINETY) DAYS	NOT APPLICABLE

During the “Labor” warranty period there will be no charge for labor. During the “Parts” warranty period, there will be no charge for parts. You must carry-in or mail-in your product during the warranty period. If non-rechargeable batteries are included, they are not warranted. This warranty only applies to products purchased and serviced in the United States or Puerto Rico. This warranty is extended only to the original purchaser of a new product which was not sold “as is”. A purchase receipt or other proof of the original purchase date is required for warranty service.

Carry-In or Mail-In Service

For Carry-In or Mail-In Service in the United States call
1-800-272-7033.

For assistance in Puerto Rico call Panasonic Puerto Rico, Inc.
(787)-750-4300 or fax (787)-768-2910.

This warranty ONLY COVERS failures due to defects in materials or workmanship, and DOES NOT COVER normal wear and tear or cosmetic damage. The warranty ALSO DOES NOT COVER damages which occurred in shipment, or failures which are caused by products not supplied by the warrantor, or failures which result from accidents, misuse, abuse, neglect, mishandling, misapplication, alteration, faulty installation, set-up adjustments, misadjustment of consumer controls, improper maintenance, power line surge, lightning damage, modification, or commercial use (such as in a hotel, office, restaurant, or other business), rental use of the product, service by anyone other than a Factory Service center or other Authorized Servicicer, or damage that is attributable to acts of God.

THERE ARE NO EXPRESS WARRANTIES EXCEPT AS LISTED UNDER "LIMITED WARRANTY COVERAGE". THE WARRANTOR IS NOT LIABLE FOR INCIDENTAL OR CONSEQUENTIAL DAMAGES RESULTING FROM THE USE OF THIS PRODUCT, OR ARISING OUT OF ANY BREACH OF THIS WARRANTY. (As examples, this excludes damages for lost time, travel to and from the servicicer, loss of media or images, data or other memory content. The items listed are not exclusive, but are for illustration only.) **ALL EXPRESS AND IMPLIED WARRANTIES, INCLUDING THE WARRANTY OF MERCHANTABILITY, ARE LIMITED TO THE PERIOD OF THE LIMITED WARRANTY.**

Some states do not allow the exclusion or limitation of incidental or consequential damages, or limitations on how long an implied warranty lasts, so the exclusions may not apply to you.

This warranty gives you specific legal rights and you may also have other rights which vary from state to state. If a problem with this product develops during or after the warranty period, you may contact your dealer or Service center. If the problem is not handled to your satisfaction, then write to the warrantor's Consumer Affairs Department at the addresses listed for the warrantor.

PARTS AND SERVICE WHICH ARE NOT COVERED BY THIS LIMITED WARRANTY ARE YOUR RESPONSIBILITY.

Customer Services Directory (For USA Only)

For Product Information, Operating Assistance, Literature Request, Dealer Locations, and all Customer Service inquiries please contact:
1-800-272-7033, Monday-Friday 8:30am-8pm EST.

Web Site: <http://www.panasonic.com/consumersupport>
You can purchase parts, accessories or locate your nearest Service Center by visiting our Web Site.

Accessory Purchases

Purchase Parts, Accessories and Instruction Books online for all Panasonic Products by visiting our Web Site at:

<http://www.pstc.panasonic.com>

or, send your request by E-mail to:

npcparts@us.panasonic.com

You may also contact us directly at:

1-800-332-5368 (Phone) 1-800-237-9080 (Fax Only)

(Monday - Friday 9 am to 9 pm, EST.)

PANASONIC SERVICE AND TECHNOLOGY COMPANY

20421 84th Avenue South, Kent, WA 98032

(We Accept Visa, MasterCard, Discover Card, American Express, and Personal Checks)

Product Repairs

Centralized Factory Service Center

Panasonic Camera and Digital Service Center

1590 Touhy Ave.

MAIL TO :

Elk Grove Village, IL 60007

Please carefully pack and ship, prepaid and insured, to the Elk Grove Village Centralized Factory Service Center.

Customer's in Puerto Rico, please ship or carry in to location below ("Service in Puerto Rico").

Service in Puerto Rico

Panasonic Puerto Rico, Inc.:

*Ave. 65 de Infantería, Km. 9.5, San Gabriel Industrial Park,
Carolina, Puerto Rico 00985*

Phone (787) 750-4300 Fax (787) 768-2910

As of January 2007

Précautions à prendre

(pour le Canada)

AVERTISSEMENT :

POUR RÉDUIRE LES RISQUES D'INCENDIE, DE CHOC ÉLECTRIQUE OU DE DOMMAGES À L'APPAREIL,

• N'EXPOSEZ PAS CET APPAREIL À LA PLUIE, À L'HUMIDITÉ, À L'ÉGOUTTEMENT OU AUX ÉCLABOUSSEMENTS, ET NE PLACEZ SUR L'APPAREIL AUCUN OBJET REMPLI DE LIQUIDE, COMME PAR EXEMPLE DES VASES.

• UTILISEZ EXCLUSIVEMENT LES ACCESSOIRES RECOMMANDÉS.
• NE RETIREZ PAS LE COUVERCLE (OU LE PANNEAU ARRIÈRE) ; IL N'Y A AUCUNE PIÈCE RÉPARABLE PAR L'UTILISATEUR À L'INTÉRIEUR. CONFIEZ TOUTE RÉPARATION À UN TECHNICIEN DE SERVICE QUALIFIÉ.

LA PRISE DE COURANT DOIT SE TROUVER À PROXIMITÉ DE L'APPAREIL ET ÊTRE FACILEMENT ACCESSIBLE.

ATTENTION

Danger d'explosion si la batterie/pile n'est pas remplacée correctement. Remplacez-la uniquement par une batterie/pile identique ou du même type recommandée par le fabricant. Suivez les instructions du fabricant pour jeter les batteries/piles usées.

Avertissement

Risque d'incendie, d'explosion et de brûlures. Ne pas démonter, chauffer à plus de 60 °C (140 °F) ou incinérer.

La plaque signalétique se trouve sur le dessous des appareils.

Cet appareil numérique de la classe B est conforme à la norme NMB-003 du Canada.

- Assurez-vous d'utiliser un adaptateur secteur de marque Panasonic (DMW-AC7PP; en option).
- Assurez-vous d'utiliser une batterie de marque Panasonic (CGR-S006A).
- Si vous utilisez d'autres batteries, nous ne pouvons pas garantir la qualité de ce produit.
- N'utilisez pas d'autres câbles de connexion USB à l'exception de celui fourni.
- N'utilisez pas d'autres câbles AV à l'exception de celui fourni.
- Conservez la carte mémoire hors de portée des enfants afin qu'ils ne puissent pas l'avaler.

Évitez d'approcher l'appareil photo de tout équipement magnétisé (four à micro-ondes, téléviseur, équipement de jeux vidéo, etc.).

- Si vous utilisez l'appareil photo à proximité d'un téléviseur, les radiations électromagnétiques pourraient nuire au son et à l'image.
- N'utilisez pas l'appareil photo à proximité d'un téléphone cellulaire; cela pourrait entraîner un bruit nuisible à l'image et au son.

- Le puissant champ magnétique de haut-parleurs ou de moteurs peut endommager les données enregistrées et distordre les images.
- Les ondes électromagnétiques émises par un microprocesseur peuvent nuire à l'appareil photo numérique et perturber l'image et le son.
- Advenant le cas où le fonctionnement de l'appareil serait dérangé par un champ magnétique, coupez le contact, retirez la batterie ou débranchez l'adaptateur secteur (modèle DMW-AC7PP; en option) pour ensuite soit remettre la batterie en place, soit rebranché l'adaptateur. Remettez l'appareil en marche.

N'utilisez pas l'appareil photo à proximité d'un émetteur radio ou de lignes à haute tension.

- L'utilisation de l'appareil photo à proximité d'un émetteur radio ou de lignes à haute tension pourrait nuire à l'image ou au son.

■ À propos du bloc-batterie

ATTENTION

Batterie (batterie au lithium-ion)

- Utilisez l'unité spécifiée pour recharger la batterie.
- N'utilisez la batterie avec aucun autre appareil que l'appareil spécifiée.
- Évitez le contact des saletés, du sable, du liquide ou autres corps étrangers avec les bornes.
- Ne touchez pas les bornes des fiches (+ et -) avec des objets métalliques.
- Évitez de démonter, remodeler, chauffer ou jeter au feu.

Si de l'électrolyte entre en contact avec vos mains ou vos vêtements, lavez-les avec beaucoup d'eau.

Si de l'électrolyte pénètre dans vos yeux, ne les frottez pas.

Rincez-vous les yeux avec beaucoup d'eau, puis consultez un médecin.

■ À propos du chargeur de batterie

ATTENTION!

NE PAS INSTALLER CET APPAREIL DANS UNE BIBLIOTHÈQUE, UNE ARMOIRE OU TOUT AUTRE ESPACE CONFINÉ. S'ASSURER QUE LA VENTILATION DE L'APPAREIL EST ADÉQUATE. AFIN D'ÉVITER TOUT RISQUE DE CHOC ÉLECTRIQUE OU D'INCENDIE DÛ À UN SURCHAUFFEMENT, S'ASSURER QUE RIDEAUX OU TOUT OBJET QUELCONQUE NE BOUCHENT LES ÉVÉNONS D'AÉRATION DE L'APPAREIL.

Chargeur de batterie

Ce chargeur fonctionne sur le secteur entre 110 V et 240 V.

Toutefois

- Aux États-Unis et au Canada, le chargeur doit être branché sur une prise secteur de 120 V seulement.
- Lors du branchement à une prise secteur à l'extérieur des États-Unis ou du Canada, utilisez un adaptateur conforme à la configuration de la prise secteur.

Index

A

AC Adaptor	111, 113
Access indication	24
Adjusting Flash Output	43
Advanced scene Mode	57
Aerial Photo Mode	65
AF Area Selection	80
AF Assist Lamp	82
AF Macro Mode	48
AF Mode	78
AF Operation Sound	22
AF/AE Lock	26, 83
Aperture-priority AE	50, 52
Aspect Ratio	66, 75, 130
Aspect Ratio Conversion	108
Audio Dubbing	105
Audio Recording	65, 77
Auto Bracket	46
Auto Power LCD Mode	39
Auto Review	20
Auto White Balance	72
AV cable	117
Available Recording Time	132

B

Baby Mode	61
Backlight Compensation	29
Battery	13, 15
Beach Mode	65
Brightness of the LCD Monitor/ Viewfinder	21
Built-in Flash	40
Built-in Memory	16
Burst Mode	47

C

Calendar Playback	89
Candle Light Mode	60
Card	5, 15, 16
Category	95
Center Weighted	78
Changing the Zoom Area	54
Charger	122
Charging	13
Clock Set	17, 20
Close-up Lens	86

Color	26, 72, 73
Color Effect	83
Condensation	5
Continuous AF	28, 82
Conversion Lens	86
Copy	109
Custom Mode	56
Custom Setting	21, 55

D

Date Printing	104, 115, 116
DCF standard	34
Deleting Pictures	33
Dial Display	23
Digital Zoom	31
Diopter Adjustment	37
DPOF Print Setting	103

E

Entering Text	61, 100
Exposure	25
Exposure Compensation	45
Extended Optical Zoom	31
EZ	31, 77

F

Face detection	78
File Number	22, 112, 120
Fine	77
Fireworks Mode	64
Flip Animation	84
Focus	26
Folder Composition	112
Folder Number	22, 112
Food Mode	60
Formatting	110

G

Guide Line	21, 36, 38
------------------	------------

H

High Angle Mode	39
High Sensitivity Mode	61
Histogram	38
Hood Adaptor	11

I		P	
Intelligent Auto Mode	28	PAL	23
Intelligent ISO Sensitivity Mode	74	Panning Mode	62
ISO Sensitivity	75	Paper Size	115
J		Party Mode	60
Jitter	27	Pet Mode	62
Jitter/Movement Detection		PictBridge	113
Demonstration	81	Picture Adjustment	84
L		Picture Quality Setting (Motion Picture	
Language Setting	23	Mode)	66
Layout	116	Picture Size	76, 130
LCD Monitor	23, 36, 118	Pictures with Audio	91
Lens Adaptor	86	Playback Pictures on TV	117
Lens Cap	10	Playback Zoom	90
Lens Hood	11	Playing Back Motion Pictures	91
M		Portrait Mode	57
m/ft	23	Power Lamp	25
MANUAL	95	Power LCD Mode	39
Manual Exposure	51, 52	Power Save	21
Manual Exposure Assistance	51	Prefocus	54
Manual Focus	52	Print Mode	113
MC Protector	118	Program AE Mode	25
Metering Mode	78	Program shift	27
MF Assist	22, 53	Protect	104
Monitor Priority	21, 37	Q	
Motion Picture Mode	65	Quality	76, 130
Multi Playback	88	Quick Setting	71
Multiple	78	R	
N		RAW	77
ND Filter	118	RAW+JPEG	77
Night Portrait Mode	58	Reset of Setting	22
NO.RESET	22	Resizing	106
NTSC	23	Review	32
Number of Prints	103, 115	Rotate	97
Number of Recordable Pictures	13, 130	Rotate Display	97
O		S	
One Shot AF	54	Scene detection	28
Operational Sound	22	Scene Menu	23
Optical Image Stabilizer	81	Scene Mode	59
Optical Zoom	30	Scenery Mode	58
Out-of-frame Display	37	Self-timer	44
		Setting Favorites	98
		Setup Menu	20
		Shutter sound	22
		Shutter-priority AE	50, 52
		Slide Show	94

Snow Mode	65
Speaker	22
Sports Mode	58
Spot	78
Spot-focusing	79
Standard	77
Starry Sky Mode	63
Strap	10
Sunset Mode	61

T

Tele conversion Lens	86
Tele-macro Function	49
Text Stamp	101
Thumbnail	34
Title Edit	99
Travel Date	21, 67
Trimming	107
Tripod	123
TV Aspect	23

U

USB Connection Cable	111, 113
----------------------------	----------

V

Video Output	23, 117
Viewfinder	23, 36, 118
Volume of Speakers	22

W

White Balance	72
White Balance Fine Adjustment	73
White Set	72
World Time	21, 69

Z

Zoom	30
Zoom Resume	22, 30



QuickTime and the QuickTime logo are trademarks or registered trademarks of Apple Inc., used under license therefrom.

**Panasonic Consumer Electronics Company,
Division of Panasonic Corporation of North America**

One Panasonic Way, Secaucus, NJ 07094

Panasonic Puerto Rico, Inc.

Ave. 65 de Infantería, Km. 9.5, San Gabriel Industrial Park, Carolina, Puerto Rico 00985

Panasonic Canada Inc.

5770 Ambler Drive, Mississauga, Ontario, L4W 2T3

© 2007 Matsushita Electric Industrial Co., Ltd.



VQT1F83

F0707MR0 (23000 Ⓐ)

