

Panasonic[®]

Basic Owner's Manual

Digital Camera/
Lens Kit

Model No. **DMC-GM5K**



LUMIX

Please read these instructions carefully before using this product, and save this manual for future use.

More detailed instructions on the operation of this camera are contained in "Owner's Manual for advanced features (PDF format)" in the supplied DVD. Install it on your PC to read it.



Register online at www.panasonic.com/register (U.S. customers only)

If you have any questions, visit:
USA : www.panasonic.com/support



Dear Customer,

Thank you for choosing Panasonic!

You have purchased one of the most sophisticated and reliable products on the market today. Used properly, we're sure it will bring you and your family years of enjoyment. Please take time to fill in the information below. The serial number is on the tag located on the underside of your camera. Be sure to **retain this manual** as your convenient camera information source.

Date of Purchase	Dealer Phone No.
Dealer Purchased From	Model No.
Dealer Address	Serial No.

Please note that the actual controls and components, menu items, etc. of your Digital Camera may look somewhat different from those shown in the illustrations in this Owner's Manual.

Carefully observe copyright laws.

- Recording of pre-recorded tapes or discs or other published or broadcast material for purposes other than your own private use may infringe copyright laws. Even for the purpose of private use, recording of certain material may be restricted.



A lithium ion battery that is recyclable powers the product you have purchased. Please call 1-800-8-BATTERY for information on how to recycle this battery.

Information for Your Safety

WARNING:

To reduce the risk of fire, electric shock or product damage,

- Do not expose this unit to rain, moisture, dripping or splashing.
- Use only the recommended accessories.
- Do not remove covers.
- Do not repair this unit by yourself. Refer servicing to qualified service personnel.

The socket outlet shall be installed near the equipment and shall be easily accessible.

■ Product identification marking

Product	Location
Digital Camera	Bottom
Battery charger	Bottom

FCC Note:

This equipment has been tested and found to comply with the limits for a Class B digital device, pursuant to Part 15 of the FCC Rules. These limits are designed to provide reasonable protection against harmful interference in a residential installation. This equipment generates, uses, and can radiate radio frequency energy and, if not installed and used in accordance with the instructions, may cause harmful interference to radio communications. However, there is no guarantee that interference will not occur in a particular installation. If this equipment does cause harmful interference to radio or television reception, which can be determined by turning the equipment off and on, the user is encouraged to try to correct the interference by one or more of the following measures:

- Reorient or relocate the receiving antenna.
- Increase the separation between the equipment and receiver.
- Connect the equipment into an outlet on a circuit different from that to which the receiver is connected.
- Consult the dealer or an experienced radio/TV technician for help.

FCC Caution: To assure continued compliance, follow the attached installation instructions and use only shielded interface cables with ferrite core when connecting to computer or peripheral devices.

Any changes or modifications not expressly approved by the party responsible for compliance could void the user's authority to operate this equipment.

Declaration of Conformity

Trade Name: Panasonic

Model No.: DMC-GM5

Responsible Party: Panasonic Corporation of North America

Two Riverfront Plaza, Newark, NJ 07102-5490

Support Contact: <http://www.panasonic.com/contactinfo>

This device complies with Part 15 of the FCC Rules. Operation is subject to the following two conditions: (1) This device may not cause harmful interference, and (2) this device must accept any interference received, including interference that may cause undesired operation.



Certification and Compliance

See Camera for the certification and compliance mark specific to that device.

- 1 Select [Wi-Fi] in the [Setup] menu.**
- 2 Select [Wi-Fi Setup] in the [Wi-Fi] menu.**
- 3 Press ▲/▼ to select [Approved Regulations], and then press [MENU/SET].**

Contains FCC ID: VPYLBXN604

This transmitter must not be co-located or operated in conjunction with any other antenna or transmitter.

This equipment complies with FCC radiation exposure limits set forth for an uncontrolled environment and meets the FCC radio frequency (RF) Exposure Guidelines in Supplement C to OET65.

This equipment has very low levels of RF energy that are deemed to comply without testing of specific absorption ratio (SAR).

■ About the battery pack

CAUTION

Battery pack (Lithium ion battery pack)

- Use the specified unit to recharge the battery pack.
- Do not use the battery pack with equipment other than the specified unit.
- Do not get dirt, sand, liquids, or other foreign matter on the terminals.
- Do not touch the plug terminals (+ and –) with metal objects.
- Do not disassemble, remodel, heat or throw into fire.

If any electrolyte should come into contact with your hands or clothes, wash it off thoroughly with water.

If any electrolyte should come into contact with your eyes, never rub the eyes. Rinse eyes thoroughly with water, and then consult a doctor.

CAUTION

- Danger of explosion if battery is incorrectly replaced. Replace only with the type recommended by the manufacturer.
- When disposing of the batteries, please contact your local authorities or dealer and ask for the correct method of disposal.

- Do not heat or expose to flame.
- Do not leave the battery(ies) in a car exposed to direct sunlight for a long period of time with doors and windows closed.

Warning

Risk of fire, explosion and burns. Do not disassemble, heat above 60 °C (140 °F) or incinerate.

■ About the battery charger

CAUTION!

To reduce the risk of fire, electric shock or product damage,

- **Do not install or place this unit in a bookcase, built-in cabinet or in another confined space. Ensure this unit is well ventilated.**

Battery charger

This battery charger operates on AC between 110 V and 240 V.

But

- In the U.S.A. and Canada, the battery charger must be connected to a 120 V AC power supply only.
- When connecting to an AC supply outside of the U.S.A. or Canada, use a plug adaptor to suit the AC outlet configuration.

Cautions for Use

- Do not use any other USB connection cables except the supplied one or a genuine Panasonic USB connection cable (DMW-USBC1: optional).
- Use a "High Speed HDMI micro cable" with the HDMI logo.
Cables that do not comply with the HDMI standards will not work.
"High Speed HDMI micro cable" (Type D–Type A plug, up to 2 m (6.6 feet) long)
- Always use a genuine Panasonic AV cable (DMW-AVC1: optional).

Keep this unit as far away as possible from electromagnetic equipment (such as microwave ovens, TVs, video games etc.).

- If you use this unit on top of or near a TV, the pictures and/or sound on this unit may be disrupted by electromagnetic wave radiation.
- Do not use this unit near cell phones because doing so may result in noise adversely affecting the pictures and/or sound.
- Recorded data may be damaged, or pictures may be distorted, by strong magnetic fields created by speakers or large motors.
- Electromagnetic wave radiation may adversely affect this unit, disturbing the pictures and/or sound.
- If this unit is adversely affected by electromagnetic equipment and stops functioning properly, turn this unit off and remove the battery or disconnect AC adaptor (DMW-AC10PP: optional). Then reinsert the battery or reconnect AC adaptor and turn this unit on.

Do not use this unit near radio transmitters or high-voltage lines.

- If you record near radio transmitters or high-voltage lines, the recorded pictures and/or sound may be adversely affected.

-
- **Before cleaning the camera, remove the battery or the DC coupler (DMW-DCC15: optional), or disconnect the power plug from the outlet.**
 - **Do not press the monitor with excessive force.**
 - **Do not press the lens with excessive force.**
 - **Do not spray the camera with insecticides or volatile chemicals.**
 - **Do not keep rubber or plastic products in contact with the camera for a long period of time.**
 - **Do not use solvents such as benzene, thinner, alcohol, kitchen detergents, etc., to clean the camera, since it may deteriorate the external case or the coating may peel off.**
 - **Do not leave the camera with the lens facing the sun, as rays of light from the sun may cause it to malfunction.**
 - **Always use the supplied cords and cables.**
 - **Do not extend the cords or the cables.**
 - **During access (image writing, reading and deleting, formatting etc.), do not turn this unit off, remove the battery, card or disconnect the AC adaptor (DMW-AC10PP: optional). Furthermore, do not subject the camera to vibration, impact or static electricity.**
 - **The data on the card may be damaged or lost due to electromagnetic waves, static electricity or breakdown of the camera or the card. We recommend storing important data on a PC etc.**
 - **Do not format the card on your PC or other equipment. Format it on the camera only to ensure proper operation.**
-
- **The battery is not charged when the camera is shipped. Charge the battery before use.**
 - **The battery is a rechargeable lithium ion battery. If the temperature is too high or too low, the operating time of the battery will become shorter.**
 - **The battery becomes warm after using and during and after charging. The camera also becomes warm during use. This is not a malfunction.**
 - **Do not leave any metal items (such as clips) near the contact areas of the power plug or near the batteries.**
 - **Store the battery in a cool and dry place with a relatively stable temperature: [Recommended temperature: 15 °C to 25 °C (59 °F to 77 °F), Recommended humidity: 40%RH to 60%RH]**
 - **Do not store the battery for a long time while fully charged.** When storing the battery for a long period of time, we recommend charging it once a year. Remove the battery from the camera and store it again after it has completely discharged.
-

-If you see this symbol-

Information on Disposal in other Countries outside the European Union

This symbol is only valid in the European Union.

If you wish to discard this product, please contact your local authorities or dealer and ask for the correct method of disposal.



Contents

Information for Your Safety	2
• Cautions for Use	5

Preparation/Basic

Care of the camera	8
Standard Accessories	9
Names and Functions of	
Components	10
Preparation	13
• Attaching the Shoulder Strap	13
• Charging the Battery	13
• Inserting/Removing the Battery	14
• Inserting/Removing the Card	
(Optional)	14
• Formatting the card (initialization)	15
• Changing the Lens	15
• Setting Date/Time (Clock Set)	16
• Diopter adjustment	16
Basic Operations	17
• Shutter button (Taking pictures)	17
• [LVF] button (Switching	
the Monitor/Viewfinder)	17
• Mode dial (Selecting	
a Recording Mode)	18
• Function buttons (Assigning	
frequently used functions to the	
buttons)	19
• Touch screen (Touch operations)	19
Calling frequently-used menus	
instantly (Quick Menu)	20
Setting the Menu	20

Recording

Taking Pictures using the Automatic	
Function (Intelligent Auto Mode)	21
Taking panorama pictures	
(Panorama Shot Mode)	23
Taking Pictures with Manual Focus	23
Recording Motion Picture	25
Recording Snap Movies	26

Playback

Playing Back Pictures	27
Playing Back Motion Pictures	27
Deleting Pictures	28

Wi-Fi

What you can do with the Wi-Fi®	
function	29
Connecting to a smartphone/tablet	30
Controlling with a Smartphone/Tablet	31

Others

About the supplied software	33
Monitor Display/Viewfinder Display	34
Menu list	37
Troubleshooting	39
Specifications	43
Digital Camera Accessory System ...	47
Reading the Owner's Manual	
(PDF format)	48
Digital Camera Accessory	
Order Form (For USA Customers)	49
Limited Warranty	
(ONLY FOR U.S.A.)	50

Care of the camera

Do not subject to strong vibration, shock, or pressure.

- The lens, monitor, or external case may be damaged if used in the following conditions. It may also malfunction or image may not be recorded if you:
 - Drop or hit the camera.
 - Press hard on the lens or the monitor.

This camera is not dust/drip/water proof.

Avoid using the camera in places with a lot of dust, water, sand, etc.

- Liquid, sand and other foreign material may get into the space around the lens, buttons, etc. Be particularly careful since it may not just cause malfunctions, but it may also become irreparable.
 - Places with a lot of sand or dust.
 - Places where water can come into contact with this unit, such as when using it on a rainy day or at the beach.

Do not place your hands inside the mount of the digital camera body. Since the sensor unit is a precision apparatus, it may cause a malfunction or damage.

■ About Condensation (When the lens, the viewfinder or monitor is fogged up)

- Condensation occurs when the ambient temperature or humidity changes. Be careful of condensation since it causes lens, viewfinder and monitor stains, fungus and camera malfunction.
- If condensation occurs, turn the camera off and leave it for about 2 hours. The fog will disappear naturally when the temperature of the camera becomes close to the ambient temperature.

About the firmware of your interchangeable lens

For smoother recording, we recommend updating the firmware of the interchangeable lens to the latest version.

- **To view the latest information on the firmware or to download the firmware, visit the support site below:**

<http://panasonic.jp/support/global/cs/dsc/>

(This Site is English only.)

- To check the firmware version of the interchangeable lens, attach it to the camera body and select [Version Disp.] in the [Setup] menu.

Standard Accessories

Check that all the accessories are supplied before using the camera.
Product numbers correct as of September 2014. These may be subject to change.

Digital Camera Body



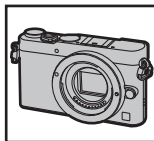







(This is referred to as **camera body** in this owner's manual.)

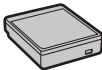

- 1 Interchangeable Lens^{*1, *3}
- 2 Lens Cap^{*2}
- 3 Battery Pack
(Indicated as **battery pack** or **battery** in the text)
Charge the battery before use.
- 4 Battery Charger
(Indicated as **battery charger** or **charger** in the text)
- 5 Flash
- 6 Soft Case
Keep the flash in the soft case when not in use.
- 7 Hot shoe cover^{*3}
- 8 USB Connection Cable
- 9 DVD
 - Software:
Use it to install the software to your PC.
 - Owner's Manual for advanced features:
Use it to install to your PC.
- 10 Shoulder Strap

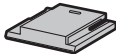
- *1 This is referred to as **lens** in this Owner's Manual.
*2 This is attached to the interchangeable lens at the time of purchase.
*3 This is attached to the camera body at the time of purchase.

- SD Memory Card, SDHC Memory Card and SDXC Memory Card are indicated as **card** in the text.
- **The card is optional.**
- Description in this Owner's Manual is based on the interchangeable lens (H-FS12032).
- If accessories are lost, customers can visit us at www.panasonic.com/support for further information about obtaining replacement parts.

1  H-FS12032	2  VYF3562
3  DMW-BLH7PP	4  DE-A99B
5  VEK0V37Z1-A	6  VFC5140
7  VKF5259	8  K1HY08YY0031
9  SFM0046	10  VFC5071

Names and Functions of Components

■ Camera body

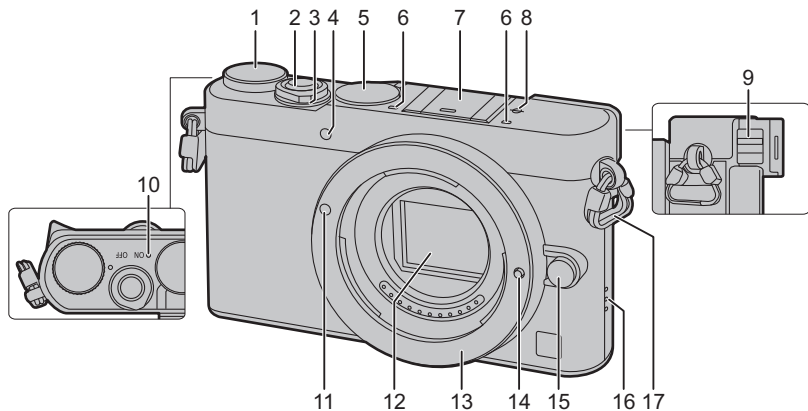

1	Mode dial (P18)		Status indicator (P16)/ Wi-Fi® connection lamp
2	Shutter button (P17)	10	• The lamp lights green when the camera is turned on, and lights blue when it is connected to Wi-Fi.
3	Camera ON/OFF switch (P16)	11	Lens fitting mark (P15)
4	Self-timer indicator/ AF Assist Lamp	12	Sensor
5	Focus mode dial (P24)	13	Mount
6	Stereo microphone • Be careful not to cover the microphone with your finger. Doing so may make sound difficult to record.	14	Lens lock pin
7	Hot shoe (Hot shoe cover) (P12) • Keep the Hot Shoe Cover out of reach of children to prevent swallowing.	15	Lens release button (P15)
8	Focus distance reference mark	16	Speaker • Be careful not to cover the speaker with your finger. Doing so may make sound difficult to hear.
9	Diopter adjustment lever (P16)	17	Shoulder strap eyelet (P13)

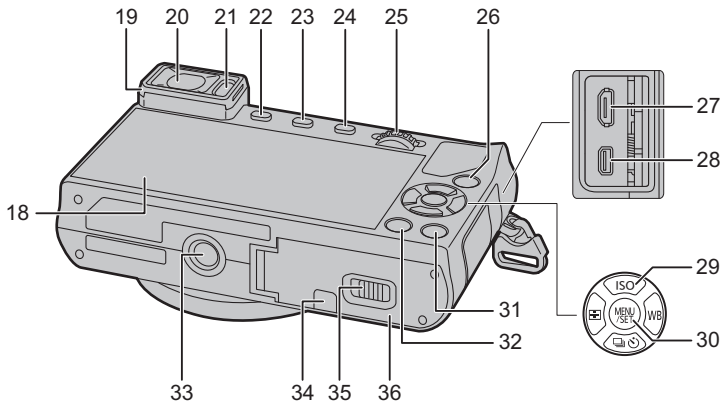

18	Touch screen (P19)/monitor (P34)	30	[MENU/SET] button (P20)
19	Eye Cup	31	[DISP] button • Each time this is pressed, the display on the monitor is switched.
20	Viewfinder (P17)	32	[] (Delete) button (P28)/ [] (Quick Menu/Return) button (P20)
21	Eye sensor (P18)	33	Tripod mount • A tripod with a screw length of 5.5 mm (0.22 inch) or more may damage this unit if attached.
22	[LVF] button (P17)/[Fn2] button (P19)	34	DC coupler cover • When using an AC adaptor, ensure that the Panasonic DC coupler (DMW-DCC15: optional) and AC adaptor (DMW-AC10PP: optional) are used. • Always use a genuine Panasonic AC adaptor (DMW-AC10PP: optional). • When using an AC adaptor, use the AC cable supplied with the AC adaptor.
23	[Wi-Fi] button (P30)/[Fn1] button (P19)	35	Release lever (P14)
24	[] (Playback) button (P27)	36	Card/Battery door (P14)
25	Rear dial • This Owner's Manual describe operations of the rear dial as follows: 		
26	Motion picture button (P25)		
27	[HDMI] socket		
28	[AV OUT/DIGITAL] socket		
29	Cursor buttons • This Owner's Manual express the up, down, left, and right of the cursor button as /▼/◀/▶. ▲/[ISO] (ISO sensitivity) ▶/[WB] (White Balance) ◀/[] (Auto Focus Mode) ▼/[] (Drive mode) – Single/Burst/Auto bracket/Self-timer		

■ Lens

H-FS12032

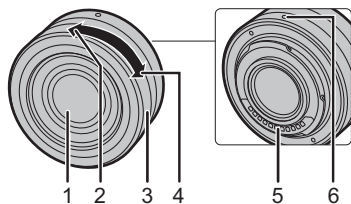

- 1 Lens surface
- 2 Tele
- 3 Zoom ring
- 4 Wide
- 5 Contact point
- 6 Lens fitting mark (P15)

- The interchangeable lens (H-FS12032) does not have a focus ring, but you can use manual focus by operating the camera. Refer to P23 for details.

Attaching the Flash (Supplied)

- 1 Remove the hot shoe cover by pulling it in the direction indicated by arrow ② while pressing it in the direction indicated by arrow ①.
- 2 Turn off the camera and the flash.
- 3 Slide the flash firmly all the way into the camera's hot shoe until it clicks into place.

- Turn on the camera and the flash when recording images.

Ⓐ Flash ON/OFF switch

- To remove the flash, pull the flash in the direction of the arrow while pressing and holding the lock release button Ⓑ.

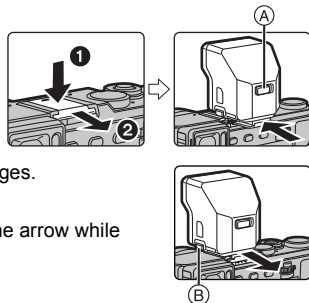

Preparation

- Check that the camera is turned off.

Attaching the Shoulder Strap

- We recommend attaching the shoulder strap when using the camera to prevent it from dropping.

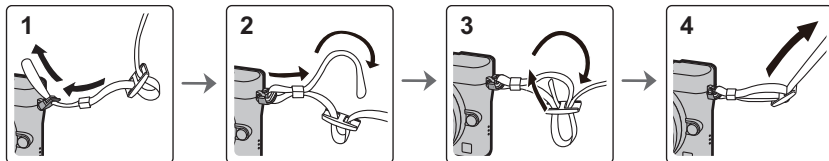

- Perform steps **1** to **4** and then attach the other side of the shoulder strap.
- Use the shoulder strap around your shoulder.
 - Do not wrap the strap around your neck. It may result in injury or accident.
- Do not leave the shoulder strap where an infant can reach it.
 - It may result in an accident by mistakenly wrapping around the neck.

Charging the Battery

The battery that can be used with this unit is DMW-BLH7PP.

- 1 Attach the battery paying attention to the direction of the battery.**
- 2 Connect the charger to the electrical outlet.**
 - The [CHARGE] indicator **A** lights up and charging begins.

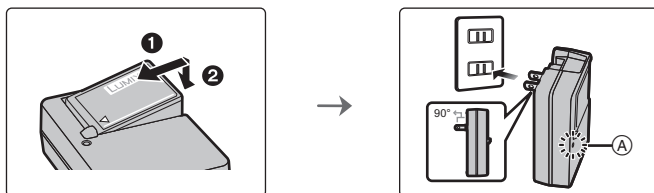

■ About the [CHARGE] indicator

On: Charging.

Off: Charging has completed.

(Disconnect the charger from the electrical socket and detach the battery after charging is completed.)

• When the [CHARGE] indicator flashes

- The battery temperature is too high or too low. It is recommended to charge the battery again in an ambient temperature of between 10 °C and 30 °C (50 °F and 86 °F).
- The terminals of the charger or the battery are dirty. In this case, wipe them with a dry cloth.

■ Charging time

Charging time	Approx. 130 min
---------------	-----------------

- The indicated charging time is for when the battery has been discharged completely. The charging time may vary depending on how the battery has been used. The charging time for the battery in hot/cold environments or a battery that has not been used for a long time may be longer than normal.

Inserting/Removing the Battery

- Always use genuine Panasonic batteries (DMW-BLH7PP).
- If you use other batteries, we cannot guarantee the quality of this product.

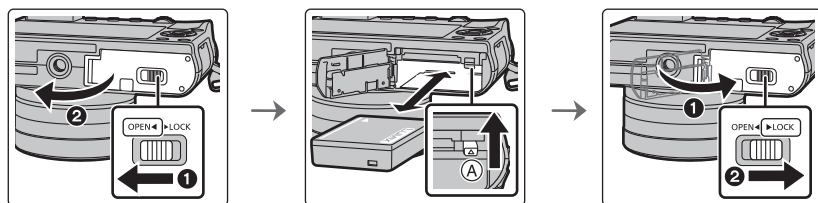

- Being careful about the battery orientation, insert all the way until you hear a locking sound and then check that it is locked by lever (A). Pull the lever (A) in the direction of the arrow to remove the battery.

Inserting/Removing the Card (Optional)

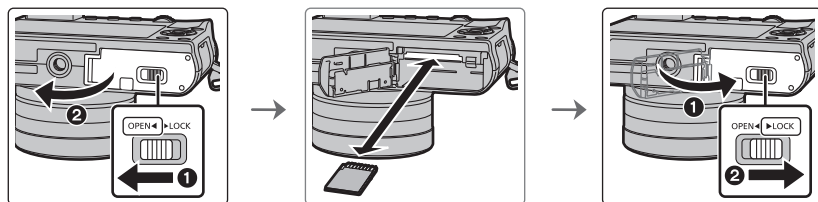

- Push it securely all the way until you hear a "click" while being careful about the direction in which you insert it. To remove the card, push the card until it clicks, then pull the card out upright.

■ About cards that can be used with this unit

SD Memory Card (8 MB to 2 GB)

SDHC Memory Card (4 GB to 32 GB)

SDXC Memory Card (48 GB, 64 GB)

■ About the motion picture recording and SD speed class

Confirm the SD Speed Class (the speed standard regarding continuous writing) on a card label etc. when you record a motion picture. Use a card with SD Speed Class with "Class 4" or more for [AVCHD]/[MP4] motion picture recording.

e.g.:



- Please confirm the latest information on the following website.

<http://panasonic.jp/support/global/cs/dsc/>

(This Site is English only.)

- Keep the Memory Card out of reach of children to prevent swallowing.

Formatting the card (initialization)

Format the card before recording a picture with this unit.

Since data cannot be recovered after formatting, make sure to back up necessary data in advance.

Select **[Format]** in the **[Setup]** menu.

- Confirmation screen is displayed. It is executed when [Yes] is selected.

Changing the Lens

- When attaching or detaching the interchangeable lens (H-FS12032), retract the lens barrel.
- Change lenses where there is not a lot of dirt or dust.

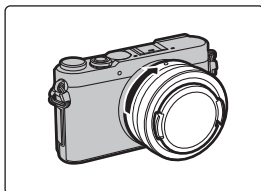
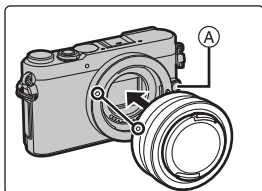

- Do not press the lens release button (A) when you attach a lens.

■ Detaching the lens

- 1 Attach the lens cap.
- 2 While pressing on the lens release button (B), rotate the lens toward the arrow until it stops and then remove.

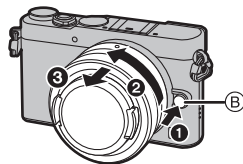

■ Extending/retracting the lens [when the interchangeable lens (H-FS12032) is attached]

How to Extend the Lens

Rotate the zoom ring in the direction of arrow ① from position ① (the lens is retracted) to position ② [12 mm to 32 mm (H-FS12032)] to extend the lens.

- When the lens barrel is retracted, images cannot be recorded.

③ The lens is retracted

How to Retract the Lens

Rotate the zoom ring in the direction of arrow ② from position ② [12 mm to 32 mm (H-FS12032)] to position ① to retract the lens.

- The zoom ring will seem to click into the 12 mm position, but continue to rotate the lens until it reaches position ①.

- When you are not recording images, we recommend that you retract the lens.

④ The lens is extended

Example: H-FS12032

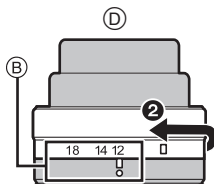
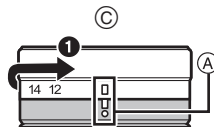

Setting Date/Time (Clock Set)

- The clock is not set when the camera is shipped.

1 Turn the camera on.

- When the camera is turned on, the status indicator ① lights up green.

2 Press [MENU/SET].

3 Press ◀/▶ to select the items (year, month, day, hour, minute), and press ▲/▼ to set.

4 Press [MENU/SET] to set.

- Confirmation screen is displayed. Press [MENU/SET].
- A message prompting you to set [Home] in [World Time] will be displayed. Press [MENU/SET].

5 Press ◀/▶ to select the home area, and then press [MENU/SET].

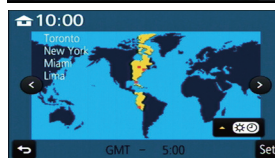
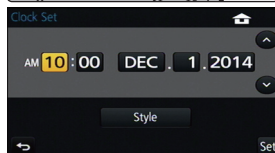
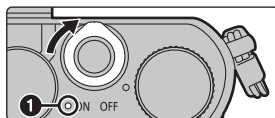

Diopter adjustment

Slide the diopter adjustment lever so that the characters displayed in the viewfinder can be seen clearly.

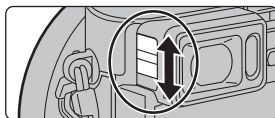

Basic Operations

Shutter button (Taking pictures)

The shutter button works in two steps. To take a picture, press it.

Press the shutter button halfway to focus.

- Ⓐ Aperture value
- Ⓑ Shutter speed
- Ⓒ Focus indication

- Aperture value and shutter speed are displayed.
(It will flash in red if the correct exposure is not achieved, except when set to flash.)
- Once the subject is in focus, the focus indication is displayed.
(When the subject is not in focus, the indication flashes)

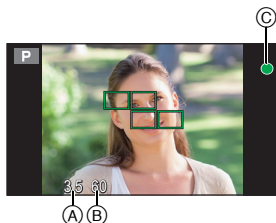
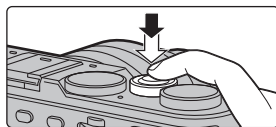

Press the shutter button fully (push it in further), and take the picture.

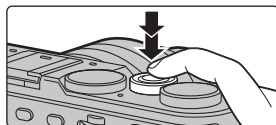

- **When the image is correctly focused, the picture will be taken, since the [Focus/Release Priority] is set initially to [FOCUS].**
- The focus range is different depending on the lens used.
- Even during menu operation or image playback, if you press the shutter button halfway, you can instantly set the camera ready for recording.

[LVF] button (Switching the Monitor/Viewfinder)

Press [LVF] to switch between the Monitor and Viewfinder.

- Ⓐ [LVF] button
- Ⓑ Eye sensor

Press [LVF].

- The monitor/viewfinder will switch as follows:

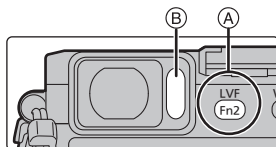

Automatic viewfinder/
monitor switching



Viewfinder display



Monitor display



■ Notes on automatic viewfinder/monitor switching

Automatic viewfinder/monitor switching enables the eye sensor to switch the display to the viewfinder automatically when you bring your eye or an object near it.

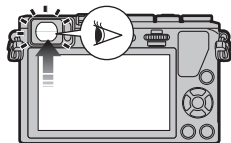

Mode dial (Selecting a Recording Mode)

Select the mode by rotating the mode dial.

- Rotate the mode dial slowly to select the desired mode.

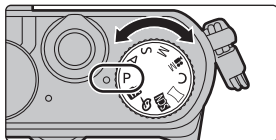

iA Intelligent Auto Mode (P21)

The subjects are recorded using settings automatically selected by the camera.

iA+ Intelligent Auto Plus Mode (P21)

Allows you to adjust the brightness and color hue when in Intelligent Auto Mode.

P Program AE Mode

Records at the aperture value and shutter speed set by the camera.

A Aperture-Priority AE Mode

The shutter speed is automatically determined by the aperture value you set.

S Shutter-Priority AE Mode

The aperture value is automatically determined by the shutter speed you set.

M Manual Exposure Mode

The exposure is adjusted by the aperture value and the shutter speed which are manually adjusted.

M Creative Video Mode

Records motion pictures with a manually set aperture value and shutter speed.

* You cannot take still pictures.

C Custom Mode

Use this mode to take pictures with previously registered settings.

P Panorama Shot Mode (P23)

This mode allows you to take panorama pictures.

SCN Scene Guide Mode

This mode allows you to take pictures that match the scene being recorded.

C Creative Control Mode

Record while checking the image effect.

Function buttons (Assigning frequently used functions to the buttons)

You can assign recording functions, etc. to specific buttons and icons.

1 Select the menu.

MENU → **fC [Custom]** → **[Fn Button Set]**

2 Press ▲/▼ to select the function button you want to assign a function to and then press **[MENU/SET]**.

3 Press ▲/▼ to select the function you want to assign and then press **[MENU/SET]**.

- Some functions cannot be assigned depending on the function button.

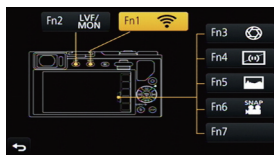

Touch screen (Touch operations)

Touch screen of this unit is capacitive. Touch the panel directly with your bare finger.

■ Touch

To touch and release the touch screen.

- When selecting features using the touch screen, be sure to touch the center of the desired icon.



■ Drag

A movement without releasing the touch screen.

This can also be used to move to the next image during playback, etc.



■ Pinch (enlarge/reduce)

Pinch the touch screen apart (enlarge) or together (reduce) with two fingers.



Non-touch-sensitive area

At the time of purchase, a part of the touch panel is set to a non-touch-sensitive area in Recording Mode to prevent accidental operation.

([Touch Screen] in [Touch Settings] in the [Custom] menu is set to [PARTIAL]). Changing the setting to [ON] allows you to deactivate the non-touch-sensitive area.)

Ⓐ Non-touch-sensitive area



Calling frequently-used menus instantly

(Quick Menu)

By using the Quick Menu, some of the menu settings can be easily found.

- The features that can be adjusted using Quick Menu are determined by the mode or a display style the camera is in.

1 Press [Q.MENU/↵] to display the Quick Menu.

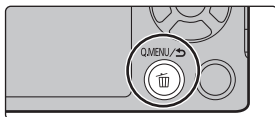

2 Rotate the rear dial to select the menu item, then press the rear dial.

3 Rotate the rear dial to select the setting.

4 Press [Q.MENU/↵] to exit the menu once the setting is complete.

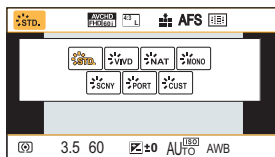

- You can close the menu by pressing the shutter button halfway.

Setting the Menu

1 Press [MENU/SET].

2 Press ▲/▼ of the cursor button to select the menu item and press [MENU/SET].

3 Press ▲/▼ of the cursor button to select the setting and press [MENU/SET].

- Depending on the menu item, its setting may not appear or it may be displayed in a different way.

■ Close the menu

Press [Q.MENU/↵] or press the shutter button halfway.

■ Switching to other menus

e.g.: Switching to the [Setup] menu from [Rec] menu.

1 Press ◀.

2 Press ▲/▼ to select a menu selector icon, such as [↵].

3 Press [MENU/SET].

- Select a menu item next and set it.

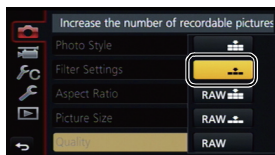
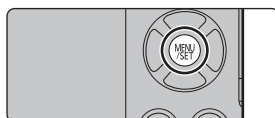

Taking Pictures using the Automatic Function

(Intelligent Auto Mode)

Recording Mode:  

In this mode, the camera makes the optimal settings for the subject and scene, so we recommend it when you wish to leave the settings to the camera and record without thinking about them.

1 Set the mode dial to .

- The camera will switch to either the most recently used of Intelligent Auto Mode or Intelligent Auto Plus Mode.

At the time of purchase, the mode is set to Intelligent Auto Plus Mode.

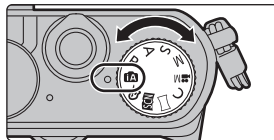

2 Align the screen with the subject.

- When the camera identifies the optimum scene, the icon of the scene concerned is displayed in blue for 2 seconds, after which its color changes to the usual red. (Automatic scene detection)

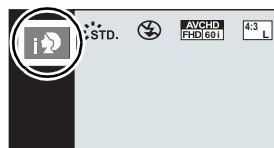

■ Switching between Intelligent Auto Plus Mode and Intelligent Auto Mode

1 Press [MENU/SET].

2 Press .

3 Press / to select the  or  tab.

4 Press / to select  or  and then press [MENU/SET].

- If [DISP.] is pressed, the description of the selected mode will be displayed.

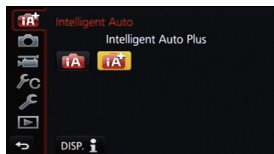

Recording night scenes ([iHandheld Night Shot])

When [iHandheld Night Shot] is set to [ON] and  is detected while taking handheld night shots, pictures of the night scenery will be taken at a high burst speed and composed into a single picture.

This mode is useful if you want to take stunning night shots with minimal jitter and noise, without using a tripod.

 →  [Rec] → [iHandheld Night Shot] → [ON]/[OFF]

Combining pictures into a single picture with rich gradation ([iHDR])

When [iHDR] is set to [ON] and there is, for example, strong contrast between the background and the subject, multiple still pictures are recorded with differing exposures and combined to create a single still picture rich in gradation.

[iHDR] works automatically as needed. When it does, [HDR] is displayed on the screen.

MENU →  **[Rec]** → **[iHDR]** → **[ON]/[OFF]**

Taking a picture with a blurred background (Defocus Control)

Recording Mode:  

You can easily set the blurriness of the background while checking the screen.

- Press the rear dial to display the setting screen.**
 - Each time the rear dial is pressed in Intelligent Auto Plus Mode, the camera switches between brightness setting operation, Defocus Control operation, and normal operation.
 - Each time the rear dial is pressed in Intelligent Auto Mode, the camera switches between Defocus Control operation and normal operation.
- Set the blurriness by rotating the rear dial.**

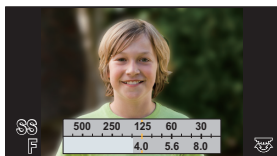

Recording images by changing the brightness or color tone

Recording Mode: 

This mode enables you to change the brightness and color tone to your preferred settings from the ones set by the camera.

■ Setting brightness

- Press the rear dial to display the setting screen.**
 - Each press of the rear dial switches among brightness setting, Defocus Control and end operation.
- Rotate the rear dial to adjust brightness.**



■ Setting color

- Press  to display the setting screen.**
- Rotate the rear dial to adjust color.**
 - This will adjust the color of the image from a reddish color to a bluish color.
 - Press [MENU/SET] to return to the recording screen.



Taking panorama pictures (Panorama Shot Mode)

Recording Mode: 

Consecutive photos taken while the camera is moved are combined to form a panorama.

- 1 Set the mode dial to .**
 - After the screen that asks you to check the recording direction is displayed, the horizontal/vertical guidelines will be displayed.
- 2 Press the shutter button halfway to focus.**
- 3 Press the shutter button fully and move the camera in a small circle in the direction of the arrow on the screen.**

Recording from left to right

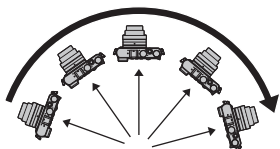

A

A Recording direction and panning (Guide)

- Move the camera at a constant speed. Pictures may not be able to be recorded properly if the camera is moved too fast or slow.

- 4 Press the shutter button once again to end the picture recording.**

- Recording can also be ended by keeping the camera still while recording.
- Recording can also be ended by moving the camera to the end of the guide.

Taking Pictures with Manual Focus

Applicable modes:   **P** **A** **S** **M**  **C**  **SCN** 



Use this function when you want to fix the focus or when the distance between the lens and the subject is determined and you do not want to activate Auto Focus.

When using an interchangeable lens (H-FS12032) with no focus ring

Press : Focuses on close-up subjects

Press : Focuses on distant subjects

A Slide bar

- These operations are possible only on the focus adjustment screen.
- Pressing and holding   will increase the focus speed.
- Focus can also be adjusted by dragging the slide bar.



A

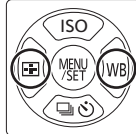

1 Set the focus mode dial to [MF].

2 Press ◀ ([MF]).

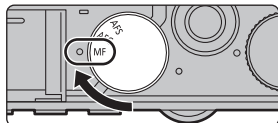

3 Press ▲/▼/◀/▶ to determine the area to be enlarged, and press [MENU/SET].

- The assist screen is displayed, enlarging the area. (MF Assist)
- If you press [DISP.], the area to be enlarged will be reset to the center.

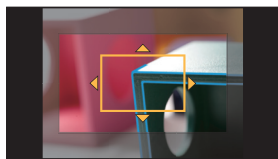

4 Adjust the focus.

- (A) Indicator for ∞ (infinity)
- (B) MF Assist (enlarged screen)
- (C) Peaking
- (D) MF Guide

- The in-focus portions will be highlighted. (Peaking)
- You can check whether the point of focus is to the near side or to the far side. (MF Guide)

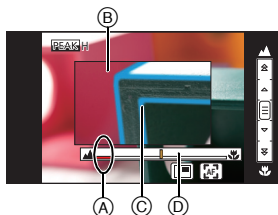

You can perform the following operations:

Button operation	Touch operation	Description of operation
▲/▼/◀/▶*	Dragging	Moves the enlarged area
—	Pinching in/out	Enlarges/reduces the screen (by steps of 0.1×)
	—	Enlarges/reduces the screen (by steps of 1.0×)
		Switches the enlarged display (windowed/full screen)
[DISP.]*	[Reset]*	Resets the area to be enlarged back to the center.

- * When using an interchangeable lens with no focus ring, you can perform these operations after pressing ▼ to display the screen that lets you set the area to be enlarged.

5 Press the shutter button halfway.

- The assist screen will close. The recording screen will be displayed.
- You can also close the assist screen by pressing [MENU/SET].

Recording Motion Picture

Applicable modes:   **P** **A** **S** **M**  **C**   

This camera can record full high definition motion pictures compatible with the AVCHD format or motion pictures recorded in MP4.

Audio will be recorded in stereo.

1 Start recording by pressing the motion picture button.

- (A) Elapsed recording time
- (B) Available recording time

- Recording of motion picture appropriate for each mode is possible.
- The recording state indicator (red)  will flash while recording motion pictures.
- If approximately 1 minute elapses without an operation being performed, part of the display will disappear. Press [DISP.] or touch the monitor to make the display reappear.
- Release the motion picture button right after you press it.

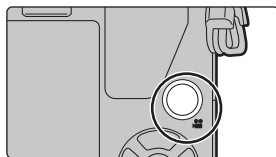

2 Stop the recording by pressing the motion picture button again.

- Still picture recording is also possible during the motion picture recording by fully pressing the shutter button.
- When a high ambient temperature, continuous recording or other conditions cause the camera to overheat, the following restrictions will occur to protect the camera. Wait until the camera cools down.
 - Continuous recording, motion picture recording, and the Wi-Fi connection will be temporarily disabled.
 - If you continue recording even when  is flashing on the screen, a message will be displayed and the camera will turn off automatically.
- It is recommended to use a fully charged battery or AC adaptor (DMW-AC10PP: optional) when recording motion pictures.
- If while recording motion pictures using the AC adaptor (DMW-AC10PP: optional) the power supply is cut off due to a power cut or if the AC adaptor (DMW-AC10PP: optional) is disconnected etc., the motion picture will not be recorded.
- Maximum time to record motion pictures continuously with [MP4] is 29 minutes 59 seconds or up to 4 GB.
(For [FHD/28M/60p]/[FHD/20M/30p] in [MP4] format, the file size is large and so the recordable time will drop below 29 minutes 59 seconds.)

Recording Snap Movies

Applicable modes:   **P** **A** **S** **M**  **C**  

You can specify the recording time in advance and record motion pictures casually like you take snapshots. The function also allows you to shift a focus at the start of recording and add fade in/out effects in advance.

- Motion pictures will be recorded with [FHD/20M/30p] in [MP4].
- Using the smartphone/tablet app “Panasonic Image App”, you can combine motion pictures recorded with the camera. Music can be added and various editing operations can be performed when you combine them. In addition, you can send the combined motion picture to a web service.

1 Select the menu. (P20)

MENU →  **[Motion Picture]** → **[Snap Movie]**

2 Select **[SET]** with **▲/▼**, and then press **[MENU/SET]**.

3 Press **▲/▼** to select an item and then press **[MENU/SET]**.

[Record time]	Sets the recording time of motion pictures.
[Pull Focus]	Allows dramatic imaging expression by shifting focus gradually at the start of recording.
[Fade]	Adds a fade-in (gradual appearance) effect to an image and audio as recording starts or adds a fade-out (gradual disappearance) effect to them as recording ends.

4 Press **[Q.MENU/↵]**.

5 Press **[MENU/SET]**.

6 Select **[ON]** with **▲/▼**, and then press **[MENU/SET]**.

- Press the shutter button halfway to exit the menu.
- If [Pull Focus] is set to [ON], set its focus.

7 Start recording by pressing the motion picture button.

- (A) Elapsed recording time
- (B) Set recording time
- Release the motion picture button right after you press it.
- You cannot stop motion picture recording in the middle. The recording will stop automatically when the set recording time has elapsed.

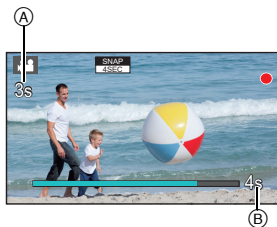

■ To deactivate Snap Movie

Select **[OFF]** in step 2.

- For details, refer to the “Owner’s Manual for advanced features (PDF format)”.

Playing Back Pictures

1 Press [▶].

2 Press ◀/▶.

◀: Play back the previous picture

▶: Play back the next picture

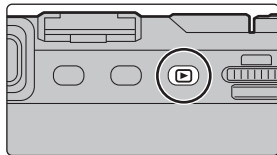

Sending an image to a web service

If you press ▼ when displaying images one by one, you can easily send an image to a web service.

• For details, refer to the "Owner's Manual for advanced features (PDF format)".

Playing Back Motion Pictures

This unit was designed to play motion pictures using the AVCHD, MP4 and QuickTime Motion JPEG formats.

• Motion pictures are displayed with the motion picture icon (▶/⏮/⏭).

Press ▲ to play back.

Ⓐ Motion picture recording time

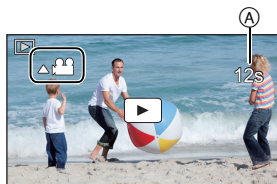

Operations during Motion Picture Playback

Button operation	Touch operation	Description of operation	Button operation	Touch operation	Description of operation
▲	▶/⏮	Play/Pause	▼	■	Stop
◀	◀◀	Fast rewind*	▶	▶▶	Fast forward*
	◀	Frame-by-frame rewind (while pausing)		▶	Frame-by-frame forward (while pausing)
🔊	−	Reduce volume level	🔊	+	Increase volume level

* The fast forward/rewind speed increases if you press ▶/◀ again.

• If you press [MENU/SET] during a pause, you can create a picture from a motion picture.

Deleting Pictures

Once deleted, pictures cannot be recovered.

To delete a single picture

1 In Playback Mode, select the picture to delete and then press [].

- The same operation can be performed by touching [].

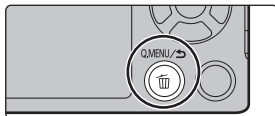

2 Press ▲ to select [Delete Single] and then press [MENU/SET].

- Confirmation screen is displayed.
Picture is deleted by selecting [Yes].

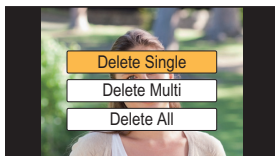

To delete multiple pictures (up to 100*) or all the pictures

- * Picture groups are treated as a single picture.
(All the pictures in the selected picture group will be deleted.)

1 In Playback Mode, press [].

2 Press ▲/▼ to select [Delete Multi] or [Delete All] and then press [MENU/SET].

- [Delete All] → Confirmation screen is displayed.
Pictures are deleted by selecting [Yes].
- It is possible to delete all pictures except the ones set as favorite when [All Delete Except Favorite] is selected with the [Delete All] set.

3 (When [Delete Multi] is selected)
Press ▲/▼/◀/▶ to select the picture, and then press [MENU/SET] to set. (Repeat this step.)

- [] appears on the selected pictures.
If [MENU/SET] is pressed again, the setting is canceled.

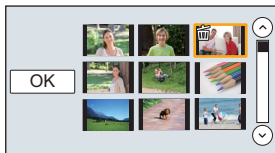

4 (When [Delete Multi] is selected)
Press ◀ to select [OK], and then press [MENU/SET] to execute.

- Confirmation screen is displayed.
Pictures are deleted by selecting [Yes].

What you can do with the Wi-Fi® function

- The camera cannot be used to connect to a public wireless LAN connection.

Controlling with a Smartphone/Tablet (P31)

- Recording with a smartphone (P31)
- Playing back pictures in the camera (P31)
- Saving images stored in the camera (P32)
- Sending images to an SNS (P32)
- Writing location information on images stored in the camera (P32)
- Combining motion pictures recorded with Snap Movie according to your preference on a smartphone/tablet (P32)



Installing the smartphone/tablet app “Image App”

- OS
 - App for Android™: Android 2.3.3 or higher*
 - Search the Google Play™ Store for “Panasonic Image App” or “LUMIX”, and install the app.
 - App for iOS: iOS 6.0 or higher (Please note that the iPhone 3GS is not supported.)
 - Search the App Store™ for “Panasonic Image App” or “LUMIX”, and install the app.
 - * Connecting to this unit with [Wi-Fi Direct] requires Android OS 4.0 or higher and Wi-Fi Direct® support.
 - Use the latest version.
 - Supported OSs are current as of September 2014 and are subject to change.
 - Read the [Help] in the “Image App” menu for further details on how to operate.
 - The service may not be able to be used properly depending on the type of smartphone being used.
- For information on the “Image App”, refer to the support site below.
- <http://panasonic.jp/support/global/cs/dsc/>
(This Site is English only.)
- When downloading the app on a mobile network, high packet communication fees may be incurred depending on the details of your contract.

Displaying pictures on a TV

Printing Wirelessly

When sending images to AV device

When sending images to PC

Using Web services



This owner's manual refer to both smartphones and tablets as “smartphones” from this point on unless noted otherwise.

- For details, refer to the “Owner’s Manual for advanced features (PDF format)”.

Connecting to a smartphone/tablet

If you are using an iOS device [iPhone/iPod touch/iPad]

Using the QR code to set up a connection

- 1 Press and hold [Wi-Fi] on the camera.

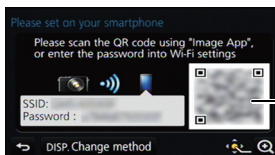
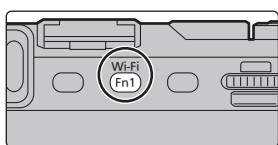

- 2 Start "Image App" on your smartphone/tablet.
- 3 Select [QR code], and then select [OK].
- 4 Using "Image App", scan the QR code displayed on the screen of the camera.
 - If you press [MENU/SET] on the camera, the QR code will be enlarged. When it is difficult to scan the QR code, try enlarging it.
- 5 Install the profile of "IMAGE APP".
 - A message will be displayed on the browser.
 - If the smartphone/tablet is locked with a passcode, enter the passcode to unlock the smartphone/tablet.
- 6 Press the home button to close the browser.
- 7 Turn on the Wi-Fi function in the setting menu of the smartphone/tablet.
- 8 Select the SSID displayed on the screen of the camera.
- 9 Return to the home screen, and then start "Image App".
 - Steps 2 through 6 are not required from the second time on.

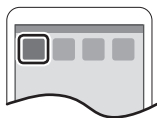

If you are using an Android device

Using the QR code to set up a connection

- 1 Press and hold [Wi-Fi] on the camera.

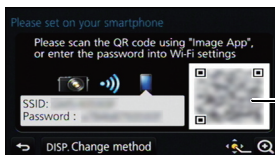
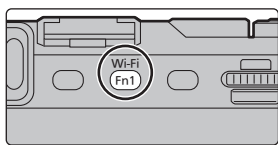

- 2 Start "Image App" on your smartphone/tablet.

- 3 Select [QR code].
- 4 Scan the QR code displayed on the screen of the camera.
 - If you press [MENU/SET] on the camera, the QR code will be enlarged. When it is difficult to scan the QR code, try enlarging it.

For both iOS devices (iPhone/iPod touch/iPad) and Android devices

Entering a password to set up a connection

- 1 Press and hold [Wi-Fi] on the camera.

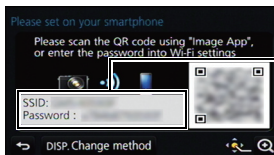
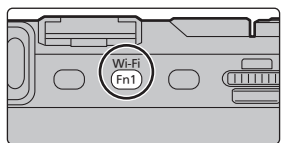

SSID and password

- 2 Turn on the Wi-Fi function in the setting menu of the smartphone/tablet.
- 3 Select the SSID displayed on the screen of the camera.
- 4 Enter the password displayed on the screen of the camera.
 - If you are using an Android device, marking the box for password display will allow the device to display the password as you enter it.
- 5 On the smartphone/tablet, start "Image App".

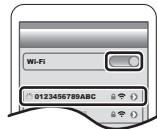

Controlling with a Smartphone/Tablet

Taking images via a smartphone/tablet (remote recording)

- 1 Connect to a smartphone. (P30)
- 2 Operate the smartphone.

- 1 Select [📱].

- 2 Record an image.

- The recorded images are saved in the camera.
- Some settings are not available.

- When a high ambient temperature, continuous recording or other conditions cause the camera to overheat, the following restrictions will occur to protect the camera. Wait until the camera cools down.
 - Continuous recording, motion picture recording, and the Wi-Fi connection will be temporarily disabled.
 - If you continue recording even when [⚠️] is flashing on the screen, a message will be displayed and the camera will turn off automatically.



Playing back images in the camera

- 1 Connect to a smartphone. (P30)
- 2 Operate the smartphone.

- 1 Select [▶].

- 2 Touch the image to enlarge it.



Saving images stored in the camera/ Sending images in the camera to an SNS

- 1 Connect to a smartphone. (P30)
- 2 Operate the smartphone.

① Select [].

② Touch and hold an image, and drag it to save it or to send it to an SNS, etc.

- The function can be assigned to the top, bottom, left or right according to your preference.
- Pictures in RAW format and motion pictures of [AVCHD] cannot be saved.



Adding location information to images stored in the camera from a smartphone/tablet

You can send location information acquired with a smartphone to the camera. After sending the information, you can also write it on images stored in the camera.

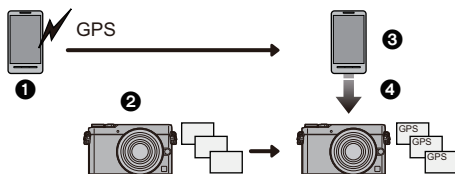

- ① Start recording location information
- ② Start recording images
- ③ Finish recording the location information
- ④ Sending and writing location information



■ Operate the smartphone

- 1 Select [].
- 2 Select [Geotagging].
- 3 Select an icon.



	Start recording location information.
	Finish recording the location information.
	Sending and writing location information. • Follow the on-screen messages to operate the smartphone.

• Cautions for Use:

Be sure to pay special attention to the privacy, the likeness rights, etc. of the subject when you use this function. Use at your own risk.

• (When using “Image App” for iOS)

If you press the Home or On/Off button of the smartphone while location information is being recorded, the recording will stop.

Combining motion pictures recorded with Snap Movie according to your preference on a smartphone/tablet

Using a smartphone, you can combine motion pictures recorded with the camera’s [Snap Movie] function (P26). Music can be added to motion pictures to be combined. In addition, you can save the combined motion picture or upload it on a web service.

- [Snap Movie] of the “Image App” requires a smartphone that supports Android OS 4.3 or higher.
- The iPhone 4 and iPod touch (4th generation) do not support [Snap Movie] of the “Image App”.
- For details, refer to the “Owner’s Manual for advanced features (PDF format)”.

About the supplied software

The supplied DVD includes the following software.
Install the software on to your computer before use.

- **PHOTOfunSTUDIO 9.6 PE** (Windows Vista/Windows 7/Windows 8/Windows 8.1)
- **SILKYPIX Developer Studio 4.2 SE** (Windows Vista/Windows 7/Windows 8/Windows 8.1, Mac OS X v10.5/v10.6/v10.7/v10.8/v10.9)

For details on how to use the SILKYPIX Developer Studio, refer to the “Help” or the Ichikawa Soft Laboratory’s support website:
<http://www.isl.co.jp/SILKYPIX/english/p/support/>

- **LoiLoScope 30 day full trial version** (Windows Vista/Windows 7/Windows 8/Windows 8.1)

For more information on how to use LoiLoScope, read the LoiLoScope manual available for download at the link below.
Manual URL: <http://loilo.tv/product/20>

■ Installing supplied software

- Before inserting the DVD, close all running applications.

1 Check the environment of your PC.

- For details about information such as the operating environment or operating method, refer to the “Owner’s Manual for advanced features (PDF format)” or the operating instructions for the respective software programmes.

2 Insert the DVD with the supplied software.

- If the automatic playback screen is displayed, you can display the menu by selecting and executing [Launcher.exe].
- In Windows 8/Windows 8.1, you can display the menu by clicking a message that is displayed after inserting the DVD and then selecting and executing [Launcher.exe].
- You can also display the menu by double-clicking [SFMXXXX] in [Computer] (XXXX differs depending on the model).

3 Click [Applications].

4 Click on the [Recommended Installation] on the install menu to install.

- Proceed with installation according to messages appearing on the screen.

- The software compatible with your PC will be installed.
- On the Mac, SILKYPIX can be installed manually.
 - 1 Insert the DVD with the supplied software.
 - 2 Double-click the application folder on the DVD.
 - 3 Double-click on the automatically displayed folder.
 - 4 Double-click the icon in the application folder.



Not available in these cases:

- “PHOTOfunSTUDIO” and “LoiLoScope” are not compatible with Mac.

Monitor Display/Viewfinder Display

- The following images are examples of when the display screen is set to [] (monitor style) in the monitor.



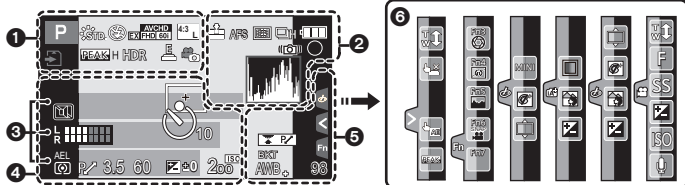







In recording

























1		Recording Mode (P18)
	C 1	Custom settings
	STD. VIVID NAT MONO SCNY PORT CUST	Photo Style
		Flash Mode
		Flash
		Extended Tele Conversion (when recording motion pictures)
		Recording format/Recording quality
		Snap Movie (P26)
		Picture size/Aspect Ratio
		Extended Tele Conversion (when taking still pictures)
		Image effect (filter) adjustment display
	EXPS	Image effect (filter) setting
		Card (displayed only during recording)
	8m30s	Elapsed recording time*1
		Simultaneous recording indicator
	LVF/ MON AUTO	Automatic viewfinder/monitor switching (P18)
	PEAK H PEAK L	Peaking

	Highlight Shadow
HDR	HDR/iHDR (P22)
	Multi exposure
	Digital Zoom
	Electronic shutter
	Picture Mode (Still picture priorities)
	Overheat indicator (P39)

2		
	RAW	Quality
AFS AFF AFC MF	Focus Mode	
	AF Mode	
	Pull Focus (P26)	
	Face Recognition	
AFL	AF Lock	
	Burst	
	Auto Bracket	
	Self-timer	
	Battery indication	
	Optical Image Stabilizer*2	
	Jitter alert	
	Recording state (Flashes red./Focus (Lights green.))	
	Focus (Under low illumination)	
	Connected to Wi-Fi	
	Histogram	

3		98	Number of recordable pictures ^{*6}
Name ^{*3}		R8m30s	Available recording time ^{*1,6}
Number of days that have passed since the departure date ^{*4}			
Age ^{*3}			
Location ^{*4}			
Current date and time/Travel destination setting ^{*4} :			
✈			
Exposure meter			
Focal distance display			
Step zoom			
4			
	AF area		
+	Spot metering target		
	Self-timer ^{*5}		
	Mic level display		
	Silent Mode		
AEL	AE Lock		
	Metering Mode		
P	Program Shift		
3.5	Aperture value (P17)		
60	Shutter speed (P17)		
	Exposure compensation value		
	Brightness (P22)		
	Manual Exposure Assistance		
	ISO sensitivity		
5			
	Dial operation guide		
BKT	White Balance Bracket		
AWB	White Balance Fine Adjustment		
	White Balance		
	Color (P22)		

6			
	Touch tab		
	Touch zoom		
	Touch Shutter		
	Touch AE		
	Peaking		
	Function button (P19)	 Fn3	 Fn4
		 Fn5	
		 Fn6	 Fn7
	Color		
	Defocus control function (P22)		
	Brightness (P22)		
	Type of defocus ([Miniature Effect])		
	One point color		
	Position of the light source		
	Image effect (filter) adjustment		
	Image effect (filter)		
	Aperture value (P17)		
	Shutter speed (P17)		
	ISO sensitivity		
	Microphone level adjustment		

*1 h: hour, m: minute, s: second

*2 Only available when a lens that supports the Stabilizer function is attached.

*3 This is displayed for about 5 seconds when the camera is turned on if the [Profile Setup] setting is set.

*4 This is displayed for about 5 seconds when the camera is turned on, after setting the clock and after switching from Playback Mode to Recording Mode.

*5 This is displayed during countdown.

*6 It is possible to switch the display between the number of recordable pictures and available recording time with the [Remaining Disp.] setting in the [Custom] menu.

In recording

On-monitor recording information

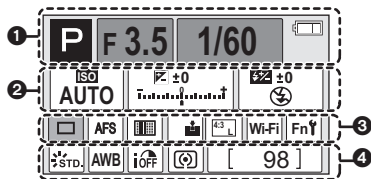

1		Recording Mode (P18)
	F3.5	Aperture value (P17)
	1/60	Shutter speed (P17)
		Battery indication

2		ISO sensitivity
	AUTO	ISO sensitivity
		Exposure compensation value
		Brightness (P22)
		Manual Exposure Assistance
		Flash Mode
		Flash

3		Single
		Burst
		Auto Bracket
		Self-timer
		Focus Mode
		AF Mode
		Quality
		Picture size/Aspect Ratio
	Wi-Fi	Wi-Fi
		Function button setting (P19)
4		Photo Style
		White Balance
		Intelligent Dynamic Range Control
		Metering Mode
	98	Number of recordable pictures
	R8m30s	Available recording time

Menu list



To display explanations of the menu items.

When [Menu Information] in the [Setup] menu is set to [ON], explanations of the menu items and settings are displayed on the menu screen.

Ⓐ Explanations of the menu

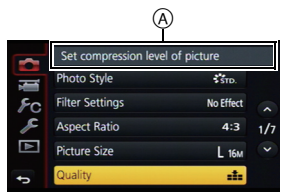

[Rec]

This menu lets you set the aspect ratio, number of pixels and other aspects of the pictures you are recording.

[Photo Style]	[i.Resolution]	[ISO Increments]
[Filter Settings]	[iHandheld Night Shot]	[Extended ISO]
[Aspect Ratio]	[iHDR]	[Long Shtr NR]
[Picture Size]	[HDR]	[Shading Comp.]
[Quality]	[Multi Exp.]	[Ex. Tele Conv.]
[AFS/AFF]	[Time Lapse Shot]	[Digital Zoom]
[Metering Mode]	[Stop Motion Animation]	[Color Space]
[Burst Rate]	[Panorama Direction]	[Stabilizer]
[Auto Bracket]	[Shutter Type]	[Face Recog.]
[Self Timer]	[Flash]	[Profile Setup]
[Highlight Shadow]	[Red-Eye Removal]	
[i.Dynamic]	[ISO Limit Set]	

[Motion Picture]

This menu lets you set the [Rec Format], [Rec Quality], and other aspects for motion picture recording.

[Photo Style]	[Picture Mode]	[Digital Zoom]
[Filter Settings]	[Continuous AF]	[Fikr Decrease]
[Snap Movie]	[Metering Mode]	[Silent Operation]
[Rec Format]	[Highlight Shadow]	[Mic Level Disp.]
[Rec Quality]	[i.Dynamic]	[Mic Level Adj.]
[Exposure Mode]	[i.Resolution]	[Wind Cut]
[AFS/AFF]	[Ex. Tele Conv.]	

- [Photo Style], [Filter Settings], [AFS/AFF], [Metering Mode], [Highlight Shadow], [i.Dynamic], [i.Resolution] and [Digital Zoom] are common to both the [Rec] menu and [Motion Picture] menu. Changing these settings in one of these menus is reflected in other menu.

[Custom]

Operation of the unit, such as displaying of the screen and button operations, can be set up according to your preferences. Also, it is possible to register the modified settings.

[Cust.Set Mem.]	[Peaking]	[Remaining Disp.]
[Silent Mode]	[Histogram]	[Auto Review]
[AF/AE Lock]	[Guide Line]	[Fn Button Set]
[Half Press Release]	[Highlight]	[Q.MENU]
[Quick AF]	[Zebra Pattern]	[Video Button]
[Eye Sensor AF]	[Monochrome Live View]	[Power Zoom Lens]
[Pinpoint AF Time]	[Constant Preview]	[Eye Sensor]
[AF Assist Lamp]	[Expo.Meter]	[Touch Settings]
[Direct Focus Area]	[Dial Guide]	[Touch Scroll]
[Focus/Release Priority]	[LVF Disp.Style]	[Menu Guide]
[AF+MF]	[Monitor Disp. Style]	[Shoot w/o Lens]
[MF Assist]	[Monitor Info. Disp.]	
[MF Guide]	[Rec Area]	

[Setup]

This menu lets you perform the clock settings, select the operating beep tone settings and set other settings which make it easier for you to operate the camera.

You can also configure the settings of Wi-Fi related functions.

[Clock Set]	[Economy]	[Exposure Comp. Reset]
[World Time]	[USB Mode]	[Self Timer Auto Off]
[Travel Date]	[TV Connection]	[No.Reset]
[Wi-Fi]	[Menu Resume]	[Reset]
[Beep]	[Menu Background]	[Reset Wi-Fi Settings]
[Live View Mode]	[Menu Information]	[Pixel Refresh]
[Monitor Display]/[Viewfinder]	[Language]	[Sensor Cleaning]
[Monitor Luminance]	[Version Disp.]	[Format]

[Playback]

This menu lets you set the Protection, Cropping or Print Settings, etc. of recorded pictures.

[2D/3D Settings]	[Video Divide]	[Favorite]
[Slide Show]	[Time Lapse Video]	[Print Set]
[Playback Mode]	[Stop Motion Video]	[Protect]
[Location Logging]	[Resize]	[Face Rec Edit]
[Clear Retouch]	[Cropping]	[Picture Sort]
[Title Edit]	[Rotate]	[Delete Confirmation]
[Text Stamp]	[Rotate Disp.]	

Troubleshooting

First, try out the following procedures.

If the problem is not resolved, it may be improved by selecting [Reset] on the [Setup] menu.

- Please also refer to the "Owner's Manual for advanced features (PDF format)", which describes more detailed information.

**The camera cannot be operated even when it is turned on.
The camera turns off immediately after it is turned on.**

- The battery is exhausted.
→ Charge the battery.
- If you leave the camera on, the battery will be exhausted.
→ Turn the camera off frequently by using the [Economy] etc.

This unit suddenly turns off during recording.

- When a high ambient temperature, continuous recording or other conditions cause the camera to overheat, the following restrictions will occur to protect the camera. Wait until the camera cools down.
– Continuous recording, motion picture recording, and the Wi-Fi connection will be temporarily disabled.
– If you continue recording even when [>] is flashing on the screen, a message will be displayed and the camera will turn off automatically.

The subject is not focused properly.

- The subject is beyond the focus range of the camera.
- There is camera shake (jitter) or the subject is moving slightly.
- Is [Focus/Release Priority] in the [Custom] menu set to [RELEASE]?

**The recorded picture is blurred.
The Optical Image Stabilizer is not effective.**

- The shutter speed will become slower and the Optical Image Stabilizer function may not work properly when taking pictures especially in dark places.
→ We recommend holding the camera firmly with both hands when taking pictures.
→ We recommend using a tripod and the self-timer when taking pictures with a slow shutter speed.
- When a moving subject is recorded with the electronic shutter, the subject may appear distorted on the picture.

Striping or flicker may appear under lighting such as fluorescent lighting and LED lighting fixture.

- This is characteristic of MOS sensors which serve as the camera's pickup sensors.
This is not a malfunction.
- Are you taking pictures with the electronic shutter?
→ When using the electronic shutter, lowering the shutter speed may reduce the effect of the horizontal stripes.

The brightness or the hue of the recorded picture is different from the actual scene.

- When recording under fluorescent or LED lighting fixture, etc., increasing the shutter speed may introduce slight changes to brightness and color. These are a result of the characteristics of the light source and do not indicate a malfunction.
- When recording subjects in extremely bright locations or recording under fluorescent lighting, LED lighting fixture, mercury lamp, sodium lighting, etc., the colors and screen brightness may change or horizontal striping may appear on the screen.

The flash is not activated.

- Is the flash (supplied) turned off?
→ Turn on the flash. (P12)
- When the electronic shutter is used, the flash is not activated.
→ Set [Shutter Type] to [AUTO] or [EFC].
- When [Silent Mode] is set to [ON], the flash is not activated.
→ Set [Silent Mode] to [OFF].

The monitor displays distorted images.

- The monitor may display distorted images in high ambient temperatures, but this does not affect images to be recorded.

The outlines of fluorescent lights and other bright light sources flicker on the monitor.

- This is a characteristic of the camera's monitor and is not a malfunction. Images to be recorded will not be affected.

Horizontal stripes appear when the monitor is viewed from an angle in an outside environment exposed to strong sunlight.

- This is a characteristic of the camera's monitor and is not a malfunction. Images to be recorded will not be affected.

**The picture is not played back.
There are no recorded pictures.**

- Is the card inserted? Is there a picture on the card?
- Is this a folder or picture which was processed in the PC?
If it is, it cannot be played back by this unit.
→ It is recommended to use the "PHOTOfunSTUDIO" software in the DVD (supplied) to write pictures from PC to card.
- Has [Playback Mode] been set for playback?
→ Change to [Normal Play].

Motion pictures recorded with this model cannot be played back on other equipment.

- The picture quality or sound quality of recorded motion pictures may be deteriorated even when these are played back with the compatible devices. Also, recording information may not be displayed correctly.

**A Wi-Fi connection cannot be established.
Radio waves get disconnected.
Wireless access point is not displayed.**

■ General tips for using a Wi-Fi connection

- Use within the communication range of the device to be connected.
- Is any device, such as microwave oven, cordless phone, etc., that uses 2.4 GHz frequency operated nearby?
 - Radio waves may get interrupted when used simultaneously. Use them sufficiently away from the device.
- When the battery indicator is flashing red, the connection with other equipment may not start or the connection may be disrupted.
(A message such as [Communication error] is displayed.)
- If you place the camera on a metal table or shelf, the radio waves may be adversely affected. In such cases, you may not be able to establish a connection. Move the camera away from the metal surface.

■ About a wireless access point

- Check if the wireless access point to connect is in operating state.
- The camera may not display or connect to a wireless access point depending on the radio wave condition.
 - Move this unit closer to the wireless access point.
 - Remove the obstacles between this unit and the wireless access point.
 - Change the direction of this unit.
 - Change the location and orientation of the wireless access point.
 - Perform the [Manual Input].
- It may not display even if the radio waves exist depending on the setting of the wireless access point.
 - Check the settings of the wireless access point.
 - When the network SSID of the wireless access point is set not to broadcast, the wireless access point may not be detected. Enter the network SSID to start the connection or enable the SSID broadcast of the wireless access point.
- Connection types and security setting methods are different depending on the wireless access point. (Refer to the operating instructions of the wireless access point.)
- Is the 5 GHz/2.4 GHz switchable wireless access point connected to other equipment using the 5 GHz band?
 - The use of a wireless access point that can use 5 GHz/2.4 GHz simultaneously is recommended. It cannot be used simultaneously with this camera if it is not compatible.

Images cannot be transmitted to a PC.

- When the firewall of the OS, security software, etc. is enabled, connecting to the PC may not be possible.

The PC is not recognized when I use a Wi-Fi connection. The camera cannot be connected to PC via Wi-Fi connection.

- The default workgroup name is set to "WORKGROUP". If you changed the workgroup name, the PC will not be recognized.
In [Change Workgroup Name] in [PC Connection] of the [Wi-Fi Setup] menu, change the workgroup name to that of the PC you are connecting to.
- When the system time of Mac computer or Windows PC connected to a camera differs severely from that of the camera, the camera cannot be connected to the computer or PC in some OSs.

When I try to set up a Wi-Fi connection with a Windows 8 PC, my user name and password are not recognized, so I cannot connect to the PC.

- Some OS versions, including Windows 8, use two types of accounts: a local account and a Microsoft account.
→ Be sure to use the user name and password for the local account.

Transmission of the image fails midway. Some images cannot be transmitted.

- Image cannot be transmitted when the battery indicator is flashing red.
- Is the size of the image too large?
→ Reduce the image size at [Size], and then send.
→ Transmit after dividing the motion picture with [Video Divide].
- File format of the motion picture that can be sent differs depending on the destination.
- Capacity or number of images in the web service is full.
→ Login to "LUMIX CLUB", and check the status of the destination on the web service link settings.

The shutter remains closed when the camera is turned off (including Sleep Mode).

- If the camera is shaken, it may cause the shutter to close. This is not a malfunction. Do not put your finger in the mount. Turning on the camera will re-open the shutter.

There is a sound from lens unit.

- It is a sound of lens movement or aperture operation when this unit is turned on or off, and it is not a malfunction.
- The sound, which is caused by the automatic adjustment of the aperture, is heard when the brightness has changed due to, for example, zooming or the movement of the camera. This is not a malfunction.

The camera becomes warm.

- The surface of the camera may become warm during use. This does not affect the performance or quality of the camera.

The clock is reset.

- If you do not use the camera for a long time, the clock may be reset.
→ [Please set the clock] message will be displayed; please reset the clock. (P16)

Specifications

Specifications are subject to change without notice.

Digital Camera Body (DMC-GM5):

Information for your safety

Power Source:	DC 8.4 V	
Power Consumption:	2.3 W (When recording with Monitor) [When the Interchangeable lens (H-FS12032) is used] 1.6 W (When playing back with Monitor) [When the Interchangeable lens (H-FS12032) is used]	
Camera effective pixels	16,000,000 pixels	
Image sensor	4/3" Live MOS sensor, total pixel number 16,840,000 pixels, Primary color filter	
Digital Zoom	Max. 4×	
Extended Tele Conversion	When taking still pictures: Max. 2× (When a picture size of [S] (4 M), aspect ratio of [4:3] is selected.) When recording motion pictures: 2.4×/3.6×/4.8×	
Focus	Auto Focus/Manual Focus, Face/Eye Detection/AF Tracking/23-area-focusing/ 1-area-focusing/Pinpoint (Touch focus area selection possible)	
Shutter type	Electronically-controlled, Single curtain focal-plane shutter/ Electronic shutter	
Burst recording		
Burst speed	Mechanical shutter	5.8 pictures/second (High speed, AFS), 5 pictures/second (High speed, AFC), 4 pictures/second (Middle speed), 2 pictures/second (Low speed)
	Electronic shutter	40 pictures/second (Super high speed), 10 pictures/second (High speed), 4 pictures/second (Middle speed), 2 pictures/second (Low speed)
Number of recordable pictures	Max. 7 pictures (when there are RAW files) Depends on the capacity of the card (when there are no RAW files)	
ISO sensitivity (Standard Output Sensitivity)	AUTO/ $\frac{1}{2}$ ISO/100*/200/400/800/1600/3200/6400/12800/25600 (1/3 EV step change possible) * Only available when [Extended ISO] is set.	
Minimum Illumination	Approx. 9 lx (when i-Low light is used, the shutter speed is 1/30th of a second) [When the Interchangeable lens (H-FS12032) is used]	

Shutter speed	Still picture: T (Time) (Max. approx. 60 seconds), 60 seconds to 1/500th of a second (Mechanical shutter), 1 second to 1/16000th of a second (Electronic shutter) Motion picture: 1/25th of a second to 1/16000th of a second
Metering range	EV 0 to EV 18
White Balance	Auto White Balance/Daylight/Cloudy/Shade/Incandescent lights/Flash/White set1/White set2/White Balance K set
Exposure (AE)	Program AE (P)/Aperture-priority AE (A)/Shutter-priority AE (S)/Manual exposure (M)/AUTO Exposure Compensation (1/3 EV Step, -5 EV to +5 EV)
Metering Mode	Multiple/Center weighted/Spot
Monitor	3.0" TFT LCD (16:9) (Approx. 920,000 dots) (field of view ratio about 100%) Touch screen
Viewfinder	Live Viewfinder (4:3) (Approx. 1,170,000 dots equivalent) (field of view ratio about 100%) (with diopter adjustment -4 to +4 diopter)
Flash Mode	AUTO, AUTO/Red-Eye Reduction, Forced ON, Forced ON/ Red-Eye Reduction, Slow Sync., Slow Sync./Red-Eye Reduction, Forced OFF
Flash synchronization speed	Equal to or smaller than 1/50th of a second (Mechanical shutter)
Microphone	Stereo
Speaker	Monaural
Recording media	SD Memory Card/SDHC Memory Card*/SDXC Memory Card* (* UHS-I-compatible)
Picture size	
Still picture	When the aspect ratio setting is [4:3] 4592×3448 pixels, 3232×2424 pixels, 2272×1704 pixels When the aspect ratio setting is [3:2] 4592×3064 pixels, 3232×2160 pixels, 2272×1520 pixels When the aspect ratio setting is [16:9] 4592×2584 pixels, 3840×2160 pixels, 1920×1080 pixels When the aspect ratio setting is [1:1] 3424×3424 pixels, 2416×2416 pixels, 1712×1712 pixels

Recording quality	
Motion pictures	[AVCHD] 1920×1080/60p/(Sensor output is 60 frames/sec.) (28 Mbps)/ 1920×1080/60i/(Sensor output is 60 frames/sec.) (17 Mbps)/ 1920×1080/60i/(Sensor output is 30 frames/sec.) (24 Mbps)/ 1920×1080/24p/(Sensor output is 24 frames/sec.) (24 Mbps) [MP4] 1920×1080/60p/(Sensor output is 60 frames/sec.) (28 Mbps)/ 1920×1080/30p/(Sensor output is 30 frames/sec.) (20 Mbps)/ 1280×720/30p/(Sensor output is 30 frames/sec.) (10 Mbps)/ 640×480/30p/(Sensor output is 30 frames/sec.) (4 Mbps)
Quality	RAW/RAW+Fine/RAW+Standard/Fine/Standard/MPO+Fine/ MPO+Standard
Recording file format	
Still Picture	RAW/JPEG (based on "Design rule for Camera File system", based on "Exif 2.3" standard, DPOF corresponding)/MPO
Motion pictures	AVCHD Progressive/AVCHD/MP4
Audio compression	AVCHD Dolby® Digital (2 ch) MP4 AAC (2 ch)
Interface	
Digital	"USB 2.0" (High Speed)
Analog video/audio	NTSC Audio line output (monaural)
Terminal	
[AV OUT/DIGITAL]	Dedicated jack (8 pin)
[HDMI]	MicroHDMI Type D
Dimensions	Approx. 98.5 mm (W)×59.5 mm (H)×36.1 mm (D) [3.88" (W)×2.34"(H)×1.42" (D)] (excluding the projecting parts)
Mass (weight)	Approx. 211 g/0.46 lb [with the card and battery] Approx. 180 g/0.40 lb (camera body) Approx. 281 g/0.62 lb [with the Interchangeable lens (H-FS12032), card and battery]
Operating temperature	0 °C to 40 °C (32 °F to 104 °F)
Operating humidity	10%RH to 80%RH
Language select	[ENGLISH]/[ESPAÑOL]

Wireless transmitter

Compliance standard	IEEE 802.11b/g/n (standard wireless LAN protocol)
Frequency range used (central frequency)	2412 MHz to 2462 MHz (1 to 11ch)
Encryption method	Wi-Fi compliant WPA™/WPA2™
Access method	Infrastructure mode

Battery Charger (Panasonic DE-A99B):

Information for your safety

Input:	~ 110 V to 240 V, 50/60 Hz, 0.15 A
Output:	=== 8.4 V, 0.43 A

Equipment mobility:

Movable

Battery Pack (lithium-ion) (Panasonic DMW-BLH7PP):

Information for your safety

Voltage/capacity:	7.2 V/680 mAh
--------------------------	---------------

Flash (supplied):

Guide number:	10 equivalent (ISO 200-m), 7 equivalent (ISO 100-m)
Lighting angle:	24 mm (35 mm film camera equivalent)

Interchangeable Lens	H-FS12032 “LUMIX G VARIO 12–32 mm/F3.5–5.6 ASPH./MEGA O.I.S.”
Focal length	f=12 mm to 32 mm (35 mm film camera equivalent: 24 mm to 64 mm)
Aperture type	7 diaphragm blades/circular aperture diaphragm
Aperture range	F3.5 (Wide) to F5.6 (Tele)
Minimum aperture value	F22
Lens construction	8 elements in 7 groups (3 aspherical lenses, 1 ED lenses)
In focus distance	0.2 m (0.66 feet) to ∞ (from the focus distance reference line) (focal length 12 mm to 20 mm), 0.3 m (0.98 feet) to ∞ (from the focus distance reference line) (focal length 21 mm to 32 mm)
Maximum image magnification	0.13× (35 mm film camera equivalent: 0.26×)
Optical Image Stabilizer	Available
[O.I.S.] switch	None (Setting of the [Stabilizer] is done in [Rec] menu.)
Mount	“Micro Four Thirds Mount”
Angle of view	84° (Wide) to 37° (Tele)
Filter diameter	37 mm
Max. diameter	Approx. 55.5 mm (2.2 inch)
Overall length	Approx. 24 mm (0.94 inch) (from the tip of the lens to the base side of the lens mount when the lens barrel is recessed)
Mass (weight)	Approx. 70 g/0.15 lb

Digital Camera Accessory System

Description	Accessory#
Battery Pack	DMW-BLH7
AC Adaptor ^{*1}	DMW-AC10
DC Coupler ^{*1}	DMW-DCC15
Flash	DMW-FL360L, DMW-FL580L
LED Video Light	VW-LED1
Body Cap	DMW-BDC1
Hand grip	DMW-HGR1
Tripod Adaptor ^{*2}	DMW-TA1
USB connection Cable	DMW-USBC1
AV Cable	DMW-AVC1
Mount Adaptor	DMW-MA1, DMW-MA2M, DMW-MA3R

*1 The AC Adaptor (optional) can only be used with the designated Panasonic DC Coupler (optional). The AC adaptor (optional) cannot be used by itself.

*2 Use if the attached lens is in contact with the tripod pedestal.

Product numbers correct as of September 2014. These may be subject to change.

- Some optional accessories may not be available in some countries.
- NOTE: Accessories and/or model numbers may vary between countries. Consult your local dealer.
- For lens-related optional accessories such as compatible lenses and filters, refer to catalogs/ Web pages, etc.

Reading the Owner's Manual (PDF format)

More detailed instructions on the operation of this camera are contained in "Owner's Manual for advanced features (PDF format)" in the supplied DVD. Install it on your PC to read it.

■ For Windows

1 Turn the PC on and insert the DVD containing the Owner's Manual (supplied).

2 Click the [Owner's Manual].

- If the automatic playback screen is displayed, you can display the menu by selecting and executing [Launcher.exe].
- In Windows 8/Windows 8.1, you can display the menu by clicking a message that is displayed after inserting the DVD and then selecting and executing [Launcher.exe].
- You can also display the menu by double-clicking [SFMXXXX] in [Computer] (XXXX differs depending on the model).

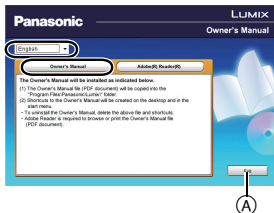

3 Select the desired language and then click [Owner's Manual] to install.

Ⓐ To return to the install menu.

4 Double click the "Owner's Manual" shortcut icon on the desktop.

■ When the Owner's Manual (PDF format) will not open

You will need Adobe Acrobat Reader 5.0 or later or Adobe Reader 7.0 or later to browse or print the Owner's Manual (PDF format).

- You can download and install a version of Adobe Reader that you can use with your OS from the following Web Site.

<http://get.adobe.com/reader/otherversions>

■ To uninstall the Owner's Manual (PDF format)

Delete the PDF file from the "Program Files\Panasonic\Lumix\" folder.

■ For Mac

1 Turn the PC on and insert the DVD containing the Owner's Manual (supplied).

2 Open the "Manual" folder in the DVD.

- "Manual" folder is displayed again.

3 Open the "Manual" folder in the DVD and then copy the PDF file with the desired language inside the folder.

4 Double click the PDF file to open it.

Digital Camera Accessory Order Form

(For USA Customers)

Please photocopy this form when placing an order.

1. Digital Camera Model # _____

2. Items Ordered

Accessory #	Description	Price Each	Quantity	Total Price
Shipping & Handling				\$6.95
Subtotal				
Your State & Local Sales Tax				
Total				

3. Method of payment (check one)

American Express

VISA

Credit Card # _____

MasterCard

Expiration Date _____

Discover

Customer Signature _____

(Please do not send cash)

4. Shipping information (UPS delivery requires complete street address)

Ship To:

Mr.

Mrs.

Ms.

First _____ Last _____

Phone#:

Day () _____

Street Address _____

Night () _____

City _____ State _____ Zip _____

TO OBTAIN ANY OF OUR DIGITAL CAMERA ACCESSORIES YOU CAN DO ANY OF
THE FOLLOWING:

VISIT YOUR LOCAL PANASONIC DEALER

OR

YOU MAY CONTACT US DIRECTLY AT:

1-800-237-9080 (FAX ONLY)

OR

MAIL THIS ORDER TO: PANASONIC NATIONAL PARTS CENTER

20421 84th Avenue South, Kent, WA 98032

Limited Warranty (ONLY FOR U.S.A.)

Panasonic Products Limited Warranty

Limited Warranty Coverage (For USA Only)

If your product does not work properly because of a defect in materials or workmanship, Panasonic Corporation of North America (referred to as “the warrantor”) will, for the length of the period indicated on the chart below, which starts with the date of original purchase (“warranty period”), at its option either (a) repair your product with new or refurbished parts, (b) replace it with a new or a refurbished equivalent value product, or (c) refund your purchase price. The decision to repair, replace or refund will be made by the warrantor.

Product or Part Name	Parts	Labor
Digital Camera	1 Year	1 Year
All included Accessories (Except Non-Rechargeable Batteries)	90 Days	Not Applicable
Only Non-Rechargeable Batteries	10 Days	Not Applicable

During the “Labor” warranty period there will be no charge for labor. During the “Parts” warranty period, there will be no charge for parts. This Limited Warranty excludes both parts and labor for non-rechargeable batteries, antennas, and cosmetic parts (cabinet). This warranty only applies to products purchased and serviced in the United States. This warranty is extended only to the original purchaser of a new product which was not sold “as is”.

Mail-In Service--Online Repair Request

Online Repair Request

To submit a new repair request and for quick repair status visit our Web Site at www.panasonic.com/repair.

When shipping the unit, carefully pack, include all supplied accessories listed in the Owner's Manual, and send it prepaid, adequately insured and packed well in a carton box. When shipping Lithium Ion batteries please visit our Web Site at www.panasonic.com/BatteryHandling as Panasonic is committed to providing the most up to date information. Include a letter detailing the complaint, a return address and provide a daytime phone number where you can be reached. A valid registered receipt is required under the Limited Warranty.

IF REPAIR IS NEEDED DURING THE WARRANTY PERIOD, THE PURCHASER WILL BE REQUIRED TO FURNISH A SALES RECEIPT/PROOF OF PURCHASE INDICATING DATE OF PURCHASE, AMOUNT PAID AND PLACE OF PURCHASE. CUSTOMER WILL BE CHARGED FOR THE REPAIR OF ANY UNIT RECEIVED WITHOUT SUCH PROOF OF PURCHASE.

Limited Warranty Limits And Exclusions

This warranty ONLY COVERS failures due to defects in materials or workmanship, and DOES NOT COVER normal wear and tear or cosmetic damage. The warranty ALSO DOES NOT COVER damages which occurred in shipment, or failures which are caused by products not supplied by the warrantor, or failures which result from accidents, misuse, abuse, neglect, mishandling, misapplication, alteration, faulty installation, set-up adjustments, misadjustment of consumer controls, improper maintenance, power line surge, lightning damage, modification, introduction of sand, humidity or liquids, commercial use such as hotel, office, restaurant, or other business or rental use of the product, or service by anyone other than a Factory Service Center or other Authorized Servicer, or damage that is attributable to acts of God.

THERE ARE NO EXPRESS WARRANTIES EXCEPT AS LISTED UNDER "LIMITED WARRANTY COVERAGE".

THE WARRANTOR IS NOT LIABLE FOR INCIDENTAL OR CONSEQUENTIAL DAMAGES RESULTING FROM THE USE OF THIS PRODUCT, OR ARISING OUT OF ANY BREACH OF THIS WARRANTY.

(As examples, this excludes damages for lost time, travel to and from the servicer, loss of or damage to media or images, data or other memory or recorded content. The items listed are not exclusive, but for illustration only.)

ALL EXPRESS AND IMPLIED WARRANTIES, INCLUDING THE WARRANTY OF MERCHANTABILITY, ARE LIMITED TO THE PERIOD OF THE LIMITED WARRANTY.

Some states do not allow the exclusion or limitation of incidental or consequential damages, or limitations on how long an implied warranty lasts, so the exclusions may not apply to you. This warranty gives you specific legal rights and you may also have other rights which vary from state to state. If a problem with this product develops during or after the warranty period, you may contact your dealer or Service Center. If the problem is not handled to your satisfaction, then write to the warrantor's Consumer Affairs Department at the addresses listed for the warrantor.

PARTS AND SERVICE, WHICH ARE NOT COVERED BY THIS LIMITED WARRANTY, ARE YOUR RESPONSIBILITY.

Customer Services Directory (United States)

Obtain Product Information and Operating Assistance; locate your nearest Dealer or Service Center; purchase Parts and Accessories; or make Customer Service and Literature requests by visiting our Web Site at:

<http://www.panasonic.com/support>

or, contact us via the web at:

<http://www.panasonic.com/contactinfo>

For hearing or speech impaired TTY users, TTY: 1-877-833-8855

Accessory Purchases (United States)

Purchase Parts, Accessories and Owner's Manual online for all Panasonic Products by visiting our Web Site at:

<http://www.pstc.panasonic.com>

Or, send your request by E-mail to:

npcparts@us.panasonic.com

You may also contact us directly at:

1-800-237-9080 (Fax Only)

(Monday-Friday 9am-9pm EST)

Panasonic National Parts Center

20421 84th Avenue South, Kent, WA 98032

(We accept Visa, MasterCard, Discover Card, American Express)

For hearing or speech impaired TTY users, TTY: 1-866-605-1277

As of April 2014

This product incorporates the following software:

- (1) the software developed independently by or for Panasonic Corporation,
- (2) the software owned by third party and licensed to Panasonic Corporation, and/or
- (3) open source software

The software categorized as (3) is distributed in the hope that it will be useful, but WITHOUT ANY WARRANTY, without even the implied warranty of MERCHANTABILITY or FITNESS FOR A PARTICULAR PURPOSE.

Please refer to the detailed terms and conditions thereof displayed by selecting [MENU/SET] → [Setup] → [Version Disp.] → [Software info].

- G MICRO SYSTEM is a lens exchange type digital camera system of LUMIX based on a Micro Four Thirds System standard.
- Micro Four Thirds™ and Micro Four Thirds Logo marks are trademarks or registered trademarks of Olympus Imaging Corporation, in Japan, the United States, the European Union and other countries.
- Four Thirds™ and Four Thirds Logo marks are trademarks or registered trademarks of Olympus Imaging Corporation, in Japan, the United States, the European Union and other countries.
- SDXC Logo is a trademark of SD-3C, LLC.
- “AVCHD”, “AVCHD Progressive” and the “AVCHD Progressive” logo are trademarks of Panasonic Corporation and Sony Corporation.
- Manufactured under license from Dolby Laboratories. Dolby and the double-D symbol are trademarks of Dolby Laboratories.
- HDMI, the HDMI Logo, and High-Definition Multimedia Interface are trademarks or registered trademarks of HDMI Licensing LLC in the United States and other countries.
- HDAVI Control™ is a trademark of Panasonic Corporation.
- Adobe is a trademark or registered trademark of Adobe Systems Incorporated in the United States and/or other countries.
- Mac and Mac OS are trademarks of Apple Inc., registered in the U.S. and other countries.
- iPad, iPhone, iPod, and iPod touch are trademarks of Apple Inc., registered in the U.S. and other countries.
- App Store is a service mark of Apple Inc.
- Windows and Windows Vista are either registered trademarks or trademarks of Microsoft Corporation in the United States and/or other countries.



- QuickTime and the QuickTime logo are trademarks or registered trademarks of Apple Inc., used under license therefrom.



- Android and Google Play are trademarks or registered trademarks of Google Inc.

- The Wi-Fi CERTIFIED™ Logo is a certification mark of Wi-Fi Alliance®.



- The Wi-Fi Protected Setup™ Identifier mark is a certification mark of Wi-Fi Alliance®.

- “Wi-Fi®” and “Wi-Fi Direct®” are registered trademarks of Wi-Fi Alliance®.



- “Wi-Fi Protected Setup™”, “WPA™”, and “WPA2™” are trademarks of Wi-Fi Alliance®.

- DLNA, the DLNA Logo and DLNA CERTIFIED are trademarks, service marks, or certification marks of the Digital Living Network Alliance.



- This product uses “DynaFont” from DynaComware Corporation. DynaFont is a registered trademark of DynaComware Taiwan Inc.

- QR Code is a registered trademark of DENSO WAVE INCORPORATED.

- Other names of systems and products mentioned in these instructions are usually the registered trademarks or trademarks of the manufacturers who developed the system or product concerned.

This product is licensed under the AVC patent portfolio license for the personal and non-commercial use of a consumer to (i) encode video in compliance with the AVC Standard (“AVC Video”) and/or (ii) decode AVC Video that was encoded by a consumer engaged in a personal and non-commercial activity and/or was obtained from a video provider licensed to provide AVC Video. No license is granted or shall be implied for any other use. Additional information may be obtained from MPEG LA, LLC. See <http://www.mpegla.com> .

Panasonic Corporation of North America
Two Riverfront Plaza, Newark, NJ 07102-5490
<http://www.panasonic.com>

© Panasonic Corporation 2014

Printed in China