

Panasonic[®]

Operating Instructions Digital Camera

Model No. **DMC-LS75**
DMC-LS70
DMC-LS60

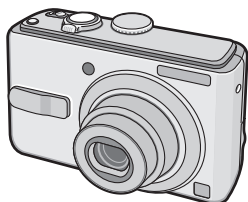

The illustration shows
DMC-LS75.



Before connecting, operating or
adjusting this product, please read the
instructions completely.

For USA assistance, please call: 1-800-272-7033 or send e-mail to : digitalstillcam@us.panasonic.com

For Canadian assistance, please call: 1-800-99-LUMIX (1-800-995-8649) or
send e-mail to: lumixconciierge@ca.panasonic.com

P PC

VQT1C63-1

Dear Customer,

Thank you for choosing Panasonic!

You have purchased one of the most sophisticated and reliable products on the market today. Used properly, we're sure it will bring you and your family years of enjoyment. Please take time to fill in the information in the box below.

The serial number is on the tag located on the underside of your Camera. Be sure to **retain this manual** as your convenient Camera information source.

Model No. _____

Serial No. _____

Information for Your Safety

WARNING:

TO REDUCE THE RISK OF FIRE, ELECTRIC SHOCK OR PRODUCT DAMAGE,

- DO NOT EXPOSE THIS APPARATUS TO RAIN, MOISTURE, DRIPPING OR SPLASHING AND THAT NO OBJECTS FILLED WITH LIQUIDS, SUCH AS VASES, SHALL BE PLACED ON THE APPARATUS.
- USE ONLY THE RECOMMENDED ACCESSORIES.
- DO NOT REMOVE THE COVER (OR BACK); THERE ARE NO USER SERVICEABLE PARTS INSIDE. REFER SERVICING TO QUALIFIED SERVICE PERSONNEL.

Carefully observe copyright laws.

Recording of pre-recorded tapes or discs or other published or broadcast material for purposes other than your own private use may infringe copyright laws. Even for the purpose of private use, recording of certain material may be restricted.

- Please note that the actual controls and components, menu items, etc. of your Digital Camera may look somewhat different from those shown in the illustrations in these Operating Instructions.
- SDHC Logo is a trademark.
- Other names, company names, and product names printed in these instructions are trademarks or registered trademarks of the companies concerned.

THE SOCKET OUTLET SHALL BE INSTALLED NEAR THE EQUIPMENT AND SHALL BE EASILY ACCESSIBLE.

CAUTION

Danger of explosion if battery is incorrectly replaced. Replace only with the same or equivalent type recommended by the manufacturer. Dispose of used batteries according to the manufacturer's instructions.

Marking sign is located on bottom of the unit.

THE FOLLOWING APPLIES ONLY IN THE U.S.A.

FCC Note: (U.S. only)

This equipment has been tested and found to comply with the limits for a Class B digital device, pursuant to Part 15 of the FCC Rules. These limits are designed to provide reasonable protection against harmful interference in a residential installation. This equipment generates, uses, and can radiate radio frequency energy and, if not installed and used in accordance with the instructions, may cause harmful interference to radio communications. However, there is no guarantee that interference will not occur in a particular installation. If this equipment does cause harmful interference to radio or television reception, which can be determined by turning the equipment off and on, the user is encouraged to try to correct the interference by one or more of the following measures:

- Reorient or relocate the receiving antenna.
- Increase the separation between the equipment and receiver.
- Connect the equipment into an outlet on a circuit different from that to which the receiver is connected.
- Consult the dealer or an experienced radio/TV technician for help.

FCC Caution: To assure continued compliance, follow the attached installation instructions and use only shielded interface cables with ferrite core when connecting to computer or peripheral devices.

Any changes or modifications not expressly approved by the party responsible for compliance could void the user's authority to operate this equipment.

Declaration of Conformity

Trade Name: Panasonic
 Model No.: DMC-LS75
 DMC-LS70
 DMC-LS60

Responsible party: Panasonic Corporation of North America
 One Panasonic Way,
 Secaucus, NJ 07094

Support Contact: Panasonic Consumer Electronics Company
 1-800-272-7033

This device complies with Part 15 of the FCC Rules. Operation is subject to the following two conditions: (1) This device may not cause harmful interference, and (2) this device must accept any interference received, including interference that may cause undesired operation.

Only for Canada

This Class B digital apparatus complies with Canadian ICES-003.

Only for U.S.A.

FC **Panasonic**
DMC-LS75

FC **Panasonic**
DMC-LS70

FC **Panasonic**
DMC-LS60

-If you see this symbol-**Information on Disposal in other Countries outside the European Union**

This symbol is only valid in the European Union. If you wish to discard this product, please contact your local authorities or dealer and ask for the correct method of disposal.

■ Care for the camera

- **Do not strongly shake or bump the camera.** The camera may not be operated normally, recording of pictures may be disabled or the lens and the LCD monitor may be damaged.
- **Sand or dust may cause the camera to malfunction. Make sure that sand or dust does not get into the lens, the flash or the terminals when using the camera on a beach etc.**
- Make sure that water does not get into the camera when using it on a rainy day or on a beach.
- **This camera is not waterproof. In case the camera comes into contact with water, wipe it off with a dry cloth. When the camera does not operate normally, contact your dealer or your nearest Service Center.**

■ About the LCD monitor

- **Do not press the LCD monitor with excessive force. Uneven colors may appear on the LCD monitor and it may malfunction.**
- Condensation may form on the LCD monitor in places with large temperature differences. Wipe the condensation with a soft, dry cloth.
- If the camera is cold when you turn it on, the picture on the LCD monitor will be slightly darker than usual at first. However, the picture will return to normal brightness when the internal temperature of the camera increases.

Extremely high precision technology is employed to produce the LCD monitor screen. However there may be some dark or bright spots (red, blue or green) on the screen. This is not a malfunction. The LCD monitor screen has more than 99.99% effective pixels with a mere 0.01% of the pixels inactive or always lit. The spots will not be recorded in pictures stored in the built-in memory or a card.

■ About the Lens

- Do not press the lens or the lens barrel with excessive force.
- Do not leave the camera with the lens facing the sun as it may cause the camera to malfunction. Also, be careful when you leave the camera outside or near a window.

■ About Condensation (When the lens is fogged up)

- Condensation occurs when the ambient temperature or humidity changes as described below. Be careful of condensation since it causes lens stains, fungus and camera malfunction.
 - When the camera is taken from the cold outdoors to the warm indoors
 - When the camera is taken from outside to inside an air-conditioned car
 - When cool wind from an air conditioner etc. blows directly on the camera
 - In humid places
- To prevent condensation, put the camera in a plastic bag until the temperature of the camera is close to the ambient temperature. If condensation occurs, turn the camera off and leave it for about 2 hours. The fog will disappear naturally when the temperature of the camera becomes close to the ambient temperature.

■ When not using the camera for a long period of time

- Store the batteries in a cool and dry place with a relatively stable temperature. [Recommended temperature: 15 °C to 25 °C (59 °F to 77 °F), Recommended humidity: 40% to 60%]
- Always remove the batteries and the card from the camera.
- If the batteries are left inserted in the camera they will discharge as a weak electric current passes through them even if the camera is turned off. [Read P12 for information about Ni-MH (nickel metal hydride) batteries.]
- We recommend storing the camera with a desiccant (silica gel) when you keep it in a closet or a cabinet.

■ About cards that can be used in this unit

You can use an SD Memory Card, an SDHC Memory Card and a MultiMediaCard.

- When the term **card** is used in these operating instructions this refers to the following types of Memory Cards.
 - SD Memory Card (8 MB to 2 GB)
 - SDHC Memory Card (4 GB)
 - MultiMediaCard

More specific information about memory cards that can be used with this unit.

- You can only use an SDHC Memory Card if using cards with 4 GB or more capacity.
- A 4 GB Memory Card without an SDHC logo is not based on the SD Standard and will not work in this product.

Contents

Before Use	
Information for Your Safety	2

Preparation	
Standard Accessories	8
Names of the Components	9
Quick Guide	10
About the Batteries	11
Inserting/Removing the Batteries/Card (Optional)	15
About the Built-in Memory/the Card	16
Setting Date/Time (Clock Set)	17
• Changing the clock setting	17
About the Mode Dial	18
Using the Menus	19
About the Setup Menu.....	21
LCD monitor and changes to the display	24

Basic	
Taking Pictures	25
• Photography basics – exposure, focus, and color	26
Taking Pictures in Simple Mode	28
Taking Pictures with the Zoom	30
• Using the Optical Zoom/the Extended Optical Zoom (EZ)	30
• Using the easy zoom button.....	31
• Using the Digital Zoom	32
Checking the Recorded Picture (Review)	33
Playing Back Pictures	34
Deleting Pictures	35

Advanced-Shooting	
About the LCD Monitor	37
• Changing the information displayed	37
• Recording a picture with the camera held high above your head (High angle mode)	39
Taking Pictures using the Built-in Flash	40
Taking Pictures with the Self-timer	43
Compensating the Exposure	44
Shooting with the Intelligent ISO mode	45
Taking Close-up pictures	46
Scene mode	47
– Portrait mode	48
– Soft skin mode	48
– Scenery mode	48
– Sports mode	48
– Night portrait mode	48
– Night scenery mode	49
– Food mode	49
– Party mode	49
– Candle light mode	49
– Sunset mode	50
– Baby mode 1	50
– Baby mode 2	50
– Pet mode	50
– High Sensitivity mode	51
– Beach mode	51
– Starry sky mode	51
– Fireworks mode	52
– Snow mode	52
– Aerial photo mode	52
Motion picture mode	53
Recording which day of the vacation you take the picture	55
Displaying the time at the travel destination	57

Using the [REC] mode menu	59
• [W.BALANCE]	60
• [SENSITIVITY]	61
• [ASPECT RATIO]	62
• [PICT.SIZE]/[QUALITY]	62
• [AF MODE]	63
• [STABILIZER]	64
• [BURST]	65
• [AF ASSIST LAMP]	66
• [COL.MODE]	66
• [CLOCK SET]	66

Advanced-Viewing

Displaying Multiple Screens (Multi Playback)	67
Displaying pictures by recording date (Calendar playback)	68
Using the Playback Zoom	69
Playing Back Motion pictures	70
Using the [PLAY] mode menu	71
• [SLIDE SHOW]	72
• [FAVORITE]	73
• [ROTATE DISP.]/[ROTATE]	74
• [DATE STAMP]	75
• [DPOF PRINT]	77
• [PROTECT]	79
• [RESIZE]	80
• [TRIMMING]	81
• [COPY]	82
• [FORMAT]	83

Connecting to other equipment

Connecting to a PC	84
Connecting to a PictBridge-compliant Printer	87
Playing Back Pictures with a TV Screen	91

Others

Screen Display	92
Cautions for Use	94
Message Display	96
Troubleshooting	98
Number of recordable pictures and available recording time	104
Specifications	107
Digital Camera Accessory System	110
Digital Camera Accessory Order Form (For USA Customers)	111
Request for Service Notice (For USA Only)	112
Limited Warranty (For USA Only)	113
Customer Services Directory (For USA Only)	115
Précautions à prendre (pour les clients canadiens)	116
Index	118

Standard Accessories

Before using your camera, check the contents.

■ Batteries

AA Oxyride batteries (ZR6)

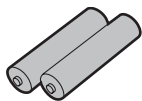

■ Video Cable

K1HA08CD0015



■ USB Connection Cable

K1HA08CD0013



■ CD-ROM



■ Strap

VFC4090



• Card is optional.

You can record or play back pictures on the built-in memory when you are not using a card. (P16)

- For information about optional accessories, please refer to "Digital Camera Accessory System". (P110)
- If any of the accessories are lost, please contact Panasonic's parts department at 1 800 833-9626 (For USA) or in Canada call 1 800 995-8649 for more details on how to obtain replacement parts.

■ About illustrations in these operating instructions

Please note that the appearance of the product, the illustration or the menu screen are a little different from those in actual use.

The illustrations in these operating instructions show DMC-LS75.

Names of the Components

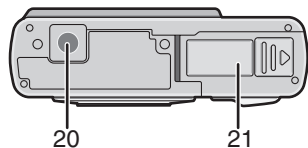
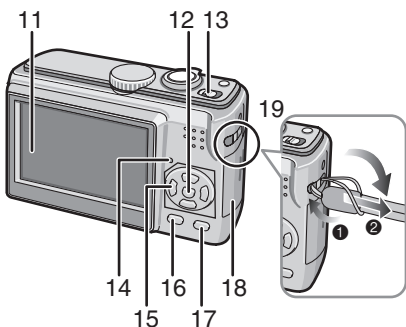
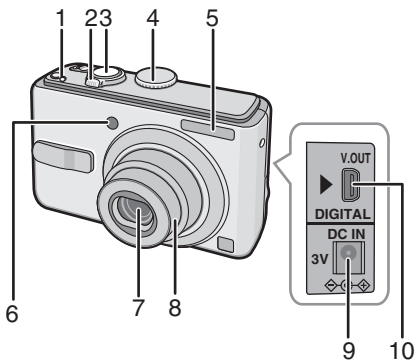

20 Tripod Receptacle

- When you use a tripod, make sure the tripod is stable with the camera attached to it.

21 Battery Door (P15)

1 [E. ZOOM] (Easy Zoom) Button (P31)

2 Zoom Lever (P30)

3 Shutter Button (P25, 53)

4 Mode Dial (P18)

5 Flash (P40)

6 Self-timer Indicator (P43)

AF Assist Lamp (P66)

7 Lens part (P5)

8 Lens barrel

9 [DC IN] Socket (P84, 87)

- Always use a genuine Panasonic AC adaptor (DMW-AC6: optional).

10 [V.OUT/DIGITAL] Socket (P84, 87, 91)

11 LCD Monitor (P37, 92)

12 [MENU/SET] Button (P17)

13 Camera Switch (P17)

14 Status Indicator (P25)

15 Cursor buttons

◀ /Self-timer Button (P43)

▼ / [REV] Button (P33)

▶ /Flash Mode Button (P40)

▲ /Backlight Compensation in Simple Mode (P29)/Exposure Compensation (P44) Button

- In these operating instructions, operations using the cursor buttons are described as follows.

e.g.: When you press the ▼ button.

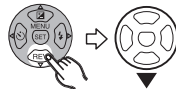

16 [DISPLAY] (P37)/ [HIGH ANGLE] (P39) Button

17 [FUNC] (function) (P59)/Delete (P35) Button

18 Card Door (P15)

19 Strap Eyelet

- To remove the strap, use a pointed object to undo the knot.

Quick Guide

This is the overview of the procedure to record pictures with this camera. For each operation, be sure to refer to the corresponding pages.

1 Insert the batteries. (P15)

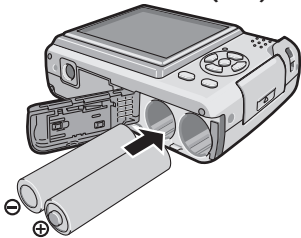

- When you do not use the card (optional), you can record or play back pictures on the built-in memory (P16). Refer to P15 when you use a card.

2 Turn the camera on to take pictures.

- Set the clock. (P17)
- Select the type of battery in use on [BATTERY TYPE] in the [SETUP] menu. (P21)

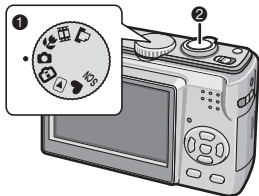

- 1 Set the mode dial to [P].
- 2 Press the shutter button to take pictures. (P25)

3 Play back the pictures.

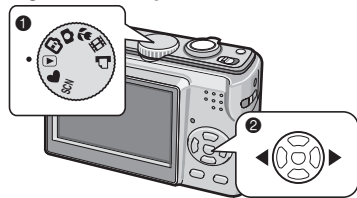

- 1 Set the mode dial to [P].
- 2 Select the picture you want to view. (P34)

About the Batteries

■ Usable batteries

AA Oxryde batteries (supplied)*
AA Alkaline batteries (optional)
AA Rechargeable Ni-MH (nickel metal hydride) batteries (optional)

- One of the following messages appears when you insert batteries for the first time, change the batteries when they become exhausted etc.
[CURRENT BATTERY TYPE SETTING: OXYRIDE]/[CURRENT BATTERY TYPE SETTING: ALKALINE/Ni-MH]
If the batteries inserted are different from the type displayed in the message, set [BATTERY TYPE] in the [SETUP] menu. (P21)
- The battery type that is set can be distinguished by the color of the battery indication (blue or white).
 - The battery indication does not appear when using the AC adaptor (DMW-AC6; optional).

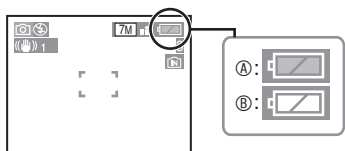

Ⓐ: When oxryde batteries are selected

The battery indication turns blue.

Ⓑ: When alkaline/Ni-MH batteries are selected

The battery indication turns white.

- * An oxryde battery is a new type of non-rechargeable battery developed by Panasonic. It has more power than a regular alkaline battery and is suitable for high-drain equipment such as digital cameras.
- We recommend using Panasonic batteries.
- Battery performance may vary greatly depending on the brand used and

the storage life and conditions of the batteries.

- Battery performance temporarily deteriorates in low temperature conditions [10 °C (50 °F) or less]. However, it recovers when the temperature returns to normal.
- Depending on the temperature and the conditions of use, the camera may not operate properly and the batteries may become exhausted without warning because the battery indication is not displayed correctly. This is not a malfunction.
- We recommend turning the camera off frequently while recording to conserve battery power for longer battery life. If you will be using the camera for long periods of time, using rechargeable Ni-MH batteries is recommended.
- Exhausted batteries may recover some performance if left for a period of time. However, they cannot be used for a long time. Be sure to replace them with new batteries.

■ Unusable batteries

Manganese batteries	Lithium batteries
Nickel batteries	Ni-Cd batteries

- Operation is not guaranteed when using the batteries listed above. The batteries can leak and the following malfunctions can occur:
 - The remaining battery power is not displayed accurately.
 - The camera does not turn on.
 - Data written to the built-in memory or the card is damaged resulting in loss of the photographs.

■ Battery shapes that cannot be used

- Batteries with unusual shapes cause leakage, heat generation or explosion if inserted in the camera.
- Batteries with the covering partly or fully peeled off. Never use these batteries. (Refer to the illustration below.)

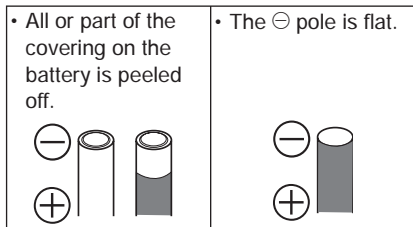

■ Proper Care and Handling of Batteries

Mishandling batteries may cause leakage, heat generation, fire or explosion. Observe the following.

- Do not heat or expose to flame.
- Do not splash batteries with water/sea water or wet battery terminals.
- Do not peel off or scratch the covering on batteries.
- Do not drop, throw or subject batteries to other strong impacts.
- Do not use batteries that show signs of leakage, deformation, discoloration etc.
- Do not store batteries in high humidity areas or high temperatures.
- Keep batteries away from children.
- Always use 2 new batteries of the same type when replacing batteries.
- Remove the batteries if you do not intend to use the unit for a long time.
- Batteries may heat up soon after you start using the unit. Turn the camera off and wait until the battery temperature decreases before removing them.
- Battery performance deteriorates and recording/playback time decreases when the ambient temperature is low [10 °C (50 °F) or less]. This is particularly true when using oxyride or alkaline batteries

so warm them in your pocket etc. before using them. Make sure that no metal objects such as a lighter are placed together with the batteries when warming them in your pocket.

- If there is grease or dirt on the battery poles, the recording/playback time may become extremely short. Before inserting the batteries, clean the battery terminals with a soft, dry cloth.

If battery leakage occurs, remove the batteries and thoroughly wipe the leakage in the battery compartment. Insert new batteries or fully charged Ni-MH batteries.

If battery electrolyte spills on your hands or clothes, thoroughly wash them with water. Battery electrolyte can cause loss of sight if it comes into contact with your eyes. Do not rub your eyes. Wash them immediately with clean water and consult a doctor.

■ Ni-MH Batteries (Nickel Metal Hydride)

You can use Ni-MH batteries after charging them with a nickel metal hydride battery charger. However, improper handling of the batteries may cause leakage, heat generation, fire or explosion. Observe the following.

- If rechargeable batteries are to be used, rechargeable batteries manufactured by Panasonic are recommended.
- If there is dirt on the battery poles, you may not be able to charge normally. Clean the battery poles and the battery recharger terminals with a soft, dry cloth.
- When charging batteries for the first time, or after having not used them for a long period of time, they may not charge fully. This is a feature of Ni-MH batteries and is not a malfunction. Battery performance will become normal after a few charges and discharges.

- We recommend charging the batteries after they are fully discharged. If you charge the batteries before they are fully discharged, it can reduce battery performance. This is called “memory effect”.
- If “memory effect” occurs, continue using the batteries until the camera stops working and then charge them fully. Battery performance will be restored after a few charges and discharges.
- Over time Ni-MH batteries naturally discharge and their capacity lowers even when they are not used.
- Once the batteries have reached full charge, do not continue to charge them.
- Do not peel off or scratch the covering on Ni-MH batteries.
- Read the operating instructions for the battery charger.

Ni-MH batteries have a limited life. Battery capacity gradually decreases over time. If the length of time you can use the camera is extremely short even after fully charging the batteries, they may have exceeded their life span. Purchase new batteries.

- Battery life differs depending on the conditions of storage and usage and the environment.

When not using the batteries for a long period of time

- If the batteries are left in the camera they will discharge. This is because a small electrical current continues to flow even when the camera is turned off. If the batteries continue to be left in the camera, they will discharge excessively and may become unusable even if charged.
- When storing the batteries for a long period of time, we recommend charging them once a year. Remove the batteries from the camera and store them again after they have completely discharged.

■ Battery life

The number of recordable pictures (By CIPA standard in normal picture mode)

Batteries Used	Number of recordable pictures (Approx.)	
	DMC-LS75/ DMC-LS70	DMC-LS60
Panasonic Oxyride batteries (supplied or optional)	250 pictures (125 min)	260 pictures (130 min)
Panasonic Alkaline batteries (optional)	150 pictures (75 min)	160 pictures (80 min)
Fully charged Panasonic Ni-MH batteries (optional)	460 pictures (230 min)	470 pictures (235 min)

Recording conditions by CIPA standard

- Temperature: 23 °C (73.4 °F)/ Humidity: 50% when the LCD monitor is on.
- Using a Panasonic SD Memory Card (16 MB)*
- * The card is not supplied.
- Starting recording 30 seconds after the camera is turned on. (When the optical image stabilizer function is set to [MODE1])
- **Recording once every 30 seconds**, with full flash every second recording.
- Rotating the zoom lever from Tele to Wide or vice versa in every recording.
- Turning the camera off every 10 recordings./Leaving the camera until the batteries cool down.
- CIPA is an abbreviation of [Camera & Imaging Products Association].

The number of recordable pictures varies depending on the recording interval time. If the recording interval time becomes longer, the number of recordable pictures decreases. (e.g. When recording once every 2 minutes: about 1/4 the number when recording once every 30 seconds)

The number of recordable pictures in low temperatures (In normal picture mode when the temperature is 0 °C (32 °F) and other recording conditions comply with CIPA standard.)

Batteries Used	Number of recordable pictures (Approx)	
	DMC-LS75/ DMC-LS70	DMC-LS60
Panasonic Oxyride batteries (supplied or optional)	50 pictures (25 min)	55 pictures (27 min)
Panasonic Alkaline batteries (optional)	40 pictures (20 min)	45 pictures (22 min)
Fully charged Panasonic Ni-MH batteries (optional)	380 pictures (190 min)	390 pictures (195 min)

- Please note that the performance of oxyride batteries and alkaline batteries significantly decreases in low temperature conditions.

Playback time

Batteries Used	Continuous playback time (Approx.)	
	DMC-LS75/ DMC-LS70	DMC-LS60
Panasonic Oxyride batteries (supplied or optional)	430 min	440 min
Panasonic Alkaline batteries (optional)	420 min	430 min
Fully charged Panasonic Ni-MH batteries (optional)	610 min	620 min



- The number of recordable pictures and playback time will vary depending on the operating conditions and how the battery is stored.
- The number of recordable pictures and the playback time will also vary depending on the brand and type of batteries used.
- We recommend using power save mode (P21) or economy mode (P22) or turning off the camera frequently while recording to maintain battery power.

Inserting/Removing the Batteries/Card (Optional)

- Check that the camera is turned off.
- Use oxyride batteries (supplied), alkaline batteries (optional) or Ni-MH batteries (optional).
- Prepare an SD Memory Card (optional), an SDHC Memory Card (optional) or a MultiMediaCard (optional).
- You can record or play back pictures on the built-in memory when you are not using a card. (P16)

1 Slide the battery door **A** or the card door **B** to open it.

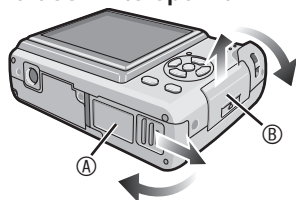

2 Batteries:

Insert the batteries with the \oplus and \ominus poles aligned correctly.

Card:

Insert the card with the label side facing the back of the camera until it clicks and locks.

To remove the card, push the card until it clicks, then pull the card out upright.

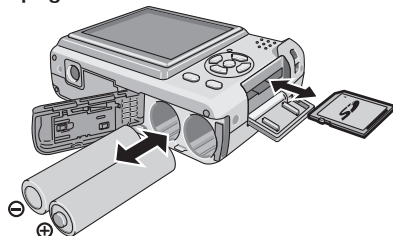

- Do not touch the connection terminals on the back side of the card.
- The card may be damaged if it is not fully inserted.

- 3 1 Close the battery door or the card door.
2 Slide the battery door or the card door to the end and then close it firmly.

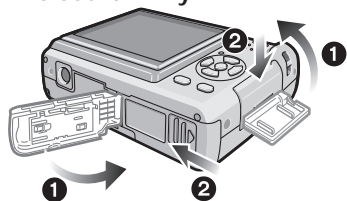

- If the card door cannot be completely closed, remove the card, check its direction and insert it again.



- Select the battery type being used in [BATTERY TYPE] in the [SETUP] menu. (P21)
- Remove the batteries after use.
- Remove the batteries after the LCD monitor and the status indicator (green) turn off. Otherwise, the settings on the camera may not be stored properly.
- Do not remove or insert the batteries or the card while the unit is on particularly while accessing the built-in memory or the card (P24). This can damage data.
- We recommend using Panasonic's SD Memory Card/SDHC Memory Card.

About the Built-in Memory/the Card

The built-in memory can be used as a temporary storage device when the card being used becomes full.

■ Built-in Memory [IN]

You can record or play back pictures on the built-in memory when you are not using a card. (The built-in memory cannot be used when a card is inserted.)

- The built-in memory capacity is about 27 MB.
- Picture size is fixed to QVGA (320×240 pixels) when recording motion pictures to the built-in memory. (P53)

■ Card [CARD]

You can record or play back pictures on a card.

■ About SD Memory Card (optional), SDHC Memory Card (optional) and MultiMediaCard (optional) (P5)

- The SD Memory Card, the SDHC Memory Card and the MultiMediaCard are small, lightweight, removable external memory cards.
- The SDHC Memory Card is a memory card standard decided by the SD Association in 2006 for high capacity memory cards more than 2 GB.
- The reading/writing speed of the SD Memory Card and the SDHC Memory Card is fast. The SD Memory Card and the SDHC Memory Card are equipped with a Write-Protect switch  that can inhibit writing and formatting. (When the switch is slid to the [LOCK] side, it is not possible to write or delete data on the card and format it. When the switch is unlocked, these functions become available.)
- This unit supports SD Memory Cards formatted in the FAT12 and FAT16



systems that comply with SD Memory Card Specifications. It also supports SDHC Memory Cards formatted in the FAT32 system.

- This unit (SDHC compliant equipment) supports both SD Memory Cards and SDHC Memory Cards. You can use SDHC Memory Cards on equipment that supports them. You cannot use SDHC Memory Cards on equipment that supports SD Memory Cards only. (When you use SDHC Memory Cards on other equipment, make sure to read the equipment's operating instructions. If you intend to have your pictures printed by someone, first find out if they are able to use SDHC Memory Cards.)

Please confirm the latest information on the following website.

<http://panasonic.co.jp/pavc/global/cs>
(This site is in English only.)

- Refer to page 104 for the number of recordable pictures and available recording time on a card.
- Use the high speed SD Memory Card or the high speed SDHC Memory Card for motion picture recording. (P53)



- Save important data in such places as your PC as well. Electromagnetic waves, static electricity, unit malfunctions, card damages and other factors may destroy or erase data.
- If the card was formatted on a PC or other equipment, format it again on the camera. (P83)
- Keep the Memory Card out of reach of children to prevent swallowing.

Setting Date/Time (Clock Set)

Set the mode dial to [📷].

■ Initial setting

The clock is not set when the camera is shipped. When you turn the camera on, the following screen appears.

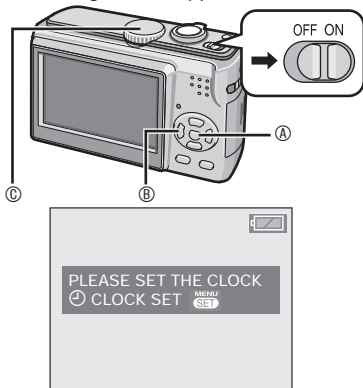

- Ⓐ: [MENU/SET] button
 Ⓑ: Cursor buttons
 Ⓒ: Mode dial

PLEASE SET THE CLOCK
 ⌚ CLOCK SET

1 Press [MENU/SET].

2 Press ▲/▼/◀/▶ to select the date.

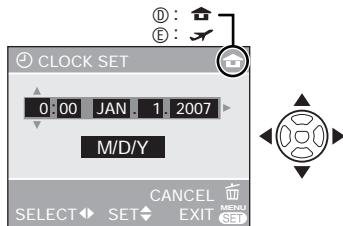

- Ⓓ: Time at the home area
 Ⓔ: Time at the travel destination (P57)
- ◀▶: Select the desired item.
 - ▲▼: Set date and time.
 - 🗑️: To cancel without setting the clock.

3 Press [MENU/SET].

- When you finish setting the clock, switch the camera off, then switch it on in recording mode to check that the clock is set correctly.

Changing the clock setting

- Press [MENU/SET].
 - Press ▲/▼ to select [CLOCK SET] (P66).
 - Press ▶ and perform the above steps 2 and 3 for setting.
 - Press [MENU/SET] to close the menu.
- You can set the clock from the setup menu (P21).



- When batteries have been inserted for more than 3 hours, the clock setting is stored in the camera for approximately 3 months even if the batteries are removed.
- You can set the year from 2000 to 2099. The 24-hour system is used.
- Set the date so that the correct date is printed when you order prints or use the date stamp (P75).

About the Mode Dial

When the power is on and you turn the mode dial, you can switch between shooting and playback modes, and also select modes suited to the subject such as the macro mode and scene modes.

Changing the mode

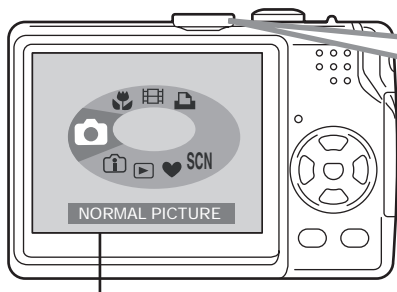

Adjust part A to the desired mode.
The mode dial can be rotated 360°. Rotate it slowly and surely to adjust to each mode. (Do not adjust it to parts where there is no mode.)

This screen appears when you turn the mode dial to show which mode is selected (P23). The current mode appears on the LCD when you turn the camera on.

Basic

Normal picture mode (P25)

Use this mode for normal recording.

Simple mode (P28)

This mode is recommended for beginners.

Playback mode (P34)

This mode allows you to play back recorded pictures.

Advanced

Intelligent ISO mode (P45)

This feature detects the subject's movement and brightness, choosing the optimal ISO sensitivity and shutter speed for shooting.

Macro mode (P46)

This mode allows you to take a close-up picture of a subject.

SCN Scene mode (P47)

This mode allows you to take pictures depending on the recording scenes.

Motion picture mode (P53)

This mode allows you to record motion pictures.

Print mode (P87)

This mode allows you to print pictures from a PictBridge-compliant printer connected directly to the camera.

Using the Menus

■ To show the menus

Press [MENU/SET].

Menu Icons

- The menu icons and items that appear depend on the position of the mode dial.

Current Page

- For example: The first page of a 3-page menu.

You can move to the next/previous page by turning the zoom lever.

Menu items and settings

■ The menu icons

📷 Recording menu (P59)

Displayed when the mode dial is set to [📷], [📷], [📷], [SCN], or [📷].

▶ Play menu (P71)

Displayed when the mode dial is set to [▶].

SCN Scene mode menu (P47)

Displayed when the mode dial is set to [SCN].

⚙️ Setup menu (P21)

Displayed when the mode dial is set to [📷], [📷], [📷], [SCN], [📷], or [▶].

■ Changing the menu settings

- The following example shows how to set [AF MODE] when normal picture mode [📷] is selected.

1 Press ▲/▼ to select the menu item.

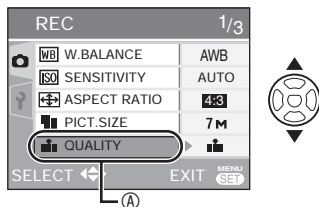

- ↓
- Press ▼ at (A) to switch to the next menu screen.

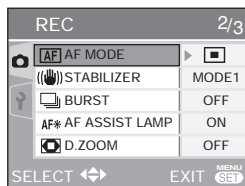

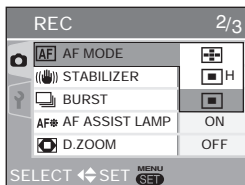
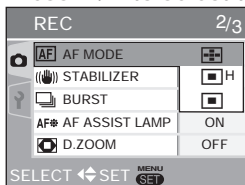
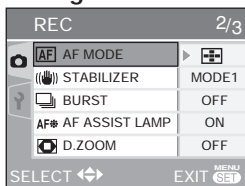
2 Press **▶**.3 Press **▲/▼** to select the setting.4 Press **[MENU/SET]** to confirm the setting.

■ To exit the menus

Press **[MENU/SET]**.

- You can also exit the menus when the mode dial is set to **[M]**, **[A]**, **[V]**, **[SCN]**, or **[B]** by pressing the shutter button halfway.

■ Switching to the setup menu

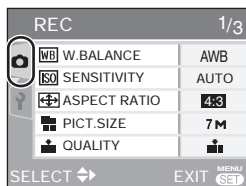
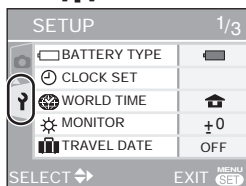
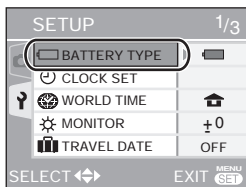
1 Press **◀** in the menu screen.2 Press **▼** to select the setup menu icon **[Y]**.3 Press **▶**.

- Continue to select items and change settings.

About the Setup Menu

- Change the settings if necessary.
- Select [RESET] to return the settings to the initial settings at the time of purchase (P23). Press [MENU] to display menu, enter the setup menu [P] and select the item. (P20) The setting marked "▶" means it is the initial setting. [BATTERY TYPE], [CLOCK SET], [AUTO REVIEW], [POWER SAVE] and [ECONOMY] are very important items. Check their settings before use.



Select the type of batteries you have inserted.
BATTERY TYPE

Select the type of battery being used from the following 2 types.

ALKALINE (LR6)/Ni-MH

OXYRIDE (ZR6)

- If the type of battery being used and the type of battery selected are not the same, the battery indication will not be displayed correctly.



Set the date and time.
CLOCK SET (P17)

Change date and time.



Show images you have taken.
AUTO REVIEW

Adjust how long the recorded picture automatically appears on the screen.

OFF / ▶ 1 SEC. / 3 SEC.

- Auto review is not available in motion picture mode [M].
- You cannot change the auto review setting in simple mode [♥] or burst mode. (The setting is not selectable.)





Have the camera turn off automatically.
POWER SAVE

If you perform no operations, the camera turns off automatically after the interval you set to save the battery.

OFF / 1 MIN. / 2 MIN. / ▶ 5 MIN. / 10 MIN.

- Press the shutter button halfway or turn the camera off and on to recover from the power save mode.
- Power save mode is fixed to [2MIN.] in economy mode and [5MIN.] in simple mode [♥].
- When using the AC adaptor (DMW-AC6; optional)/connecting to a PC or a printer/recording motion pictures/playing back motion pictures/during Slide Show (P72), the power save mode is not activated.

Press [] to display menu, enter the setup menu [] and select the item. (P20)

 *Have the LCD turn off automatically.*
ECONOMY

Battery life is saved by reducing the brightness of the LCD monitor and turning it off automatically when the camera is not being used in recording mode.

▶ **OFF:** Economy mode cannot be activated.

LEVEL1:The LCD monitor turns off if the camera is not operated for about 15 seconds in recording mode.

LEVEL2:The LCD monitor turns off if the camera is not operated for about 15 seconds in recording mode or for about 5 seconds after taking a picture.

- The status indicator lights while the LCD monitor is turned off. Press any button to turn on the LCD monitor again.
- Power save mode is fixed to [2 MIN.] in economy mode.
[However, power save mode is not activated when using the AC adaptor (DMW-AC6; optional).]
- Economy mode is not activated in the following cases.
 - In simple mode []
 - When using the AC adaptor (DMW-AC6; optional)
 - While a menu screen is displayed
 - While the self-timer is set
 - While recording motion pictures

 **WORLD TIME (P57)**

Set date and time at your home area and the travel destination.

 : The local time at the travel destination

▶  : The time at your home area

 **MONITOR**

Adjust the brightness of the LCD monitor in 7 steps.



 **TRAVEL DATE (P55)**

Set the departure and return dates.

▶ **OFF / SET**

 **BEEP**

Set to select the volume of operational sound.

-  : No operational sound
- ▶  : Soft operational sound
-  : Loud operational sound

 **NO.RESET**

Set this when you want to start the file number of the picture from 0001 on the next recording.

- The folder number is updated, and the file number starts from 0001 (P85).
- The folder number can be assigned from 100 to 999. When the folder number reaches 999, it cannot be reset. We recommend formatting the card after saving the data on a PC or elsewhere.
- To reset the folder number to 100, you must first reformat the built-in memory or the card (P83). After this perform [NO. RESET] to reset the file number, after which a screen appears asking whether you want to reset the folder number. Select [YES].

Press [] to display menu, enter the setup menu [] and select the item. (P20)

RESET

The settings on the recording or the [SETUP] menu are reset to the initial settings.

- The birthday setting for [BABY1]/[BABY2] or [PET] (P50) in scene mode and the number of days that have passed since the departure date for [TRAVEL DATE] (P55) and the [WORLD TIME] setting (P57) are also reset when the [SETUP] menu settings are reset. Also, [FAVORITE] (P73) is fixed to [OFF] and [ROTATE DISP.] (P74) is fixed to [ON].
- The battery type setting, the folder number and the clock setting are not changed.



VIDEO OUT (Playback mode only)

Set to [NTSC] or [PAL] according to the TV system in your country (P91).

- ▶ **NTSC:** Video output is set to NTSC system.
- PAL:** Video output is set to PAL system.

TV ASPECT (Playback mode only)

Set to [] or [] according to your television.

- ▶ : Select if your television has a 16:9 aspect ratio.
- ▶ : Select if your television has a 4:3 aspect ratio.

DIAL DISPLAY (P18)

Choose whether to show the mode dial display when you turn the mode dial.

OFF / ▶ ON

LANGUAGE

Set to the language on the menu screen from the following languages.

- ▶ **[ENGLISH]:** English
- [DEUTSCH]:** German
- [FRANÇAIS]:** French
- [ESPAÑOL]:** Spanish
- [ITALIANO]:** Italian
- [中文]:** Chinese (Traditional)*
- [日本語]:** Japanese

* Available in Canada only

- When you set to other language by mistake, select [] from the menu icons to set the desired language.

LCD monitor and changes to the display

■ Display in normal picture mode [📷]. (at the time of purchase)

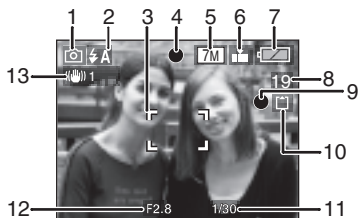

1 Recording mode

2 Flash mode (P40)

- The flash icon turns red when activating the flash and pressing the shutter button halfway.

3 AF area

- The AF area displayed is bigger than usual when taking pictures in dark place.

4 Focus (P25)

5 Picture size (P62)

6 Quality (P62)

[📷] : Jitter alert indication (P27)

7 Battery indication



- The battery indication turns red and blinks. (The status indicator blinks when the LCD monitor is turned off.) Replace with new batteries or fully charged Ni-MH batteries.
- It does not appear when using the AC adaptor (DMW-AC6; optional).

8 Remaining number of recordable pictures

9 Recording indication

10 Built-in memory [IN] / Card [C]

([IN] or [C] lights red during accessing.)

- Do not do the following when the access indication lights.
 - Turn the camera off.
 - Remove the batteries or the card (if used).

- Shake or impact the camera.
- Disconnect the AC adaptor (DMW-AC6; optional). (when using the AC adaptor)

- Observe the above caution also when pictures are being read or deleted or the built-in memory (or the card) is being formatted (P83).
- The access time for the built-in memory may be longer than the access time for a card. (Max. about 7 sec.)

11 Shutter speed (P25)

12 Aperture value (P25)

- If the exposure is not adequate, the aperture value and the shutter speed turn red. (They do not turn red when the flash is activated.)

13 Optical image stabilizer (P64)





- For details about other displays, see page 92.

■ Changing the display

Press [DISPLAY] to change the display. Choose whether to display information such as the number of pixels and possible number of images for recording while you are shooting. For details, see page 37.

Taking Pictures

 Select normal picture mode [].

The camera automatically sets the shutter speed and the aperture value according to the brightness of the subject.

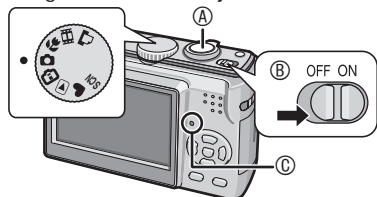

- A Shutter button
- B Turn the camera on.
- C The status indicator lights for 1 second.

1 Hold the camera gently with both hands, keep your arms still at your side and stand with your feet shoulder-width apart.

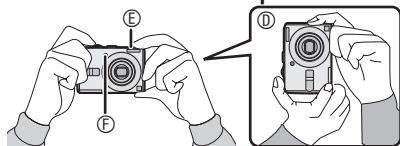

- D: When holding the camera vertically
- E: Flash
- F: AF assist lamp

2 Aim the AF area  to the point you want to focus on.

3 Press the shutter button halfway to focus.

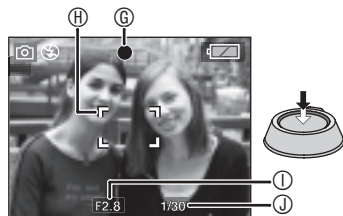

- G: The focus indication lights green.
- H: AF area: white → green

 Aperture value



 Shutter speed

- The camera beeps twice when the subject is focused.
- **The camera can focus between 50 cm (1.64 feet) and ∞.**
- The following indicate that the subject is out of focus.
 - Focus indication blinks (green).
 - AF area turns white to red or no AF area.
 - Beeps 4 times.
- The focus indicator may light even if the subject is not properly focused if the subject is out of range.

4 Press the shutter button fully to take the picture.



■ Using the flash

If the flash is set to AUTO [A] or AUTO/Red-eye reduction [A], the flash will work when you press the shutter button if the camera determines that the area to be shot is too dark.

- You can change the flash settings (P40).



- When you press the shutter button, the screen may become bright or dark for a moment. This function allows easy adjustment of focus and the recorded picture will not be affected.
- Be careful not to move the camera when you press the shutter button.
- Do not cover the photo flash or the AF assist lamp with your finger or other objects.
- Do not touch the lens.

Photography basics – exposure, focus, and color

A little knowledge about exposure, focus and color will come in handy when you are having trouble with a shot.

Are images dark?

Exposure problems

Go to page 44

In normal picture mode [, Auto Exposure (AE) normally sets the correct exposure for you, but images may be dark if there is backlight.

Use exposure compensation in these situations for brighter images.

Focus problems

Go to page 27, 46

In normal picture mode [, Auto Focus (AF) normally sets the correct focus for you, but images may be unfocused in the following situations. The camera can focus between 50 cm (1.64 feet) and ∞ .

- When shooting something that is far away and something that is close by at the same time.
- When shooting through a dirty window.
- When there are sparkling or shiny objects around the subject.
- When shooting in a dark place.
- When shooting a subject that is moving fast.
- When shooting a scene with minimal contrast.
- When shooting something very bright.
- When taking a close-up picture of the subject
- When there is jitter.

Use AF/AE lock or macro mode [] in these situations.

Color problems

Go to page 60

How the subject appears depends on the kind of lighting, so colors in different lights will be different. This unit adjusts the color automatically to give a more natural result. (Auto white balance)

You can also adjust the white balance to suit different situations to reproduce natural colors.

■ When you want to take a subject outside the AF area (AF/AE Lock)

When recording a picture of people with a composition like the following picture, you will not be able to focus the camera on the subject because the people are outside the AF area.



In this case,

- 1 Aim the AF area at the subject.
- 2 Press the shutter button halfway to fix the focus and the exposure.
 - The focus indication lights when the subject is focused.
- 3 Press and hold the shutter button halfway while moving the camera as you compose the picture.
- 4 Press the shutter button fully.
 - You can repeatedly retry AF/AE lock before pressing the shutter button fully.



■ Direction detection function

- If you take pictures by holding the camera vertically, the information of the rotation on the pictures is automatically added and recorded to the pictures. When [ROTATE DISP.] (P74) is set to [ON], you can rotate and display pictures on the screen or the TV according to the information of the rotation on the pictures.
- This function may not work properly on pictures recorded by aiming the camera up or down.
- In motion picture mode [M], you cannot use the direction detection function.

■ Preventing jitter (camera shake)

- Be careful of jittering when pressing the shutter button.
- The jitter alert ① appears when the shutter speed is slow and the chances of blurring are greater.



- When the jitter alert appears, take special care with the shooting methods described on P25, or use a tripod for best results. By combining the use of a tripod with the self-timer (P43), you can avoid blurring caused when you press the shutter button.
- Shutter speed will be slower particularly in the following cases. Keep the camera still from the moment the shutter button is pressed until the picture appears on the screen. We recommend using a tripod.
 - [NIGHT PORTRAIT], [NIGHT SCENERY], [PARTY], [CANDLE LIGHT], [STARRY SKY], [FIREWORKS] in scene mode (P47)

Taking Pictures in Simple Mode



This mode allows beginners to take pictures easily. Only the basic functions appear in the menu to make operations simple.

Basic menu settings

1 Press [MENU/SET].

2 Press ▲/▼ to select the desired menu item and then press ►.

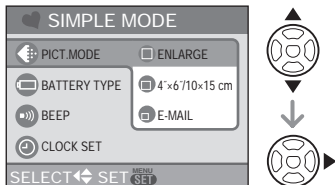

3 Press ▲/▼ to select the desired setting and then press [MENU/SET].

4 Press [MENU/SET] to close the menu.

- You can also press the shutter button halfway to close the menu.

Settings in Simple mode

[PICT.MODE]

<input type="checkbox"/> ENLARGE	Suitable for enlarging the pictures to be printed to 8" × 10" size, letter size etc.
<input type="checkbox"/> 4" × 6"/10 × 15 cm	Suitable for regular size printing.
<input type="checkbox"/> E-MAIL	Suitable for attaching pictures to e-mails or adding pictures to websites.

[BATTERY TYPE]

Change the battery type being used. (P21)

[BEEP]

<input type="checkbox"/> OFF	No operation sound
<input type="checkbox"/> LOW	Soft operation sound
<input type="checkbox"/> HIGH	Loud operation sound

[CLOCK SET]

Change date and time. (P17)

- If [4" × 6"/10 × 15 cm] or [E-MAIL] is set in [PICT.MODE], the extended optical zoom is activated (P30).
- The settings for [BATTERY TYPE], [BEEP] and [CLOCK SET] in simple mode are also applied to other recording modes.
- The settings for [WORLD TIME] (P22), [MONITOR] (P22), [TRAVEL DATE] (P22), [NO.RESET] (P22) and [LANGUAGE] (P23) in the [SETUP] menu are applied to simple mode.

Other Settings in simple mode

In simple mode, other settings are fixed as follows. For more information about each setting, refer to the page indicated.

- Focus range:
 - 30 cm (0.98 feet) to ∞ (Tele)
 - 5 cm (0.16 feet) to ∞ (Wide)
- [AUTO REVIEW] (P21): [1SEC.]
- [POWER SAVE] (P21): [5MIN.]
- [ECONOMY] (P22): [OFF]
- Self-timer (P43): 10 seconds
- Optical Image Stabilizer (P64): [MODE2]
- [W.BALANCE] (P60): [AWB]

- [SENSITIVITY] (P61):
Settings will be the same as those used when you have set ISO LIMIT in Intelligent ISO mode [] (P45) to [ISO800].
- [ASPECT RATIO]/[PICT.SIZE]/[QUALITY] (P62):
 - [ENLARGE]:
4:3/DMC-LS75/DMC-LS70: [**7M**] (7M),
DMC-LS60: [**6M**] (6M)/Fine
 - [4" × 6"/10 × 15 cm]:
3:2 / [**2.5M**] (2.5M EZ)/Standard
 - [E-MAIL]:
4:3 / [**0.3M**] (0.3M EZ)/Standard
- [AF MODE] (P63):
[] (1-area-focusing)
- [AF ASSIST LAMP] (P66)
[ON]
- You cannot use the following functions in simple mode.
 - High angle mode
 - Exposure compensation
 - [BURST]
 - [D.ZOOM]
 - [COL.MODE]
- You cannot change the following settings.
 - [TRAVEL DATE]
 - [WORLD TIME]

■ The Backlight Compensation

Backlight is a situation where light comes from behind the subject. This can cause the subject to appear dark, so brightening the whole image compensates for this.

Press ▲.

- [] appears when you are using backlight compensation. Press ▲ to cancel.



- When you use the backlight compensation function, we recommend using the flash. (When you use the flash, the flash setting is fixed to Forced ON [].)
- When you use the flash with the backlight compensation off, the flash setting is fixed to AUTO/Red-eye reduction [].

Taking Pictures with the Zoom

Using the Optical Zoom / the Extended Optical Zoom (EZ)



You can make people and subjects appear closer with the 3 times optical zoom, and landscapes can be recorded in wide angle. (35 mm film camera equivalent: 35 mm to 105 mm)

To zoom even more (up to 4.5 times with DMC-LS75/DMC-LS70) with no reduction in picture quality, choose any resolution for each of the available aspect ratios except the largest one.

■ To make subjects appear closer use (Tele)

Rotate the zoom lever towards Tele.



■ To make subjects appear further away use (Wide)

Rotate the zoom lever towards Wide.



■ How the extended optical zoom works

The extended optical zoom works by extracting the center of the picture and expanding it for a higher telephoto effect. So, for example, if you choose [3M] (3M EZ) (3 million pixels), the 7M (7 million) (DMC-LS75/DMC-LS70) or 6M (6 million) (DMC-LS60) CCD area is cropped to the center 3M (3 million pixels) area, allowing a picture with a higher zoom effect.

■ Resolution and maximum zoom

Aspect ratio (P62)	Pixels (P29, 62)	Maximum zoom (Tele)	
		DMC-LS75/ DMC-LS70	DMC-LS60
4:3	DMC-LS75/ DMC-LS70 [7M] / (7M)	3 ×	—
	DMC-LS60 only [6M] / (6M)	—	3 ×
	DMC-LS75/ DMC-LS70 [5M] (5M EZ)	3.6 ×	—
	[3M] (3M EZ), [2M] (2M EZ), [1M] (1M EZ), [0.3M] / (0.3M EZ)	4.5 ×	4.1 ×
3:2	DMC-LS75/ DMC-LS70 [6M] (6M)	3 ×	—
	DMC-LS60 only [5M] (5M)	—	3 ×
	[2.5M] / (2.5M EZ)	4.5 ×	4.1 ×
16:9	DMC-LS75/ DMC-LS70 [5.5M] (5.5M)	3 ×	—
	DMC-LS60 only [4.5M] (4.5M)	—	3 ×
	[2M] (2M EZ)	4.5 ×	4.1 ×



- The optical zoom is set to Wide (1 ×) when the camera is turned on.
- If you use the zoom function after focusing on the subject, focus on the subject again.
- The lens barrel (P9) extends or retracts according to the zoom position. Take care not to interrupt the motion of the lens barrel while the zoom lever is rotated.
- In motion picture mode [H], the zoom magnification is fixed to the value set at the start of recording.

- "EZ" is an abbreviation of [Extended optical Zoom].
- If you set a picture size that activates the extended optical zoom, the extended optical zoom icon [EZ] is displayed on the screen when you use the zoom function.
- The zoom will stop moving for an instant near [W] (1 ×) when the extended optical zoom is used. This is not a malfunction.
- The indicated zoom magnification is an approximation.
- In motion picture mode [MOVIE] and [HIGH SENS.] in scene mode, the extended optical zoom does not work.

Using the easy zoom button



Press the [E.ZOOM] button to quickly zoom. Actual zoom factors depend on the pixel recording setting.

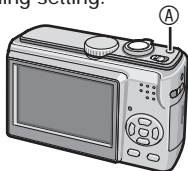

A [E.ZOOM] button

■ When the picture size is set to the highest resolution for each aspect ratio

Resolution is temporarily reduced and you can use the extended optical zoom.

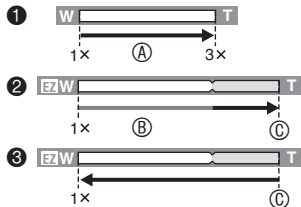

- 1 Press [E.ZOOM] once.
 - 2 Press [E.ZOOM] twice.
 - 3 Press [E.ZOOM] three times.
- A Optical zoom

- 4 Extended optical zoom
 - 5 Maximum extended optical zoom magnification
- The resolution becomes smaller as shown below when the extended optical zoom is used. The color of the zoom bar and the resolution displayed on the screen change at this time.

Aspect ratio	Picture size
4:3	3M
3:2	2.5M
16:9	2M

- If you press [E.ZOOM] three times, the zoom position returns to the Wide and the resolution returns to the original. The resolution also returns to normal when you return the zoom lever to the optical zoom position.

■ When the picture size is set except highest resolution for each aspect ratio

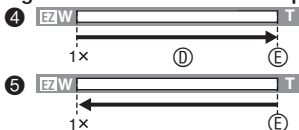

- 4 Press [E.ZOOM] once.
 - 5 Press [E.ZOOM] twice.
- D Extended optical zoom
E Maximum extended optical zoom magnification



- Press [E.ZOOM] until the zoom starts working.
- The easy zoom is also activated if the zoom position is anything other than Wide.
- You can further extend the zoom to the Digital zoom range when [D.ZOOM] (P32) is set to [ON].
- In [ENLARGE] in simple mode [HEART], [HIGH SENS.] (P51) in scene mode and motion picture mode [MOVIE], the zoom is limited to the 3 × optical zoom.
- The indicated zoom magnification is an approximation.

Using the Digital Zoom Further extending the zoom



A maximum of 12 × zoom can be achieved with the 3 × optical zoom and the 4 × digital zoom when [D.ZOOM] is set to [ON] in the [REC] menu. However, if a picture size that can use extended optical zoom is selected, a maximum of 18 × zoom can be achieved with the 4.5 × extended optical zoom and the 4 × digital zoom (DMC-LS75/DMC-LS70).

Menu operation

1 Press [MENU/SET].

- When a scene mode is selected, select the [REC] menu icon and then press .

2 Press / to select [D.ZOOM] and then press .

3 Press to select [ON] and then press [MENU/SET].

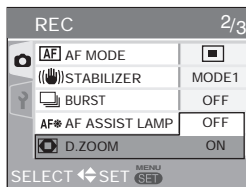

4 Press [MENU/SET] to close the menu.

- You can also press the shutter button halfway to close the menu.

Entering the digital zoom range

When you rotate the zoom lever to the extreme Tele position, the on-screen zoom indication may momentarily pause. You can enter the digital zoom range to continuously rotate the zoom lever to Tele or to release the zoom lever once and then rotate it to Tele again.

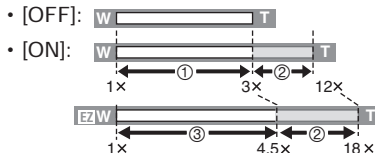

For example: When using the digital zoom and the extended optical zoom [[3M]] (3M EZ) at the same time with DMC-LS75/DMC-LS70.

- Optical zoom
- Digital zoom
- Extended optical zoom



- The AF area is displayed with a size wider than usual and set only to a point on the center of the screen in the digital zoom range. (P64) Also, the stabilizer function may not be effective.
- When using the digital zoom, the picture quality becomes deteriorated.
- When using the digital zoom, use a tripod and the self-timer (P43) for best results.
- The indicated zoom magnification is an approximation.
- The digital zoom does not operate in the following cases.
 - In simple mode []
 - In intelligent ISO mode []
 - In [SPORTS], [BABY1]/[BABY2], [PET] and [HIGH SENS.] in scene mode (P47)

Checking the Recorded Picture (Review)



You can check the recorded pictures while still in [REC] mode.

1 Press ▼ [REV].



- The last recorded picture appears for about 10 seconds.
- Review is canceled when the shutter button is pressed halfway or the ▼ [REV] is pressed again.

2 Press ◀▶ to choose a picture.



◀ : Previous picture

▶ : Next picture

■ Enlarging pictures

1 Rotate the zoom lever towards [Q] [T].

- Rotate the zoom lever to [Q] [T] for a 4× magnification and then rotate it even more for a 8× magnification. When you rotate the zoom lever towards [W] after enlarging the picture, the magnification becomes lower.

2 Press ▲/▼/◀▶ to move the position.

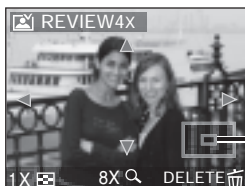

- When you change the magnification or the position to be displayed, the zoom position indication **A** appears for about 1 second to check where is enlarged.

■ Recorded pictures can be deleted during the review (Quick Deletion)

During review you can delete one, multiple, or all pictures. For details about how to delete images, see page 35.



- When [ROTATE DISP.] is set to [ON], pictures recorded holding the camera vertically are played back vertically (rotated) (P74).

Playing Back Pictures



The picture data on the built-in memory appears when a card is not inserted. The picture data on the card appears when a card is inserted. (P16)

Press ◀▶ to select the picture.



- ◀: Play back the previous picture.
- ▶: Play back the next picture.

■ Fast forwarding/Fast rewinding

Press and hold ◀▶ during playback.

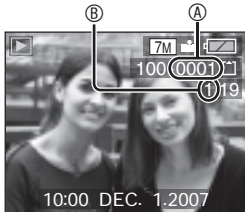

- ▶: Fast forward
- ◀: Fast rewind

- The file number ① and the picture number ② only change one by one. Release ◀▶ when the number of the desired picture appears to play back the picture.
- If you press and hold ◀▶, you can forward/rewind faster.
- In review playback in the recording mode or multi playback (P67), the picture can only be forwarded or rewound one by one.



- This camera is based on the DCF standards (Design rule for Camera File system) which was established by the Japan Electronics and Information Technology Industries Association (JEITA).
- The LCD monitor may not be able to display the details of the recorded pictures. You can use the playback zoom (P69) to check the details of the pictures.
- If you play back pictures that have been recorded with other equipment, the picture quality may deteriorate. (The pictures are displayed as [THUMBNAIL IS DISPLAYED] on the screen.)
- When changing the folder name or file name on a PC, the pictures will not be played back.
- When playing back a file out of standard, the folder/file number is indicated by [—] and the screen may turn black.
- You cannot play back the audio of still pictures with audio recorded on other equipment.

Deleting Pictures



The picture data on the built-in memory is deleted when a card is not inserted. The picture data on the card is deleted when a card is inserted. (P16)

- Once deleted, pictures cannot be recovered. Please double-check before deleting pictures.

■ To delete a single picture

1 Select the picture with .

2 Press .

3 Press to select [YES] and then press [MENU/SET].



- While deleting the picture, appears on the screen.

■ To delete [MULTI DELETE]/[ALL DELETE]

1 Press twice.

2 Press / to select [MULTI DELETE] or [ALL DELETE] and then press [MENU/SET].





- If you select [MULTI DELETE], perform steps 3 onwards.
- If you select [ALL DELETE], perform steps 5 onwards.
- When [FAVORITE] (P73) is set to [ON], [ALL DELETE EXCEPT ★] appears. If you select [ALL DELETE EXCEPT ★], perform steps 5 onwards. (However, if none of the pictures have [★] displayed, you cannot select [ALL DELETE EXCEPT ★] even if [FAVORITE] is set to [ON].)

3 Press to select the picture and then press to set.

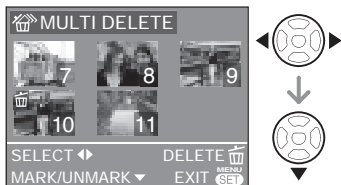
(Only when selecting [MULTI DELETE])



- Repeat the above procedure.
- The selected pictures appear with . When  is pressed again, the setting is canceled.
- The icon  blinks red if the selected picture cannot be deleted. Cancel the protect setting. (P79)

4 Press .

5 Press to select [YES] and then press [MENU/SET] to set.

(Screen when selecting [MULTI DELETE])



- When you delete all pictures, only pictures in either of the built-in memory or the card can be deleted. (You cannot delete pictures in both the built-in memory and the card at the same time.)
- [DELETE ALL PICTURES ON THE BUILT-IN MEMORY ?] or [DELETE ALL PICTURES ON THE MEMORY CARD ?] is displayed when using [ALL DELETE], and [DELETE ALL EXCEPT ★?] is displayed when using [ALL DELETE EXCEPT ★].
- If you press [MENU/SET] while deleting pictures using [ALL DELETE] or [ALL DELETE EXCEPT ★], the deleting will stop halfway.



- Do not turn off the camera while deleting.
- When deleting pictures, use batteries with sufficient battery power (P24) or use the AC adaptor (DMW-AC6; optional).
- It is possible to delete up to 50 pictures at one time using [MULTI DELETE].
- The more pictures there are to delete, the more time it takes.
- In the following cases, pictures are not deleted even if [ALL DELETE] or [ALL DELETE EXCEPT ★] is selected.
 - When the Write-protect switch of the SD Memory Card or SDHC Memory Card is set to the [LOCK] side (P16)
 - When files do not conform to the DCF (P34)
 - When pictures are protected  (P79)

About the LCD Monitor

Changing the information displayed

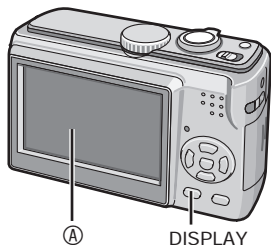

Ⓐ LCD monitor (LCD)

Press the [DISPLAY] button to switch to the screen to be used.

- When the menu screen appears, the [DISPLAY] button is not activated. During playback zoom (P69), while playing back motion pictures (P70) and during a slide show (P72), you can only select "Normal display" or "Non-display".

In recording mode

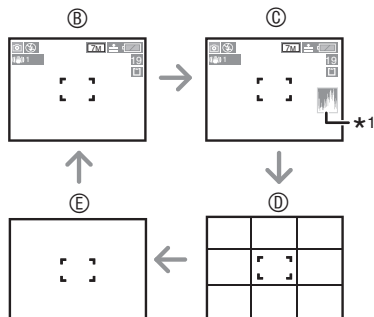

Ⓑ Normal display

Ⓒ Display with histogram

Ⓓ Guide line display

Ⓔ Non-display

*1 Histogram

In playback mode

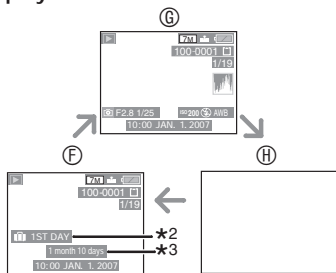

Ⓕ Normal display

Ⓖ Display with recording information and histogram

Ⓗ Non-display

*2 The number of days that have passed since the travel date is displayed when a picture was taken with [TRAVEL DATE] (P55) setting.

*3 Displayed when you set birthday setting for [BABY1]/[BABY2] or [PET] in scene mode, and [WITH AGE] is selected (P50) at taking pictures.

In simple mode [♥]

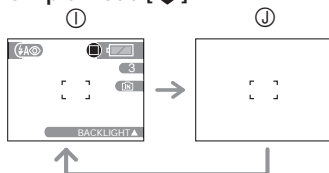

Ⓚ Normal display

Ⓛ Non-display



- In [NIGHT PORTRAIT], [NIGHT SCENERY], [STARRY SKY] and [FIREWORKS] in scene mode (P47), the guide lines are grey.

■ About guide line display

When you align the subject on the guide lines or the cross point of these lines, you can take pictures with well-designed composition by viewing the size, the slope and the balance of the subject.

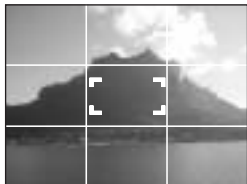

■ Histogram

- A histogram is a graph that displays brightness along the horizontal axis (black to white) and the number of pixels at each brightness level on the vertical axis.
- It allows the camera user to easily check the way a picture is being exposed.
- When the values in the histogram are distributed evenly **(A)**, the exposure is adequate and the brightness is well-balanced.
- When the values are concentrated to the left **(B)**, the picture is under exposed. Pictures that are mostly black, such as night scenery, forms this type of histogram.
- When the values are concentrated to the right **(C)**, the picture is over exposed. Pictures that are mostly white, form this type of histogram.

Example of histogram

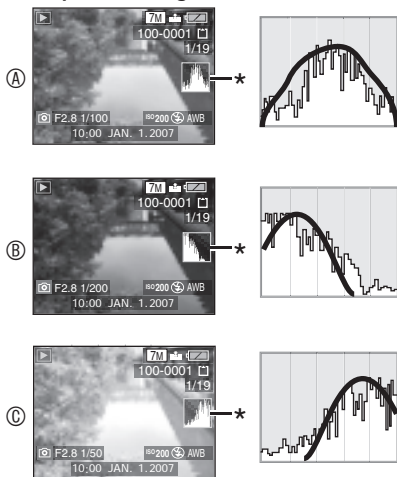

(A) Properly Exposed

(B) Under Exposed

(C) Over Exposed

* Histogram



- The image you are shooting and the histogram may not match when shooting in a dark place or with the flash. The histogram will be orange to indicate this.
- The histogram in the recording mode is an approximation.
- The histogram in recording and playback may not match each other.
- The histogram in this camera does not match the one displayed in image editing software used with a PC, etc.
- No histogram appears in the following cases.
 - In simple mode [**♥**].
 - In motion picture mode [**⏏**].
 - While multi playback is in progress.
 - While calendar playback is in progress.
 - While playback zoom is in use.

Recording a picture with the camera held high above your head (High angle mode)



The LCD monitor becomes easier to see when the camera is held in the following position. This is useful when you cannot get close to the subject because there is a person in the way.



Press [HIGH ANGLE] **(A)** for 1 second to display the High angle mode icon **(B)**.

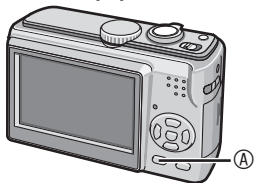

- High angle mode is activated. The LCD monitor becomes brighter and easier to see when the camera is held away from you. (However it becomes more difficult to see when looked at straight on.)

■ Canceling High angle mode

Press and hold [HIGH ANGLE] again for 1 second or turn the camera off.

- High Angle mode is also canceled if power save mode is activated.



- Pictures are displayed on the LCD monitor with increased brightness in High angle mode. Therefore, some subjects may look different on the LCD monitor. However, this does not affect the recorded pictures.
- If the LCD monitor screen is hard to see because of light from the sun etc. shining on it, block the light with your hands.
- High angle mode is not activated in the following cases:
 - In simple mode [♥]
 - In playback mode
 - In print mode [📄]
 - While the menu screen is displayed
 - During Review

Taking Pictures using the Built-in Flash

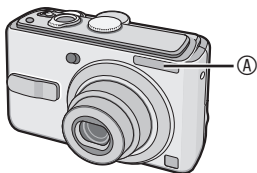

Ⓐ: Photo flash

- Do not cover the photo flash with your fingers or any other items.

Switching to the appropriate flash setting

Set the flash setting of the built-in flash according to the scene to be recorded.

1 Press **▶** [**⚡**].

2 Press **▲/▼** or **▶** [**⚡**] to switch the flash setting.

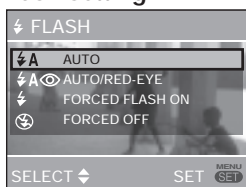

- For the flash setting contents, refer to “Flash setting”. For the selectable flash setting, refer to “Available flash settings by recording mode” (P41).

3 Press **[MENU/SET]**.

- You can also press the shutter button halfway to finish.
- When 5 seconds pass without any operation, the setting selected at the time is automatically adopted.

Flash setting

⚡ A : AUTO

The flash is automatically activated according to the recording condition.

⚡ A with eye icon : AUTO/Red-eye reduction*1

The flash is automatically activated according to the recording condition. It reduces the red-eye phenomenon (eyes of the subject appear red in photo flash) by triggering the flash before actually recording the picture.

After that, the flash is activated for actual recording again.

- Use this when you take pictures of people in low lighting conditions.

⚡ : Forced ON

The flash is activated every time regardless of the recording condition.

- Use this when your subject is back-lit or under fluorescent light.

⚡ with eye icon : Forced ON/Red-eye reduction*1

- In [PARTY] or [CANDLE LIGHT] in scene mode (P47), the flash mode is set to Forced ON/Red-eye reduction.

⚡ S with eye icon : Slow sync./Red-eye reduction*1

When you take a picture with a dark background landscape, this feature makes the shutter speed slow when the flash is activated, so that the dark background landscape will become bright. Simultaneously it reduces the red-eye phenomenon.

- You can use this setting only in [NIGHT PORTRAIT], [PARTY] or [CANDLE LIGHT] in scene mode (P47).

⊕ : Forced OFF

The flash is not activated in any recording condition.

- Use this when taking pictures in places where the use of the flash is not permitted.

*1 The flash is activated twice. The subject should not move until the second flash is activated.

■ Available flash settings by recording mode

The available flash settings depend on the recording mode.

(: Available, — : Not available, : Initial setting)

	↓A	↓A	↓	↓S	↓	⊕
	○	○	○	—	—	○
	—	○*2	—*2	—	—	○
	○	○	○	—	—	○
	○	○	○	—	—	○
	○	⊙	○	—	—	○
	○	⊙	○	—	—	○
	—	—	—	—	—	⊙
	⊙	—	○	—	—	○
	—	—	—	⊙	—	○
	—	—	—	—	—	⊙
	○	—	○	—	—	⊙
	—	—	—	⊙	○	○
	—	—	—	○	○	⊙
	—	—	—	—	—	⊙
	—	⊙	○	—	—	○
	—	⊙	○	—	—	○
	○	—	○	—	—	⊙
	—	—	—	—	—	⊙
	—	—	⊙	—	—	○
	—	—	—	—	—	⊙
	—	—	—	—	—	⊙
	⊙	—	○	—	—	○
	—	—	—	—	—	⊙
	—	—	—	—	—	○

*2 It becomes Forced ON (⊕), when the backlight compensation function is activated.

- The flash setting may change when you change the recording mode. Change the flash setting again if necessary.
- Flash settings are retained even if you switch the camera off. However, scene mode flash settings return to the factory settings when you change the scene mode.

■ The available flash range to take pictures

ISO sensitivity (P61)	Available flash range
AUTO	30 cm (0.98 feet) to 4.7 m (15.42 feet) (Wide) 30 cm (0.98 feet) to 2.6 m (8.53 feet) (Tele)
ISO100	30 cm (0.98 feet) to 1.8 m (5.91 feet) (Wide) 30 cm (0.98 feet) to 1.0 m (3.28 feet) (Tele)
ISO200	40 cm (1.31 feet) to 2.6 m (8.53 feet) (Wide) 30 cm (0.98 feet) to 1.4 m (4.59 feet) (Tele)
ISO400	60 cm (1.97 feet) to 3.7 m (12.14 feet) (Wide) 40 cm (1.31 feet) to 2.1 m (6.89 feet) (Tele)
ISO800	80 cm (2.62 feet) to 5.3 m (17.39 feet) (Wide) 60 cm (1.97 feet) to 2.9 m (9.51 feet) (Tele)
ISO1250	100 cm (3.28 feet) to 5.3 m (17.39 feet) (Wide) 80 cm (2.62 feet) to 2.9 m (9.51 feet) (Tele)

- Refer to P107 for the focus range.
- When you use the flash when you have set ISO sensitivity to [AUTO] or set ISO LIMIT in Intelligent ISO mode (⊕) to anything other than [ISO400], ISO sensitivity automatically becomes a maximum of [ISO640] ([ISO400] in the [BABY1]/[BABY2] or [PET] scene modes (P47)).
- The edges of the picture may appear dark if you shoot a very close subject with the flash while the zoom lever is close to the W side. Zoom in slightly if this occurs.

■ The available flash range to take pictures in intelligent ISO mode

ISO LIMIT (P45)	Available flash range
ISO400	30 cm (0.98 feet) to 3.7 m (12.14 feet) (Wide) 30 cm (0.98 feet) to 2.1 m (6.89 feet) (Tele)
ISO800	30 cm (0.98 feet) to 5.3 m (17.39 feet) (Wide)
ISO1250	30 cm (0.98 feet) to 2.9 m (9.51 feet) (Tele)

- When you have set ISO LIMIT in Intelligent ISO mode [] (P45) to anything other than [ISO400] and use the flash, ISO sensitivity automatically rises to a maximum of [ISO640].

■ Shutter speed for each flash mode

Flash mode	Shutter speed (sec.)
: AUTO	1/30 to 1/2000
: AUTO/ Red-eye reduction	1/30 to 1/2000
: Forced ON : Forced ON/Red-eye reduction	1/30 to 1/2000
: Slow sync./ Red-eye reduction	1/4 or 1 to 1/2000* ¹ 1/4 to 1/2000* ²
: Forced OFF	1/4 to 1/2000 1/8 or 1 to 1/2000* ³ 1/4 or 1 to 1/2000* ⁴

*1 [NIGHT PORTRAIT] (P48) or [CANDLE LIGHT] (P49) in scene mode

*2 [PARTY] (P49) in scene mode

*3 In simple mode []

*4 Intelligent ISO mode [] (P45)/
[SPORTS] (P48), [NIGHT PORTRAIT] (P48), [CANDLE LIGHT] (P49), [BABY] (P50), and [PET] (P50) in scene mode

- The shutter speed reaches the maximum of 1 second for *1, *3 and *4 when:
 - Optical Image Stabilizer is [OFF]
 - In simple mode [] or when the Optical

Image Stabilizer is set to [MODE1] or [MODE2] and the camera determines that there is minimum possibility of blurring.

- The shutter speed will be different from that shown in the above table in the following scene modes.
 - [NIGHT SCENERY] (P49):
8 seconds to 1/2000th of a second
 - [STARRY SKY] (P51):
15 seconds, 30 seconds, 60 seconds
 - [FIREWORKS] (P52):
1/4th of a second, 2 seconds



- Do not look directly at the flash at close range when it is activated.**
- Do not bring the flash too close to objects or close the flash while it is activated. The objects may be discolored by its heat or lighting.**
- While the flash is charged, the LCD monitor turns off and you cannot take pictures. The status indicator lights up. [This does not happen when using the AC adaptor (DMW-AC6; optional).] If the remaining battery power is low, the screen may be turned off for a longer period of time.**
- When you take a picture beyond the available flash range, the exposure may not be adjusted properly and the picture may become bright or dark.
- The white balance may not be properly adjusted if the photo flash is insufficient. (P60)
- When the shutter speed is fast, the flash effect may not be sufficient.
- When you repeat taking a picture, recording may be disabled even if the flash is activated. Take a picture after the access indication disappears.
- The red-eye reduction effect differs between people. Also, if the subject was far away from the camera or was not looking at the first flash, the effect may not be evident.
- You cannot take photographs in succession when using the flash.

Taking Pictures with the Self-timer



1 Press ◀ [⌚].

2 Press ▲/▼ or ◀ [⌚] to switch the self-timer mode.



3 Press [MENU/SET].

- You can also press the shutter button halfway to finish.
- When 5 seconds pass without any operation, the setting selected at the time is automatically adopted.

4 Press the shutter button halfway to focus and then press it fully to take a picture.



- The self-timer indicator ① blinks and the shutter is activated after 10 seconds (or 2 seconds).
- If you press [MENU/SET] when the self-timer is set, the self-timer setting is canceled.

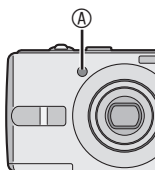

- When using a tripod or in other cases, setting the self-timer to 2 seconds is a convenient way to stabilize the jitter caused by pressing the shutter button.
- When you press the button fully with one stroke, the subject is automatically focused just before the recording. In dark places, the self-timer indicator blinks and then it may turn on brightly to work as the AF assist lamp (P66) for focusing on the subject.
- In simple mode [♥], the self-timer is fixed to 10 seconds.
- When you set the self-timer in burst mode, the camera starts taking a picture 2 or 10 seconds after the shutter button is pressed. The number of pictures taken at one time is fixed to 3.
- We recommend using a tripod when setting the self-timer.

Compensating the Exposure



Use this function when you cannot achieve appropriate exposure due to the difference of brightness between the subject and the background.

Over exposed



Compensate the exposure toward negative.

Properly Exposed



Compensate the exposure toward positive.

Under exposed

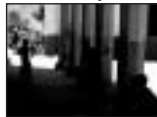

- 1 Press \blacktriangle [\pm] to display [\pm EXPOSURE] and press \blacktriangleleft / \blacktriangleright to compensate the exposure.

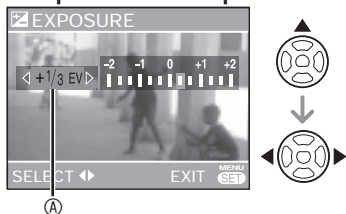

- \textcircled{A} : The exposure compensation value
- You can compensate from -2 EV to +2 EV in steps of 1/3 EV.
- Select [0 EV] to return to the original exposure.

- 2 Press [MENU/SET] to finish.

- You can also press the shutter button halfway to finish.



- EV is an abbreviation of "Exposure Value", and it is the amount of light given to the CCD by the aperture value and the shutter speed.
- The exposure compensation value appears on the lower left of the screen.
- The exposure value is memorized even if the camera is turned off.
- The compensation range of the exposure will be limited depending on the brightness of the subject.
- You cannot compensate the exposure with [STARRY SKY] in scene mode.

Shooting with the Intelligent ISO mode



The camera detects movements of the subject near the center of the frame and sets the optimum ISO sensitivity and shutter speed according to the movements and brightness.

1 Press [MENU/SET].

2 Press ▲/▼ to select [ISO LIMIT] and then press ►.

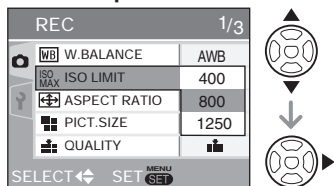

3 Press ▲/▼ to select the menu item and then press [MENU/SET].

Item	Content
400	The camera raises the ISO sensitivity up to the level you have set to match the movement and brightness of the subject.
800	
1250	

- The higher you raise the ISO sensitivity, the less chance there is of the subject blurring, but picture noise will increase.
- When shooting a moving subject indoors, you can reduce blur by raising ISO sensitivity and increasing the shutter speed.



1/125 ISO800

- When taking pictures of a motionless subject, you can reduce noise by setting ISO sensitivity at a low level.



1/30 ISO200

- When you press the shutter button halfway, [iISO] appears. When you press the shutter button fully, the shutter speed and the ISO sensitivity appear for a while.



- Focus range is 5 cm (0.16 feet) (Wide)/30 cm (0.98 feet) (Tele) to ∞.
- ISO sensitivity can be raised to a maximum of [ISO640] when using the flash (when ISO Limit is set to anything other than [ISO400]).
- Refer to P42 for the available flash range.
- Brightness or the subject's moving speed may cause pictures to blur.
- Movement detection may not be possible in the following cases.
 - When the moving subject is too small
 - When the moving subject is on the edge of the frame
 - In case the subject began to move the moment you pressed the shutter button fully
- To avoid picture noises, we recommend reducing the [ISO LIMIT] or setting [COL. MODE] to [NATURAL] (P66).
- You cannot use the digital zoom.

Taking Close-up pictures



This mode allows you to take close-up pictures of the subject, e.g. When taking pictures of flowers.

You can take pictures approaching the subject at a distance up to 5 cm (0.16 feet) from the lens by rotating the zoom lever upmost to Wide (1 ×).

■ Focus range

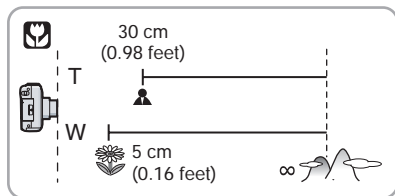

- Use a tripod and the self-timer (P43) for best results.
- When the subject is close to the camera, the effective focus range (depth of field) is significantly narrowed. Therefore, you will have difficulty in focusing on the subject if the distance between the camera and the subject is changed after focusing on the subject.
- When the camera lens is at a distance beyond the available range from the subject, the subject may not be focused even if the focus indication lights.
- Macro mode gives priority to a subject close to the camera. Therefore, if the distance between the camera and the subject is more than 50 cm (1.64 feet) it takes longer to focus on it in macro mode than normal picture mode.
- The available flash range is about 30 cm (0.98 feet) to 5.0 m (16.40 feet) (Wide). (This is applied when you set the ISO sensitivity to [AUTO].) We recommend setting the flash to Forced OFF [] when you take pictures at close range.
- When you take pictures at close range, the resolution of the periphery of the picture may decrease slightly. This is not a malfunction.

Scene mode



When you select a scene mode to match the subject and recording situation, the camera sets the optimal exposure and hue to obtain the desired picture.

- See pages 48 to 52 for details about the modes. Explanations about the scene modes are also included in the camera's [i INFORMATION] feature.

1 Press \blacktriangleright to enter the scene mode menu screen.

2 Press $\blacktriangle/\blacktriangledown/\blacktriangleleft/\blacktriangleright$ to select the scene mode.

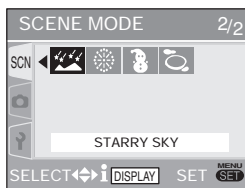
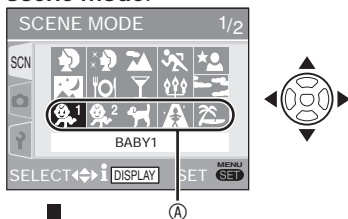

- Press \blacktriangledown at **A** to switch to the next menu screen.
- You can switch menu screens from any menu item by rotating the zoom lever.

3 Press [MENU/SET].

- Now you can take pictures with the scene mode that you selected.
- Press [MENU/SET] and then perform steps 1, 2 and 3 to change the scene mode.

■ Scene mode help [i INFORMATION]

- To see explanations about the scene modes, press [DISPLAY] while a scene mode is selected in step 2. Press again to return to the scene mode menu.



- Refer to P42 for the shutter speed.
- Flash settings return to the factory settings when you change the scene mode (P41).
- The color of the picture may seem strange if you use a scene mode that is unsuitable for the shot.
- [SCN] is selected if you press \blacktriangleleft while you have selected either [PORTRAIT] or [STARRY SKY] in step 2. If you select either the [REC] menu [RECORD] or the [SETUP] menu [SETUP], you can set the desired items. (P19)
- The following cannot be set in scene mode because the camera automatically adjusts them to the optimal setting.
 - [SENSITIVITY]
 - [COL.MODE]

Press [] to display the [SCENE MODE] menu and select a scene mode. (P47)



Portrait mode

The background is blurred and the person stands out with a healthier complexion.

■ Technique to make this mode more effective:

- 1 Rotate the zoom lever to Tele as far as possible.
- 2 Move close to the subject.



- Suitable for outdoors in the daytime.
- ISO sensitivity is fixed to [ISO100].



Soft skin mode

The camera detects the face or skin area to achieve a smoother appearance than portrait mode. Use when taking portraits from the chest up.

■ Technique to make this mode more effective:

- 1 Rotate the zoom lever to Tele as far as possible.
- 2 Move close to the subject.



- Suitable for daylight shooting.
- Other flesh-colored elements are also softened.
- The effect may not be as obvious if there isn't enough light.
- ISO sensitivity is fixed to [ISO100].



Scenery mode

The camera focuses on distant subjects to allow you to take pictures of wide landscapes.



- Focus range is 5 m (16.4 feet) to ∞.
- The Flash setting is fixed to Forced OFF [].
- The setting on the AF assist lamp is disabled.
- You cannot change the white balance setting.



Sports mode

Allows you to shoot fast moving subjects (e.g. outdoor sports).



- Suitable for daylight shooting, 5 m (16.4 feet) or more away from the subject.
- When shooting fast moving subjects indoors, sensitivity will be the same as when you have set ISO LIMIT in Intelligent ISO mode [] (P45) to [ISO800].
- The digital zoom is fixed to [OFF].



Night portrait mode

Shoot the subject with natural brightness using the flash and slow shutter speed.

■ Technique for Night portrait mode

- **Use the flash.**
- Due to the slow shutter speed, use a tripod and the self-timer (P43) for best results.
- Keep the subject still for about 1 second after taking a picture.
- Rotate the zoom lever to Wide (1 ×), about 1.5 m (4.92 feet) from the subject.



- Focus range is 1.2 m (3.94 feet) to 5 m (16.4 feet). (See page 41 for details about available flash range.)
- The shutter may close (max. about 1 sec.) after shooting due to signal processing. This is not a malfunction.
- When shooting in dark places, noise may become visible.
- When using the flash, Slow sync./Red-eye reduction [] is selected and the flash is activated every time.
- You cannot change the white balance setting.

Press [] to display the [SCENE MODE] menu and select a scene mode. (P47)



Night scenery mode

The nightscape can be recorded vividly.

■ Technique for Night scenery mode

- Use a tripod as the shutter may be open for as long as 8 seconds. Use the self-timer for best results. (P43)



- The focus range is 5 m (16.4 feet) to ∞.
- The shutter may close (max. about 8 seconds) after shooting due to signal processing. This is not a malfunction.
- When shooting in dark places, noise may become visible.
- The Flash setting is fixed to Forced OFF [].
- The ISO sensitivity is fixed to [ISO100].
- The settings on the AF assist lamp is disabled.
- You cannot change the white balance setting.



Food mode

Use to take pictures of food in restaurants, irrespective of the lighting, so that the natural colors of the subject come out.



- Focus range is 5 cm (0.16 feet) (Wide)/30 cm (0.98 feet) (Tele) to ∞.
- You cannot change the white balance setting.





Party mode

Use to take pictures at wedding receptions, indoor parties, etc. Both the people and the background can be shot with natural brightness using the flash and slow shutter speed.

■ Technique for Party mode

- Use a tripod and the self-timer (P43) for best results.
- Rotate the zoom lever to Wide (1 ×), about 1.5 m (4.92 feet) from the subject.



- The flash setting can be set to Forced ON/Red-eye reduction [] or Slow sync./Red-eye reduction [].
- You cannot change the white balance setting.





Candle light mode

Use to get the most from the mood created by candlelight.

■ Technique for Candle light mode

- Don't use the flash.
- Use a tripod and the self-timer (P43) for best results.



- The focus range is 5 cm (0.16 feet) (Wide)/30 cm (0.98 feet) (Tele) to ∞.
- The flash setting can be set to Forced ON/Red-eye reduction [] or Slow sync./Red-eye reduction [].
- You cannot change the white balance setting.

Press [] to display the [SCENE MODE] menu and select a scene mode. (P47)



Sunset mode

Use to take pictures of the sunset. Sunset color can be reproduced vividly.



- The flash setting is fixed to Forced OFF [].
- The setting on the AF assist lamp is disabled.
- ISO sensitivity is fixed to [ISO100].
- You cannot change the white balance setting.



Baby mode 1

Baby mode 2

Adjusts the exposure and tone to bring out the healthy color of your baby's skin. The flash will be weaker than normal if you choose to use it.

You can set the birthdays of two babies by using [BABY1] and [BABY2]. You can display the set age when playing back the pictures and imprint the age on the recorded pictures with [DATE STAMP] (P75).

- You can also use the [LUMIX Simple Viewer] or [PHOTOfunSTUDIO-viewer-] software on the included CD-ROM to print your baby's age. (For details, refer to the separate operating instructions for PC connection.)

■ Age display setting



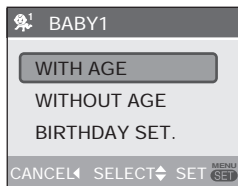

- To show age, first enter the birthday, select [WITH AGE], and press [MENU/SET].



■ Birthday setting

- 1 Select [BIRTHDAY SET.] and press

[MENU/SET].

- 2 [PLEASE SET THE BIRTHDAY OF THE BABY] appears. Select year/month/day with  and  and change the date with  and .
- 3 Press [MENU/SET] to exit.



- Focus range is 5 cm (0.16 feet) (Wide)/30 cm (0.98 feet) (Tele) to ∞.
- Sensitivity will be the same as when you have set ISO LIMIT in Intelligent ISO mode [] (P45) to [ISO400].
- After turning on the camera in [BABY1]/[BABY2] in scene mode, the age, current date, and time appear for about 5 seconds at the bottom of the screen.
- Actual age displays depend on the [LANGUAGE] setting.
- Check the clock and birthday settings if the age shown is incorrect.
- Note that if you select [WITHOUT AGE], age information is not recorded. The information will not appear even if you select [WITH AGE] after taking pictures.
- To reset the birthday setting, use [RESET] in the [SETUP] menu. (P23)
- The digital zoom is fixed to [OFF].



Pet mode

Suitable for taking pictures of your pet. Keep a record of your pet's development by adding the date. You can display the set age when playing back the pictures and imprint the age on the recorded pictures with [DATE STAMP] (P75).

- Displays and settings are the same as for the baby modes. For details on how to set age and birthday, see [BABY1]/[BABY2].
- You can also use the [LUMIX Simple Viewer] or [PHOTOfunSTUDIO-viewer-] software on the included CD-ROM to print the pet's age. (For details, refer to the separate operating instructions for PC connection.)

Press [MENU/SET] to display the [SCENE MODE] menu and select a scene mode. (P47)



- Focus range is 5 cm (0.16 feet) (Wide)/30 cm (0.98 feet) (Tele) to ∞.
- Sensitivity will be the same as when you have set ISO LIMIT in Intelligent ISO mode [LOCK] (P45) to [ISO400].
- After turning on the camera in [PET] in scene mode, the age, current date, and time appear for about 5 seconds at the bottom of the screen.
- Actual age displays depend on the [LANGUAGE] setting.
- Check the clock and birthday settings if the age shown is incorrect.
- Note that if you select [WITHOUT AGE], age information is not recorded. The information will not appear even if you select [WITH AGE] after taking pictures.
- To reset the birthday setting, use [RESET] in the [SETUP] menu. (P23)
- The digital zoom is fixed to [OFF].
- The AF assist lamp (P66) is changed to [OFF].



High Sensitivity mode

Allows you to take pictures at [ISO3200] level with high sensitivity processing.



- Focus range is 5 cm (0.16 feet) (Wide)/30 cm (0.98 feet) (Tele) to ∞.
- The resolution of the recorded picture decreases significantly because of high sensitivity processing. This is not a malfunction.
- The flash setting is fixed to Forced OFF [OFF].
- You cannot use the extended optical zoom or digital zoom.



Beach mode

Prevents under exposure of the subject under strong sunlight to allow you to take pictures on a beach.



- Do not touch the camera with wet hands.
- Sand or seawater may cause the camera to malfunction. Make sure that sand or seawater does not come in touch with the camera, particularly its lens, flash or terminals.
- You cannot change the white balance setting.



Starry sky mode

Take clear pictures of the night sky or other dark subjects.

Setting the shutter speed

Choose a shutter speed; 15, 30, or 60 seconds.

- 1 Press ▲/▼ to select the shutter speed, then press [MENU/SET].

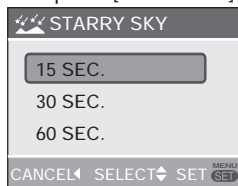

- 2 To change the shutter speed, press [MENU/SET], then select [STARRY SKY] again with ►.
- 2 Take a picture.

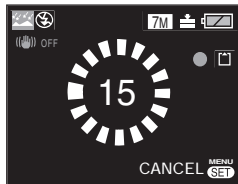

- The countdown screen appears. Do not move the camera. [PLEASE WAIT...] appears for the number of seconds you chose for shutter speed after the countdown. This is to process the signals.
- To cancel the shot, press [MENU/SET] while the countdown screen is displayed.

Press [] to display the [SCENE MODE] menu and select a scene mode. (P47)

■ Technique for Starry sky mode

- The shutter opens for 15, 30 or 60 seconds, so use a tripod and the self-timer (P43) for best results.



- The LCD darkens automatically.
- The histogram is always orange. (P38)
- The Flash setting is fixed to Forced OFF [].
- The ISO sensitivity is fixed to [ISO100].
- You cannot use exposure compensation, white balance adjustment, stabilizer function or burst mode.



Fireworks mode

Take beautiful pictures of fireworks exploding in the night sky.

■ Technique for Fireworks mode

- Shutter speed becomes slower so use a tripod.



- This is most effective on subjects 10 m (32.8 feet) or more from the camera.
- The shutter speed becomes:
 - When [OFF] is set on the optical image stabilizer function: 2 seconds
 - When optical image stabilizer [MODE1] or [MODE2] is on: 1/4th or 2 seconds (The shutter speed becomes 2 seconds when the camera determines that there is little jitter such as when using a tripod etc.)
- Histogram is always displayed in orange. (P38)
- The Flash setting is fixed to Forced OFF [].
- You cannot change the AF mode setting.
- AF area is not displayed.
- The settings on the AF assist lamp is disabled.
- ISO sensitivity is fixed to [ISO100].
- You cannot change the white balance setting.



Snow mode

Exposure and white balance are adjusted to make the white of the snow stand out.



- You cannot change the white balance setting.



Aerial photo mode

Allows you to take pictures through an airplane window.

■ Technique for Aerial photo mode

Use this technique if it is difficult to focus when taking pictures of clouds etc. Aim the camera at something with high contrast, press the shutter button halfway to fix the focus, then aim the camera at the subject and press the shutter button fully to take the picture.



- **Turn the camera off when taking off or landing.**
- **When using the camera, follow all instructions from the cabin crew.**
- Be careful about the reflection from the window.
- The flash setting is fixed to Forced OFF [].
- The setting on the AF assist lamp is disabled.
- You cannot change the white balance setting.

Motion picture mode



- 1 Press the shutter button halfway to focus and then press it fully to start recording.

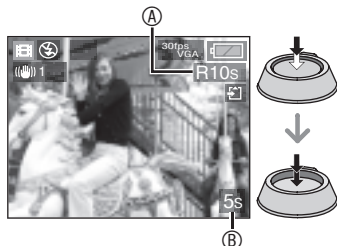

- Ⓐ: Available recording time
 Ⓑ: Elapsed recording time
- When the subject is focused, the focus indication lights.
 - The focus, zoom and aperture value are fixed to those set at the beginning of recording (for the first frame).
 - When you use the optical image stabilizer function, only [MODE1] is available in motion picture mode.

- 2 Press the shutter button fully to stop recording.

- If the built-in memory or the card becomes full in the middle of recording, the camera stops recording automatically.

- Changing the aspect ratio and the picture quality settings

- 1 Press [MENU/SET].
- 2 Press ▲/▼ to select [ASPECT RATIO] and then press ►.

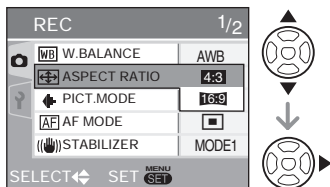

- 3 Press ▲/▼ to select the item and then press [MENU/SET].

- 4 Press ▲/▼ to select [PICT.MODE] and then press ►.

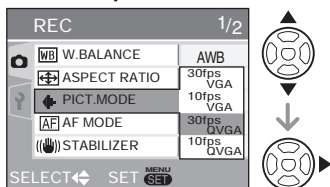

- 5 Press ▲/▼ to select the item and then press [MENU/SET].

- When the aspect ratio setting is [4:3]

Item	Picture size	fps
30fpsVGA	640 × 480 pixels	30 fps
10fpsVGA	640 × 480 pixels	10 fps
30fpsQVGA	320 × 240 pixels	30 fps
10fpsQVGA	320 × 240 pixels	10 fps

- When the aspect ratio setting is [16:9]

Item	Picture size	fps
30fps16:9	848 × 480 pixels	30 fps
10fps16:9	848 × 480 pixels	10 fps

- fps (frame per second); This refers to the number of frames used in 1 second.

- You can record smoother motion pictures with 30 fps.
 - You can record longer motion pictures with 10 fps although the picture quality is lower.
 - [10fpsQVGA]:
The file size is smaller, so the files are suitable to be attached to e-mails.
 - * **You can only record to the built-in memory if the picture size is set to "30fpsQVGA" / "10fpsQVGA".**
- When motion pictures recorded with this camera are played back on other equipment, the quality of pictures may be deteriorated or it may not be possible to play them back. Also the recording information may not be displayed correctly.
 - In motion picture mode [, you cannot use the direction detection function and the review function.
 - You cannot set [MODE2] on the Optical Image Stabilizer function.

6 Press [MENU/SET] to close the menu.

- You can also press the shutter button halfway to close the menu.



- The focus range is 5 cm (0.16 feet) to ∞ (Wide), 30 cm (0.98 feet) to ∞ (Tele).
- Refer to P106 for information about the available recording time.
- The remaining recordable time shown on the LCD may not reduce regularly.
- You cannot record audio.
- This camera cannot take motion pictures if you are using a MultiMediaCard.
- When [PICT.MODE] is set to [30fpsVGA] or [30fps16:9], we recommend you to use cards offering "10 MB/s" or higher speeds (printed on their packages and elsewhere) for best results.
- Depending on the type of SD Memory Card or SDHC Memory Card, recording may stop in the middle.
- **We recommend using Panasonic's SD Memory Card/SDHC Memory Card.**
- Depending on the type of card you are using, the card access indication may appear for a while after shooting motion pictures. This is normal.
- The volume of motion picture is limited to 2 GB per recording session. The maximum available recording time for up to 2 GB only is displayed on the screen.

Recording which day of the vacation you take the picture



By setting the departure and return dates, you can record which date of the vacation you take a picture. The day of the vacation is shown when you play a picture and you can add it to the picture for printing with [DATE STAMP] (P75).

- When you play back a picture, the date on which it was taken is displayed.

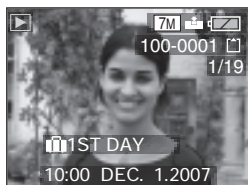

- The number of days that have passed since the departure date can be printed on each picture by using the software [LUMIX Simple Viewer] or [PHOTOfunSTUDIO-viewer-] in the CD-ROM (supplied). (For information about printing, refer to the separate operating instructions for PC connection.)

■ Setting the travel date

(Screen shows an example for the normal picture mode [📷])

- 1 Press [MENU/SET] and then press **◀**.
- 2 Press **▼** to select the [SETUP] menu icon [🔧] and then press **▶**.
- 3 Press **▲/▼** to select [TRAVEL DATE] and then press **▶**.

- 4 Press **▼** to select [SET] and then press [MENU/SET].

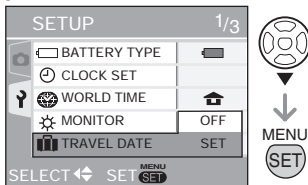

- 5 Press **▲/▼/◀/▶** to select the departure date and then press [MENU/SET].



- ◀/▶: Select the desired item.
- ▲/▼: Set the year, month and date.

- 6 Press **▲/▼/◀/▶** to set the return date and then press [MENU/SET].

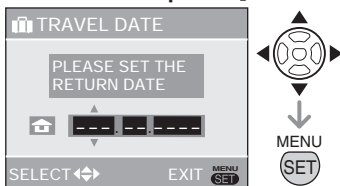

- ◀/▶: Select the desired item.
- ▲/▼: Set the year, month and date.
- The travel date is cleared if the current date is after the return date.
- If you have not set the return date, press [MENU/SET] while " - - - " is displayed.

- 7 Press [MENU/SET] to exit the menu.

8 Take a picture.

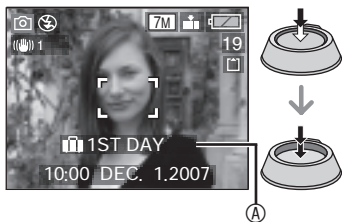

- The day of the vacation **A** appears for about 5 seconds after setting the travel dates and when the camera is turned on when the travel date is set.
- When [TRAVEL DATE] is set,  appears on the lower right of the screen. (It is not displayed if the current date is after the return date.)

■ Canceling the travel date

The travel date is cleared if the current date is after the return date. If you want to cancel part way through the setting, select [OFF] in step 4 and press [MENU/SET] twice.



- The travel date is calculated using the date in the clock setting (P17) and the departure date you set. If you set [WORLD TIME] (P57) to the travel destination, the travel date is calculated using the date in the clock setting and the travel destination setting.
- The travel date setting is memorized even if the camera is turned off.
- If you set a departure date and then take a picture on a date before this departure date, [-] (minus) is displayed in orange and the day of the vacation that you took the picture is not recorded.
- If you set a departure date and then change the clock setting to the date and time at the travel destination, [-] (minus) is displayed in white and the day of the vacation that you took the picture on is recorded when the travel destination date is, for example, one day before the departure date.
- If [TRAVEL DATE] is set to [OFF], the number of days that have passed since the departure date will not be recorded even if you set the travel date. Even if [TRAVEL DATE] is set to [SET] after taking the pictures, the day of the vacation you took them on is not displayed.
- Set the clock (P17) if the message "PLEASE SET THE CLOCK" appears.
- The travel dates are also used in the simple mode [].

Displaying the time at the travel destination



If you set your home area and the travel destination area when traveling abroad etc., the local time at the travel destination area can be displayed on the screen and recorded on the pictures taken.

- Select [CLOCK SET] to set the current date and time in advance. (P17)

1 Press [MENU/SET] and then press ◀.

2 Press ▼ to select the [SETUP] menu icon [⌂] and then press ▶.

3 Press ▲/▼ to select [WORLD TIME] and then press ▶.

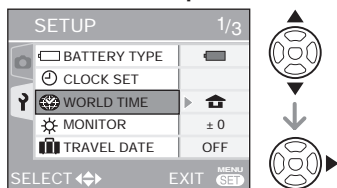

- If you are setting the world time for the first time, the message [PLEASE SET THE HOME AREA] appears. If this message appears, press [MENU/SET] and then set home area from the screen shown in step 2 in "Setting the home area [HOME]".

■ Setting the home area [HOME]

(Perform steps 1, 2 and 3.)

- 1 Press ▼ to select [HOME] and then press [MENU/SET].

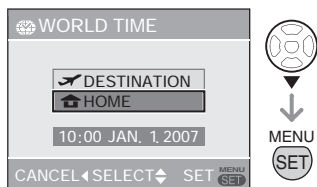

- 2 Press ◀▶ to select your home area and then press [MENU/SET].

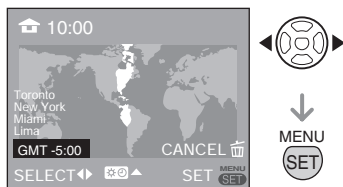

- The current time is displayed on the top left of the screen and the time difference from GMT (Greenwich Mean Time) is displayed on the bottom left of the screen.
- If daylight saving time [⚙️🕒] is used at the home area, press ▲. Press ▲ again to return to the original time.
- The daylight saving time setting for the home area does not advance the current time. Advance the clock setting by one hour. (P17)

Finishing setting the home area

- If you are setting the home area for the first time, the screen returns to the screen shown in step ① of “Setting the home area [HOME]” after you press [MENU/SET] to set your home area. Press ◀ to return to the screen shown in step 3 and then press [MENU/SET] to close the menu.
- If you are setting the home area for the second time etc., the screen returns to the screen shown in step 3 after you press [MENU/SET] to set your home area. Press [MENU/SET] again to close the menu.

■ Setting the travel destination area

(Perform steps 1, 2 and 3 on P57.)

- ① Press ▲ to select [DESTINATION] and then press [MENU/SET] to set.

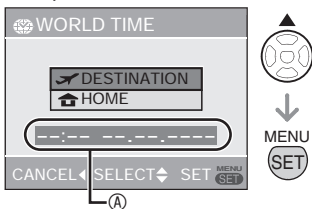

- ② Depending on the setting, the time at the travel destination area or the home area is displayed.
- If you are setting the travel destination area for the first time, the date and time are displayed as shown in the screen above.
- ② Press ◀▶ to select the area the travel destination is in and then press [MENU/SET] to set.

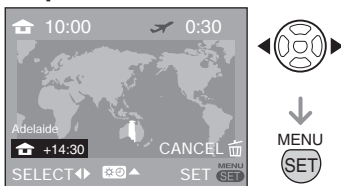

- The current time at the selected travel destination area is displayed on the top right of the screen and the time difference from the home area is displayed at the bottom left of the screen.
 - If daylight saving time [☀️] is used in your travel destination, press ▲. (The time advances by one hour.) Press ▲ again to return to the original time.
- ③ Press [MENU/SET] to close the menu.

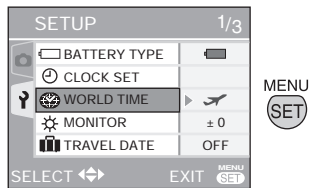

- The icon changes from [🏠] to [✈️] after setting the travel destination.



- Return the setting to [HOME] when the vacation is finished by performing steps 1, 2, 3 and then steps ① and ② of “Setting the home area [HOME]” (P57).
- If you cannot find the travel destination in the areas displayed on the screen, set by the time difference from the home area.
- The [WORLD TIME] setting also affects simple mode [♥️].
- Now when you play photographs taken while on holiday, the travel icon [✈️] appears.

Using the [REC] mode menu



Setting the hue, picture quality adjustment, etc. allows you to create wide variations on taking pictures. The menu items that can be set differ depending on the recording mode.

■ Using the [REC] mode menu

Press [MENU/SET] to show the recording menu, then select the item you want to change (P19).

Items you can set

(In normal picture mode [📷])

Menu page	Item
Page 1	[WB] W.BALANCE (P60)
	[ISO] SENSITIVITY (P61)
	[ASPECT RATIO] ASPECT RATIO (P62)
	[PICT.SIZE] PICT.SIZE (P62)
	[QUALITY] QUALITY (P62)
Page 2	[AF] AF MODE (P63)
	[STABILIZER] STABILIZER (P64)
	[BURST] BURST (P65)
	[AF*] AF ASSIST LAMP (P66)
	[D.ZOOM] D.ZOOM (P32)
Page 3	[COL.MODE] COL.MODE (P66)
	[CLOCK SET] CLOCK SET (P66)

■ Using the quick setting

You can use the [FUNC] button to easily set the following 6 items when recording (In normal picture mode [📷]).

- [STABILIZER]
- [BURST]
- [W.BALANCE]
- [SENSITIVITY]
- [PICT.SIZE]
- [QUALITY]

- 1 In shooting mode, press and hold [FUNC] until the quick setting items appear.



- 2 Press ▲/▼/◀▶ to select the menu item and setting and then press [MENU/SET] to close the menu.

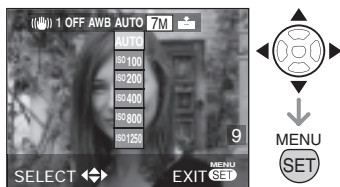

- You can also close the menu by pressing [FUNC].



- The [📷SET] (White Set) setting for white balance does not appear when using the quick setting.

Press [] to display the [REC] mode menu and select the item to set. (P19)







[W.BALANCE]



Adjusting the hue for a more natural picture



This function allows you to reproduce a white color closer to the tone in real life on the pictures recorded under sunlight, halogen lighting, etc. in which the white color may appear reddish or bluish. Select a setting that matches the recording conditions.

AWB	for auto setting (auto white balance)
 (Daylight)	for recording outdoors on a bright day
 (Cloudy)	for recording outdoors on a cloudy day
 (Shade)	for recording in shaded areas outdoors on a bright day
 (Halogen)	for recording under halogen lighting
 (White set)	for using the preset white balance
 (White set)	for using set mode with a different white balance setting

■ Auto White Balance (AWB)

Use of auto white balance adjustment in inappropriate lighting conditions may result in reddish or bluish pictures. Where the subject is surrounded by many light sources or there are no white or whitish objects in the frame, auto white balance adjustment may not operate properly. In this case, set the white balance to a mode except [AWB] manually.

- 1 The range that is controlled by the auto white balance adjustment mode of this camera
- 2 Blue sky
- 3 Cloudy sky (Rain)
- 4 Shade
- 5 TV screen
- 6 Sunlight
- 7 White fluorescent light
- 8 Incandescent light bulb
- 9 Sunrise and sunset
- 10 Candlelight

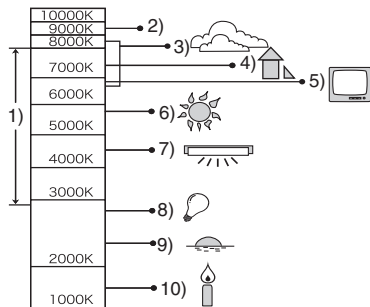

K=Kelvin Color Temperature

Press [MENU/SET] to display the [REC] mode menu and select the item to set. (P19)

■ Setting the white balance manually (White set [MENU/SET])

Use this to set the white balance manually.

- 1 Select [MENU/SET] (White set) and then press [MENU/SET].
- 2 Aim the camera at a sheet of white paper or a similar white object so that the frame on the center of the screen turns white and then press [MENU/SET].



- 3 Press [MENU/SET] twice to close the menu.

- You can also press the shutter button halfway to finish.



- The white balance may not be correct if the subject is out of flash range.
- The white balance you set is saved even if you switch the camera off, but if you change the scene mode, the white balance setting returns to [AWB].
- The white balance cannot be set in the following cases:
 - In simple mode [♥]
 - [SCENERY], [NIGHT SCENERY], [NIGHT PORTRAIT], [FOOD], [PARTY], [CANDLE LIGHT], [SUNSET], [FIREWORKS], [BEACH], [STARRY SKY], [SNOW], or [AERIAL PHOTO] in scene mode (P47)

[ISO] [SENSITIVITY] Setting the light sensitivity



ISO sensitivity represents the sensitivity of the image sensor to light. If you set the ISO sensitivity higher, the camera becomes more suitable for recording in dark places.

- When setting to [AUTO], the ISO sensitivity is automatically adjusted to a maximum of [ISO400] according to the brightness. (When using the flash, the adjustment range becomes a maximum of [ISO640].)

ISO sensitivity	100	←	→	1250
Use in bright places (e.g. outdoors)	Suitable			Not suitable
Use in dark places	Not suitable			Suitable
Shutter speed	Slow			Fast
Noise	Less			More



- The ISO sensitivity is fixed to [ISO3200] in [HIGH SENS.] (P51) in scene mode.
- To avoid picture noise we recommend reducing the ISO sensitivity or setting [COL.MODE] to [NATURAL]. (P66)
- If the camera is in Intelligent ISO mode (P45), the screen changes to the one for [ISO LIMIT].
- The ISO sensitivity cannot be set in the following cases:
 - In simple mode [♥]
 - In motion picture mode [H]
 - In scene mode

Press [MENU/SET] to display the [REC] mode menu and select the item to set. (P19)



[ASPECT RATIO]

Setting the aspect ratio of pictures

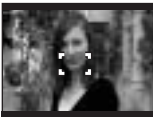
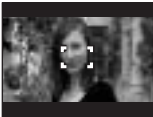

By changing the aspect ratio, you can select an angle of view that matches the subject.

<p>4:3</p>	<p>Select to take pictures with the same aspect ratio as a 4:3 TV or a computer monitor.</p> 
<p>3:2</p>	<p>Select to take pictures with the same 3:2 aspect ratio as 35 mm film.</p> 
<p>16:9</p>	<p>This is suitable for landscapes etc. where a wide view is preferable. This is also suitable for playing back pictures on a wide-screen TV, high-definition TV etc.</p> 



- You cannot choose [3:2] during motion picture mode [M] (P53).
- The ends of the recorded pictures may be cut at printing. (P102)



[PICT.SIZE]/[QUALITY]

Setting a picture size and quality that matches your use of the pictures



A digital picture is made of numerous dots called pixels. Although you cannot see the difference on the camera's screen, the more the pixels the finer the picture will be when it is printed on a large piece of paper or displayed on a computer monitor. Picture quality refers to the compression rate when saving digital pictures.

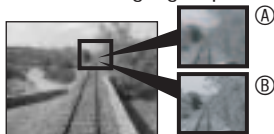

- Ⓐ Many pixels (Fine)
- Ⓑ Few pixels (Rough)

* These pictures are examples to show the effect.

■ Number of pixels

Select a higher number of pixels for clearer pictures when printing.



Select a lower number of pixels [0.3M] (0.3M EZ) to store more pictures. Fewer pixels also means it is easier to send pictures by e-mail or use them on a homepage.

■ When the aspect ratio setting is [4:3]



DMC-LS75/DMC-LS70 [7M] (7M)	3072 × 2304 pixels
DMC-LS60 only [6M] (6M)	2816 × 2112 pixels
DMC-LS75/DMC-LS70 [5M] (5M EZ)	2560 × 1920 pixels
[3M] (3M EZ)	2048 × 1536 pixels
[2M] (2M EZ)	1600 × 1200 pixels
[1M] (1M EZ)	1280 × 960 pixels
[0.3M] (0.3M EZ)	640 × 480 pixels

Press [] to display the [REC] mode menu and select the item to set. (P19)



■ When the aspect ratio setting is [3:2]

DMC-LS75/DMC-LS70  (6M)	3072 × 2048 pixels
DMC-LS60 only  (5M)	2816 × 1880 pixels
 (2.5M EZ)	2048 × 1360 pixels





■ When the aspect ratio setting is [16:9]







DMC-LS75/DMC-LS70  (5.5M)	3072 × 1728 pixels
DMC-LS60 only  (4.5M)	2816 × 1584 pixels
 (2M EZ)	1920 × 1080 pixels

■ Quality

	Fine (Low compression): This type gives priority to picture quality. Picture quality will be high.
	Standard (High compression): This type gives priority to the number of recordable pictures and records standard quality pictures.









- The number of pixels that can be selected differs depending on the aspect ratio. If you change the aspect ratio, set the picture size.
- [EZ] is an abbreviation of [Extended optical Zoom]. (P30)
- The extended optical zoom does not work in [HIGH SENS.] (P51) in scene mode so the picture size for [EZ] is not displayed.
- Pictures may have a mosaic-like appearance depending on the subject or the recording condition.
- Refer to P104 for the number of recordable pictures.
- In simple mode [], the settings become as follows.
 -  ENLARGE:
 /DMC-LS75/DMC-LS70:[] (7M), DMC-LS60:[] (6M)/Fine

-  4" × 6" / 10 × 15 cm:
 / [] (2.5M EZ)/Standard
-  E-MAIL:
 / [] (0.3M EZ)/Standard

[] **[AF MODE]**
Setting the focus method



Select the mode that matches the recording conditions and the composition.

	5-area-focusing: The camera focuses on any of 5 focus areas. This is effective when the subject is not in the center of the screen. 
	1-area-focusing (high speed): The camera quickly focuses on the subject in the AF area on the center of the screen. 
	1-area-focusing: The camera focuses on the subject in AF area on the center of the screen. 

Press [MENU/SET] to display the [REC] mode menu and select the item to set. (P19)

■ About 1-area-focusing (High speed)

- You can focus on the subject more quickly than other AF modes.
- Pictures may become still in the condition they were in before the subject was focused when you press the shutter button halfway. However, it is not a malfunction.



- When using the digital zoom or when you take pictures in dark places, the AF area is displayed on the center of the screen with a size wider than usual.



- When multiple AF areas (max. 5 areas) light at the same time, the camera is focusing on all the AF areas. The focus position is not predetermined because it is set to the position the camera automatically determines at the time of focusing. If you want to determine the focus position to take pictures, switch the AF mode to 1-area-focusing or 1-area-focusing (high speed) mode.
- In 5-area focusing mode, AF areas are not displayed until the camera focused on a subject.
- The AF mode cannot be set in simple mode [♥] or [FIREWORKS] in scene mode.

[STABILIZER]



This feature detects jitter and corrects for it



MODE1 ([HAND] 1)	The stabilizer operates continuously and can assist during photo composition.
MODE2 ([HAND] 2)	The jitter is compensated for when the shutter button is pressed. There is a greater stabilizing effect.
OFF ([HAND] OFF)	When image stabilization is not desired.

■ About demonstration of jitter/movement detection screen

Press ► to display [JITTER, SUBJ. MOVE DEMO.] when the [STABILIZER] screen is displayed. You cannot shoot while the demonstration is on. Press ► again to stop the demonstration.

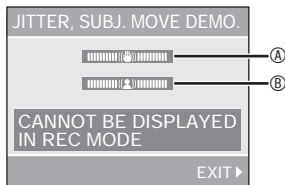



Ⓐ Jitter indicator

Ⓑ Movement indicator

- The camera automatically detects jittering and movement of the subject and indicates them.
- The demonstrations are examples only.
- The automatic ISO sensitivity setting using movement detection only works in Intelligent ISO mode and the [SPORTS], [BABY], and [PET] scene modes (P47).



Press [] to display the [REC] mode menu and select the item to set. (P19)



- The stabilizer function may not work in the following cases so take special care not to move the camera when pressing the shutter button.
 - When too much jitter occurs.
 - When the zoom magnification is high.
 - In digital zoom range.
 - When taking pictures while following subjects in motion.
 - When the shutter speed is extremely slow due to dark conditions or other reasons.
- In simple mode [], the setting is fixed to [MODE2] and in [STARRY SKY] (P51) in scene mode it is fixed to [OFF].
- In motion picture mode [], [MODE2] cannot be set.

[BURST] Shooting in quick succession



- Turn this mode [ON] and when you press and hold the shutter button several pictures are taken in succession.
- 
- **The burst speed will become slower halfway.** When it slows down depends on the type of card, picture size, and quality.
 - You can take pictures until the capacity of the built-in memory or the card is full.
 - Burst speed slows when ISO sensitivity (P45, 61) is higher than [ISO400].
 - Shutter speed decreases in dark places, so burst speed may also be slower.
 - The focus is fixed in the first picture.
 - The camera sets the exposure and white balance for each picture in the series.
 - When panning across areas with a large difference in brightness, the camera takes some time to get the right exposure. This means that the exposure may not be correct when taking pictures in succession.
 - When the self-timer is used, the number of recordable pictures in burst mode is fixed to 3.
 - Burst mode is not canceled when the camera is switched off.
 - In Burst mode, auto review is activated even if the setting is off. You cannot change the auto review setting in the setup menu.
 - You can only take one photograph at a time when using the flash.
 - You cannot take photographs in succession when the camera is in simple mode [] or [STARRY SKY] in scene mode.

Press [MENU/SET] to display the [REC] mode menu and select the item to set. (P19)

[AF ASSIST LAMP]

AF* *Focusing in low light conditions becomes easier*



Illuminating the subject with the AF assist lamp allows the camera to focus on the subject in low light conditions.

If the AF assist lamp is set to [ON], an AF area (P63) with a size wider than usual is displayed and the AF assist lamp **A** turns on.

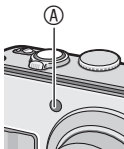

ON	The AF assist lamp turns on under low light conditions. In this time, the AF assist lamp icon [AF*] appears on the screen. The effective range of the AF assist lamp is 1.5 m (4.92 feet).
OFF	The AF assist lamp does not turn on.



- Be sure of the following points when the AF assist lamp is in use.
 - Do not look into the AF assist lamp closely.
 - Do not cover the AF assist lamp with your fingers or other objects.
- When you do not want to use the AF assist lamp (e.g. when you take a picture of animals in a dark place), set the [AF ASSIST LAMP] to [OFF]. In this case, it becomes difficult to focus on the subject.
- The AF assist lamp is fixed to [ON] while the camera is in simple mode [♥].
- You cannot use the AF assist lamp in [SCENERY], [NIGHT SCENERY], [SUNSET], [FIREWORKS] and [AERIAL PHOTO] in scene mode. (P47)
- The AF assist lamp is changed to [OFF] in [PET] (P50) in scene mode.

[COL.MODE]

Setting color effects for the recorded pictures



You can use following types of color effects depending on the image of the picture.

NATURAL	Shoot softer pictures.
VIVID	Shoot more vivid pictures.
B/W	The picture becomes black and white.
SEPIA	The picture becomes sepia.



- Picture noises might stand out when taking a picture in a dark place. To avoid picture noises we recommend setting [COL.MODE] to [NATURAL].

[CLOCK SET]

Setting the date, time and display



Set the clock when you change the date or time (P17).

Displaying Multiple Screens (Multi Playback)



1 Rotate the zoom lever towards [W] to display multiple screens.



For example: When you have chosen to show 9 pictures

- [W]: 1 screen → 9 screens → 25 screens → Calendar screen display (P68)
- Rotate the zoom lever towards [Q] [T] to return to the previous screen.

2 Press ▲/▼/◀/▶ to select a picture.

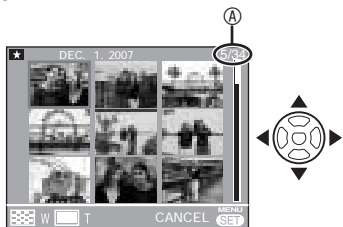

Ⓐ: Number of the selected picture and the total number of recorded pictures

- Depending on the recorded picture and the setting, the following icons will appear.
 - [★] (Favorites)
 - [📅] (Motion picture)
 - [👶] ([BABY1]/[BABY2] in scene mode)
 - [🐕] ([PET] in scene mode)
 - [📅] (Travel date)
 - [✈️] (Travel destination)
 - [📅] (Date stamp complete)

■ Example of 25 screens

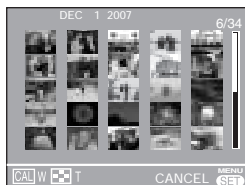

■ To return to the normal playback

Rotate the zoom lever towards [Q] [T], or press [MENU/SET].

- The image you select is shown.

■ To delete a picture during a multi playback

- 1 Press ▲/▼/◀/▶ to select a picture and then press [🗑️].
- 2 Press ▲ to select [YES].
- 3 Press [MENU/SET].



- During multi playback, you cannot clear the shooting information from the display by pressing [DISPLAY].
- Pictures will not be displayed in the rotated direction even if [ROTATE DISP.] is set to [ON] (P74).

Displaying pictures by recording date (Calendar playback)



You can display pictures by recording date using the calendar playback function.

1 Rotate the zoom lever towards [] [W] several times to display the calendar screen.



- The recording date of the picture selected in the playback screen becomes the date selected when the calendar screen is first displayed.
- If there are multiple pictures with the same recording date, the first picture recorded on that day is displayed.

2 Press ▲/▼/◀/▶ to select the date to be played back.

▲/▼: Select the month

◀/▶: Select the date

- If there were no pictures recorded during a month, the month is not displayed.

3 Press [MENU/SET] to display the pictures that were recorded on the selected date.



- Rotate the zoom lever towards [] [W] to return to the calendar screen.

4 Press ▲/▼/◀/▶ to select a picture and then press [MENU/SET].

- The selected picture is displayed on the 1 screen playback screen.

■ To return to the 1 screen playback screen

After the calendar screen is displayed, rotate the zoom lever towards [Q] [T] to display 25 screens, 9 screens and 1 screen. (P67)



- The pictures are displayed without being rotated even if you set [ROTATE DISP.] to [ON]. (P74)
- You can display the calendar between January 2000 and December 2099.
- If the recording date of the picture selected in 25 screens multi playback is not between January 2000 and December 2099, the camera automatically displays it in the oldest calendar date.
- Pictures edited on a PC or processed on other equipment may be displayed with dates different from the actual recording dates.
- If the date is not set in the camera (P17), the recording date is set as January 1st, 2007.
- If you take pictures after setting the travel destination in [WORLD TIME] (P57), the pictures are displayed by the dates at the travel destination in calendar playback.

Using the Playback Zoom



1 Rotate the zoom lever towards [Q] [T] to enlarge the picture.



- **Q**: 1x→2x→4x→8x→16x
- When you rotate the zoom lever towards [W] after enlarging the picture, the magnification becomes lower. When you rotate the zoom lever towards [Q] [T], the magnification becomes higher.
- When you change the magnification, the zoom position indication **A** appears for about 1 second to check the position of the section enlarged.

2 Press ▲/▼/◀/▶ to move the position.



- When you move the position to be displayed, the zoom position indication is displayed for about 1 second.

■ To stop using the playback zoom

Rotate the zoom lever towards [W] or press [MENU/SET].

■ To delete a picture during the playback zoom

- 1 Press [DELETE].
- 2 Press ▲ to select [YES].
- 3 Press [MENU/SET].





- During playback zoom, you can clear the shooting information from the display by pressing [DISPLAY].
- The more the picture is enlarged, the more its quality deteriorates.
- If you want to save the enlarged picture, use the trimming function. (P81)
- The playback zoom may not operate if pictures have been recorded with other equipment.

Playing Back Motion pictures

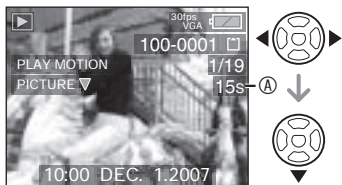

Press **◀▶** to select a picture with a motion picture icon [**30fps_VGA**] / [**10fps_VGA**] / [**30fps_QVGA**] / [**10fps_QVGA**] / [**30fps_16:9**] / [**10fps_16:9**] and then press **▼** to play back.



- The motion picture recording time **(A)** is displayed on the LCD monitor. After playback starts, the elapsed playback time is displayed on the bottom right of the LCD monitor. For example, 1 hour 20 minutes and 30 seconds is displayed as [1h20m30s].
- The cursor displayed during playback corresponds to **▲/▼/◀/▶** 

To stop motion picture playback
Press **▼**.

Fast forwarding/Fast rewinding
During motion picture playback, keep pressing **◀▶**.

▶: Fast forward

◀: Fast rewind

- When releasing the button, it turns to normal motion picture playback.

To pause

Press **▲** during motion picture playback.

- Press **▲** again to cancel pause.

Frame-by-frame forward/reverse viewing

Press **◀▶** during pause.



- The file format that can be played back with this camera is QuickTime Motion JPEG.
- Please note that the bundled software includes QuickTime to play back motion picture files created with the camera on the PC (P84).
- Some QuickTime Motion JPEG files recorded by a PC or other equipment may not be played back with this camera.
- When playing back motion pictures that have been recorded with other equipment, the quality of pictures may be deteriorated or it may not be possible to play them back.
- You cannot play back the audio of motion pictures with audio recorded on other equipment.
- When using a high capacity card, it is possible that fast rewinding may be slower than usual.
- You cannot use the following functions with motion pictures.
 - Playback zoom (While playing back or pausing motion pictures)
 - [ROTATE DISP.]/[ROTATE]
 - [DATE STAMP]
 - [RESIZE]/[TRIMMING]

Using the [PLAY] mode menu



You can use various functions in playback mode to rotate pictures, set protection for them etc.

- Refer to P72 to 83 for each menu item.

1 Press [MENU/SET].

2 Press ▲/▼ to select the menu item and then press ►.

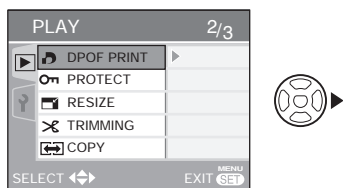
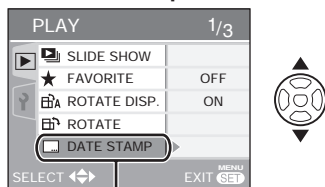

- Press ▼ at ① to switch to the next menu screen.
- You can switch menu screens from any menu item by rotating the zoom lever.
- After selecting a menu item in step 2, refer to the description of the menu item in the operating instructions and then set it.

Items you can set

Menu Page	Item
Page 1	SLIDE SHOW (P72)
	FAVORITE (P73)
	ROTATE DISP. (P74)
	ROTATE (P74)
	DATE STAMP (P75)
Page 2	DPOF PRINT (P77)
	PROTECT (P79)
	RESIZE (P80)
	TRIMMING (P81)
	COPY (P82)
Page 3	FORMAT (P83)

Press [MENU/SET] to display the [PLAY] mode menu and select the item to set. (P71)

[SLIDE SHOW]
Playing back pictures in order
for a fixed duration

This is recommended when playing back pictures on a TV screen. You can skip unwanted pictures if [FAVORITE] (P73) has been set.

- The screen shown in step 1 appears when [FAVORITE] is set to [ON]. When [FAVORITE] is set to [OFF], perform step 2 onwards.

1 Press ▲/▼ to select [ALL] or [★] and then press [MENU/SET].

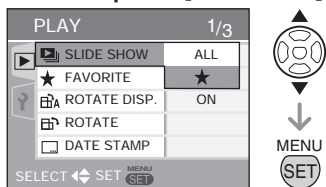

ALL	For playing back all pictures
★	For showing pictures in your favorites list (P73)

- If none of the pictures have [★] displayed, you cannot select [★] even if [FAVORITE] is set to [ON].

2 Press ▲ to select [START] and then press [MENU/SET].

(Screen when [ALL] is selected)

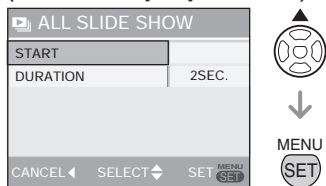

- The cursor displayed during a slide show **A** or while a slide show is paused **B** or during [MANUAL] slide show **C** is the same as ▲/▼/◀/▶.
- Press ▲ to pause the slide show. Press ▲ again to cancel pause.
- Press ◀/▶ while paused to display the previous or next picture.

3 By pressing the ▼, the Slide Show stops.

■ About playback duration

Select [DURATION] for setting on the screen displayed in step 2.

DURATION	Select intervals of 1, 2, 3, 5 seconds or MANUAL.
----------	---

- You can select [MANUAL] if you have selected [★] in step 1.
- Press ◀/▶ to display the previous or next picture when [MANUAL] is selected.



- You cannot play back motion pictures and use power save in a slide show. (However, the setting for power save mode is fixed to [10MIN.] while pausing a slide show or playing back a manual slide show.)

Press [MENU/SET] to display the [PLAY] mode menu and select the item to set. (P71)



[FAVORITE]

Setting your favorite pictures

You can do the following if a mark has been added to pictures and they have been set as favorites.

- Delete all the pictures not set as favorites. ([ALL DELETE EXCEPT ★]) (P35)
- Play back the pictures set as favorites only as a slide show. (P72)
- Print only the pictures set as favorites. (P88)

1 Press ▼ to select [ON] and then press [MENU/SET].

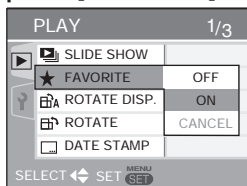

- You cannot set pictures as favorites if [FAVORITE] is set to [OFF]. Also the favorites icon [★] will not appear when [FAVORITE] is set to [OFF] even if it was previously set to [ON].
- You cannot select [CANCEL] if none of the pictures have [★] displayed.

2 Press [MENU/SET] to close the menu.

3 Press ◀▶ to select the picture then press ▲.

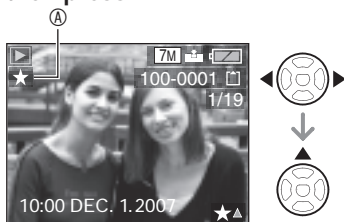

- Repeat the above procedure.
- If ▲ is pressed while the [★] favorites icon ⓐ is displayed, [★] is cleared, and the favorites setting is canceled.
- You can place up to 999 pictures in your favorites list.

■ Canceling all favorites

- 1 Select [CANCEL] on the screen shown in step 1 and then press [MENU/SET].
- 2 Press ▲ to select [YES] and then press [MENU/SET].
- 3 Press [MENU/SET] to close the menu.



- When printing pictures at a photo printing store, [ALL DELETE EXCEPT ★] (P35) is useful so only the pictures you want to be printed remain on the card.
- Use [LUMIX Simple Viewer] or [PHOTOfunSTUDIO-viewer-] (on the included CD-ROM) to change settings, check, or erase your pictures in your favorites list. (For details, refer to the separate operating instructions for PC connection.)
- You may not be able to put pictures you have shot on other equipment into your favorites list.

Press [MENU/SET] to display the [PLAY] mode menu and select the item to set. (P71)



This mode allows you to automatically display pictures vertically if they were recorded holding the camera vertically or rotate pictures manually in 90° steps.

■ Rotate display

(The picture is automatically rotated and displayed.)

1 Press ▼ to select [ON] and then press [MENU/SET].

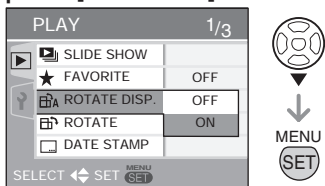

- When you select [OFF], the pictures are displayed without being rotated.
- Refer to P34 for how to play back pictures.

2 Press [MENU/SET] to close the menu.

■ Rotate

(The picture is rotated manually.)

1 Press ◀/▶ to select the picture and then press ▼.



- When [ROTATE DISP.] is set to [OFF], [ROTATE] function is disabled.
- Motion pictures and protected pictures cannot be rotated.

2 Press ▲/▼ to select the direction to rotate the picture and then press [MENU/SET].



	The picture rotates clockwise in steps of 90°.
	The picture rotates counter-clockwise in steps of 90°.

3 Press [MENU/SET] twice to close the menu.



- If you take pictures when aiming the camera up or down, it may not be possible to display the pictures vertically. (P27)
- The picture may be slightly blurred when the camera is connected to the TV with the video cable (supplied) and played back vertically.
- When you play the picture on a PC, you cannot play rotated pictures without an OS or a software compatible with Exif. Exif is the file format for still pictures, to which recording information and other can be added, established by JEITA [Japan Electronics and Information Technology Industries Association].
- When playing back rotated pictures in multi playback, pictures appear in original orientation.
- You may not be able to rotate images shot on other equipment.

Press [MENU/SET] to display the [PLAY] mode menu and select the item to set. (P71)



You can stamp your pictures with the date of shooting, ages, and travel dates. This function is suitable when you print 4" x 6"/10 x 15 cm images. (Images are resized when you add the date to the pictures taken with a resolution of more than [3M].)

1 Press ▲/▼ to select [SINGLE] or [MULTI] and press [MENU/SET].

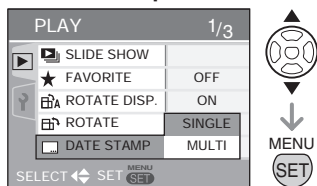

- You cannot add the date to the following images.
 - Images taken when the clock is not set
 - Images taken on other cameras
 - Images that already have a date on them
 - Motion Pictures

2 Press ◀/▶ to choose a picture, then press ▼.

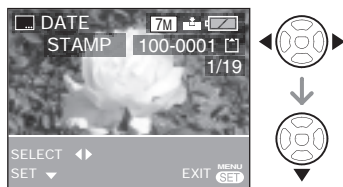

- When you have selected [SINGLE] in step 1, proceed to step 3.
- When you have selected [MULTI] in step 1, repeat step 2 for each picture, press [MENU/SET], then proceed to step 3.

3 Press ▲/▼/◀/▶ to select [SHOOTING DATE], [AGE], or [TRAVEL DATE] and change the settings for the item, and then press [MENU/SET].

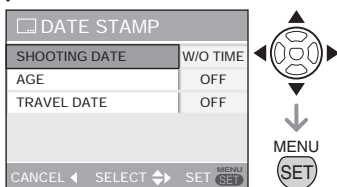

■ SHOOTING DATE

W/O TIME	Date is added
WITH TIME	Date and time are added

■ AGE (P50)

OFF	Age not added
ON	Age added

■ TRAVEL DATE (P55)

OFF	Travel dates not added
ON	Travel dates added

4 Press [MENU/SET].

- Images are resized as follows when you add the date to the pictures taken with a resolution of more than [3M].
 - 4:3 aspect ratio → 3M
 - 3:2 aspect ratio → 2.5M
 - 16:9 aspect ratio → 2M

5 Press ▲/▼ to select [YES] or [NO] and press [MENU/SET].

(Screen when you have chosen an image taken at [7M])

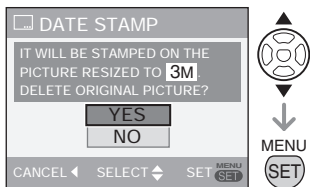

- The message [DELETE ORIGINAL PICTURE?] appears when the picture is taken with a resolution of [3M] or less.
- The image is replaced if you select [YES]. The original image is overwritten with the resized image that has the date added.
- Select [NO] to save a new picture with the date.
- You cannot save over the original picture if it is protected. Select [NO] to save a new picture with the date.

6 Press [MENU/SET] twice to close the menu.

- Pictures that have been date stamped will be marked with the date stamp complete indicator (A).
- To confirm the date stamp (B), use playback zoom (P69).



- Note that if you use date stamp and then specify printing the date when you order prints or on a printer, both dates will be printed and may overlap.**
- Make sure there is some space available on the built-in memory or card.
- It is possible to set up to 50 pictures at one time using [MULTI].
- If protected pictures are included when you use [MULTI], a message appears when you select [YES] in step 5 and the date stamp will not be imprinted on the protected pictures.
- The date may be cut off with some printers.
- Once you have added the date, you will no longer be able to use the following functions with the pictures.
 - [DATE STAMP]
 - Date print setting in [DPOF PRINT]
 - [RESIZE]
 - [TRIMMING]

Press [MENU/SET] to display the [PLAY] mode menu and select the item to set. (P71)

[DPOF PRINT]



Setting the Picture to be Printed and the Number of Prints

DPOF (Digital Print Order Format) is a system that allows the user to select which pictures to print, how many copies of each picture to print and whether or not to print the recording date on the pictures when using a DPOF compatible photo printer or photo printing store. For details, ask at your photo printing store.

When you want to use a photo printing store to print pictures recorded on the built-in memory, copy them to a card (P82) and then set the DPOF setting.

For more information please visit:

http://panasonic.jp/dc/dpof_110/white_e.htm

Press ▲/▼ to select [SINGLE], [MULTI] or [CANCEL] and then press [MENU/SET].

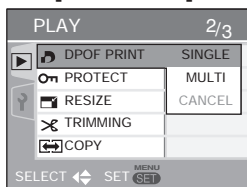

- You cannot select [CANCEL] if there are no prints that have been set in the DPOF print settings.

■ Single setting

1 Press ◀▶ to select the picture to print and then press ▲/▼ to set the number of prints.



- The number of prints icon [D] appears.
- The number of prints can be set from 0 to 999. When the number of prints is set to "0", DPOF print setting is canceled.

2 Press [MENU/SET] twice to close the menu.

■ Multi setting

1 Press ◀▶ to select the picture to print and then press ▲/▼ to set the number of prints.

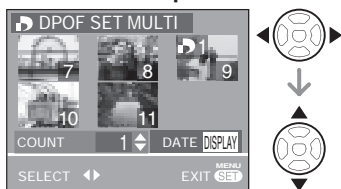

- Repeat the above procedure. (You cannot set all the pictures at one time.)
- The number of prints icon [D] appears.
- The number of prints can be set from 0 to 999. When the number of prints is set to "0", DPOF print setting is canceled.

2 Press [MENU/SET] twice to close the menu.

■ To cancel all settings

1 Press **▲** to select **[YES]** and then press **[MENU/SET]**.

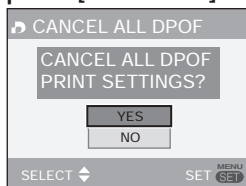

2 Press **[MENU/SET]** to close the menu.

- DPOF print settings on the built-in memory are canceled when a card is not inserted. DPOF print settings on the card are canceled when a card is inserted.

■ To print the date

You can set/cancel the printing with the recorded date each press of the **[DISPLAY]** button when setting the number of prints.

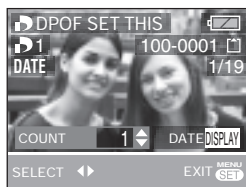

- The date print icon **[DATE]** appears.
- When you go to a photo studio for digital printing, be sure to order the printing of the date additionally if required.
- The date may not be printed depending on photo studios or printers even if you set the date print. For further information, ask the photo studio for details or refer to the operating instructions of the printer.
- This function is not available for images imprinted with the date stamp.
- This function is canceled if you imprint the date stamp on the picture.



- DPOF is an abbreviation of [Digital Print Order Format]. This feature allows you to write print information to media and then use the information on a DPOF-compliant system.
- DPOF print setting is a convenient function when you print pictures with printers supporting PictBridge. The date printing setting on the printer may take priority over the date printing setting on the camera. Check the date printing setting on the printer also. (P87)
- When setting the DPOF print, delete any previous DPOF print settings made by other equipment.
- If the file is not based on the DCF standard (P34), the DPOF print setting cannot be set.

Press [MENU/SET] to display the [PLAY] mode menu and select the item to set. (P71)

[PROTECT] Preventing Accidental Erasure of the Picture

You can set protection for the pictures you do not want to delete to prevent them from accidental erasure.

Press ▲/▼ to select [SINGLE], [MULTI] or [CANCEL] and then press [MENU/SET].

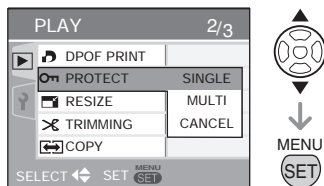

■ Single setting

1 Press ◀▶ to select the picture and then press ▼ to set/cancel.



SET	The protect icon [On] appears.
CANCEL	The protect icon [On] disappears.

2 Press [MENU/SET] twice to close the menu.

■ Multi setting/To cancel all settings

Perform the same operation as in [[DPOF PRINT] Setting the Picture to be Printed and the Number of Prints]. (P77 and 78)



- The protect setting may not be effective in other equipment.
- If you want to delete protected pictures, cancel the protect setting first.
- While this feature protects the pictures from accidental erasure, formatting the card will permanently delete all data. (P83)
- Sliding the Write-Protect switch Ⓐ of the SD Memory Card or the SDHC Memory Card to [LOCK] prevents pictures from deletion even if protection is not set.

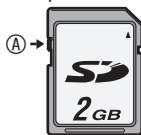

- The following functions cannot be used with protected pictures.
 - [ROTATE]

Press [MENU/SET] to display the [PLAY] mode menu and select the item to set. (P71)

[RESIZE] Making the picture smaller

This function is useful if you want to reduce the file size of the picture in cases when it needs to be attached to an e-mail or uploaded to a website.

1 Press to select the picture and then press .



- The following pictures cannot be resized.

Aspect ratio	Picture size
4:3	0.3M
3:2	2.5M
16:9	2M

- Motion pictures
- Pictures imprinted with the date stamp

2 Press to select the size and then press .



- Sizes smaller than the recorded picture are displayed.
- The message [DELETE ORIGINAL PICTURE?] appears.

3 Press to select [YES] or [NO] and then press [MENU/SET].

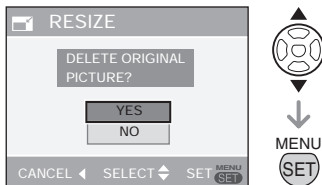

- When you select [YES], the picture is overwritten. When resized pictures are overwritten, they cannot be restored.
- When you select [NO], a resized picture is newly created.
- When the original picture is protected, you cannot overwrite the resized picture. Select [NO] and newly create a resized picture.

4 Press [MENU/SET] twice to close the menu.



- You may not be able to resize pictures you have shot on other equipment.

Press [MENU/SET] to display the [PLAY] mode menu and select the item to set. (P71)



[TRIMMING]

Enlarging a picture and trimming it

Use this function when you trim unnecessary parts of the recorded picture.

1 Press [LEFT]/[RIGHT] to select the picture and then press [DOWN].

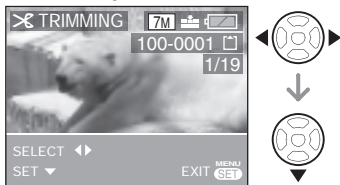

- The following pictures cannot be trimmed.
 - Motion pictures
 - Pictures imprinted with the date stamp

2 Enlarge or decrease the parts to be trimmed with the zoom lever.

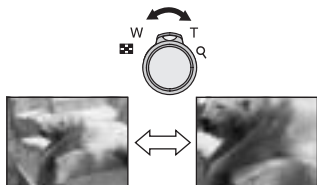

3 Press [UP]/[DOWN]/[LEFT]/[RIGHT] to move the position of the part to be trimmed.

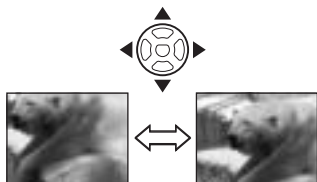

4 Press the shutter button.

- The message [DELETE ORIGINAL PICTURE?] appears.

5 Press [UP]/[DOWN] to select [YES] or [NO] and then press [MENU/SET].

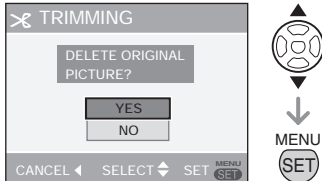

- When you select [YES], the picture is overwritten. When trimmed pictures are overwritten, they cannot be restored.
- When you select [NO], a trimmed picture is newly created.
- When the original picture is protected, you cannot overwrite the trimmed picture. Select [NO] and newly create a trimmed picture.

6 Press [MENU/SET] twice to close the menu.



- If you trim a picture, the number of pixels may be fewer in the trimmed picture than in the original.
- The picture quality of the trimmed picture may be deteriorated.
- It may not be possible to trim pictures recorded with other equipment.

Press [MENU/SET] to display the [PLAY] mode menu and select the item to set. (P71)



[COPY]

Copying the picture data

You can copy recorded picture data from the built-in memory to a card or vice versa.

1 Press ▲/▼ to select the copy destination and then press [MENU/SET].

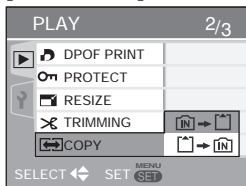

• [IN] → []:

All the picture data in the built-in memory are copied onto the card at one time. (Perform step 3)

• [] → [IN]:

One picture at a time is copied from the card to the built-in memory. (Perform step 2)

2 Press ◀/▶ to select the picture and then press ▼. (Only when [] → [IN] is selected)

3 Press ▲ to select [YES] and then press [MENU/SET].

(The illustration shows the screen when pictures are copied from the built-in memory to a card.)

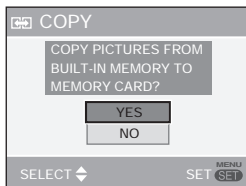

- The message [COPY THIS PICTURE TO BUILT-IN MEMORY?] appears when you copy picture from the card to the built-in memory.
- If you press [MENU/SET] while copying pictures from the built-in memory to the card, the copying will stop halfway.
- Do not turn the camera off or do any other operations before copying is finished. The data on the built-in memory or the card may be damaged or lost.

4 Press [MENU/SET] several times to close the menu.

- If you copy picture data from the built-in memory to a card, the screen automatically returns to the playback screen when all the pictures are copied.



- If you copy picture data from the built-in memory to a card which does not have sufficient free space, the picture data will only be copied halfway. We recommend using a card which has more free space than the built-in memory (about 27 MB).
- You cannot copy an image file if there is already a file in the destination that has the same name (same file and folder numbers).
- It may take time to copy the picture data.
- Only pictures recorded with a Panasonic digital camera (LUMIX) will be copied. (Even if the pictures were recorded with a Panasonic digital camera, you may not be able to copy them if they were edited with a PC.)
- DPOF settings on the original picture data will not be copied. Set the DPOF settings again after copying is finished. (P77)

Press [] to display the [PLAY] mode menu and select the item to set. (P71)

[FORMAT]
*Initializing the built-in memory
 or a card*

Usually, it is not necessary to format the built-in memory and the card. Format them when the message [BUILT-IN MEMORY ERROR] or [MEMORY CARD ERROR] appears.

Press **▲** to select [YES] and then press [MENU/SET].

(The illustration shows the screen when the built-in memory is formatted.)

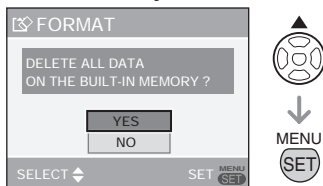

- When a card is not inserted, you can format the built-in memory. When a card is inserted, you can format the card.
- If you press [MENU/SET] while formatting the built-in memory, the formatting will stop halfway. (However, all the pictures will be deleted.)



- Once the card is formatted, all data including protected images are irretrievably erased. Please confirm that all data is transferred to your PC before proceeding with format function.
- If the card has been formatted on a PC or other equipment, format it on the camera again.
- Use batteries with sufficient power (P24) or the AC adaptor (DMW-AC6; optional) when formatting.
- During formatting, do not turn the camera off.
- It may take longer to format the built-in memory than the card. (Max. about 15 sec.)

- Sliding the Write-Protect switch of the SD Memory Card or the SDHC Memory Card to [LOCK] prevents formatting. (P16)
- If the built-in memory or the card cannot be formatted, consult your nearest Service Center.

For USA assistance, please call: 1-800-272-7033 or send e-mail to : digitalstillcam@us.panasonic.com

For Canadian assistance, please call: 1-800-99-LUMIX (1-800-995-8649) or send e-mail to: lumixconcierge@ca.panasonic.com

Connecting to a PC



- By connecting the camera to a computer, you can upload your pictures, then use the software on the included CD-ROM ([LUMIX Simple Viewer] and [PHOTOfunSTUDIO-viewer-] for Windows®) to print or send your images by e-mail.
- **If you use Windows 98/98SE, install the USB driver and then connect the camera to the computer.**
- For details about installing [LUMIX Simple Viewer] or [PHOTOfunSTUDIO-viewer-] etc., refer to the separate operating instructions for PC connection.

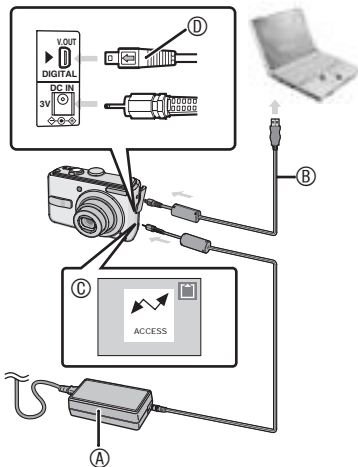

- Ⓐ : AC adaptor (DMW-AC6; optional)
- Use batteries with sufficient battery power (P24) or the AC adaptor (DMW-AC6; optional).
 - Make sure this unit is off before connecting or disconnecting the AC adaptor (DMW-AC6; optional).
- Ⓑ : USB connection cable (supplied)
- Ⓒ : This message appears during data transfer.
- Ⓓ : Check the facing of the connector and push straight in.

- Set the camera's mode dial to a mode other than Print mode [🖨️].

1 Turn on the camera and the PC.

2 Connect the camera to a PC via the USB connection cable ⑥ (supplied).

- Connect the USB connection cable with the [←] mark facing the [→] mark on the [DIGITAL] socket.
- Hold ⑥ and then insert or pull the USB connection cable straight. Do not try to force the connector in backwards or sideways. This can damage this unit and the equipment you are connecting.

[Windows]

The drive appears on the [My Computer] folder.

- If it is the first time you are connecting the camera to a PC, the required driver is installed automatically so that the camera can be recognized by the Windows Plug and Play, then it appears on the [My Computer] folder.

[Macintosh]

The drive is displayed on the screen.

- The drive is displayed as [LUMIX] when you connect the camera with no card inserted.
- The drive is displayed as [NO NAME] or [Untitled] when you connect the camera with a card inserted.

■ Motion picture playback on a PC

Use "QuickTime" (for Windows 2000/XP) in the supplied CD-ROM when you play back motion pictures recorded on this camera on your PC.

- Download [QuickTime6.5.2 for PC] from the following website and install it on your PC when you use Windows98/98SE/Me. <http://www.apple.com/support/quicktime/>
- The software is a standard Macintosh feature.

■ Folder Composition

Folders appear as follows.

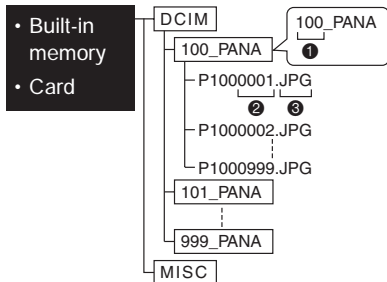

- ❶ Folder number
- ❷ File number
- ❸ JPG : Pictures
MOV : Motion pictures

MISC : Folder containing files with DPOF settings.

- This unit stores up to 999 picture files in each folder. A new folder is created after this maximum is reached.
- To reset file and folder numbers, use [NO.RESET] in the setup menu. (P22)

■ Conditions under which a different folder number is used

In the following cases, the picture is not recorded in the same folder as the previously recorded picture. It is recorded in a folder with a new number.



- The folder containing the picture you just shot had a file numbered 999 in it (example: P1000999.JPG).
- When the card just recorded to contains, for example, a folder with the number 100 (100_PANA) in it and that card is removed and replaced with a card that has a folder with the number 100 in it recorded by a camera from a different maker (100XXXXX, with XXXXX being the name of the maker) and then a picture is recorded.
- You start shooting again after using [NO.RESET] in the setup menu (P22). (It is recorded to a new folder that has a number following on from the one previous. You can also reset the folder number to 100 by using [NO.RESET] immediately after formatting the card when there are no folders or pictures on the card.)

■ Connection in the PTP mode

Windows XP/Mac OS X users can establish connection in the PTP mode by setting the camera in print mode [] and connecting it to their PC.

- You can only load pictures from the camera and cannot write them on the card or delete them.
- When there are 1000 or more pictures on a card, the pictures may not be imported.



- Do not use any other USB connection cables except the supplied one.
- While [ACCESS] is being displayed, do not disconnect the USB connection cable.
- Data transmission takes time when a card contains a large number of pictures.
- Motion image files in the built-in memory or on a card in this unit may not play properly on a computer, so upload them to your computer for playback.
- If the remaining battery power is exhausted during communication, the recorded data may be damaged. When you connect the camera to the PC, use a battery with sufficient battery power (P24) or the AC adaptor (DMW-AC6; optional).
- If the remaining battery power becomes low while the camera and the PC are communicating, the status indicator blinks and the alarm beeps. In this case, stop the communication at once on the PC.
- **When connecting the camera to a Windows 2000 OS PC with the USB connection cable, do not replace the card while the camera and the PC are connected. The information on the card may be damaged. Before changing cards, make sure you do the necessary steps to safely remove hardware (double-click the icon in the task bar in Windows).**
- Pictures edited or rotated with a PC may be displayed in black in playback mode (P34), multi playback (P67) and calendar playback (P68).
- Refer to the operating instructions of the PC, too.
- If a card is not inserted when the camera is connected to the PC, you can edit or access the picture data on the built-in memory. If a card is inserted, you can edit or access the picture data on it.
- You cannot switch between the built-in memory and the card while the camera is connected to the PC. When you want to switch between the built-in memory and the card, disconnect the USB connection cable, insert (or remove) the card and then connect the USB connection cable to the PC again.
- When you change the mode dial to print mode [,] with the camera connected to the PC, [PLEASE RE-CONNECT THE PRINTER.] appears on the camera's LCD monitor. Before reconnecting the camera to a printer, change the mode from [,] to another one and make sure that data transmission is not in progress. ([ACCESS] appears on the camera's LCD monitor while data transmission is in progress.)

Connecting to a PictBridge-compliant Printer



By connecting the camera directly to a printer supporting PictBridge via the USB connection cable (supplied), you can select the pictures to be printed or start printing on the LCD monitor. Make the necessary settings on your printer beforehand. (Read your printer's operating instructions.)

1 Turn on the camera and the printer.

2 Set the mode dial to [P].

- [PLEASE CONNECT TO THE PRINTER] appears.

3 Connect the camera to a printer via the USB connection cable ① (supplied).

- Connect the USB connection cable with the [←] mark facing the [▶] mark on the [DIGITAL] socket.
- Hold ② and then insert or pull the USB connection cable straight.



- Do not use any other USB connection cables except the supplied one.
- When you connect the camera to a printer without setting the mode dial to [P], remove the cable, set the mode dial to [P], turn the camera and the printer off and on, and connect again.
- If a card is not inserted when the camera is connected to the printer, you can print the picture data on the built-in memory. If a card is inserted, you can print the picture data on it.
- You cannot switch between the built-in memory and the card while the camera is connected to the printer. When you want to switch between the built-in memory and the card, disconnect the USB connection cable, insert (or remove) the card and then connect the USB connection cable to the printer again.
- To print the age in [BABY1]/[BABY2]

and [PET] in scene mode (P47) or the departure date for [TRAVEL DATE] (P55), use the software [LUMIX Simple Viewer] or [PHOTOfunSTUDIO-viewer-] in the CD-ROM (supplied) and print from the PC. For information about this, refer to the separate operating instructions for PC connection.

- To find out more about PictBridge compliant printers, contact your local dealer.

■ To connect

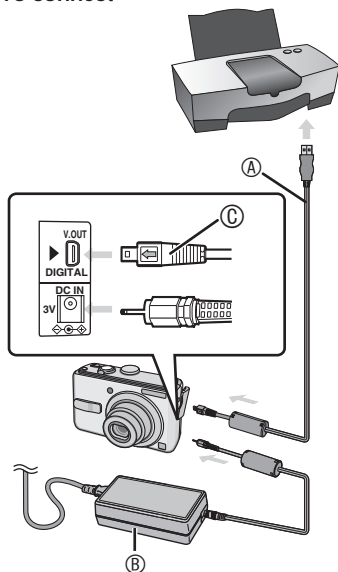

① : USB connection cable (supplied)

② : AC adaptor (DMW-AC6; optional)

- It may take time to print some pictures. Use batteries with sufficient battery power (P24) or the AC adaptor (DMW-AC6; optional) when you connect to a printer.
 - Make sure this unit is off before connecting or disconnecting the AC adaptor (DMW-AC6; optional).
- ③ : Check the facing of the connector and push straight in.

■ Printing the selected picture (making a single print)

1 Press **◀/▶** to select the picture and then press **[MENU/SET]**.

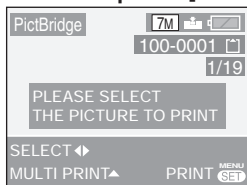

- A message displays for about 2 seconds.

2 Press **▲** to select **[PRINT START]** and then press **[MENU/SET]**.

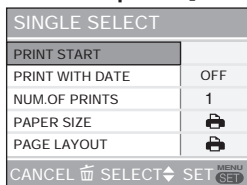

- Press **[MENU/SET]** to cancel printing.

3 Disconnect the USB connection cable after printing.

■ Selecting multiple pictures for printing

1 Press **▲**.

2 Press **▲/▼** to select an item and then press **[MENU/SET]**.

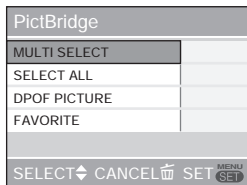

Item	Setting contents
MULTI SELECT	Multiple pictures are selected at once for printing. [Operation] On the plural pictures screen, press ◀/▶ to select pictures. When you press ▼ , [] is displayed with the picture you selected for printing. (When you press ▼ once more, the print setting is canceled.) Press [MENU/SET] when you finish selection.
SELECT ALL	All pictures in the built-in memory or the card are printed.
DPOF PICTURE	Pictures in the [DPOF PRINT] setting (P77) are printed.
FAVORITE	Pictures set as favorites (P73) are printed. • This item appears only when favorite setting is [ON]. • You cannot select any picture when [FAVORITE] is set to [ON], but no picture is marked with [★] .

3 Press ▲ to select [PRINT START] and then press [MENU/SET].

MULTI SELECT	
PRINT START	
PRINT WITH DATE	OFF
NUM.OF PRINTS	1
PAPER SIZE	
PAGE LAYOUT	
CANCEL	SELECT



- In DPOF setting, [PRINT WITH DATE] and [NUM. OF PRINTS] are not displayed.
- When you select [DPOF PICTURE], [DPOF SET] is selectable. When you select [DPOF SET], refer to P77.
- Press [MENU/SET] when you wish to cancel printing halfway.
- When you select [MULTI SELECT], [SELECT ALL] or [FAVORITE], the print confirmation screen appears. Select [YES] and perform printing.
- When the number of prints exceeds 1,000, [PRINTING --- PICTURES DO YOU WANT TO PROCEED?] appears on the print confirmation screen.

4 Disconnect the USB connection cable after printing.

■ Setting date printing, the number of prints, the paper size and the page layout

- Select an item to set on the screen for step 2 in "Printing the selected picture (making a single print)" (P88) or on the screen for step 3 in "Selecting multiple pictures for printing" (P88, 89).

- When you want to print pictures in a paper size or a layout which is not supported by the camera, set [PAPER SIZE] and [PAGE LAYOUT] to and then set the paper size or the layout on the printer. (For details, refer to the operating instructions of the printer.)

• [PRINT WITH DATE]

OFF	Date is not printed.
ON	Date is printed.

- If the printer does not support date printing, the date cannot be printed on the picture.
- [NUM. OF PRINTS]
Set the number of prints.
 - You can set up to 999 prints.
- [PAPER SIZE]
(Possible paper sizes on the camera)
The items are listed on 1/2 and 2/2.
Press ▼ to select the desired item.





1/2	
	Settings on the printer are prioritized.
L/3.5" × 5"	89 mm × 127 mm
2L/5" × 7"	127 mm × 178 mm
POSTCARD	100 mm × 148 mm
A4	210 mm × 297 mm

2/2*	
CARD SIZE	54 mm × 85.6 mm
10 × 15cm	100 mm × 150 mm
4" × 6"	101.6 mm × 152.4 mm
8" × 10"	203.2 mm × 254 mm
LETTER	216 mm × 279.4 mm

- * These items cannot be displayed when the printer does not support the paper sizes.

• [PAGE LAYOUT]

(Possible layouts on the camera)

	Settings on the printer are prioritized.
	1 page with no frame print
	1 page with frame print
	2 pages print
	4 pages print

- An item cannot be selected if the printer does not support the page layout.

■ Layout printing





• When printing a picture several times on 1 sheet of paper

For example, if you want to print a picture 4 times on 1 sheet of paper, set [PAGE LAYOUT] to  and then set the number of prints to 4 for the picture on [NUM. OF PRINTS].

• When printing different pictures on 1 sheet of paper

For example, if you want to print 4 different pictures on 1 sheet of paper, set [PAGE LAYOUT] to 4-picture printing  and then set [NUM. OF PRINTS] for the pictures to 1.



- Do not disconnect the USB connection cable when the cable disconnection warning icon  is indicated. (Depending on the printer, the icon may not be displayed.)
- If the remaining battery power becomes low while the camera and the printer are connected, the status indicator blinks and the alarm beeps. If this happens during printing, press [MENU/SET] and stop printing at once. If not printing, disconnect the USB connection cable.
- The camera is receiving an error message from the printer when the  indication lights orange during printing. After finishing printing, make sure there are no problems with the printer.
- If the total number of ordered prints or the number of pictures set for print is large, printing is performed at intervals. In such cases, the number of remaining prints shown on the display will differ from the number of prints you set. The discrepancy, however, does not indicate an error.
- Date print function on the printer may have priority over the same settings on the camera. Check the setting on the printer as well.
- When the mode dial is set to a choice other than print mode , [USB MODE CHANGED. PLEASE REMOVE THE USB CABLE.] appears on the camera's LCD monitor. Set the mode dial back to  before disconnecting the USB connection cable. Disconnect the USB connection cable after canceling printing.
- When you want to print pictures with date, the [DATE STAMP] function (P75) is also useful. **Note that if you use date stamp and then specify printing the date when you order prints or on a printer, both dates will be printed and may overlap.**

Playing Back Pictures with a TV Screen



■ Playing back pictures with the supplied cable

- Set the [TV ASPECT]. (P23)
- Turn the camera and the TV off.

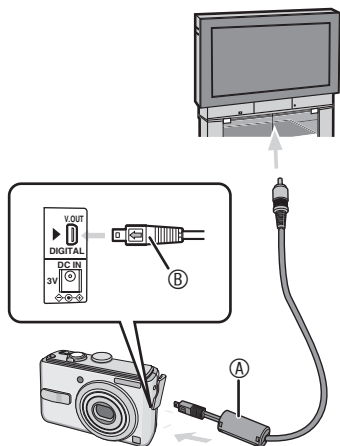

1 Connect the video cable ① (supplied) to the [V. OUT] socket of the camera.

- Connect the video cable with the [←] mark facing the [▶] mark on the [V. OUT] socket.
- Hold ② and then insert or pull the video cable straight.

2 Connect the video cable to the video input socket of the TV.

3 Turn the TV on and select external input.

4 Turn the camera on.



- Do not use any other Video cables except the supplied one.
- The top and bottom or left and right of the picture may be cut off slightly when it is displayed due to the characteristics of the TV.
- Depending on the screen mode setting of the TV when you connect the camera to a wide-screen TV or a high-definition TV, the picture may be stretched horizontally or vertically and the top and bottom and or left and right of the picture may be cut off when it is displayed. In this case, change the screen mode setting.
- Read the TV operating instructions too.
- Pictures might be slightly blurred if you show them vertically on a television.
- You can view pictures on TVs in other countries (regions) which use the NTSC or PAL system when you set [VIDEO OUT] in the [SETUP] menu. Even if you set [VIDEO OUT] to [PAL], the output signal will still be NTSC in the recording mode.

■ Playback pictures on TV with SD Memory Card slot

You can put your SD Memory Card in a television with an SD Memory Card slot to show still images.



- Depending on the television, some pictures may not take up the whole screen.
- You cannot play motion pictures. To play back motion pictures, connect the camera to the TV with the video cable (supplied).
- You may be unable to play MultiMedia Cards.

Screen Display

The LCD monitor shows the status of the camera.

In normal picture mode [📷] (Initial setting)

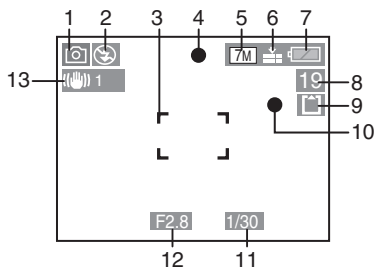

■ In recording

- 1 Recording mode
- 2 Flash mode (P40)
- 3 AF area (P25)
- 4 Focus indication (P25)
- 5 Picture size (P62)
- 6 Quality (P62)
- Jitter alert indication (P27) : 📷
- 7 Battery indication (P24)
- 8 Remaining number of recordable pictures
- 9 [IN] : Built-in memory (P16)
[C] : Card (P16)
- 10 Recording indication
- 11 Shutter speed indication (P25)
- 12 Aperture value indication (P25)
- 13 Optical image stabilizer (P64)
- 14 Burst (P65)
- 15 White balance (P60)
- 16 Sensitivity (P61)
ISO MAX 400 : ISO limit (P45)
- 17 Color mode (P66)
- 18 In Motion picture mode (P53) :
30fps VGA // 10fps VGA // 30fps DVGA //
10fps QVGA (4:3)
30fps 16:9 // 10fps 16:9 (16:9)
- 19 Available recording time in Motion picture mode
e.g. : R 1h 20m 30s
- 20 Histogram (P38)

In recording (After settings)

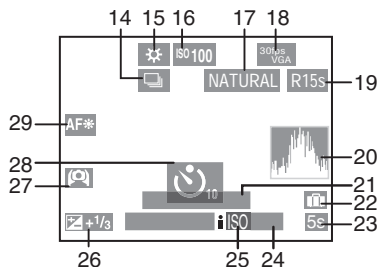

21 Age (P50)

- It is displayed about 5 seconds when switching to [BABY] or [PET] in scene mode.

Number of days that have passed since the departure date (P55)

22 Travel date (P55)

23 Elapsed recording time (P53)

24 Current date and time/Destination settings : 🛩️ (P57)

- It is displayed for about 5 seconds when turning the camera on, setting the clock and after switching from the playback mode to the recording mode.

Zoom (P30)/Extended optical zoom (P30)/Easy zoom (P31)/Digital zoom (P32) :



25 Intelligent ISO (P45)

26 Exposure compensation (P44)

27 High angle mode (P39)

28 Self-timer (P43)

29 AF assist lamp (P66)

In Simple mode

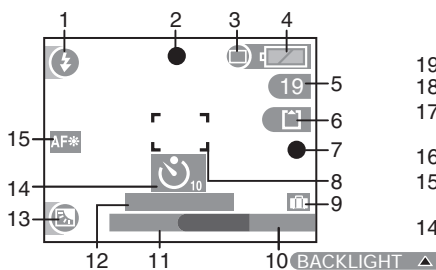

In Playback

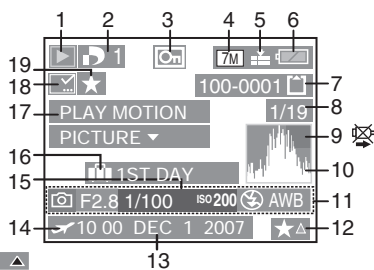

■ In simple mode

- 1 Flash mode (P40)
- 2 Focus indication (P25)
- 3 Picture mode (P28)
 : Jitter alert indication (P27)
- 4 Battery indication (P24)
- 5 Remaining number of recordable pictures
- 6 : Built-in memory (P16)
 : Card (P16)
- 7 Recording indication
- 8 AF area (P25)
- 9 Travel date (P55)
- 10 Backlight compensation operation (P29)
- 11 Current date and time
 It is displayed about 5 seconds then turning the camera on, setting the clock and after switching from the playback mode to the recording mode.
 Zoom (P30)/Extended optical zoom (P30)/Easy zoom (P31)
- 12 Number of days that have passed since the departure date (P55)
- 13 Backlight compensation (P29)
- 14 Self-timer (P43)
- 15 AF assist lamp (P66)

■ In Playback

- 1 Playback mode (P34)
- 2 Number of DPOF prints (P77)
- 3 Protected picture (P79)
- 4 Picture size (P62)

5 Quality (P62)

In Motion picture mode (P53) :

(4:3)

(16:9)

In simple mode (P28):

: ENLARGE

: 4" × 6 7/10 × 15 cm

: E-MAIL

6 Battery indication (P24)

7 Folder/File number (P85)

: Built-in memory (P16)

: Card (P16)

8 Picture number/Total pictures

9 Cable disconnection warning icon (P90)

Motion picture recording time (P70) :

1h 20m 30s

10 Histogram (P38)

11 Recording information

12 Favorites setting (P73)/

Elapsed playback time (P70) :

1h 20m 30s

13 Recorded date and time

14 Destination settings (P57)

15 Age display (P50)

16 Number of days that have passed since the departure date (P55)

17 Motion picture playback (P70)

18 Date stamp complete indicator (P76)

19 Favorites indicator (P73)

Cautions for Use

■ Optimal Use of the Camera

Take care not to drop or knock the unit or put a lot of pressure on it.

- Do not leave the unit in your pants pocket when you sit down or forcefully insert it into a full bag etc.
- Take care not to drop or knock the bag that you inserted the unit in as it may strongly shock the unit.
- A strong shock may break the lens, screen or outer case and cause the camera to malfunction.



Keep the camera as far away as possible from electromagnetic equipment (such as microwave ovens, TVs, video games etc.).

- If you use the camera on top of or near a TV, the pictures on the camera may be disrupted by electromagnetic wave radiation.
- Do not use the camera near cell phones because doing so may result in noise adversely affecting the pictures.
- Recorded data may be damaged, or pictures may be distorted, by strong magnetic fields created by speakers or large motors.
- Electromagnetic wave radiation generated by microprocessors may adversely affect the camera, disturbing the pictures.
- If the camera is adversely affected by electromagnetic equipment and stops functioning properly, turn the camera off and remove the battery or disconnect AC adaptor (DMW-AC6; optional). Then reinsert the battery or reconnect AC adaptor and turn the camera on.

Do not use the camera near radio transmitters or high-voltage lines.

- If you record near radio transmitters or high-voltage lines, the recorded pictures may be adversely affected.

Make sure to use the supplied cords and cables. If you use optional accessories, use the cords and the cables supplied with them. Do not extend the cords and the cables.

Do not spray insecticides or volatile chemicals onto the camera.

- If the camera is sprayed with such chemicals, the camera body may be damaged and the surface finish may peel off.
- Do not keep rubber or plastic products in contact with the camera for a long period of time.

Do not use benzene, thinner or alcohol for cleaning the camera.

- Before cleaning the camera, remove the batteries or disconnect the AC adaptor (DMW-AC6; optional) from the electrical outlet.
- The camera body may be deformed and the surface finish may peel off.
- Wipe the dust or fingerprints with a soft, dry cloth. To remove stubborn stains, soak a dry cloth in water and then use it to wipe the dirt. Then wipe again with a dry cloth.
- Do not use a kitchen detergent or a chemically treated cloth.
- In case rain or other sources of water splash onto the camera, wipe it with a dry cloth.

■ Batteries

Be sure to remove the batteries when you will not be using the camera for a long period of time.

- If the temperature is too high or low, the terminals may rust causing a malfunction.

If you drop the batteries accidentally, check to see if the body of the batteries and the terminals are damaged.

- Inserting a damaged battery in the camera will damage the camera.

Bring charged spare batteries when going out.

- Be aware that the operating time of the batteries becomes shorter in low temperature conditions such as at a ski resort.

Dispose of unusable batteries.

- Batteries have a limited life.
- Do not throw batteries into fire because they may cause an explosion.
- Unusable batteries should be discarded in accordance with battery recycling laws. Call the RBRC hotline on 1-800-822-8837 for information.

Do not allow battery terminals to come into contact with metal objects (such as necklaces, hairpins, etc.).

- This can cause short circuiting or heat generation and you may be badly burned if you touch the batteries.

■ Card

Do not leave the card in places where there is high temperature or direct sunlight, or where electromagnetic waves or static electricity are easily generated.

Do not bend or drop the card.

- The card may be damaged or the recorded content may be damaged or erased.
- Store the card in the card case or the storage bag after use and when you store or carry the card.
- Do not allow dirt, dust or water to enter the terminals on the back of the card and do not touch the terminals with your fingers.

Message Display

Confirmation messages or error messages will be displayed on the screen in some cases. The major messages are described below as examples.

[CURRENT BATTERY TYPE SETTING: OXYRIDE]/[CURRENT BATTERY TYPE SETTING: ALKALINE/Ni-MH]

This message is displayed the first time you insert batteries and when the batteries are exhausted and you replace them. If the battery type being used is different from the one indicated in the message, change the battery type in [BATTERY TYPE] in the [SETUP] menu. (P21)

[THIS MEMORY CARD IS LOCKED]

Cancel the card lock. (P16, 79)

[NO VALID PICTURE TO PLAY]

Play back after recording or after inserting a card with a recorded picture.

[THIS PICTURE IS PROTECTED]

After canceling the protect setting (P79), you can delete or overwrite the picture.

[THIS PICTURE CANNOT BE DELETED]/[SOME PICTURES CANNOT BE DELETED]

The pictures not based on the DCF standard cannot be deleted.

To delete this kind of picture, first save your data to your computer, then use this unit to reformat the card. (P83)

[NO ADDITIONAL DELETE SELECTIONS CAN BE MADE]

You have selected more than the allowed number of items in multi delete or the MULTI setting in [DATE STAMP]. Repeat the procedure as necessary.

You have placed more than 999 pictures in your favorites list.

[CANNOT BE SET ON THIS PICTURE]/[CANNOT BE SET ON SOME PICTURES]

The DPOF setting cannot be set to the following pictures.

- Pictures not based on the DCF.

[NOT ENOUGH SPACE ON BUILT-IN MEMORY]/[NOT ENOUGH MEMORY ON THE CARD]

There is no space left on the built-in memory or the card.

- When you copy pictures from the built-in memory to the card (batch copy), the pictures are copied until the capacity of the card becomes full.

[SOME PICTURES CANNOT BE COPIED]/[COPY COULD NOT BE COMPLETED]

The following pictures cannot be copied.

- When a picture with the same name as the picture to be copied exists in the copy destination.
 - Files not based on the DCF standard.
- Moreover, pictures recorded or edited by other equipment may not be copied.

[BUILT-IN MEMORY ERROR FORMAT BUILT-IN MEMORY?]

This message will be displayed when you format the built-in memory on the PC or remove the battery without turning the camera off. Format the built-in memory of the camera again. (P83) The data on the built-in memory will be deleted.

[MEMORY CARD ERROR FORMAT THIS CARD?]

The format of the card cannot be recognized by this camera. Format the card again with this camera. Save your data to your computer, then use this unit to reformat the card. (P83)

[PLEASE TURN CAMERA OFF AND THEN ON AGAIN]

This message appears when the camera is not operating properly. Turn the camera off and on. If the message persists, contact the dealer or your nearest Service Center.

[MEMORY CARD ERROR MEMORY CARD PARAMETER ERROR]

Use a card compatible with this camera. (P5, 16)

You can only use 4 GB cards if they are SDHC Memory Cards.

[MEMORY CARD ERROR PLEASE CHECK THE CARD]

- Failed access to the card.
Insert the card again.

[READ ERROR PLEASE CHECK THE CARD]

Data reading error.
Insert the card again. Make sure the card is inserted properly and then play back again.

[WRITE ERROR PLEASE CHECK THE CARD]

Data writing error.
Turn the camera off and remove the card. Then insert the card and turn the camera on again. This error may also indicate that the card is damaged.

[MOTION RECORDING WAS CANCELLED DUE TO THE LIMITATION OF THE WRITING SPEED OF THE CARD]

- When you set the [PICT.MODE] to [30fpsVGA] or [30fps16:9], we recommend using cards that offer 10 MB/second or higher speeds (shown on their packages and elsewhere) for best results.

- Depending on the type of Card, recording may stop in the middle.

[A FOLDER CANNOT BE CREATED]

A folder cannot be created because there are no remaining folder numbers that can be used. (P85)
Save your data to your computer, then use this unit to reformat the card. (P83)
If you execute [NO.RESET] in the [SETUP] menu after formatting, the folder number is reset to 100. (P22)

**[PICTURE IS DISPLAYED FOR 4:3 TV]/
[PICTURE IS DISPLAYED FOR 16:9 TV]**

- The video cable is connected to the camera. Press [MENU/SET] if you want to delete this message at once.
- Select [TV ASPECT] in the [SETUP] menu to change the TV aspect. (P23)
- This message also appears when the USB connection cable is connected to the camera only.
In this case, connect the other end of the USB connection cable to a PC or a printer. (P84, 87)

[PLEASE RE-CONNECT THE PRINTER.]

This message appears if you change the mode dial to [] while the camera and the PC are connected. Set the camera to a mode other than [] mode, check that no data is being transferred and then connect to the printer again. ([ACCESS] appears on the LCD monitor of the camera while data is being transferred.)

[USB MODE CHANGED. PLEASE REMOVE THE USB CABLE.]

This message appears if you change the mode dial to a mode other than [] while the camera and the printer are connected. Set the mode dial to [] again and then disconnect the USB connection cable. If this happens during printing, stop printing and then disconnect the USB connection cable.

Troubleshooting

If you put the menu back to the settings at the time of purchase, the conditions may be improved. Carry out the [RESET] in the setup menu. (P23)

■ Batteries and power supply

Conditions	Causes
The camera turns off immediately even when battery power is full.	The remaining battery power may not be displayed accurately, and the camera may suddenly stop working, when the type of battery and the settings on [BATTERY TYPE] are not identical. However this is not a malfunction. Depending on the battery brand and the operating temperature, or if exhausted batteries are used, the remaining battery power may not be displayed accurately. Please check [BATTERY TYPE] (P21) in the [SETUP] menu.
The remaining battery power is low even if new batteries are inserted.	
The camera will not turn on.	Are the batteries inserted correctly? Use sufficiently charged batteries when using Ni-MH batteries.
The picture is not displayed on the LCD monitor.	Is the power save mode (P21) or economy mode (P22) activated? Press the shutter button halfway to deactivate these modes.
	Are the batteries exhausted? Replace them with batteries which have sufficient capacity. (When you use Ni-MH batteries, charge them.)
The camera turns off soon after turning it on.	<ul style="list-style-type: none"> • Are the batteries exhausted? Replace them with batteries which have sufficient capacity. (When you use Ni-MH batteries, charge them.) • If you leave the camera on, the battery will be exhausted. Turn the camera off frequently by using power save mode (P21) or economy mode (P22) etc.

■ Shooting



Conditions	Causes
The picture cannot be recorded.	Is the mode dial correctly set?
	Is there any memory capacity left on the built-in memory or the card? Before recording, delete some pictures. (P35)
The recorded pictures are pale. There is dirt on the lens.	The picture can become whitish if there is dirt e.g. fingerprints on the lens. If the lens is dirty, turn on the camera, eject the lens barrel (P9) and gently wipe the lens surface with a soft dry cloth.
The recorded picture is too bright or dark.	Check that the exposure is correctly compensated. (P44)

Conditions	Causes
The subject is not focused properly.	The focus range varies depending on the recording mode. To set the proper mode for the distance to the subject, rotate the mode dial.
	Is the subject out of the focus range? (P25, 46)
	Have you taken a picture with jitter?
Sometimes two or three pictures are taken with a single press of the shutter button.	Is the camera set in burst mode (P65)?
The recorded picture is blurred. The optical image stabilizer is not effective.	When taking a picture in shaded areas or indoors, the shutter speed becomes slow and the Optical Image Stabilizer function may not work properly. In this case, we recommend holding the camera with both hands firmly to take pictures (P25).
Images are grainy or noisy.	Is the ISO sensitivity high or the shutter speed slow? (When set to [AUTO], ISO sensitivity increases for indoor and other shooting occasions.)
	<ul style="list-style-type: none"> • Reduce ISO sensitivity. (P61) • Set [COL.MODE] to [NATURAL]. (P66) • Improve the ambient light.
	In [HIGH SENS.] (P51) in scene mode, the resolution of the recorded picture decreases slightly because of high sensitivity processing. This is not a malfunction.
The brightness or color of the picture differs from the actual scene.	Brightness and colors may change when using a fast shutter speed under fluorescent lights, but this is a characteristic of such lighting and is not a malfunction.
Shooting of motion pictures stops unexpectedly.	This camera is not compatible with motion picture recording on MultiMediaCards.
	<ul style="list-style-type: none"> • When you set the [PICT.MODE] to [30fpsVGA] or [30fps16:9], we recommend using cards that offer 10 MB/second or higher speeds (shown on their packages and elsewhere) for best results. • Depending on the type of SD Memory Card or SDHC Memory Card, recording may stop in the middle.
A reddish vertical line appears on the LCD monitor while the shutter button is pressed halfway or recording motion pictures.	<p>This is a phenomenon called smear. It is a characteristic of CCD and appears when the subject has a bright part. Black or green vertical lines or horizontal irregularities may also appear around the smear, but this is not a malfunction. It is recorded in motion pictures but is not recorded on still pictures.</p> 

■ LCD

Conditions	Causes
The LCD monitor sometimes turns off although the camera is turned on.	Is the LCD monitor turned off soon after you take pictures with the flash? While the flash is being charged, the LCD monitor is turned off.
The brightness of the LCD monitor becomes dark or bright for a moment.	This phenomenon appears when pressing the shutter button halfway to set the aperture value and does not affect the recorded pictures.
The LCD monitor flickers indoors.	The LCD monitor may flicker for a few seconds after turning the camera on indoors under fluorescent light. This is not a malfunction.
The LCD monitor is too bright or dark.	Adjust the brightness of the LCD monitor. (P22) Is the high angle mode activated? (P39)
Black, red, blue and green dots appear on the LCD monitor.	This is not a malfunction. These pixels do not affect the recorded pictures.
Noise appears on the LCD monitor.	In dark places, noise may appear to maintain the brightness of the LCD monitor. This does not affect the pictures you are recording.

■ Flash

Conditions	Causes
Flash is not activated.	Is the flash setting set to Forced OFF  ? Change the flash setting. (P40)
	The flash is not activated when motion picture mode  , [SCENERY], [NIGHT SCENERY], [SUNSET], [HIGH SENS.], [STARRY SKY], [FIREWORKS] or [AERIAL PHOTO] in scene mode (P47) is selected.
The flash is activated 2 times.	When you select red-eye reduction (P40), the flash is activated once before the actual recording to reduce the red-eye phenomenon (eyes of the subject appearing red in the picture) and then activated again for the actual recording.

■ Playback

Conditions	Causes
Pictures rotate unexpectedly.	<p>One of the features of this unit can automatically detect when you have turned the camera side on to take a picture, then rotate that picture for you when you play it back.</p> <p>In some cases, the unit may detect that you have turned the camera sideways, when in fact you are facing it up or down.</p> <ul style="list-style-type: none"> • Set [ROTATE DISP.] (P74) to [OFF] so that the camera does not rotate these kinds of pictures for you. • You can use [ROTATE] (P74) to rotate the pictures when necessary.
The picture is not played back.	<p>Is the mode dial set to playback [▶]?</p> <p>Is there a picture on the built-in memory or the card?</p> <ul style="list-style-type: none"> • The pictures on the built-in memory appear when a card is not inserted. The picture data on the card appears when a card is inserted. (P16)
Folder or file number appears as [-] and the display goes black.	<p>The picture may have been changed on a computer or taken on a different manufacturer's camera.</p> <p>This problem can also occur if you remove the batteries immediately after taking a picture or if the batteries had very little charge left.</p> <ul style="list-style-type: none"> • You will need to reformat the card to delete this type of picture. (P83) (Remember that all data will be irretrievably erased when you format the card, so save your data and check the card before proceeding.)
The picture is displayed with a date different from the actual recording date in calendar playback.	<p>Was the picture edited with a PC or recorded with a digital camera from another manufacturer?</p> <p>This kind of picture may be displayed with a date different from the actual recording date in calendar playback. (P68)</p> <p>Is the clock in the camera set properly? (P17)</p> <p>For example, if the clock setting on the camera is different from the date and time set on the PC and you acquire pictures recorded with the camera to the PC and then write them back to the card, the pictures may be displayed with dates different from the actual recording dates in calendar playback etc.</p>

■ Connecting to a TV, computer or printer

Conditions	Causes
The picture does not appear on the television. The TV screen is disturbed or displayed in monochrome.	<p>Is the camera connected to the TV correctly?</p> <p>Set the TV to video input mode.</p>

Conditions	Causes
The display areas on the TV screen and the camera's LCD monitor are different.	Depending on the TV model, the area display may be smaller so the picture may be stretched horizontally or vertically and the top and bottom or left and right of the picture may be cut off when it is displayed. This is due to the TV specifications and is not a malfunction.
Cannot play motion pictures on a television.	You cannot play motion pictures if you have inserted the card into a card slot on a television. Connect the camera to the television with the included video cable and play the pictures on this unit. (P91)
The picture size does not fit the TV screen.	Check the [TV ASPECT] setting on this unit. (P23)
Cannot upload pictures to your computer.	Check the connections.
	Check that the computer has correctly recognized the camera.
	Set the camera's mode dial to a mode other than Print mode (P84).
The computer does not recognize the card. (The built-in memory is recognized.)	Disconnect the USB connection cable, then insert the card and reconnect the cable.
The pictures cannot be printed with printers.	Does the printer support PictBridge? You cannot print pictures with printers which do not support PictBridge. (P87) Set the camera's mode dial to Print mode (P87).
The sides of printed images are cut off.	<ul style="list-style-type: none"> If your printer has trimming and border settings, change the settings so that there is no trimming and no border. (Read your printer's operating instructions.) Some photography shops can handle pictures shot in the [16:9] aspect ratio (P62). Enquire before sending them for printing.

■ Others







Conditions	Causes
Unreadable language was selected by mistake.	Press [MENU/SET], select the [SETUP] menu icon [P] and then select the [Q] icon to set the desired language. (P23)
Cannot change the auto review setting.	You cannot change the auto review setting when using burst mode or shooting motion pictures.
When the shutter button is pressed halfway, a red lamp turns on sometimes.	In dark places, the AF assist lamp (P66) lights red to make it easier to focus on a subject.





Conditions	Causes
The AF assist lamp does not turn on.	Is [AF ASSIST LAMP] on the [REC] mode menu set to [ON]? (P66)
	Are you taking pictures in dark places? The AF assist lamp does not turn on in bright places.
	The AF assist lamp does not turn on when [SCENERY], [NIGHT SCENERY], [SUNSET], [FIREWORKS] or [AERIAL PHOTO] in scene mode (P47) is selected.
The camera gets hot.	The camera may get a little warm while you are using it, but this is normal.
The lens clicks.	When brightness has changed due to the zoom or the movement of the camera or other, the lens may click and the picture on the screen may be drastically changed, however, the pictures are not affected. The sound is caused by automatic adjustment of the aperture. It is not a malfunction.
The clock setting is reset.	If you do not use the camera for a long time, the clock setting may be reset. When the message [PLEASE SET THE CLOCK] appears, set the clock again. (P17)
	When you take a picture before setting the clock, [0:00 0. 0. 0] is recorded.
Images appear slightly distorted.	Images may be taken with some distortion depending on the zoom ratio. This distortion increases as you get nearer the subject, but it is not a malfunction.
Strange colors appear around the edge of the image.	Depending on the zoom magnification, the picture may have some colored fringes around the subject. This is called chromatic aberration and may be more visible when recording distant subjects. However this is not a malfunction.
File numbers are not created in order.	Certain operations cause pictures to be saved in folders with different numbers. (P85)
The file numbers are recorded in ascending order.	If the batteries are inserted or removed when the camera is not turned off, the recorded folder numbers are lost. However if you turn the camera on again and record pictures, the file numbers may be recorded in ascending order.
The picture is displayed black.	Pictures edited or rotated with a PC may be displayed in black in playback mode (P34), multi playback (P67) and calendar playback (P68).





Number of recordable pictures and available recording time





- The number of recordable pictures and the available recording time are an approximation. (These vary depending on the recording conditions and the type of card.)
- The number of recordable pictures and the available recording time vary depending on the subjects.
- The numbers inside the thick black line are the number of recordable pictures in simple mode [♥]. (P28)





■ Number of recordable pictures

Aspect ratio		4:3			
Picture size		DMC-LS75/DMC-LS70 7M / 7M (3072 × 2304 pixels)		DMC-LS60 only 6M / 6M (2816 × 2112 pixels)	
Quality		 / 		 / 	
Built-in Memory (Approx. 27 MB)		7	14	8	17
Card	16 MB	3	7	4	8
	32 MB	7	16	9	19
	64 MB	16	34	20	40
	128 MB	35	69	41	82
	256 MB	68	135	81	160
	512 MB	135	270	160	320
	1 GB	270	540	320	640
	2 GB	550	1090	660	1270
4 GB	1090	2150	1290	2510	

Aspect ratio		4:3			
Picture size		DMC-LS75/DMC-LS70 5M : 5M EZ (2560 × 1920 pixels)		3M : 3M EZ (2048 × 1536 pixels)	
Quality				 / 	
Built-in Memory (Approx. 27 MB)		10	21	16	33
Card	16 MB	5	10	8	16
	32 MB	11	23	18	36
	64 MB	24	48	38	75
	128 MB	50	99	78	150
	256 MB	98	190	150	290
	512 MB	195	380	300	590
	1 GB	390	770	600	1180
	2 GB	790	1530	1220	2360
4 GB	1560	3010	2410	4640	

Aspect ratio		4:3					
Picture size		2M : 2M EZ (1600 × 1200 pixels)		1M : 1M EZ (1280 × 960 pixels)		0.3M / □ : 0.3M EZ (640 × 480 pixels)	
Quality						 / 	
Built-in Memory (Approx. 27 MB)		27	53	41	78	130	210
Card	16 MB	13	27	21	40	68	110
	32 MB	29	58	45	85	145	230
	64 MB	61	120	93	175	290	480
	128 MB	125	240	190	350	600	970
	256 MB	240	470	370	690	1170	1900
	512 MB	480	940	730	1370	2320	3770
	1 GB	970	1880	1470	2740	4640	7550
	2 GB	1920	3610	2920	5120	8780	12290
4 GB	3770	7090	5740	10050	17240	24130	

Aspect ratio		3:2					
Picture size		DMC-LS75/DMC-LS70 6M : 6M (3072 × 2048 pixels)		DMC-LS60 only 5M : 5M (2816 × 1880 pixels)		2.5M / □ : 2.5M EZ (2048 × 1360 pixels)	
Quality						 / 	
Built-in Memory (Approx. 27 MB)		8	16	9	19	19	37
Card	16 MB	3	8	4	10	9	18
	32 MB	8	18	10	21	20	40
	64 MB	19	38	22	45	43	83
	128 MB	39	78	46	92	88	165
	256 MB	77	150	91	180	170	330
	512 MB	150	300	180	350	340	650
	1 GB	300	600	360	710	680	1310
	2 GB	620	1220	730	1420	1360	2560
4 GB	1230	2410	1450	2800	2680	5020	

Aspect ratio		16:9					
Picture size		DMC-LS75/DMC-LS70 5.5M : 5.5M (3072 × 1728 pixels)		DMC-LS60 only 4.5M : 4.5M (2816 × 1584 pixels)		2M : 2M EZ (1920 × 1080 pixels)	
Quality						 / 	
Built-in Memory (Approx. 27 MB)		9	19	11	23	25	48
Card	16 MB	4	10	5	11	12	25
	32 MB	10	21	12	25	27	53
	64 MB	22	45	27	53	57	105
	128 MB	46	92	55	105	115	220
	256 MB	91	180	105	210	230	430
	512 MB	180	350	210	420	450	860
	1 GB	360	710	430	850	910	1720
	2 GB	730	1420	870	1700	1800	3410
4 GB	1450	2800	1720	3350	3540	6700	

■ Available recording time (In Motion picture mode)

Picture quality setting		30fps VGA	10fps VGA	30fps QVGA	10fps QVGA	30fps 16:9	10fps 16:9
Built-in Memory (Approx. 27 MB)		—	—	53 s	2 min 40 s	—	—
Card	16 MB	6 s	26 s	26 s	1 min 23 s	5 s	22 s
	32 MB	17 s	59 s	59 s	2 min 55 s	14 s	50 s
	64 MB	39 s	2 min	2 min	6 min	33 s	1 min 46 s
	128 MB	1 min 23 s	4 min 10 s	4 min 10 s	12 min 20 s	1 min 11 s	3 min 35 s
	256 MB	2 min 45 s	8 min 10 s	8 min 10 s	24 min	2 min 20 s	7 min
	512 MB	5 min 30 s	16 min 20 s	16 min 20 s	47 min 50 s	4 min 40 s	14 min
	1 GB	11 min	32 min 50 s	32 min 50 s	1 h 35 min	9 min 20 s	28 min 10 s
	2 GB	22 min 30 s	1 h 7 min	1 h 7 min	3 h 15 min	19 min 20 s	57 min 30 s
	*4 GB	44 min 20 s	2 h 11 min	2 h 11 min	6 h 22 min	38 min	1 h 53 min

* The volume of motion picture is limited to 2 GB per recording session. The maximum available recording time for up to 2 GB only is displayed on the screen.



- The number of recordable pictures and the available recording time displayed on the LCD monitor may not decrease in order.
- This unit does not support recording motion pictures on MultiMediaCards.
- The extended optical zoom does not work in [HIGH SENS.] (P51) in scene mode so the picture size for [EZ] is not displayed.

Specifications

Digital Camera:	Information for your safety
Power Source:	DC 3 V
Power Consumption:	DMC-LS75/DMC-LS70: 1.5 W (When recording) DMC-LS60: 1.4 W (When recording) 0.6 W (When playing back)
Camera Effective pixels:	DMC-LS75/DMC-LS70: 7,200,000 pixels DMC-LS60: 6,000,000 pixels
Image sensor:	1/2.5" CCD
Total pixels	DMC-LS75/DMC-LS70: 7,380,000 pixels DMC-LS60: 6,370,000 pixels Primary color filter
Lens:	Optical 3 × zoom, f=5.8 to 17.4 mm [35 mm film camera equivalent: 35 to 105 mm] /F2.8 to F5.0
Digital zoom:	Max. 4 ×
Extended optical zoom:	DMC-LS75/DMC-LS70 : max 4.5 × (When recording resolution is 3M or less) DMC-LS60 : max 4.1 × (When recording resolution is 3M or less)
Focus:	Normal/Macro (Mode dial) 5-area-focusing/1-area-focusing (high speed)/1-area-focusing
Focus range:	Normal : 50 cm (1.64 feet) to ∞ Macro/Simple/Intelligent ISO/Motion picture: 5 cm (0.16 feet) (Wide)/ 30 cm (0.98 feet) (Tele) to ∞ Scene mode: settings may be different to those shown above
Shutter system:	Electronic shutter+Mechanical shutter
Motion picture recording:	Aspect ratio 4:3 : 640 × 480 pixels (When a card is used.)/ 320 × 240 pixels Aspect ratio 16:9 : 848 × 480 pixels (When a card is used.) 30 or 10 frames/second without audio
Burst recording	
Burst speed:	Depends on the type of card, the recording resolution, and picture quality
Number of recordable pictures:	Depends on the remaining capacity of the Built-in memory or the card. (unlimited)

ISO sensitivity:	AUTO/ 100/200/400/800/1250 [HIGH SENS.] mode: 3200
Shutter speed:	8 seconds to 1/2,000th of a second [STARRY SKY] mode: 15 seconds, 30 seconds, 60 seconds Motion picture mode: 1/30th of a second to 1/6,400th of a second
White balance:	Auto white balance/Daylight/Cloudy/Shade/Halogen/White set
Exposure (AE):	Program AE Exposure compensation (1/3 EV Step, -2 EV to +2 EV)
Metering mode:	Multiple
LCD monitor:	Amorphous silicon active TFT LCD DMC-LS75: 2.5" (Approx. 115,200 pixels) (field of view ratio about 100%) DMC-LS70/DMC-LS60: 2.0" (Approx. 86,400 pixels) (field of view ratio about 100%)
Flash:	Flash range: (ISO AUTO) Approx. 30 cm (0.98 feet) to 4.7 m (15.42 feet) (Wide [ISO AUTO] mode) AUTO, AUTO/Red-eye reduction, Forced ON (Forced ON/Red-eye reduction), Slow sync./Red-eye reduction, Forced OFF
Recording media:	Built-in Memory (Approx. 27 MB)/SD Memory Card/SDHC Memory Card/MultiMediaCard (Still pictures only)
Picture size:	
Still picture:	Aspect ratio [4:3]: 3072 × 2304 pixels (DMC-LS75/DMC-LS70), 2816 × 2112 pixels (DMC-LS60 only), 2560 × 1920 pixels (DMC-LS75/DMC-LS70), 2048 × 1536 pixels, 1600 × 1200 pixels, 1280 × 960 pixels, 640 × 480 pixels Aspect ratio [3:2]: 3072 × 2048 pixels (DMC-LS75/DMC-LS70), 2816 × 1880 pixels (DMC-LS60 only), 2048 × 1360 pixels Aspect ratio [16:9]: 3072 × 1728 pixels (DMC-LS75/DMC-LS70), 2816 × 1584 pixels (DMC-LS60 only), 1920 × 1080 pixels
Motion picture:	Aspect ratio [4:3]: 640 × 480 pixels (Only when using an SD Memory card/SDHC Memory Card), 320 × 240 pixels Aspect ratio [16:9]: 848 × 480 pixels (Only when using an SD Memory card/SDHC Memory Card)
Quality:	Fine/Standard

Recording file format

Still Picture: JPEG (Design rule for Camera File system, based on Exif 2.21 standard), DPOF corresponding

Motion pictures: QuickTime Motion JPEG

Interface

Digital: USB 2.0 (Full Speed)

Analog video: NTSC/PAL Composite (Switched by menu)

Terminal

DIGITAL/V.OUT: Dedicated jack (8 pin)

DC IN: Type1 jack

Dimensions: 3.69"(W) × 2.44"(H) × 1.17"(D)
(93.7 mm (W) × 62.0 mm (H) × 29.7 mm (D))
(excluding the projection part)

Weight:

DMC-LS75:

Approx. 4.87 oz/138 g
(excluding Memory Card and battery)

Approx. 6.49 oz/184 g
(with Memory Card and battery)

DMC-LS70/DMC-LS60:



Approx. 4.76 oz/135 g
(excluding Memory Card and battery)

Approx. 6.38 oz/181 g
(with Memory Card and battery)

Operating Temperature: 0 °C to 40 °C (32 °F to 104 °F)

Operating Humidity: 10 % to 80 %

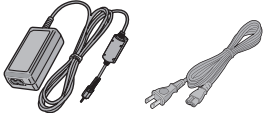
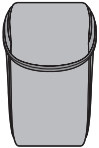
Digital Camera Accessory System

Accessory#	Figure	Description
DMW-AC6		AC Adaptor
DMW-CLS75		Soft Case
DMW-CHTZ3		Semi Hard Case
RP-SDR04GU1K RP-SDK02GU1A RP-SDR02GU1A RP-SDK01GU1A RP-SDH01GU1A RP-SDR01GU1A RP-SDK512U1A RP-SDR512U1A RP-SDH256U1A RP-SDR256U1A RP-SD128BU1A RP-SD064BPPA		4 GB SDHC Memory Card 2 GB SD Memory Card 2 GB SD Memory Card 1 GB SD Memory Card 1 GB SD Memory Card 1 GB SD Memory Card 1 GB SD Memory Card 512 MB SD Memory Card 512 MB SD Memory Card 256 MB SD Memory Card 256 MB SD Memory Card 128 MB SD Memory Card 64 MB SD Memory Card

- NOTE: Accessories and/or model numbers may vary by country. Please consult your local dealer.

Digital Camera Accessory Order Form

(For USA Customers)

Please photocopy this form when placing an order.

1. Digital Camera Model # _____
 2. Items Ordered

Accessory #	Description	Price Each	Quantity	Total Price
Subtotal				
Your State & Local Sales Tax				
Shipping & Handling				6.95
Total Enclosed				

3. Method of payment (check one)

- Check of Money Order enclosed (NO C.O.D.SHIPMENTS)
 VISA Credit Card # _____
 MasterCard Expiration Date _____
 Discover Customer Signature _____

Make Check or Money Order to: PANASONIC ACCESSORIES

(Please do not send cash)

4. Shipping information (UPS delivery requires complete street address)

Ship To:

Mr.

Mrs.

Ms.

 First Last

Phone#:

Day () _____

 Street Address

Night () _____

 City State Zip

TO OBTAIN ANY OF OUR DIGITAL CAMERA ACCESSORIES YOU CAN DO ANY OF THE FOLLOWING:

VISIT YOUR LOCAL PANASONIC DEALER

OR

CALL PANASONIC'S ACCESSORY ORDER LINE AT 1-800-332-5368

[6 AM-5 PM M-F, 6 AM-10:30 AM SAT, PACIFIC TIME]

OR

MAIL THIS ORDER TO: PANASONIC SERVICE AND TECHNOLOGY COMPANY
 ACCESSORY ORDER OFFICE

20421 84th Avenue South Kent, WA. 98032

In CANADA, please contact your local Dealer for more information about accessories.

Request for Service Notice (For USA Only)

Please photocopy this form when making a request for service notice.

In the unlikely event this product needs service.

Request for Service Notice: (USA Only)

- Please include your **proof of purchase**.
(Failure to do so will delay your repair.)
- To further speed your repair, please provide an explanation of what wrong with the unit and any symptom it is exhibiting.

Mail this completed form and your Proof of Purchase along with your unit to:

Panasonic Camera and Digital Service Center

1590 Touhy Ave.

Elk Grove Village, IL 60007

Limited Warranty (For USA Only)

PANASONIC CONSUMER ELECTRONICS COMPANY, DIVISION OF
PANASONIC CORPORATION OF NORTH AMERICA

One Panasonic Way, Secaucus, New Jersey 07094

PANASONIC PUERTO RICO, INC.

Ave. 65 de Infantería, Km. 9.5, San Gabriel Industrial Park, Carolina, Puerto Rico 00985

Panasonic Digital Still Camera Limited Warranty

Limited Warranty Coverage

If your product does not work properly because of a defect in materials or workmanship, Panasonic Consumer Electronics Company or Panasonic Puerto Rico, Inc. (collectively referred to as "the warrantor") will, for the length of the period indicated on the chart below, which starts with the date of original purchase ("warranty period"), at its option either (a) repair your product with new or refurbished parts, or (b) replace it with a new or refurbished product. The decision to repair or replace will be made by the warrantor.

PRODUCT OR PART NAME	PARTS	LABOR
DIGITAL STILL CAMERA (EXCEPT ITEMS LISTED BELOW)	1 (ONE) YEAR	1 (ONE) YEAR
CCD	6 (SIX) MONTHS	90 (NINETY) DAYS
RECHARGEABLE BATTERY PACK (IN EXCHANGE FOR DEFECTIVE BATTERY PACK)	90 (NINETY) DAYS	NOT APPLICABLE
SD MEMORY CARD (IN EXCHANGE FOR DEFECTIVE SD CARD)	90 (NINETY) DAYS	NOT APPLICABLE

During the "Labor" warranty period there will be no charge for labor. During the "Parts" warranty period, there will be no charge for parts. You must carry-in or mail-in your product during the warranty period. If non-rechargeable batteries are included, they are not warranted. This warranty only applies to products purchased and serviced in the United States or Puerto Rico. This warranty is extended only to the original purchaser of a new product which was not sold "as is". A purchase receipt or other proof of the original purchase date is required for warranty service.

Carry-In or Mail-In Service

For Carry-In or Mail-In Service in the United States call
1-800-272-7033.

For assistance in Puerto Rico call Panasonic Puerto Rico, Inc.
(787)-750-4300 or fax (787)-768-2910.

This warranty **ONLY COVERS** failures due to defects in materials or workmanship, and **DOES NOT COVER** normal wear and tear or cosmetic damage. The warranty **ALSO DOES NOT COVER** damages which occurred in shipment, or failures which are caused by products not supplied by the warrantor, or failures which result from accidents, misuse, abuse, neglect, mishandling, misapplication, alteration, faulty installation, set-up adjustments, misadjustment of consumer controls, improper maintenance, power line surge, lightning damage, modification, or commercial use (such as in a hotel, office, restaurant, or other business), rental use of the product, service by anyone other than a Factory Service Center or other Authorized Servicer, or damage that is attributable to acts of God.

THERE ARE NO EXPRESS WARRANTIES EXCEPT AS LISTED UNDER "LIMITED WARRANTY COVERAGE". THE WARRANTOR IS NOT LIABLE FOR INCIDENTAL OR CONSEQUENTIAL DAMAGES RESULTING FROM THE USE OF THIS PRODUCT, OR ARISING OUT OF ANY BREACH OF THIS WARRANTY. (As examples, this excludes damages for lost time, travel to and from the servicer, loss of media or images, data or other memory content. The items listed are not exclusive, but are for illustration only.) **ALL EXPRESS AND IMPLIED WARRANTIES, INCLUDING THE WARRANTY OF MERCHANTABILITY, ARE LIMITED TO THE PERIOD OF THE LIMITED WARRANTY.**

Some states do not allow the exclusion or limitation of incidental or consequential damages, or limitations on how long an implied warranty lasts, so the exclusions may not apply to you.

This warranty gives you specific legal rights and you may also have other rights which vary from state to state. If a problem with this product develops during or after the warranty period, you may contact your dealer or Service Center. If the problem is not handled to your satisfaction, then write to the warrantor's Consumer Affairs Department at the addresses listed for the warrantor.

PARTS AND SERVICE WHICH ARE NOT COVERED BY THIS LIMITED WARRANTY ARE YOUR RESPONSIBILITY.

Customer Services Directory (For USA Only)

For Product Information, Operating Assistance, Literature Request, Dealer Locations, and all Customer Service inquiries please contact:
1-800-272-7033, Monday-Friday 8:30am-8pm EST.

Web Site: <http://www.panasonic.com/consumersupport>
 You can purchase parts, accessories or locate your nearest Service Center by visiting our Web Site.

Accessory Purchases

Purchase Parts, Accessories and Instruction Books online for all Panasonic Products by visiting our Web Site at:

<http://www.pasc.panasonic.com>

or, send your request by E-mail to:

npcparts@us.panasonic.com

You may also contact us directly at:

1-800-332-5368 (Phone) 1-800-237-9080 (Fax Only)

(Monday - Friday 9 am to 9 pm, EST.)

PANASONIC SERVICE AND TECHNOLOGY COMPANY

20421 84th Avenue South, Kent, WA 98032

(We Accept Visa, MasterCard, Discover Card, American Express, and Personal Checks)

Product Repairs

Centralized Factory Service Center

MAIL TO :

Panasonic Camera and Digital Service Center
 1590 Touhy Ave.
 Elk Grove Village, IL 60007

Please carefully pack and ship, prepaid and insured, to the Elgin Centralized Factory Service Center.

Customer's in Puerto Rico, please ship or carry in to location below ("Service in Puerto Rico").

Service in Puerto Rico

Panasonic Puerto Rico, Inc.:

*Ave. 65 de Infantería, Km. 9.5, San Gabriel Industrial Park,
 Carolina, Puerto Rico 00985*

Phone (787) 750-4300 Fax (787) 768-2910

As of March 2007

Précautions à prendre (pour les clients canadiens)

AVERTISSEMENT:

POUR RÉDUIRE TOUT RISQUE D'INCENDIE, DE CHOC ÉLECTRIQUE OU DE DOMMAGE,

- N'EXPOSEZ PAS CET APPAREIL À LA PLUIE, À L'HUMIDITÉ, AUX GOUTTES OU ÉCLABOUSSURES ET ASSUREZ-VOUS QU'AUCUN OBJET OU VASE REMPLI DE LIQUIDE NE SOIT PLACÉ SUR L'APPAREIL.
- N'UTILISEZ QUE LES ACCESSOIRES RECOMMANDÉS.
- NE PAS RETIRER LE COUVERCLE (OU LE PANNEAU ARRIÈRE) ; AUCUNE PIÈCE INTERNE NE PEUT ÊTRE RÉPARÉE PAR L'UTILISATEUR. CONFIER TOUTE RÉPARATION À UN TECHNICIEN QUALIFIÉ.

LA PRISE DE COURANT DOIT SE TROUVER À PROXIMITÉ DE L'APPAREIL ET ÊTRE FACILEMENT ACCESSIBLE.

MISE EN GARDE

Une batterie de remplacement inappropriée peut exploser. Ne remplacez qu'avec une batterie identique ou d'un type recommandé par le fabricant. L'élimination des batteries usées doit être faite conformément aux instructions du fabricant.

Une inscription se trouve en-dessous de l'appareil.

- Si vous songez à utiliser des piles rechargeables, les piles fabriquées par Panasonic sont recommandées.
- Assurez-vous d'utiliser un adaptateur secteur de marque Panasonic (modèle DMW-AC6; en option).
- N'utilisez pas d'autres câbles de connexion USB à l'exception de celui fourni.
- N'utilisez pas d'autres câbles vidéo à l'exception de celui qui est fourni.
- Conservez la carte mémoire hors de portée des enfants afin qu'ils ne puissent pas l'avaler.

A propos des batteries

- N'exposez pas les piles à la flamme ou à la chaleur.

Évitez d'approcher l'appareil photo de tout équipement magnétisé (four à micro-ondes, téléviseur, équipement de jeux vidéo, etc.).

- Si vous utilisez l'appareil sur ou proche d'un téléviseur, les images de l'appareil photo risquent d'être distordues par le rayonnement électromagnétique.
- N'utilisez pas l'appareil à proximité des téléphones cellulaires qui pourraient créer du bruit vidéo sur les images.
- Le puissant champ magnétique de haut-parleurs ou de moteurs peut endommager les données enregistrées sur support magnétique et distordre les images.
- Le rayonnement électromagnétique produit par les microprocesseurs peuvent nuire au fonctionnement de l'appareil photo et perturber les images.
- Advenant le cas où le fonctionnement de l'appareil serait dérangé ou interrompu par un champ électromagnétique, coupez le contact, retirez les piles ou débranchez l'adaptateur secteur (DMW-AC6; en option). Remettez l'appareil en marche.

N'utilisez pas l'appareil photo à proximité d'un émetteur radio ou de lignes à haute tension.

- L'utilisation de l'appareil photo à proximité d'un émetteur radio ou de lignes à haute tension pourrait perturber les images enregistrées.

Cet appareil numérique de la classe B est conforme à la norme NMB-003 du Canada.

Index

A	
AC adaptor	84, 87, 110
Access indication	24
Aerial photo mode	52
AF Assist Lamp	66
AF/AE Lock	27
AF Mode	63
Alkaline batteries	11
Aspect ratio	62
Auto Review	21
Auto White Balance	60
Available recording time	106
B	
Baby mode	50
Backlight Compensation	29
Batteries	11, 15
Battery type	21
Beach mode	51
Built-in Flash	40
Built-in memory	16
Burst Mode	65
C	
Calendar playback	68
Candle light mode	49
Card	5, 15, 16
Color	26
Color mode	66
Condensation	5
Copy	82
D	
Date Printing	78, 89
Date stamp	75
Deleting Pictures	35
Demonstration of jitter/movement detection screen	64
DIAL DISPLAY	23
Digital Zoom	32
DPOF Print	77
E	
Easy zoom	31
Economy mode	22
Exposure	26, 44
Exposure Compensation	44
Extended optical zoom	30
EZ	30, 63
F	
Favorites setting	73
File number	22, 85
Fine	63
Fireworks mode	52
Focusing	26
Folder Composition	85
Folder number	22, 85
Food mode	49
Formatting	83
G	
Guide line display	37
H	
High angle mode	39
High sensitivity mode	51
Histogram	38
I	
ISO Sensitivity	61
Intelligent ISO mode	45
J	
Jitter	27, 64
L	
Language setting	23
LCD Monitor	4, 24, 37, 92
M	
Macro mode	46
Monitor	22
Motion picture mode	53
Multi Playback	67
N	
Nickel metal hydride batteries	11, 12
Night portrait mode	48
Night scenery mode	49
NO.RESET	22
NTSC	23, 91

Normal picture mode	25	Simple Mode.....	28
Number of Prints	77, 89	Slide Show	72
Number of recordable pictures	13, 104	Snow mode	52
O		Soft skin mode	48
Operational sound	22	Sports mode	48
Optical Image Stabilizer	64	Standard	63
Optical Zoom	30	Starry sky mode	51
Oxyride batteries	11	Status Indicator	25
P		Strap	9
Page layout	90	Sunset mode	50
PAL	23, 91	T	
Paper size	89	Thumbnail.....	34
Party mode	49	Travel date	22, 55
PC	84	Trimming	81
Pet mode	50	TV ASPECT	23
PictBridge	87	U	
Picture Quality Setting (Simple Mode)....	28	USB Connection Cable	84, 87
Picture Quality Setting (Motion Picture Mode)	53	V	
Picture Size	62	Video cable	91
Playback Zoom	69	Video Output	23, 91
Playing Back Motion Pictures	70	W	
Playing Back Pictures with a TV Screen	91	White Balance	60
Portrait mode	48	White set	60
Power save	21	World time	22, 57
Print mode	87	Z	
Protect	79	Zoom	30
Q			
Quality	62		
Quick setting	59		
R			
Reset	23		
Resize	80		
Review	33		
Rotate	74		
Rotate Display	74		
S			
Scene mode	47		
Scenery mode	48		
Self-timer	43		
Setting Date/Time	17, 66		
Setup Menu	21		



QuickTime and the QuickTime logo are trademarks or registered trademarks of Apple Computer, Inc., used under license therefrom.

**Panasonic Consumer Electronics Company,
Division of Panasonic Corporation of North America**
One Panasonic Way, Secaucus, NJ 07094

Panasonic Puerto Rico, Inc.
Ave. 65 de Infantería, Km. 9.5, San Gabriel Industrial Park, Carolina, Puerto Rico 00985

Panasonic Canada Inc.
5770 Ambler Drive, Mississauga, Ontario, L4W 2T3

© 2007 Matsushita Electric Industrial Co., Ltd.



VQT1C63-1
H1206CK1017

