

Panasonic®

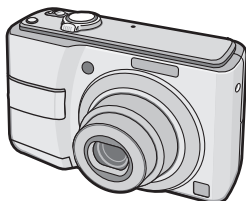

Operating Instructions Digital Camera

Model No. **DMC-LS80**



Before connecting, operating or adjusting this product, please read the instructions completely.

For USA assistance, please call: 1-800-211-Pana (7262) or, contact us via the web at:
<http://www.panasonic.com/contactinfo>

For Canadian assistance, please call: 1-800-99-LUMIX (1-800-995-8649) or
send e-mail to: lumixconciierge@ca.panasonic.com



VQT1L50

Dear Customer,

Thank you for choosing Panasonic!

You have purchased one of the most sophisticated and reliable products on the market today. Used properly, we're sure it will bring you and your family years of enjoyment. Please take time to fill in the information in the box below.

The serial number is on the tag located on the underside of your Camera. Be sure to **retain this manual** as your convenient Camera information source.

Model No. _____

Serial No. _____

Information for Your Safety

WARNING:

TO REDUCE THE RISK OF FIRE, ELECTRIC SHOCK OR PRODUCT DAMAGE,

- DO NOT EXPOSE THIS APPARATUS TO RAIN, MOISTURE, DRIPPING OR SPLASHING AND THAT NO OBJECTS FILLED WITH LIQUIDS, SUCH AS VASES, SHALL BE PLACED ON THE APPARATUS.
- USE ONLY THE RECOMMENDED ACCESSORIES.
- DO NOT REMOVE THE COVER (OR BACK); THERE ARE NO USER SERVICEABLE PARTS INSIDE. REFER SERVICING TO QUALIFIED SERVICE PERSONNEL.

Carefully observe copyright laws. Recording of pre-recorded tapes or discs or other published or broadcast material for purposes other than your own private use may infringe copyright laws. Even for the purpose of private use, recording of certain material may be restricted.

- Please note that the actual controls and components, menu items, etc. of your Digital Camera may look somewhat different from those shown in the illustrations in these Operating Instructions.
- SDHC Logo is a trademark.
- Other names, company names, and product names printed in these instructions are trademarks or registered trademarks of the companies concerned.

THE SOCKET OUTLET SHALL BE INSTALLED NEAR THE EQUIPMENT AND SHALL BE EASILY ACCESSIBLE.

CAUTION

Danger of explosion if battery is incorrectly replaced. Replace only with the same or equivalent type recommended by the manufacturer. Dispose of used batteries according to the manufacturer's instructions.

Product Identification Marking is located on the bottom of unit.

THE FOLLOWING APPLIES ONLY IN THE U.S.A.

FCC Note:

This equipment has been tested and found to comply with the limits for a Class B digital device, pursuant to Part 15 of the FCC Rules. These limits are designed to provide reasonable protection against harmful interference in a residential installation. This equipment generates, uses, and can radiate radio frequency energy and, if not installed and used in accordance with the instructions, may cause harmful interference to radio communications. However, there is no guarantee that interference will not occur in a particular installation. If this equipment does cause harmful interference to radio or television reception, which can be determined by turning the equipment off and on, the user is encouraged to try to correct the interference by one or more of the following measures:

- Reorient or relocate the receiving antenna.
- Increase the separation between the equipment and receiver.
- Connect the equipment into an outlet on a circuit different from that to which the receiver is connected.
- Consult the dealer or an experienced radio/TV technician for help.

FCC Caution: To assure continued compliance, follow the attached installation instructions and use only shielded interface cables with ferrite core when connecting to computer or peripheral devices.

Any changes or modifications not expressly approved by the party responsible for compliance could void the user's authority to operate this equipment.

Declaration of Conformity

Trade Name: Panasonic
 Model No.: DMC-LS80
 Responsible party: Panasonic Corporation of North America
 One Panasonic Way,
 Secaucus, NJ 07094
 Support Contact: Panasonic Consumer Electronics Company
 1-800-211-PANA(7262)

This device complies with Part 15 of the FCC Rules. Operation is subject to the following two conditions: (1) This device may not cause harmful interference, and (2) this device must accept any interference received, including interference that may cause undesired operation.



THE FOLLOWING APPLIES ONLY IN CANADA.

This Class B digital apparatus complies with Canadian ICES-003.

-If you see this symbol-

Information on Disposal in other Countries outside the European Union



This symbol is only valid in the European Union. If you wish to discard this product, please contact your local authorities or dealer and ask for the correct method of disposal.

■ Care for the camera

- **Do not strongly shake or bump the camera.** The camera may not be operated normally, recording of pictures may be disabled or the lens and the LCD monitor may be damaged.
- **Sand or dust may cause the camera to malfunction. Make sure that sand or dust does not get into the lens, the flash or the terminals when using the camera on a beach etc.**
- Make sure that water does not get into the camera when using it on a rainy day or on a beach.
- **This camera is not waterproof. In case the camera comes into contact with water, wipe it off with a dry cloth. When the camera does not operate normally, contact your dealer or your nearest Service Center.**

■ About the LCD monitor

- **Do not press the LCD monitor with excessive force. Uneven colors may appear on the LCD monitor and it may malfunction.**
- Condensation may form on the LCD monitor in places with large temperature differences. Wipe the condensation with a soft, dry cloth.
- If the camera is cold when you turn it on, the picture on the LCD monitor will be slightly darker than usual at first. However, the picture will return to normal brightness when the internal temperature of the camera increases.

Extremely high precision technology is employed to produce the LCD monitor screen. However there may be some dark or bright spots (red, blue or green) on the screen. This is not a malfunction. The LCD monitor screen has more than 99.99% effective pixels with a mere 0.01% of the pixels inactive or always lit. The spots will not be recorded in pictures stored in the built-in memory or a card.

■ About the Lens

- Do not press the lens or the lens barrel with excessive force.
- Do not leave the camera with the lens facing the sun as rays of light from the sun may cause it to malfunction. Also, be careful when you leave the camera outside or near a window.

■ About Condensation (When the lens is fogged up)

- Condensation occurs when the ambient temperature or humidity changes as described below. Be careful of condensation since it causes lens stains, fungus and camera malfunction.
 - When the camera is taken from the cold outdoors to the warm indoors
 - When the camera is taken from outside to inside an air-conditioned car
 - When cool wind from an air conditioner etc. blows directly on the camera
 - In humid places
- To prevent condensation, put the camera in a plastic bag until the temperature of the camera is close to the ambient temperature. If condensation occurs, turn the camera off and leave it for about 2 hours. The fog will disappear naturally when the temperature of the camera becomes close to the ambient temperature.

■ When not using the camera for a long period of time



- Store the batteries in a cool and dry place with a relatively stable temperature. [Recommended temperature: 15 °C to 25 °C (59 °F to 77 °F), Recommended humidity: 40% to 60%]
- Always remove the batteries and the card from the camera.
- If the batteries are left inserted in the camera they will discharge as a weak electric current passes through them even if the camera is turned off. [Read P12 for information about Ni-MH (nickel metal hydride) batteries.]
- We recommend storing the camera with a desiccant (silica gel) when you keep it in a closet or a cabinet.

■ About cards that can be used in this unit

You can use an SD Memory Card, an SDHC Memory Card and a MultiMediaCard.

- When the term **card** is used in these operating instructions this refers to the following types of Memory Cards.
 - SD Memory Card (8 MB to 2 GB)
 - SDHC Memory Card (4 GB to 16 GB)
 - MultiMediaCard
- More specific information about memory cards that can be used with this unit.
- When you use a card of 4 MB or more capacity, you can use only the SDHC Memory Card with SDHC logo that is based on the SD Standard.
 - A MultiMediaCard is compatible with still pictures only.

Before Use	
Information for Your Safety.....	2
Preparation	
Standard Accessories.....	8
Names of the Components.....	9
Quick Guide.....	10
About the Batteries.....	11
Inserting/Removing the Batteries/ Card (Optional).....	15
About the Built-in Memory/the Card.....	16
Setting Up the Clock (Turning the camera [ON] for the first time).....	17
Checking the clock setting.....	17
Changing the clock setting.....	17
Basics of Modes and Menus.....	18
About the mode.....	18
About the menu.....	19
Basic settings (Setup menu).....	20
BATTERY TYPE.....	21
CLOCK SET.....	21
WORLD TIME.....	21
MONITOR.....	21
LCD MODE.....	21
BEEP.....	21
GUIDE LINE.....	21
TRAVEL DATE.....	21
ECONOMY.....	22
AUTO REVIEW.....	22
NO.RESET.....	22
RESET.....	23
USB MODE.....	23
VIDEO OUT.....	23
TV ASPECT.....	23
SCENE MENU.....	23
FORMAT.....	23
LANGUAGE.....	24
DEMO MODE.....	24
LCD Monitor and Changes to the Display.....	25

Basic	
Taking Pictures Easily ( Intelligent Mode).....	26
Taking Pictures in the Desired Setting ( Normal Picture Mode).....	28
Photography basics – exposure, focus, and color.....	29
Taking Pictures with the Zoom.....	31
Using the optical zoom / the extended optical zoom (EZ).....	31
Using the easy zoom button.....	32
Using the digital zoom.....	33
Playing Back Pictures ( Normal playback mode).....	34
Deleting Pictures.....	35

Advanced-Shooting	
About the LCD Monitor.....	37
Changing the information displayed ...	37
Making the LCD monitor easier to see (LCD mode).....	38
Taking Pictures Using the Built-in Flash.....	39
Taking Close-up Pictures (AF  Macro Shooting).....	42
Taking Pictures with the Self-timer.....	43
Compensating the Exposure.....	44
Auto Bracket Recording.....	45
Scene Mode.....	46
Portrait mode.....	47
Soft skin mode.....	47
Self portrait mode.....	47
Scenery mode.....	47
Sports mode.....	48
Night portrait mode.....	48
Night scenery mode.....	48
Food mode.....	48
Party mode.....	49
Candle light mode.....	49
Baby mode 1.....	49
Baby mode 2.....	49
Pet mode.....	50
Sunset mode.....	50
High sensitivity mode.....	50
High-speed burst mode.....	50

Starry sky mode	51
Fireworks mode	52
Beach mode	52
Snow mode	52
Aerial photo mode	52
Motion Picture Mode	53
Vacation Date Recording	55
Displaying the Time at the Travel	
Destination	57
Using the [REC] Mode Menu	59
[PICTURE SIZE] / [QUALITY]	60
[ASPECT RATIO]	61
[INTELLIGENT ISO]	61
[SENSITIVITY]	62
[WHITE BALANCE]	62
[AF MODE] / [QUICK AF]	64
[BURST]	65
[COLOR MODE]	65
[STABILIZER]	66
[AF ASSIST LAMP]	66

Advanced-Viewing

Displaying Multiple Screens	
(Multi Playback)	67
Displaying Pictures by Recording Date	
([CAL] CALENDAR)	68
Using the Playback Zoom	69
Playing Back Pictures Automatically	
([▶] Slide Show)	70
Searching by Recording Information	
([▶] Category Play)	71
Playing Back Your Favorite Pictures	
(★ Favorite Play)	72
Playing Back Motion Pictures	73
Using the [PLAYBACK] Mode Menu	74
[CALENDAR]	74
[TITLE EDIT]	74
[TEXT STAMP]	76
[RESIZE]	78
[TRIMMING]	79
[ASPECT CONV.]	80
[ROTATE] / [ROTATE DISP.]	81
[FAVORITE]	82
[DPOF PRINT]	83
[PROTECT]	85
[COPY]	86

Connecting to other equipment

Connecting to a PC	87
Connecting to a PictBridge-compliant	
Printer	90
Playing Back Pictures with a	
TV Screen	94

Others

Screen Display	95
Cautions for Use	97
Message Display	99
Troubleshooting	101
Number of Recordable Pictures and	
Available Recording Time	107
Specifications	110
Digital Camera Accessory System	113
Digital Camera Accessory Order Form	
(For USA Customers)	114
Request for Service Notice	
(For USA Only)	115
Limited Warranty (For USA Only)	116
Customer Services Directory	
(For USA Only)	118
Précautions à prendre	
(Pour le Canada seulement)	119
Index	121

Standard Accessories

Before using your camera, check the contents.

■ Batteries

AA Alkaline batteries (LR6)

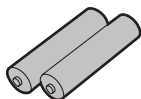

■ AV Cable

K1HA08CD0027



■ USB Connection Cable

K1HA08CD0023



■ CD-ROM



■ Strap

VFC4297

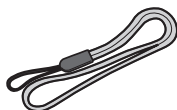

• Card is optional.

You can record or play back pictures on the built-in memory when you are not using a card.

- For information about optional accessories, please refer to "Digital Camera Accessory System". (P113)
- If any of the accessories are lost, customers in the USA should contact Panasonic's parts department at 1 800 833-9626 and customers in Canada should contact 1 800 99-LUMIX (1-8-995-8649) for further information about obtaining.

■ About illustrations in these operating instructions

Please note that the appearance of the product, the illustration or the menu screen are a little different from those in actual use.

Names of the Components

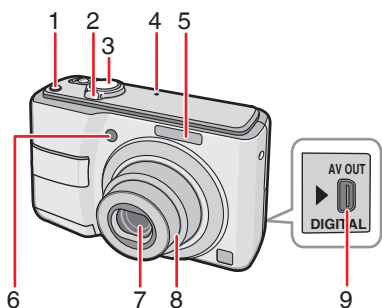

- 1 [E. ZOOM] (Easy zoom) button (P32)
- 2 Zoom lever (P31)
- 3 Shutter button (P26, 53)
- 4 Microphone (P53)
- 5 Flash (P39)
- 6 Self-timer indicator (P43)
- 7 AF assist lamp (P66)
- 8 Lens part
- 8 Lens barrel
- 9 [AV OUT/DIGITAL] socket (P87, 90, 94)
- 10 LCD monitor (P37, 95)
- 11 Recording/playback switch (P18)
- 12 [MENU/SET] button (P17)
- 13 Camera ON/OFF switch (P17)
- 14 [MODE] button (P18)
- 15 Cursor buttons

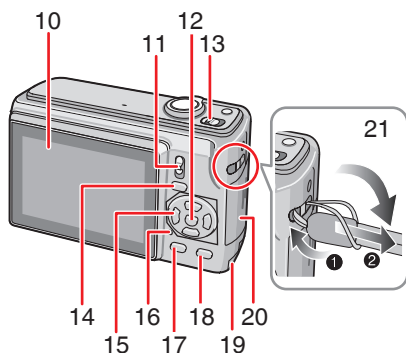

- ◀ /Self-timer button (P43)
- ▼ /Macro button (P42)
- ▶ /Flash mode button (P39)
- ▲ /Exposure compensation (P44)
- /Auto bracket (P45) /Backlight compensation (P27) button
- In these operating instructions, operations using the cursor buttons are described as follows.

e.g.: When you press the ▼ button.

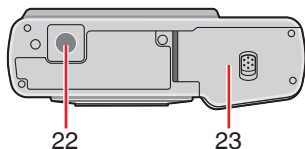
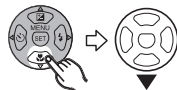

22 Tripod receptacle

- When you use a tripod, make sure the tripod is stable with the camera attached to it.

23 Battery door (P15)

- 16 Status indicator (P15, 22, 25)
- 17 [DISPLAY] button (P37)
- 18 [Q.MENU] (P59) /Delete (P35) button
- 19 DC coupler door (P87, 90, 113)
- 20 Card door (P15)
- 21 Strap eyelet

- Attach the strap when using the camera to prevent it from dropping.

Quick Guide

This is the overview of the procedure to record pictures with this camera. For each operation, be sure to refer to the corresponding pages.

1 Insert the batteries.

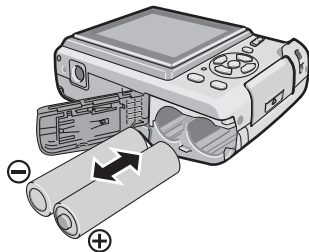

- When you do not use the card (optional), you can record or play back pictures on the built-in memory. Refer to P16 when you use a card.

2 Turn the camera on to take pictures.

- Set the clock. (P17)
- Select the type of battery in use in [BATTERY TYPE] in the [SETUP] menu. (P21)

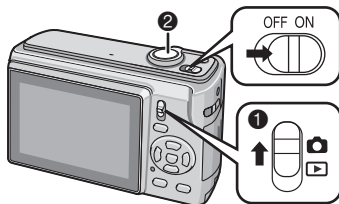

- 1 Set the recording/playback switch to [📷].
- 2 Press the shutter button to take pictures. (P28)

3 Play back the pictures.

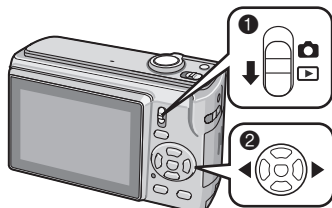

- 1 Set the recording/playback switch to [▶].
- 2 Select the picture you want to view. (P34)

About the Batteries

■ Usable batteries

AA Alkaline batteries (supplied)
AA Rechargeable Ni-MH (nickel metal hydride) batteries (optional)
AA Oxyride batteries (optional)

- One of the following messages appears when you insert batteries for the first time, change the batteries when they become exhausted etc. [CURRENT BATTERY TYPE SETTING: ALKALINE/Ni-MH] / [CURRENT BATTERY TYPE SETTING: OXYRIDE] If the batteries inserted are different from the type displayed in the message, set [BATTERY TYPE] in the [SETUP] menu. (P21)
- The battery type that is set can be distinguished by the color of the battery indication (white or blue).

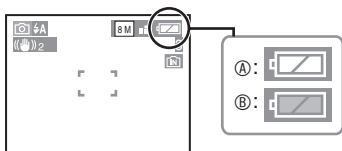

- Ⓐ When alkaline/Ni-MH batteries are selected
The battery indication turns white.
- Ⓑ When oxyride batteries are selected
The battery indication turns blue.
- We recommend using Panasonic batteries.
- Battery performance may vary greatly depending on the brand used and the storage life and conditions of the batteries.
- Battery performance temporarily deteriorates in low temperature conditions [10 °C (50 °F) or less]. However, it recovers when the temperature returns to normal.

- Depending on the temperature and the conditions of use, the camera may not operate properly and the batteries may become exhausted without warning because the battery indication is not displayed correctly. This is not a malfunction.
- We recommend turning the camera off frequently while recording to conserve battery power for longer battery life. If you will be using the camera for long periods of time, using rechargeable Ni-MH batteries is recommended.
- Exhausted batteries may recover some performance if left for a period of time. However, they cannot be used for a long time. Be sure to replace them with new batteries.

■ Unusable batteries

Manganese batteries	Lithium batteries
Nickel batteries	Ni-Cd batteries

- Operation is not guaranteed when using the batteries listed above. The batteries can leak and the following malfunctions can occur:
 - The remaining battery power is not displayed accurately.
 - The camera does not turn on.
 - Data written to the built-in memory or the card is damaged resulting in loss of the photographs.

■ Battery shapes that cannot be used

- Batteries with unusual shapes cause leakage, heat generation or explosion if inserted in the camera.
- Batteries with the covering partly or fully peeled off. Never use these batteries. (Refer to the illustration below.)

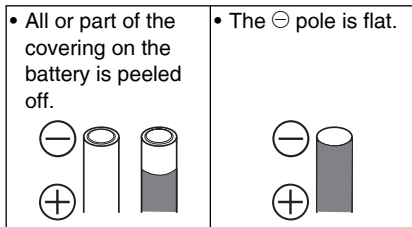

■ Proper Care and Handling of Batteries

Mishandling batteries may cause leakage, heat generation, fire or explosion. Observe the following.

- Do not heat or expose to flame.
- Do not leave the batteries in an automobile exposed to direct sunlight for a long period of time with doors and windows closed.
- Do not splash batteries with water/sea water or wet battery terminals.
- Do not peel off or scratch the covering on batteries.
- Do not drop, throw or subject batteries to other strong impacts.
- Do not use batteries that show signs of leakage, deformation, discoloration etc.
- Do not store batteries in high humidity areas or high temperatures.
- Keep batteries away from children.
- Always use 2 new batteries of the same type when replacing batteries.
- Remove the batteries if you do not intend to use the unit for a long time.
- Batteries may heat up soon after you start using the unit. Turn the camera off and wait until the battery temperature decreases before removing them.
- Battery performance deteriorates and recording/playback time decreases when

the ambient temperature is low [10 °C (50 °F) or less]. This is particularly true when using alkaline or oxyride batteries so warm them in your pocket etc. before using them. Make sure that no metal objects such as a lighter are placed together with the batteries when warming them in your pocket.

- If there is grease or dirt on the battery poles, the recording/playback time may become extremely short. Before inserting the batteries, clean the battery terminals with a soft, dry cloth.

If battery leakage occurs, remove the batteries and thoroughly wipe the leakage in the battery compartment. Insert new batteries or fully charged Ni-MH batteries.

If battery electrolyte spills on your hands or clothes, thoroughly wash them with water. Battery electrolyte can cause loss of sight if it comes into contact with your eyes. Do not rub your eyes. Wash them immediately with clean water and consult a doctor.

■ Ni-MH Batteries (Nickel Metal Hydride)

You can use Ni-MH batteries after charging them with a nickel metal hydride battery charger. However, improper handling of the batteries may cause leakage, heat generation, fire or explosion. Observe the following.

- If rechargeable batteries are to be used, rechargeable batteries manufactured by Panasonic are recommended.
- If there is dirt on the battery poles, you may not be able to charge normally. Clean the battery poles and the battery recharger terminals with a soft, dry cloth.
- When charging batteries for the first time, or after having not used them for a long period of time, they may not charge fully. This is a feature of Ni-MH batteries and is not a malfunction. Battery performance will become normal after a few charges

and discharges.

- We recommend charging the batteries after they are fully discharged. If you charge the batteries before they are fully discharged, it can reduce battery performance. This is called “memory effect”.
- If “memory effect” occurs, continue using the batteries until the camera stops working and then charge them fully. Battery performance will be restored after a few charges and discharges.
- Over time Ni-MH batteries naturally discharge and their capacity lowers even when they are not used.
- Once the batteries have reached full charge, do not continue to charge them.
- Do not peel off or scratch the covering on Ni-MH batteries.
- Read the operating instructions for the battery charger.

Ni-MH batteries have a limited life. Battery capacity gradually decreases over time. If the length of time you can use the camera is extremely short even after fully charging the batteries, they may have exceeded their life span. Purchase new batteries.

- Battery life differs depending on the conditions of storage and usage and the environment.

When not using the batteries for a long period of time

- If the batteries are left in the camera they will discharge. This is because a small electrical current continues to flow even when the camera is turned off. If the batteries continue to be left in the camera, they will discharge excessively and may become unusable even if charged.
- When storing the batteries for a long period of time, we recommend charging them once a year. Remove the batteries from the camera and store them again after they have completely discharged.

■ Battery life

The number of recordable pictures (By CIPA standard in normal picture mode )

Batteries Used	Number of recordable pictures (Approx.)
Panasonic Alkaline batteries (supplied or optional)	180 pictures (90 min)
Fully charged Panasonic Ni-MH batteries (optional)	470 pictures (235 min)
Panasonic Oxyride batteries (optional)	270 pictures (135 min)

Recording conditions by CIPA standard

- Temperature: 23 °C (73.4 °F)/ Humidity: 50% when the LCD monitor is on*1.
 - Using a Panasonic SD Memory Card (16 MB)
 - Starting recording 30 seconds after the camera is turned on. (When the optical image stabilizer function is set to [MODE2])
 - **Recording once every 30 seconds**, with full flash every second recording.
 - Rotating the zoom lever from Tele to Wide or vice versa in every recording.
 - Turning the camera off every 10 recordings./Leaving the camera until the batteries cool down.
- *1 The number of recordable pictures decreases when the auto power LCD, power LCD or high angle mode is used (P38).
- CIPA is an abbreviation of [Camera & Imaging Products Association].

The number of recordable pictures varies depending on the recording interval time. If the recording interval time becomes longer, the number of recordable pictures decreases. (e.g. When recording once every 2 minutes: about 1/4 the number when recording once every 30 seconds)

The number of recordable pictures in low temperatures (In normal picture mode [📷] when the temperature is 0 °C (32 °F) and other recording conditions comply with CIPA standard.)

Batteries Used	Number of recordable pictures (Approx)
Panasonic Alkaline batteries (supplied or optional)	40 pictures (20 min)
Fully charged Panasonic Ni-MH batteries (optional)	390 pictures (195 min)
Panasonic Oxyride batteries (optional)	50 pictures (25 min)

- Please note that the performance of alkaline batteries and oxyride batteries significantly decreases in low temperature conditions.

Playback time

Batteries Used	Continuous playback time (Approx.)
Panasonic Alkaline batteries (supplied or optional)	420 min
Fully charged Panasonic Ni-MH batteries (optional)	610 min
Panasonic Oxyride batteries (optional)	430 min



- The number of recordable pictures and playback time will vary depending on the operating conditions and how the battery is stored.
- The number of recordable pictures and the playback time will also vary depending on the brand and type of batteries used.
- We recommend using economy mode (P22) or turning off the camera frequently while recording to maintain battery power.

Inserting/Removing the Batteries/Card (Optional)

- Check that the camera is turned off.
- Use alkaline batteries (supplied), Ni-MH batteries (optional) or oxyride batteries (optional).
- Prepare a card.
- **You can record or play back pictures on the built-in memory when you are not using a card. (P16)**

1 Slide the battery door **A** or the card door **B** to open it.

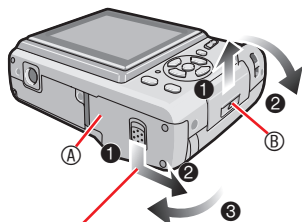

Press and keep the lever down and slide the door.

2 Batteries:

Insert the batteries with the \oplus and \ominus poles aligned correctly.

Card:

Insert the card with the label side facing the back of the camera until it clicks and locks.

To remove the card, push the card until it clicks, then pull the card out upright.

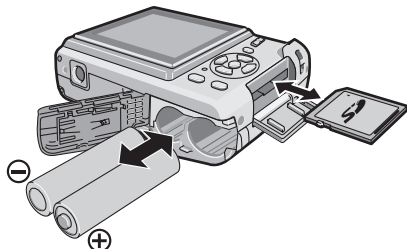

- Do not touch the connection terminals on the back side of the card.

- The card may be damaged if it is not fully inserted.

- 1 **Close the battery door or the card door.**
- 2 **Slide the battery door or the card door to the end and then close it firmly.**

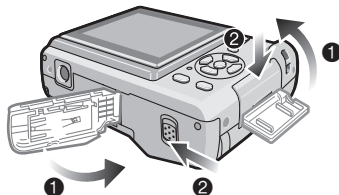

- If the card door cannot be completely closed, remove the card, check its direction and insert it again.



- **Select the battery type being used in [BATTERY TYPE] in the [SETUP] menu. (P21)**
- Remove the batteries after use.
- **Remove the batteries after the LCD monitor and the status indicator (green) turn off. Otherwise, the settings on the camera may not be stored properly.**
- **Do not remove or insert the batteries or the card while the unit is on, particularly while accessing the built-in memory or the card. This can damage data.**
- **We recommend using Panasonic's SD Memory Card/SDHC Memory Card.**

About the Built-in Memory/the Card

The built-in memory can be used as a temporary storage device when the card being used becomes full.

■ Built-in Memory []

You can record or play back pictures on the built-in memory when you are not using a card. (The built-in memory cannot be used when a card is inserted.)

- You can copy pictures from the built-in memory to a card (P86).
- The built-in memory capacity is about 24 MB.
- Picture size is fixed to QVGA (320 × 240 pixels) when recording motion pictures to the built-in memory.

■ Card []

You can record or play back pictures on a card.

■ About SD Memory Card (optional), SDHC Memory Card (optional) and MultiMediaCard (optional)

- The SD Memory Card, the SDHC Memory Card and the MultiMediaCard are small, lightweight, removable external memory cards. Read P5 for information about cards that can be used in this unit.
- The SDHC Memory Card is a memory card standard decided by the SD Association in 2006 for high capacity memory cards more than 2 GB.
- The reading/writing speed of the SD Memory Card and the SDHC Memory Card is fast. The SD Memory Card and the SDHC Memory Card are equipped with a Write-Protect switch  that can inhibit writing and formatting. (When the switch is slid to the [LOCK] side, it is not possible to write or delete data on the card and format it. When the switch is unlocked, these functions become available.)



- This unit supports SD Memory Cards formatted in the FAT12 and FAT16 systems that comply with SD Memory Card Specifications. It also supports SDHC Memory Cards formatted in the FAT32 system.
- This unit (SDHC compliant equipment) supports both SD Memory Cards and SDHC Memory Cards. You can use SDHC Memory Cards on equipment that supports them. You cannot use SDHC Memory Cards on equipment that supports SD Memory Cards only. (When you use SDHC Memory Cards on other equipment, make sure to read the equipment's operating instructions. If you intend to have your pictures printed by someone, first find out if they are able to use SDHC Memory Cards.)

Please confirm the latest information on the following website.

<http://panasonic.co.jp/pavc/global/cs>

(This site is in English only.)

- Refer to P107 for the number of recordable pictures and available recording time on a card.
- Use the high speed SD Memory Card or the high speed SDHC Memory Card for motion picture recording.



- Save important data in such places as your PC as well. Electromagnetic waves, static electricity, unit malfunctions, card damages and other factors may destroy or erase data.
- If the card was formatted on a PC or other equipment, format it again on the camera. (P23)
- Keep the Memory Card out of reach of children to prevent swallowing.

Setting Up the Clock (Turning the camera [ON] for the first time)

■ Initial setting

The clock is not set when the camera is shipped. When you turn the camera on, the following screen appears. (It does not appear in playback mode.)

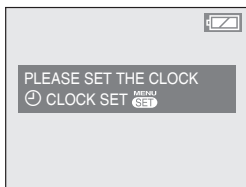
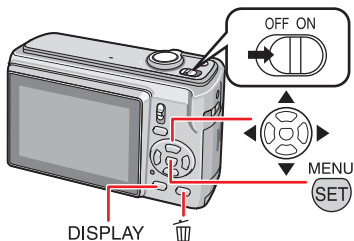

1 Press [MENU/SET].

2 Press ▲/▼/◀/▶ to select the date and time.

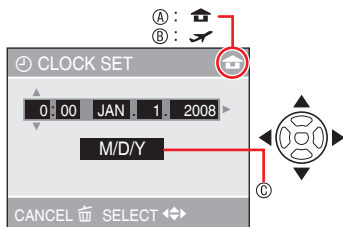

- Ⓐ Time at the home area
- Ⓑ Time at the travel destination (P57)
- Ⓒ Appearance
- ◀/▶ : Select the desired item.
- ▲/▼ : Set date, time and the display order for the date and time.
- 🗑️ : To cancel without setting the clock.

3 Press [MENU/SET].

- When [MENU/SET] has been pressed to complete the settings without the clock having been set, set the clock correctly by following the “Changing the clock setting (In normal picture mode)” procedure below.

Checking the clock setting

Press [DISPLAY] several times.

- Current date and time will be displayed on the bottom left of the screen for about 5 seconds.

Changing the clock setting

- 1 Press [MENU/SET].
 - 2 Press ▲/▼ to select [CLOCK SET].
 - 3 Press ▶ and perform steps 2 and 3 for setting.
 - 4 Press [MENU/SET] to close the menu.
- You can also set the clock in the [SETUP] menu. (P20)



- When batteries have been inserted for more than 3 hours, the clock setting is stored in the camera for approximately 3 months even if the batteries are removed.
- You can set the year from 2000 to 2099. The 24-hour system is used.
- Set the date so that the correct date is printed when you order prints or use the text stamp.
- If the clock is set, the correct date can be printed even if the date is not displayed on the screen of the camera.

Basics of Modes and Menus

About the mode

Selecting recording modes or playback mode.

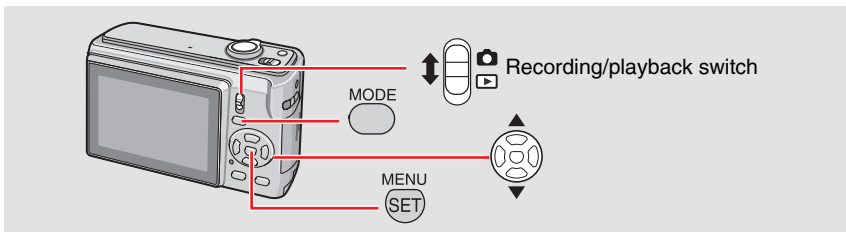

- 1** Slide the recording/playback switch to (up) or (down).

: Recording mode
 : Playback mode

- 2** Press [MODE] to display the mode selection screen.
 (Example: Normal picture mode)

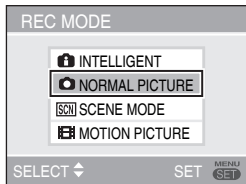

- 3** Select a mode using / and press [MENU/SET] to close the menu.

Refer to corresponding page for more details on each mode. (Right)

Recording mode



Intelligent mode	P26
Taking pictures easily.	
Normal picture mode	P28
Taking pictures in the desired setting.	
Scene mode	P46
Taking pictures according to the scene.	
Motion pictures mode	P53
This mode allows you to record motion pictures.	

Playback mode

Normal playback mode	P34
Playing back the pictures normally.	
Slide show mode	P70
Playing back the pictures continuously.	
Category playback mode	P71
Playing back the pictures by recorded information.	
Favorite playback mode	P72
Playing back the pictures set as your favorite.	
<ul style="list-style-type: none"> • Pictures do not appear when the [FAVORITE] is set to [OFF] 	

About the menu

This camera contains various menus to enable you to setup your own preferences for recording and playing. Displayed menu items vary depending on each mode.

 Setup menu (Common in recording mode / playback mode)	P20
To setup the default setting of the camera, such as the batteries, clock, etc.	
 Recording menu (Only in recording mode)	P59
To setup the picture size, ISO sensitivity, etc.	
 Playback menu (Only in playback mode)	P74
To setup the preference for editing, printing (DPOF), etc.	

■ Changing the menu settings

Example shown below describes how to set recording menu (in normal picture mode )

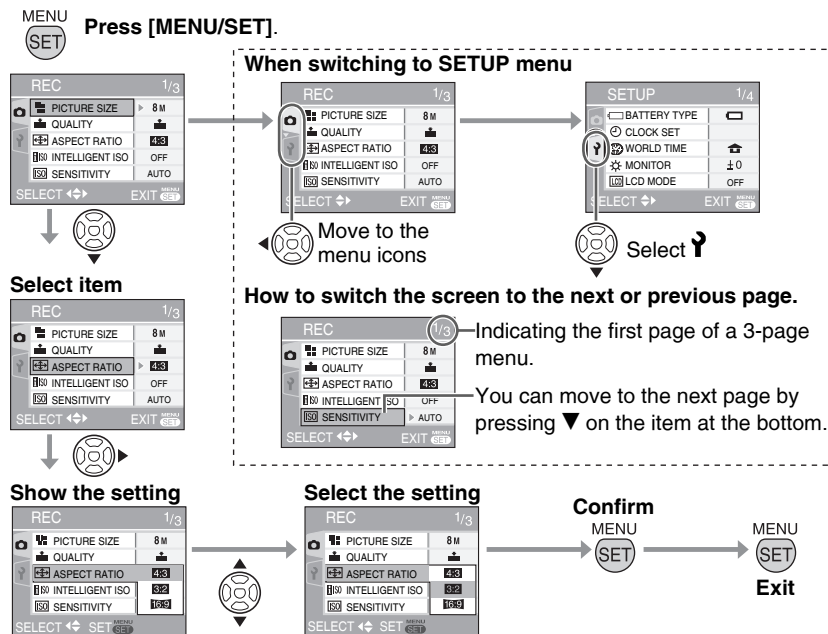

Basic settings (Setup menu)

Setting up the preference of battery type, clock, economy mode, etc.

Make sure to set [BATTERY TYPE].

- If the type of battery being used and the type of battery selected are not the same, the battery indication will not be displayed correctly. The battery life may also become shorter.
- We recommend confirming the settings for [CLOCK SET], [AUTO REVIEW] and [ECONOMY].

1 Press [MENU/SET].

- The displayed menu depends on the recording mode. (Example: When normal picture mode [📺] is selected.)

2 Press ◀ and select an icon ☹ using ▼.

- SETUP menu screen appears.

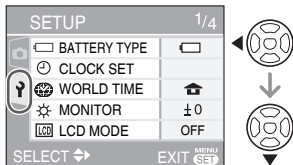

3 Press ▶ and select the item using ▲/▼.

- You can turn to the next page by pressing ▼ on the item at the bottom. You can turn the pages by rotating the zoom lever.
- Refer to P21-24 for more details on menu items.

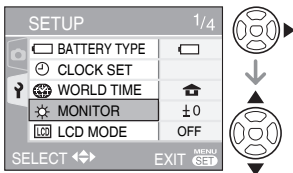

4 Press ▶ and select settings using ▲/▼.

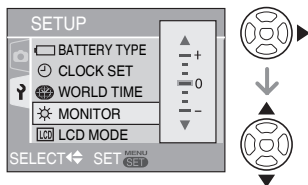

- The further items will be displayed depending on items. Press ▶ again, and select the settings using ▲/▼.



5 Press [MENU/SET] to confirm the setting, and press it again (several times) to close the menu.





- Items set are limited for intelligent mode [📺].

Press  to display menu, enter the setup menu [] and select the item. (P20)
The setting marked “▶” means it is the initial setting.



Select the type of batteries you have inserted.
BATTERY TYPE

Select the type of battery being used from the following 2 types.

- ▶  **ALKALINE (LR6)/Ni-MH**
-  **OXYRIDE (ZR6)**



- If the type of battery being used and the type of battery selected are not the same, the battery indication will not be displayed correctly.



Set the date and time.
CLOCK SET (P17)

Change date and time.



WORLD TIME (P57)

Set date and time at your home area and the travel destination.

- ✈ : The local time at the travel destination
- ▶  : The time at your home area





MONITOR

Adjust the brightness of the LCD monitor in 7 steps.



LCD MODE (P38)

Set to make the LCD monitor easier to see.

- ▶ OFF
-  : AUTO POWER LCD
-  : POWER LCD
-  : HIGH ANGLE





- In playback mode, only [OFF] or [POWER LCD] is selectable.



BEEP

Set to select the volume of operational sound.

-  : No operational sound
- ▶  : Soft operational sound
-  : Loud operational sound



GUIDE LINE (P37)

REC. INFO.

Set whether recording information is displayed with guide lines.

- ▶ OFF
- ON

PATTERN

Select the pattern of the guide lines.

- ▶ 
- 



TRAVEL DATE (P55)

Set the departure and return dates.

- ▶ OFF
- SET

Press [**MENU**] to display menu, enter the setup menu [**?**] and select the item. (P20)
The setting marked “▶” means it is the initial setting.

ECO

Restrict battery consumption ECONOMY

POWER SAVE

If you perform no operations, the camera turns off automatically after the interval you set.

OFF
1 MIN.
2 MIN.
▶ 5 MIN.
10 MIN.



- Press the shutter button halfway or restart the camera to cancel.
- Power save is fixed to [5 MIN.] in intelligent mode [**i**].
- This function is not activated in the following cases.
 - When connected to the PC / printer
 - While recording / playing back motion pictures
 - While performing slide show

AUTO LCD OFF

LCD monitor is turned off automatically while the camera is not in use for the set time. (in recording mode only)

▶ OFF
15 SEC.
30 SEC.



- The status indicator lights while the LCD monitor is turned off. Press any button to turn on the LCD monitor again.
- This function is not activated in the following cases.
 - While a menu screen is displayed
 - While the self-timer is set
 - While recording motion pictures



Show images you have taken. AUTO REVIEW

Adjust how long the recorded picture automatically appears on the screen.

OFF
1 SEC.
▶ 2 SEC.
HOLD
ZOOM





- When [HOLD] is selected, the picture remains on the display. Press [MENU/SET] to cancel.
- When [ZOOM] is set, the picture is displayed for 1 second, then at 4 × zoom for further 1 second.
- AUTO REVIEW works even if set to [OFF] in [AUTO BRACKET], [BURST] or [HI-SPEED BURST]. However, [HOLD] and [ZOOM] are disabled.
- You can not change settings in [AUTO BRACKET], [BURST], [SELF PORTRAIT], [HI-SPEED BURST] and motion picture modes [**M**].
- Fixed to [2 SEC.] in Intelligent mode [**i**].



NO.RESET

Set this when you want to start the file number of the picture from 0001 on the next recording.

- The folder number is updated, and the file number starts from 0001.
- The folder number can be assigned from 100 to 999. When the folder number reaches 999, it cannot be reset. We recommend formatting the card after saving the data on a PC or elsewhere.
- To reset the folder number to 100, you must first reformat the built-in memory or the card. After this perform [NO.RESET] to reset the file number, after which a screen appears asking whether you want to reset the folder number. Select [YES].

Press  to display menu, enter the setup menu [] and select the item. (P20)
The setting marked “▶” means it is the initial setting.

RESET



The settings on the recording or the [SETUP] menu are reset to the initial settings.



- When you reset the settings on the recording in recording mode, lens is also placed back to initial position. Despite the lens operation noise will be occurred, this is not malfunction
- When you reset the SETUP settings, following settings are also initialized.
 - Birthday and name settings in [BABY] and [PET] mode
 - The number of days that have passed since the departure date for [TRAVEL DATE]
 - [WORLD TIME] setting
- [FAVORITE] is fixed to [OFF], and [ROTATE DISP.] is fixed to [ON].
- The battery type setting, the folder number and the clock setting are not changed.

USB MODE (P87, 90)

Set the USB mode to be used when connecting the camera to a computer or a printer.

- ▶  **SELECT ON CONNECTION**
- ▶  **PictBridge (PTP)**: Connects the camera to a PictBridge compliant printer
- ▶  **PC**: Connects the camera to a PC



- When you set [SELECT ON CONNECTION], [PictBridge] / [PC] selection screen will be displayed when connecting with USB cable.

VIDEO OUT (P94) (Playback mode only)

Set to [NTSC] or [PAL] according to the TV system in your country.

- ▶ **NTSC**: Video output is set to NTSC system.
- ▶ **PAL**: Video output is set to PAL system.

TV ASPECT (P94) (Playback mode only)

Set to [16:9] or [4:3] according to your television.

- ▶ **16:9**: Select if your television has a 16:9 aspect ratio.
- ▶ **4:3**: Select if your television has a 4:3 aspect ratio.

SCENE MENU (P46)

Setup the screen in SCENE mode

- OFF : Displays the currently selected scene mode screen
- ▶ **AUTO** : Displays scene selection screen

Initializing the built-in memory or a card. **FORMAT**

Usually, it is not necessary to format the built-in memory and the card. Format them when the message [BUILT-IN MEMORY ERROR] or [MEMORY CARD ERROR] appears. Use batteries with sufficient power when formatting.



- **Once formatting has been completed, all data including protected pictures will be deleted. Make sure not to delete them before formatting**
- When the card is not inserted, built-in memory can be formatted. When the card is inserted, the card can be formatted.

Press [**MENU** / **SET**] to display menu, enter the setup menu [**?**] and select the item. (P20)
The setting marked “▶” means it is the initial setting.

- Do not turn the camera off during formatting.
- It may take longer to format the built-in memory than the card. (Max. about 15 sec.)
- You cannot format an SD Memory Card or an SDHC Memory Card when the card's Write-Protect switch set to [LOCK].
- If the card has been formatted on a PC or other equipment, format it on the camera again.
- If the built-in memory or the card cannot be formatted, consult your nearest Service Center.

For USA assistance, please call:
1-800-211-Pana (7262) or, contact us via the web at:
<http://www.panasonic.com/contactinfo>

For Canadian assistance, please call:
1-800-99-LUMIX (1-800-995-8649) or send e-mail to:
lumixconciierge@ca.panasonic.com

LANGUAGE

Set to the language on the menu screen from the following languages.

- ▶ [ENGLISH]: English
- [DEUTSCH]: German
- [FRANÇAIS]: French
- [ESPAÑOL]: Spanish
- [ITALIANO]: Italian
- [中文]: Chinese (Traditional)*
- [日本語]: Japanese

- * Available in Canada only
- When you set to other language by mistake, select [] from the menu icons to set the desired language.

DEMO DEMO MODE

Display the demonstration.

JITTER, SUBJ. MOVE DEMO. (below)
AUTO DEMO: Displays the product image as a slide show



- [JITTER, SUBJ. MOVE DEMO.] only works in recording mode.
- Press [DISPLAY] to finish [JITTER, SUBJ. MOVE DEMO.].
- Press [MENU/SET] to finish [AUTO DEMO].
- While the AV cable or USB cable is connected to the camera, [AUTO DEMO] is not available.

About demonstration of jitter/movement detection screen

The camera automatically detects jittering and movement of the subject and indicates them. (You cannot shoot while the demonstration is on.)

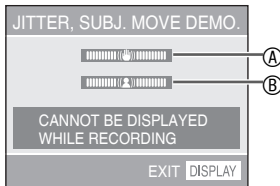

Ⓐ Jitter indicator

Ⓑ Movement indicator

- The demonstration can also be displayed from quick setting (P59). Select the stabilizer and press [DISPLAY].
- The demonstrations are examples only.
- The automatic ISO sensitivity setting using movement detection only works in intelligent ISO and the [SPORTS], [BABY] and [PET] modes.

LCD Monitor and Changes to the Display

■ Display in normal picture mode [📷]. (at the time of purchase)

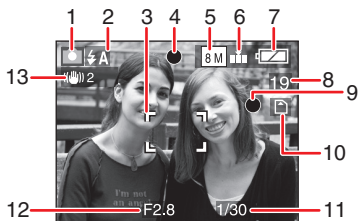

1 Recording mode

2 Flash mode (P39)

- The flash icon turns red when activating the flash and pressing the shutter button halfway.

3 AF area

- The AF area displayed is bigger than usual when taking pictures in dark places.

4 Focus (P28)

5 Picture size (P60)

6 Quality (P60)

[📷] : Jitter alert indication (P30)

7 Battery indication



- The battery indication turns red and blinks. (The status indicator blinks when the LCD monitor is turned off.)
Replace with new batteries or fully charged Ni-MH batteries.

8 Remaining number of recordable pictures (P107)

9 Recording indication

10 Built-in memory [IN] / Card [C]

([IN] or [C]) lights red during accessing.)

- Do not do the following when the access indication lights.
 - Turn the camera off.
 - Remove the batteries or the card.
 - Shake or impact the camera.
 - Disconnect the AC adaptor (optional).
- Observe the above caution also when pictures are being read or deleted or the built-in memory (or the card) is being formatted.
- The access time for the built-in memory may be longer than the access time for a card. (Max. about 7 sec.)

11 Shutter speed (P28)

12 Aperture value (P28)

- If the exposure is not adequate, the aperture value and the shutter speed turn red. (They do not turn red when the flash is activated.)

13 Optical image stabilizer (P66)



- For details about other displays, refer to P95.

■ Changing the display

Press [DISPLAY] to change the display. Choose whether to display information such as the number of pixels and possible number of images for recording while you are shooting. For details, refer to P37.

Taking Pictures Easily (Intelligent Mode)

The camera automatically sets the appropriate settings according to the subject and recording condition. This mode is recommended for beginners to take pictures easily.

1 Set the camera to intelligent mode (Intelligent Mode).

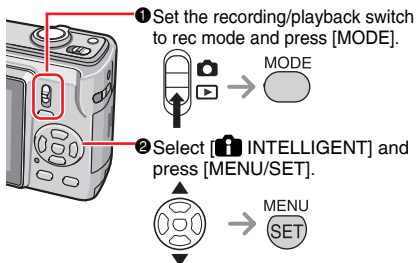

2 Hold this unit gently with both hands, keep your arms still at your side and stand with your feet slightly apart.

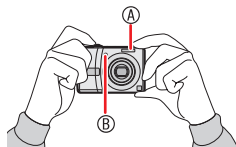

- Ⓐ Flash
- Ⓑ AF assist lamp

3 Aim the composition and press the shutter button half way.

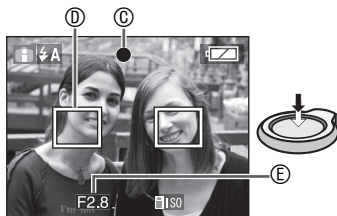

- Ⓒ The focus indication lights green.
 - When the focus indication blinks, the subject is out of focus.

- Ⓓ AF area
 - AF area is displayed on suitable focus points. (Max. 5 points)
- Ⓔ Aperture value
 - The camera beeps twice when the subject is focused.
 - The focus range is 5 cm (0.16 feet) to ∞. However, the available distance between the camera and the subject becomes further as you set high magnification (up to 30 cm (0.98 feet) to ∞).

4 Press the halfway pressed shutter button fully to take a picture.



The following functions are automatically activated.

INTELLIGENT ISO

The camera automatically sets the adequate ISO sensitivity and shutter speed according to the action and brightness of the subject.

QUICK AF

Focusing will be faster when the shutter button is pressed as the camera automatically adjusts the focus when there is not much jittering.

STABILIZER

The camera automatically detects and compensates for jittering.

MACRO

[i-MACRO] is automatically set when the subject is close to the camera.



- i-MACRO may not work according to the recording condition. In that case, the setting is fixed to initial setting of Intelligent mode (Intelligent Mode).
- You can automatically display pictures vertically if they were recorded holding the camera vertically (P30, 81).
- When you press the shutter button, the screen may become bright or dark for

a moment. This function allows easy adjustment of focus and the recorded picture will not be affected.

- Be careful not to move the camera when you press the shutter button.
- Do not cover the photo flash or the AF assist lamp with your finger or other objects.
- Do not touch the lens.
- You cannot use the following functions.
 - Exposure compensation
 - Auto bracket
 - Digital zoom

■ Flash (P39)

You can select the setting of flash among AUTO [⚡A], Auto/Red-eye reduction [⚡A👁️] or Forced OFF [🚫].

■ The Backlight Compensation (Intelligent mode [i] only)

Press ▲ to compensate that backlight cause the subject to appear dark. (Press again to cancel.)



This icon appears when you are using backlight compensation.

■ Standard settings of Intelligent mode [i] (Fixed)

Quality: Fine (when the picture size is 0.3M: Standard)
 WHITE BALANCE: AWB
 SENSITIVITY: INTELLIGENT ISO
 AF MODE: 5-area-focusing
 QUICK AF: ON
 AF ASSIST LAMP: ON
 POWER SAVE: 5 MIN.
 SELFTIMER: [OFF] or [10SEC.] is only selectable.

■ Change the setting

Press [MENU/SET] to set the following recording menu, setup menu. Refer to each corresponding page for the details on each mode.

Menu	Settings
REC menu	PICTURE SIZE* (P60)
	ASPECT RATIO (P61)
	BURST (P65)
	COLOR MODE* (P65)
	STABILIZER* (P66)
SETUP menu	BATTERY TYPE (P21)
	CLOCK SET (P17)
	WORLD TIME (P21)
	BEEP (P21)
	LANGUAGE (P24)

* The available settings differ from the other recording modes.



- The settings for above mentioned recording menu (except [BURST]) are effective only for Intelligent mode [i]. The SETUP menu settings are applied in all modes.

■ Quick setting

Using [Q.MENU] and the cursor button, you can easily make the following settings.

STABILIZER (P66)
 BURST (P65)
 PICTURE SIZE (P60)
 LCD MODE (P38)



Refer to P59 for more details on quick setting.

Taking Pictures in the Desired Setting

(📷 Normal Picture Mode)

This mode allows you to take pictures freely as more options are setup is available than Intelligent mode [i].

1 Set the camera to normal picture mode [📷].

- The [📷 NORMAL PICTURE] is set as initial setting when the camera is shipped.

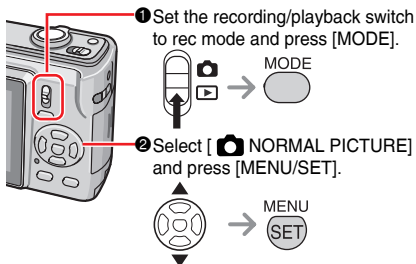

2 Hold the camera gently with both hands, keep your arms still at your side and stand with your feet shoulder-width apart.

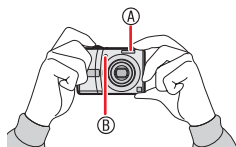

- A Flash
- B AF assist lamp

3 Aim the AF area ① to the point you want to focus on, and press the shutter button halfway to focus.

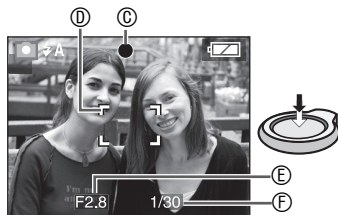

③ The focus indication lights green.

④ AF area: white → green

⑤ Aperture value

⑥ Shutter speed

- The camera beeps twice when the subject is focused. (When the macro is not used)

• **The camera can focus between 50 cm (1.64 feet) and ∞. (When the macro is not used)**

- The followings indicate that the subject is out of focus.

– Focus indication blinks (green).

– AF area turns white to red or no AF area.

– Beeps 4 times.

- The focus indicator may light even if the subject is not properly focused if the subject is out of range.

4 Press the halfway pressed shutter button fully to take a picture.



■ Using the flash

If the flash is set to AUTO [⚡A] or AUTO/Red-eye reduction [⚡A👁], the flash will work when you press the shutter button if the camera determines that the area to be shot is too dark.

- You can change the flash settings (P39).



- When you press the shutter button, the screen may become bright or dark for a moment. This function allows easy adjustment of focus and the recorded picture will not be affected.
- Be careful not to move the camera when you press the shutter button.
- Do not cover the photo flash or the AF assist lamp with your finger or other objects.
- Do not touch the lens.

Photography basics – exposure, focus, and color

A little knowledge about exposure, focus and color will come in handy when you are having trouble with a shot.

<p>Are images dark? Exposure problems Refer to P44</p>	<p>In normal picture mode [📷], Auto Exposure (AE) normally sets the correct exposure for you, but images may be dark if there is backlight. Use exposure compensation in these situations for brighter images.</p>
<p>Focus problems Refer to P30, 42</p>	<p>In normal picture mode [📷], Auto Focus (AF) normally sets the correct focus for you, but images may be unfocused in the following situations. The camera can focus between 50 cm (1.64 feet) and ∞.</p> <ul style="list-style-type: none"> – When shooting something that is far away and something that is close by at the same time. – When shooting through a dirty window. – When there are sparkling or shiny objects around the subject. – When shooting in a dark place. – When shooting a subject that is moving fast. – When shooting a scene with minimal contrast. – When shooting something very bright. – When taking a close-up picture of the subject. – When there is jitter. <p>Use AF/AE lock or macro in these situations.</p>
<p>Color problems Refer to P62</p>	<p>How the subject appears depends on the kind of lighting, so colors in different lights will be different. This unit adjusts the color automatically to give a more natural result. (Auto white balance)</p> <p>You can also adjust the white balance to suit different situations to reproduce natural colors.</p>

■ When you want to take a picture of a subject outside the AF area (AF/AE Lock)

When recording a picture of people with a composition like the following picture, you will not be able to focus the camera on the subject because the people are outside the AF area.



In this case,

- 1 Aim the AF area at the subject.
- 2 **Press the shutter button halfway** to fix the focus and the exposure.
 - The focus indication lights when the subject is focused.
- 3 **Press and hold the shutter button halfway** while moving the camera as you compose the picture.
- 4 Press the shutter button fully.
 - You can repeatedly retry AF/AE lock before pressing the shutter button fully.



■ Direction detection function

If you take pictures by holding the camera vertically, the information of the rotation on the pictures is automatically added and recorded to the pictures.

When [ROTATE DISP.] (P81) is set to [ON], you can rotate and display pictures on the screen or the TV according to the information of the rotation on the pictures.

- This function may not work properly on pictures recorded by aiming the camera up or down.
- Motion pictures taken with the camera held vertically are not displayed vertically.

■ Preventing jitter (camera shake)

- Be careful of jittering when pressing the shutter button.
- The jitter alert ① appears when the shutter speed is slow and the chances of blurring are greater.



- When the jitter alert appears, use a tripod for best results. By combining the use of a tripod with the self-timer (P43), you can avoid blurring caused when you press the shutter button.
- Shutter speed will be slower particularly in the following cases. Keep the camera still from the moment the shutter button is pressed until the picture appears on the screen. We recommend using a tripod.
 - [NIGHT PORTRAIT], [NIGHT SCENERY], [PARTY], [CANDLE LIGHT], [STARRY SKY], [FIREWORKS] mode

Taking Pictures with the Zoom

Using the optical zoom / the extended optical zoom (EZ)

You can make people and subjects appear closer with the 3 times optical zoom, and landscapes can be recorded in wide angle. (35 mm film camera equivalent: 33 mm to 100 mm)

To record in wider angle without deteriorating (Extended optical zoom), do not set the picture size to the highest setting for each aspect ratio (**4:3** / **3:2** / **16:9**)

■ To make subjects appear closer use (Tele)

Rotate the zoom lever towards Tele.



■ To make subjects appear further away use (Wide)

Rotate the zoom lever towards Wide.



■ Maximum Zoom

When the picture size is set except at the highest resolution, optical zoom becomes extended optical zoom to enlarge more.

Enlargement : Max. 4.8 x

- Maximum zoom magnification varies depending on the aspect ratio as follows.

Aspect ratio	Pixels	Maximum zoom (Tele)
4:3	[5M]	3.8 x
3:2	[4.5M]	
16:9	[3.5M]	

■ How the extended optical zoom works

The extended optical zoom works by extracting the center of the picture and expanding it for a higher telephoto effect. So, for example, if you choose [3M] (3M EZ) (3 million pixels), the 8M (8.1 million) CCD area is cropped to the center 3M (3 million pixels) area, allowing a picture with a higher zoom effect.



- The optical zoom is set to Wide (1 x) when the camera is turned on.
- If you use the zoom function after focusing on the subject, focus on the subject again.
- The lens barrel extends or retracts according to the zoom position. Take care not to interrupt the motion of the lens barrel while the zoom lever is rotated.
- In motion picture mode [M], the zoom magnification is fixed to the value set at the start of recording.
- “EZ” is an abbreviation of “Extended optical Zoom”.
- If you set a picture size that activates the extended optical zoom, the extended optical zoom icon [EZ] is displayed on the screen when you use the zoom function.
- The zoom will stop moving for an instant near [W] (1 x) when the extended optical zoom is used. This is not a malfunction.
- The indicated zoom magnification is an approximation.
- The extended optical zoom cannot be activated in the following modes.
 - Motion picture mode [M]
 - [HIGH SENS.]
 - [HI-SPEED BURST]

Using the easy zoom button

Press the [E.ZOOM] button to quickly zoom. Actual zoom factors depend on the pixel recording setting.

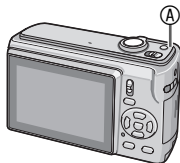

A [E.ZOOM] button

When the picture size is set to the highest resolution for each aspect ratio

Resolution is temporarily reduced and you can use the extended optical zoom.

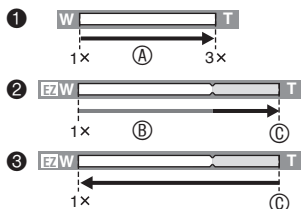

- 1 Press [E.ZOOM] once.
- 2 Press [E.ZOOM] twice.
- 3 Press [E.ZOOM] three times.

- A Optical zoom
- B Extended optical zoom
- C Maximum extended optical zoom magnification

- The resolution becomes smaller as shown below when the extended optical zoom is used. The color of the zoom bar and the resolution displayed on the screen change at this time.

Aspect ratio	Picture size
4:3	8M → 3M
3:2	7M → 2.5M
16:9	6M → 2M

- If you press [E.ZOOM] three times, the zoom position returns to Wide and the resolution returns to the original. The resolution also returns to normal when

you return the zoom lever to the optical zoom position.

When the picture size is set except at the highest resolution for each aspect ratio

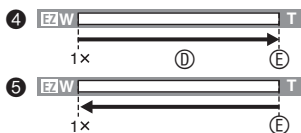

- 4 Press [E.ZOOM] once.
 - 5 Press [E.ZOOM] twice.
- D Extended optical zoom
 - E Maximum extended optical zoom magnification

- Maximum extended optical zoom magnification varies depending on [ASPECT RATIO] and [PICT.SIZE]



- Press [E.ZOOM] until the zoom starts working.
- The easy zoom is also activated if the zoom position is anything other than Wide.
- You can further extend the zoom to the Digital zoom range when [DIGITAL ZOOM] is set to [ON].
- In motion picture mode [FHD], [HIGH SENS.] and [HI-SPEED BURST] mode, the zoom is limited to the optical zoom.
- The indicated zoom magnification is an approximation.



Using the digital zoom Further extending the zoom

A maximum of 12 × zoom can be achieved with the 3 × optical zoom and the 4 × digital zoom when [DIGITAL ZOOM] is set to [ON] in the [REC] menu. However, if a picture size that can use extended optical zoom is selected, a maximum of 19.1 × zoom can be achieved with the 4.8 × extended optical zoom and the 4 × digital zoom.

Menu operation

1 Press [MENU/SET] when the recording/playback switch is set to [CAM].

- When a scene mode is selected, select the recording menu and then press ►.

2 Press ▲/▼ to select [DIGITAL ZOOM] and then press ►.

3 Press ▼ to select [ON] and then press [MENU/SET].

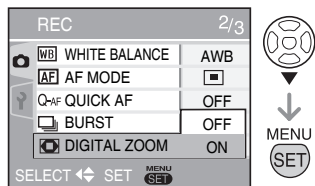

4 Press [MENU/SET] to close the menu.

- You can also press the shutter button halfway to close the menu.

Entering the digital zoom range

When you rotate the zoom lever to the extreme Tele position, the on-screen zoom indication may momentarily pause. You can enter the digital zoom range to continuously rotate the zoom lever to Tele or to release the zoom lever once and then rotate it to Tele again.

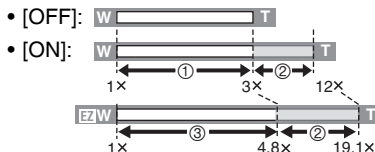

For example: When using the digital zoom and the extended optical zoom ([3M]) (3M EZ) at the same time.

- Optical zoom
- Digital zoom
- Extended optical zoom



- The AF area is displayed with a size wider than usual and set only to a point on the center of the screen in the digital zoom range. Also, the stabilizer function may not be effective.
- When using the digital zoom, the picture quality becomes deteriorated.
- When using the digital zoom, we recommend setting the stabilizer to [MODE1].
- When using the digital zoom, use a tripod and the self-timer for best results.
- The indicated zoom magnification is an approximation.
- The digital zoom does not operate in the following cases.
 - In Intelligent mode (i)
 - When the Intelligent ISO setting is activated
 - In [SPORTS], [BABY1] / [BABY2], [PET], [HIGH SENS.] and [HI-SPEED BURST] mode

Playing Back Pictures (▶) Normal playback mode

Select the normal playback mode (▶) (P18).

The picture data on the built-in memory appears when a card is not inserted. The picture data on the card appears when a card is inserted.

■ Playing Back Pictures

Press ◀▶ to select the picture.



- ◀ : Play back the previous picture.
- ▶ : Play back the next picture.

■ Fast forwarding/Fast rewinding

Press and hold ◀▶ during playback.

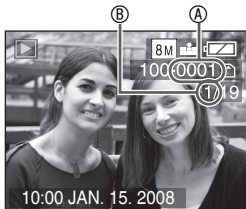

- ▶▶ : Fast forward
- ◀◀ : Fast rewind

- The file number ① and the picture number ② only change one by one. Release ◀▶ when the number of the desired picture appears to play back the picture.
- If you press and hold ◀▶, you can forward/rewind faster.
- In multi playback (P67), the picture can only be forwarded or rewound one by one.



- This camera is based on the DCF standards (Design rule for Camera File system) which was established by the Japan Electronics and Information Technology Industries Association (JEITA).
- The LCD monitor may not be able to display the details of the recorded pictures. You can use the playback zoom (P69) to check the details of the pictures.
- If you play back pictures that have been recorded with other equipment, the picture quality may deteriorate. (The pictures are displayed as [THUMBNAIL IS DISPLAYED] on the screen.)
- When changing the folder name or file name on a PC, the pictures will not be played back.
- When playing back a file out of standard, the folder/file number is indicated by [—] and the screen may turn black.
- You cannot play back the audio of still pictures with audio recorded on other equipment.
- The lens barrel retracts about 15 seconds after switching from [REC] to [PLAYBACK] mode.

Deleting Pictures

Select the normal playback mode [▶] (P18).

The picture data on the built-in memory is deleted when a card is not inserted. The picture data on the card is deleted when a card is inserted.

- Once deleted, pictures cannot be recovered. Please double-check before deleting pictures.

■ To delete a single picture

1 Select the picture with ◀▶.

2 Press [🗑️].

3 Press ◀ to select [YES] and then press [MENU/SET].



- While deleting the picture, [🗑️] appears on the screen.

■ To delete [DELETE MULTI] (up to 50 pictures) / [DELETE ALL]

1 Press [🗑️].

2 Press ▲/▼ to select [DELETE MULTI] or [DELETE ALL] and then press [MENU/SET].



- If you select [DELETE MULTI], perform steps 3 onwards.
- If you select [DELETE ALL], perform steps 5 onwards.

When [FOVORITE] (P82) is set to [ON], [DELETE ALL] and [ALL DELETE EXCEPT ★] appear in advance. Select either of them using ▲/▼, press [MENU/SET] and then perform steps 5 onwards. When no picture is set as favorite, [ALL DELETE EXCEPT ★] is not selectable.

3 Press ◀▶ to select the picture and then press ▼ to set.

(Only when selecting [DELETE MULTI])

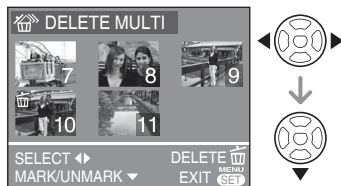

- Repeat the above procedure.
- The selected pictures appear with [🗑️]. When ▼ is pressed again, the setting is canceled.
- The icon [On] blinks red if the selected picture cannot be deleted. Cancel the protect setting. (P85)

4 Press [].

5 Press **▲** to select [YES] and then press [MENU/SET] to set.

(Screen when selecting [DELETE MULTI])

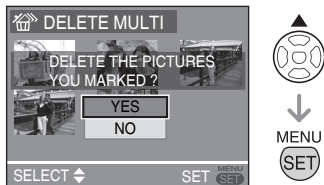

- When you delete all pictures, only pictures in either of the built-in memory or the card can be deleted. (You cannot delete pictures in both the built-in memory and the card at the same time.)
- If you press [MENU/SET] while deleting pictures using [DELETE MULTI], [DELETE ALL] or [ALL DELETE EXCEPT ★], the deleting will stop halfway.



- Do not turn off the camera while deleting pictures or movies.
- When deleting pictures, use batteries with sufficient battery power or use the AC adaptor (optional).
- The more pictures there are to delete, the more time it takes.
- In the following cases, pictures are not deleted even if [DELETE ALL] or [ALL DELETE EXCEPT ★] is selected.
 - When the Write-protect switch of the SD Memory Card or SDHC Memory Card is set to the [LOCK] side
 - When files do not conform to the DCF
 - When pictures are protected [

About the LCD Monitor

Changing the information displayed

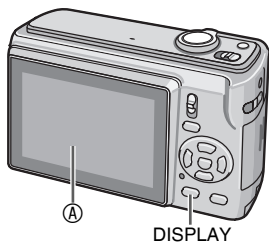

Ⓐ LCD monitor (LCD)

Press [DISPLAY] to switch to the screen to be used.

- When the menu screen appears, the [DISPLAY] button is not activated.
- During, playback zoom, while playing back motion pictures and during a slide show, you can only select “Normal display” or “Non-display”

In recording mode

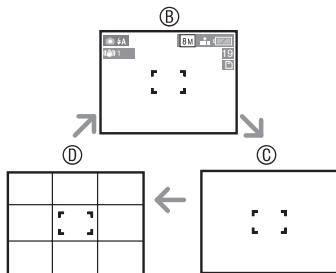

Ⓑ Normal display

Ⓒ Non-display

Ⓓ Guide line display

In playback mode

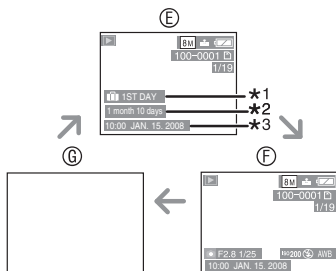

Ⓔ Normal display

Ⓕ Display with recording information

Ⓖ Non-display

- *1 The number of days that have passed since the travel date is displayed when a picture was taken with [TRAVEL DATE] setting.
- *2 Displayed when you set birthday setting for [BABY1]/[BABY2] or [PET] mode, and [WITH AGE] is selected at taking pictures.
- *3 When characters are registered under [BABY] or [PET] mode or [TITLE EDIT] in [PLAYBACK] mode menu, the recorded date and time appears after the registered characters are displayed for a few seconds.

■ Guide line

When recording, you can refer to the the guideline for composing. You can choose the guideline pattern from setup menu (P21).



⌘ : To divide the entire screen into 3x3 for a well-balanced composition

⊕ : To align the subject on the center of the screen.

Making the LCD monitor easier to see (LCD mode)



- 1 Press and hold [Q.MENU] until quick setting screen is displayed.

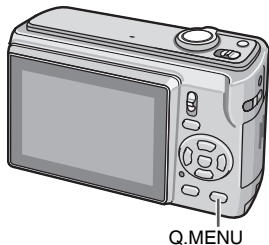

- 2 Select indication at the right end (initial setting: [OFF]) using **▶**, select mode using **▲/▼** and press [MENU/SET].



Mode	Uses
AUTO POWER LCD	Brightness of the LCD monitor automatically changes depending on brightness of the environment.
POWER LCD	The LCD monitor becomes brighter and easier to see even when taking pictures outdoors.
HIGH ANGLE	This is useful when you cannot get close to the subject because there is a person in the way. (More difficult to see when looked straight on.)
OFF	The LCD monitor returns to the normal brightness.



- You can set LCD mode in setup menu. (P21)
- High angle mode is canceled if you turn the camera off. (Same occurs in [POWER SAVE].)
- The LCD monitor automatically returns to normal brightness after 30 seconds when recording in power LCD mode. Press any button to make the LCD monitor bright again.
- The brightness of the pictures displayed on the LCD monitor is adjusted when power LCD mode or high angle mode is activated. Therefore, some subjects may look different on the LCD monitor. However, this does not affect the recorded pictures.
- If the screen is difficult to see because of light from the sun etc. shining on it, use your hand or another object to block the light.
- The number of recordable pictures decreases when the auto power LCD, power LCD or high angle mode is used.

Taking Pictures Using the Built-in Flash

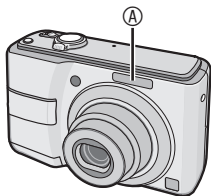

A Photo flash

- Do not cover the photo flash with your fingers or any other items.

Switching to the appropriate flash setting

Set the flash setting of the built-in flash according to the scene to be recorded.

1 Press **▶** [**⚡**].

2 Press **▲/▼** or **▶** [**⚡**] to switch the flash setting.

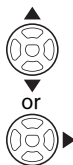
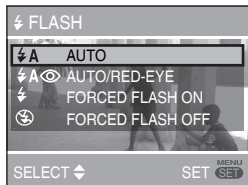

- For the flash setting contents, refer to “Flash setting”. For the selectable flash setting, refer to “Available flash settings by recording mode” (P40).

3 Press [**MENU/SET**].

- You can also press the shutter button halfway to SET.
- When 5 seconds pass without any operation, the setting selected at the time is automatically adopted.

Flash setting

⚡A : AUTO

The flash is automatically activated according to the recording condition.

⚡A : AUTO/Red-eye reduction*¹ (White)

The flash is automatically activated according to the recording condition.

- Use this when you take pictures of people in low lighting conditions.**

⚡ : Forced Flash ON

The flash is activated every time regardless of the recording condition.

- Use this when your subject is back-lit or under fluorescent light.**

⚡ : Forced ON/Red-eye reduction*¹

- In [PARTY] or [CANDLE LIGHT] mode, the flash mode is set to Forced ON/Red-eye reduction.

⚡S : Slow sync./Red-eye reduction*¹ (Orange)

When you take a picture with a dark background landscape, this feature makes the shutter speed slow when the flash is activated, so that the dark background landscape will become bright.

- You can use this setting only in [NIGHT PORTRAIT], [PARTY] or [CANDLE LIGHT] mode.**

⚡ : Forced Flash OFF

The flash is not activated in any recording condition.

- Use this when taking pictures in places where the use of the flash is not permitted.**

*¹ Flash is activated twice to prevent eyes of the subjects appearing red. The subject should not move until the second flash is activated.

■ **The available flash range to take pictures in intelligent ISO are as follows:**

ISO LIMIT	Available flash range
ISO MAX400	60 cm (1.97 feet) to 3.7 m (12.14 feet) (Wide) 40 cm (1.31 feet) to 2.0 m (6.56 feet) (Tele)
ISO MAX800	80 cm (2.62 feet) to 5.3 m (17.39 feet) (Wide) 60 cm (1.97 feet) to 2.9 m (9.51 feet) (Tele)
ISO MAX 1250	1.0 m (3.28 feet) to 6.6 m (21.65 feet) (Wide) 80 cm (2.62 feet) to 3.6 m (11.81 feet) (Tele)

■ **Shutter speed for each flash mode**

Flash mode	Shutter speed (sec.)
A : AUTO	1/30 to 1/2000
A : AUTO/ Red-eye reduction	1/30 to 1/2000
ON : Forced ON	1/30 to 1/2000
ON : Forced ON/Red-eye reduction	1/30 to 1/2000
S : Slow sync./ Red-eye reduction	1/8 or 1 to 1/2000*1
OFF : Forced OFF	1/4 or 1 to 1/2000*2 1/8 or 1 to 1/2000*3

*1 [NIGHT PORTRAIT] or [CANDLE LIGHT] mode

*2 When intelligent ISO is set or in [SPORTS], [BABY] or [PET] mode

*3 When in normal picture mode , [NIGHT PORTRAIT] or [CANDLE LIGHT] mode

- The shutter speed reaches the maximum of 1 second for *1, *2 and *3 when:
 - Optical Image Stabilizer is [OFF]
 - When the Optical Image Stabilizer is set to [MODE1] or [MODE2] and the camera determines that there is minimum possibility of blurring.

- The shutter speed will be different from that shown in the table in the following scene modes.

– [NIGHT SCENERY]:

1/8th of a second or 8 seconds to 1/2000th of a second

– [STARRY SKY]:

15 seconds, 30 seconds, 60 seconds

– [FIREWORKS]:

1/4th of a second, 2 seconds

– Other scene modes:

1/8th of a second to 1/2000th of a second



- **Do not look directly at the flash at close range when it is activated.**
- **Do not bring the flash too close to objects or close the flash while it is activated. The objects may be discolored by its heat or lighting.**
- **While the flash is charged, the LCD monitor turns off and you cannot take pictures. The status indicator lights up. If the remaining battery power is low, the screen may be turned off for a longer period of time.**
- When you take a picture beyond the available flash range, the exposure may not be adjusted properly and the picture may become bright or dark.
- When the flash icon blinks, the flash is being charged and you cannot take a picture even when you press the shutter button fully.
- The white balance may not be properly adjusted if the photo flash is insufficient.
- When the shutter speed is fast, the flash effect may not be sufficient.
- When you repeat taking a picture, recording may be disabled even if the flash is activated. Take a picture after the access indication disappears.
- The red-eye reduction effect differs between people. Also, if the subject was far away from the camera or was not looking at the first flash, the effect may not be evident.
- In burst mode or auto bracket mode, you cannot use the flash.

Taking Close-up Pictures (AF Macro Shooting)



This mode allows you to take close-up pictures of the subject, e.g. when taking pictures of flowers.

You can take pictures approaching the subject at a distance up to 5 cm (0.16 feet) from the lens by rotating the zoom lever upmost to Wide (1 \times).

1 Press



- Macro shooting starts.

■ Focus range

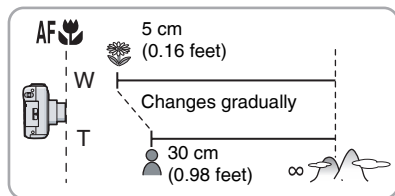

- Use a tripod and the self-timer for best results.
- When the subject is close to the camera, the effective focus range (depth of field) is significantly narrowed. Therefore, you will have difficulty in focusing on the subject if the distance between the camera and the subject is changed after focusing on the subject.
- When the camera lens is at a distance beyond the available range from the subject, the subject may not be focused even if the focus indication lights.
- Macro shooting gives priority to a subject close to the camera. Therefore, if the distance between the camera and the subject is more than 50 cm (1.64 feet) it takes longer to focus on it in macro shooting than normal shooting.
- The available flash range is about 30 cm (0.98 feet) to 5.9 m (19.36 feet) (Wide). (This is applied when you set the ISO sensitivity to [AUTO].) We recommend setting the flash to Forced Flash OFF [] when you take pictures at close range.
- When you take pictures at close range, the resolution of the periphery of the picture may decrease slightly. This is not a malfunction.

Taking Pictures with the Self-timer

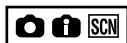

1 Press ◀ [⏸].

2 Select shutter speed using ▲/▼ or ◀ [⏸].



3 Press [MENU/SET].

- You can also press the shutter button halfway to set.
- When 5 seconds pass without any operation, the setting selected at the time is automatically adopted.

4 Press the shutter button halfway to focus and then press it fully to take a picture.



- The self-timer indicator **A** blinks and the shutter is activated after 10 seconds (or 2 seconds).
- If you press [MENU/SET] when the self-timer is being set, the self-timer setting is canceled.

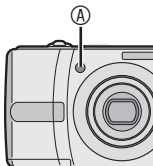

- When using a tripod or in other cases, setting the self-timer to 2 seconds is a convenient way to stabilize the jitter caused by pressing the shutter button.
- When you press the button fully with one stroke, the subject is automatically focused just before the recording. In dark places, the self-timer indicator blinks and then it may turn on brightly to work as the AF assist lamp for focusing on the subject.
- In Intelligent mode [i], [10SEC.] or [OFF] is selectable.
- In [SELF PORTRAIT] mode, [2SEC.] or [OFF] is selectable.
- When you set the self-timer in burst mode, the camera starts taking a picture 2 or 10 seconds after the shutter button is pressed. The number of pictures taken at one time is fixed to 3.
- We recommend using a tripod when setting the self-timer.
- You cannot use the self-timer in [HI-SPEED BURST].

Compensating the Exposure



Use this function when you cannot achieve appropriate exposure due to the difference of brightness between the subject and the background.

Over exposed



Compensate the exposure toward negative.

Properly Exposed



Compensate the exposure toward positive.

Under exposed



- 1 Press **▲** [**+/-**] to display [EXPOSURE] and press **◀/▶** to compensate the exposure.

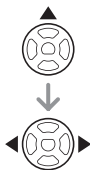

- Ⓐ The exposure compensation value
- You can compensate from -2 EV to +2 EV in steps of 1/3 EV.
 - Select [0 EV] to return to the original exposure.

- 2 Press [MENU/SET] to finish.

- You can also press the shutter button halfway to finish.





- EV is an abbreviation of “Exposure Value”, and it is the amount of light given to the CCD by the aperture value and the shutter speed.
- The exposure compensation value appears on the lower left of the screen.
- The exposure value is memorized even if the camera is turned off.
- The compensation range of the exposure will be limited depending on the brightness of the subject.
- You cannot compensate the exposure in [STARRY SKY] mode.

Auto Bracket Recording



3 pictures are taken in succession, automatically changing the exposure. The pictures are based on the selected compensation range after setting the exposure (P44).

1 Press \blacktriangle () several times to display  [AUTO BRACKET] and set the compensation range of the exposure using \blacktriangleleft \blacktriangleright .

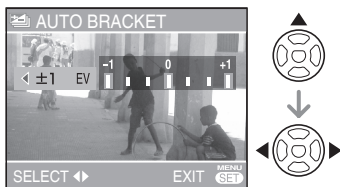

- You can select OFF, $\pm 1/3$ EV, $\pm 2/3$ EV or ± 1 EV. (When you do not use auto bracket, select [OFF].)

2 Press [MENU/SET] to apply.

- When setting auto bracket, the auto bracket icon () appears on the screen.

3 Press the shutter button to take pictures.

- The auto review function is activated after taking pictures.



- The auto bracket setting is canceled if you turn the camera off. (Same occurs in [POWER SAVE].)
- You cannot use auto bracket in [STARRY SKY] and [HI-SPEED BURST] mode.
- The number of recordable pictures is 2 or less, auto bracket cannot be activated.
- The exposure may not be compensated with auto bracket depending on the brightness of the subject.
- When auto bracket is activated, [FLASH] is set to Forced Flash OFF ().
- Burst mode setting is canceled, when [AUTO BRACKET] is activated.

Scene Mode

Set the recording/playback switch to the recording [📷]. (P18)

When you select a scene mode to match the subject and recording situation, the camera sets the optimal exposure and hue to obtain the desired picture.

- Refer to P47 to 52 for details about the modes.

1 Press [MODE], select [SCENE MODE] using ▲/▼ and press [MENU/SET].

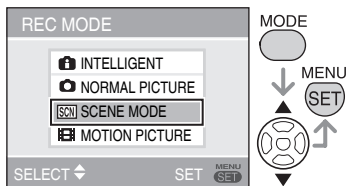

- If you set [SCENE MENU] in [SETUP] menu to [OFF], the previous scene mode is set.

2 Press ▲/▼/◀/▶ to select the scene mode.

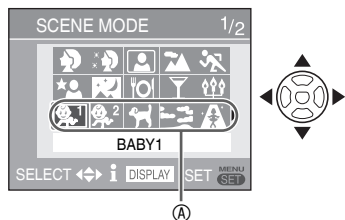

- Press ▼ at ① to switch to the next menu screen.
- You can switch menu screens from any menu item by rotating the zoom lever.

3 Press [MENU/SET].

Press [MENU/SET] and then perform steps 2 and 3 to change the scene mode.

■ Scene mode help [i] INFORMATION

- To see explanations about the scene modes, press [DISPLAY] while a scene mode is selected in step 2. Press again to return to the scene mode menu.

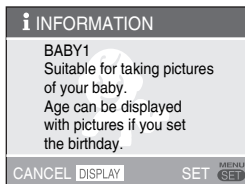

- Refer to P41 for the shutter speed.
- Flash settings return to the factory settings when you change the scene mode despite it remains still even if the camera is turned off.
- The color of the picture may seem strange if you use a scene mode that is unsuitable for the shot.
- If you press [MENU/SET] to display the menu screen, [SCN] menu will be displayed. You can setup recording menu [📷] or setup menu [⚙️] using ▼ on this screen.
- The following cannot be set in scene mode.
 - [INTELLIGENT ISO]
 - [SENSITIVITY]
 - [COLOR MODE]

Refer to P46 for details on selecting a scene menu.



Portrait mode

The background is blurred and the person stands out with a healthier complexion.

■ Technique to make this mode more effective:

- 1 Rotate the zoom lever to Tele as far as possible.
- 2 Move close to the subject.



- Suitable for outdoors in the daytime.
- ISO sensitivity is fixed to [ISO100].



Soft skin mode

The camera detects the face or skin area to achieve a smoother appearance than portrait mode. Use when taking portraits from the chest up.

■ Technique to make this mode more effective:

- 1 Rotate the zoom lever to Tele as far as possible.
- 2 Move close to the subject.



- Suitable for daylight shooting.
- Other flesh-colored elements are also softened.
- The effect may not be as obvious if there isn't enough light.
- ISO sensitivity is fixed to [ISO100].



Self portrait mode

For taking pictures of yourself easily.

■ Technique for self portrait mode

- Press the shutter button halfway to focus. The self-timer indicator lights up when you are brought into focus. Making sure you hold the camera still, press the shutter button fully to take the picture.



- The subject is not focused when the self-timer indicator is blinking. Make sure to press the shutter button halfway again to focus.
- The recorded picture automatically appears on the LCD monitor for reviewing (for 10 seconds).
- If the picture is blurry due to the slow shutter speed, we recommend using the 2 second self-timer. (P43)



- The focus range is about 30 cm (0.98 feet) to 70 cm (2.3 feet) (Wide).
- When you select [SELF PORTRAIT], the zoom magnification is automatically moved to Wide.
- The self-timer can only be set to [OFF] or [2SEC.]. If it is set to 2 seconds, this setting will remain until the camera is turned off, the scene mode is changed or the camera is switched to the playback mode.
- The setting on the AF assist lamp is disabled.
- Optical image stabilizer is fixed to [MODE2].



Scenery mode

The camera focuses on distant subjects to allow you to take pictures of wide landscapes.



- The focus range is 5 m (16.4 feet) to ∞.
- The flash setting is fixed to Forced OFF [⊗].
- The setting on the AF assist lamp is disabled.
- You cannot change the white balance setting.

Refer to P46 for details on selecting a scene menu.



Sports mode

Allows you to shoot fast moving subjects (e.g. outdoor sports).



- Suitable for daylight shooting, 5 m (16.4 feet) or more away from the subject.
- When shooting fast moving subjects indoors, Sensitivity will be the same as when you have set ISO limit in intelligent ISO to [ISO MAX800].
- The digital zoom is fixed to [OFF].



Night portrait mode

Shoot the subject with natural brightness using the flash and slow shutter speed.

■ Technique for Night portrait mode

• Use the flash.

- Due to the slow shutter speed, use a tripod and the self-timer for best results.
- Keep the subject still for about 1 second after taking a picture.
- Rotate the zoom lever to Wide (1 x), about 1.5 m (4.92 feet) from the subject.



- The focus range is 1.2 m (3.94 feet) to 5 m (16.4 feet). (Refer to P40 for details about available flash range.)
- The shutter may close (max. about 1 sec.) after shooting due to signal processing. This is not a malfunction.
- When shooting in dark places, noise may become visible.
- When using the flash, Slow sync./Red-eye reduction [] is selected and the flash is activated every time.
- You cannot change the white balance setting.



Night scenery mode

The nightscape can be recorded vividly.

■ Technique for night scenery mode

- Use a tripod as the shutter may be open for as long as 8 seconds. Use the self-timer for best results.



- The focus range is 5 m (16.4 feet) to ∞.
- The shutter may close (max. about 8 seconds) after shooting due to signal processing. This is not a malfunction.
- When shooting in dark places, noise may become visible.
- The flash setting is fixed to Forced Flash OFF [].
- The shutter speed becomes as follows:
Max. 8 seconds:
– When optical image stabilizer is [OFF]
– When optical image stabilizer is [MODE1] or [MODE2] and the camera determines that there is little jitter
Max. 1/8 second:
– Other cases than the case listed above.
- The settings on the AF assist lamp is disabled.
- You cannot change the white balance setting.



Food mode

Use to take pictures of food in restaurants, irrespective of the lighting, so that the natural colors of the subject come out.



- The focus range is 5 cm (0.16 feet) (Wide)/30 cm (0.98 feet) (Tele) to ∞.
- You cannot change the white balance setting.

Refer to P46 for details on selecting a scene menu.



Party mode

Use to take pictures at wedding receptions, indoor parties, etc. Both the people and the background can be shot with natural brightness using the flash and slow shutter speed.

■ Technique for Party mode

• Use the flash.

- Use a tripod and the self-timer for best results.
- Rotate the zoom lever to Wide (1 x), about 1.5 m (4.92 feet) from the subject.



- The flash setting can be set to Forced ON/Red-eye reduction [] or Slow sync./Red-eye reduction [].
- You cannot change the white balance setting.



Candle light mode

Use to get the most from the mood created by candlelight.

■ Technique for Candle light mode

- Don't use the flash.
- Use a tripod and the self-timer for best results.



- The focus range is 5 cm (0.16 feet) (Wide)/30 cm (0.98 feet) (Tele) to ∞.
- The flash setting can be set to Forced ON/Red-eye reduction [] or Slow sync./Red-eye reduction [].
- You cannot change the white balance setting.



Baby mode 1



Baby mode 2

Adjusts the exposure and tone to bring out the healthy color of your baby's skin. The flash will be weaker than normal if you choose to use it.

- You can set two different birthdays and names by using [BABY1] and [BABY2]. You can display the set items when playing back the pictures and stamp them on the recorded pictures with [TEXT STAMP] (P76).
- You can also use the [PHOTOfunSTUDIO-viewer-] software on the included CD-ROM to print your baby's age. (For details, refer to the separate operating instructions (PDF file) of the software.)

■ Age and name display setting

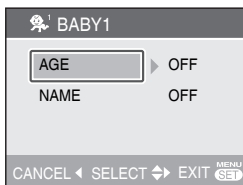

1. Select [AGE] or [NAME] using ▲/▼ and press ▶.
2. Select [SET] using ▲/▼ and press [MENU/SET].
3. When setting [Age]:
Select year / month / day using ◀▶ and set them using ▲/▼.
Setting [NAME]: Enter the name (Refer to P75 for details on text entry)
4. Press [MENU/SET]
[AGE] and [NAME] is automatically set to [ON] and displayed on the screen when age and name is set. To change display/none, select [ON] or [OFF] in [AGE] or [NAME] in step 1 above, and press [MENU/SET].
 - If [ON] is selected when name or age is not set, the setup screen is automatically displayed.
 - If [AGE] or [NAME] is set to [OFF], the age or name will not be displayed.

Refer to P46 for details on selecting a scene menu.



- The focus range is 5 cm (0.16 feet) (Wide)/30 cm (0.98 feet) (Tele) to ∞.
- Sensitivity will be the same as when you have set ISO limit in intelligent ISO to [ISO MAX400].
- If you turn on the camera in [BABY1] / [BABY2], age will be displayed for about 5 seconds.
- Actual age displays depend on the [LANGUAGE] setting.
- If the age is not properly displayed, check the clock and birthday settings.
- The birthday setting can be reset with [RESET]. (P23)
- The digital zoom cannot be used.



Pet mode

Suitable for taking pictures of your pet. This allows you to set the birthday (age) and name of your pet. For details on how to set age and birthday, see [BABY1]/[BABY2].



- Sensitivity will be the same as when you have set ISO limit in intelligent ISO to [ISO MAX800].
- The AF assist lamp is changed to [OFF].
- The AF mode is changed to [□].
- Refer to [BABY] for more details.



Sunset mode

Use to take pictures of the sunset. Sunset color can be reproduced vividly.



- The flash setting is fixed to Forced Flash OFF [☺].
- The setting on the AF assist lamp is disabled.
- ISO sensitivity is fixed to [ISO100].
- You cannot change the white balance setting.



High sensitivity mode

The ISO sensitivity automatically switches to between [ISO1600] and [ISO6400] when taking pictures.

■ Setting the aspect ratio and a picture size



1. Select [4:3 3M], [3:2 2.5M] or [16:9 2M] using ▲/▼ and press [MENU/SET].



- The resolution of the recorded picture decreases significantly because of high sensitivity processing. This is not a malfunction.
- This mode is suitable when you print 4" × 6"/10 × 15 cm images.
- The focus range is 5 cm (0.16 feet) (Wide)/30 cm (0.98 feet) (Tele) to ∞.
- The flash setting can be set to AUTO [⚡] or Forced Flash ON [⚡].
- The quality setting is fixed to [□].
- The following function cannot be activated.
 - Extended optical zoom
 - Digital zoom



High-speed burst mode

This is a convenient mode for shooting rapid movement or a decisive moment. Burst speed: Approx. 5.5 fps

■ Setting the aspect ratio and a picture size

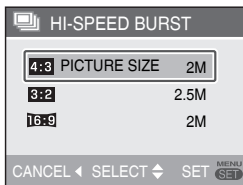

Refer to P46 for details on selecting a scene menu.

1. Select [4:3 2M], [3:2 2.5M] or [16:9 2M] using ▲/▼ and press [MENU/SET].
2. Press the shutter button fully to take pictures.

Still pictures are taken continuously while the shutter button is pressed fully.

Number of recordable pictures

Built-in memory: Approx.15

Card: Approx.15 to 100 (max.)

- The burst speed changes depending on the recording conditions.
- The number of picture is limited depending on the recording conditions, the type of card, etc.
- The number of picture taken in succession may increase right after formatting.



- The flash setting is fixed to Forced Flash OFF [☺].
- The quality setting is fixed to [S].
- The focus range is 5 cm (0.16 feet) (Wide) / 30 cm (0.98 feet) (Tele) to ∞.
- The shutter speed becomes 1/8th of a second to 1/2000th of a second.
- ISO sensitivity is automatically fixed between [ISO500] and [ISO800]. (ISO sensitivity is set higher as burst speed becomes faster.)
- Focus, shutter speed, ISO sensitivity, zoom and exposure are fixed to the values set for the first picture.
- The recorded picture becomes slightly rougher. (Suitable for 4" × 6"/10 × 15 cm printing.)
- The following function cannot be used.
 - Extended optical zoom
 - Digital zoom
 - Auto bracket
 - Self-timer
 - Burst

**Starry sky mode**

Take clear pictures of the night sky or other dark subjects.

Setting the shutter speed

Choose a shutter speed; 15, 30, or 60 seconds.

- 1 Press ▲/▼ to select the shutter speed, then press [MENU/SET].

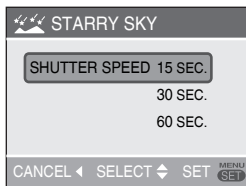

- To change the shutter speed, press [MENU/SET], then select [STARRY SKY] again with ►.
 - The shutter speed can also be changed in quick setting (P59).
- 2 Take a picture.

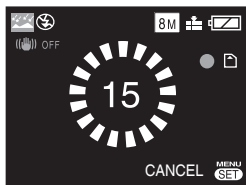

- The countdown screen appears. Do not move the camera. [PLEASE WAIT...] appears for the number of seconds you chose for shutter speed after the countdown. This is to process the signals.
- To cancel the shot, press [MENU/SET] while the countdown screen is displayed.

Technique for Starry sky mode

- The shutter opens for 15, 30 or 60 seconds, so use a tripod and the self-timer for best results.



- The flash setting is fixed to Forced Flash OFF [☺].
- The ISO sensitivity is fixed to [ISO100].
- The following function cannot be used.
 - Exposure compensation
 - White balance
 - Stabilizer
 - Burst

Refer to P46 for details on selecting a scene menu.



Fireworks mode

Take beautiful pictures of fireworks exploding in the night sky.

■ Technique for Fireworks mode

- Shutter speed becomes slower so use a tripod.



- This is most effective on subjects 10 m (32.8 feet) or more from the camera.
- The shutter speed becomes:
 - When [OFF] is set on the optical image stabilizer function: 2 seconds
 - When optical image stabilizer [MODE1] or [MODE2] is on: 1/4th or 2 seconds (The shutter speed becomes 2 seconds when the camera determines that there is little jitter such as when using a tripod etc.). You can change shutter speed when exposure is compensated.
- The flash setting is fixed to Forced Flash OFF [☀].
- You cannot change the AF mode setting.
- AF area is not displayed.
- The settings on the AF assist lamp is disabled.
- ISO sensitivity is fixed to [ISO100].
- You cannot change the white balance setting.



Beach mode

Prevents underexposure of the subject under strong sunlight to allow you to take pictures on a beach.



- Do not touch the camera with wet hands.
- Sand or seawater may cause the camera to malfunction. Make sure that sand or seawater does not come in touch with the camera, particularly its lens, flash or terminals.
- Problems caused by sand or seawater are not covered by the product warranty.
- You cannot change the white balance setting.



Snow mode

Exposure and white balance are adjusted to make the white of the snow stand out.



- You cannot change the white balance setting.



Aerial photo mode

Allows you to take pictures through an airplane window.

■ Technique for Aerial photo mode

Use this technique if it is difficult to focus when taking pictures of clouds etc. Aim the camera at something with high contrast, press the shutter button halfway to fix the focus, then aim the camera at the subject and press the shutter button fully to take the picture.



- Turn the camera off when taking off or landing.
- When using the camera, follow all instructions from the cabin crew.
- The focus range is 5 m (16.4 feet) to ∞.
- Be careful about the reflection from the window.
- The flash setting is fixed to Forced Flash OFF [☀].
- The setting on the AF assist lamp is disabled.
- You cannot change the white balance setting.

Motion Picture Mode

Set the recording/playback switch to the recording [📷]. (P18)



- 1 Press [MODE], select [🎬 MOTION PICTURE] using ▲/▼, and press [MENU/SET] again.

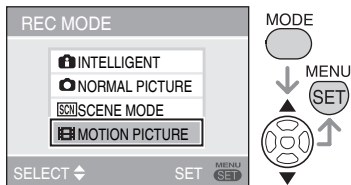

- 2 Press the shutter button halfway to focus and then press it fully to start recording.

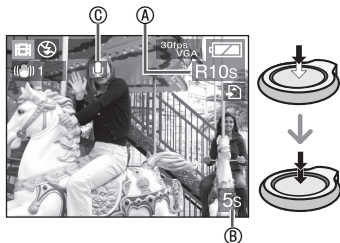

Ⓐ Available recording time

Ⓑ Elapsed recording time

Ⓒ Audio recording

- The audio is also recorded through the microphone.
- When the subject is focused, the focus indication lights.
- The focus, zoom and aperture value are fixed to those set at the beginning of recording (for the first frame).
- While you keep pressing the shutter button, the motion picture is recorded without audio for the first few seconds.

- 3 Press the shutter button fully to stop recording.

- If the built-in memory or the card becomes full in the middle of recording, the camera stops recording automatically.

- Changing the aspect ratio and the picture quality settings

- 1 Press [MENU/SET].

- 2 Press ▲/▼ to select [ASPECT RATIO] and then press ►.

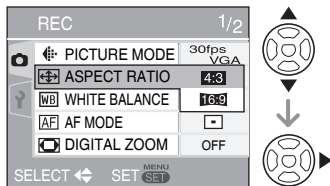

- 3 Press ▲/▼ to select the item and then press [MENU/SET].

- 4 Press ▲/▼ to select [PICTURE MODE] and then press ►.

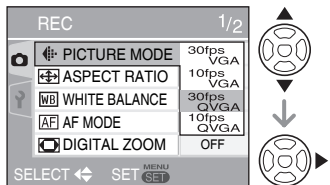

- 5 Press ▲/▼ to select the item and then press [MENU/SET].

- When the aspect ratio setting is [4:3]

Item	Picture size	fps
30fpsVGA	640 × 480 pixels	30 fps
10fpsVGA	640 × 480 pixels	10 fps
30fpsQVGA	320 × 240 pixels	30 fps
10fpsQVGA	320 × 240 pixels	10 fps

■ When the aspect ratio setting is

[16:9]

Item	Picture size	fps
30fps16:9	848 × 480 pixels	30 fps
10fps16:9	848 × 480 pixels	10 fps

- fps (frame per second); This refers to the number of frames used in 1 second.
- You can record smoother motion pictures with 30 fps.
- You can record longer motion pictures with 10 fps although the picture quality is lower.
- [10fpsQVGA]:
The file size is smaller, so the files are suitable to be attached to e-mails.
- * Set [ASPECT RATIO] to [4:3] and the [PICTURE MODE] to [30fpsQVGA] or [10fpsQVGA] (320 × 240 pixels) when you record motion pictures to the built-in memory.

6 Press [MENU/SET] to close the menu.

- **You can also press the shutter button halfway to close the menu.**



- When you use the optical image stabilizer function, only [MODE1] is available in motion picture mode.
- Refer to P109 for information about the available recording time.
- The remaining recordable time shown on the LCD may not reduce regularly.
- This camera cannot take motion pictures if you are using a MultiMediaCard.
- When [PICTURE MODE] is set to [30fpsVGA] or [30fps16:9], we recommend that you use cards offering “10 MB/s” or higher speeds (printed on their packages and elsewhere) for best results.
- Depending on the type of SD Memory Card or SDHC Memory Card, recording may stop in the middle.

• We recommend using Panasonic’s SD Memory Card/SDHC Memory Card.

- Depending on the type of card you are using, the card access indication may appear for a while after shooting motion pictures. This is normal.
- The volume of motion picture is limited to 2 GB per recording session. The maximum available recording time for up to 2 GB only is displayed on the screen.
- When motion pictures recorded with this camera are played back on other equipment, the quality of pictures may be deteriorated or it may not be possible to play them back. Also the recording information may not be displayed correctly.
- When the brightness of the subject is changed, the lens operation noise may be recorded.
- In motion picture mode [] the following functions cannot be used.
 - Direction detection function
 - [MODE2] on the optical image stabilizer function
- To hear audio recorded with movie, recording must be played back on a computer. This camera is not equipped with a speaker.

Vacation Date Recording



By setting the departure and return dates, you can record which date of the vacation you take a picture. The day of the vacation **A** is shown when you play a picture and you can add it to the picture for printing with [TEXT STAMP] (P76).

- When you play back a picture, the date on which it was taken is displayed.

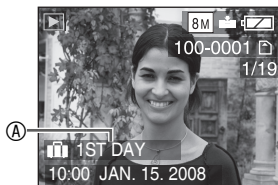

- The number of days that have passed since the departure date can be printed on each picture by using the software [PHOTOfunSTUDIO-viewer-] in the CD-ROM (supplied). (For information about printing, refer to the separate operating instructions (PDF file) of the software.)

■ Setting the travel date

(Screen shows an example for the normal picture mode [📷])

- 1 Press [MENU/SET] and then press **◀**.
- 2 Press **▼** to select the [SETUP] menu icon [⌘] and then press **▶**.
- 3 Press **▲/▼** to select [TRAVEL DATE] and then press **▶**.

- 4 Press **▼** to select [SET] and then press [MENU/SET].

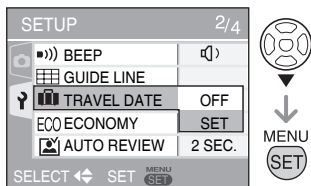

- 5 Press **▲/▼/◀/▶** to select the departure date and then press [MENU/SET].

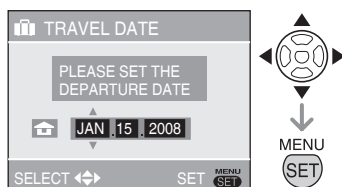

- ◀/▶: Select the desired item.
- ▲/▼: Set the year, month and date.

- 6 Press **▲/▼/◀/▶** to set the return date and then press [MENU/SET].

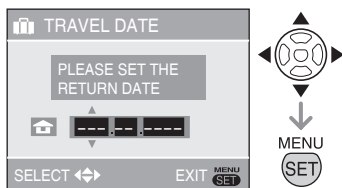

- ◀/▶: Select the desired item.
- ▲/▼: Set the year, month and date.
- The travel date is cleared if the current date is after the return date.
- If you have not set the return date, press [MENU/SET] while “---” is displayed.

- 7 Press [MENU/SET] to exit the menu.

8 Take a picture.



- The day of the vacation **A** appears for about 5 seconds after setting the travel dates and when the camera is turned on when the travel date is set.
- When [TRAVEL DATE] is set,  appears on the lower right of the screen. (It is not displayed if the current date is after the return date.)

■ Canceling the travel date

The travel date is cleared if the current date is after the return date. If you want to cancel part way through the setting, select [OFF] in step 4 and press [MENU/SET] twice.



- The travel date is calculated using the date in the clock setting and the departure date you set. If you set [WORLD TIME] to the travel destination, the travel date is calculated using the date in the clock setting and the travel destination setting.
- The travel date setting is memorized even if the camera is turned off.
- If you set a departure date and then take a picture on a date before this departure date, [-] (minus) is displayed in orange and the day of the vacation that you took the picture is not recorded.
- If you set a departure date and then change the clock setting to the date and time at the travel destination, [-] (minus) is displayed in white and the day of the vacation that you took the picture on is recorded when the travel destination date is, for example, one day before the departure date.
- If [TRAVEL DATE] is set to [OFF], the number of days that have passed since the departure date will not be recorded even if you set the travel date. Even if [TRAVEL DATE] is set to [SET] after taking the pictures, the day of the vacation you took them on is not displayed.
- Set the clock if the message "PLEASE SET THE CLOCK" appears.
- The travel dates are also used in the Intelligent mode .

Displaying the Time at the Travel Destination



If you set your home area and the travel destination area when traveling abroad etc., the local time at the travel destination area can be displayed on the screen and recorded on the pictures taken.

- Select [CLOCK SET] to set the current date and time in advance. (P17)

1 Press [MENU/SET] and then press ◀.

2 Press ▼ to select the [SETUP] menu icon [⚙] and then press ▶.

3 Press ▲/▼ to select [WORLD TIME] and then press ▶.

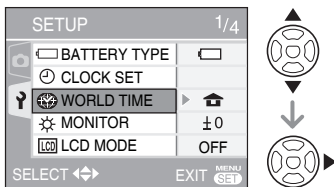

- If you are setting the world time for the first time, the message [PLEASE SET THE HOME AREA] appears. If this message appears, press [MENU/SET] and then set home area from the screen shown in step ② in “Setting the home area [HOME]”.

■ Setting the home area [HOME]

(Perform steps 1, 2 and 3.)

- ① Press ▼ to select [HOME] and then press [MENU/SET].



- ② Press ◀▶ to select your home area and then press [MENU/SET].

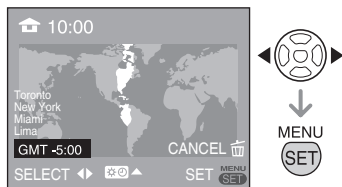

- The current time is displayed on the top left of the screen and the time difference from GMT (Greenwich Mean Time) is displayed on the bottom left of the screen.
- If daylight saving time [☀🌙] is used at the home area, press ▲. Press ▲ again to return to the original time.
- The daylight saving time setting for the home area does not advance the current time. Advance the clock setting by one hour.

Finishing setting the home area

- If you are setting the home area for the first time, the screen returns to the screen shown in step ① of “Setting the home area [HOME]” after you press [MENU/SET] to set your home area.
- If the travel is not planned for a long period of time, press w to return to the screen shown in step 3 and then press [MENU/SET] to close the menu.
- Press ◀ to return to the screen shown in step 3 and then press [MENU/SET] to close the menu.
- If you are setting the home area for the second time etc., the screen returns to the screen shown in step 3 after you press [MENU/SET] to set your home area. Press [MENU/SET] again to close the menu.

■ Setting the travel destination area

(Perform steps 1, 2 and 3 on P57.)

- 1 Press **▲** to select [DESTINATION] and then press [MENU/SET] to set.

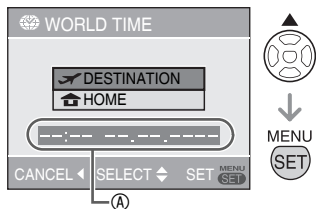

- 2 Depending on the setting, the time at the travel destination area or the home area is displayed.

- If you are setting the travel destination area for the first time, the date and time are displayed as shown in the screen above.

- 2 Press **◀▶** to select the area the travel destination is in and then press [MENU/SET] to set.

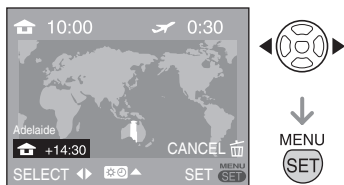

- The current time at the selected travel destination area is displayed on the top right of the screen and the time difference from the home area is displayed at the bottom left of the screen.
- If daylight saving time **[☀️⌚]** is used in your travel destination, press **▲**. (The time advances by one hour.) Press **▲** again to return to the original time.

- 3 Press [MENU/SET] to close the menu.

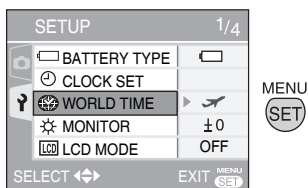

- The icon changes from **[🏠]** to **[✈️]** after setting the travel destination.



- Return the setting to [HOME] when the vacation is finished by performing steps 1, 2, 3 and then steps 1 and 2 of "Setting the home area [HOME]" (P57).
- If you cannot find the travel destination in the areas displayed on the screen, set by the time difference from the home area.
- Now when you play photographs taken while on holiday, the travel icon **[✈️]** appears.

Using the [REC] Mode Menu



Setting the color/hue, picture quality adjustment, etc. allows you to create wide variations on taking pictures. The menu items that can be set differ depending on the recording mode.

■ Using the [REC] mode menu

Press [MENU/SET] to show the recording menu, then select the item you want to change (P19).

Items you can set

(In normal picture mode [📷])

Menu page	Item
Page 1	PICTURE SIZE (P60)
	QUALITY (P60)
	ASPECT RATIO (P61)
	INTELLIGENT ISO (P61)
	SENSITIVITY (P62)
Page 2	WHITE BALANCE (P62)
	AF MODE (P64)
	QUICK AF (P64)
	BURST (P65)
	DIGITAL ZOOM (P33)
Page 3	COLOR MODE (P65)
	STABILIZER (P66)
	AF ASSIST LAMP (P66)
	CLOCK SET (P17)

■ Using the quick setting

You can use the [Q.MENU] button to easily set the following items when recording (In normal picture mode [📷]).

- [STABILIZER]
- [BURST]
- [AF MODE]
- [WHITE BALANCE]
- [SENSITIVITY]
- [PICTURE SIZE]
- [LCD MODE]

The items that can be set differ depending on the recording mode.

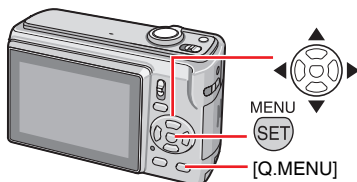

- 1 In shooting mode, press and hold [Q.MENU] until the quick setting items appear.



- 2 Press to select the menu item and setting and then press [MENU/SET] to close the menu.



- You can also close the menu by pressing [Q.MENU].



- In quick setting, [📷 SET] (white set) setting for white balance does not appear.

Press **[MENU]** to display the [REC] mode menu and select the item to set. (P19)

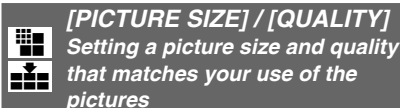

A digital picture is made of numerous dots called pixels. Although you cannot see the difference on the camera's screen, the more the pixels the finer the picture will be when it is printed on a large piece of paper or displayed on a computer monitor. Picture quality refers to the compression rate when saving digital pictures.

■ Number of pixels



Select a higher number of pixels for clearer pictures when printing.

Select a lower number of pixels to store more pictures. Fewer pixels also means it is easier to send pictures by e-mail or use them on a homepage.

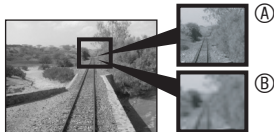

Ⓐ Many pixels (Fine)

Ⓑ Few pixels (Rough)

* These pictures are examples to show the effect.

When the aspect ratio setting is [4:3]

[8M] (8M)	3264 × 2448 pixels
[5M] (5M EZ)	2560 × 1920 pixels
[3M] (3M EZ)	2048 × 1536 pixels
[2M] (2M EZ)*	1600 × 1200 pixels
[0.3M] (0.3M EZ)	640 × 480 pixels

* Cannot be set in Intelligent mode **[i]**

When the aspect ratio setting is [3:2]

[7M] (7M)	3264 × 2176 pixels
[4.5M] (4.5M EZ)	2560 × 1712 pixels
[2.5M] (2.5M EZ)	2048 × 1360 pixels

When the aspect ratio setting is [16:9]

[6M] (6M)	3264 × 1840 pixels
[3.5M] (3.5M EZ)	2560 × 1440 pixels
[2M] (2M EZ)	1920 × 1080 pixels

■ Quality



	Fine (Low compression): This type gives priority to picture quality. Picture quality will be high.
	Standard (High compression): This type gives priority to the number of recordable pictures and records standard quality pictures.



- The number of pixels that can be selected differs depending on the aspect ratio. If you change the aspect ratio, set the picture size.
- [EZ] is an abbreviation of [Extended optical Zoom].
- The extended optical zoom does not work in [HIGH SENS.] and [HI-SPEED BURST] mode, so the picture size for [EZ] is not displayed.
- Pictures may have a mosaic-like appearance depending on the subject or the recording condition.
- Refer to P107 for the number of recordable pictures.
- The number of recordable pictures vary depending on the subject.
- The number of recordable pictures displayed on LCD monitor may not correspond with recorded pictures.

Press  to display the [REC] mode menu and select the item to set. (P19)



[ASPECT RATIO]



Setting the aspect ratio of pictures

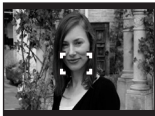

By changing the aspect ratio, you can select an angle of view that matches the subject.

<p>4:3</p>	<p>Select to take pictures with the same aspect ratio as a 4:3 TV or a computer monitor.</p> 
<p>3:2</p>	<p>Select to take pictures with the same 3:2 aspect ratio as 35 mm film.</p> 
<p>16:9</p>	<p>This is suitable for landscapes etc. where a wide view is preferable. This is also suitable for playing back pictures on a wide-screen TV, high-definition TV etc.</p> 



- You cannot choose **[3:2]** during motion picture mode **[iH]**.
- The ends of the recorded pictures may be cut at printing.

[INTELLIGENT ISO]



Changing ISO sensitivity automatically



The camera detects the movement of the subject and then sets the optimal ISO sensitivity and shutter speed according to the movement and the brightness of the subject.

The settings listed below indicates the selectable highest ISO sensitivity.

OFF	Intelligent ISO does not work.
ISO MAX400	[MAX] shows the maximum level of ISO sensitivity.
ISO MAX800	The ISO sensitivity automatically increases up to the set value.

-  displays when you press the shutter button halfway. If you press it fully, the shutter speed and ISO sensitivity will be displayed.
- Jitter is avoided when taking pictures indoors of a moving subject by increasing the ISO sensitivity and making the shutter speed faster. (However, picture noise will increase.)
- Noise is avoided when taking pictures indoors of a subject with no movement by decreasing the ISO sensitivity.



- Depending on the brightness and how fast the subject is moving, jitter may not be avoided.
 - When the moving subject is small
 - When the moving subject is at the edge of the screen
 - When the subject starts moving the instant the shutter button is pressed fully.
- To avoid picture noise, we recommend setting [COLOR MODE] to [NATURAL].
- The digital zoom cannot be used.

Press  to display the [REC] mode menu and select the item to set. (P19)



[SENSITIVITY]

Setting the light sensitivity



ISO sensitivity represents the sensitivity of the image sensor to light. If you set the ISO sensitivity higher, the camera becomes more suitable for recording in dark places.

- When setting to [AUTO], the ISO sensitivity is automatically adjusted to a maximum of [ISO400] according to the brightness. (When using the flash, the adjustment range becomes a maximum of [ISO1000].)

ISO sensitivity	100  1600	
Use in bright places (e.g. outdoors)	Suitable	Not suitable
Use in dark places	Not suitable	Suitable
Shutter speed	Slow	Fast
Noise	Less	More



- The ISO sensitivity automatically changes between [ISO1600] and [ISO6400] in [HIGH SENS.] mode.
- To avoid picture noise we recommend reducing the ISO sensitivity or setting [COLOR MODE] to [NATURAL].
- ISO sensitivity cannot be set when the intelligent ISO is used.









[WHITE BALANCE]

Adjusting the hue for a more natural picture



This function allows you to reproduce a white color closer to the tone in real life on the pictures recorded under sunlight, halogen lighting, etc. in which the white color may appear reddish or bluish. Select a setting that matches the recording conditions.

AWB	for auto setting (auto white balance)
 (Daylight)	for recording outdoors on a bright day
 (Cloudy)	for recording outdoors on a cloudy day
 (Shade)	for recording in shaded areas outdoors on a bright day
 (Halogen)	for recording under halogen lighting
 (White set)	for using the preset white balance
 (White set)	for using set mode with a different white balance setting

- The optimum white balance under fluorescent lights depends on the type of light, so use [AWB] or [ SET].

Press **[MENU/SET]** to display the [REC] mode menu and select the item to set. (P19)

■ Auto White Balance (AWB)

Use of auto white balance adjustment in inappropriate lighting conditions may result in reddish or bluish pictures. Where the subject is surrounded by many light sources or there are no white or whitish objects in the frame, auto white balance adjustment may not operate properly. In this case, set the white balance to a mode except [AWB] manually.

- 1 The range that is controlled by the auto white balance adjustment mode of this camera
- 2 Blue sky
- 3 Cloudy sky (Rain)
- 4 Shade
- 5 TV screen
- 6 Sunlight
- 7 White fluorescent light
- 8 Incandescent light bulb
- 9 Sunrise and sunset
- 10 Candlelight

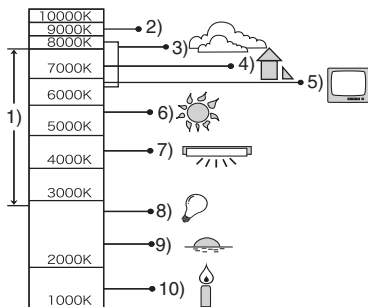

K=Kelvin Color Temperature

■ Setting the white balance manually (White set SET)

- 1 Select [ SET] (White set) and then press [MENU/SET].
- 2 Aim the camera at a sheet of white paper or a similar white object so that the frame on the center of the screen turns white and then press [MENU/SET].

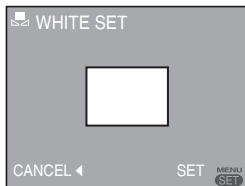

- 3 Press [MENU/SET] twice to close the menu.
 - You can also press the shutter button halfway to finish.



- The white balance you set is saved even if you switch the camera off, but if you change the scene mode, the white balance setting returns to [AWB].
- The white balance may not be correct if the subject is out of flash range.
- The white balance cannot be set in the following modes:
 - [SCENERY], [NIGHT SCENERY], [NIGHT PORTRAIT], [FOOD], [PARTY], [CANDLE LIGHT], [SUNSET], [BEACH], [STARRY SKY], [FIREWORKS], [SNOW], or [AERIAL PHOTO]



Press **[MENU]** **[SET]** to display the [REC] mode menu and select the item to set. (P19)



■ AF MODE

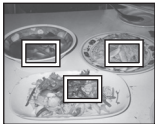

Select the mode that matches the recording conditions and the composition.

	<p>5-area-focusing: The camera focuses on any of 5 focus areas. This is effective when the subject is not in the center of the screen.</p> 
	<p>1-area-focusing (high speed): The camera quickly focuses on the subject in the AF area on the center of the screen.</p> 
	<p>1-area-focusing: The camera focuses on the subject in AF area on the center of the screen.</p> 

■ About 1-area-focusing (High speed)

- You can focus on the subject more quickly than other AF modes.
- Pictures may become still in the condition they were in before the subject was focused when you press the shutter button halfway. However, it is not a malfunction.



- When using the digital zoom or when you take pictures in dark places, the AF area is displayed on the center of the screen with a size wider than usual.
- When multiple AF areas (max. 5 areas) light at the same time, the camera is focusing on all the AF areas. The focus position is not predetermined because it is set to the position the camera automatically determines at the time of focusing. If you want to determine the focus position to take pictures, switch the AF mode to 1-area-focusing or 1-area-focusing (high speed) mode.
- In 5-area focusing mode, AF areas are not displayed until the camera focused on a subject.
- AF mode is fixed to 5-area focusing mode in [SELF PORTRAIT] mode.
- The AF mode cannot be set in [FIREWORKS] mode.



■ QUICK AF



When quick AF is set to [ON] focusing will be faster when the shutter button is pressed as the camera automatically adjusts the focus when there is not much jittering.





- Quick AF is fixed to [ON] in Intelligent mode .
- Quick AF cannot be set in the following modes:
[NIGHT PORTRAIT], [NIGHT SCENERY], [STARRY SKY] or [FIREWORKS].

Press  to display the [REC] mode menu and select the item to set. (P19)



[BURST] Shooting in quick succession



When you press and hold the shutter button several pictures are taken in succession.

Burst mode		
Burst speed	2.5 fps *	Approx. 2 fps
Number of recordable pictures	 Max. 4 frames	Depending on the remaining capacity of the built-in memory / card.
	 Max. 7 frames	

* The burst speed is constant regardless of the transfer speed of the card.

- The focus is fixed when the first picture is taken. The exposure and the white balance vary depending on the burst mode setting. (When burst mode is set to , they are fixed to the values set for the first picture and when the burst speed is set to , they are adjusted each time you take a picture.)
- When the self-timer is used, the number of recordable pictures in burst mode is fixed to 3.
- In burst mode, the flash setting is fixed to Forced Flash OFF .



- When the burst mode setting is set to , the burst speed becomes slower halfway. (The exact timing of this depends on the type of card and each settings.)
- The burst speed may become slower if the ISO sensitivity is set to high or in dark places.
- If you are following a moving subject while taking pictures in a place where there is a large difference between the light and shade, the exposure may not become optimal.

- If you take pictures in burst mode with the built-in memory, it will take time to write the picture data.
- In burst mode, auto review is activated even if the setting is off.
- Burst mode cannot be set in [STARRY SKY] and [HI-SPEED BURST] modes.
- Auto bracket mode setting is canceled when [BURST] is activated.



[COLOR MODE] Setting color effects for the recorded pictures



You can use following types of color effects depending on the image of the picture.

Item	Setting
STANDARD	Standard setting
NATURAL	Shoot softer pictures
VIVID	More vivid picture
B/W	Black and white
SEPIA	Sepia colored pictures
COOL	More blue
WARM	More red



- Picture noises might stand out when taking a picture in a dark place. To avoid picture noises we recommend setting [COLOR MODE] to [NATURAL].
- [COOL] or [WARM] cannot be set in intelligent mode . Also, [NATURAL] or [VIVID] cannot be set in motion picture mode . Each recording modes are set independently.



Press  to display the [REC] mode menu and select the item to set. (P19)

[STABILIZER]





This feature detects jitter and corrects for it



MODE1 	The stabilizer operates continuously and can assist during photo composition.
MODE2 	The jitter is compensated for when the shutter button is pressed. There is a greater stabilizing effect.
OFF 	When image stabilization is not desired. e.g. When using a tripod.



- The stabilizer function may not work in the following cases so take special care not to move the camera when pressing the shutter button.
 - When too much jitter occurs.
 - When the zoom magnification is high.
 - In digital zoom range.
 - When taking pictures while following subjects in motion.
 - When the shutter speed is extremely slow due to dark conditions or other reasons.
- In Intelligent mode , [OFF] is not selectable.
- It is fixed to [MODE2] in [SELF PORTRAIT] mode and [OFF] in [STARRY SKY] mode.
- In motion picture mode , [MODE2] cannot be set.

[AF ASSIST LAMP]



Focusing in low light conditions becomes easier



Illuminating the subject with the AF assist lamp allows the camera to focus on the subject in low light conditions. If the AF assist lamp is set to [ON], an AF area with a size wider than usual is displayed and the AF assist lamp  turns on.

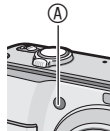

ON	The AF assist lamp turns on under low light conditions. In this time, the AF assist lamp icon  appears on the screen. The effective range of the AF assist lamp is 1.5 m (4.92 feet).
OFF	The AF assist lamp does not turn on.



- Be sure of the following points when the AF assist lamp is in use.
 - Do not look into the AF assist lamp closely.
 - Do not cover the AF assist lamp with your fingers or other objects.
- When you do not want to use the AF assist lamp (e.g. when you take a picture of animals in a dark place), set the [AF ASSIST LAMP] to [OFF]. In this case, it becomes difficult to focus on the subject.
- The AF assist lamp is fixed to [ON] while the camera is in intelligent mode .
- You cannot use the AF assist lamp in [SELF PORTRAIT], [SCENERY], [NIGHT SCENERY], [SUNSET], [FIREWORKS] and [AERIAL PHOTO].
- [OFF] is set as initial setting in [PET] mode.

Displaying Multiple Screens (Multi Playback)



1 Rotate the zoom lever towards [] [W] to display multiple screens.



For example: When you have chosen to show 12 pictures

- [] : 1 screen → 12 screens → 30 screens → Calendar screen display (P68)
- Rotate the zoom lever towards [Q] [T] to return to the previous screen.

2 Press ▲/▼/◀/▶ to select a picture.

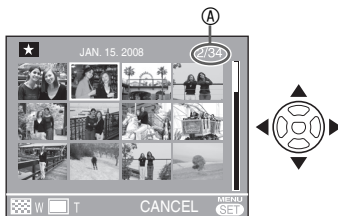

- Ⓐ Number of the selected picture and the total number of recorded pictures.

- Depending on the recorded picture and the setting, the following icons will appear.
 - [★] (Favorites)
 - [] (Motion picture)
 - [] ([BABY1] / [BABY2] mode), [] ([PET] mode)
 - [] (Travel date)
 - [] (Travel destination)
 - [] (Text stamp complete)
 - [] (Title edit complete)

■ Example of 30 screens

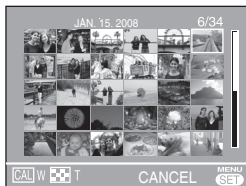

■ To return to the normal playback

Rotate the zoom lever towards [Q] [T], or press [MENU/SET].

- The image you select is shown.

■ To delete a picture during a multi playback

- 1 Press ▲/▼/◀/▶ to select a picture and then press [].
- 2 Press ◀ to select [YES].
- 3 Press [MENU/SET].



- During multi playback, you cannot clear the shooting information from the display by pressing [DISPLAY].
- Pictures will not be displayed in the rotated direction even if [ROTATE DISP.] is set to [ON].
- Pictures will be displayed only in 12 screens during category playback [] and favorite [★] playback.
- Multi playback cannot be activated during in slide show [].

Displaying Pictures by Recording Date (CAL CALENDAR)



You can display pictures by recording date using the calendar function.

1 Rotate the zoom lever towards [] [W] several times to display the calendar screen.



- The recording date of the picture selected in the playback screen becomes the date selected when the calendar screen is first displayed.
- If there are multiple pictures with the same recording date, the first picture recorded on that day is displayed.

2 Press ▲/▼/◀/▶ to select the date to be played back.

▲/▼: Select the month

◀/▶: Select the date

- If there were no pictures recorded during a month, the month is not displayed.

3 Press [MENU/SET] to display the pictures that were recorded on the selected date.



- To return the calendar screen, press [].

4 Press ▲/▼/◀/▶ to select a picture and then press [MENU/SET].

- The selected picture is displayed on the 1 screen playback screen.

■ To return to the 1 screen playback screen

After the calendar screen is displayed, rotate the zoom lever towards [Q] [T] to display 30 screens, 12 screens and 1 screen.



- The pictures are displayed without being rotated even if you set [ROTATE DISP.] to [ON].
- You can display the calendar between January 2000 and December 2099.
- If the recording date of the picture selected in 30 screens multi playback is not between January 2000 and December 2099, the camera automatically displays it in the latest calendar date.
- Pictures edited on a PC or processed on other equipment may be displayed with dates different from the actual recording dates.
- If the date is not set in the camera, the recording date is set as January 1st, 2008.
- If you take pictures after setting the travel destination in [WORLD TIME], the pictures are displayed by the dates at the travel destination in calendar playback.

Using the Playback Zoom



1 Rotate the zoom lever towards [Q] [T] to enlarge the picture.



- **Q**: 1x→2x→4x→8x→16x
- When you rotate the zoom lever towards [W] after enlarging the picture, the magnification becomes lower. When you rotate the zoom lever towards [Q] [T], the magnification becomes higher.
- When you change the magnification, the zoom position indication **A** appears for about 1 second to check the position of the section enlarged.

2 Press ▲/▼/◀/▶ to move the position.



- When you move the position to be displayed, the zoom position indication is displayed for about 1 second.

■ To stop using the playback zoom

Rotate the zoom lever towards [W] or press [MENU/SET].

■ To delete a picture during the playback zoom

- 1 Press [DELETE].
- 2 Press ◀ to select [YES].
- 3 Press [MENU/SET].



- During playback zoom, you can press [DISPLAY] to show or clear the shooting information.
- The more the picture is enlarged, the more its quality deteriorates.
- If you want to save the enlarged picture, use the trimming function. (P79)
- The playback zoom may not operate if pictures have been recorded with other equipment.

Playing Back Pictures Automatically Slide Show

Set the recording/playback switch to the playback . (P18)

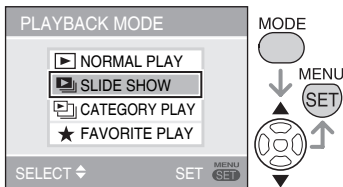

Playing back pictures automatically in order. Recommended when viewing on TV screen, etc.

- 1 Press [MODE], select  SLIDE SHOW] using ▲/▼ and press [MENU/SET].**

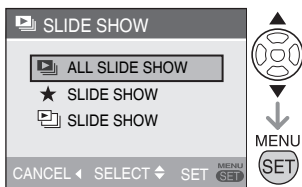

- 2 Select a slide show item with ▲/▼ and press [MENU/SET].**



	All pictures
★	Pictures set as FAVORITE (P82). Set [FAVORITE] to [ON] and set any pictures as favorites.
	Pictures categorized as desired (P72). (You cannot select a category that is not registered as category slide show.)

- 3 Select [START] with ▲ and press [MENU/SET].**

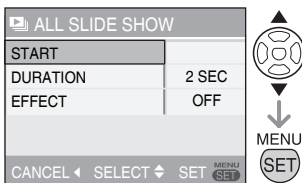

- The cursor displayed during playback corresponds to ▲/▼/◀/▶.

To finish the slide show 

Press ▼.

Pausing

Press ▲ during playback.



Pause will be released when you press ▲ again.

■ To set playback duration

- Select [DURATION] in step 3 and press ▶.
- Select seconds (1, 2, 3, 5, MANUAL) with ▲/▼ and press [MENU/SET].
 - You can select [MANUAL] only when either ★ or  is set in step 2. Press ◀▶ to switch pictures in playback.

■ To set the effect of switching pictures.

- Select [EFFECT] in step 3 and press ▶.
- Select the effect with ▲/▼ and press [MENU/SET].

OFF	Not effective
	Switch while sliding.
	Switch with fade-in and fade-out.
	From center to corners.
MIX	An effect is selected at random.

If you set [DURATION] to [MANUAL] the settings in [EFFECT] are disabled.



- The following functions cannot be used for slide show .
 - Playing back motion pictures
 - Power save (However, the setting for power save mode is fixed to [10MIN.] while pausing a slide show.)

Searching by Recording Information

Category Play

Set the recording/playback switch to the playback . (P18)

You can perform category playback by classifying pictures according to the recording information such as scene mode ([PORTRAIT], [SCENERY], etc.).

1 Press [MODE], select  CATEGORY PLAY using $\blacktriangle/\blacktriangledown$ and press [MENU/SET].

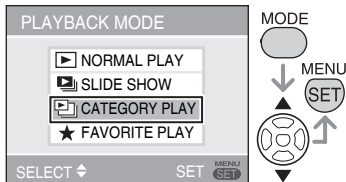







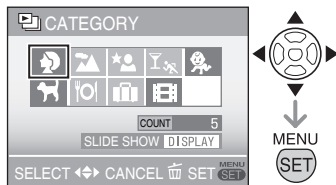

Category search starts.

- If a picture is found in a category, the category icon turns blue.
- The more pictures there are, the more time it takes to search.
- Press [] to cancel searching.



2 Select category using $\blacktriangle/\blacktriangledown/\blacktriangleleft/\blacktriangleright$ and press [MENU/SET].



Category	Recording information such as scene
 (PORTRAIT etc.)	PORTRAIT, SOFT SKIN, SELF PORTRAIT, NIGHT PORTRAIT, BABY1, 2
 (SCENERY etc.)	SCENERY, SUNSET, AERIAL PHOTO
 (NIGHT SCENERY etc.)	NIGHT PORTRAIT, NIGHT SCENERY, STARRY SKY
 (EVENTS)	SPORTS, PARTY, CANDLE LIGHT, FIREWORKS, BEACH, SNOW, AERIAL PHOTO
	BABY1, 2
	PET
	FOOD
	TRAVEL DATE
	Motion Picture

3 Select a picture using $\blacktriangleleft/\blacktriangleright$.



- Turn the zoom lever to  (W) and 12 screen will be displayed. Turn to  (T) to enlarge pictures.
- If [\star FAVORITE] is set to [ON], you can register the pictures as favorite by pressing \blacktriangledown . (P82)



- When one of the following operations is done, the category playback mode [P] is canceled.
 - Changes the mode to other playback mode or to recording mode
 - Turns the camera [OFF]

■ To perform category slide show

1. On step 2, select category with ▲/▼/◀/▶ you want to play back and press [DISPLAY].
2. Select [START] using ▲ and press [MENU/SET].
 - Refer to P70 for details on slide show.
 - Motion pictures cannot be played back in slide show.

■ To register the category slide show

If you register a category, you can easily play back the pictures in the set category as a slide show (P71).

1. On step 2, press ▲/▼/◀/▶ to select the category to play back and then press [DISPLAY] to set.
2. Select [SLIDESHOW SETUP] using ▼ and press [MENU/SET].
3. Select [YES] using ▲ and press [MENU/SET].
 - You can register only one category slide show. If registered already, it will switch to the new registration.
 - If there are 1000 or more pictures, you can make a slide show with up to 999 pictures.

Playing Back Your Favorite Pictures (★ Favorite Play)

Set the recording/playback switch to the playback [▶]. (P18)

You can playback the pictures set as favorites only.

1 Press [MODE], select [★ FAVORITE PLAY] using ▲/▼ and press [MENU/SET].

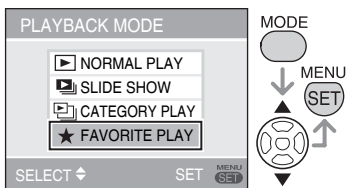

- [★ FAVORITE PLAY] does not appear when the [FAVORITE] is set to [OFF], and is not selectable if no picture is set as favorite.

2 Select a picture using ◀/▶.

- Turn the zoom lever to [W] and 12 screen will be displayed. Turn to [T] to enlarge pictures.

■ To cancel the favorite setting [★]

You may not be able to cancel the favorite in [★ FAVORITE PLAY]. If ▼ is pressed while the [★] favorites icon is displayed in [▶ NORMAL PLAY] or [P] CATEGORY PLAY] the favorites setting is canceled. (Refer to P82 for details.)



- When one of the following operations is done, the favorite play mode [★] is canceled.
 - Changes the mode to other playback mode or to recording mode
 - Turns the camera off

Playing Back Motion Pictures

Press to select a picture with a motion picture icon / / / / / and then press to play back.

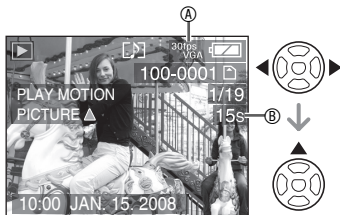

- The motion picture recording time is displayed on the LCD monitor. After playback starts, the elapsed playback time is displayed on the bottom right of the LCD monitor. For example, 8 minutes and 30 seconds is displayed as [8m30s].
- The cursor displayed during playback corresponds to .

To stop motion picture playback

Press .



Fast forwarding/Fast rewinding

During motion picture playback, keep pressing .

: Fast forward

: Fast rewind

- When releasing the button, it turns to normal motion picture playback.

To pause

Press during motion picture playback.

- Press again to cancel pause.

Frame-by-frame forward/reverse viewing

Press during pause.



- To hear audio recorded with movie, recording must be played back on a computer or TV. This camera is not equipped with a speaker (P87, 94)
- The file format that can be played back with this camera is QuickTime Motion JPEG.
- Please note that the bundled software includes QuickTime to play back motion picture files created with the camera on the PC (P87).
- Some QuickTime Motion JPEG files recorded by a PC or other equipment may not be played back with this camera.
- When playing back motion pictures that have been recorded with other equipment, the quality of pictures may be deteriorated or it may not be possible to play them back.
- When using a high capacity card, it is possible that fast rewinding may be slower than usual.
- You cannot use the following functions with motion pictures.
 - Playback zoom (While playing back or pausing motion pictures)
 - [ROTATE]/[ROTATE DISP.]
 - [TITLE EDIT]
 - [TEXT STAMP]
 - [RESIZE]/[TRIMMING]
 - [ASPECT CONV.]

Using the [PLAYBACK] Mode Menu



You can use various functions in playback mode to rotate pictures, set protection for them etc.

1 Press [MENU/SET].

2 Press ▲/▼ to select the menu item and then press ►.

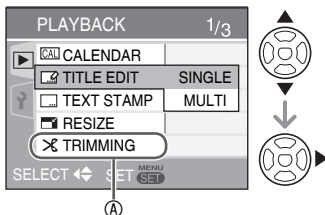

- Press ▼ at ① to switch to the next menu screen.
- You can switch menu screens from any menu item by rotating the zoom lever.
- **After selecting a menu item in step 2, refer to the description of the menu item in the operating instructions and then set it.**

Items you can set

Menu Page	Item
Page 1	CALENDAR (P74)
	TITLE EDIT (P74)
	TEXT STAMP (P76)
	RESIZE (P78)
	TRIMMING (P79)
Page 2	ASPECT CONV. (P80)
	ROTATE (P81)
	ROTATE DISP. (P81)
	FAVORITE (P82)
	DPOF PRINT (P83)
Page 3	PROTECT (P85)
	COPY (P86)

- When saving the edited picture in [TEXT STAMP], [RESIZE], [TRIMMING] and [ASPECT CONV.], the picture will be saved as new file. Check remaining capacity of the card or built-in memory before using those functions.

[CALENDAR] Searching pictures at the date

You can search pictures by recording date using the calendar function.

Select [CALENDAR] in playback menu.



Refer to the step 2 - 4 on P68 for further operations.

[TITLE EDIT] Adding text (comments) to pictures

You can add text (comments) to pictures. After text has been registered, it can be included in prints using [TEXT STAMP] (P76). (Only alphabetic characters and symbols can be entered.)

Select [TITLE EDIT] from playback menu.

Press [MENU/SET] to display the [PLAYBACK] mode menu and select the item to set. (P74)

Common operation

Press ▲/▼ to select [SINGLE] or [MULTI] and then press [MENU/SET].

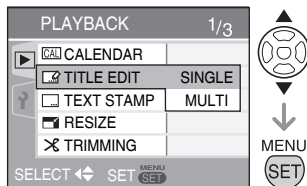

- Title edit cannot be used on the following pictures.

- Images recorded with other equipment
- Protected pictures
- Motion pictures

Single setting

After the common operation.

1 Select a picture using ◀▶ and press ▼.

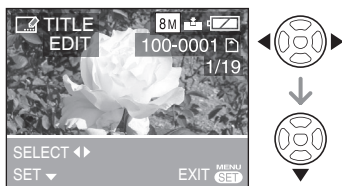

- The title edit icon (📝) is displayed for pictures that have already been recorded with text in [BABY] or [PET] name settings.

2 Select text using ▲/▼/◀▶ and press [MENU/SET] to register.

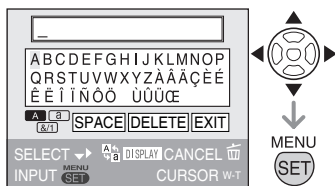

Text	Press [DISPLAY] to switch text between [A] (capitals), [a] (small case) and [&/1] (special characters and numbers).
Cursor	Rotate the zoom lever.
Blank	Move the cursor to [SPACE] and press [MENU/SET].
Delete	Move the cursor to [DELETE] and press [MENU/SET].

- Refer to next page for an example of the text entry.
- A maximum of 30 characters can be entered.
- To stop editing during text entry, press [🗑️].

3 Move the cursor to [EXIT] and press [MENU/SET] to finish text input.

4 Press [MENU/SET] twice to close the menu.

Multi setting (up to 50 pictures)

After the common operation.

1 Select the picture using ◀▶ and press ▼ to set/cancel.

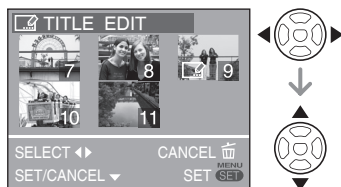

Set	The [📝] icon appears.
Cancel	The [📝] icon disappears.

- Repeat this step.

2 Press [MENU/SET].

After performing step 2, perform step 2-3 onwards in "Single setting". Press [MENU/SET] to close the menu.

Press [] to display the [PLAYBACK] mode menu and select the item to set. (P74)

■ Delete the title (for [SINGLE] only)











- In step 2 when [SINGLE] is selected, delete all the texts, select [EXIT], and press [MENU/SET].
- Press [MENU/SET] twice to close the menu.



- Registered text can be displayed on the screen of this unit. (Displayed on slide if too many texts are input.)
- The name setting of [BABY] or [PET] mode can be registered by using the same operation as “Single setting”. However, the name setting and [TITLE EDIT] cannot be registered at the same time.
- You can use the software [PHOTOfunSTUDIO-viewer-] on the CD-ROM (supplied) to print the text (comments). For details, refer to the operating instructions (PDF file) of the software.

Example of text entry

In case of entering [LUMIX]:

- Move / to move the cursor to [L] and then press [MENU/SET].
- Move / to move the cursor to [U] and then press [MENU/SET].
- Move / to move the cursor to [M] and then press [MENU/SET].
- Move / to move the cursor to [I] and then press [MENU/SET].
- Move / to move the cursor to [X] and then press [MENU/SET].

[TEXT STAMP] Stamping the text on your pictures

You can stamp the set text, date and time of recording, the age and the travel date on the recorded pictures.



This function is suitable when you print 4" x 6"/10 x 15 cm images. (Images are resized when you add the text to the pictures taken with a resolution of more than [3M].)

Select [] **TEXT STAMP** from playback menu (P74).

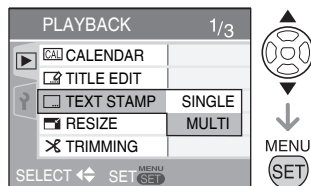
- Press / to select [SINGLE] or [MULTI] and press [MENU/SET].



- You cannot add the texts or the date to the following images.
 - Pictures taken when the clock is not set
 - Pictures imprinted with the text stamp
 - Motion pictures
 - Pictures recorded with other equipment

- Press  to choose a picture, then press .

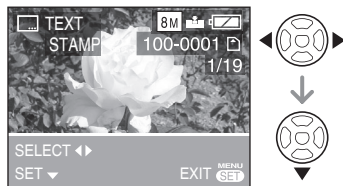

- When you have selected [SINGLE] in step 1, proceed to step 3. When you have selected [MULTI] in step 1, repeat step 2 for each pictures (up to 50). You can set or cancel the picture using . After you select the pictures, press [MENU/SET] and then proceed to step 3-5. Press [MENU/SET] to close the menu.

Press [MENU/SET] to display the [PLAYBACK] mode menu and select the item to set. (P74)

3 Press ▲/▼/◀/▶ to select [SHOOTING DATE], [AGE], [TRAVEL DATE] or [TITLE] and change the settings for the item, and then press [MENU/SET].

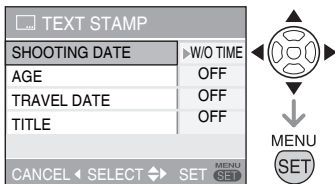

■ SHOOTING DATE

OFF	Date and time does not added
W/O TIME	Date added
WITH TIME	Date and time added

■ AGE

OFF	Age not added
ON	Age added

■ TRAVEL DATE

OFF	Travel dates not added
ON	Travel dates added

■ TITLE

OFF	Title or name is not added
ON	Title or name in [BABY] or [PET] mode is added

4 Press [MENU/SET].

- Images are resized as follows when you add the text to the pictures taken with a high resolution.

4:3	[5M] or more → [3M]
3:2	[4.5M] or more → [2.5M]
16:9	[3.5M] or more → [2M]

- The picture becomes slightly rougher.

5 Press ▲ to select [YES] and press [MENU/SET].

(Screen when you have chosen an image taken at [4:3])

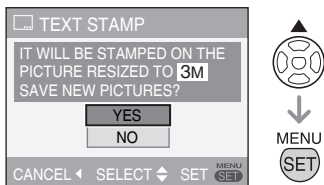

- If you select [NO], the screen returns to the one shown in step 2.

6 Press [MENU/SET] twice to close the menu.

- Pictures that have been text stamped will be marked with the text stamp complete indicator (A).
- To confirm the text stamp (B), use playback zoom (P69).

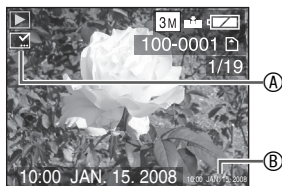

- Note that if you use text stamp and then specify printing the date when you order prints or on a printer, both dates will be printed and may overlap.**
- Make sure there is some space available on the built-in memory or card.
- The text may be cut off with some printers.
- The printed texts may be blurred on the pictures with the resolution of [0.3M].
- Once you have added the text stamp you will no longer be able to use the following functions with the pictures.
 - [TEXT STAMP]
 - Date print setting in [DPOF PRINT]
 - [RESIZE]
 - [TRIMMING]
 - [ASPECT CONV.]

Press [] to display the [PLAYBACK] mode menu and select the item to set. (P74)



[RESIZE]

Making the picture smaller

This function is useful if you want to reduce the file size of the picture in cases when it needs to be attached to an e-mail or uploaded to a website.

Select [] [RESIZE] from playback menu (P74).

1 Press   to select the picture and then press .



• The following pictures cannot be resized.

ASPECT RATIO	PICTURE SIZE
4:3	0.3M
3:2	2.5M
16:9	2M

- Motion pictures
- Pictures imprinted with the text stamp

2 Press   to select the size and then press .



• Sizes smaller than the recorded picture are displayed.

3 Press  to select [YES] and then press [MENU/SET].

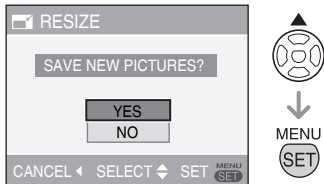

• If you select [NO], the screen returns to the one shown in step 2.

4 Press [MENU/SET] twice to close the menu.



- You may not be able to resize pictures you have taken using other equipment.
- The picture becomes slightly rougher.

Press [] to display the [PLAYBACK] mode menu and select the item to set. (P74)

[TRIMMING]

 *Enlarging a picture and trimming it*

Use this function when you trim unnecessary parts of the recorded picture.

Select [ TRIMMING] from playback menu (P74).



1 Press  to select the picture and then press .

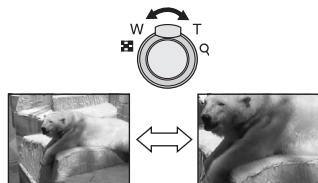

- The following pictures cannot be trimmed.
 - Motion pictures
 - Pictures imprinted with the text stamp

2 Enlarge or decrease the parts to be trimmed with the zoom lever.



3 Press , , , or  to move the position of the part to be trimmed.

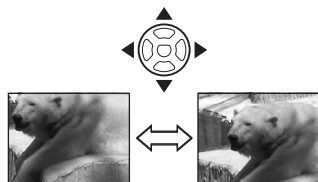

4 Press the shutter button.

5 Press  to select [YES] and then press [MENU/SET].

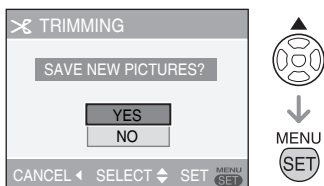

- If you select [NO], the screen returns to the one shown in step 2.

6 Press [MENU/SET] twice to close the menu.



- If you trim a picture, the number of pixels may be fewer in the trimmed picture than in the original.
- The picture quality of the trimmed picture may be deteriorated.
- It may not be possible to trim pictures recorded with other equipment.

Press [MENU/SET] to display the [PLAYBACK] mode menu and select the item to set. (P74)

[ASPECT CONV.] Changing the aspect ratio of a 16:9 picture

You can convert pictures taken with a [16:9] aspect ratio to a [3:2] or a [4:3] aspect ratio.

Select [ASPECT CONV.] from playback menu (P74).

1 Select [3:2] or [4:3] using ▲/▼ and then press [MENU/SET].

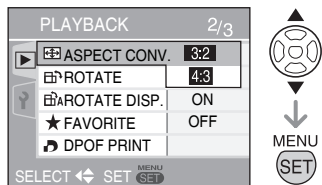

- The following pictures cannot be converted.
 - Motion pictures
 - Pictures imprinted with the text stamp

2 Press ◀▶ to select a picture and then press ▼.



- If you select and set a picture with an aspect ratio other than [16:9], the message [CANNOT BE SET ON THIS PICTURE] is displayed on the screen.

3 Press ◀▶ to determine the horizontal position and press the shutter button to set.



- Use ▼/▲ to set the frame position for pictures rotated vertically.

4 Press ▲ to select [YES] and then press [MENU/SET].

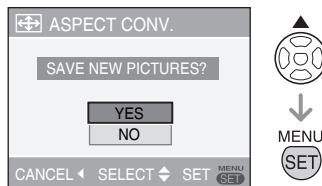

- If you select [NO], the screen returns to the one shown in step 3.

5 Press [MENU/SET] twice to close the menu.



- After converting the aspect ratio, the picture size may become larger than that of the original picture.
- Files that do not conform to the DCF standard cannot be converted.
- You may not be able to convert pictures taken on other equipment.

Press [MENU/SET] to display the [PLAYBACK] mode menu and select the item to set. (P74)



This mode allows you to automatically display pictures vertically if they were recorded holding the camera vertically or rotate pictures manually in 90° increments.

■ Rotate

(The picture is rotated manually.)

Select [ROTATE] from playback menu (P74).

- When [ROTATE DISP.] is set to [OFF], [ROTATE] function is disabled.

1 Press [LEFT/RIGHT] to select the picture and then press [DOWN].

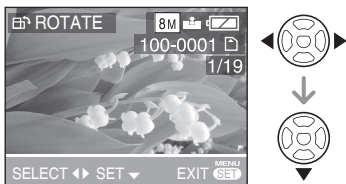

- Motion pictures and protected pictures cannot be rotated.

2 Press [UP/DOWN] to select the direction to rotate the picture and then press [MENU/SET].



	The picture rotates clockwise in increments of 90°.
	The picture rotates counter-clockwise in increments of 90°.

3 Press [MENU/SET] twice to close the menu.

■ Rotate display

(The picture is automatically rotated and displayed.)

Select [ROTATE DISP.] from playback menu (P74).

1 Press [DOWN] to select [ON] and then press [MENU/SET].

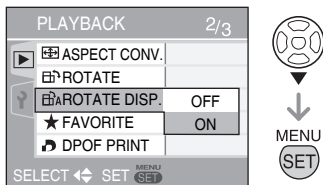

- When you select [OFF], the pictures are displayed without being rotated.

2 Press [MENU/SET] to close the menu.



- If you take pictures when aiming the camera up or down, it may not be possible to display the pictures vertically.
- The picture may be slightly blurred when the camera is connected to the TV with the AV cable (supplied) and played back vertically.
- When you play the picture on a PC, you cannot play rotated pictures without an OS or a software compatible with Exif. Exif is the file format for still pictures, to which recording information and other data can be added, established by JEITA [Japan Electronics and Information Technology Industries Association].
- Rotated pictures are displayed without being rotated when they are played back in multi playback.
- You may not be able to rotate images shot on other equipment.

Press [] to display the [PLAYBACK] mode menu and select the item to set. (P74)



[FAVORITE]

Setting your favorite pictures

You can do the following if a mark [★] has been added to pictures and they have been set as favorites.

- Play back the pictures set as favorite. (P72)
- Play back the pictures set as favorites only as a slide show. (P70)
- Delete all the pictures not set as favorites. ([ALL DELETE EXCEPT ★]) (P35)
- Print only the pictures set as favorites. (P91)

Select [★ FAVORITE] from playback menu (P74).

1 Press ▲/▼ to select [ON] and then press [MENU/SET].

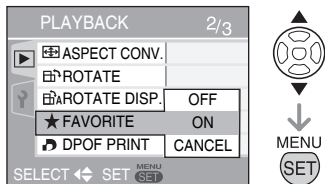

- You cannot set pictures as favorites if [FAVORITE] is set to [OFF]. Also the favorites icon [★] will not appear when [FAVORITE] is set to [OFF] even if it was previously set to [ON].

2 Press [MENU/SET] to close the menu.

3 Press ◀▶ to select the picture then press ▼.



- Repeat the above procedure.
- If ▼ is pressed while the [★] favorites icon (A) is displayed, [★] is cleared, and the favorites setting is canceled.
- You can place up to 999 pictures in your favorites list.

■ Canceling all favorites

- 1 Select [CANCEL] on the screen shown in step 1 and then press [MENU/SET].
 - 2 Press ▲ to select [YES] and then press [MENU/SET].
 - 3 Press [MENU/SET] to close the menu.
- You cannot select [CANCEL] if none of the pictures have [★] displayed.



- When printing pictures at a photo printing store, [ALL DELETE EXCEPT ★] (P35) is useful so only the pictures you want to be printed remain on the card.
- Use [PHOTOfunSTUDIO-viewer-] (on the included CD-ROM) to change settings, check, or erase your pictures in your favorites list. For details, refer to the operating instructions (PDF file) of the software.
- You may not be able to set pictures shot on other equipment as favorites.

Press [] to display the [PLAYBACK] mode menu and select the item to set. (P74)

[DPOF PRINT]



Setting the picture to be printed and the number of prints

DPOF (Digital Print Order Format) is a system that allows the user to select which pictures to print, how many copies of each picture to print and whether or not to print the recording date on the pictures when using a DPOF compatible photo printer or photo printing store. For details, ask at your photo printing store.

When you want to use a photo printing store to print pictures recorded on the built-in memory, copy them to a card (P86) and then set the DPOF setting.

For more information please visit:

http://panasonic.jp/dc/dpof_110/white_e.htm

Select [ DPOF PRINT] from playback menu (P74).

Common operation

Press $\blacktriangle/\blacktriangledown$ to select [SINGLE], [MULTI] or [CANCEL] and then press [MENU/SET].

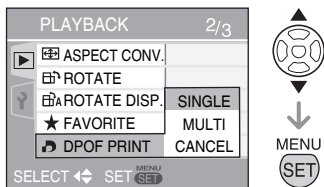

- You cannot select [CANCEL] if there are no prints that have been set in the DPOF print settings.

Single setting

After the common operation.

- Press $\blacktriangle/\blacktriangledown$ to select the picture to print and then press $\blacktriangle/\blacktriangledown$ to set the number of prints.



- The number of prints icon [] 1 appears.
- The number of prints can be set from 0 to 999. When the number of prints is set to "0", DPOF print setting is canceled.

- Press [MENU/SET] twice to close the menu.

Multi setting

After the common operation.

- Press $\blacktriangle/\blacktriangledown$ to select the picture to print and then press $\blacktriangle/\blacktriangledown$ to set the number of prints.

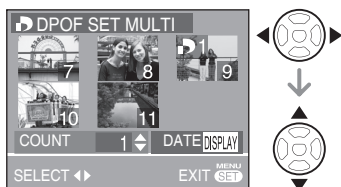

- Repeat the above procedure. (You cannot set all the pictures at one time.)
- The number of prints icon [] 1 appears.
- The number of prints can be set from 0 to 999. When the number of prints is set to "0", DPOF print setting is canceled.

- Press [MENU/SET] twice to close the menu.

■ To cancel all settings

After the common operation.

1 Press **▲** to select [YES] and then press [MENU/SET].

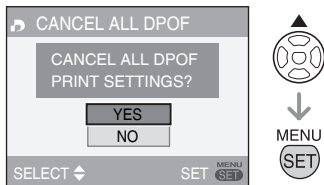

2 Press [MENU/SET] to close the menu.

- DPOF print settings on the built-in memory are canceled when a card is not inserted. DPOF print settings on the card are canceled when a card is inserted.

■ To print the date

You can set/cancel the printing with the recorded date with each press of the [DISPLAY] button when setting the number of prints.



- The date print icon [**DATE**] appears.
- When you go to a photo studio for digital printing, be sure to order the printing of the date if required.
- The date may not be printed depending on photo studios or printers even if you set the date print. For further information, ask the photo studio for details or refer to the operating instructions of the printer.
- This function is not available for images imprinted with the text stamp.
- This function is canceled if you imprint the text stamp on the picture.



- DPOF is an abbreviation of [Digital Print Order Format]. This feature allows you to write print information to media and then use the information on a DPOF-compliant system.
- DPOF print setting is a convenient function when you print pictures with printers supporting PictBridge. The date printing setting on the printer may take priority over the date printing setting on the camera. Check the date printing setting on the printer also.
- Some DPOF information set by other equipment may not be effective. In such cases, delete all of the DPOF information and then set it again with this camera.
- If the file is not based on the DCF standard, the DPOF print setting cannot be set.

Press [MENU/SET] to display the [PLAYBACK] mode menu and select the item to set. (P74)



You can set protection for the pictures you do not want to delete to prevent them from accidental erasure.

Select [PROTECT] from playback menu (P74).

Common operation

Press ▲/▼ to select [SINGLE], [MULTI] or [CANCEL] and then press [MENU/SET].

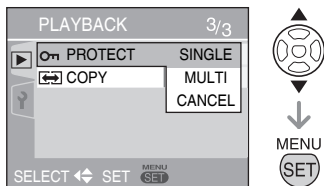

Single setting

After the common operation.

1 Press ◀▶ to select the picture and then press ▼ to set/cancel.



SET	The protect icon [On] appears.
CANCEL	The protect icon [On] disappears.

2 Press [MENU/SET] twice to close the menu.

Multi setting/To cancel all settings

After the common operation.

Perform the same operation as in [DPOF PRINT] (P83 to 84).



- The protect setting may not be effective in other equipment.
- If you want to delete protected pictures, cancel the protect setting first.
- While this feature protects the pictures from accidental erasure, formatting the card will permanently delete all data.
- Sliding the Write-Protect switch (A) of the SD Memory Card or the SDHC Memory Card to [LOCK] prevents pictures from deletion even if protection is not set.

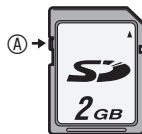

- The following functions cannot be used with protected pictures.
 - [TITLE EDIT]
 - [ROTATE]

Press [MENU/SET] to display the [PLAYBACK] mode menu and select the item to set. (P74)

[COPY] Copying the picture data

You can copy recorded picture data from the built-in memory to a card or vice versa.

Select [ COPY] from playback menu (P74).

1 Press ▲/▼ to select the copy destination and then press [MENU/SET].

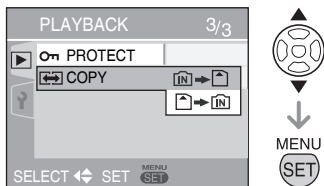

• :

All the picture data in the built-in memory are copied onto the card at one time. (Perform step 3)

• :

One picture at a time is copied from the card to the built-in memory. (Perform step 2)

(Only when  is selected)

2 Press ◀▶ to select the picture and then press ▼.

3 Press ▲ to select [YES] and then press [MENU/SET].

(The illustration shows the screen when pictures are copied from the built-in memory to a card.)

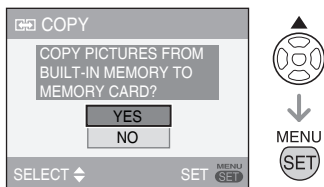



- The message [COPY THIS PICTURE TO BUILT-IN MEMORY?] appears when you copy picture from the card to the built-in memory.
- If you press [MENU/SET] while copying pictures from the built-in memory to the card, the copying will stop halfway.
- Do not turn the camera off or do any other operations before copying is finished. The data on the built-in memory or the card may be damaged or lost.

4 Press [MENU/SET] several times to close the menu.

- If you copy picture data from the built-in memory to a card, the screen automatically returns to the playback screen when all the pictures are copied.



- If you copy picture data from the built-in memory to a card which does not have sufficient free space, the picture data will only be copied halfway. We recommend using a card which has more free space than the built-in memory.
- In case of "", you can copy an image file even if there is already a file in the destination that has the same name (same file and folder numbers) by making new folder. In case of "", if a picture exists with the same name as the picture to be copied in the built-in memory, it is not copied.
- It may take time to copy the picture data.
- Only pictures recorded with a Panasonic digital camera (LUMIX) will be copied. (Even if the pictures were recorded with a Panasonic digital camera, you may not be able to copy them if they were edited with a PC.)
- DPOF settings on the original picture data will not be copied. Set the DPOF settings again after copying is finished.

Connecting to a PC

- By connecting the camera to a computer, you can upload your pictures, then use the software on the included CD-ROM ([PHOTOfunSTUDIO-viewer-] for Windows®) to print or send your images by e-mail.
- **If you use Windows 98/98SE, install the USB driver and then connect the camera to the computer.**
- For details, refer to the operating instructions (PDF file) of the software.

1 Turn on the camera and the PC.

2 Connect the camera to a PC via the USB connection cable ㉓ (supplied).

- The screen to select [PictBridge (PTP)] or [PC] is displayed.
- If [USB MODE] in setup menu is set to other than [SELECT ON CONNECTION], the screen is not displayed (P23).

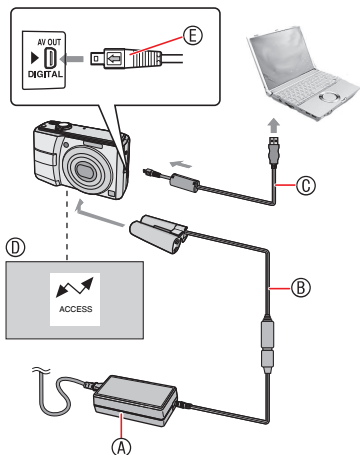

- ㉓ AC adaptor (DMW-AC6PP: optional)
- ㉔ DC coupler (DMW-DCC2: optional)
 - Use batteries with sufficient battery power or the AC adaptor ㉓ and the DC coupler ㉔.

- Always use a genuine Panasonic AC adaptor (DMW-AC6PP: optional) and DC coupler (DMW-DCC2: optional).
- Make sure this unit is off before connecting or disconnecting the AC adaptor.
- ㉕ USB connection cable (supplied)
 - Connect the USB connection cable with the [←] mark facing the [→] mark on the [DIGITAL] socket.
- ㉖ This message appears during data transfer.
- ㉗ Check the facing of the connector and push straight in.
 - Hold ㉗ and then insert or pull the USB connection cable straight. Do not try to force the connector in backwards or sideways. This can damage this unit and the equipment you are connecting.

3 Select [PC] using ▼ and press [MENU/SET].

[Windows]

The drive appears on the [My Computer] folder.

- If it is the first time you are connecting the camera to a PC, the required driver is installed automatically so that the camera can be recognized by the Windows Plug and Play, then it appears on the [My Computer] folder.

[Macintosh]

The drive is displayed on the screen.

- The drive is displayed as [LUMIX] when you connect the camera with no card inserted.
- The drive is displayed as [NO_NAME] or [Untitled] when you connect the camera with a card inserted.

■ Motion picture playback on a PC

Use "QuickTime" (for Windows 2000/XP/Vista) in the supplied CD-ROM when you play back motion pictures recorded on this camera on your PC.

- Download [QuickTime6.5.2 for Windows] from the following website and install it on your PC when you use Windows98/98SE/Me.

<http://www.apple.com/support/downloads/quicktime652forwindows.html>

- The software is a standard Macintosh feature.

■ Folder composition

Folders appear as follows.

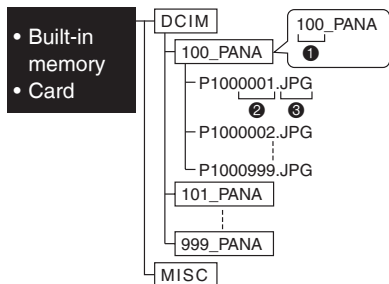

① Folder number

② File number

③ JPG : Pictures

MOV : Motion pictures

MISC: Folder containing files with following settings

DPOF print

Favorite

Category slide show

- This unit stores up to 999 picture files in each folder. A new folder is created after this maximum is reached.
- To reset file and folder numbers, use [NO.RESET] in the setup menu. (P22)

■ Conditions under which a different folder number is used

In the following cases, the picture is not recorded in the same folder as the previously recorded picture. It is recorded in a folder with a new number.

- The folder containing the picture you just shot had a file numbered 999 in it (example: P1000999.JPG).
- When the card just recorded to contains, for example, a folder with the number 100 (100_PANA) in it and that card is removed and replaced with a card that has a folder with the number 100 in it recorded by a camera from a different maker (100XXXXX, with XXXXX being the name of the maker) and then a picture is recorded.
- You start shooting again after using [NO.RESET] in the setup menu. (It is recorded to a new folder that has a number following on from the one previous. You can also reset the folder number to 100 by using [NO.RESET] immediately after formatting the card when there are no folders or pictures on the card.)

■ Connection in the PTP mode

If the OS is "Windows XP", "Windows Vista" or "Mac OS X", you can connect in PTP mode if you set the camera to [PictBridge (PTP)] and press [MENU/SET] after connecting the USB cable.

- You can only load pictures from the camera and cannot write them on the card or delete them.
However, you can connect in MTP mode on Windows Vista, instead of PTP. Then, you can format or delete the data on the card.
- When there are 1000 or more pictures on a card, the pictures may not be imported.



- Do not use any other USB connection cables except the supplied one.
- While [ACCESS] is being displayed, do not disconnect the USB connection cable.
- When using Windows PC, click Safety Remove Hardware icon on the task tray first to remove USB cable. When the icon is not displayed, make sure the connection screen is not displayed, and turn the camera [OFF] to remove.
- **When connecting the camera to a Windows 2000 OS PC with the USB connection cable, do not replace the card while the camera and the PC are connected. The information on the card may be damaged. Before changing cards, make sure you perform the necessary steps to safely remove hardware (double-click the icon in the task bar in Windows).**
- When there are many pictures on the built-in memory or the card, it may take some time to transfer them.
- Motion image files in the built-in memory or on a card in this unit may not play properly on a computer, so upload them to your computer for playback.
- If the remaining battery power becomes low while the camera and the PC are communicating, the status indicator blinks and the alarm beeps. In this case, stop the communication at once on the PC.
- Pictures edited or rotated with a PC may be displayed in black in playback mode, multi playback and calendar.
- If a card is not inserted when the camera is connected to the PC, you can edit or access the picture data on the built-in memory. If a card is inserted, you can edit or access the picture data on it.
- You cannot switch between the built-in memory and the card while the camera is connected to the PC. When you want to switch between the built-in memory and the card, disconnect the USB connection cable, insert (or remove) the card and then connect the USB connection cable to the PC again.
- When connecting the camera to a Mac OS v10.2 or lower and using SDHC Memory card to import the picture data, set the Write-Protect switch on the SDHC Memory Card to [LOCK].
- Refer to the operating instructions of the PC, too.

Connecting to a PictBridge-compliant Printer

By connecting the camera directly to a printer supporting PictBridge via the USB connection cable (supplied), you can select the pictures to be printed or start printing on the LCD monitor. Make the necessary settings on your printer beforehand. (Read your printer's operating instructions.)

1 Turn on the camera and the printer.

2 Connect the camera to a printer via the USB connection cable ① (supplied).

- The screen to select [PictBridge (PTP)] or [PC] is displayed.
- If [USB MODE] in setup menu is set to other than [SELECT ON CONNECTION], the screen is not displayed (P23).

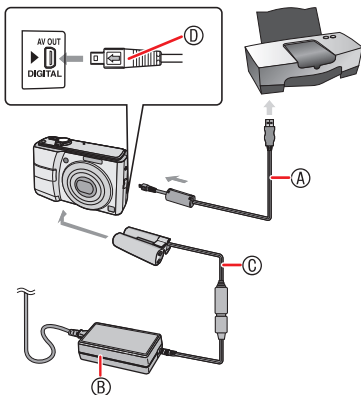

- ① USB connection cable (supplied)
- Connect the USB connection cable with the [◀] mark facing the [▶] mark on the [DIGITAL] socket.
- ② AC adaptor (DMW-AC6PP: optional)
- ③ DC coupler (DMW-DCC2: optional)
- Use batteries with sufficient battery power or the AC adaptor ② and the DC coupler ③.
 - Always use a genuine Panasonic AC adaptor (DMW-AC6PP: optional) and DC coupler (DMW-DCC2: optional).

- Make sure this unit is off before connecting or disconnecting the AC adaptor.

- ④ Check the facing of the connector and push straight in.
- Hold ④ and then insert or pull the USB connection cable straight. Do not try to force the connector in backwards or sideways. This can damage this unit and the equipment you are connecting.

3 Select [PictBridge] using ▲ and press [MENU/SET].



- Do not use any other USB connection cables except the supplied one.
- If a card is not inserted when the camera is connected to the printer, you can print the picture data on the built-in memory. If a card is inserted, you can print the picture data on it.
- You cannot switch between the built-in memory and the card while the camera is connected to the printer. When you want to switch between the built-in memory and the card, disconnect the USB connection cable, insert (or remove) the card and then connect the USB connection cable to the printer again.
- To print the name of the age in [BABY] and [PET], the departure date for [TRAVEL DATE] or the text input in [TITLE EDIT], use the [PHOTOfunSTUDIO-viewer-] software in the CD-ROM (supplied) and print from the PC. For information about this, refer to the separate operating instructions (PDF file) of the software.
- To find out more about PictBridge compliant printers, contact your local dealer.

■ Printing the selected picture (making a single print)

1 Press to select the picture and then press [MENU/SET].

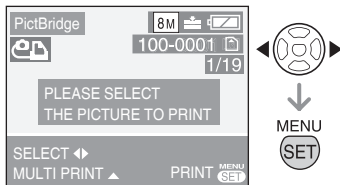

- A message displays for about 2 seconds.

2 Press to select [PRINT START] and then press [MENU/SET].

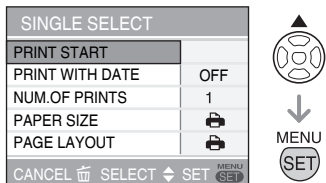

- Press [MENU/SET] to cancel printing.





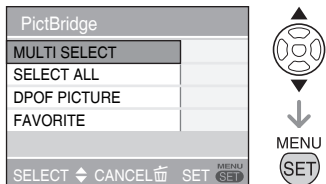

3 Disconnect the USB connection cable after printing.

■ Selecting multiple pictures for printing

1 Press .

2 Press / to select an item and then press [MENU/SET].



Item	Setting contents
MULTI SELECT	Multiple pictures are selected at once for printing. [Operation] On the plural pictures screen, press   to select pictures. When you press  ,  is displayed with the picture you selected for printing. (When you press  once more, the print setting is canceled.) Press [MENU/SET] when you finish selection.
SELECT ALL	All pictures in the built-in memory or the card are printed.
DPOF PICTURE	Pictures in the [DPOF PRINT] setting are printed.
FAVORITE	Pictures set as favorites are printed. <ul style="list-style-type: none"> • This item appears only when favorite setting is [ON]. • You cannot select any picture when [FAVORITE] is set to [ON], but no picture is marked with .

3 Press to select [PRINT START] and then press [MENU/SET].

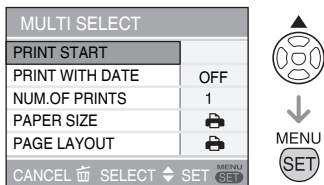

- In DPOF setting, [PRINT WITH DATE] and [NUM. OF PRINTS] are not displayed.

- When you select [DPOF PICTURE], [DPOF SET] is selectable. When you select [DPOF SET], refer to P83.
- Press [MENU/SET] when you wish to cancel printing halfway.
- When you select [MULTI SELECT], [SELECT ALL] or [FAVORITE], the print confirmation screen appears. Select [YES] and perform printing.
- When the number of prints exceeds 1,000, [PRINTING --- PICTURES DO YOU WANT TO PROCEED?] appears on the print confirmation screen.

4 Disconnect the USB connection cable after printing.

■ Setting date printing, the number of prints, the paper size and the page layout

Select an item to set on the screen for step 2 in “Printing the selected picture (making a single print)” or on the screen for step 3 in “Selecting multiple pictures for printing”.

- When you want to print pictures in a paper size or a layout which is not supported by the camera, set [PAPER SIZE] and [PAGE LAYOUT] to  and then set the paper size or the layout on the printer. (For details, refer to the operating instructions of the printer.)

• [PRINT WITH DATE]

OFF	Date is not printed.
ON	Date is printed.

- If the printer does not support date printing, the date cannot be printed on the picture.
- ##### • [NUM. OF PRINTS]
- Set the number of prints.
- You can set up to 999 prints.

• [PAPER SIZE]





(Possible paper sizes on the camera)

	Settings on the printer are prioritized.
L/3.5" × 5"	89 mm × 127 mm
2L/5" × 7"	127 mm × 178 mm
POSTCARD	100 mm × 148 mm
16:9	101.6 mm × 180.6 mm
A4	210 mm × 297 mm
A3	297 mm × 420 mm
10 × 15cm	100 mm × 150 mm
4" × 6"	101.6 mm × 152.4 mm
8" × 10"	203.2 mm × 254 mm
LETTER	216 mm × 279.4 mm
CARD SIZE	54 mm × 85.6 mm

- These items cannot be displayed when the printer does not support the paper sizes.

• [PAGE LAYOUT]

(Possible layouts on the camera)

	Settings on the printer are prioritized.
	1 page with no frame print
	1 page with frame print
	2 pages print
	4 pages print

- An item cannot be selected if the printer does not support the page layout.

■ Layout printing

• When printing a picture several times on 1 sheet of paper

For example, if you want to print a picture 4 times on 1 sheet of paper, set [PAGE LAYOUT] to  and then set the number of prints to 4 for the picture on [NUM. OF PRINTS].

• When printing different pictures on 1 sheet of paper

For example, if you want to print 4 different pictures on 1 sheet of paper, set [PAGE LAYOUT] to 4-picture printing  and then set [NUM. OF PRINTS] for the pictures to 1.



- Do not disconnect the USB connection cable when the cable disconnection warning icon [🚫] is indicated. (Depending on the printer, the icon may not be displayed.)
- If the remaining battery power becomes low while the camera and the printer are connected, the status indicator blinks and the alarm beeps. If this happens during printing, press [MENU/SET] and stop printing at once. If not printing, disconnect the USB connection cable.
- The camera is receiving an error message from the printer when the [●] indication lights orange during printing. After finishing printing, make sure there are no problems with the printer.
- If the total number of ordered prints or the number of pictures set for print is large, printing is performed at intervals. In such cases, the number of remaining prints shown on the display will differ from the number of prints you set. The discrepancy, however, does not indicate an error.
- Date print function on the printer may have priority over the same settings on the camera. Check the setting on the printer as well.

Playing Back Pictures with a TV Screen

■ Playing back pictures using the AV cable (supplied)

- Set the [TV ASPECT]. (P23)
- Turn the camera and the TV off.

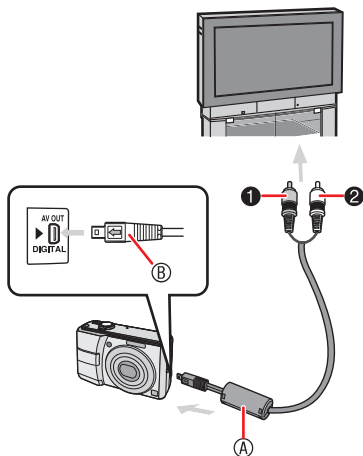

1 Connect the AV cable (A) (supplied) to the [AV OUT] socket of the camera.

- Connect the AV cable with the [←] mark facing the [▶] mark on the [AV OUT] socket.
- Hold (B) and then insert or pull the AV cable straight.

2 Connect the AV cable to the video input and the audio input sockets of the TV.

- ① Yellow: to the video input socket
- ② White: to the audio input socket

3 Turn the TV on and select external input.

4 Turn the camera on and playback the picture.



- Do not use any other AV cables except the supplied one.
- The top and bottom or left and right of the picture may be cut off slightly when it is displayed due to the characteristics of the TV.
- Read the TV operating instructions too.
- Pictures might be slightly blurred if you show them vertically on a television.
- You can view pictures on TVs in other countries (regions) which use the NTSC or PAL system when you set [VIDEO OUT] in the [SETUP] menu. Even if you set [VIDEO OUT] to [PAL], the output signal will still be NTSC in the recording mode.

■ Playback pictures on TV with SD Memory Card slot

You can put your SD Memory Card in a television with an SD Memory Card slot to show still images.



- Depending on the television, some pictures may not take up the whole screen.
- You cannot play motion pictures. To play back motion pictures, connect the camera to the TV with the AV cable (supplied).
- You can use SDHC Memory Card on SDHC Memory Card compatible TV only.
- You may be unable to play MultiMedia Cards.

Screen Display

The LCD monitor shows the status of the camera.

In normal picture mode [] (Initial setting)

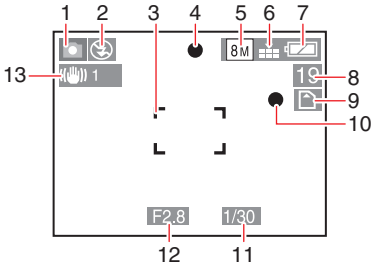

■ In recording

- 1 Recording mode
- 2 Flash mode (P39)
- 3 AF area (P26)
- 4 Focus indication (P26)
- 5 Picture size (P60)
- 6 Quality (P60)
- Jitter alert indication (P30) : []
- 7 Battery indication (P25)
- 8 Remaining number of recordable pictures (P107)
- 9 [IN]: Built-in memory (P16)
[]: Card (P16)
- 10 Recording indication
- 11 Shutter speed indication (P28)
Intelligent ISO (P61) : [ISO]
- 12 Aperture value indication (P28)
- 13 Optical image stabilizer (P66)
- 14 Burst (P65)
[]: Audio recording (P53)
- 15 White balance (P62)
- 16 Sensitivity (P62)
ISO limit (P61) : [ISO MAX 400] / [ISO MAX 800] / [ISO MAX 1250]
- 17 Color mode (P65)
- 18 Picture mode (P53) :
[30fps_VGA] / [10fps_VGA] / [30fps_QVGA] /
[10fps_QVGA] (4:3)
[30fps_16:9] / [10fps_16:9] (16:9)
- 19 Available recording time in motion picture mode
e.g. : [R 8m 30s]

In recording (After settings)

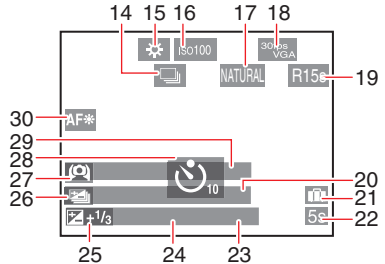

- 20 Age (P49, 50)
 - It is displayed about 5 seconds when switching to [BABY] or [PET] in scene mode.
- Number of days that have passed since the departure date (P55)
- 21 Travel date (P55)
- 22 Elapsed recording time (P53)
- 23 Backlight compensation operation (Intelligent mode only) (P27)
- 24 Current date and time/Destination settings : [] (P57)
 - It is displayed for about 5 seconds when turning the camera on, setting the clock and after switching from the playback mode to the recording mode.
- Zoom (P31)/Extended optical zoom (P31)/Easy zoom (P32)/Digital zoom (P33) : [EZ W] [] [T] [1X]
- 25 Exposure compensation (P44)
Backlight compensation (Intelligent mode only) (P27) : []
- 26 Auto bracket (P45)
- 27 LCD mode (P38)
- 28 Self-timer (P43)
- 29 Name (P49, 50)
This is displayed for about 5 seconds when this unit is turned on in [BABY] or [PET] in scene mode.
- 30 AF assist lamp (P66) : [AF#]

In playback

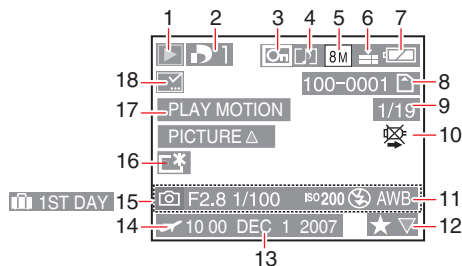

■ In Playback

- 1 Playback mode (P18)
- 2 Number of DPOF prints (P83)
- 3 Protected picture (P85)
- 4 Motion pictures with audio (P53)
- 5 Picture size (P60)
- 6 Quality (P60)
- In Motion picture mode (P53) :
 [30fps VGA] / [10fps VGA] / [30fps QVGA] /
 [10fps QVGA] (4:3)
 [30fps 16:9] / [10fps 16:9] (16:9)
- 7 Battery indication (P25)
- 8 Folder/File number (P88)
 [IN] : Built-in memory (P16)
 [] : Card (P16)
- 9 Picture number/Total pictures
- 10 Cable disconnection warning icon (P93)
 Motion picture recording time (P73) :
 [8m 30s]
- 11 Recording information
- 12 Favorites setting (P82)/
 Elapsed playback time (P73) : [8m 30s]
- 13 Recorded date and time
- 14 Destination settings (P57)
 Name (P49)
 Title (P74)
- 15 Number of days that have passed since
 the departure date (P55)
 Age display (P49, 50)
- 16 Power LCD mode (P38)
- 17 Motion picture playback (P73)
- 18 Text stamp complete indicator (P76)
 Favorites indicator (P82) : [★]

Cautions for Use

■ Optimal Use of the Camera

Take care not to drop or knock the unit or put a lot of pressure on it.

- Do not leave the unit in your pants pocket when you sit down or forcefully insert it into a full bag etc.
- Take care not to drop or knock the bag that you inserted the unit in as it may strongly shock the unit.
- A strong shock may break the lens, screen or outer case and cause the camera to malfunction.



Keep the camera as far away as possible from electromagnetic equipment (such as microwave ovens, TVs, video games etc.).

- If you use the camera on top of or near a TV, the pictures and sound on the camera may be disrupted by electromagnetic wave radiation.
- Do not use the camera near cell phones because doing so may result in noise adversely affecting the pictures and sound.
- Recorded data may be damaged, or pictures may be distorted, by strong magnetic fields created by speakers or large motors.
- Electromagnetic wave radiation generated by microprocessors may adversely affect the camera, disturbing the pictures and sound.
- If the camera is adversely affected by electromagnetic equipment and stops functioning properly, turn the camera off and remove the battery or disconnect AC adaptor (DMW-AC6PP: optional). Then reinsert the battery or reconnect AC adaptor and turn the camera on.

Do not use the camera near radio transmitters or high-voltage lines.

- If you record near radio transmitters or high-voltage lines, the recorded pictures and sound may be adversely affected.

Make sure to use the supplied cords and cables. If you use optional accessories, use the cords and the cables supplied with them. Do not extend the cords and the cables.

Do not spray insecticides or volatile chemicals onto the camera.

- If the camera is sprayed with such chemicals, the camera body may be damaged and the surface finish may peel off.
- Do not keep rubber or plastic products in contact with the camera for a long period of time.

Maintenance

Uninstall the battery or DC coupler and wipe them with a soft, dry cloth when maintenance.

- When the camera becomes dirty, clean it with a soft, slightly damp cloth. Then wipe the camera with dry cloth.
- Do not use solvents such as benzine, thinner, alcohol or kitchen detergent. This can cause damage to the body of the camera and the surface may peel off.
- When using chemically treated cloth, read the instruction before hands.

■ Batteries

Be sure to remove the batteries when you will not be using the camera for a long period of time.

- If the temperature is too high or low, the terminals may rust causing a malfunction.

If you drop the batteries accidentally, check to see if the body of the batteries and the terminals are damaged.

- Inserting a damaged battery in the camera will damage the camera.

Bring charged spare batteries when going out.

- Be aware that the operating time of the batteries becomes shorter in low temperature conditions such as at a ski resort.

Dispose of unusable batteries.

- Batteries have a limited life.
- Do not throw batteries into fire because they may cause an explosion.
- Unusable batteries should be discarded in accordance with battery recycling laws. Call the RBRC hotline on 1-800-822-8837 for information.

Do not allow battery terminals to come into contact with metal objects (such as necklaces, hairpins, etc.).

- This can cause short circuiting or heat generation and you may be badly burned if you touch the batteries.

■ Card

Do not leave the card in places where there is high temperature or direct sunlight, or where electromagnetic waves or static electricity are easily generated.

Do not bend or drop the card.

- The card may be damaged or the recorded content may be damaged or erased.
- Store the card in the card case or the storage bag after use and when you store or carry the card.

- Do not allow dirt, dust or water to enter the terminals on the back of the card and do not touch the terminals with your fingers.

■ About the picture data

- Recorded data may be damaged or lost if the camera breaks down due to inappropriate handling. Panasonic will not be liable for any damage suffered due to loss of recorded data.

■ About tripods

- When you use a tripod, make sure the tripod is stable when this unit is attached to it.
- You may not be able to remove the card or the battery when using a tripod.
- Make sure that the screw on the tripod is not at an angle when attaching or detaching the camera. You may damage the screw on the camera if you use excessive force when turning it. Also, the camera body and the rating label may be damaged or scratched if the camera is attached too tightly to the tripod.
- Read the operating instructions for the tripod carefully.

Message Display

Confirmation messages or error messages will be displayed on the screen in some cases. The major messages are described below as examples.

[CURRENT BATTERY TYPE SETTING: ALKALINE/Ni-MH]/[CURRENT BATTERY TYPE SETTING: OXYRIDE]

This message is displayed the first time you insert batteries and when the batteries are exhausted and you replace them. If the battery type being used is different from the one indicated in the message, change the battery type in [BATTERY TYPE] in the [SETUP] menu (P21).

[THIS MEMORY CARD IS LOCKED]

- Cancel the card lock. (P16)

[NO VALID PICTURE TO PLAY]

Play back after recording or after inserting a card with a recorded picture.

[THIS PICTURE IS PROTECTED]

After canceling the protect setting (P85), you can delete the picture.

[THIS PICTURE CANNOT BE DELETED]/[SOME PICTURES CANNOT BE DELETED]

The pictures not based on the DCF standard cannot be deleted.

To delete this kind of picture, first save your data to your computer, then use this unit to reformat the card. (P23)

[NO ADDITIONAL DELETE SELECTIONS CAN BE MADE]

You have selected more than the allowed number of items in multi delete or the MULTI setting in [TITLE EDIT]/[TEXT STAMP]. Repeat the procedure as necessary.

You have placed more than 999 pictures in your favorites list.

[CANNOT BE SET ON THIS PICTURE]/[CANNOT BE SET ON SOME PICTURES] [DPOF PRINT], [TITLE EDIT], and [TEXT STAMP] cannot be set for pictures not based on the DCF standard.

[NOT ENOUGH SPACE ON BUILT-IN MEMORY]/[NOT ENOUGH MEMORY ON THE CARD]

There is no space left on the built-in memory or the card.

- When you copy pictures from the built-in memory to the card (batch copy), the pictures are copied until the capacity of the card becomes full.

[SOME PICTURES CANNOT BE COPIED]/[COPY COULD NOT BE COMPLETED]

The following pictures cannot be copied.

- When a picture with the same name as the picture to be copied exists in the copy destination. (When copying pictures from the card to the built-in memory)
 - Files not based on the DCF standard.
- Moreover, pictures recorded or edited by other equipment may not be copied.

[BUILT-IN MEMORY ERROR FORMAT BUILT-IN MEMORY?]

This message will be displayed when you format the built-in memory on the PC or remove the battery without turning the camera off. Format the built-in memory of the camera again. (P23) The data on the built-in memory will be deleted.

[MEMORY CARD ERROR FORMAT THIS CARD?]

The format of the card cannot be recognized by this camera. Format the card again with this camera. Save your data to your computer, then use this unit to reformat the card. (P23)

[PLEASE TURN CAMERA OFF AND THEN ON AGAIN]

This message appears when the camera is not operating properly. Turn the camera off and on. If the message persists, contact the dealer or your nearest Service Center.

[MEMORY CARD ERROR MEMORY CARD PARAMETER ERROR]

Use a card compatible with this camera. (P5, 16)

You can only use 4 GB cards if they are SDHC Memory Cards.

[MEMORY CARD ERROR PLEASE CHECK THE CARD]

- Failed access to the card. Insert the card again.

[READ ERROR PLEASE CHECK THE CARD]

Data reading error.

Insert the card again. Make sure the card is inserted properly and then play back again.

[WRITE ERROR PLEASE CHECK THE CARD]

Data writing error.

Turn the camera off and remove the card. Then insert the card and turn the camera on again. This error may also indicate that the card is damaged.

[MOTION RECORDING WAS CANCELLED DUE TO THE LIMITATION OF THE WRITING SPEED OF THE CARD]

- When you set the [PICTURE MODE] to [30fpsVGA] or [30fps16:9], we recommend using cards that offer 10 MB/second or higher speeds (shown on their packages and elsewhere) for best results.
- Depending on the type of Card, recording may stop in the middle.

[A FOLDER CANNOT BE CREATED]

A folder cannot be created because there are no remaining folder numbers that can be used.

Save your data to your computer, then use this unit to reformat the card. (P23)

If you execute [NO.RESET] in the [SETUP] menu after formatting, the folder number is reset to 100. (P22)

[PICTURE IS DISPLAYED FOR 4:3 TV/ PICTURE IS DISPLAYED FOR 16:9 TV]

- The AV cable is connected to the camera. Press [MENU/SET] if you want to delete this message at once.
- Select [TV ASPECT] in the [SETUP] menu to change the TV aspect. (P23)
- This message also appears when the USB connection cable is connected to the camera only. In this case, connect the other end of the USB connection cable to a PC or a printer.

[PRINTER BUSY]/[PLEASE CHECK THE PRINTER]

The printer cannot print. Check the printer.

Troubleshooting

If you put the menu back to the settings at the time of purchase, the conditions may be improved. Carry out the [RESET] in the setup menu while the camera is in the recording mode. (P23)

■ Batteries and power supply

Conditions	Causes
The camera turns off immediately even when battery power is full.	The remaining battery power may not be displayed accurately, and the camera may suddenly stop working, when the type of battery and the settings on [BATTERY TYPE] are not identical. However this is not a malfunction. Depending on the battery brand and the operating temperature, or if exhausted batteries are used, the remaining battery power may not be displayed accurately. Please check [BATTERY TYPE] (P21) in the [SETUP] menu.
The remaining battery power is low even if new batteries are inserted.	
The camera will not turn on.	Are the batteries inserted correctly?
	Use sufficiently charged batteries when using Ni-MH batteries.
The picture is not displayed on the LCD monitor.	Is the economy mode (P22) activated? Press the shutter button halfway to deactivate these modes.
	Are the batteries exhausted? Replace them with batteries which have sufficient capacity. (When you use Ni-MH batteries, charge them.)
The camera turns off soon after turning it on.	<ul style="list-style-type: none"> • Are the batteries exhausted? Replace them with batteries which have sufficient capacity. (When you use Ni-MH batteries, charge them.) • If you leave the camera on, the battery will be exhausted. Turn the camera off frequently by using economy mode (P22) etc.

■ Shooting



Conditions	Causes
The picture cannot be recorded.	Is the mode correctly set?
	Is there any memory capacity left on the built-in memory or the card?
	Before recording, delete some pictures. (P35)
The recorded pictures are pale.	The picture can become whitish if there is dirt e.g. fingerprints on the lens. If the lens is dirty, turn on the camera, eject the lens barrel and gently wipe the lens surface with a soft dry cloth.
The recorded picture is too bright or dark.	Check that the exposure is correctly compensated. (P44)
2 or 3 pictures are taken at one time.	Is AUTO BRACKET (P45), HI-SPEED BURST (P50) or BURST (P65) mode set?

Conditions	Causes
The subject is not focused properly.	<p>The focus range varies depending on the recording mode. Set the proper recording mode for the distance to the subject.</p> <p>Is the subject out of the focus range? (P28, 42)</p> <p>Have you taken a picture with jitter?</p> <p>The subject is not focused until the shutter button is pressed halfway.</p>
The recorded picture is blurred. The optical image stabilizer is not effective.	<p>When taking a picture in shaded areas or indoors, the shutter speed becomes slow and the Optical Image Stabilizer function may not work properly. In this case, we recommend holding the camera with both hands firmly to take pictures.</p>
Images are grainy or noisy.	<p>Is the ISO sensitivity high or the shutter speed slow? (When set to [AUTO], ISO sensitivity increases for indoor and other shooting occasions.)</p> <ul style="list-style-type: none"> • Reduce ISO sensitivity. (P62) • Set [COLOR MODE] to [NATURAL]. (P65) • Improve the ambient light. <p>In [HIGH SENS.] and [HI-SPEED BURST] mode, the resolution of the recorded picture decreases slightly because of high sensitivity processing. This is not a malfunction.</p>
The brightness or color of the picture differs from the actual scene.	<p>Brightness and colors may change when using a fast shutter speed under fluorescent lights, but this is a characteristic of such lighting and is not a malfunction.</p>
Shooting of motion pictures stops unexpectedly.	<p>This camera is not compatible with motion picture recording on MultiMediaCards.</p> <ul style="list-style-type: none"> • When you set the [PICTURE MODE] to [30fpsVGA] or [30fps16:9], we recommend using cards that offer 10 MB/second or higher speeds (shown on their packages and elsewhere) for best results. • Depending on the type of SD Memory Card or SDHC Memory Card, recording may stop in the middle.
Reddish vertical lines appear on the LCD monitor while shooting.	<ul style="list-style-type: none"> • This is a phenomenon called smear. It is a characteristic of CCD and appears when the subject has a bright part. Irregularities may also appear around the smear, but this is not a malfunction. (It is recorded in motion pictures but not on still pictures.) • We recommend not to let a strong source of light such as the sun light enter the screen when taking pictures. 

■ LCD

Conditions	Causes
The LCD monitor sometimes turns off although the camera is turned on.	The LCD turns off immediately after using the flash while it recharges.
	The LCD may turn off immediately after setting to recording mode while it recharges.
	Have you set [AUTO LCD OFF]? (P22)
The brightness of the LCD monitor becomes dark or bright for a moment.	This phenomenon appears when pressing the shutter button halfway to set the aperture value and does not affect the recorded pictures.
The LCD monitor flickers indoors.	The LCD monitor may flicker for a few seconds after turning the camera on indoors under fluorescent light. This is not a malfunction.
The LCD monitor is too bright or dark.	Adjust the brightness of the LCD monitor. (P21)
	Is the power LCD or the high angle mode activated? (P38)
Black, red, blue and green dots appear on the LCD monitor.	This is not a malfunction. These pixels do not affect the recorded pictures.
Noise appears on the LCD monitor.	In dark places, noise may appear to maintain the brightness of the LCD monitor. This does not affect the pictures you are recording.

■ Flash

Conditions	Causes
Flash is not activated.	Is the flash setting set to Forced OFF [ ? Change the flash setting. (P39)
	The flash is not activated when motion picture mode [], [SCENERY], [NIGHT SCENERY], [SUNSET], [HI-SPEED BURST], [STARRY SKY], [FIREWORKS] and [AERIAL PHOTO] mode, burst and auto bracket is selected.
The flash is activated 2 times.	When you select red-eye reduction (P39), the flash is activated once before the actual recording to reduce the red-eye phenomenon (eyes of the subject appearing red in the picture) and then activated again for the actual recording.

■ Playback

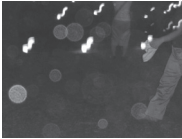
Conditions	Causes
<p>Pictures rotate unexpectedly.</p>	<p>One of the features of this unit can automatically detect when you have turned the camera sideways to take a picture, then rotate that picture for you when you play it back.</p> <p>In some cases, the unit may detect that you have turned the camera sideways, when in fact you are facing it up or down.</p> <ul style="list-style-type: none"> • Set [ROTATE DISP.] (P81) to [OFF] so that the camera does not rotate these kinds of pictures for you. • You can use [ROTATE] (P81) to rotate the pictures when necessary.
<p>The picture is not played back.</p>	<p>Is the recording/playback switch set to playback [▶]? Is there a picture on the built-in memory or the card?</p> <ul style="list-style-type: none"> • The pictures on the built-in memory appear when a card is not inserted. The picture data on the card appears when a card is inserted.
<p>Folder or file number appears as [-] and the display goes black.</p>	<p>The picture may have been changed on a computer or taken on a different camera.</p> <p>This problem can also occur if you remove the batteries immediately after taking a picture or if the batteries had very little charge left.</p> <ul style="list-style-type: none"> • You will need to reformat the card to delete this type of picture. (P23) (Remember that all data will be irretrievably erased when you format the card, so save your data and check the card before proceeding.)
<p>The picture is displayed with a date different from the actual recording date in calendar playback.</p>	<p>Was the picture edited with a PC or recorded with a digital camera from another manufacturer? This kind of picture may be displayed with a date different from the actual recording date in calendar playback.</p> <p>Is the clock in the camera set properly? (P17) For example, if the clock setting on the camera is different from the date and time set on the PC and you acquire pictures recorded with the camera to the PC and then write them back to the card, the pictures may be displayed with dates different from the actual recording dates in calendar etc.</p>
<p>White round spots like soap bubbles appear on the recorded picture.</p>	<p>If you take a picture with the flash in a dark place or indoors, white round spots may appear on the picture caused by the flash reflecting of particles of dust in the air. This is not a malfunction.</p> <p>A characteristic of this is that the number of round spots and their position differ in every picture.</p> 

■ Connecting to a TV, computer or printer

Conditions	Causes
The picture does not appear on the television. The TV screen is disturbed or displayed in monochrome.	Is the camera connected to the TV correctly? Set the TV to video input mode.
The display areas on the TV screen and the camera's LCD monitor are different.	Depending on the TV model, the area display may be smaller so the picture may be stretched horizontally or vertically and the top and bottom or left and right of the picture may be cut off when it is displayed. This is due to the TV specifications and is not a malfunction.
Cannot play motion pictures on a television.	You cannot play motion pictures if you have inserted the card into a card slot on a television. Connect the camera to the television with the included AV cable and play the pictures on this unit. (P94)
The picture size does not fit the TV screen.	Check the [TV ASPECT] setting on this unit. (P23)
Cannot upload pictures to your computer.	Check the connections. Check that the computer has correctly recognized the camera.
The computer does not recognize the card. (The built-in memory is recognized.)	Disconnect the USB connection cable, then insert the card and reconnect the cable.
The pictures cannot be printed with printers.	Does the printer support PictBridge? You cannot print pictures with printers which do not support PictBridge. (P90)
The sides of printed images are cut off.	<ul style="list-style-type: none"> • If your printer has trimming and border settings, change the settings so that there is no trimming and no border. (Read your printer's operating instructions.) • Some photography shops can handle pictures shot in the [16:9] aspect ratio. Enquire before sending them for printing.

■ Others







Conditions	Causes
Unreadable language was selected by mistake.	Press [MENU/SET], select the [SETUP] menu icon [Y] and then select the [Q] icon to set the desired language. (P24)
Cannot change the auto review setting.	Is auto bracket, [SELF PORTRAIT], [HI-SPEED BURST], burst mode or motion picture mode [H] activated? You cannot change the auto review setting when using these modes.





Conditions	Causes
When the shutter button is pressed halfway, a red lamp turns on sometimes.	In dark places, the AF assist lamp (P66) lights red to make it easier to focus on a subject.
The AF assist lamp does not turn on.	Is [AF ASSIST LAMP] on the [REC] mode menu set to [ON]? (P66)
	Are you taking pictures in dark places? The AF assist lamp does not turn on in bright places.
	The AF assist lamp does not turn on when [SELF PORTRAIT], [SCENERY], [NIGHT SCENERY], [SUNSET], [FIREWORKS] or [AERIAL PHOTO] mode is selected.
The camera gets hot.	The camera may get a little warm while you are using it, but this is normal.
The lens clicks.	When brightness has changed due to the zoom or the movement of the camera or other, the lens may click and the picture on the screen may be drastically changed, however, the pictures are not affected. The sound is caused by automatic adjustment of the aperture. It is not a malfunction.
The clock setting is reset.	If you do not use the camera for a long time, the clock setting may be reset. When the message [PLEASE SET THE CLOCK] appears, set the clock again. (P17)
	When you take a picture before setting the clock, [0:00 0. 0. 0] is recorded.
Images appear slightly distorted.	Images may be taken with some distortion depending on the zoom ratio. This distortion increases as you get nearer the subject, but it is not a malfunction.
Strange colors appear around the edge of the image.	Depending on the zoom magnification, the picture may have some colored fringes around the subject. This is called chromatic aberration and may be more visible when recording distant subjects. However this is not a malfunction.
File numbers are not created in order.	Certain operations cause pictures to be saved in folders with different numbers. (P88)
The file numbers are recorded in ascending order.	If the batteries are inserted or removed when the camera is not turned off, the recorded folder numbers are lost. However if you turn the camera on again and record pictures, the file numbers may be recorded in ascending order.
The picture is displayed black.	Pictures edited or rotated with a PC may be displayed in black in playback mode, multi playback and calendar.
The lens barrel is retracted.	The lens barrel retracts about 15 seconds after switching from [REC MODE] to [PLAYBACK MODE].







Number of Recordable Pictures and Available Recording Time







- The number of recordable pictures and the available recording time are an approximation. (These vary depending on the recording conditions and the type of card.)
- The number of recordable pictures and the available recording time vary depending on the subjects.

■ Number of recordable pictures

Aspect ratio		4:3					
Picture size		8M : 8M (3264 × 2448 pixels)		5M : 5M EZ (2560 × 1920 pixels)		3M : 3M EZ (2048 × 1536 pixels)	
Quality							
Built-in Memory (Approx. 24MB)		5	11	9	18	14	29
Card	16 MB	2	6	5	10	8	16
	32 MB	6	14	11	23	18	36
	64 MB	14	30	24	48	38	75
	128 MB	30	61	50	99	78	150
	256 MB	61	120	98	190	150	290
	512 MB	120	240	195	380	300	590
	1 GB	240	480	390	770	600	1180
	2 GB	490	970	790	1530	1220	2360
	4 GB	970	1910	1560	3010	2410	4640
	8 GB	1980	3890	3180	6130	4910	9440
16 GB	3980	7840	6410	12350	9880	19000	

Aspect ratio		4:3			
Picture size		2M : 2M EZ (1600 × 1200 pixels)		0.3M : 0.3M EZ (640 × 480 pixels)	
Quality					
Built-in Memory (Approx. 24MB)		23	46	115	190
Card	16 MB	13	27	68	110
	32 MB	29	58	145	230
	64 MB	61	120	290	480
	128 MB	125	240	600	970
	256 MB	240	470	1170	1900
	512 MB	480	940	2320	3770
	1 GB	970	1880	4640	7550
	2 GB	1920	3610	8780	12290
	4 GB	3770	7090	17240	24130
	8 GB	7670	14440	35080	49120
16 GB	15440	29070	70590	98840	

Aspect ratio		3:2					
Picture size		7M : 7M (3264 × 2176 pixels)		4.5M : 4.5M EZ (2560 × 1712 pixels)		2.5M : 2.5M EZ (2048 × 1360 pixels)	
Quality							
Built-in Memory (Approx. 24MB)		6	12	10	21	16	32
Card	16 MB	3	7	5	12	9	18
	32 MB	7	16	13	26	20	40
	64 MB	16	33	27	54	43	83
	128 MB	34	69	56	110	88	165
	256 MB	68	135	110	210	170	330
	512 MB	135	260	210	430	340	650
	1 GB	270	530	440	860	680	1310
	2 GB	550	1070	890	1700	1360	2560
	4 GB	1080	2110	1740	3350	2680	5020
	8 GB	2210	4300	3550	6820	5450	10230
16 GB	4450	8660	7160	13720	10980	20590	

Aspect ratio		16:9					
Picture size		6M : 6M (3264 × 1840 pixels)		3.5M : 3.5M EZ (2560 × 1440 pixels)		2M : 2M EZ (1920 × 1080 pixels)	
Quality							
Built-in Memory (Approx. 24MB)		7	15	12	25	22	42
Card	16 MB	4	8	7	14	12	25
	32 MB	9	19	15	31	27	53
	64 MB	20	40	32	64	57	105
	128 MB	41	81	66	130	115	220
	256 MB	81	155	130	250	230	430
	512 MB	160	310	250	510	450	860
	1 GB	320	630	520	1020	910	1720
	2 GB	650	1270	1040	2040	1800	3410
	4 GB	1280	2510	2040	4020	3540	6700
	8 GB	2610	5110	4160	8180	7220	13640
16 GB	5250	10290	8370	16470	14530	27450	

■ Available recording time (In Motion picture mode)

Picture quality setting		30fps VGA	10fps VGA	30fps QVGA	10fps QVGA	30fps 16:9	10fps 16:9
Built-in Memory (Approx. 24MB)		—	—	46 s	2 min 20 s	—	—
Card	16 MB	6 s	26 s	26 s	1 min 23 s	5 s	22 s
	32 MB	17 s	58 s	59 s	2 min 55 s	14 s	50 s
	64 MB	39 s	2 min	2 min	6 min	33 s	1 min 46 s
	128 MB	1 min 23 s	4 min 10 s	4 min 10 s	12 min 20 s	1 min 11 s	3 min 35 s
	256 MB	2 min 45 s	8 min 10 s	8 min 10 s	24 min	2 min 20 s	7 min
	512 MB	5 min 30 s	16 min 20 s	16 min 20 s	47 min 50 s	4 min 40 s	14 min
	1 GB	11 min	32 min 50 s	32 min 50 s	1 h 35 min	9 min 20 s	28 min 10 s
	2 GB	22 min 30 s	1 h 7 min	1 h 7 min	3 h 15 min	19 min 20 s	57 min 30 s
	4 GB*	44 min 20 s	2 h 11 min	2 h 11 min	6 h 22 min	38 min	1 h 53 min
	8 GB*	1 h 30 min	4 h 28 min	4 h 28 min	12 h 59 min	1 h 17 min	3 h 50 min
	16 GB*	3 h 1 min	8 h 59 min	8 h 59 min	26 h 8 min	2 h 36 min	7 h 43 min

* The volume of motion picture is limited to 2 GB per recording session. The maximum available recording time for up to 2 GB only is displayed on the screen.



- The number of recordable pictures and the available recording time displayed on the LCD monitor may not decrease in order.
- This unit does not support recording motion pictures on MultiMediaCards.
- The extended optical zoom does not work in [HIGH SENS.] and [HI-SPEED BURST] mode so the picture size for [EZ] is not displayed.

Specifications

Digital Camera:	Information for your safety
Power Source:	DC 3 V
Power Consumption:	1.5 W (When recording) 0.6 W (When playing back)
Camera Effective pixels:	8,100,000 pixels
Image sensor:	1/2.5" CCD
Total pixels:	8,320,000 pixels Primary color filter
Lens:	Optical 3 × zoom, f=5.5 to 16.5 mm [35 mm film camera equivalent: 33 to 100 mm] / F2.8 to F5.1
Digital zoom:	Max. 4 ×
Extended optical zoom:	Max. 4.8 ×
Focus:	Normal / Macro 5-area-focusing / 1-area-focusing (high speed) / 1-area-focusing
Focus range:	Normal : 50 cm (1.64 feet) to ∞ Macro / Intelligent: 5 cm (0.16 feet) (Wide) / 30 cm (0.98 feet) (Tele) to ∞ Scene mode: settings may be different to those shown above
Shutter system:	Electronic shutter+Mechanical shutter
Motion picture recording:	Aspect ratio [4:3]: 640 × 480 pixels (30 frames/second, 10 frames/second) (When a card is used.) / 320 × 240 pixels (30 frames/second, 10 frames/second) Aspect ratio [16:9]: 848 × 480 pixels (30 frames/second, 10 frames/second) (When a card is used.) With audio
Burst recording	
Burst speed:	Approx. 2.5 pictures/second (NORMAL), Approx. 2 pictures/second (Unlimited)
Number of recordable pictures:	Max. 7 pictures (Standard), max. 4 pictures (Fine), Depends on the remaining capacity of the built-in memory or the card (Unlimited).
Hi-speed burst	
Burst speed:	Approx. 5.5 pictures/second
Picture size:	[2M] (4:3), [2.5M] (3:2), [2M] (16:9)

ISO sensitivity:	AUTO/ 100 / 200 / 400 / 800 / 1600 [HIGH SENS.] mode: 1600 to 6400
Shutter speed:	8 seconds to 1/2,000th of a second [STARRY SKY] mode: 15 seconds, 30 seconds, 60 seconds
White balance:	Auto white balance / Daylight / Cloudy / Shade / Halogen / White set
Exposure (AE):	Program AE Exposure compensation (1/3 EV Step, -2 EV to +2 EV)
Metering mode:	Multiple
LCD monitor:	TFT LCD 2.5" (Approx. 230,000 dots) (field of view ratio about 100%)
Flash:	Flash range: Approx. 30 cm (0.98 feet) to 5.9 m (15.42 feet) (Wide [ISO AUTO] mode) AUTO, AUTO / Red-eye reduction, Forced ON (Forced ON / Red-eye reduction), (Slow sync. / Red-eye reduction), Forced OFF
Microphone:	Monaural
Recording media:	Built-in Memory (Approx. 24 MB) / SD Memory Card / SDHC Memory Card/MultiMediaCard (Still pictures only)
Picture size:	
Still picture:	Aspect ratio [4:3]: 3264 × 2448 pixels, 2560 × 1920 pixels, 2048 × 1536 pixels, 1600 × 1200 pixels, 640 × 480 pixels Aspect ratio [3:2]: 3264 × 2176 pixels, 2560 × 1712 pixels, 2048 × 1360 pixels Aspect ratio [16:9]: 3264 × 1840 pixels, 2560 × 1440 pixels, 1920 × 1080 pixels
Motion picture:	Aspect ratio [4:3]: 640 × 480 pixels (Only when using an SD Memory card / SDHC Memory Card), 320 × 240 pixels Aspect ratio [16:9]: 848 × 480 pixels (Only when using an SD Memory card / SDHC Memory Card)
Quality:	Fine / Standard
Recording file format	
Still Picture:	JPEG (Design rule for Camera File system, based on Exif 2.21 standard), DPOF corresponding
Motion pictures:	"QuickTime Motion JPEG" (motion pictures with audio)
Interface	
Digital:	USB 2.0 (Full Speed)

Others

Analog video / audio: NTSC / PAL Composite (Switched by menu),
Audio line output (monaural)

Terminal

DIGITAL/AV OUT: Dedicated jack (8 pin)

DC IN: Type1 jack (Only when using DC coupler)

Dimensions: 3.77" (W) × 2.44" (H) × 1.23" (D)
(95.7 mm (W) × 62.0 mm (H) × 31.2 mm (D))
(excluding the projection part)

Mass (Weight): Approx. 0.28 lb/129 g
(excluding Memory Card and battery)
Approx. 0.39 lb/177 g
(with Memory Card and battery)

Operating Temperature: 0 °C to 40 °C (32 °F to 104 °F)

Operating Humidity: 10 % to 80 %

Digital Camera Accessory System

DC coupler:

DMW-DCC2

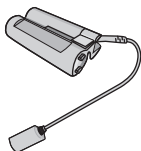

AC Adaptor:

DMW-AC6PP

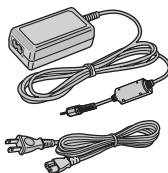

- Purchase DC coupler and AC adaptor together. You cannot use either of them individually.

Soft Case:

DMW-CLZ10

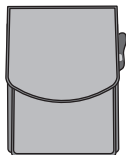

Semi Hard Case:

DMW-CHTZ3



SDHC Memory Card
SD Memory Card



- 16 GB SDHC Memory Card RP-SDV16GU1K
 8 GB SDHC Memory Card RP-SDV08GU1K
 4 GB SDHC Memory Card RP-SDM04GU1K
 4 GB SDHC Memory Card RP-SDV04GU1K
 2 GB SD Memory Card..... RP-SDM02GU1A
 2 GB SD Memory Card..... RP-SDV02GU1A
 1 GB SD Memory Card..... RP-SDR01GU1A
 1 GB SD Memory Card..... RP-SDV01GU1A

- NOTE: Accessories and/or model numbers may vary by country. Please consult your local dealer.

■ Connecting DC coupler and AC adaptor to the camera

Read operating instructions on how to connect the DC coupler to the camera.

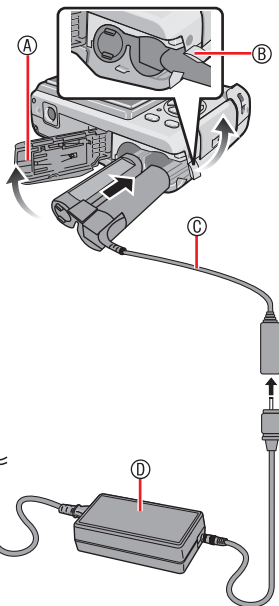

Ⓐ Battery door

Ⓑ DC coupler door

- Open the DC coupler door in advance.

Ⓒ DC coupler

Ⓓ AC adaptor

- Make sure the battery door is closed.
- Use specified DC coupler and AC adaptor (left). Using other products may cause malfunction.

Digital Camera Accessory Order Form

(For USA Customers)

Please photocopy this form when placing an order.

1. Digital Camera Model # _____

2. Items Ordered

Accessory #	Description	Price Each	Quantity	Total Price
Subtotal				
Your State & Local Sales Tax				
Shipping & Handling				6.95
Total Enclosed				

3. Method of payment (check one)

- Check of Money Order enclosed (NO C.O.D.SHIPMENTS)
- VISA Credit Card # _____
- MasterCard Expiration Date _____
- Discover Customer Signature _____

Make Check or Money Order to: PANASONIC ACCESSORIES

(Please do not send cash)

4. Shipping information (UPS delivery requires complete street address)

Ship To:

Mr.

Mrs.

Ms.

First Last

Phone#:

Day () _____

Street Address

Night () _____

City State Zip

TO OBTAIN ANY OF OUR DIGITAL CAMERA ACCESSORIES YOU CAN DO ANY OF THE FOLLOWING:

VISIT YOUR LOCAL PANASONIC DEALER

OR

CALL PANASONIC'S ACCESSORY ORDER LINE AT 1-800-332-5368

[6 AM-5 PM M-F, 6 AM-10:30 AM SAT, PACIFIC TIME]

OR

MAIL THIS ORDER TO: PANASONIC SERVICE AND TECHNOLOGY COMPANY
ACCESSORY ORDER OFFICE

20421 84th Avenue South Kent, WA. 98032

In CANADA, please contact your local Dealer for more information about accessories.

Request for Service Notice (For USA Only)

Please photocopy this form when making a request for service notice.

In the unlikely event this product needs service.

Request for Service Notice: (USA Only)

- Please include your **proof of purchase**.
(Failure to do so will delay your repair.)
 - To further speed your repair, please provide an explanation of what wrong with the unit and any symptom it is exhibiting.
-
-
-
-

Mail this completed form and your Proof of Purchase along with your unit to:
Panasonic Camera and Digital Service Center
1590 Touhy Ave.
Elk Grove Village, IL 60007

Limited Warranty (For USA Only)

PANASONIC CONSUMER ELECTRONICS COMPANY, DIVISION OF
PANASONIC CORPORATION OF NORTH AMERICA

One Panasonic Way, Secaucus, New Jersey 07094

PANASONIC PUERTO RICO, INC.

Ave. 65 de Infantería, Km. 9.5, San Gabriel Industrial Park, Carolina, Puerto Rico 00985

Panasonic Digital Still Camera Limited Warranty

Limited Warranty Coverage

If your product does not work properly because of a defect in materials or workmanship, Panasonic Consumer Electronics Company or Panasonic Puerto Rico, Inc. (collectively referred to as "the warrantor") will, for the length of the period indicated on the chart below, which starts with the date of original purchase ("warranty period"), at its option either (a) repair your product with new or refurbished parts, or (b) replace it with a new or refurbished product. The decision to repair or replace will be made by the warrantor.

PRODUCT OR PART NAME	PARTS	LABOR
DIGITAL STILL CAMERA (EXCEPT ITEMS LISTED BELOW)	1 (ONE) YEAR	1 (ONE) YEAR
CCD	6 (SIX) MONTHS	90 (NINETY) DAYS
RECHARGEABLE BATTERY PACK (IN EXCHANGE FOR DEFECTIVE BATTERY PACK)	90 (NINETY) DAYS	NOT APPLICABLE
SD MEMORY CARD (IN EXCHANGE FOR DEFECTIVE SD CARD)	90 (NINETY) DAYS	NOT APPLICABLE

During the "Labor" warranty period there will be no charge for labor. During the "Parts" warranty period, there will be no charge for parts. You must carry-in or mail-in your product during the warranty period. If non-rechargeable batteries are included, they are not warranted. This warranty only applies to products purchased and serviced in the United States or Puerto Rico. This warranty is extended only to the original purchaser of a new product which was not sold "as is". A purchase receipt or other proof of the original purchase date is required for warranty service.

Carry-In or Mail-In Service

For Carry-In or Mail-In Service in the United States call 1-800-211-PANA(7262).

For assistance in Puerto Rico call Panasonic Puerto Rico, Inc. (787)-750-4300 or fax (787)-768-2910.

This warranty **ONLY COVERS** failures due to defects in materials or workmanship, and **DOES NOT COVER** normal wear and tear or cosmetic damage. The warranty **ALSO DOES NOT COVER** damages which occurred in shipment, or failures which are caused by products not supplied by the warrantor, or failures which result from accidents, misuse, abuse, neglect, mishandling, misapplication, alteration, faulty installation, set-up adjustments, misadjustment of consumer controls, improper maintenance, power line surge, lightning damage, modification, or commercial use (such as in a hotel, office, restaurant, or other business), rental use of the product, service by anyone other than a Factory Service Center or other Authorized Servicer, or damage that is attributable to acts of God.

THERE ARE NO EXPRESS WARRANTIES EXCEPT AS LISTED UNDER "LIMITED WARRANTY COVERAGE". THE WARRANTOR IS NOT LIABLE FOR INCIDENTAL OR CONSEQUENTIAL DAMAGES RESULTING FROM THE USE OF THIS PRODUCT, OR ARISING OUT OF ANY BREACH OF THIS WARRANTY. (As examples, this excludes damages for lost time, travel to and from the servicer, loss of media or images, data or other memory content. The items listed are not exclusive, but are for illustration only.) **ALL EXPRESS AND IMPLIED WARRANTIES, INCLUDING THE WARRANTY OF MERCHANTABILITY, ARE LIMITED TO THE PERIOD OF THE LIMITED WARRANTY.**

Some states do not allow the exclusion or limitation of incidental or consequential damages, or limitations on how long an implied warranty lasts, so the exclusions may not apply to you.

This warranty gives you specific legal rights and you may also have other rights which vary from state to state. If a problem with this product develops during or after the warranty period, you may contact your dealer or Service Center. If the problem is not handled to your satisfaction, then write to the warrantor's Consumer Affairs Department at the addresses listed for the warrantor.

PARTS AND SERVICE WHICH ARE NOT COVERED BY THIS LIMITED WARRANTY ARE YOUR RESPONSIBILITY.

Customer Services Directory (For USA Only)

Obtain Product Information and Operating Assistance; locate your nearest Dealer or Service Center; purchase Parts and Accessories; or make Customer Service and Literature requests by visiting our Web Site at:

<http://www.panasonic.com/consumersupport>

or, contact us via the web at:

<http://www.panasonic.com/contactinfo>

You may also contact us directly at:

1-800-211-PANA (7262),

Monday-Friday 9 am-9 pm; Saturday-Sunday 10 am-7 pm, EST

For hearing or speech impaired TTY users, TTY : 1-877-833-8855

Accessory Purchases

Purchase Parts, Accessories and Instruction Books online for all Panasonic Products by visiting our Web Site at:

<http://www.pstc.panasonic.com>

or, send your request by E-mail to:

npcparts@us.panasonic.com

You may also contact us directly at:

1-800-332-5368 (Phone) 1-800-237-9080 (Fax Only)

(Monday - Friday 9 am to 9 pm, EST.)

PANASONIC SERVICE AND TECHNOLOGY COMPANY

20421 84th Avenue South, Kent, WA 98032

(We Accept Visa, MasterCard, Discover Card, American Express, and Personal Checks)

For hearing or speech impaired TTY users, TTY : 1-866-605-1277

Product Repairs

Centralized Factory Service Center

Panasonic Camera and Digital Service Center

MAIL TO : 1590 Touhy Ave.
Elk Grove Village, IL 60007

Please carefully pack and ship, prepaid and insured, to the Elk Grove Village Centralized Factory Service Center.

Customer's in Puerto Rico, please ship or carry in to location below ("Service in Puerto Rico").

Service in Puerto Rico

Panasonic Puerto Rico, Inc.:

Ave. 65 de Infantería, Km. 9.5, San Gabriel Industrial Park,
Carolina, Puerto Rico 00985

Phone (787) 750-4300 Fax (787) 768-2910

As of January 2007

Précautions à prendre (Pour le Canada seulement)

AVERTISSEMENT: POUR RÉDUIRE TOUT RISQUE D'INCENDIE, DE CHOC ÉLECTRIQUE OU DE DOMMAGE,

- **N'EXPOSEZ PAS CET APPAREIL À LA PLUIE, À L'HUMIDITÉ, AUX GOUTTES OU ÉCLABOUSSURES ET ASSUREZ-VOUS QU'AUCUN OBJET OU VASE REMPLI DE LIQUIDE NE SOIT PLACÉ SUR L'APPAREIL.**
- **N'UTILISEZ QUE LES ACCESSOIRES RECOMMANDÉS.**
- **NE RETIREZ PAS LE COUVERCLE (OU LE PANNEAU ARRIÈRE) ; AUCUNE PIÈCE INTERNE NE PEUT ÊTRE RÉPARÉE PAR L'UTILISATEUR. CONFIEZ TOUTE RÉPARATION À UN TECHNICIEN QUALIFIÉ.**

LA PRISE DE COURANT DOIT SE TROUVER À PROXIMITÉ DE L'APPAREIL ET ÊTRE FACILEMENT ACCESSIBLE.

MISE EN GARDE

Une pile de remplacement inappropriée peut exploser. Ne remplacez qu'avec une pile identique ou d'un type recommandé par le fabricant. L'élimination des piles usées doit être faite conformément aux instructions du fabricant.

Une plaque signalétique se trouve en dessous de l'appareil.

Cet appareil numérique de la classe B est conforme à la norme NMB-003 du Canada.

- Si vous songez à utiliser des piles rechargeables, les piles fabriquées par Panasonic sont recommandées.
- Assurez-vous d'utiliser un adaptateur secteur (modèle DMW-AC6PP: en option) et coupleur c.c. (modèle DMW-DCC2: en option) de marque Panasonic.
- N'utilisez pas d'autres câbles de connexion USB à l'exception de celui fourni.
- N'utilisez pas d'autres câbles AV à l'exception de celui qui est fourni.
- Conservez la carte mémoire hors de portée des enfants afin qu'ils ne puissent pas l'avaler.

À propos des piles

- N'exposez pas les piles à la flamme ou à la chaleur.
- Ne laissez pas la ou les batteries dans un véhicule exposé au soleil avec vitres et portes fermées pendant une longue période de temps.

Évitez d'approcher l'appareil photo de tout équipement magnétisé (four à micro-ondes, téléviseur, équipement de jeux vidéo, etc.).

- Si vous utilisez l'appareil photo à proximité d'un téléviseur, les radiations électromagnétiques pourraient nuire au son et à l'image.
- N'utilisez pas l'appareil photo à proximité d'un téléphone cellulaire; cela pourrait entraîner un bruit nuisible à l'image et au son.
- Le puissant champ magnétique de haut-parleurs ou de moteurs peut endommager les données enregistrées sur support magnétique et distordre les images.
- Les ondes électromagnétiques émises par un microprocesseur peuvent nuire à l'appareil photo numérique et perturber l'image et le son.
- Advenant le cas où le fonctionnement de l'appareil serait dérangé par un champ magnétique, coupez le contact, retirez les piles ou débranchez l'adaptateur secteur (modèle DMW-AC6PP; en option) pour ensuite soit remettre la batterie en place, soit rebrancher l'adaptateur. Remettez l'appareil en marche.

N'utilisez pas l'appareil photo à proximité d'un émetteur radio ou de lignes à haute tension.

- L'utilisation de l'appareil photo à proximité d'un émetteur radio ou de lignes à haute tension pourrait perturber les images enregistrées.

Index

A		D	
Access indication.....	25	Date printing.....	84, 92
Aerial photo mode.....	52	DC coupler.....	87, 90, 113
AF/AE lock.....	30	Deleting pictures.....	35
AF area.....	28	Demonstration of jitter/ movement detection screen.....	24
AF assist lamp.....	66	Digital zoom.....	33
AF mode.....	64	DPOF print.....	83
Aspect convert.....	80	E	
Aspect ratio.....	61	Easy zoom.....	32
Auto bracket.....	45	Economy mode.....	22
Auto demo.....	24	Exposure.....	29
Auto power LCD.....	38	Extended optical zoom.....	31
Auto review.....	22	EZ.....	31
Auto white balance.....	63	F	
Available recording time.....	109	Favorite.....	82
AV cable.....	94	Favorite play.....	72
AV OUT socket.....	94	File number.....	22, 88
B		Fine.....	60
Baby mode.....	49	Fireworks mode.....	52
Backlight compensation.....	27	Flash.....	39
Batteries.....	11	Focus.....	26, 28, 29, 42
Battery type.....	21	Focus indication.....	26, 28
Beach mode.....	52	Folder.....	88
Beep.....	21	Food mode.....	48
Built-in memory.....	16	Format.....	23
Burst.....	65	G	
C		Guide line display.....	37
Calendar.....	68, 74	H	
Candle light mode.....	49	High-speed burst mode.....	50
Card.....	16	High angle.....	38
Category playback.....	71	High sensitivity mode.....	50
Clock set.....	17	I	
Color mode.....	65	Intelligent ISO.....	61
Compensating the exposure.....	44	Intelligent mode.....	26
Copy.....	86	ISO sensitivity.....	62
		L	
		Language setting.....	24
		LCD monitor.....	25

M		R	
Macro shooting	42	REC mode menu	59
Maintenance	97	Reset	23
Monitor	21	Resize	78
Motion picture mode	53	Rotate	81
Multi playback	67	Rotate display	81
N		S	
Night portrait mode	48	Scene menu	23
Night scenery mode	48	Scene mode	46
No. reset	22	Scenery mode	47
Normal picture mode	28	Self-timer	43
NTSC	23	Self portrait mode	47
Number of prints	83, 92	Setup menu	20
Number of recordable pictures	13, 107	Slide show	70
O		Snow mode	52
Optical zoom	31	Soft skin mode	47
P		Sports mode	48
Page layout	92	Stabilizer	66
PAL	23	Standard	60
Paper size	92	Starry sky mode	51
Party mode	49	Status indicator	15, 22, 25
Pet mode	50	Sunset mode	50
PictBridge	90	T	
Picture quality setting	53	Text stamp	76
Picture size	60	Thumbnail	34
Playback mode	18	Title edit	74
Playback mode menu	74	Travel date	55
Playback motion pictures	73	Trimming	79
Playback zoom	69	TV aspect	23
Portrait mode	47	U	
Power LCD	38	USB connection cable	87, 90
Protect	85	USB mode	23
PTP	88	W	
Q		White balance	62
Quality	60	World time	57
Quick AF	64	Z	
Quick setting	59	Zoom	31

MEMO



QuickTime and the QuickTime logo are trademarks or registered trademarks of Apple Inc., used under license therefrom.

**Panasonic Consumer Electronics Company,
Division of Panasonic Corporation of North America**

One Panasonic Way, Secaucus, NJ 07094

Panasonic Puerto Rico, Inc.

Ave. 65 de Infantería, Km. 9.5, San Gabriel Industrial Park, Carolina, Puerto Rico 00985

Panasonic Canada Inc.

5770 Ambler Drive, Mississauga, Ontario, L4W 2T3

© 2008 Matsushita Electric Industrial Co., Ltd.



VQT1L50
H1207HM0

