

Panasonic[®]

Operating Instructions

Digital Camera

Model No. **DMC-LZ5** ✓

DMC-LZ4

DMC-LZ3

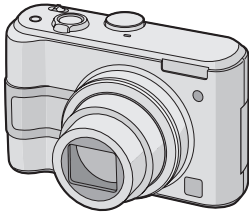

LUMIX

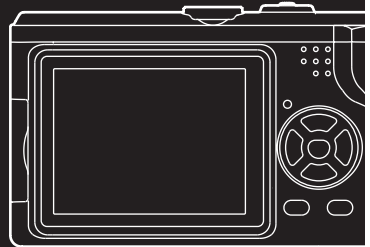
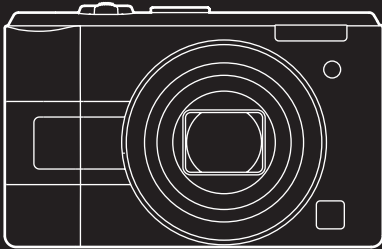

Before connecting, operating or adjusting this product, please read the instructions completely.

For USA assistance, please call: 1-800-272-7033 or send e-mail to : digitalstillcam@panasonic.com

For Canadian assistance, please call: 1-800-561-5505 or visit us at www.panasonic.ca

Dear Customer,

We would like to take this opportunity to thank you for purchasing this Panasonic Digital Camera. Please read these Operating Instructions carefully and keep them handy for future reference.

Information for Your Safety

WARNING

TO REDUCE THE RISK OF FIRE OR SHOCK HAZARD AND ANNOYING INTERFERENCE, USE ONLY THE RECOMMENDED ACCESSORIES AND DO NOT EXPOSE THIS EQUIPMENT TO RAIN OR MOISTURE. DO NOT REMOVE THE COVER (OR BACK); THERE ARE NO USER SERVICEABLE PARTS INSIDE. REFER SERVICING TO QUALIFIED SERVICE PERSONNEL.

Carefully observe copyright laws. Recording of pre-recorded tapes or discs or other published or broadcast material for purposes other than your own private use may infringe copyright laws. Even for the purpose of private use, recording of certain material may be restricted.

- Please note that the actual controls and components, menu items, etc. of your Digital Camera may look somewhat different from those shown in the illustrations in these Operating Instructions.
- SD Logo is a trademark.
- Other names, company names, and product names printed in these instructions are trademarks or registered trademarks of the companies concerned.

The socket outlet shall be installed near the equipment and easily accessible or the mains plug or an appliance coupler shall remain readily operable.

CAUTION

Danger of explosion if battery is incorrectly replaced. Replace only with the same or equivalent type recommended by the manufacturer. Dispose of used batteries according to the manufacturer's instructions.

FCC Note: (U.S. only)

This equipment has been tested and found to comply with the limits for a Class B digital device, pursuant to Part 15 of the FCC Rules. These limits are designed to provide reasonable protection against harmful interference in a residential installation. This equipment generates, uses, and can radiate radio frequency energy and, if not installed and used in accordance with the instructions, may cause harmful interference to radio communications. However, there is no guarantee that interference will not occur in a particular installation. If this equipment does cause harmful interference to radio or television reception, which can be determined by turning the equipment off and on, the user is encouraged to try to correct the interference by one or more of the following measures:

- Reorient or relocate the receiving antenna.
- Increase the separation between the equipment and receiver.
- Connect the equipment into an outlet on a circuit different from that to which the receiver is connected.
- Consult the dealer or an experienced radio/TV technician for help.

FCC Caution: To assure continued compliance, follow the attached installation instructions and use only shielded interface cables with ferrite core when connecting to computer or peripheral devices.

Any changes or modifications not expressly approved by the party responsible for compliance could void the user's authority to operate this equipment.

Trade Name: Panasonic
 Model No.: DMC-LZ5
 DMC-LZ4
 DMC-LZ3

Responsible party: Panasonic Corporation of North America
 One Panasonic Way, Secaucus, NJ 07094

Support Contact: Panasonic Consumer Electronics Company
 1-800-272-7033

This device complies with Part 15 of the FCC Rules. Operation is subject to the following two conditions: (1) This device may not cause harmful interference, and (2) this device must accept any interference received, including interference that may cause undesired operation.

This Class B digital apparatus complies with Canadian ICES-003



Panasonic
DMC-LZ5



Panasonic
DMC-LZ4



Panasonic
DMC-LZ3

-If you see this symbol-

Information on Disposal in other Countries outside the European Union

This symbol is only valid in the European Union.

If you wish to discard this product, please contact your local authorities or dealer and ask for the correct method of disposal.



■ Care of the camera

- **Do not strongly shake or bump the camera.** The camera may stop operating normally, pictures may not be recorded or the lens may be damaged.
- **Sand or dust may cause the camera to malfunction. Make sure that sand or dust does not get into the lens or the terminals when using the camera on a beach etc.**
- Make sure that water does not get into the camera when using it on a rainy day or on a beach.
- **If water or seawater splashes on the camera, wet a soft cloth with tap water, wring it well and use it to wipe the camera body carefully. Then, wipe the camera again with a dry cloth.**

■ About the LCD monitor

- **Do not press the LCD monitor with excessive force. Uneven colors may appear on the LCD monitor and it may malfunction.**
- Condensation may form on the LCD monitor in places with large temperature

differences. Wipe the condensation with a soft, dry cloth.

- If the camera is cold when you turn it on, the picture on the LCD monitor will be slightly darker than usual at first. However, the picture will return to normal brightness when the internal temperature of the camera increases.

Extremely high precision technology is employed to produce the LCD monitor screen. However there may be some dark or bright spots (red, blue or green) on the screen. This is not a malfunction. The LCD monitor screen has more than 99.99% effective pixels with a mere 0.01% of the pixels inactive or always lit. The spots will not be recorded on pictures on the built-in memory or a card.

■ About the Lens

- Do not press the lens with excessive force.
- Do not leave the camera with the lens facing the sun as it may cause the camera to malfunction. Also, be careful when you leave the camera outside or near a window.

■ About Condensation (When the lens is fogged up)

- Condensation occurs when the ambient temperature or humidity changes as described below. Be careful of condensation since it causes lens stains, fungus and camera malfunction.
 - When the camera is taken from the cold outdoors to the warm indoors.
 - When the camera is taken from outside to inside an air-conditioned car.
 - When cool wind from an air conditioner etc. blows directly on the camera.
 - In humid places
- To prevent condensation, put the camera in a plastic bag until the temperature of the camera is close to the ambient

temperature. If condensation occurs, turn the camera off and leave it for about 2 hours. The fog will disappear naturally when the temperature of the camera becomes close to the ambient temperature.

■ When not using the camera for a long period of time

- Store the batteries in a cool and dry place with a relatively stable temperature.
[Recommended temperature: 15 °C to 25 °C (59 °F to 77 °F), Recommended humidity: 40% to 60%]
- Always remove the batteries and the card from the camera.
- If the batteries are left inserted in the camera they will discharge as a weak electric current passes through them even if the camera is turned off. [Read P13 for information about Ni-MH (nickel metal hydride) batteries.]
- We recommend storing the camera with a desiccant (silica gel) when you keep it in a closet or a cabinet.

About The Mode Dial

Adjust part **A** to the desired mode. The mode dial can be rotated 360°. Rotate it slowly and surely to adjust to each mode. (Do not adjust it to parts where there is no mode.)

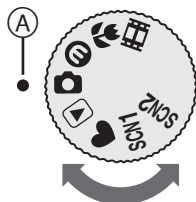

: Normal picture mode (P24)

Use this mode for normal recording.

: Economy mode (P47)

This mode allows you to take pictures while reducing battery power consumption.

: Macro mode (P48)

This mode allows you to take a close-up picture of a subject.

: Motion picture mode (P55)

This mode allows you to record motion pictures.

SCN1 : Scene mode 1

SCN2 : Scene mode 2 (P49)

This mode allows you to match the picture to the scene being recorded.

Two frequently used scenes can be set to the mode dials [SCN1] and [SCN2].

: Simple mode (P27)

This mode is recommended for beginners.

: Playback mode (P33)

This mode allows you to play back recorded pictures.

■ About indications in these operating instructions



Modes indicated here allow you to use the functions or settings described on this page. Set the mode dial to any of the modes to use the functions or settings.



Convenient or helpful information for use of the camera is described.

■ About illustrations in these operating instructions

Please note that the appearance of the product, the illustration or the menu screen are a little different from those in actual use. The procedure is described for DMC-LZ5 as an example.

■ About illustrations of the cursor button

In these operating instructions, the operations on the cursor button are described as illustrated as shown. e.g.: When you press the ▼ button

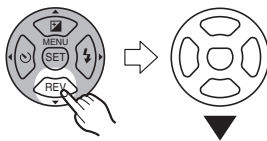

Contents

Before Use

Information for Your Safety	2
About The Mode Dial	5

Preparation

Standard Accessories	9
Names of the Components	9
Quick Guide	11
About the Batteries	12
Inserting/Removing the Batteries.....	16
Inserting/Removing the Card (Optional)	16
About the Built-in Memory/the Card.....	17
Setting Date/Time (Clock Set)	19
About the Setup Menu	20

Basic

Taking Pictures	24
Taking Pictures in Simple Mode	27
Taking Pictures with the Zoom	29
• Using the Optical Zoom	29
• Using the Extended Optical Zoom (EZ)	30
• Using the Digital Zoom Further extending the zoom	31
Checking the Recorded Picture (Review)	32
Playing Back Pictures	33
Deleting Pictures.....	34

Advanced

About the LCD Monitor	36
• Changing the information displayed	36
• Recording a picture with the camera held high above your head (High angle mode)	38
Taking Pictures using the Built-in Flash.....	39

Taking Pictures with the Self-timer	42
Compensating the Exposure	43
Taking Pictures using Auto Bracket	44
Optical Image Stabilizer	45
Taking Pictures using Burst Mode	46
Economizing Power Consumption	47
Taking Close-up Pictures.....	48
Scene Mode.....	49
– Portrait mode	50
– Soft skin mode	50
– Scenery mode	50
– Sports mode	51
– Night portrait mode	51
– Night scenery mode.....	51
– Food mode	52
– Party mode	52
– Candle light mode.....	52
– Fireworks mode	53
– Starry sky mode.....	53
– Snow mode.....	54
– Baby mode 1/Baby mode 2	54
– High Sensitivity mode	55
Motion Picture Mode.....	55
Displaying Multiple Screens (Multi Playback).....	57
Using the Playback Zoom	58
Playing Back Motion Pictures/ Pictures with Audio.....	59

Menu Settings

Using the [REC] Mode Menu	61
• [W.BALANCE] Adjusting the hue for a more natural picture	62
• [SENSITIVITY] Setting the light sensitivity	63
• [ASPECT RATIO] Setting the aspect ratio of pictures ...	64
• [PICT.SIZE]/[QUALITY] Setting a picture size and quality that matches your use of the pictures	64
• [AUDIO REC.] (DMC-LZ5) Recording still pictures with audio ...	66

• [AF MODE] Setting the focus method.....	66
• [AF ASSIST LAMP] Focusing in low light conditions becomes easier	67
• [SLOW SHUTTER] Recording bright pictures in dark places	67
• [COL.EFFECT] Setting color effects for the recorded pictures	68
• [PICT.ADJ.] Adjusting the picture quality for the recorded pictures	68
Using the [PLAY] mode menu	69
• [SLIDE SHOW] Playing back pictures in order for a fixed duration.....	69
• [FAVORITE] Setting your favorite pictures	70
• [ROTATE DISP.]/[ROTATE] To display the picture rotated	71
• [DPOF PRINT] Setting the picture to print and the number of prints	72
• [PROTECT] Preventing accidental erasure of pictures	74
• [AUDIO DUB.] (DMC-LZ5) Adding audio after taking pictures	75
• [RESIZE] Making the picture smaller	75
• [TRIMMING] Enlarging a picture and trimming it...	76
• [COPY] Copying the picture data	77
• [FORMAT] Initializing the built-in memory or a card	78

Connecting to other equipment

Connecting to a PC.....	80
Printing the Pictures.....	82
Playing Back Pictures on a TV Screen ...	86

Others

Screen Display.....	87
Cautions for Use	89
Message Display	91
Troubleshooting	92
Number of recordable pictures and available recording time	97
Specifications.....	100
Digital Camera Accessory System	103
Digital Camera Accessory Order Form (For USA Customers).....	104
Request for Service Notice (For USA Only).....	105
Limited Warranty (For USA Only)	106
Customer Services Directory (For USA Only).....	108
Index	109
Spanish Quick Use Guide/ Guía rápida en español.....	111

Standard Accessories

Check that all the accessories are included before using the camera.

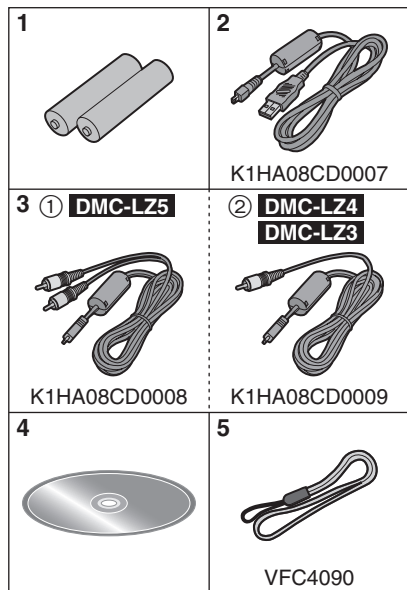

1 Batteries

AA Oxyride batteries (ZR6)

2 USB Connection Cable

3 ①: AV Cable

(Supplied with DMC-LZ5)

②: Video Cable

(Supplied with DMC-LZ4/
DMC-LZ3)

4 CD-ROM

5 Strap

•SD Memory Cards are optional.

You can record or play back pictures on the built-in memory when you are not using a card. (P17)

•For information about optional accessories, refer to the "Digital Camera Accessory System". (P103)

• If any accessories are lost, customers in the USA should contact Panasonic's parts department at 1 800 833-9626 and customers in Canada should contact 1 800 561-5505 for further information about obtaining replacement parts.

Names of the Components

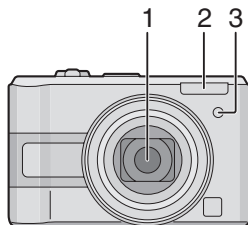

1 Lens (P4)

2 Flash (P39)

3 Self-timer indicator (P42) AF assist lamp (P67)

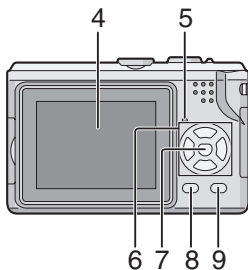

4 LCD monitor (P4, 36, 87)

5 Status indicator (P13, 16, 47)

6 Cursor buttons

◀/Self-timer button (P42)

▼/[REV] button (P32)

▶/Flash setting button (P39)

▲/Exposure compensation (P43)/Auto bracket (P44)/White balance fine

adjustment (P62)/Backlight
compensation in simple mode (P28)
button

- 7 [MENU/SET] button (P20)
- 8 [DISPLAY] (P36)/[HIGH ANGLE] (P38)
button
- 9 Delete (P34)/Single or burst mode
(P46) button

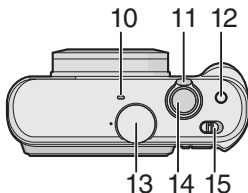

- 10 Microphone (DMC-LZ5) (P55, 66, 75)
- 11 Zoom lever (P29)
- 12 Optical image stabilizer button (P45)
- 13 Mode dial (P5)
- 14 Shutter button (P24, 55)
- 15 Camera ON/OFF switch (P11, 19)

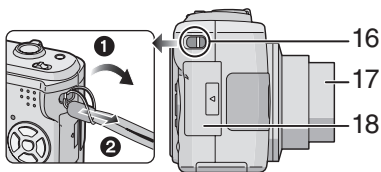

- 16 Strap eyelet
- 17 Lens barrel
- 18 Card door (P16)

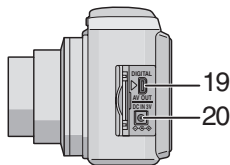

- 19 [DIGITAL/AV OUT] socket
(DMC-LZ5)
[DIGITAL/V.OUT] socket
(DMC-LZ4/DMC-LZ3)
(P80, 82, 86)
- 20 [DC IN] socket (P80, 82)
 - Always use a genuine Panasonic AC
adaptor (DMW-AC6; optional).

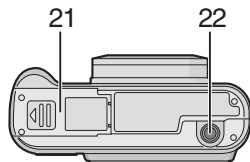

- 21 Battery door (P16)
- 22 Tripod receptacle
 - When you use a tripod, make sure it is
stable when the camera is attached to
it.

Quick Guide

This is an overview of how to record and playback pictures with the camera. For each step, be sure to refer to the pages indicated in brackets.

1 Insert the batteries. (P16)

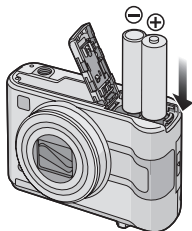

- When you do not use the card (optional), you can record or play back pictures on the built-in memory (P17). Refer to P16 when you use a card.

2 Turn the camera on to take pictures.

- Set the clock. (P19)
- Select the type of battery in use on [BATTERY TYPE] in the [SETUP] menu. (P21)

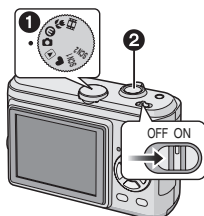

- 1 Set the mode dial to [📷].
- 2 Press the shutter button to take pictures. (P24)

3 Play back the pictures.

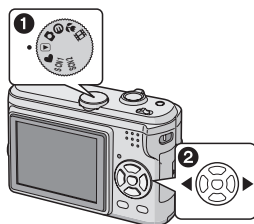

- 1 Set the mode dial to [▶].
- 2 Select the picture you want to view. (P33)

About the Batteries

■ Usable batteries

AA Oxyride batteries (supplied)*
AA Alkaline batteries (optional)
AA Rechargeable Ni-MH (nickel metal hydride) batteries (optional)

- **One of the following messages appears when you insert batteries for the first time, change the batteries when they become exhausted etc.**

[CURRENT BATTERY TYPE SETTING: OXYRIDE]/[CURRENT BATTERY TYPE SETTING: ALKALINE/Ni-MH]

If the batteries inserted are different from the type displayed in the message, set [BATTERY TYPE] in the [SETUP] menu. (P21)

- **The battery type that is set can be distinguished by the color of the battery indication (blue or white).**
 - The battery indication does not appear when using the AC adaptor (DMW-AC6; optional).

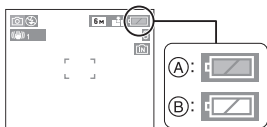

- (A) **When oxyride batteries are selected**
The battery indication turns blue.
- (B) **When alkaline/Ni-MH batteries are selected**
The battery indication turns white.

*An oxyride battery is a new type of non-rechargeable battery developed by Panasonic. It has more power than a regular alkaline battery and is suitable for high-drain equipment such as digital cameras.

- We recommend using Panasonic batteries.

- Battery performance may vary greatly depending on the brand used and the storage life and conditions of the batteries.
- Battery performance temporarily deteriorates in low temperature conditions [10 °C (50 °F) or less]. However, it recovers when the temperature returns to normal.
- Depending on the temperature and the conditions of use, the camera may not operate properly and the batteries may become exhausted without warning because the battery indication is not displayed correctly. This is not a malfunction.
- We recommend turning the camera off frequently while recording to conserve battery power for longer battery life. If you will be using the camera for long periods of time, using rechargeable Ni-MH batteries is recommended.
- Exhausted batteries may recover some performance if left for a period of time. However, they cannot be used for a long time. Be sure to replace them with new batteries.

■ Unusable batteries

Manganese batteries	Lithium batteries
Nickel batteries	Ni-Cd batteries

- Operation is not guaranteed when using the batteries listed above. The batteries can leak and the following malfunctions can occur:
 - The remaining battery power is not displayed accurately.
 - The camera does not turn on.
 - Data written to the built-in memory or the card is damaged resulting in loss of the photographs.

■ Battery shapes that cannot be used

- Batteries with unusual shapes cause leakage, heat generation or explosion if inserted in the camera.

- Batteries with the covering partly or fully peeled off. Never use these batteries. (Refer to the illustration below.)

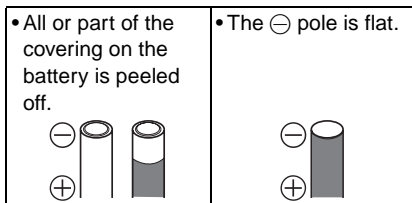

■ Battery indication

The remaining battery power appears on the LCD monitor. [It does not appear when using the AC adaptor (DMW-AC6; optional)].



- The battery indication turns red and blinks. (The status indicator blinks when the LCD monitor is turned off.)
- Replace with new batteries or fully charged Ni-MH batteries.

■ Proper Care and Handling of Batteries

Mishandling batteries may cause leakage, heat generation, fire or explosion. Observe the following.

- Do not splash batteries with water/sea water or wet battery terminals.
- Do not peel off or scratch the covering on batteries.
- Do not drop, throw or subject batteries to other strong impacts.
- Do not use batteries that show signs of leakage, deformation, discoloration etc.
- Do not store batteries in high humidity areas or high temperatures.
- Keep batteries away from children.
- Always use 2 new batteries of the same type when replacing batteries.
- Remove the batteries if you do not intend to use the unit for a long time.
- Batteries may heat up soon after you start using the unit. Turn the camera off and

wait until the battery temperature decreases before removing them.

- Battery performance deteriorates and recording/playback time decreases when the ambient temperature is low [10 °C (50 °F) or less]. This is particularly true when using oxyride or alkaline batteries so warm them in your pocket etc. before using them. Make sure that no metal objects such as a lighter are placed together with the batteries when warming them in your pocket.
- If there is grease or dirt on the battery poles, the recording/playback time may become extremely short. Before inserting the batteries, clean the battery terminals with a soft, dry cloth.

If battery leakage occurs, remove the batteries and thoroughly wipe the leakage in the battery compartment. Insert new batteries or fully charged Ni-MH batteries.

If battery electrolyte spills on your hands or clothes, thoroughly wash them with water. Battery electrolyte can cause loss of sight if it comes into contact with your eyes. Do not rub your eyes. Wash them immediately with clean water and consult a doctor.

■ Ni-MH Batteries (Nickel Metal Hydride)

You can use Ni-MH batteries after charging them with a nickel metal hydride battery charger. However, improper handling of the batteries may cause leakage, heat generation, fire or explosion. Observe the following.

- If there is dirt on the battery poles, you may not be able to charge normally. Clean the battery poles and the battery recharger terminals with a soft, dry cloth.
- When charging batteries for the first time, or after having not used them for a long period of time, they may not charge fully. This is a feature of Ni-MH batteries and is not a malfunction. Battery performance

will become normal after a few charges and discharges.

- We recommend charging the batteries after they are fully discharged. If you charge the batteries before they are fully discharged, it can reduce battery performance. This is called "memory effect".
- If "memory effect" occurs, continue using the batteries until the camera stops working and then charge them fully. Battery performance will be restored after a few charges and discharges.
- Over time Ni-MH batteries naturally discharge and their capacity lowers even when they are not used.
- Once the batteries have reached full charge, do not continue to charge them.
- Do not peel off or scratch the covering on Ni-MH batteries.
- Read the operating instructions for the battery charger.

Ni-MH batteries have a limited life. Battery capacity gradually decreases over time. If the length of time you can use the camera is extremely short even after fully charging the batteries, they may have exceeded their life span. Purchase new batteries.

- Battery life differs depending on the conditions of storage and usage and the environment.

When not using the batteries for a long period of time

- If the batteries are left in the camera they will discharge. This is because a small electrical current continues to flow even when the camera is turned off. If the batteries continue to be left in the camera, they will discharge excessively and may become unusable even if charged.
- When storing the batteries for a long period of time, we recommend charging them once a year. Remove the batteries from the camera and store them again after they have completely discharged.

■ Battery life

The number of recordable pictures (By CIPA standard in normal picture mode)

Batteries Used	Number of recordable pictures
Panasonic Oxide batteries (supplied or optional)	DMC-LZ5: Approx. 235 pictures (Approx. 117 min)
	DMC-LZ4/DMC-LZ3: Approx. 250 pictures (Approx. 125 min)
Panasonic Alkaline batteries (optional)	DMC-LZ5: Approx. 140 pictures (Approx. 70 min)
	DMC-LZ4/DMC-LZ3: Approx. 155 pictures (Approx. 77 min)
Fully charged Panasonic Ni-MH batteries (optional)	DMC-LZ5: Approx. 380 pictures (Approx. 190 min)
	DMC-LZ4/DMC-LZ3: Approx. 400 pictures (Approx. 200 min)

Recording conditions by CIPA standard

- Temperature: 23 °C (73.4 °F)
Humidity: 50% when the LCD monitor is on.
 - Using a Panasonic SD Memory Card (16 MB)*
 - Starting recording 30 seconds after the camera is turned on. (When the optical image stabilizer function is set to [MODE1])
 - **Recording once every 30 seconds**, with full flash every second recording.
 - Rotating the zoom lever from Tele to Wide or vice versa in every recording.
 - Turning the camera off every 10 recordings./Leaving the camera until the batteries cool down.
- *The card is not supplied.
- CIPA is an abbreviation of [Camera & Imaging Products Association].

The number of recordable pictures varies depending on the recording interval time. If the recording interval time becomes longer, the number of recordable pictures decreases. (e.g. When recording once every 2 minutes: about 1/4 the number when recording once every 30 seconds)

The number of recordable pictures in low temperatures
(In normal picture mode when the temperature is 0 °C (32 °F) and other recording conditions comply with CIPA standard.)

Batteries Used	Number of recordable pictures
Panasonic Oxyride batteries (supplied or optional)	DMC-LZ5: Approx. 40 pictures (Approx. 20 min)
	DMC-LZ4/DMC-LZ3: Approx. 45 pictures (Approx. 22 min)
Panasonic Alkaline batteries (optional)	DMC-LZ5: Approx. 35 pictures (Approx. 17 min)
	DMC-LZ4/DMC-LZ3: Approx. 35 pictures (Approx. 17 min)
Fully charged Panasonic Ni-MH batteries (optional)	DMC-LZ5: Approx. 340 pictures (Approx. 170 min)
	DMC-LZ4/DMC-LZ3: Approx. 360 pictures (Approx. 180 min)

- Please note that the performance of oxyride batteries and alkaline batteries significantly decreases in low temperature conditions.

Playback time

Batteries Used	Continuous playback time
Panasonic Oxyride batteries (supplied or optional)	DMC-LZ5: Approx. 410 min
	DMC-LZ4/DMC-LZ3: Approx. 420 min
Panasonic Alkaline batteries (optional)	DMC-LZ5: Approx. 400 min
	DMC-LZ4/DMC-LZ3: Approx. 410 min
Fully charged Panasonic Ni-MH batteries (optional)	DMC-LZ5: Approx. 500 min
	DMC-LZ4/DMC-LZ3: Approx. 510 min



- The number of recordable pictures and playback time will vary depending on the operating conditions and how the battery is stored.
- The number of recordable pictures and the playback time will also vary depending on the brand and type of batteries used.
- We recommend using power save mode (P22) or economy mode (P47) or turning off the camera frequently while recording to maintain battery power.

Inserting/Removing the Batteries

- Check that the camera is turned off and that the lens is retracted.
- Use oxyride batteries (supplied), alkaline batteries (optional) or Ni-MH batteries (optional).

1 Slide the battery door to open it.

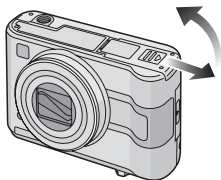

2 Insert the batteries with the ⊕ and ⊖ poles aligned correctly.

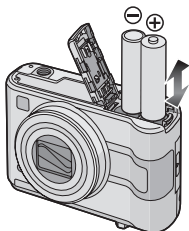

- 3
- 1 Close the battery door.
 - 2 Slide the battery door to the end and then close it firmly.

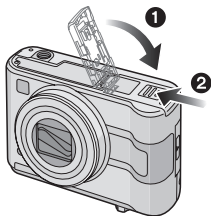

- Select the battery type being used in [BATTERY TYPE] in the [SETUP] menu. (P21)
- Remove the batteries after use.
- When batteries have been inserted for more than 3 hours, the clock setting is stored in the camera for approximately 3 months even if the batteries are removed.
- Do not remove the card or the batteries while the camera accesses the built-in memory or a card. The data may be damaged. (P17)
- Remove the batteries after the LCD monitor and the status indicator (green) turn off. Otherwise, the settings on the camera may not be stored properly.

Inserting/Removing the Card (Optional)

- Check that the camera is turned off and that the lens is retracted.
- You can record or play back pictures on the built-in memory when you are not using a card. (P17)

1 Slide the card door to open it.

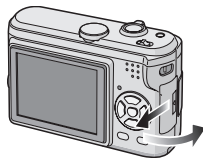

2 Insert:

Insert the card fully until it clicks and it is locked.

Remove:

Push the card until it clicks, then pull the card out upright.

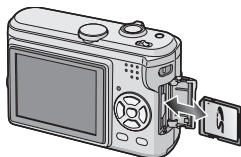

- Check the direction of the card.
- Do not touch the connection terminals on the back side of the card.
- The card may be damaged if it is not fully inserted.

3 ① Close the card door.

② Slide the card door to the end and then close it firmly.



- If the card door cannot be completely closed, remove the card and insert it again.



- The card and the data may be damaged if it is inserted or removed while the camera is on.
- We recommend using Panasonic's SD Memory Card.

About the Built-in Memory/the Card

■ Built-in Memory []

You can record or play back pictures on the built-in memory when you are not using a card.

- The built-in memory capacity is about 14 MB.
- Picture size is fixed to QVGA (320×240 pixels) when recording motion pictures to the built-in memory. (P55)

■ Card []

You can record or play back pictures on a card.

(The built-in memory cannot be used when a card is inserted.)

■ Access to the built-in memory or the card

- The access indication lights red when pictures are being recorded on the built-in memory (or the card).
- Do not do the following when the access indication lights, pictures are being read or deleted or the built-in memory (or the card) is being formatted (P78).
 - Turn the camera off.
 - Remove the batteries or the card (if used).
 - Shake or impact the camera.
 - Disconnect the AC adaptor (DMW-AC6; optional). (when using the AC adaptor)

The card or the data may be damaged and the camera may not operate normally.

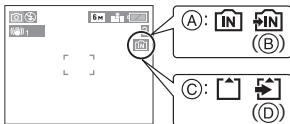
Icons displayed on the screen:

- (A): When using the built-in memory
- (B): When accessing the built-in memory
- (C): When using the card
- (D): When accessing the card

• **Picture data recorded on the built-in memory or a card can be copied from the built-in memory to the card or vice versa. (P77)**



• **The built-in memory (about 14 MB) can be used as a temporary storage device when the card being used becomes full.**

- The data on the built-in memory or the card may be damaged or lost due to electromagnetic waves, static electricity or breakdown of the camera or the card. We recommend storing important data on a PC etc.
- The access time for the built-in memory may be longer than the access time for a card. (Max. about 7 sec.)
- If the card was formatted on a PC or other equipment, format it again on the camera. (P78)

■ **SD Memory Card (optional) and MultiMediaCard (optional)**

- The SD Memory Card and MultiMediaCard are small, lightweight, removable external cards.
- The reading/writing speed of an SD Memory Card is fast. The SD Memory Card is equipped with a Write-Protect switch (E) that can inhibit writing and formatting a card. (When the switch is slid to the [LOCK] side, it is not possible to write or delete data on the card and

format it. When the switch is unlocked, these functions become available.)

SD Memory Card

- On this unit, you can use SD Memory Cards of the following capacity (from 8 MB to 2 GB).

8 MB, 16 MB, 32 MB, 64 MB, 128 MB, 256 MB, 512 MB, 1 GB, 2 GB (Maximum)

Please confirm the latest information on the following website.

<http://panasonic.co.jp/pavc/global/cs>

(This Site is English only.)

- Refer to P97 for information about the number of recordable pictures and the available recording time for each SD Memory Card.
- This unit supports SD Memory Cards formatted in FAT12 system and FAT16 system based on SD Memory Card Specifications.
- This unit does not support recording motion pictures on MultiMediaCards. We recommend using High Speed SD Memory Cards when recording motion pictures (P55).



- The reading/writing speed of a MultiMediaCard is slower than an SD Memory Card. When a MultiMediaCard is used, the performance of certain features may be slightly slower than advertised.
- Keep the Memory Card out of reach of children to prevent swallowing.

Setting Date/Time (Clock Set)

Initial setting

The clock is not set so the following screen appears when you turn the camera on.

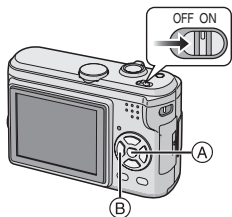

(A): [MENU/SET] button

(B): Cursor buttons

- The screen disappears after about 5 seconds. Turn the camera off and on again.

1 Press [MENU/SET].

2 Press ▲/▼/◀/▶ to select the date and time.

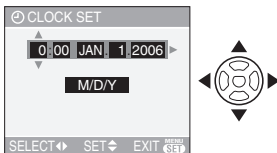

- ◀/▶: Select the desired item.
- ▲/▼: Set the display order for the date and time.

3 Press [MENU/SET] several times to close the menu.

- Turn the camera off after finishing setting the clock. Then turn it on and check that the clock setting is correct.

Changing the clock setting

- 1 Press [MENU/SET] to display the menu and then press ◀.
- 2 Press ▼ to select the [SETUP] menu icon [P] and then press ▶.
- 3 Press ▲/▼ to select [CLOCK SET] and then press ▶. Set as shown previously.

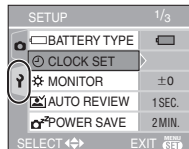

- When batteries have been inserted for more than 3 hours, the clock setting is stored in the camera for approximately 3 months even if the batteries are removed.
- You can set the year from 2000 to 2099. The 24-hour system is used.
- If the date is not set in the camera it will not be printed when you use a photo printing service, even if the store provides a date printing option for your photographs. (P73)

About the Setup Menu

- Set items as required. (Refer to P21 to P23 for each menu item.)
- Menu items differ depending on the mode selected with the mode dial (P5).
The following example shows how to set [BEEP] when normal picture mode [CAM] is selected.
- Select [RESET] to return the settings to the initial settings at the time of purchase. (P23)

1 Press [MENU/SET] and then press ◀.

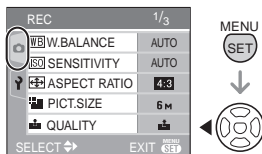

2 Press ▼ to select the [SETUP] menu icon [⌋] and then press ▶.

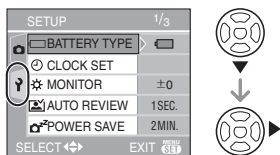

3 Press ▲/▼ to select the menu item.

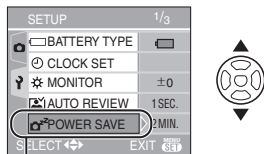

A

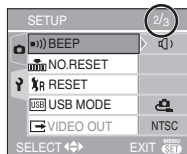

- Press ▼ at (A) to switch to the next menu screen.

4 Press ▶, press ▲/▼ to select the setting and then press [MENU/SET].

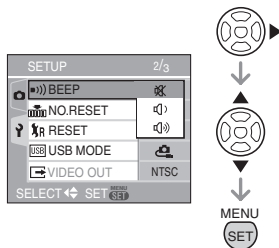

5 Press [MENU/SET] to close the menu.

- You can also press the shutter button halfway to close the menu.

■ About the menu screen items

- There are 3 menu screens (1/3, 2/3 and 3/3).
- You can switch menu screens from any menu item by rotating the zoom lever.

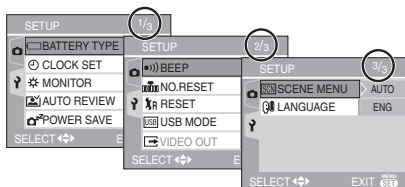

[BATTERY TYPE]

Press [] to display the [SETUP] menu and select the item to set. (P20)

Select the type of battery being used from the following 2 types.

[] ALKALINE (LR6)/Ni-MH]:

Alkaline batteries or Ni-MH batteries

[] OXYRIDE (ZR6)]:

Oxyride batteries

- If the type of battery being used and the type of battery selected are not the same, the battery indication will not be displayed correctly.
- The [BATTERY TYPE] setting also affects simple mode [].

[CLOCK SET]

Press [] to display the [SETUP] menu and select the item to set. (P20)

Change date and time. (P19)

[MONITOR]

Press [] to display the [SETUP] menu and select the item to set. (P20)

Adjust the brightness of the LCD monitor in 7 steps.

- The [MONITOR] setting also affects simple mode [].

[AUTO REVIEW]



Press [] to display the [SETUP] menu and select the item to set. (P20)

[1SEC.]: The recorded picture automatically appears on the screen for about 1 second.

[3SEC.]: The recorded picture automatically appears on the screen for about 3 seconds.

[ZOOM]: The recorded picture automatically appears on the screen for about 1 second. It is then enlarged 4 times and appears for about 1 second. This mode is useful for confirming focus. Pictures recorded using auto bracket or burst mode and pictures with audio (DMC-LZ5) are not enlarged even if [ZOOM] is selected.

[OFF]: The recorded picture does not automatically appear.

- The auto review function is not activated in motion picture mode [].
- When pictures are recorded in simple mode [], auto bracket (P44) or burst mode (P46), the auto review function is activated regardless of the setting on the auto review function. (The picture is not enlarged.)
- The auto review function is activated while pictures with audio (DMC-LZ5) (P66) are being recorded regardless of its setting. (The picture is not enlarged.)
- The auto review setting is disabled when using auto bracket or burst mode, in motion picture mode [] or when [AUDIO REC.] (DMC-LZ5) is set to [ON].

[POWER SAVE] (Except for mode)

Press [] to display the [SETUP] menu and select the item to set. (P20)

[1MIN.]/[2MIN.]/[5MIN.]/[10MIN.]:

Power save mode is activated (the camera is automatically turned off to save the battery life) if the camera has not been used for the time selected on the setting.

[OFF]: Power save mode is not activated.

- Press the shutter button halfway or turn the camera off and on to cancel power save mode.
- In simple mode [], power save mode is fixed to [2MIN.].
- When using the AC adaptor (DMW-AC6; optional), connecting to a PC or a printer, recording or playing back motion pictures and during a slide show, power save mode is not activated. (However, the setting for power save mode is fixed to [10MIN.] while pausing a slide show or playing back a manual slide show.)

ECO [ECONOMY]

(mode only)

Press [] to display the [SETUP] menu and select the item to set. (P20)

Battery life is saved by reducing the brightness of the LCD monitor and turning it off automatically when the camera is not being used in recording mode. (P47)

[LEVEL 1]: The LCD monitor turns off if the camera is not operated for about 15 seconds in recording mode.

[LEVEL 2]: The LCD monitor turns off if the camera is not operated for about 15 seconds in recording mode or for about 5 seconds after taking a picture.

- The status indicator lights while the LCD monitor is turned off. Press any button to turn on the LCD monitor again.

- Power save mode is fixed to [2MIN.] in economy mode.
[However, power save mode is not activated when using the AC adaptor (DMW-AC6; optional).]
- Economy mode will not work when the menu screen is displayed or the self-timer is set.

[BEEP]

Press [] to display the [SETUP] menu and select the item to set. (P20)

[]: No operation sound

[]: Soft operation sound

[]: Loud operation sound

- The [BEEP] setting also affects simple mode [].

[NO.RESET]

Press [] to display the [SETUP] menu and select the item to set. (P20)

Set this when you want the file number of the next recording to start from 0001. (The folder number is updated and the file number starts from 0001.)

- A folder number between 100 and 999 can be assigned.
When the folder number reaches 999, the number cannot be reset. We recommend formatting the card after saving the data on a PC or elsewhere.
- To reset the folder number to 100, format the built-in memory (P78) or the card first and then use this function to reset the file number.
A reset screen for the folder number will then appear. Select [YES] to reset the folder number.
- Refer to P81 for detailed information about the file number and the folder number.
- The [NO.RESET] setting also affects simple mode [].

[R] [RESET]

Press [] to display the [SETUP] menu and select the item to set. (P20)

The [REC] or [SETUP] menu settings are reset to the initial settings.

- The birthday setting for [BABY1]/[BABY2] (P54) in scene mode is also reset when the [SETUP] menu settings are reset. Also, in the [PLAY] mode menu, [ROTATE DISP.] (P71) is reset to [ON] and [FAVORITE] (P70) is reset to [OFF].
- The battery type setting, the folder number and the clock setting are not changed.

[USB] [USB MODE]

Press [] to display the [SETUP] menu and select the item to set. (P20)

Select the USB communication system after or before connecting the camera to your PC or your printer with the USB connection cable (supplied).

[ SELECT ON CONNECTION]:

Select either [PC] or [PictBridge (PTP)] if you connected the camera to a PC or a printer supporting PictBridge.

[ PC]:

Set after or before connecting to a PC.

[ PictBridge (PTP)]:

Set after or before connecting to a printer supporting PictBridge.

- When [PC] is selected, the camera is connected via the USB Mass Storage communication system.
- When [PictBridge (PTP)] is selected, the camera is connected via the PTP (Picture Transfer Protocol) communication system.

[ VIDEO OUT]

(Playback mode only) (P86)

Press [] to display the [SETUP] menu and select the item to set. (P20)

[NTSC]: Video output is set to NTSC system.

[PAL]: Video output is set to PAL system.

[SCN] [SCENE MENU]

Press [] to display the [SETUP] menu and select the item to set. (P20)

[AUTO]: [SCENE MODE] menu appears automatically when setting the mode dial to [SCN1] or [SCN2]. Select the desired scene mode. (P49)

[OFF]: [SCENE MODE] menu does not appear when setting the mode dial to [SCN1] or [SCN2] and the camera is operated in the scene mode currently selected. If you change the scene mode, press [MENU/SET] to display the [SCENE MODE] menu and then select the desired scene mode.

[ LANGUAGE]

Press [] to display the [SETUP] menu and select the item to set. (P20)

Set the language on the menu screen from the following languages. Set to the desired language with ▲/▼ and store it with [MENU/SET].

[ENGLISH]: English

[DEUTSCH]: German

[FRANÇAIS]: French

[ESPAÑOL]: Spanish

[ITALIANO]: Italian

[中文]: Chinese (Traditional)

[日本語]: Japanese

- If you set a different language by mistake, select [] from the menu icons to set the desired language.

- The [LANGUAGE] setting also affects simple mode [].

Taking Pictures



The camera automatically sets the shutter speed and the aperture value according to the brightness of the subject.

- 1 **Turn the camera on.**
- 2 **Select normal picture mode [P].**

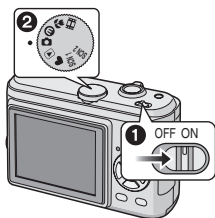

- 2 **Aim the AF area ① to the point you want to focus on and then press the shutter button halfway.**

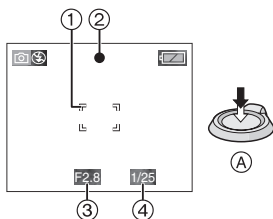

- (A): Press the shutter button halfway to focus.
- The focus indication (2) lights and then the aperture value (3) and the shutter speed (4) are displayed.
- If 5-area-focusing or 3-area-focusing (High speed) is used in AF mode, the AF area does not appear until the subject is brought into focus. (P66)
- The AF area displayed is bigger than usual when using the digital zoom or

when taking pictures in dark places. (P66)

	When the subject is not focused	When the subject is focused
Focus indication	Blinks (green)	On (green)
AF area	Turns white to red or no AF area	Turns white to green
Sound	Beeps 4 times	Beeps 2 times

- 3 **Take a picture.**

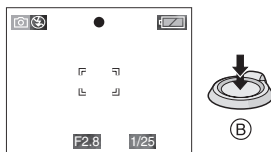

- (B): Press the shutter button fully to take the picture.



- We recommend checking that the clock is set properly before taking pictures. (P19)
- When you press the shutter button, the screen may become bright or dark for a moment. This function allows easy adjustment of focus and the recorded picture will not be affected.
- When a time is set for power save (P22), the camera automatically turns off if you do not operate it within the set time. To operate the camera again, press the shutter button halfway or turn the camera off and on.
- To avoid noise, we recommend decreasing the ISO sensitivity (P63) or setting [PICT.ADJ.] to [NATURAL]. (P68) (ISO sensitivity is set to [AUTO] when the camera is shipped. Therefore, when taking pictures indoors etc. the ISO sensitivity increases.)

■ Tips for taking good pictures

- Hold the camera gently with both hands, keep your arms still at your side and stand with your feet slightly apart.
- Make sure the camera does not shake when you press the shutter button.
- Do not cover the photo flash or the AF assist lamp with your fingers or other objects.
- Do not touch the front of the lens.
- If the LCD monitor screen is difficult to see because of light from the sun etc. shining on it, we recommend using your hand or another object to block the light when using the camera.

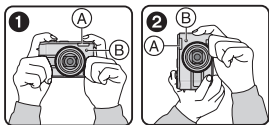

①: When holding the camera sideways

②: When holding the camera vertically

(A): Photo flash

(B): AF assist lamp

■ Direction detection function

Pictures recorded with the camera held vertically are played back vertically (rotated). (Only when [ROTATE DISP.] (P71) is set to [ON])

- Pictures may not be displayed vertically if they were taken with the camera aimed up or down.
- Motion pictures taken with the camera held vertically are not displayed vertically.

■ When you want to take a subject outside the AF area (AF/AE Lock)

When recording a picture of people with a composition like the following picture, you will not be able to focus the camera on the

subject because the people are outside the AF area.

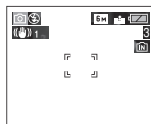

In this case,

- 1 Aim the AF area at the subject.
 - 2 Press the shutter button halfway to fix the focus and the exposure.
 - The focus indication lights when the subject is focused.
 - 3 Press and hold the shutter button halfway while moving the camera as you compose the picture.
 - 4 Press the shutter button fully.
- You can repeatedly retry AF/AE lock before pressing the shutter button fully.

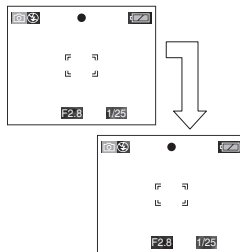

■ Focusing

- The focus range is 50 cm (1.64 feet) to ∞ (Wide), 1.2 m (3.94 feet) to ∞ (Tele). Use macro mode when recording close-up pictures. (P48)
- If the distance between the camera and the subject is beyond the focus range of the camera, the picture may not be properly focused even if the focus indication lights.
- In the following cases, the camera will not focus on subjects properly.
 - When there are both near and distant subjects in a scene.
 - When there is dirt or dust on glass between the lens and the subject.

- When there are illuminated or glittering objects around the subject.
- When taking a picture in dark places.
- When the subject is moving fast.
- When the scene has low contrast.
- When jitter occurs.
- When recording a very bright subject.

We recommend taking pictures using AF/AE lock. In dark places, the AF assist lamp (P67) may turn on to focus on the subject.

- Even when the focus indication appears and the subject is focused, it is canceled if you release the shutter button. Press the shutter button halfway again.

■ Preventing jitter (camera shake)

- Be careful of jittering when pressing the shutter button.
- If jitter could occur because of slow shutter speed, the jitter alert (A) appears.

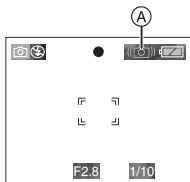

- When the jitter alert appears, we recommend using a tripod. If you cannot use a tripod, be careful how you hold the camera (P25). The use of the self-timer prevents jittering caused by pressing the shutter button when you are using a tripod (P42).
- Shutter speed will be slower particularly in the following cases. Keep the camera still from the moment the shutter button is pressed until the picture appears on the screen. We recommend using a tripod.
 - Slow sync./Red-eye reduction (P39)
 - [NIGHT PORTRAIT] (P51)
 - [NIGHT SCENERY] (P51)
 - [PARTY] (P52)
 - [CANDLE LIGHT] (P52)
 - [FIREWORKS] (P53)

- [STARRY SKY] (P53)

- When the shutter speed is slowed in [SLOW SHUTTER] (P67)

■ Exposure

- If you press the shutter button halfway when the exposure is not adequate, the aperture value and the shutter speed turn red. (They do not turn red when the flash is activated.)
- The brightness of the screen may differ from the brightness of the recorded pictures especially when recording in low light conditions.
- When most of the subjects on the screen are bright (e.g. a blue sky on a clear day, a snowy field etc.), the recorded pictures may become dark. In this case, compensate the exposure value on the camera. (P43)

Taking Pictures in Simple Mode



This mode allows beginners to take pictures easily. Only the basic functions appear in the menu to make operations simple.

Basic menu settings

1 Press [MENU/SET].

2 Press ▲/▼ to select the desired menu item and then press ►.

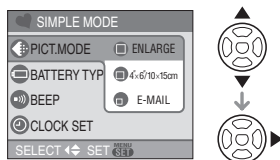

3 Press ▲/▼ to select the desired setting and then press [MENU/SET].

4 Press [MENU/SET] to close the menu.

- You can also press the shutter button halfway to close the menu.

Settings in Simple mode

[PICT.MODE]

ENLARGE	Suitable for enlarging the pictures to be printed to 8"×10" size, letter size etc.
4"×6"/10×15cm	Suitable for regular size printing.
E-MAIL	Suitable for attaching pictures to e-mails or adding pictures to websites.

[BATTERY TYPE]

Change the battery type being used. (P21)

[BEEP]

OFF	No operation sound
LOW	Soft operation sound
HIGH	Loud operation sound

[CLOCK SET]









Change date and time. (P19)

- If [4"×6"/10×15cm] or [E-MAIL] are set in [PICT.MODE], the extended optical zoom is activated and the zoom ratio is extended to a maximum of 8.3×(DMC-LZ5)/7.5×(DMC-LZ4/DMC-LZ3). (P30)
- The settings for [BATTERY TYPE], [BEEP] and [CLOCK SET] in simple mode are also applied to other recording modes.
- The settings for [MONITOR] (P21), [NO.RESET] (P22) and [LANGUAGE] (P23) in the [SETUP] menu are applied to simple mode.

Other Settings in Simple mode

In simple mode, other settings are fixed as follows. For more information about each setting, refer to the page indicated.

- Focus range:
 - 50 cm (1.64 feet) to ∞ (Tele)
 - 5 cm (0.16 feet) to ∞ (Wide)
- [AUTO REVIEW] (P21): [1SEC.]
- [POWER SAVE] (P22): [2MIN.]
- Self-timer (P42): 10 seconds
- Optical Image Stabilizer (P45): [MODE1]
- Burst speed (P46): Low speed (2 frames/second)
- [W.BALANCE] (P62): [AUTO]



- [SENSITIVITY] (P63):
[AUTO]
- [ASPECT RATIO]/[PICT.SIZE]/[QUALITY] (P64):
– [ ENLARGE]:
 4:3 /  (6M) (DMC-LZ5) /  (5M)
 (DMC-LZ4/DMC-LZ3)/Fine
- [ 4"×6"/10×15cm]:
 3:2 /  (2.5M EZ)/Standard
- [ E-MAIL]:
 4:3 /  (0.3M EZ)/Standard
- [AF MODE] (P66):
[] (1-area-focusing)
- [AF ASSIST LAMP] (P67):
[ON]
- [SLOW SHUTTER] (P67):
[1/8–]

- You cannot use the following functions in simple mode.
 - High angle mode
 - White balance fine adjustment
 - Exposure compensation
 - Auto bracket
 - [AUDIO REC.] (DMC-LZ5)
 - [D.ZOOM]
 - [COL.EFFECT]
 - [PICT.ADJ.]





■ The Backlight Compensation

Backlight refers to when light comes from the back of a subject.

In this case, the subject, such as a person, will become dark.

If you press ▲, [] (compensating backlight ON indication)  appears and the backlight compensation function is activated. This function compensates the backlight by brightening the whole of the picture.



- If you press ▲ while [] is displayed, [] disappears and the backlight compensation function is canceled.
- We recommend using the flash when you use the backlight compensation function. (When using the flash, it is fixed to Forced ON [].)
- The flash setting is fixed to AUTO/Red-eye reduction [] when the backlight compensation function is set to [OFF].

Taking Pictures with the Zoom

Using the Optical Zoom



You can make people and subjects appear closer with the 6× optical zoom and landscapes can be recorded in wide angle.

■ To make subjects appear closer use (Tele)

Rotate the zoom lever towards Tele.

- When the setting for picture size is **[6M]** (6M) (DMC-LZ5).



■ To make subjects appear further away use (Wide)

Rotate the zoom lever towards Wide.

- When the setting for picture size is **[6M]** (6M) (DMC-LZ5).



- The optical zoom is set to Wide (1×) when the camera is turned on.
- Depending on the zoom magnification, the picture may have some distortion. Distortion will be more visible when using

a wider area of the zoom lens as you move closer to the subject.

- Depending on the zoom magnification, the picture may have some colored fringes around the subject. This is called chromatic aberration and may be more visible when recording distant subjects.
- If you use the zoom function after focusing on the subject, focus on the subject again.
- The indicated zoom magnification is an approximation.
- The lens barrel (P10) extends or retracts according to the zoom position. Take care not to interrupt the motion of the lens barrel while the zoom lever is rotated.
- In motion picture mode **[M]**, the zoom magnification is fixed to the value set at the start of recording.

Using the Extended Optical Zoom (EZ)



This camera has a 6× optical zoom. However, if the picture size is not set to the highest setting for each aspect ratio [4:3 / 3:2 / 16:9], a maximum of 8.3× (DMC-LZ5)/7.5× (DMC-LZ4/DMC-LZ3) zoom can be achieved with no picture quality deterioration.

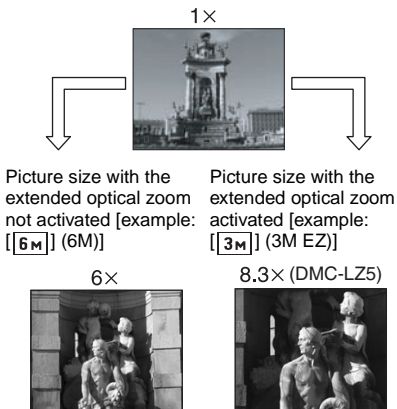

Picture size and maximum zoom magnification

(○: Available, —: Not available)

Aspect ratio	Picture size	Maximum zoom magnification	Extended optical zoom
4:3	[6M] / [6M] (6M) (DMC-LZ5)/ [5M] / [5M] (5M) (DMC-LZ4/DMC-LZ3)	6×	—
3:2	[5M] (5M) (DMC-LZ5)/ [4.5M] (4.5M) (DMC-LZ4/DMC-LZ3)		
16:9	[4.5M] (4.5M) (DMC-LZ5)/ [3.5M] (3.5M) (DMC-LZ4/DMC-LZ3)		
4:3	[3M] (3M EZ) [2M] (2M EZ) [1M] (1M EZ) [0.3M] / [0.3M] (0.3M EZ)	8.3× (DMC-LZ5) 7.5× (DMC-LZ4/DMC-LZ3)	○
3:2	[2.5M] / [2.5M] (2.5M EZ)		
16:9	[2M] (2M EZ)		

Extended optical zoom mechanism

When you set the picture size to [[3M]] (3M EZ) (3 million pixels), the 6M (6 million pixels) (DMC-LZ5)/5M (5 million pixels) (DMC-LZ4/DMC-LZ3) CCD area is cropped to the center 3M (3 million pixels) area, allowing a picture with a higher zoom effect.



- Refer to P64 for aspect ratio settings, P64 for picture size and P27 for simple mode [♥].
- “EZ” is an abbreviation of [Extended optical Zoom].
- You can further enhance the zoom magnification with the extended optical zoom without worrying about further picture distortion.
- If you set a picture size that activates the extended optical zoom, the extended optical zoom icon [EZ] is displayed on the screen when you use the zoom function.
- The zoom will stop moving for an instant near [W] (1×) when the extended optical zoom is used. This is not a malfunction.
- The indicated zoom magnification is an approximation.
- In motion picture mode [H] and [HIGH SENS.] in scene mode, the extended optical zoom does not work.



Using the Digital Zoom Further extending the zoom



A maximum of 24× zoom can be achieved with the 6× optical zoom and the 4× digital zoom when [D.ZOOM] is set to [ON] in the [REC] menu. However, if a picture size that can use extended optical zoom is selected, a maximum of 33× (DMC-LZ5)/30× (DMC-LZ4/DMC-LZ3) zoom can be achieved with the 8.3× (DMC-LZ5)/7.5× (DMC-LZ4/DMC-LZ3) extended optical zoom and the 4× digital zoom.

Menu operation

1 Press [MENU/SET].

- When a scene mode is selected, press ◀ in the [SCENE MODE] menu (P49), press ▼ to select the [REC] menu icon [📷] and then press ▶.

2 Press ▲/▼ to select [D.ZOOM] and then press ▶.

3 Press ▼ to select [ON] and then press [MENU/SET].

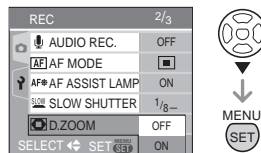

4 Press [MENU/SET] to close the menu.

- You can also press the shutter button halfway to close the menu.

Entering the digital zoom range

The on-screen zoom indication may momentarily stop moving when you rotate the zoom lever to the extreme Tele position. You can enter the digital zoom range by continuously rotating the zoom lever to Tele or releasing the zoom lever once and then rotating it to Tele again.

- [OFF]: W [] T
 - [ON]: W [] T
-
- ① Optical zoom
② Digital zoom
③ Extended optical zoom



- When using the digital zoom, the AF area on the center of the screen is displayed and it is bigger than usual. (P67)
- In digital zoom, the larger the picture the lower the picture quality.

- In the digital zoom range, the stabilizer function may not be effective.
- When using the digital zoom, we recommend using a tripod and the self-timer (P42) for taking pictures.
- The indicated zoom magnification is an approximation.
- The digital zoom does not work in simple mode [♥] or [HIGH SENS.] in scene mode.

Checking the Recorded Picture (Review)



You can check the recorded pictures while still in [REC] mode.

1 Press ▼ [REV].



- The last recorded picture appears for about 10 seconds.
- Review is canceled when the shutter button is pressed halfway or the ▼ [REV] is pressed again.
- You can check other pictures by pressing ◀/▶.
- When the recorded pictures are too bright or too dim, compensate the exposure. (P43)

2 Rotate the zoom lever towards [Q] [T] to enlarge the picture.

- Rotate the zoom lever to [Q] [T] for a 4× magnification and then rotate it even more for a 8× magnification. When you rotate the zoom lever towards [Q] [T] after enlarging the picture, the magnification becomes lower.

3 Press ▲/▼/◀/▶ to move the position.

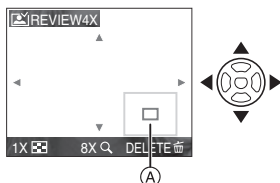

- When you change the magnification or the position to be displayed, the zoom position indication (A) appears for about 1 second so that you can check the enlarged area.

■ Deleting the recorded picture during Review (Quick deletion)

- 1 Press [REVIEW].
- 2 Press ▲ to select [YES].
- 3 Press [MENU/SET].



- Once deleted, pictures cannot be recovered. Double-check pictures before deleting them.
- Multiple pictures or all the pictures can be deleted. For information about how to delete pictures, refer to P34.

Playing Back Pictures



The picture data on the built-in memory appears when a card is not inserted. The picture data on the card appears when a card is inserted. (P17)

Press ◀/▶ to select the picture.

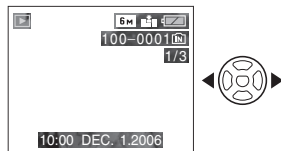

- ◀: Play back the previous picture
- ▶: Play back the next picture

- The first recorded picture will be displayed after the last recorded picture.
- When [ROTATE DISP.] (P71) is set to [ON], pictures recorded by holding the camera vertically are played back vertically.

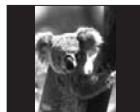

■ Fast forwarding/Fast rewinding

Press and hold ◀/▶ during playback

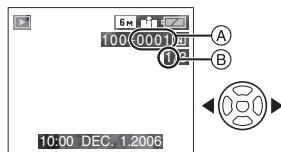

- ◀: Fast rewind
- ▶: Fast forward
- The file number (A) and the picture number (B) only change one by one. Release ◀/▶ when the number of the

desired picture appears to play back the picture.

- If you press and hold ◀/▶, the number of files forwarded/rewound at one time increases. The actual number of files forwarded/rewound at one time depends on the number of files recorded.
- In review playback in recording mode and in multi playback (P57), the pictures can only be forwarded or rewind one by one.



- This camera is based on the DCF standard (Design rule for Camera File system) which was established by the Japan Electronics and Information Technology Industries Association (JEITA).
- The file format that can be played back on the camera is JPEG. (In some cases, even JPEG pictures cannot be played back.)
- The LCD monitor may not be able to display the details of the recorded pictures. You can use the playback zoom (P58) to check the details of the pictures.
- If you play back pictures that have been recorded with other equipment, the picture quality may deteriorate. (The pictures are displayed as [THUMBNAIL IS DISPLAYED] on the screen.)
- If you change a folder name or file name on your PC, the pictures may not play back on the camera.
- If you play back a non-standard file, the folder/file number is indicated by [—] and the screen may turn black.
- Depending on the subject, an interference fringe may appear on the screen. This is called moire. This is not a malfunction.

Deleting Pictures



The picture data on the built-in memory is deleted when a card is not inserted. The picture data on the card is deleted when a card is inserted. (P17)

■ To delete a single picture

1 Select the picture with ◀/▶.

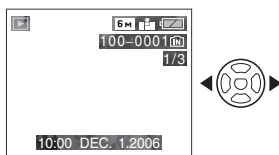

◀: Play back the previous picture

▶: Play back the next picture

2 Press [RECALL].

3 Press ▲ to select [YES] and then press [MENU/SET].

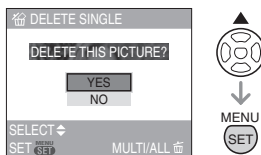

- While the picture is being deleted, [RECALL] appears on the screen.

■ To delete [MULTI DELETE]/ [ALL DELETE]

1 Press [RECALL] twice.

2 Press ▲/▼ to select [MULTI DELETE] or [ALL DELETE] and then press [MENU/SET].



- If you select [MULTI DELETE], perform steps 3 onwards.
- If you select [ALL DELETE], perform steps 5 onwards.
- When [FAVORITE] (P70) is set to [ON], [ALL DELETE EXCEPT ★] appears. If you select [ALL DELETE EXCEPT ★], perform steps 5 onwards. (However, if none of the pictures have [★] displayed, you cannot select [ALL DELETE EXCEPT ★] even if [FAVORITE] is set to [ON].)

3 Press ◀/▶ to select the picture and then press ▼ to set.

(Only when selecting [MULTI DELETE])

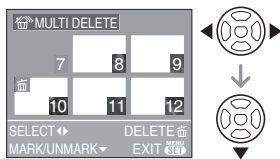

- Repeat the above procedure.
- [] appears on the selected pictures. If ▼ is pressed again, the setting is canceled.
- The icon [] blinks red if the selected picture is protected and cannot be deleted. Cancel the protect setting and then delete the picture. (P74)

4 Press [].

5 Press ▲ to select [YES] and then press [MENU/SET] to set.

(Screen when selecting [MULTI DELETE])

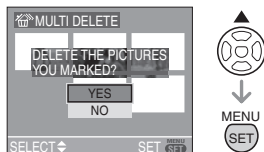

- [DELETE ALL PICTURES?] is displayed when using [ALL DELETE] and [DELETE ALL EXCEPT ★?] is displayed when using [ALL DELETE EXCEPT ★].
- When you delete all pictures, only pictures in either of the built-in memory or the card can be deleted. (You cannot delete pictures in both the built-in memory and the card at the same time.)
- If you press [MENU/SET] while deleting pictures using [ALL DELETE] or [ALL DELETE EXCEPT ★], the deleting will stop halfway.



• **Once deleted, pictures cannot be recovered. Double-check pictures before deleting them.**

- Do not turn off the camera while deleting.
- When deleting pictures, use batteries with sufficient battery power (P13) or use the AC adaptor (DMW-AC6; optional).
- It is possible to delete up to 50 pictures at one time using [MULTI DELETE].
- The greater the number of pictures the longer it takes to delete them.
- If there are pictures that are protected [] (P74), do not conform to the DCF standard (P34) or are in a card with the Write-Protect switch slid to the [LOCK] side (P18), they are not deleted even if [ALL DELETE] or [ALL DELETE EXCEPT ★] is selected.

About the LCD Monitor

Changing the information displayed

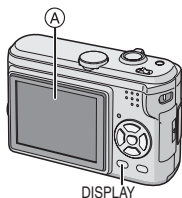

A LCD monitor (LCD)

Press [DISPLAY] to change.

- When the menu screen appears, the [DISPLAY] button is not activated. During multi playback (P57) or playback zoom (P58), you can only select “Normal display” or “No display”.

In simple mode [♥]

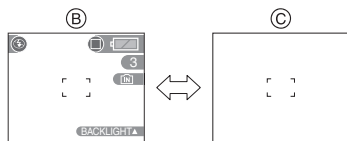

- B Normal display
C No display

In recording mode

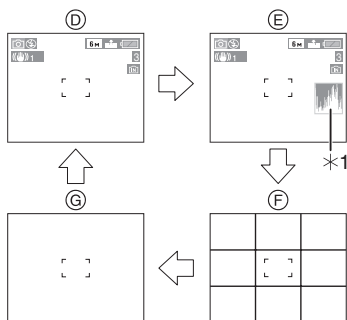

- D Normal display
E Display with histogram
F No display (Recording guide line)
G No display
*1 Histogram

In playback mode

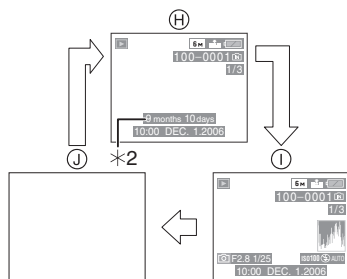

- H Normal display
I Display with recording information and histogram
J No display
*2 Displayed if [BIRTHDAY SET.] and [WITH AGE] were set in [BABY1]/[BABY2] (P54) in scene mode before taking pictures.



- In [NIGHT PORTRAIT] (P51), [NIGHT SCENERY] (P51), [FIREWORKS] (P53) and [STARRY SKY] (P53) in scene mode, the lines are grey.

■ Recording guide line

When you align the subject on the horizontal and vertical guide lines or the cross point of these lines, you can take pictures with well-designed composition by viewing the size, the slope and the balance of the subject.



■ Histogram

- A histogram is a graph that displays brightness along the horizontal axis (black to white) and the number of pixels at each brightness level on the vertical axis.
 - It allows you to easily check a picture's exposure.
 - It is very useful if manual adjustments of the lens aperture and shutter speed are available, especially in those situations where automatic exposure may be difficult due to uneven lighting. Using the histogram feature allows you to get the maximum performance from your camera.
- (A) When the values are concentrated on the left, the picture is under exposed.
- (B) When the values are distributed evenly, the exposure is proper and the brightness is well-balanced.
- (C) When the values are concentrated on the right, the picture is over exposed.

Example of histogram

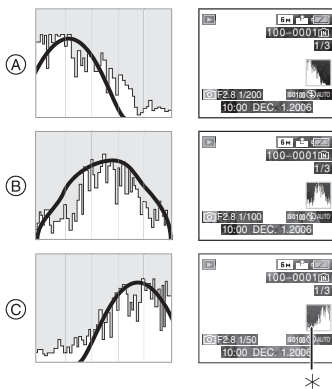

- (A) Under Exposed
 (B) Properly Exposed
 (C) Over Exposed
 *Histogram



• **When you take pictures with the flash or in dark places, the histogram is displayed in orange because the recorded picture and the histogram do not match each other.**

- The histogram is an approximation in recording mode.
- The histogram of a picture may not match in recording mode and playback mode.
- The histogram displayed in this camera does not match histograms displayed by picture editing software used in PCs etc.
- The histogram does not appear in simple mode [♥] or motion picture mode [RECORD] and during multi playback and playback zoom.

Recording a picture with the camera held high above your head (High angle mode)



The LCD monitor becomes easier to see when the camera is held in the following position. This is useful when you cannot get close to the subject because there is a person in the way.

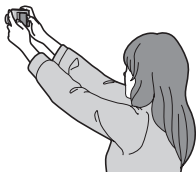

Press [HIGH ANGLE] (A) for 1 second to display the High angle mode icon (B).

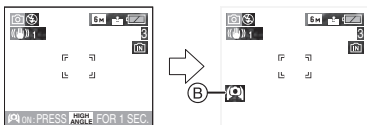
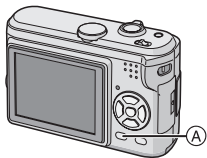

• High angle mode is activated. The LCD monitor becomes brighter and easier to see when the camera is held away from you. (However it becomes more difficult to see when looked at straight on.)

■ Canceling High angle mode

Press and hold [HIGH ANGLE] again for 1 second or turn the camera off.

• High Angle mode is also canceled if power save mode is activated.



- Pictures are displayed on the LCD monitor with increased brightness in High angle mode. Therefore, some subjects may look different on the LCD monitor. However, this does not affect the recorded pictures.
- You may not notice the High angle mode effect if the LCD monitor is difficult to see because of light from the sun etc. shining on it. In this case, we recommend using your hand or another object to block the light when using the camera.
- High angle mode is not activated in the following cases:
 - In simple mode [♥]
 - In playback mode
 - While the menu screen is displayed
 - During Review

Taking Pictures using the Built-in Flash

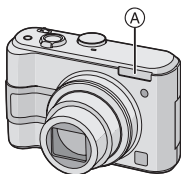

A: Photo flash

Do not cover it with your fingers or other objects.

Switching to the appropriate flash setting

Set the flash to match the recording.

Press **▶** [**⚡**] to switch the flash setting.



- For information about flash settings that can be selected, refer to “Available flash settings by recording mode” (P40).

⚡A: AUTO

The flash is automatically activated when the recording conditions make it necessary.

⚡A: AUTO/Red-eye reduction^{*1}

The flash is automatically activated when the recording conditions make it necessary. It is activated once before the actual recording to reduce the red-eye phenomenon (eyes of the subject appearing red in the picture) and then activated again for the actual recording.

- Use this when you take pictures of people in low lighting conditions.

⚡: Forced ON

The flash is activated every time regardless of the recording conditions.

- Use this when your subject is back-lit or under fluorescent light.

⚡: Forced ON/Red-eye reduction^{*1}

- The flash setting is set to Forced ON/Red-eye reduction only when you set [PARTY] (P52) or [CANDLE LIGHT] (P52) in scene mode.

⚡S: Slow sync./Red-eye reduction^{*1}

If you take a picture with a dark background landscape, this feature will slow the shutter speed when the flash is activated so that the dark background landscape will become bright. Simultaneously it reduces the red-eye phenomenon.

- Use this when you take pictures of people in front of a dark background.

⊗: Forced OFF

The flash is not activated in any recording conditions.

- Use this when you take pictures in places where the use of the flash is not permitted.

- *1 The flash is activated twice. The subject should not move until the second flash is activated.

■ Available flash settings by recording mode

The available flash settings depend on the recording mode.

(○: Available, —: Not available)

	○	○	○	○	—	○
	—	○*2	—*2	—	—	○
	○	○	○	○	—	○
	○	○	○	○	—	○
	○	○	○	—	—	○
	○	○	○	—	—	○
	—	—	—	—	—	○
	○	○	○	—	—	○
	—	—	—	○	—	○
	—	—	—	—	—	○
	○	—	○	—	—	○
	—	—	—	○	○	○
	—	—	—	○	○	○
	—	—	—	—	—	○
	—	—	—	—	—	○
	○	—	○	—	—	○
	○	○	○	—	—	○
	○	○	○	—	—	○
	○	○	○	○	—	○
	—	—	—	—	—	○

*2 It becomes Forced ON [], when the backlight compensation function is activated.

■ The available flash range to take pictures











The available flash range to take pictures depends on the ISO sensitivity selected.

ISO sensitivity	Available flash range
AUTO	Wide
	50 cm (1.64 feet) to 4.2 m (13.8 feet)
	Tele
	50 cm (1.64 feet) to 2.6 m (8.53 feet)
ISO80	Wide
	50 cm (1.64 feet) to 1.9 m (6.23 feet)
	Tele
	50 cm (1.64 feet) to 1.1 m (3.61 feet)
ISO100	Wide
	50 cm (1.64 feet) to 2.1 m (6.89 feet)
	Tele
	50 cm (1.64 feet) to 1.3 m (4.27 feet)
ISO200	Wide
	50 cm (1.64 feet) to 3.0 m (9.84 feet)
	Tele
	50 cm (1.64 feet) to 1.8 m (5.91 feet)
ISO400	Wide
	60 cm (1.97 feet) to 4.2 m (13.8 feet)
	Tele
	60 cm (1.97 feet) to 2.6 m (8.53 feet)

- The available flash range differs in [HIGH SENS.] (P55) in scene mode.
Wide: 80 cm (2.62 feet) to 5.7 m (18.7 feet)
Tele: 80 cm (2.62 feet) to 3.5 m (11.5 feet)

- The available flash range is an approximation.
- Refer to P63 for the ISO sensitivity.
- Refer to P25 for the focus range.
- If ISO sensitivity is set to [AUTO] when using the flash, it will be automatically increased to a maximum of [ISO400].
- To avoid noise, we recommend decreasing the ISO sensitivity (P63) or setting [PICT.ADJ.] to [NATURAL]. (P68)

■ Shutter speed for each flash setting

Flash setting	Shutter speed (Sec.)
 A : AUTO	1/30 to 1/2000
 A  : AUTO/ Red-eye reduction	1/30 to 1/2000
 : Forced ON   : Forced ON/ Red-eye reduction	1/30 to 1/2000
  : Slow sync./ Red-eye reduction	1/8 ^{*3} to 1/2000
  : Forced OFF	1/8 ^{*3} to 1/2000

*3 The shutter speed changes depending on the slow shutter setting. (P67)

- There may be differences in the above shutter speeds in scene mode.
 - [NIGHT SCENERY] (P51): 8 to 1/2000th
 - [FIREWORKS] (P53): 1/4th, 1 second
 - [STARRY SKY] (P53): 15 seconds, 30 seconds, 60 seconds



- Do not look directly at the flash at close range when it is activated.
- If you bring the flash too close to an object, the object may be distorted or discolored by the heat or lighting from the flash.
- Do not cover the photo flash with your fingers or other objects.
- While the flash is charged, the screen turns off and you cannot take pictures.

The status indicator lights. [Except when using the AC adaptor (DMW-AC6; optional).]

If the remaining battery power is low, the screen may be turned off for a longer period of time.

- If you press the shutter button halfway when the flash is activated, the flash icon turns red.
- When the jitter alert appears, we recommend using a tripod.
- When you take a picture beyond the available flash range, the exposure may not be adjusted properly and the picture may become bright or dark.
- When taking a picture with the flash, the white balance is automatically adjusted [except for [] (Daylight)]. However, the white balance may not be properly adjusted if the flash level is insufficient. (P62)
- When the shutter speed is fast, the flash effect may not be sufficient.
- If you repeat taking a picture, it may not actually be taken even if the flash is activated. Take a picture after the access indication disappears.
- The red-eye reduction effect differs between people. Also, if the subject was far away from the camera or was not looking at the first flash, the effect may not be evident.
- When you set burst mode or auto bracket, only 1 picture is recorded for every flash activated.

Taking Pictures with the Self-timer



1 Press ◀ [] to select the self-timer mode.



: Self-timer set to 10 seconds

: Self-timer set to 2 seconds

No display: canceled

2 Press the shutter button halfway to focus and then press it fully to take the picture.



- (A): Press the shutter button halfway to focus.
- (B): Press the shutter button fully to take the picture.
- The self-timer indicator (C) blinks and the shutter is activated after 10 seconds (or 2 seconds).
- If you press [MENU/SET] while the self-timer is set, the self-timer setting is canceled.



- When using a tripod etc., setting the self-timer to 2 seconds is a convenient way to avoid the jitter caused by pressing the shutter button.
- When you press the shutter button once fully, the subject is automatically focused just before recording. In dark places, the self-timer indicator will blink and then may turn on brightly operating as an AF assist lamp (P67) to allow the camera to focus on the subject.
- In simple mode [], the self-timer is fixed to 10 seconds.
- When you set the self-timer in burst mode, the camera starts taking a picture 2 or 10 seconds after the shutter button is pressed. The number of pictures taken at one time is fixed to 3.
- We recommend using a tripod when recording with the self-timer. (When you use a tripod, make sure the tripod is stable when the camera is attached to it.)

Compensating the Exposure



Use this function when you cannot achieve appropriate exposure due to the difference in brightness between the subject and the background. Look at the following examples.

Under exposed



Compensate the exposure towards positive.



Properly exposed



Over exposed



Compensate the exposure towards negative.

- 1 Press **▲** [**+/−**] until [EXPOSURE] appears, compensate the exposure with **◀/▶**.

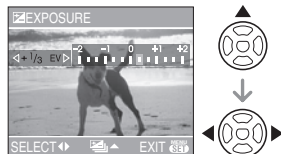

- You can compensate from [−2 EV] to [+2 EV] in steps of [1/3 EV].
- Select [0 EV] to return to the original exposure.

- 2 Press [MENU/SET] to finish.

- You can also press the shutter button halfway to finish.



- EV is an abbreviation of [Exposure Value]. It refers to the amount of light given to the CCD by the aperture value and the shutter speed.
- The exposure compensation value appears on the lower left of the screen.
- The set exposure value is memorized even if the camera is turned off.
- The compensation range of the exposure will be limited depending on the brightness of the subject.
- Exposure cannot be compensated when using [STARRY SKY] in scene mode.

Taking Pictures using Auto Bracket



In this mode, 3 pictures are automatically recorded in the selected exposure compensation range each time the shutter button is pressed. You can select the picture with the desired exposure from the 3 pictures with different exposures.

1 Press \blacktriangle [\pm] several times until [AUTO BRACKET] appears, set the compensation range of the exposure with $\blacktriangleleft/\blacktriangleright$.

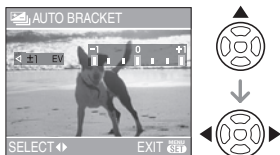

- You can select [OFF] (0), [$\pm 1/3$ EV], [$\pm 2/3$ EV] or [± 1 EV].
- When you do not use auto bracket, select [OFF] (0).

2 Press [MENU/SET] to finish.

- You can also press the shutter button halfway to finish.



- When setting auto bracket, the auto bracket icon [, which is a camera with a bracket symbol] appears on the lower left of the screen.
- When taking pictures using auto bracket after setting the exposure compensation range, the pictures taken are based on the selected exposure compensation range. When the exposure is compensated, the exposure compensation value appears on the lower left of the screen.

- The auto bracket setting is canceled if the camera is turned off.
- When setting auto bracket and burst mode simultaneously, auto bracket will be performed.
- When auto bracket is set, the auto review function is activated regardless of the auto review setting. (The picture is not enlarged.) You cannot set the auto review function in the [SETUP] menu.
- When auto bracket is activated, [AUDIO REC.] cannot be used. (DMC-LZ5)
- The exposure may not be compensated with auto bracket depending on the brightness of the subject.
- When the flash is activated or [STARRY SKY] in scene mode is selected, you can take only 1 picture.
- If the number of recordable pictures is 2 or less, you cannot take pictures by setting auto bracket.

Optical Image Stabilizer







This mode detects jitter and compensates for it.

1 Press and hold the optical image stabilizer button (A) until [STABILIZER] appears.

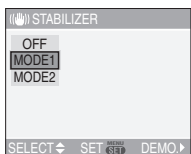

2 Press ▲/▼ to select the stabilizer function mode and then press [MENU/SET].





MODE1 ()	The stabilizer operates continuously and can assist during photo composition.
MODE2 ()	The jitter is compensated for when the shutter button is pressed. There is a greater stabilizing effect.
OFF ()	When you want to take a picture with jitter.

■ Demonstration of the optical image stabilizer (Demonstration Mode)

Press ► to display the demonstration. After the demonstration ends, the screen returns to the stabilizer function mode selection menu. Press ► again if you want to exit the demonstration before it ends. While the demonstration is displayed, the optical

zoom is fixed to Wide (1×) and the zoom function cannot be activated. You also cannot take pictures.



- The stabilizer function may not be effective in the following cases.
 - When there is a lot of jitter.
 - When the zoom magnification is high
 - In digital zoom range.
 - When taking pictures while following a moving subject.
 - When the shutter speed becomes slower to take pictures indoors or in dark places.
- Be careful of camera jitter when you press the shutter button.
- In simple mode [, the setting is fixed to [MODE1] and in [STARRY SKY] (P53) in scene mode it is fixed to [OFF]. The stabilizer function mode selection menu does not appear.
- In motion picture mode [, [MODE2] cannot be set.

Taking Pictures using Burst Mode



1 Press the burst mode button to switch the burst mode setting.



: High speed

: Low speed

: Unlimited*1

No display: canceled

*1 Depends on the memory size, battery power, picture size and quality (compression).

2 Take a picture.

- Hold down the shutter button fully to activate the burst mode.

■ Number of pictures recorded in burst mode

	Burst speed (pictures/second)	Number of recordable pictures (pictures)	
	3*2	DMC-LZ5: max. 6	DMC-LZ5: max. 8
	2*2	DMC-LZ4/ DMC-LZ3: max. 3	DMC-LZ4/ DMC-LZ3: max. 5
	approx. 1.5	Depends on the remaining capacity of the built-in memory/card.	

*2 The burst speed is constant regardless of the transfer speed of the card.

- The number of pictures indicated is when the shutter speed is faster than 1/60 and the flash is not activated.
- In simple mode [], the settings become as follows. [] appears on the left of the screen. (P88)
 - [] ENLARGE]:
 /Max. 6 pictures (DMC-LZ5)/Max. 3 pictures (DMC-LZ4/DMC-LZ3)
 - [] 4"×6"/10×15cm/[] E-MAIL]:
 /Max. 8 pictures (DMC-LZ5)/Max. 5 pictures (DMC-LZ4/DMC-LZ3)



• When the burst mode setting is set to Unlimited

- You can take pictures until the capacity of the built-in memory or the card is full.
- The burst speed will become slower halfway. The burst speed of a MultiMediaCard becomes even slower than that of an SD Memory Card. However, the exact timing of this depends on the number of recordable pictures and the card.
- The focus is fixed when the first picture is taken.
- When the self-timer is used, the number of recordable pictures in burst mode is fixed to 3.
- Burst mode is not canceled when the camera is switched off.
- When auto bracket and burst mode are set simultaneously, auto bracket will be performed.
- The exposure and the white balance vary depending on the burst mode setting. When burst mode is set to [] or [], they are fixed to the values set for the first picture. When the burst speed is set to [], they are adjusted each time you take a picture.
- When burst mode is set, the auto review function is activated regardless of the auto review setting. (The picture is not

enlarged.) You cannot set the auto review function in the [SETUP] menu.

- When burst mode is activated, [AUDIO REC.] cannot be used. (DMC-LZ5)
- When the flash is activated or [STARRY SKY] in scene mode is selected, you can take only 1 picture.

Economizing Power Consumption



The brightness of the screen is reduced and the camera operates in the following way. Other operations operate in the same way as recording mode [📷]. Refer to P20 for the setting method.

Conditions:

- When 15 seconds pass without any operation.
- When 5 seconds pass without any operation after taking a picture. (Only effective when [ECONOMY] in the [SETUP] menu is set to [LEVEL 2].) (P22)

Operation:

- The [MONITOR OFF] message blinks and then the LCD monitor turns off and the status indicator lights.

How to turn the LCD monitor on again:

Press any button.

Power save:

The camera turns off and power save mode is activated when 2 minutes pass without any operation. Press the shutter button halfway or turn the camera off and on to cancel power save mode.



- Economy mode is not activated in the following cases. (Power save mode is activated.)
 - While the menu screen is displayed.
 - While the self-timer is set.
- Power save mode is not activated when using the AC adaptor (DMW-AC6; optional).

Taking Close-up Pictures



This mode allows you to take close-up pictures of a subject, e.g. when taking pictures of flowers. You can take pictures of a subject as close as 5 cm (0.16 feet) from the lens by rotating the zoom lever upmost to Wide (1×).

■ Focus range

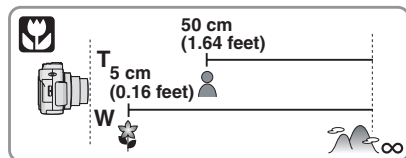

- We recommend using a tripod and the self-timer (P42) in macro mode.
- When a subject is close to the camera, the effective focus range (depth of field) is significantly narrowed. Therefore, if the distance between the camera and the subject is changed after focusing on the subject, it may become difficult to focus on it again.
- If the distance between the camera and the subject is beyond the focus range of the camera, the picture may not be properly focused even if the focus indication lights.
- Macro mode gives priority to a subject close to the camera. Therefore, if the distance between the camera and the subject is more than 50 cm (1.64 feet) it takes longer to focus on it in macro mode than normal picture mode.
- The available flash range is about 50 cm (1.64 feet) to 4.2 m (13.8 feet) (Wide). (When the ISO sensitivity is set to [AUTO].)

- We recommend setting the flash to Forced OFF [] when you take pictures at close range.
- When you take pictures at close range, the resolution of the periphery of the picture may decrease slightly. This is not a malfunction.

Scene Mode



When you select a scene mode to match the subject and recording situation, the camera sets the optimal exposure and hue to obtain the desired picture.

Two frequently used scenes can be set to the mode dials [SCN1] and [SCN2].

- Refer to P50 to 55 for each scene menu.

1 Press ▲/▼ to select the scene mode.

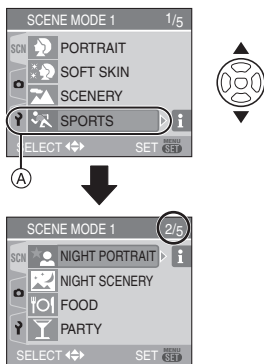

- Press ▼ at (A) to switch to the next menu screen.
- If [SCENE MODE] menu does not appear, press [MENU/SET] to display the [SCENE MODE] menu.
- When you press ►, explanations about each scene mode are displayed. (When you press ◀, the screen returns to the [SCENE MODE] menu.)

2 Press [MENU/SET].

■ About the menu screen items

- There are 5 menu screens (1/5, 2/5, 3/5, 4/5 and 5/5).

- You can switch menu screens from any menu item by rotating the zoom lever.

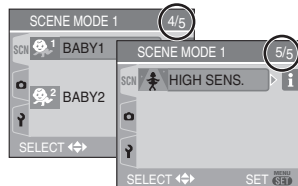
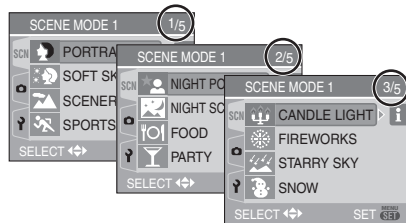

■ Setting frequently used scenes to the mode dials [SCN1] and [SCN2].

- 1 Set [SCENE MENU] in the [SETUP] menu to [OFF]. (P23)

- 2 Press ▲/▼ to select the scene mode and then press [MENU/SET].

- When the mode dial is set to [SCN1] or [SCN2], the selected scene mode is activated and the [SCENE MODE] menu is not displayed. This is convenient as you do not need to select the scene mode in the [SCENE MODE] menu every time you take pictures.



- When you take a picture with a scene mode that is not adequate for the purpose, the hue of the picture may differ from the actual scene.
- When you want to change the brightness of the picture to be recorded, compensate the exposure (P43). (However, the exposure cannot be compensated in [STARRY SKY].)
- Press ◀ and then press ▲/▼ in the [SCENE MODE] menu to select either the [REC] menu icon [📷] (P61) or the

[SETUP] menu icon [P] (P20) and set the desired items.

- The following cannot be set in scene mode because the camera automatically adjusts them to the optimal setting.
 - [W.BALANCE]
 - [SENSITIVITY]
 - [COL.EFFECT]
 - [PICT.ADJ.]

Portrait mode

Press [MENU] [SET] to display the [SCENE MODE] menu and select a scene mode. (P49)
The person stands out from the background and has a healthier complexion.

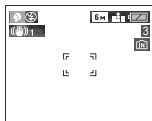

■ Technique for Portrait mode

To increase the effective of this mode:

- 1 Rotate the zoom lever as far as possible to Tele.
- 2 Move close to the subject to make this mode more effective.



- This mode is only suitable when taking pictures outdoors in the daytime.
- ISO sensitivity is fixed to [ISO80].

Soft skin mode

Press [MENU] [SET] to display the [SCENE MODE] menu and select a scene mode. (P49)
The camera detects the face or skin area to achieve a smoother appearance of the skin than portrait mode.

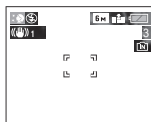

■ Technique for Soft skin mode

To make this mode more effective:

- 1 Rotate the zoom lever as far as possible to Tele.
- 2 Move close to the subject to make this mode more effective.



- This mode is only suitable when taking pictures outdoors in the daytime.
- If a part of the background etc. is a color close to skin color, this part is also smoothed.
- This mode may not be effective when there is insufficient brightness.
- ISO sensitivity is fixed to [ISO80].

Scenery mode

Press [MENU] [SET] to display the [SCENE MODE] menu and select a scene mode. (P49)
The camera focuses preferentially on a distant subject. This allows you to take pictures of a wide landscape.



- The focus range is 5 m (16.4 feet) to ∞.

- The flash setting is fixed to Forced OFF [].
- The setting on the AF assist lamp is disabled.

Sports mode

Press [] to display the [SCENE MODE] menu and select a scene mode. (P49)
This mode allows you to take pictures of a fast moving subject e.g. when taking pictures of outdoor sports.



■ Technique for Sports mode

- This mode is effective when taking pictures during the day in good weather.



- This mode is suitable for taking pictures outdoors in the daytime when you are 5 m (16.4 feet) or more away from the subject.

Night portrait mode

Press [] to display the [SCENE MODE] menu and select a scene mode. (P49)
This mode allows you to take pictures of a subject and a landscape with near real-life brightness by using the flash and slowing down the shutter speed.

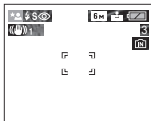



■ Technique for Night portrait mode

- **Use the flash.**
- Since the shutter speed becomes slower, we recommend using a tripod and the self-timer (P42) for taking pictures.

- Keep the subject still for about 1 second after taking the picture.
- We recommend rotating the zoom lever to Wide (1×) and being about 1.5 m (4.92 feet) from the subject when taking a picture.



- The focus range is 1.2 m (3.94 feet) to 5 m (16.4 feet). (Refer to P40 for the available flash range to take pictures.)
- The shutter may remain closed (max. about 1 sec.) after taking the picture because of signal processing. This is not a malfunction.
- Noise may become visible when you take pictures in dark places.
- When using the flash, Slow sync./Red-eye reduction [ ] is selected and the flash is activated every time.

Night scenery mode

Press [] to display the [SCENE MODE] menu and select a scene mode. (P49)
This mode allows you to record the nightscape vividly by reducing the shutter speed.



■ Technique for Night scenery mode

- Since the shutter speed becomes slower (up to about 8 sec.) use a tripod. We also recommend using the self-timer (P42) for taking pictures.



- The focus range is 5 m (16.4 feet) to ∞.
- The shutter may remain closed (max. about 8 sec.) after taking the picture because of signal processing. This is not a malfunction.

- Noise may become visible when you take pictures in dark places.
- The flash setting is fixed to Forced OFF [🔌].
- ISO sensitivity is fixed to [ISO80].
- The setting on the AF assist lamp is disabled.
- You cannot set the slow shutter.

Food mode

Press [MENU/SET] to display the [SCENE MODE] menu and select a scene mode. (P49)
This mode allows you to take pictures of food with a natural hue without being affected by the ambient light in restaurants etc.



- The focus range becomes the same as macro mode. [5 cm (0.16 feet) (Wide)/ 50 cm (1.64 feet) (Tele) to ∞]

Party mode

Press [MENU/SET] to display the [SCENE MODE] menu and select a scene mode. (P49)
Select this mode when you want to take pictures at a wedding reception, indoor party etc. By using the flash and slowing down the shutter speed, both people and the background can be recorded with a brightness close to real life.

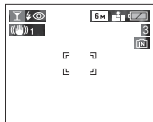

■ Technique for Party mode

- Since the shutter speed becomes slower, we recommend using a tripod and the self-timer (P42) for taking pictures.
- We recommend rotating the zoom lever to Wide (1×) and being about 1.5 m (4.92 feet) from the subject when taking pictures.



- The flash setting can be set to Slow sync./ Red-eye reduction [🔌S👁] or Forced ON/ Red-eye reduction [🔌👁].

Candle light mode

Press [MENU/SET] to display the [SCENE MODE] menu and select a scene mode. (P49)
This mode allows you to take pictures with a candle-lit atmosphere.



■ Technique for Candle light mode

- If you make the most of the candle light, you can take successful pictures without using the flash.
- We recommend using a tripod and the self-timer (P42) for taking pictures.



- The focus range becomes the same as macro mode. [5 cm (0.16 feet) (Wide)/ 50 cm (1.64 feet) (Tele) to ∞]
- The flash setting can be set to Slow sync./ Red-eye reduction [🔌S👁] or Forced ON/ Red-eye reduction [🔌👁].

Fireworks mode

Press [MENU/SET] to display the [SCENE MODE] menu and select a scene mode. (P49)
This mode allows you to take beautiful pictures of fireworks exploding in the night sky.

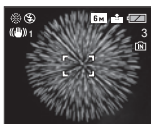

■ Technique for Fireworks mode

- Since the shutter speed becomes slower, we recommend using a tripod.



- This mode is most effective when the subject is 10 m (32.8 feet) or more away.
- The shutter speed becomes the following.
 - When [OFF] is set on the optical image stabilizer function: Fixed to 1 second
 - When [MODE1] or [MODE2] is set on the optical image stabilizer function: 1/4th or 1 second (The shutter speed becomes 1 second only when the camera has determined that there is little jitter such as when using a tripod etc.)
- Histograms are always displayed in orange. (P37)
- The flash setting is fixed to Forced OFF [OFF].
- The setting on the AF assist lamp is disabled.
- You cannot set the slow shutter.

Starry sky mode

Press [MENU/SET] to display the [SCENE MODE] menu and select a scene mode. (P49)
This mode allows you to take vivid pictures of a starry sky or a dark subject that you

could not take in [NIGHT SCENERY] by making the shutter speed slower.



■ Setting the shutter speed

- Select a shutter speed of [15 SEC.], [30 SEC.] or [60 SEC.].
- 1 Press ▲/▼ to select the number of seconds and then press [MENU/SET].

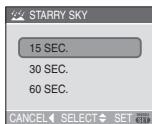

2 Taking Pictures.



- Press the shutter button to display the countdown screen. Do not move the camera after this screen is displayed. When countdown finishes, [PLEASE WAIT...] is displayed for the same length of time as the set shutter speed for signal processing.
- Press [MENU/SET] to stop taking the picture while the countdown screen is displayed.

■ Technique for Starry sky mode

- The shutter opens for 15, 30 or 60 seconds. Be sure to use a tripod. We also recommend taking pictures with the self-timer. (P42)



- Histograms are always displayed in orange. (P37)
- The flash setting is fixed to Forced OFF [OFF].

- The optical image stabilizer function is fixed to [OFF].
- ISO sensitivity is fixed to [ISO80].
- You cannot compensate the exposure or set [AUDIO REC.] (DMC-LZ5), auto bracket, burst mode.

Snow mode

Press  to display the [SCENE MODE] menu and select a scene mode. (P49) This mode allows you to take a picture in locations such as skiing resorts and locations near snowy mountains. The exposure and the white balance are adjusted to make the white color of the snow stand out.



Baby mode 1/ Baby mode 2

Press  to display the [SCENE MODE] menu and select a scene mode. (P49) This mode takes pictures of a baby with a healthy complexion. When the flash is used, the light from it is weaker than usual. You can set the birthdays of two babies by using [BABY1] and [BABY2].

- The baby's age can be displayed when playing back pictures.
- The age can also be printed on each picture by using the software [LUMIX Simple Viewer] in the CD-ROM (supplied). (For information about printing, refer to the separate operating instructions for PC connection.)







■ Age display setting

- If you want the age to be displayed, set the birthday in advance, select [WITH AGE] and press [MENU/SET].

- If you do not want the age to be displayed, select [WITHOUT AGE] and press [MENU/SET].



■ Birthday setting

- 1 Press  /  to select [BIRTHDAY SET.] and then press [MENU/SET].
 - 2 When the message [PLEASE SET THE BIRTHDAY OF THE BABY] appears, select items (Year/Month/Day) using  /  and set them using  / .
 - 3 Press [MENU/SET] to finish the setting.
- If you select [WITH AGE] without setting the birthday in advance, a message is displayed. Press [MENU/SET] and set the birthday in steps 2 and 3.



- The focus range becomes the same as macro mode. [5 cm (0.16 feet) (Wide)/ 50 cm (1.64 feet) (Tele) to ∞]
- After turning on the camera in [BABY1]/ [BABY2] in scene mode or switching to [BABY1]/[BABY2] from other scene modes, the age and current date and time are displayed for about 5 seconds at the bottom of the screen.
- The age display style differs depending on the language setting in the recording mode.
- The display style when printing may differ slightly from the display style on the screen.
- The date of birth is displayed as [0 month 0 day].
- If the age is not properly displayed, check the clock and birthday settings.
- If the camera is set to [WITHOUT AGE], the age is not recorded even if the time and birthday are set. This means the age cannot be displayed even the camera is

set to [WITH AGE] after taking the pictures.

- Use [RESET] in the [SETUP] menu to reset the birthday setting. (P23)

High Sensitivity mode

Press [] to display the [SCENE MODE] menu and select a scene mode. (P49)

The sensitivity is set higher than usual allowing for pictures to be taken with faster shutter speeds. This mode helps minimize the blur of moving subjects in situations with inadequate lighting such as a baby in a dimly lit room.

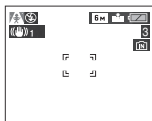

- ISO sensitivity is automatically set to the optimal value between [ISO800] and [ISO1600].
- The focus range becomes the same as macro mode. [5 cm (0.16 feet) (Wide)/ 50 cm (1.64 feet) (Tele) to ∞]
- The resolution of the recorded picture decreases slightly because of high sensitivity processing. This is not a malfunction.
- The extended optical zoom and digital zoom cannot be used.

Motion Picture Mode



- 1 Press the shutter button halfway to focus and then press it fully to start recording.

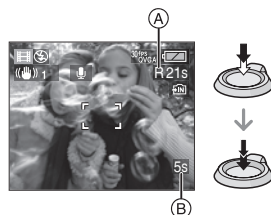

- When the subject is focused, the focus indication lights.
- The focus, zoom and aperture value are fixed to the setting when recording starts (the first frame).
- The available recording time (A) is displayed on the top right and the elapsed recording time (B) is displayed on the bottom right of the screen. For example, 1 hour 20 minutes and 30 seconds is displayed as [1h20m30s].
- The available recording time and the elapsed recording time are approximations.
- Audio recording starts simultaneously from the camera's built-in microphone. (DMC-LZ5)

- 2 Press the shutter button fully to stop recording.

- If the built-in memory or the card becomes full in the middle of recording, the camera stops recording automatically.

■ Changing the picture quality setting

1 Press [MENU/SET].

2 Press ▲/▼ to select [PICT.MODE] and then press ►.

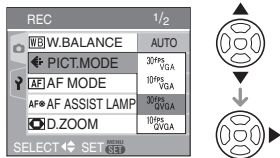

3 Press ▲/▼ to select the item and then press [MENU/SET].

Item	Picture size	fps
30fpsVGA	640×480 pixels	30
10fpsVGA		10
30fpsQVGA	320×240 pixels	30
10fpsQVGA		10

- fps (frames per second); This refers to the number of frames used in 1 second.
- You can record smoother motion pictures with 30 fps.
- You can record longer motion pictures with 10 fps although the picture quality is lower.
- The file size with [10fpsQVGA] is small so it is suitable for e-mails.

* You can only record to the built-in memory if the picture size is set to QVGA (320×240 pixels).

(○: Available, —: Not available)

Item	SD Memory Card	Built-in Memory
30fpsVGA	○	—
10fpsVGA	○	—
30fpsQVGA	○	○
10fpsQVGA	○	○

4 Press [MENU/SET] to close the menu.

- You can also press the shutter button halfway to close the menu.



- The focus range is 5 cm (0.16 feet) to ∞ (Wide), 50 cm (1.64 feet) to ∞ (Tele).
- Refer to P99 for information about the available recording time.
- The available recording time is an approximation. (It varies depending on the recording condition and the types of SD memory Card.)
- The available recording time changes with subjects.
- The available recording time displayed on the screen may not decrease regularly.
- Motion pictures cannot be recorded without audio. (DMC-LZ5)
- **You cannot record audio. (DMC-LZ4/DMC-LZ3)**
- This unit does not support recording motion pictures on MultiMediaCards.
- **When you set the picture quality to [30fpsVGA], we recommend using a high speed SD Memory Card with "10MB/s" or greater displayed on the package.**
- **Depending on the type of SD Memory Card, recording may stop in the middle.**
- **We recommend using Panasonic's SD Memory Card.**
- Depending on the type of SD Memory Card, the card access indication may appear for a while after recording motion pictures. This is not a malfunction.
- When motion pictures recorded with the camera are played back on other equipment, the quality of the picture and sound may deteriorate and it may not be possible to play them back.
- In motion picture mode [M], you cannot use the direction detection function and the review function.

- You cannot set [MODE2] on the optical image stabilizer function.
- The bundled software includes QuickTime to play back motion picture files recorded with the camera on the PC.

Displaying Multiple Screens (Multi Playback)



1 Rotate the zoom lever towards [] [W] to display multiple screens.

(Screen when 9 screens are displayed)

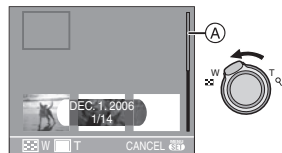

- []: 1 screen → 9 screens → 16 screens → 25 screens
- After the multiple screens are displayed, rotate the zoom lever further towards [] [W] to display 16 screens then 25 screens. Rotate the zoom lever towards [Q] [T] to return to the previous screen.
- When you switch to multiple screens, a scroll bar (A) appears. You can confirm the location of the displayed picture in all the recorded pictures with this scroll bar.

2 Press ▲/▼/◀/▶ to select a picture.

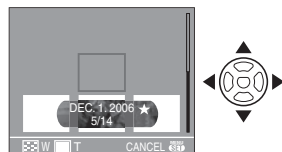

- The recording date and number of the selected picture and the total number of recorded pictures are displayed.

- Depending on the recorded picture and the setting, the following icons will appear.
 - [★] (Favorites)
 - [MOTION] (Motion picture)
 - [BABY1]/[BABY2] in scene mode)

■ Examples of 16 screens and 25 screens

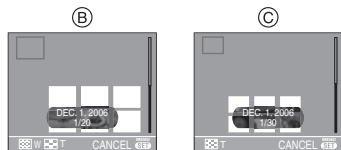

(B): 16 screens

(C): 25 screens

■ To return to normal playback

Rotate towards [Q] [T] or press [MENU/SET].

- The picture appears framed in orange.

■ To delete a picture during multi playback

- Press ▲/▼/◀/▶ to select a picture and then press [ENTER].
- Press ▲ to select [YES].
- Press [MENU/SET].



- Even if the indications on the screen are turned off in normal playback mode (P36), the recording information etc. appears on the screen in multi playback. You can switch between displaying or not displaying the indications on the screen by pressing [DISPLAY]. If you return to the previous screen, the indications on the screen are displayed as in normal playback mode.
- Pictures will not be displayed in the rotated direction even if [ROTATE DISP.] is set to [ON]. (P71)

Using the Playback Zoom



1 Rotate the zoom lever towards [Q] [T] to enlarge the picture.

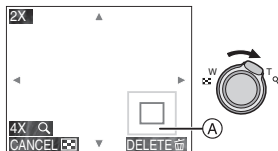

- Q : 1X → 2X → 4X → 8X → 16X
- When you rotate the zoom lever towards [W] after enlarging the picture, the magnification becomes lower. When you rotate the zoom lever towards [T], the magnification becomes higher.
- When you change the magnification, the zoom position indication (A) appears for about 1 second so that you can check the position of the enlarged section.

2 Press ▲/▼/◀/▶ to move the position.

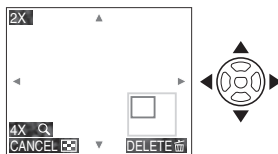

- When you move the position to be displayed, the zoom position indication appears for about 1 second.

■ To stop using the playback zoom

Rotate towards [W] or press [MENU/SET].

■ To delete a picture during the playback zoom

- 1 Press [].
- 2 Press **▲** to select [YES].
- 3 Press [MENU/SET].







• Even if the indications on the screen are turned off in normal playback mode (P36), the magnification and operation appear on the screen when the playback zoom is activated. You can switch between displaying or not displaying the indications on the screen by pressing [DISPLAY]. When you set the magnification to 1×, the indications on the screen are displayed as in normal playback mode.

- The more a picture is enlarged, the more its quality deteriorates.
- If you want to save the enlarged picture, use the trimming function. (P76)
- The playback zoom may not operate if pictures have been recorded with other equipment.

Playing Back Motion Pictures/Pictures with Audio



■ Motion pictures

Press **◀/▶** to select a picture with a motion picture icon [] / [] / [] / [] and then press **▼** to play back.

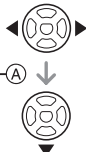

- The motion picture recording time (A) is displayed on the screen. After playback starts, the motion picture recording time disappears and the elapsed playback time is displayed on the bottom right of the screen.

For example, 1 hour 20 minutes and 30 seconds is displayed as [1h20m30s].

- The cursor displayed during playback is the same as **▲/▼/◀/▶**. 
- Press **▼** again to stop motion picture playback and return to the normal playback screen.

Fast forwarding/Fast rewinding

Press and hold **◀/▶** during motion picture playback.

◀: Fast rewind

▶: Fast forward

- The camera returns to normal motion picture playback when **◀/▶** is released.

To pause

Press **▲** during motion picture playback.

- Press **▲** again to cancel pause.

■ Pictures with audio (DMC-LZ5)

Press ◀/▶ to select a picture with the audio icon [] and then press ▼ to play back.

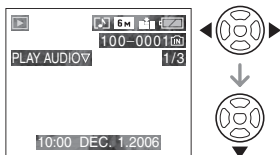

- Refer to [AUDIO REC.] (P66) and [AUDIO DUB.] (P75) for information about how to create still pictures with audio.



• You can record audio on DMC-LZ5.

However, you cannot play audio only with the camera. When you want to play audio, connect the camera to PC (P80) or TV (P86).

• You cannot record audio on DMC-LZ4/DMC-LZ3.

- The file format that can be played back with this camera is QuickTime Motion JPEG.
- Please note that the bundled software includes QuickTime to play back motion picture files created with the camera on the PC.
- Some QuickTime Motion JPEG files recorded by a PC or other equipment may not play back on the camera.
- If you play back motion pictures that have been recorded with other equipment, the picture quality may deteriorate or the pictures may not play back.
- When using a high capacity card, it is possible that fast rewinding may be slower than usual.
- You cannot use the following functions with pictures with audio (DMC-LZ5) and motion pictures.
 - Playback zoom
[While playing audio (DMC-LZ5) and playing back or pausing motion pictures]

- [AUDIO DUB.] (DMC-LZ5)/ [ROTATE DISP.]/[ROTATE] (Motion pictures only)
- [RESIZE]/[TRIMMING]

Using the [REC] Mode Menu



Increase the variety of pictures you can take by setting color effect, picture adjustment etc.

- Set the mode dial to the desired recording mode.
- Menu items differ depending on the mode selected with the mode dial (P5). This page describes how to set [AUDIO REC.] (DMC-LZ5) in normal picture mode [📷]. (Refer to P62 to 68 for each menu item.)
- Select [RESET] in the [SETUP] menu to return the menu settings to the initial settings at the time of purchase. (P23)

1 Press [MENU/SET].

2 Press ▲/▼ to select the menu item.

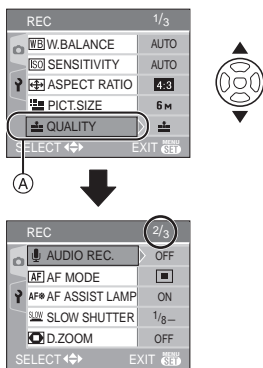

- Press ▼ at (A) to switch to the next menu screen.

3 Press ►, press ▲/▼ to select the setting and then press [MENU/SET].

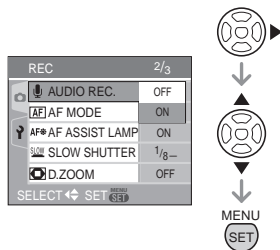

4 Press [MENU/SET] to close the menu.

- You can also press the shutter button halfway to close the menu.

■ About the menu screen items

- There are 3 menu screens (1/3, 2/3 and 3/3).
- You can switch menu screens from any menu item by rotating the zoom lever.

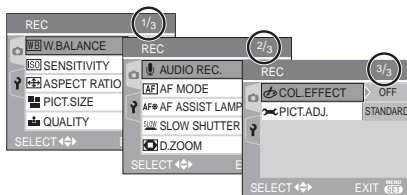

[W.BALANCE]

Adjusting the hue for a more natural picture



Press [MENU/SET] to display the [REC] mode menu and select the item to set. (P61)
This function allows you to reproduce a white color close to real life in pictures recorded under sunlight, halogen lighting etc. in which the white color may appear reddish or bluish. Select a setting that matches the recording conditions.

AUTO	for auto setting (auto white balance)
(Daylight)	for recording outdoors on a bright day
(Cloudy)	for recording outdoors on a cloudy day
(Halogen)	for recording under halogen lighting
(White set)	for using the preset white balance
(White set)	for setting the white balance again

- If you select a setting other than [AUTO], you can finely adjust the white balance.

■ Auto white balance

The available white balance range is shown in the following illustration. When you take a picture beyond the available white balance range, the picture may appear reddish or bluish. Also, auto white balance may not operate properly if the subject is surrounded by many light sources. In these cases, set the white balance to a mode other than [AUTO].

- 1 Auto white balance will work in the following range.
- 2 Blue sky
- 3 Cloudy sky (Rain)
- 4 TV screen

62

VQT0U87

- 5 Sunlight
- 6 White fluorescent light
- 7 Incandescent light bulb
- 8 Sunrise and sunset
- 9 Candlelight

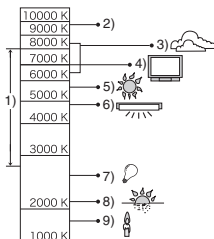

K=Kelvin Color Temperature

■ Setting the white balance manually (White set)

Use this to set the white balance manually.

- 1 Select [MENU/SET] (White set) and then press [MENU/SET].
- 2 Aim the camera at a sheet of white paper etc. so that the frame in the center is filled by the white object only and then press [MENU/SET].



- 3 Press [MENU/SET] twice to close the menu.

- You can also press the shutter button halfway to finish.

■ Finely adjusting the white balance (white balance fine adjustment)

You can adjust the white balance finely when you cannot acquire the desired hue by setting the white balance.

- Set the white balance to [] [] [] [].

1 Press **▲** [] several times until **[WB ADJUST.]** appears and then press **◀/▶** to adjust the white balance.



- **◀ [RED]:** Press when the hue is bluish.
- **▶ [BLUE]:** Press when the hue is reddish.
- Select **[0]** to return to the original white balance.

2 Press **[MENU/SET]** to finish.

- You can also press the shutter button halfway to finish.



About the white balance

- When you take a picture with the flash, the white balance is automatically adjusted [except for [] (Daylight)]. However, the white balance may not be properly adjusted if the flash level is insufficient.
- The white balance cannot be set in simple mode [] and scene mode.

About the white balance fine adjustment

- You can finely adjust the white balance independently for each white balance item.
- The white balance icon on the screen turns red or blue.
- The white balance fine adjustment setting is reflected in the picture when using the flash.
- The white balance fine adjustment setting is memorized even if the camera is turned off.

- The white balance fine adjustment level in [] (White set) returns to "0" when you reset the white balance using White set [SET].
- You cannot finely adjust the white balance when **[COL.EFFECT]** (P68) is set to **[COOL]**, **[WARM]**, **[B/W]** or **[SEPIA]**.



[SENSITIVITY]

Setting the light sensitivity



- Press [] to display the **[REC]** mode menu and select the item to set. (P61)
- ISO is a measure of sensitivity to light. The higher the sensitivity is set, the less light is needed to take a picture so the camera becomes more suitable for recording in dark places.
- When **[AUTO]** is selected, the ISO sensitivity automatically increases to a maximum of **[ISO200]** (or **[ISO400]** when the flash is activated) depending on the brightness.

ISO sensitivity	80	←	→	400
Use in bright places (e.g. outdoors)	Suitable			Not suitable
Use in dark places	Not suitable			Suitable
Shutter speed	Slow			Fast
Noise	Less			Increased



- ISO sensitivity is automatically set to the optimal value between **[ISO800]** and **[ISO1600]** in **[HIGH SENS.]** (P55) in scene mode.
- To avoid picture noise, we recommend decreasing the ISO sensitivity or setting **[PICT.ADJ.]** to **[NATURAL]**. (P68)

- ISO sensitivity cannot be set in scene mode, motion picture mode [] and simple mode [].





[ASPECT RATIO]

Setting the aspect ratio of pictures



Press [MENU] to display the [REC] mode menu and select the item to set. (P61)
By changing the aspect ratio, you can select an angle of view that matches the subject.

<p>4:3</p>	<p>Select to take pictures with the same aspect ratio as a 4:3 TV or a computer monitor.</p> 
<p>3:2</p>	<p>Select to take pictures with the same 3:2 aspect ratio as 35 mm film.</p> 
<p>16:9</p>	<p>This is suitable for landscapes etc. where a wide view is preferable. This is also suitable for playing back pictures on a wide-screen TV, high-definition TV etc.</p> 



- The ends of the recorded pictures may be cut at printing. (P95)

[PICT.SIZE]/[QUALITY]



Setting a picture size and quality that matches your use of the pictures



Press [MENU] to display the [REC] mode menu and select the item to set. (P61)
A digital picture is made of numerous dots called pixels. Although you cannot see the difference on the camera's screen, the more the pixels the finer the picture will be when it is printed on a large piece of paper or displayed on a computer monitor. Picture quality refers to the compression rate when saving digital pictures.









- (A) Many pixels (Fine)
- (B) Few pixels (Rough)

■ Number of pixels



You can print pictures more clearly when a large picture size [] (6M) (DMC-LZ5)/ [] (5M) (DMC-LZ4/DMC-LZ3) is selected.

When a smaller picture size [] (0.3M) is selected, you can record more pictures and attach them to an e-mail or post them on a website because their file size is small.



■ When the aspect ratio is [4:3].

 (6M) (DMC-LZ5)	2816×2112 pixels
 (5M) (DMC-LZ4/ DMC-LZ3)	2560×1920 pixels
 (3M EZ)	2048×1536 pixels
 (2M EZ)	1600×1200 pixels
 (1M EZ)	1280×960 pixels
 (0.3M EZ)	640×480 pixels

■ When the aspect ratio is [3:2].



 (5M) (DMC-LZ5)	2816×1880 pixels
 (4.5M) (DMC-LZ4/ DMC-LZ3)	2560×1712 pixels
 (2.5M EZ)	2048×1360 pixels

■ When the aspect ratio is [16:9].

 (4.5M) (DMC-LZ5)	2816×1584 pixels
 (3.5M) (DMC-LZ4/ DMC-LZ3)	2560×1440 pixels
 (2M EZ)	1920×1080 pixels

■ Quality



You can increase the number of recordable pictures without changing the picture size if quality is set to [STANDARD].

	Fine (Low compression): This gives priority to picture quality. Picture quality will be high.
	Standard (High compression): This gives priority to the number of recordable pictures. Standard quality pictures are recorded.



- The number of pixels that can be selected differs depending on the aspect ratio. If

you change the aspect ratio, set the picture size.

- “EZ” is an abbreviation of [Extended optical Zoom]. This is a function which further extends the optical zoom ratio. If you select a picture size with EZ displayed, the zoom ratio is extended to a maximum of 8.3× (DMC-LZ5)/7.5× (DMC-LZ4/DMC-LZ3) when the digital zoom is set to [OFF]. (P29)
- The extended optical zoom does not work in [HIGH SENS.] in scene mode so the picture size for [EZ] is not displayed.
- In motion picture mode [], the picture size is fixed to VGA (640×480 pixels) (Only when using an SD Memory Card) or QVGA (320×240 pixels).
- Pictures may appear mosaic depending on the subject and the recording conditions.
- Refer to P97 for information about the number of recordable pictures.
- The number of recordable pictures depends on the subject.
- The number of recordable pictures displayed on the screen may not correspond with recorded frames.
- In simple mode [], the settings become as follows.

–  ENLARGE:

 (6M []) (DMC-LZ5)/

 (5M []) (DMC-LZ4/DMC-LZ3)/

Fine

–  4"×6"/10×15cm:

 (2.5M EZ [])/Standard

–  E-MAIL:

 (0.3M EZ [])/Standard

[AUDIO REC.] (DMC-LZ5)

Recording still pictures with audio



Press [MENU/SET] to display the [REC] mode menu and select the item to set. (P61)
You can record audio with the still picture if this is set to [ON]. This means you can record the conversation that took place when you were recording or an explanation of the picture.

- [U] appears on the screen when you set [AUDIO REC.] to [ON].
- Focus on the subject and press the shutter button to start recording. Recording will automatically stop about 5 seconds later. There is no need to press and hold the shutter button.
- Audio is recorded from the built-in microphone on the camera.
- If you press [MENU/SET] during audio recording, the audio recording is canceled. The audio is not recorded.
- The total number of pictures that can be stored on each card will decrease slightly when audio is recorded with each picture.



- You cannot take pictures with audio in auto bracket, burst mode or [STARRY SKY] in scene mode.

[AF MODE]

Setting the focus method



Press [MENU/SET] to display the [REC] mode menu and select the item to set. (P61)
Select the mode that matches the recording conditions and the composition.

[5-area-focusing]:

The camera focuses on any of 5 focus areas. This is effective when the subject is not in the center of the screen.



[3-area-focusing (High speed)]:

The camera quickly focuses on any of 3 focus areas points – left, right or center. This is effective when the subject is not in the center of the screen.



[1-area-focusing (High speed)]:

The camera quickly focuses on the subject in the AF area on the center of the screen.



[1-area-focusing]:

The camera focuses on the subject in the AF area on the center of the screen.



[Spot-focusing]:

The camera focuses on a limited narrow area in the screen.



■ About 3-area-focusing (High speed) and 1-area-focusing (High speed)

- You can focus on the subject more quickly than other AF modes.
- The picture may stop moving for a moment before being brought into focus when you press the shutter button halfway. This is not a malfunction.



- The AF area displayed on the center of the screen is bigger than usual when using the digital zoom or when taking pictures in dark places.



- The camera is focusing on all the AF areas when multiple AF areas (max. 5 areas) light at the same time. The focus position is not predetermined. It is set to a position automatically determined by the camera at the time of focusing. If you want to determine the focus position to take pictures, switch the AF mode to 1-area-focusing mode (High speed), 1-area-focusing mode or Spot-focusing mode.
- Switch the AF mode to 1-area-focusing mode (High speed) or 1-area-focusing mode if it is difficult to focus using Spot-focusing mode.
- The AF mode cannot be set in simple mode [♥].

[AF ASSIST LAMP]

AF* *Focusing in low light conditions becomes easier*



Press [MENU] to display the [REC] mode menu and select the item to set. (P61)
Illuminating the subject makes it easier for the camera to focus when recording in low light conditions that make focusing difficult.

- If the AF assist lamp is set to [ON], an AF area with a size wider than usual is displayed and the AF assist lamp (A) turns



on when you press the shutter button halfway in dark places etc.

ON	The AF assist lamp turns on in low light conditions. At this time, the AF assist lamp icon [AF*] appears on the screen.
OFF	The AF assist lamp does not turn on.



- Be careful about the following when using the AF assist lamp.
 - Do not look at the AF assist lamp from close up.
 - Do not cover the AF assist lamp with your fingers or other objects.
- When the AF assist lamp is turned on, the AF area on the center of the screen is displayed and it is bigger than usual. (P67)
- When you do not want to use the AF assist lamp (e.g. when taking pictures of animals in dark places), set the [AF ASSIST LAMP] to [OFF]. In this case, it will become more difficult to focus on the subject.
- The setting for [AF ASSIST LAMP] is fixed to [ON] in simple mode [♥].
- The setting for the [AF ASSIST LAMP] is fixed to [OFF] in [SCENERY] (P50), [NIGHT SCENERY] (P51) and [FIREWORKS] (P53) in scene mode.

[SLOW SHUTTER]

SLOW *Recording bright pictures in dark places*



Press [MENU] to display the [REC] mode menu and select the item to set. (P61)
The shutter speed is automatically adjusted. However, if you want brighter pictures you can manually select an even slower shutter speed.

- The slow shutter speeds you can select are: [1/8-], [1/4-], [1/2-] and [1-].
- This is effective if you want to take bright pictures of both a night landscape and a subject using [NIGHT PORTRAIT] (P51) in scene mode.

Slow shutter setting	1/8- ←————→ 1-
Brightness	Darker Brighter
Jitter	Less More

■ Example

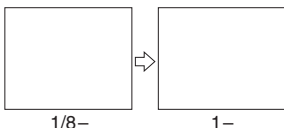

- This should usually be set to [1/8-] to take pictures. (When you select a slow shutter speed other than [1/8-], [SLOW] appears on the lower left of the screen.)
- When the shutter speed is made slower using [SLOW SHUTTER], jitter is likely to occur. We recommend using a tripod and the self-timer (P42) for taking pictures.
- You cannot set the slow shutter in [NIGHT SCENERY], [FIREWORKS] and [STARRY SKY] in scene mode.

[COL.EFFECT]



Setting color effects for the recorded pictures



Press [MENU] to display the [REC] mode menu and select the item to set. (P61)
Select a color effect that matches the recording conditions and your image of the recording.

COOL	The picture becomes bluish.
WARM	The picture becomes reddish.
B/W	The picture becomes black and white.
SEPIA	The picture becomes sepia.

[PICT.ADJ.]



Adjusting the picture quality for the recorded pictures



Press [MENU] to display the [REC] mode menu and select the item to set. (P61)
Select an effect that matches the recording situation and your image of the recording.

NATURAL	The picture becomes softer.
VIVID	The picture becomes sharper.



- When you take pictures in dark places, noise may become visible. To avoid noise, we recommend setting [PICT.ADJ.] to [NATURAL].

Using the [PLAY] mode menu



You can use various functions in playback mode to rotate pictures, set protection for them etc.

- Refer to P69 to 78 for each menu item.

1 Press [MENU/SET].

2 Press ▲/▼ to select the menu item.

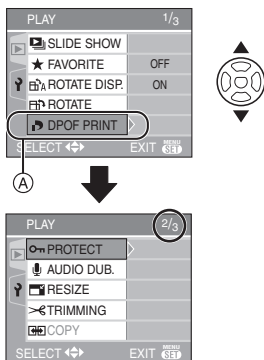

- Press ▼ at (A) to switch to the next menu screen.

3 Press ►.

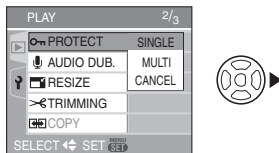

- After selecting a menu item in step 3, refer to the description of the menu item in the operating instructions and then set it.

■ About the menu screen items

- There are 3 menu screens (1/3, 2/3 and 3/3).
- You can switch menu screens from any menu item by rotating the zoom lever.

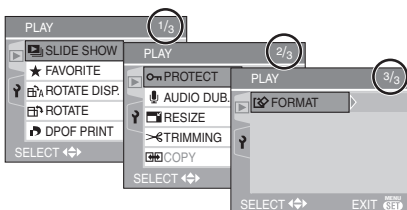

[SLIDE SHOW]

Playing back pictures in order for a fixed duration

Press [MENU/SET] to display the [PLAY] mode menu and select the item to set. (P69)
This is recommended when playing back pictures on a TV screen. You can skip unwanted pictures if [FAVORITE] (P70) has been set.

1 Press ▲/▼ to select [ALL] or [★] and then press [MENU/SET].

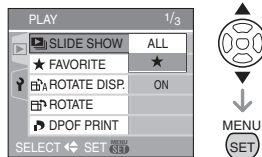

[ALL]	Displays all pictures.
[★]	Displays only those pictures that have been set as favorites (P70).

- The screen shown in step 1 appears when [FAVORITE] is set to [ON]. When [FAVORITE] is set to [OFF], perform step 2 onwards.

- If none of the pictures have [★] displayed, you cannot select [★] even if [FAVORITE] is set to [ON].

2 Press ▲ to select [START] and then press [MENU/SET].

(Screen when [ALL] is selected)

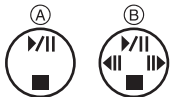
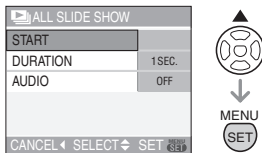

- The cursor displayed during a slide show (A) or while a slide show is paused (B) is the same as ▲/▼/◀/▶.
- Press ▲ to pause the slide show. Press ▲ again to cancel pause.
- Press ◀/▶ while paused to display the previous or next picture.

3 Press ▼ to finish.

■ Setting the audio (DMC-LZ5) and duration

Select [DURATION] or [AUDIO] on the screen shown in step 2 and set.

[DURATION]	Can be set to [1SEC.], [2SEC.], [3SEC.], [5SEC.] or [MANUAL] (manual playback).
[AUDIO]*	If set to [ON], the audio of the pictures with audio is played back.

- You can only select [MANUAL] when [★] has been selected in step 1.
- Press ◀/▶ to display the previous or next picture when [MANUAL] is selected.
- * When the camera is connected to TV (P86), the audio can be played back.



- If you set [AUDIO] to [ON] and then play back a picture with audio, the next picture will be displayed after the audio has finished. (DMC-LZ5)
- You cannot play back motion pictures and use power save in a slide show. (However, the setting for power save mode is fixed to [10MIN.] while pausing a slide show or playing back a manual slide show.)

[FAVORITE]

Setting your favorite pictures

- Press [MENU/SET] to display the [PLAY] mode menu and select the item to set. (P69)
- You can do the following if a mark has been added to pictures and they have been set as favorites.
- Delete all the pictures not set as favorites. ([ALL DELETE EXCEPT ★]) (P34)
 - Play back the pictures set as favorites only as a slide show. (P69)

1 Press ▼ to select [ON] and then press [MENU/SET].

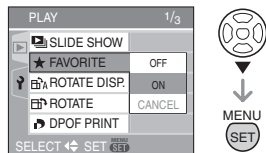

- You cannot set pictures as favorites if [FAVORITE] is set to [OFF]. Also the favorites icon [★] will not appear when [FAVORITE] is set to [OFF] even if it was previously set to [ON].
- You cannot select [CANCEL] if none of the pictures have [★] displayed.

2 Press [MENU/SET] to close the menu.

3 Press ◀/▶ to select the picture then press ▲.

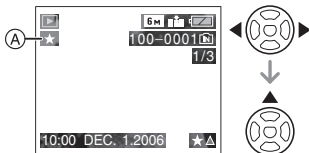

- Repeat the above procedure.
- If ▲ is pressed while the [★] favorites icon (A) is displayed, [★] is cleared, and the favorites setting is canceled.
- You can set up to 999 pictures as favorites.

■ Deleting all favorites

- 1 Select [CANCEL] on the screen shown in step 1 and then press [MENU/SET].
- 2 Press ▲ to select [YES] and then press [MENU/SET].
- 3 Press [MENU/SET] to close the menu.



- When printing pictures at a photo printing store, [ALL DELETE EXCEPT ★] (P34) is useful so only the pictures you want to be printed remain on the card.
- Use [LUMIX Simple Viewer] on the CD-ROM (supplied), to set, confirm or delete favorites. (For information about this, refer to the separate operating instructions for PC connection.)
- You may not be able to set pictures taken with other equipment as favorites.

[ROTATE DISP.]/[ROTATE] To display the picture rotated

Press [] to display the [PLAY] mode menu and select the item to set. (P69) This mode allows you to automatically display pictures vertically if they were recorded holding the camera vertically or rotate pictures manually in 90° steps.

■ Rotate display (The picture is automatically rotated and displayed.)

1 Press ▼ to select [ON] and then press [MENU/SET].

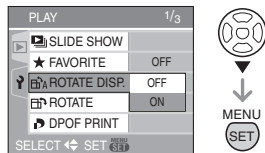

- The pictures are displayed without being rotated when you select [OFF].
- Refer to P33 for information about how to play back pictures.

2 Press [MENU/SET] to close the menu.

■ Rotate (The picture is rotated manually.)

1 Press ◀/▶ to select the picture and then press ▼.



- The [ROTATE] function is disabled when [ROTATE DISP.] is set to [OFF].
- Motion pictures and protected pictures cannot be rotated.

2 Press ▲/▼ to select the direction to rotate the picture and then press [MENU/SET].



	The picture rotates clockwise in steps of 90°.
	The picture rotates counter-clockwise in steps of 90°.

3 Press [MENU/SET] twice to close the menu.

■ Example When rotating clockwise (↻)

Original picture

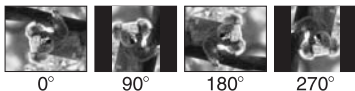

- When [ROTATE DISP.] is set to [ON], pictures recorded holding the camera vertically are played back vertically (rotated).
- If you take pictures when aiming the camera up or down, it may not be possible to display the pictures vertically. (P25)
- The picture may be slightly blurred when the camera is connected to the TV with the AV cable (DMC-LZ5)/video cable (DMC-LZ4/DMC-LZ3) (supplied) and played back vertically.
- When you play back pictures on a PC, they cannot be displayed in the rotated direction unless the OS or software is compatible with Exif. Exif is a file format for still pictures which allows recording

information etc. to be added. It was established by JEITA [Japan Electronics and Information Technology Industries Association].

- Rotated pictures are displayed without being rotated when they are played back in multi playback.
- It may not be possible to rotate pictures that have been recorded with other equipment.

[DPOF PRINT]

Setting the picture to print and the number of prints

Press [] to display the [PLAY] mode menu and select the item to set. (P69) DPOF (Digital Print Order Format) is a system that allows the user to select which pictures to print, how many copies of each picture to print and whether or not to print the recording date on the pictures when using a DPOF compatible photo printer or photo printing store. For details, ask at your photo printing store.

When you want to use a photo printing store to print pictures recorded on the built-in memory, copy them to a card (P77) and then set the DPOF setting.

For more information visit:
http://panasonic.jp/dc/dpof_110/white_e.htm

Press ▲/▼ to select [SINGLE], [MULTI] or [CANCEL] and then press [MENU/SET].

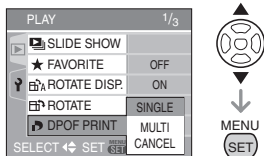

- You cannot select [CANCEL] if there are no prints that have been set in the DPOF print settings.

■ Single setting

- 1 Press **◀/▶** to select the picture to print and then press **▲/▼** to set the number of prints.

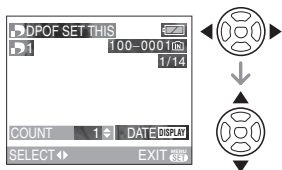

- The number of prints icon [] appears.
- The number of prints can be set from 0 to 999. The DPOF print setting is canceled when the number of prints is set to "0".

- 2 Press **[MENU/SET]** twice to close the menu.

■ Multi setting

- 1 Press **◀/▶** to select the picture to print then press **▲/▼** to set the number of prints.

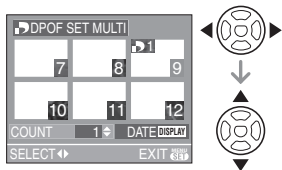

- The number of prints icon [] appears.
- Repeat the above procedure. (You cannot set all the pictures at one time.)
- The number of prints can be set from 0 to 999. The DPOF print setting is canceled when the number of prints is set to "0".

- 2 Press **[MENU/SET]** twice to close the menu.

■ To cancel all settings

- 1 Press **▲** to select **[YES]** and then press **[MENU/SET]**.

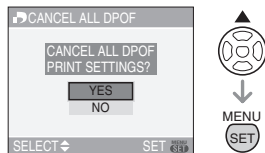

- 2 Press **[MENU/SET]** to close the menu.

- DPOF print settings on the built-in memory are canceled when a card is not inserted. DPOF print settings on the card are canceled when a card is inserted.

■ To print the date

After setting the number of prints, set/cancel printing with the recording date by pressing **[DISPLAY]**.

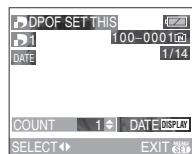

- The date print icon [**DATE**] appears.
- When you go to a photo printing store for digital printing, be sure to order the printing of the date additionally if required.
- Depending on the photo printing store or the printer, the date may not be printed even if you set to print the date. For further information, ask at your photo printing store or refer to the operating instructions for the printer.



- DPOF is an abbreviation of [Digital Print Order Format]. This feature allows you to write print information to media and then use the information on a DPOF-compliant system.
- DPOF print setting is a convenient function when printing pictures with a printer that supports PictBridge (P82). The date printing setting on the printer may take priority over the date printing setting on the camera. Check the date printing setting on the printer also. (P82)
- It is necessary to delete all previous DPOF print information made on other equipment when setting DPOF print on the camera.
- If the file is not based on the DCF standard, the DPOF print setting cannot be set. DCF is an abbreviation of [Design rule for Camera File system], stipulated by JEITA [Japan Electronics and Information Technology Industries Association].

[PROTECT]**Preventing accidental erasure of pictures**

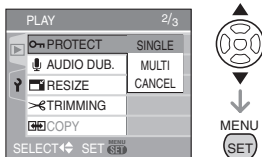

Press [MENU/SET] to display the [PLAY] mode menu and select the item to set. (P69)
You can set protection for pictures you do not want to be deleted by mistake.

Press ▲/▼ to select [SINGLE], [MULTI] or [CANCEL] and then press [MENU/SET].

**■ Single setting**

1 Press ◀/▶ to select the picture and then press ▼ to set/cancel.



SET	The protect icon [] appears.
CANCEL	The protect icon [] disappears.

2 Press [MENU/SET] twice to close the menu.

■ Multi setting/To cancel all settings

Perform the same operation as in "[DPOF PRINT] Setting the picture to print and the number of prints". (P72 to 74)



- If you press [MENU/SET] while canceling protection, the canceling will stop halfway.
- The protect setting may not be effective on other equipment.
- If you want to delete protected pictures, cancel their protection.
- Even if you protect pictures in the built-in memory or a card, they will be deleted if the built-in memory or the card is formatted. (P78)
- Even if you do not protect pictures on an SD Memory Card, they cannot be deleted when the card's write protect switch (A) is set to [LOCK].



- The following functions cannot be used with protected pictures.
 - [ROTATE]
 - [AUDIO DUB.] (DMC-LZ5)

[AUDIO DUB.] (DMC-LZ5) Adding audio after taking pictures

Press [**MENU/SET**] to display the [PLAY] mode menu and select the item to set. (P69)
You can add the audio after taking a picture.

1 Press **◀/▶** to select the picture and then press **▼** to start audio recording.

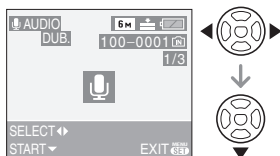

- The message [OVERWRITE AUDIO DATA?] screen appears when audio has already been recorded. Press **▲** to select [YES] and then press [**MENU/SET**] to start audio recording. (The original audio is overwritten.)
- Audio dubbing cannot be used with the following pictures.
 - Motion pictures
 - Protected pictures
- Audio dubbing may not work properly on pictures recorded by other equipment.

2 Press **▼** to stop recording.

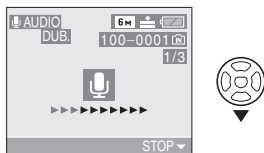

- The audio recording stops automatically if **▼** is not pressed after about 10 seconds.

3 Press [**MENU/SET**] twice to close the menu.

[RESIZE] Making the picture smaller

Press [**MENU/SET**] to display the [PLAY] mode menu and select the item to set. (P69)
This function is useful if you want to reduce the file size of a picture to attach it to an e-mail or upload it to a website.

1 Press **◀/▶** to select the picture and then press **▼**.

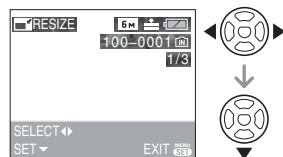

- The following pictures cannot be resized.
 - When the aspect ratio setting is [**4:3**].
 - Pictures recorded in [**0.3M**] (0.3M EZ)
 - When the aspect ratio setting is [**3:2**].
 - Pictures recorded in [**2.5M**] (2.5M EZ)
 - When the aspect ratio setting is [**16:9**].
 - Pictures recorded in [**2M**] (2M EZ)
 - Motion pictures
 - Pictures with audio (DMC-LZ5)
- It may not be possible to resize pictures recorded with other equipment.

2 Press ◀/▶ to select the size and then press ▼.

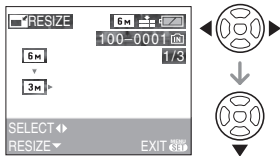

- Sizes smaller than the recorded picture are displayed.
- When the aspect ratio setting is [4:3].
 - [3M]/[2M]/[1M]/[0.3M]
- When the aspect ratio setting is [3:2].
 - [2.5M]
- When the aspect ratio setting is [16:9].
 - [2M]

3 Press ▲/▼ to select [YES] or [NO] and then press [MENU/SET].

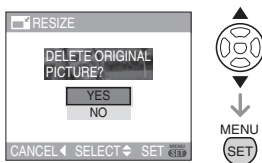

- The picture is overwritten when you select [YES]. Resized pictures cannot be restored when they are overwritten.
- A resized picture is newly created when you select [NO].
- If the original picture is protected, you cannot overwrite it. Select [NO] and newly create a resized picture.

4 Press [MENU/SET] twice to close the menu.

[TRIMMING] *Enlarging a picture and trimming it*

Press [MENU/SET] to display the [PLAY] mode menu and select the item to set. (P69)
You can enlarge and then clip the important part of the recorded picture.

1 Press ◀/▶ to select the picture and then press ▼.



- The following pictures cannot be trimmed.
 - Motion pictures
 - Pictures with audio (DMC-LZ5)
- It may not be possible to trim pictures recorded with other equipment.

2 Enlarge or decrease the parts to be trimmed with the zoom lever.



3 Press ▲/▼/◀/▶ to move the position of the part to be trimmed.



4 Press shutter button.

- The message [DELETE ORIGINAL PICTURE?] appears.

5 Press ▲/▼ to select [YES] or [NO] and then press [MENU/SET].

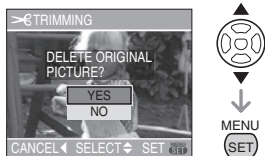

- The picture is overwritten when you select [YES]. The trimmed pictures cannot be restored when they are overwritten.
- A trimmed picture is newly created when you select [NO].
- When the original picture is protected, you cannot overwrite it. Select [NO] and newly create a trimmed picture.

6 Press [MENU/SET] twice to close the menu.



- Depending on the cut size, the picture size of the trimmed picture may become smaller than that of the original picture.
- The picture quality of the trimmed picture will deteriorate.

[COPY] Copying the picture data

Press [MENU/SET] to display the [PLAY] mode menu and select the item to set. (P69)
You can copy recorded picture data from the built-in memory to a card or vice versa.

1 Press ▲/▼ to select the copy destination and then press [MENU/SET].

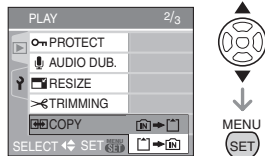

- → :
All the picture data in the built-in memory are copied onto the card at one time.
(Perform step 3)
- → :
One picture at a time is copied from the card to the built-in memory.
(Perform step 2)

2 Press ◀/▶ to select the picture and then press ▼.



- When you copy picture data from the built-in memory to the card, all the pictures are selected at one time so this screen does not appear.

3 Press ▲ to select [YES] and then press [MENU/SET].

(The illustration shows the screen when pictures are copied from the built-in memory to a card.)

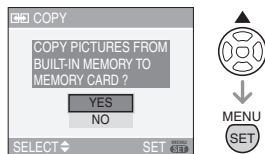

- The message [COPY THIS PICTURE TO BUILT-IN MEMORY?] appears when you copy pictures from the card to the built-in memory.
- If you press [MENU/SET] while copying pictures from the built-in memory to the card, the copying will stop halfway.
- Do not turn the camera off or do any other operations before copying is finished. The data on the built-in memory or the card may be damaged or lost.

4 Press [MENU/SET] several times to close the menu.

- If you copy picture data from the built-in memory to a card, the screen automatically returns to the playback screen when all the pictures are copied.



- If you copy picture data from the built-in memory to a card, we recommend using a card which has more free space than the built-in memory (about 14 MB).
- It may take time to copy the picture data.
- Only pictures recorded with a Panasonic digital camera (LUMIX) will be copied. (Even if the pictures were recorded with a Panasonic digital camera, you may not be able to copy them if they were edited with a PC.)
- DPOF settings on the original picture data will not be copied. Set the DPOF settings again after copying is finished. (P72)
- If a picture with the same name as the picture to be copied exists in the copy destination, the picture will not be copied.
- If you copy picture data from the built-in memory to a card which does not have sufficient free space, the picture data will only be copied halfway.

[FORMAT]



Initializing the built-in memory or a card

Press [MENU/SET] to display the [PLAY] mode menu and select the item to set. (P69) Usually, it is not necessary to format the built-in memory and the card. Format them when the message [BUILT-IN MEMORY ERROR] or [MEMORY CARD ERROR] appears.

Press ▲ to select [YES] and then press [MENU/SET].

(The illustration shows the screen when the built-in memory is formatted.)

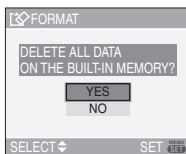

- When a card is not inserted, you can format the built-in memory. When a card is inserted, you can format the card.
- If you press [MENU/SET] while formatting the built-in memory, the formatting will stop halfway. (However, all the pictures will be deleted.)



- Formatting irretrievably deletes all the data including any protected pictures. Check the data carefully before formatting.
- If the card has been formatted on a PC or other equipment, format it on the camera again.
- Use batteries with sufficient power (P13) or the AC adaptor (DMW-AC6; optional) when formatting.
- Do not turn the camera off during formatting.
- It may take longer to format the built-in memory than the card. (Max. about 15 sec.)
- You cannot format an SD Memory Card when the card's write protect switch is set to [LOCK].
- If the built-in memory or the card cannot be formatted, consult your nearest servicenter.

For USA assistance, please call: 1-800-272-7033
or send e-mail to : digitalstillcam@panasonic.com

For Canadian assistance, please call:
1-800-561-5505 or visit us at www.panasonic.ca

Connecting to a PC



You can acquire recorded pictures to a PC by connecting the camera and the PC.

The software [LUMIX Simple Viewer] (for Windows®) in the CD-ROM (supplied) allows you to easily acquire pictures recorded with the camera to a PC, print them and send them by e-mail.

If you use Windows 98/98SE, install the USB driver and then connect it to the computer.

For information about installing [LUMIX Simple Viewer] etc., refer to the separate operating instructions for PC connection.

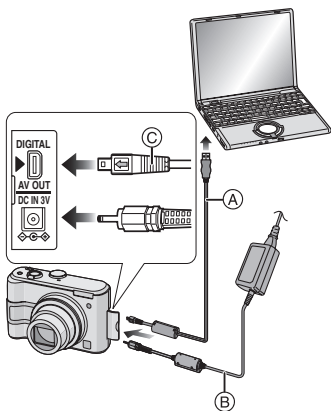

(A): USB connection cable (supplied)

(B): AC adaptor (DMW-AC6; optional)

- Use batteries with sufficient battery power or the AC adaptor (DMW-AC6; optional).
- Turn the camera off before inserting or removing the cable for the AC adaptor (DMW-AC6; optional).

1 Turn on the camera and the PC.

2 Connect the camera to a PC via the USB connection cable (A) (supplied).

- Connect the USB connection cable with the [←] mark facing the [▶] mark on the [DIGITAL] socket.
- Hold the USB connection cable at (C) and insert straight in or take straight out. (If you forcibly insert the USB connection cable at a slant or upside down you can deform the connection terminals and damage the camera or the connected equipment.)



(D): This message appears during data transfer.

3 Press ▲ to select [PC] and then press [MENU/SET].

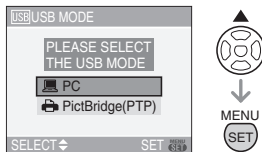

- If you set [USB MODE] in the [SETUP] menu to [PC] in advance, it is not necessary to set this every time you connect to a PC. (P23)
- If you set [USB MODE] to [PictBridge (PTP)] and then connect the camera to the PC, messages may appear on the screen of the PC. Select [Cancel] to close the messages and disconnect the camera from the PC. Set [USB MODE] to [PC] again.

[Windows]

The drive appears in the [My Computer] folder.

- If you are connecting the camera to a PC for the first time, the required driver is installed automatically so that the camera can be recognized by Windows Plug and Play. The drive then appears on the [My Computer] folder.

[Macintosh]

The drive is displayed on the screen.

- The drive is displayed as [LUMIX] when you connect the camera with no card inserted.
- The drive is displayed as [NO_NAME] or [Untitled] when you connect the camera with a card inserted.

■ Folder Composition

Folders are displayed as shown in the following illustration.

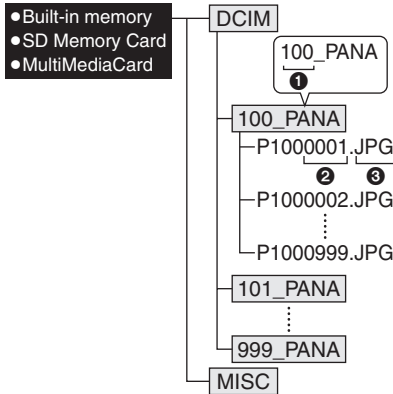

- 1 Folder number
- 2 File number
- 3 JPG: pictures

MOV: motion pictures

The items in each folder are as follows.

DCIM	Folders from [100_PANA] to [999_PANA]
100_PANA to 999_PANA	Pictures/motion pictures
MISC	Files on which the DPOF print settings are recorded

- The data for up to 999 pictures recorded by the camera can be included in 1 folder. If the number of pictures exceeds 999, another folder is created.
- To reset the file number or the folder number, select [NO.RESET] in the [SETUP] menu. (P22)

■ Conditions under which a different folder number is used

In the following cases, the picture is not recorded in the same folder as the previously recorded picture. It is recorded in a folder with a new number.

- 1 When the folder just recorded to contains a picture file with the number 999 in it (example: P1000999.JPG).
- 2 When the card just recorded to contains, for example, a folder with the number 100 (100_PANA) in it and that card is removed and replaced with a card that has a folder with the number 100 in it recorded by a camera from a different maker (100XXXXX, with XXXXX being the name of the maker) and then a picture is recorded.
- 3 When recording after selecting [NO.RESET] (P22) from the [SETUP] menu. (Pictures will be recorded to a new folder with a number sequential to the folder recorded to immediately before. By using [NO.RESET] on a card that does not contain folders or pictures, such as one just formatted, the folder number can be reset to 100.)

■ PictBridge (PTP) setting

Even if you set [USB MODE] to [PictBridge (PTP)], you can connect to your PC if the OS is Windows XP Home Edition/Professional or Mac OS X.

- Pictures can only be read on the camera. They cannot be written to a card or deleted.
- When there are 1000 or more pictures on a card, the pictures may not be imported.



- Do not use any other USB connection cables except the supplied one.
- Do not disconnect the USB connection cable while [ACCESS] is displayed.
- If battery power is exhausted while the camera and the PC are communicating, the recorded data may be damaged. Use batteries with sufficient battery power (P13) or the AC adaptor (DMW-AC6; optional) when you connect the camera to the PC.
- If the remaining battery power becomes low while the camera and the PC are communicating, the status indicator blinks and the alarm beeps. In this case, stop the communication at once on the PC.
- **When connecting the camera to a Windows 2000 OS PC with the USB connection cable, do not replace the card while the camera and the PC are connected. The information on the card may be damaged. Disconnect the USB connection cable before replacing the card.**
- For information about this, refer to the separate operating instructions for PC connection.
- Read the operating instructions for the PC.
- If a card is not inserted when the camera is connected to the PC, you can edit or access the pictures on the built-in memory. If a card is inserted, you can edit or access the pictures on it.
- You cannot switch between the built-in memory and the card while the camera is connected to the PC. When you want to switch between the built-in memory and the card, disconnect the USB connection cable, insert (or remove) the card and then connect the USB connection cable to the PC again.

Printing the Pictures



By connecting the camera directly to a printer supporting PictBridge via the USB connection cable (supplied), you can select the pictures to print and start printing on the camera's screen.

Set print settings such as the print quality on the printer beforehand. (Read the printer operating instructions.)

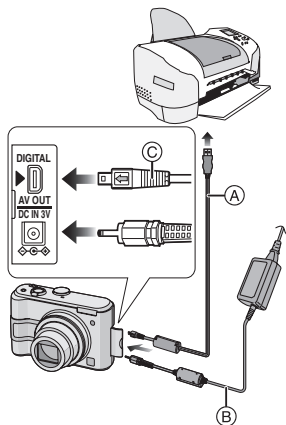

(A): USB connection cable (supplied)

(B): AC adaptor (DMW-AC6; optional)

- It may take time to print some pictures. Use batteries with sufficient battery power (P13) or the AC adaptor (DMW-AC6; optional) when you connect to a printer.
- Turn the camera off before inserting or removing the cable for the AC adaptor (DMW-AC6; optional).

1 Turn on the camera and the printer.

2 Connect the camera to a printer via the USB connection cable (A) (supplied).

- Connect the USB connection cable with the [◀] mark facing the [▶] mark on the [DIGITAL] socket.
- Hold the USB connection cable at © and insert straight in or take straight out.

3 Press ▼ to select [PictBridge (PTP)] and then press [MENU/SET].

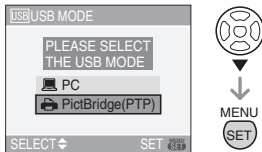

- If you set [USB MODE] in the [SETUP] menu to [PictBridge (PTP)] in advance, it is not necessary to set this every time you connect to a PC. (P23)



- Do not use any other USB connection cables except the supplied one.
- If a card is not inserted when the camera is connected to the PC, you can edit or access the picture data on the built-in memory. If a card is inserted, you can edit or access the picture data on it.
- You cannot switch between the built-in memory and the card while the camera is connected to the printer. When you want to switch between the built-in memory and the card, disconnect the USB connection cable, insert (or remove) the card and then connect the USB connection cable to the printer again.
- To print the age in [BABY1]/[BABY2] (P54) in scene mode, use the software [LUMIX Simple Viewer] in the CD-ROM (supplied) and print from the PC. For information about this, refer to the separate operating instructions for PC connection.

- To find out more about PictBridge compliant printers, contact your local dealer.

■ Single picture

1 Press ▲ to select [SINGLE PICTURE] and then press [MENU/SET].

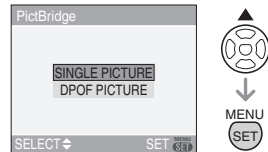

2 Press ◀/▶ to select the picture and then press ▼.

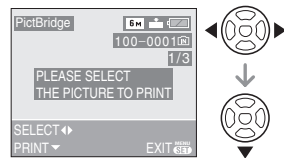

- The message disappears in about 2 seconds.

3 Press ▲ to select [PRINT START] and then press [MENU/SET].

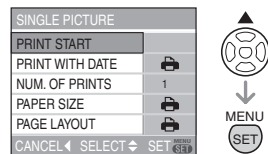

- Press [MENU/SET] to cancel printing.

4 Disconnect the USB connection cable after printing.

■ Setting date printing, the number of prints, the paper size and the page layout

Select and set each item in step 3.

- Items not supported by the printer are displayed in gray and cannot be selected.
- When you want to print pictures in a paper size or a layout which is not supported by the camera, set [PAPER SIZE] or [PAGE LAYOUT] to  and then set the paper size or the layout on the printer. (For details, refer to the operating instructions of the printer.)

• [PRINT WITH DATE]

	Settings on the printer are prioritized.
OFF	Date is not printed.
ON	Date is printed.

- If the printer does not support date printing, the date cannot be printed on the picture.

• [NUM. OF PRINTS]

Set the number of prints.

• [PAPER SIZE]





(Paper sizes that can be set with this unit)
The paper sizes are displayed on pages 1/2 and 2/2. Press  to select.

1/2	
	Settings on the printer are prioritized.
L/3.5"×5"	89 mm×127 mm
2L/5"×7"	127 mm×178 mm
POSTCARD	100 mm×148 mm
A4	210 mm×297 mm
2/2*	
CARD SIZE	54 mm×85.6 mm
10×15cm	100 mm×150 mm
4"×6"	101.6 mm×152.4 mm
8"×10"	203.2 mm×254 mm
LETTER	216 mm×279.4 mm

*These items cannot be displayed when the printer does not support the paper sizes.

• [PAGE LAYOUT]

(Layouts that can be set with this unit)

	Settings on the printer are prioritized.
	1 page with no frame is printed.
	1 page with a frame is printed.
	2 pages are printed.
	4 pages are printed.

- An item cannot be selected if the printer does not support the page layout.

■ DPOF picture

- Set the DPOF print setting on the camera in advance. (P72)

1 Press to select [DPOF PICTURE] and then press [MENU/SET].



2 Press to select [PRINT START] and then press [MENU/SET].

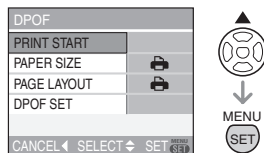

- You cannot select [PRINT START] when the DPOF print setting is not set. Select [DPOF SET] and then set the DPOF print setting. (P72)
- Press [MENU/SET] to cancel printing.

3 Disconnect the USB connection cable after printing.

■ Setting the date printing with the DPOF print in advance

We recommend setting DPOF date printing with [DPOF PRINT] (P73) in advance when the printer supports it. If you select [DPOF PICTURE], printing starts and the recording date is printed.

■ Layout printing



• When printing a picture several times on 1 sheet of paper

For example, if you want to print a picture 4 times on 1 sheet of paper, set [PAGE LAYOUT] to [] and then set [NUM. OF PRINTS] to 4.

• When printing different pictures on 1 sheet of paper (only in DPOF printing)

For example, if you want to print 4 different pictures on 1 sheet of paper, set [PAGE LAYOUT] to [] and then set [COUNT] in [DPOF PRINT] (P72) to 1 for each of the 4 pictures.



- Do not disconnect the USB connection cable when the cable disconnection warning icon [] is displayed. (Depending on the printer, the icon may not be displayed.)
- If the remaining battery power becomes low while the camera and the printer are connected, the status indicator blinks and the alarm beeps. If this happens during printing, press [MENU/SET] and stop printing at once. If not printing, disconnect the USB connection cable.
- The camera is receiving an error message from the printer when the [] indication lights orange during printing. After finishing printing, make sure there are no problems with the printer.
- If the total number of DPOF prints or the number of DPOF pictures printed is high, pictures may be printed several times. The remaining number of prints indicated may

differ from the number set. This is not a malfunction.

- With date printing, the setting on the printer may take priority over the setting on the camera. Check the date print setting on the printer also.

Playing Back Pictures on a TV Screen



■ Playing back pictures using the AV cable (supplied)

The procedure for DMC-LZ5 is described below. In the case of DMC-LZ4/DMC-LZ3, connect the TV and the [V.OUT] terminal on the camera with the video cable (supplied).

- Turn the camera and the TV off.

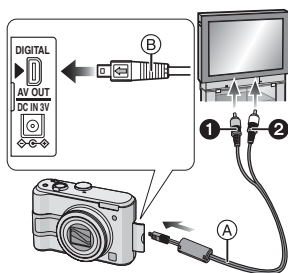

1 Connect the AV cable **(A)** (supplied) to the [AV OUT] socket on the camera.

- Connect the AV cable with the [←] mark facing the [▶] mark on the [AV OUT] socket.
- Hold the AV cable at **(B)** and insert straight in or take straight out.

2 Connect the AV cable to the video input and the audio input sockets on the TV.

- **1** Yellow: to the video input socket
- **2** White: to the audio input socket

3 Turn the TV on and select external input.

4 Turn the camera on.



- Do not use any other AV cables (DMC-LZ5)/video cables (DMC-LZ4/DMC-LZ3) except the supplied one.
- The top and bottom or left and right of the picture may be cut off slightly when it is displayed due to the characteristics of the TV.
- Depending on the screen mode setting of the TV when you connect the camera to a wide-screen TV or a high-definition TV, the picture may be stretched horizontally or vertically and the top and bottom and or left and right of the picture may be cut off when it is displayed. In this case, change the screen mode setting.
- Audio playback is monaural. (DMC-LZ5)
- Read the operating instructions for the TV.
- When you play back a picture vertically, it may be blurry.
- You can view pictures on TVs in other countries (regions) which use the NTSC or PAL system when you set [VIDEO OUT] in the [SETUP] menu. Even if you set [VIDEO OUT] to [PAL], the output signal will still be NTSC in the recording mode.

■ Playing back pictures on a TV with an SD Memory Card slot

Still pictures recorded on an SD Memory Card can be played back on a TV with an SD Memory Card slot.



- Depending on the TV model, pictures may not be displayed on the full screen.
- Motion pictures cannot be played back. To play back motion pictures, connect the camera to the TV with the AV cable (DMC-LZ5)/video cable (DMC-LZ4/DMC-LZ3) (supplied).
- You may not be able to play back MultiMediaCards.

Screen Display

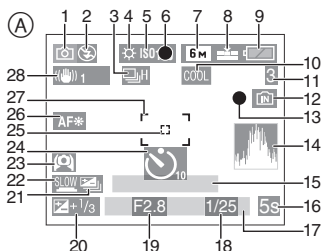

Ⓐ In recording

- 1 Recording mode (P24)
- 2 Flash mode (P39)
- 3 Burst (P46)
 - U : Audio recording (DMC-LZ5) (P55, 66)
- 4 White balance (P62)
- 5 ISO sensitivity (P63)
- 6 Focus (P24)
- 7 Picture size (P64)
- 8 Quality (P64)
 - In Motion picture mode (P55)
 - 30fps VGA / 10fps VGA / 30fps QVGA / 10fps QVGA
 - ((())) : Jitter alert (P26)
- 9 Battery indication (P13)
- 10 Color effect mode (P68)
- 11 Number of recordable pictures/
Available recording time
 - In Motion picture mode (P55)
 - e.g.: R1h20m30s
- 12 Built-in memory/Card (P17)
 - [IN] : Built-in memory
 - [] : Card
- 13 Recording state
- 14 Histogram (P37)

15 Age (P54)

- This is displayed for about 5 seconds when the camera is turned on in baby mode, after setting the clock or birthday, and after switching from other modes to baby mode.

16 Elapsed recording time (P55)

17 Current date and time

- This is displayed for about 5 seconds when the camera is turned on, after setting the clock and after switching from playback mode to recording mode.

Zoom (P29)/Extended optical zoom (P30)/Digital zoom (P31)



18 Shutter speed (P24)

19 Aperture value (P24)

20 Exposure compensation (P43)

21 Auto bracket (P44)

22 Slow shutter (P67)

23 High angle mode (P38)

24 Self-timer mode (P42)

25 Spot AF area (P66)

26 AF assist lamp (P67)

27 AF area (P24)

28 Optical image stabilizer (P45)

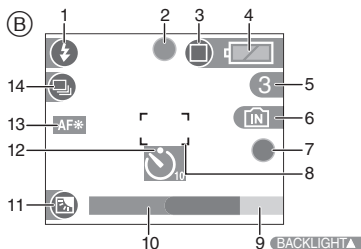

(B) Recording in simple mode

- 1 Flash mode (P39)
- 2 Focus (P24)
- 3 Picture mode (P27)
: Jitter alert (P26)
- 4 Battery indication (P13)
- 5 Number of recordable pictures
- 6 Built-in memory/Card (P17)
: Built-in memory
: Card
- 7 Recording state
- 8 AF area (P24)
- 9 Operation for backlight compensation (P28)
- 10 Current date and time
 - This is displayed for about 5 seconds when the camera is turned on, after setting the clock and after switching from playback mode to simple mode.
 Zoom (P29)/Extended optical zoom (P30)
- 11 Backlight compensation (P28)
- 12 Self-timer mode (P42)
- 13 AF assist lamp (P67)
- 14 Burst (P46)

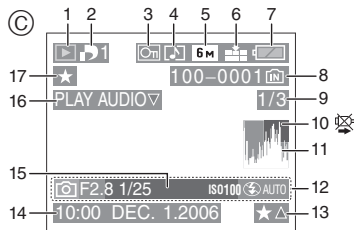

(C) In playback

- 1 Playback mode (P33)
- 2 Number of DPOF prints (P72)
- 3 Protected picture (P74)
- 4 Picture with audio (DMC-LZ5)/Motion pictures (P59)
- 5 Picture size (P64)
- 6 Quality (P64)
 In Motion picture mode (P55)
 / / /
 In Simple mode (P27)
: ENLARGE
: 4"×6"/10×15cm
: E-MAIL
- 7 Battery indication (P13)
- 8 Folder/File number (P81)
Built-in memory/Card (P17)
- 9 Picture number/Total pictures
- 10 Cable disconnection warning icon (P85)
 - This is displayed when printing using a printer supporting PictBridge. (Depending on the printer, the icon may not be displayed.)
 Motion picture recording time (P59)
 e.g.: **1h20m30s**
- 11 Histogram (P37)
- 12 Recording information
- 13 Favorites settings (P70)
Elapsed playback time (P59)
 e.g.: **1h20m30s**

- 14 Recorded date and time
- 15 Age (P54)
- 16 Audio playback (DMC-LZ5) (P59)
In motion picture mode (P55)
- PLAY MOTION**
PICTURE V
- 17 Favorites (P70)

Cautions for Use

■ Optimal use of the camera

Take care not to drop or knock the unit or put a lot of pressure on it.

- Do not leave the unit in your pants pocket when you sit down or forcefully insert it into a full bag etc.
- Take care not to drop or knock the bag that you inserted the unit in as it may strongly shock the unit.
- A strong shock to the unit may break the lens, screen or outer case and cause the unit to malfunction.



Keep the camera as far away as possible from electromagnetic equipment (such as microwave ovens, TVs, video games etc.).

- If you use the camera on top of or near a TV, the pictures and sound on the camera may be disrupted by electromagnetic wave radiation.
- Do not use the camera near cell phones because doing so may result in noise adversely affecting the pictures and sound.
- Recorded data may be damaged, or pictures may be distorted, by strong magnetic fields created by speakers or large motors.
- Electromagnetic wave radiation generated by microprocessors may adversely affect

the camera, disturbing the pictures and sound.

- If the camera is adversely affected by electromagnetic equipment and stops functioning properly, turn the camera off and remove the batteries or disconnect AC adaptor (DMW-AC6; optional). Then reinsert the batteries or reconnect AC adaptor and turn the camera on.

Do not use the camera near radio transmitters or high-voltage lines.

- If you record near radio transmitters or high-voltage lines, the recorded pictures and sound may be adversely affected.

Always use the supplied cords and cables. If you use optional accessories, use the cords and the cables supplied with them.

Do not extend the cords or the cables.

Do not spray the camera with insecticides or volatile chemicals.

- If the camera is sprayed with such chemicals, the body of the camera may be damaged and the surface finish may peel off.
- Do not keep rubber or plastic products in contact with the camera for a long period of time.

Do not use benzine, thinner or alcohol for cleaning the camera.

- Before cleaning the camera, remove the batteries or disconnect the AC adaptor (DMW-AC6; optional) from the electrical outlet.
- The body of the camera may be damaged and the surface finish may peel off.
- Wipe the camera with a soft, dry cloth. To remove stubborn stains, wipe with a cloth that is soaked in a detergent diluted with water and then with a soft, dry cloth.
- If you use a chemically treated cloth, read the instructions that come with the cloth.

- If rain water or other drops of water splash onto the camera, wet a soft cloth with tap water, wring it well, then use it to wipe the camera body carefully. Lastly, wipe the camera again with a dry cloth.

■ Card

Do not leave the card where the temperature is high, where electromagnetic waves or static electricity are easily generated or exposed to direct sunlight.

Do not bend or drop the card.

- The card may be damaged or the recorded content may be damaged or deleted.
- Put the card in the card case or the storage bag after use and when storing or carrying the card.
- Do not allow dirt, dust or water to get into the terminals on the back of the card and do not touch the terminals with your fingers.

■ Batteries

Be sure to remove the batteries when you will not be using the camera for a long period of time.

- If the temperature is too high or low, the terminals may rust causing a malfunction.

If you drop the batteries accidentally, check to see if the body of the batteries and the terminals are damaged.

- Inserting a damaged battery in the camera will damage the camera.

Bring charged spare batteries when going out.

- Be aware that the operating time of the batteries becomes shorter in low temperature conditions such as at a ski resort.

Dispose of unusable batteries.

- Batteries have a limited life.
- Do not throw batteries into fire because they may cause an explosion.

- Unusable batteries should be discarded in accordance with battery recycling laws. Call the RBRC hotline on 1-800-822-8837 for information.

Do not allow battery terminals to come into contact with metal objects (such as necklaces, hairpins, etc.).

- This can cause short circuiting or heat generation and you may be badly burned if you touch the batteries.

Message Display

Confirmation messages or error messages will be displayed on the screen in some cases.

The major messages are described below as examples.

[CURRENT BATTERY TYPE SETTING: OXYRIDE]/[CURRENT BATTERY TYPE SETTING: ALKALINE/Ni-MH]

This message is displayed the first time you insert batteries and when the batteries are exhausted and you replace them. If the battery type being used is different from the one indicated in the message, change the battery type in [BATTERY TYPE] in the [SETUP] menu. (P21)

[THIS MEMORY CARD IS PROTECTED]

The Write-Protect switch on the SD Memory Card is moved to [LOCK]. Move the switch back to unlock it. (P18, 74)

[NO VALID PICTURE TO PLAY]

Record a picture or insert a card with a recorded picture and then play it.

[THIS PICTURE IS PROTECTED]

Delete or overwrite the picture after canceling the protect setting. (P74)

[THIS PICTURE CANNOT BE DELETED]/[SOME PICTURES CANNOT BE DELETED]

Pictures not based on the DCF standard cannot be deleted. If you want to delete some pictures, format the card after saving necessary data on a PC etc. (P78)

[NO ADDITIONAL DELETE SELECTIONS CAN BE MADE]

You have exceeded the number of pictures that can be set at once with [MULTI DELETE]. Delete the selected pictures and then select [MULTI DELETE] again to delete any remaining pictures. More than 999 favorites have been set.

[CANNOT BE SET ON THIS PICTURE]/[CANNOT BE SET ON SOME PICTURES]

If the pictures are not based on the DCF standard, the DPOF print cannot be set.

[NOT ENOUGH SPACE ON BUILT-IN MEMORY]/[NOT ENOUGH MEMORY IN THE CARD]

There is no space left on the built-in memory or the card.

- When you copy pictures from the built-in memory to the card (batch copy), the pictures are copied until the capacity of the card becomes full.

[SOME PICTURES CANNOT BE COPIED]/[COPY COULD NOT BE COMPLETED]

The following pictures cannot be copied.

- When a picture with the same name as the picture to be copied exists in the copy destination.
- Files not based on the DCF standard. Moreover, pictures recorded or edited by other equipment may not be copied.

[BUILT-IN MEMORY ERROR FORMAT BUILT-IN MEMORY?]

This message will be displayed when you format the built-in memory on the PC or remove the batteries without turning the camera off. Format the built-in memory on the camera again. (P78) The data on the built-in memory will be deleted.

[MEMORY CARD ERROR FORMAT THIS CARD?]

The card format cannot be recognized by the camera. Format the card again with the camera after saving necessary data on a PC etc. (P78)

[PLEASE TURN CAMERA OFF AND THEN ON AGAIN]

This message appears when the camera is not operating properly. Turn the camera off and on. If the message persists, contact the dealer or your nearest servicenter.

[MEMORY CARD ERROR PLEASE CHECK THE CARD]

- An error has occurred accessing the card. Insert the card again.
- A card with a capacity more than 2 GB is inserted. Do not use a card with a capacity more than 2 GB.

[READ ERROR PLEASE CHECK THE CARD]

An error has occurred reading the data. Insert the card again. Make sure the card is inserted properly and then play back again.

[WRITE ERROR PLEASE CHECK THE CARD]

An error has occurred writing the data. Turn the camera off and remove the card. Insert the card again and turn the camera on. Make sure the camera is turned off before removing or inserting the card to avoid damage.

[MOTION RECORDING WAS CANCELLED DUE TO THE LIMITATION OF THE WRITING SPEED OF THE CARD]

- We recommend using a high speed SD Memory Card with "10MB/s" or greater displayed on the package when you set the picture quality to [30fpsVGA].
- Depending on the type of SD Memory Card, recording may stop in the middle.

[A FOLDER CANNOT BE CREATED]

A folder cannot be created because there are no remaining folder numbers that can be used. (P81)

Format the card after saving necessary data on a PC etc. (P78)

Troubleshooting

If you return the menu settings to the initial settings at the time of purchase, the condition may improve.

Select [RESET] in the [SETUP] menu. (P23)

■ Batteries and the power source

1: The camera turns off immediately even when battery power is full.

The remaining battery power is low even if new batteries are inserted.

- The remaining battery power may not be displayed accurately, and the camera may suddenly stop working, when the type of battery and the settings on [BATTERY TYPE] are not identical. However this is not a malfunction. Depending on the battery brand and the operating temperature, or if exhausted batteries are used, the remaining battery power may not be displayed accurately.
 - Please check [BATTERY TYPE] (P21) in the [SETUP] menu.

2: The camera cannot be operated even when it is turned on.

- Are the batteries inserted correctly?
- Use sufficiently charged batteries when using Ni-MH batteries.

3: The LCD monitor turns off while the camera is turned on.

- Is power save mode (P22) or economy mode (P22) activated?
 - Press the shutter button halfway to cancel these modes.
- Are the batteries exhausted?
 - Replace them with batteries which have sufficient capacity. (When you use Ni-MH batteries, charge them.)

4: The camera turns off immediately after it is turned on.

- Are the batteries exhausted?

- Replace them with batteries which have sufficient capacity. (When you use Ni-MH batteries, charge them.)
- If you leave the camera on, the batteries will be exhausted. Turn the camera off frequently by using power save mode (P22), economy mode (P22), etc.

■ Recording

1: The picture cannot be recorded.

- Is the mode dial correctly set?
- Is there any memory remaining on the built-in memory or the card?
 - Before recording, delete some pictures. (P34)

2: The recorded picture is whitish.

The lens is dirty.

- The picture can become whitish if there is dirt e.g. fingerprints on the lens. If the lens is dirty, turn on the camera, eject the lens barrel (P10) and gently wipe the lens surface with a soft dry cloth.

3: The recorded picture is too bright or dark.

- Check that the exposure is correctly compensated. (P43)

4: The subject is not focused properly.

- The focus range varies depending on the recording mode.
 - Rotate the mode dial to set the proper mode for the distance to the subject.
- Is the subject beyond the focus range of the camera? (P25)
- Have you taken a picture with jitter?

5: The recorded picture is blurred. The optical image stabilizer is not effective.

- The shutter speed will become slower and the optical image stabilizer function may not work properly when taking pictures especially in dark places. In this case, we recommend holding the camera firmly with both hands when taking pictures. (P25) When

[SLOW SHUTTER] (P67) is set, we recommend using a tripod and the self-timer (P42) when taking pictures.

6: The recorded picture looks rough.

Noise appears on the picture.

- Is the ISO sensitivity high or the shutter speed slow?
 - (ISO sensitivity is set to [AUTO] when the camera is shipped. Therefore, when taking pictures indoors etc. the ISO sensitivity increases.)
 - Decrease the ISO sensitivity. (P63)
 - Set [PICT.ADJ.] to [NATURAL]. (P68)
 - Take pictures in bright places.
- In [HIGH SENS.] (P55) in scene mode, the resolution of the recorded picture decreases slightly because of high sensitivity processing.
 - This is not a malfunction.

7: Motion picture recording stops in the middle.

- Are you using a MultiMediaCard?
 - This unit does not support MultiMediaCards.
- We recommend using a high speed SD Memory Card with "10MB/s" or greater displayed on the package when you set the picture quality to [30fpsVGA].
- Depending on the type of SD Memory Card, recording may stop in the middle.

■ LCD monitor

1: The LCD monitor is turned off sometimes when the camera is turned on.

- Is the LCD monitor turned off soon after you take pictures with the flash?
 - While the flash is being charged, the LCD monitor is turned off.

2: The LCD monitor becomes darker or brighter for a moment.

- This phenomenon appears when you press the shutter button halfway to set the aperture value and does not affect the recorded pictures.

3: The LCD monitor flickers indoors.

- The LCD monitor may flicker for a few seconds after turning the camera on indoors under fluorescent light.

This is not a malfunction.

4: The LCD monitor is too bright or dark.

- Adjust the brightness of the screen. (P21)
- Is the camera in high angle mode? (P38)

5: Black, red, blue and green dots appear on the LCD monitor.

- These pixels do not affect the recorded pictures.

This is not a malfunction.

6: Noise appears on the LCD monitor.



- In dark places, noise may appear to maintain the brightness of the LCD monitor.

This does not affect the pictures you are recording.

7: A vertical line appears on the LCD monitor.

- This is a phenomenon called smear. It is a characteristic of CCD and appears when the subject has a bright part. Uneven colors may also appear around the smear. This is not a malfunction. It is recorded in motion pictures but is not recorded on still pictures.

■ Flash**1: The flash is not activated.**

- Is the flash setting set to Forced OFF [?
– Change the flash setting. (P39)
- The flash is not activated when motion picture mode [], [SCENERY] (P50), [NIGHT SCENERY] (P51), [FIREWORKS] (P53) or [STARRY SKY] (P53) in scene mode is selected.

2: The flash is activated 2 times.

- When you select red-eye reduction (P39), the flash is activated once before

the actual recording to reduce the red-eye phenomenon (eyes of the subject appearing red in the picture) and then activated again for the actual recording.

■ Playback**1: The picture being played back is rotated and displayed in an unexpected direction.**

The camera has a function that automatically rotates the display of pictures recorded holding the camera vertically. (If you take pictures when aiming the camera up or down, the camera may recognize that it is being held vertically.)

- You can display the pictures without being rotated when [ROTATE DISP.] (P71) is set to [OFF].
- You can rotate pictures with the [ROTATE] function. (P71)

2: The picture is not played back.

- Is the mode dial set to playback [)?
- Is there a picture on the built-in memory or the card?

The pictures on the built-in memory appears when a card is not inserted. The picture data on the card appears when a card is inserted. (P17)

3: The folder number and the file number are displayed as [—] and the screen turns black.

- Is the picture edited with a PC or recorded with a digital camera from another manufacturer?
This may also happen if batteries are removed immediately after recording or if recording with exhausted batteries.
– Format the data to delete the pictures mentioned above. (P78) (Formatting irretrievably deletes all data including the other pictures. Check the data carefully before formatting.)

■ TV, PC and printer

1: The picture does not appear on the television.

- Is the camera connected to the TV correctly?
- Set the TV input to external input mode.

2: The display areas on the TV screen and the camera's LCD monitor are different.

Depending on the TV model, the area display may be smaller so the picture may be stretched horizontally or vertically and the top and bottom or left and right of the picture may be cut off when it is displayed. This is due to the TV specifications and is not a malfunction.

3: The motion pictures cannot be played back on a TV.

- Are you trying to play back the motion pictures by directly inserting the card in the card slot of the TV?
 - Connect the camera to the TV with the AV cable (DMC-LZ5)/video cable (DMC-LZ4/DMC-LZ3) (supplied) and then play back the pictures on the camera.

4: The picture cannot be transferred when the camera is connected to a PC.

- Is the camera connected to the PC correctly?
- Is the camera recognized by the PC correctly?
- Set [USB MODE] to [PC]. (P23, 80)

5: The card is not recognized by the PC. (The built-in memory is recognized.)

- Disconnect the USB connection cable. Connect it again while the card is inserted in the camera.

6: The picture cannot be printed when the camera is connected to a printer.

- Does the printer support PictBridge?

- You cannot print pictures with printers which do not support PictBridge.

(P82)



- Set [USB MODE] to [PictBridge (PTP)]. (P23, 82)

7: The ends of the pictures are cut at printing.

- When using a printer with a trimming or borderless printing function, cancel this function before printing. (For details, refer to the operating instructions for the printer.)
- When you order photo studios to print pictures, ask the photo studio if the pictures can be printed with both ends.

■ Others

1: An unreadable language was selected by mistake.

- Press [MENU/SET], select the [SETUP] menu icon [] and then select the [] icon to set the desired language. (P23)

2: The setting for the auto review function is disabled.

- Are you taking pictures using auto bracket (P44)? Is the camera in burst mode (P46) or motion picture mode [] (P55)? Is [AUDIO REC.] set to [ON] (DMC-LZ5) (P66)?
 - In these cases, you cannot set the auto review function in the [SETUP] menu.

3: A red lamp sometimes turns on when the shutter button is pressed halfway.

- In dark places, the AF assist lamp (P67) lights red to make it easier to focus on a subject.

4: The AF assist lamp does not turn on.

- Is [AF ASSIST LAMP] on the [REC] mode menu set to [ON]? (P67)
- Are you taking pictures in dark places?
 - The AF assist lamp does not turn on in bright places.
- The AF assist lamp does not turn on when [SCENERY] (P50), [NIGHT SCENERY] (P51) or [FIREWORKS] (P53) in scene mode is selected.

5: The camera becomes warm.

- The surface of the camera may become warm during use. This does not affect the performance or quality of the camera.

6: The lens clicks.

- When the brightness changes due to zoom or camera movement etc., the lens may click and the picture on the screen may drastically change. However, the picture is not affected. The sound is caused by the automatic adjustment of the aperture. This is not a malfunction.

7: The clock is reset.

- If you do not use the camera for a long time, the clock may be reset. When the message [PLEASE SET THE CLOCK] appears, set the clock again. (P19)
- When you take a picture before setting the clock, [0:00 0. 0. 0] is recorded.

8: Colors appear on the picture which were not found in the actual scene.

- Depending on the zoom magnification, the picture may have some colored fringes around the subject. This is called chromatic aberration and may be more visible when recording distant subjects. However this is not a malfunction.

9: The file numbers are not recorded consecutively.

- When you perform an operation after taking a certain action, the pictures may be recorded in folders with different numbers from the ones used prior to the operation. (P81)

Number of recordable pictures and available recording time

- The number of recordable pictures and the available recording time are an approximation. (These vary depending on the recording conditions and the type of card.)
- The number of recordable pictures varies depending on the subjects.

■ Number of recordable pictures

Aspect ratio		4:3					
Picture size		6M (6M): (2816×2112 pixels) (DMC-LZ5)		5M (5M): (2560×1920 pixels) (DMC-LZ4/ DMC-LZ3)		3M (3M EZ): (2048×1536 pixels)	
Quality							
Built-in Memory (Approx. 14 MB)		4	8	5	10	8	16
Card	16 MB	4	8	5	10	8	16
	32 MB	9	19	11	23	18	36
	64 MB	20	40	24	48	38	75
	128 MB	41	82	50	99	78	150
	256 MB	81	160	98	190	150	290
	512 MB	160	320	195	380	300	590
	1 GB	320	640	390	770	600	1180
	2 GB	660	1270	790	1530	1220	2360

Aspect ratio		4:3					
Picture size		2M (2M EZ): (1600×1200 pixels)		1M (1M EZ): (1280×960 pixels)		0.3M (0.3M EZ): (640×480 pixels)	
Quality							
Built-in Memory (Approx. 14 MB)		13	27	20	39	67	110
Card	16 MB	13	27	21	40	68	110
	32 MB	29	58	45	85	145	230
	64 MB	61	120	93	175	290	480
	128 MB	125	240	190	350	600	970
	256 MB	240	470	370	690	1170	1900
	512 MB	480	940	730	1370	2320	3770
	1 GB	970	1880	1470	2740	4640	7550
	2 GB	1920	3610	2920	5120	8780	12290

Aspect ratio		3:2					
Picture size		5M (5M): (2816×1880 pixels) (DMC-LZ5)		4.5M (4.5M): (2560×1712 pixels) (DMC-LZ4/ DMC-LZ3)		2.5M (2.5M EZ): (2048×1360 pixels)	
Quality							
Built-in Memory (Approx. 14 MB)		4	9	5	11	9	18
Card	16 MB	4	10	5	12	9	18
	32 MB	10	21	13	26	20	40
	64 MB	22	45	27	54	43	83
	128 MB	46	92	56	110	88	165
	256 MB	91	180	110	210	170	330
	512 MB	180	350	210	430	340	650
	1 GB	360	710	440	860	680	1310
2 GB	730	1420	890	1700	1360	2560	

Aspect ratio		16:9					
Picture size		4.5M (4.5M): (2816×1584 pixels) (DMC-LZ5)		3.5M (3.5M): (2560×1440 pixels) (DMC-LZ4/ DMC-LZ3)		2M (2M EZ): (1920×1080 pixels)	
Quality							
Built-in Memory (Approx. 14 MB)		5	11	6	14	12	24
Card	16 MB	5	11	7	14	12	25
	32 MB	12	25	15	31	27	53
	64 MB	27	53	32	64	57	105
	128 MB	55	105	66	130	115	220
	256 MB	105	210	130	250	230	430
	512 MB	210	420	250	510	450	860
	1 GB	430	850	520	1020	910	1720
2 GB	870	1700	1040	2040	1800	3410	

■ Available recording time (seconds)

Picture quality setting		30fpsVGA	10fpsVGA	30fpsQVGA	10fpsQVGA
Built-in Memory (Approx. 14 MB)		—	—	25	81
SD Memory Card	16 MB	5	25	25	82
	32 MB	15	55	55	170
	64 MB	35	120	120	360
	128 MB	80	250	250	740
	256 MB	160	490	490	1440
	512 MB	320	980	980	2870
	1 GB	660	1970	1970	5700
2 GB	1350	4020	4020	11700	



- The numbers inside the thick black line are the number of recordable pictures in simple mode [♥]. (P27)
- The number of recordable pictures and the available recording time displayed on the LCD monitor may not decrease in order.
- This unit does not support recording motion pictures on MultiMediaCards.
- The extended optical zoom does not work in [HIGH SENS.] (P55) in scene mode so the picture size for [EZ] is not displayed.







Specifications

Digital Camera:	Information for your safety
Power Source:	DC 3.0 V
Power Consumption:	DMC-LZ5: 1.5 W (When recording) 0.7 W (When playing back)
	DMC-LZ4: DMC-LZ3: 1.4 W (When recording) 0.7 W (When playing back)
Camera effective pixels:	6,000,000 pixels (DMC-LZ5)/5,000,000 pixels (DMC-LZ4/ DMC-LZ3)
Image sensor:	1/2.5" CCD, total pixel number 6,370,000 pixels (DMC-LZ5)/ 5,360,000 pixels (DMC-LZ4/DMC-LZ3), Primary color filter
Lens:	Optical 6× zoom, f=6.1 mm to 36.6 mm (35 mm film camera equivalent: 37 mm to 222 mm)/F2.8 to F4.5
Digital zoom:	Max. 4×
Extended optical zoom:	Max. 8.3× (DMC-LZ5)/Max. 7.5× (DMC-LZ4/DMC-LZ3) (Except for the maximum picture size for each aspect ratio)
Focus:	Normal/Macro, 5-area-focusing/3-area-focusing (High speed)/ 1-area-focusing (High speed)/1-area-focusing/Spot-focusing
Focus range:	Normal: 50 cm (1.64 feet) (Wide)/1.2 m (3.94 feet) (Tele) to ∞ Macro/Simple/Motion picture: 5 cm (0.16 feet) (Wide)/50 cm (1.64 feet) (Tele) to ∞
Shutter system:	Electronic shutter+Mechanical shutter
Burst recording	
Burst speed:	3 frames/second (High speed), 2 frames/second (Low speed), Approx. 1.5 frames/second (Unlimited)
Number of recordable pictures:	Max. 8 frames (Standard) (DMC-LZ5), max. 6 frames (Fine), (DMC-LZ5), Max. 5 frames (Standard) (DMC-LZ4/DMC-LZ3), max. 3 frames (Fine) (DMC-LZ4/DMC-LZ3), Depends on the remaining capacity of the built-in memory or the card (Unlimited). (Performance in burst recording is only with SD Memory Card. MultiMediaCard performance will be less.)
Motion picture recording:	640×480 pixels (Only when using an SD Memory Card)/ 320×240 pixels (30 or 10 frames/second with audio. The maximum recording time depends on the capacity of the built-in memory or the card. Audio recording is available only with DMC-LZ5.)
ISO sensitivity:	AUTO/80/100/200/400 [HIGH SENS.] mode: 800 to 1600
Shutter speed:	8 to 1/2000th [STARRY SKY] mode: 15 seconds, 30 seconds, 60 seconds Motion picture mode: 1/30th to 1/20000th
White balance:	AUTO/Daylight/Cloudy/Halogen/White set
Exposure (AE):	Program AE Exposure compensation (1/3 EV Step, -2 EV to +2 EV)

Metering mode:	Multiple
LCD monitor:	2.5" (DMC-LZ5/DMC-LZ4)/2.0" (DMC-LZ3) low-temperature polycrystalline TFT LCD (Approx. 85,000 pixels) (field of view ratio about 100%)
Flash:	Flash range: (ISO AUTO) Approx. 50 cm (1.64 feet) to 4.2 m (13.8 feet) (Wide [HIGH SENS.] mode: Approx. 80 cm (2.62 feet) to 5.7 m (18.7 feet) AUTO, AUTO/Red-eye reduction, Forced ON (Forced ON/Red-eye reduction), Slow sync./Red-eye reduction, Forced OFF
Microphone (DMC-LZ5):	Monaural
Recording media:	Built-in Memory (Approx. 14 MB)/SD Memory Card/MultiMediaCard (Still pictures only)
Picture size	
Still picture:	When the aspect ratio setting is [4:3] 2816×2112 pixels (DMC-LZ5), 2560×1920 pixels (DMC-LZ4/DMC-LZ3), 2048×1536 pixels, 1600×1200 pixels, 1280×960 pixels, 640×480 pixels When the aspect ratio setting is [3:2] 2816×1880 pixels (DMC-LZ5), 2560×1712 pixels (DMC-LZ4/DMC-LZ3), 2048×1360 pixels When the aspect ratio setting is [16:9] 2816×1584 pixels (DMC-LZ5), 2560×1440 pixels (DMC-LZ4/DMC-LZ3), 1920×1080 pixels
Motion pictures:	640×480 pixels (Only when using an SD Memory Card)/320×240 pixels
Quality:	Fine/Standard
Recording file format	
Still Picture:	JPEG (based on Design rule for Camera File system, based on Exif 2.2 standard)/DPOF corresponding
Picture with audio (DMC-LZ5):	JPEG (based on Design rule for Camera File system, based on Exif 2.2 standard)+QuickTime (picture with audio)
Motion pictures:	QuickTime Motion JPEG (Audio recording is available on DMC-LZ5)
Interface	
Digital:	USB 2.0 (Full Speed)
Analog video/audio (DMC-LZ5):	
Analog video (DMC-LZ4/DMC-LZ3):	NTSC/PAL Composite (Switched by menu), Audio line output (monaural) (DMC-LZ5)
Terminal	
DIGITAL/AV OUT (DMC-LZ5):	
DIGITAL/V.OUT (DMC-LZ4/DMC-LZ3):	Dedicated jack (8 pin)
DC IN:	Dedicated jack

Dimensions:	Approx. 100.0 mm (W)×62.0 mm (H)×45.0 mm (D) [3 15/16" (W)×2 7/16" (H)×1 13/16" (D)] (excluding the projection part)
Mass:	Approx. 186 g/6.56 oz (DMC-LZ5/DMC-LZ4), Approx. 183 g/6.45 oz (DMC-LZ3) (excluding card and batteries), Approx. 234 g/8.25 oz (DMC-LZ5/DMC-LZ4), Approx. 231 g/8.15 oz (DMC-LZ3) (with card and batteries)
Operating temperature:	0 °C to 40 °C (32 °F to 104 °F)
Operating humidity:	10% to 80%

Digital Camera Accessory System

Accessory#	Figure	Description
DMW-CLZ5		Soft Case
DMW-CLZH5		Semi Hard Case
DMW-AC6		AC Adaptor
RP-SDK02GU1A RP-SDQ02GU1A RP-SDK01GU1A RP-SDQ01GU1A RP-SDK512U1A RP-SD512BU1A RP-SDH256U1A RP-SD256BU1A RP-SD128BU1A RP-SD064BPPA		2 GB SD Memory Card 2 GB SD Memory Card 1 GB SD Memory Card 1 GB SD Memory Card 512 MB SD Memory Card 512 MB SD Memory Card 256 MB SD Memory Card 256 MB SD Memory Card 128 MB SD Memory Card 64 MB SD Memory Card
BN-SDCAPU/1B		SD USB Reader/Writer (compatible with MultiMediaCard)
BN-SDABPU/1B		SD PC Card Adaptor (compatible with MultiMediaCard)

•NOTE: Accessories and/or model numbers may vary between countries. Consult your local dealer.

Digital Camera Accessory Order Form

(For USA Customers)

Please photocopy this form when placing an order.

1. Digital Camera Model # _____

2. Items Ordered

Accessory #	Description	Price Each	Quantity	Total Price
Subtotal				
Your State & Local Sales Tax				
Shipping & Handling				6.95
Total Enclosed				

3. Method of payment (check one)

- Check of Money Order enclosed (NO C.O.D.SHIPMENTS)
- VISA Credit Card # _____
- MasterCard Expiration Date _____
- Discover Customer Signature _____

Make Check or Money Order to: PANASONIC ACCESSORIES

(Please do not send cash)

4. Shipping information (UPS delivery requires complete street address)

Ship To:

Mr.

Mrs.

Ms.

First _____ Last _____

Phone#:

Day () _____

Street Address _____

Night () _____

City _____ State _____ Zip _____

TO OBTAIN ANY OF OUR DIGITAL CAMERA ACCESSORIES YOU CAN DO ANY OF
THE FOLLOWING:

VISIT YOUR LOCAL PANASONIC DEALER

OR

CALL PANASONIC'S ACCESSORY ORDER LINE AT 1-800-332-5368

[6 AM-5 PM M-F, 6 AM-10:30 AM SAT, PACIFIC TIME]

OR

MAIL THIS ORDER TO: PANASONIC SERVICES COMPANY ACCESSORY ORDER OFFICE

20421 84th Avenue South Kent, WA. 98032

In CANADA, please contact your local Dealer for more information about accessories.

Request for Service Notice (For USA Only)

Please photocopy this form when making a request for service notice.

In the unlikely event this product needs service.

Request for Service Notice: (USA Only)

- Please include your **proof of purchase**.
(Failure to do so will delay your repair.)
 - To further speed your repair, please provide an explanation of what wrong with the unit and any symptom it is exhibiting.
-
-
-
-

Mail this completed form and your Proof of Purchase along with your unit to:

Panasonic Services Company
410B Airport Road
Elgin, IL 60123-9333
Attn: Digital Camera Repair

Limited Warranty (For USA Only)

PANASONIC CONSUMER ELECTRONICS COMPANY, DIVISION OF
PANASONIC CORPORATION OF NORTH AMERICA
One Panasonic Way, Secaucus, New Jersey 07094

PANASONIC PUERTO RICO, INC.

Ave. 65 de Infantería, Km. 9.5, San Gabriel Industrial Park, Carolina, Puerto Rico 00985

Panasonic Digital Still Camera Limited Warranty

Limited Warranty Coverage

If your product does not work properly because of a defect in materials or workmanship, Panasonic Consumer Electronics Company or Panasonic Puerto Rico, Inc. (collectively referred to as "the warrantor") will, for the length of the period indicated on the chart below, which starts with the date of original purchase ("warranty period"), at its option either (a) repair your product with new or refurbished parts, or (b) replace it with a new or refurbished product. The decision to repair or replace will be made by the warrantor.

PRODUCT OR PART NAME	PARTS	LABOR
DIGITAL STILL CAMERA (EXCEPT ITEMS LISTED BELOW)	1 (ONE) YEAR	90 (NINETY) DAYS
CCD	6 (SIX) MONTHS	90 (NINETY) DAYS
RECHARGEABLE BATTERY PACK (IN EXCHANGE FOR DEFECTIVE BATTERY PACK)	90 (NINETY) DAYS	NOT APPLICABLE
SD MEMORY CARD (IN EXCHANGE FOR DEFECTIVE SD CARD)	90 (NINETY) DAYS	NOT APPLICABLE

During the "Labor" warranty period there will be no charge for labor. During the "Parts" warranty period, there will be no charge for parts. You must carry-in or mail-in your product during the warranty period. If non-rechargeable batteries are included, they are not warranted. This warranty only applies to products purchased and serviced in the United States or Puerto Rico. This warranty is extended only to the original purchaser of a new product which was not sold "as is". A purchase receipt or other proof of the original purchase date is required for warranty service.

Carry-In or Mail-In Service

For Carry-In or Mail-In Service in the United States call
1-800-272-7033.

For assistance in Puerto Rico call Panasonic Puerto Rico, Inc.
(787)-750-4300 or fax (787)-768-2910.

This warranty ONLY COVERS failures due to defects in materials or workmanship, and DOES NOT COVER normal wear and tear or cosmetic damage. The warranty ALSO DOES NOT COVER damages which occurred in shipment, or failures which are caused by products not supplied by the warrantor, or failures which result from accidents, misuse, abuse, neglect, mishandling, misapplication, alteration, faulty installation, set-up adjustments, misadjustment of consumer controls, improper maintenance, power line surge, lightning damage, modification, or commercial use (such as in a hotel, office, restaurant, or other business), rental use of the product, service by anyone other than a Factory Servicenter or other Authorized Servicer, or damage that is attributable to acts of God.

THERE ARE NO EXPRESS WARRANTIES EXCEPT AS LISTED UNDER "LIMITED WARRANTY COVERAGE". THE WARRANTOR IS NOT LIABLE FOR INCIDENTAL OR CONSEQUENTIAL DAMAGES RESULTING FROM THE USE OF THIS PRODUCT, OR ARISING OUT OF ANY BREACH OF THIS WARRANTY. (As examples, this excludes damages for lost time, travel to and from the servicer, loss of media or images, data or other memory content. The items listed are not exclusive, but are for illustration only.) **ALL EXPRESS AND IMPLIED WARRANTIES, INCLUDING THE WARRANTY OF MERCHANTABILITY, ARE LIMITED TO THE PERIOD OF THE LIMITED WARRANTY.**

Some states do not allow the exclusion or limitation of incidental or consequential damages, or limitations on how long an implied warranty lasts, so the exclusions may not apply to you.

This warranty gives you specific legal rights and you may also have other rights which vary from state to state. If a problem with this product develops during or after the warranty period, you may contact your dealer or Servicenter. If the problem is not handled to your satisfaction, then write to the warrantor's Consumer Affairs Department at the addresses listed for the warrantor.

PARTS AND SERVICE WHICH ARE NOT COVERED BY THIS LIMITED WARRANTY ARE YOUR RESPONSIBILITY.

Customer Services Directory (For USA Only)

For Product Information, Operating Assistance, Literature Request, Dealer Locations, and all Customer Service inquiries please contact:

1-800-272-7033, Monday-Friday 8:30am-8pm EST.

Web Site: <http://www.panasonic.com/consumersupport>

You can purchase parts, accessories or locate your nearest servicerenter by visiting our Web Site.

Accessory Purchases:

Purchase Parts, Accessories and Instruction Books online for all Panasonic Products by visiting our Web Site at:

<http://www.pasc.panasonic.com>

or, send your request by E-mail to:
npcparts@us.panasonic.com

You may also contact us directly at:

1-800-332-5368 (Customer Orders Only)

Panasonic Services Company 20421 84th Avenue South, Kent, WA 98032

(6 am to 5 pm Monday - Friday; 6 am to 10:30 am Saturday; PST)

(Visa, MasterCard, Discover Card, American Express, Check)

Product Repairs

MAIL TO :

Centralized Factory Servicerenter

Panasonic Services Company

410B Airport Road

Elgin, IL 60123-9333

Attention: Digital Camera Repair

Please carefully pack and ship, prepaid and insured, to the Elgin Centralized Factory Servicerenter.

Customer's in Puerto Rico, please ship or carry in to location below ("Service in Puerto Rico").

Service in Puerto Rico

Panasonic Puerto Rico, Inc.:

Ave. 65 de Infantería, Km. 9.5, San Gabriel Industrial Park, Carolina, Puerto Rico 00985

Phone (787) 750-4300 Fax (787) 768-2910

As of October 2005

Index

A

AC Adaptor	80, 82
Access Indication	17
AF Assist Lamp	67
AF Mode	66
AF/AE Lock	25
Alkaline Batteries	12
Aspect Ratio	64
Audio Dubbing	75
Audio Recording	55, 66
Auto Bracket	44
Auto Review	21
Auto White Balance	62
Available Recording Time	99

B

Baby Mode	54
Backlight Compensation	28
Batteries	12
Battery Setting	21
Brightness of the LCD Monitor	21
Built-in Flash	39
Built-in Memory	17
Burst Mode	46

C

Candle Light Mode	52
Clock Set	19, 21
Color Effect	68
Condensation	4
Copy	77

D

Date Printing	73, 84, 85
Deleting Pictures	34
Demonstration of the Optical Image Stabilizer	45
Digital Zoom	31
DPOF Print Setting	72

E

Economy Mode	22, 47
Exposure	26
Exposure Compensation	43
Extended Optical Zoom	30
EZ	30, 64

F

File Number	22, 81, 88
Fine	65
Fireworks Mode	53
Focus	25
Folder Composition	81
Folder Number	22, 81, 88
Food Mode	52
Formatting	78

H

High Angle Mode	38
High Sensitivity Mode	55
Histogram	37

I

ISO Sensitivity	63
-----------------------	----

J

Jitter	26
--------------	----

L

Language Setting	23
Layout	84
LCD Monitor	36, 87

M

Macro Mode	48
MANUAL	70
Mass Storage	23
Motion Picture Mode	55
Multi Playback	57

N

Night Portrait Mode	51
Night Scenery Mode	51
Ni-MH Batteries	12, 13
Normal Recording	24
NO.RESET	22
NTSC	23
Number of Prints	73, 84
Number of Recordable Pictures	14, 97

O

Operational Sound	22
Optical Image Stabilizer	45
Optical Zoom	29
Oxyride Batteries	12

P	
PAL	23
Paper Size	84
Party Mode	52
PC	23, 80
PictBridge	23, 82
Picture Adjustment	68
Picture Quality Setting (Motion Picture Mode)	56
Picture Quality Setting (Simple Mode)	27
Picture Size	64
Pictures with Audio	59
Playback Pictures on TV	86
Playback Zoom	58
Playing Back Motion Pictures	59
Portrait Mode	50
Power Save	22
Protect	74

Q

Quality	64
---------------	----

R

Recording Guide Line	37
Reset of Setting	23
Resizing	75
Review	32
Rotate	71
Rotate Display	71

S

Scene Menu	23
Scene Mode	49
Scenery Mode	50
Self-timer	42
Setting Favorites	70
Setup Menu	20
Simple Mode	27
Slide Show	69
Slow Shutter	67
Snow Mode	54
Soft Skin Mode	50
Sports Mode	51
Spot-focusing	66
Standard	65
Starry Sky Mode	53
Status Indicator	13, 16, 22, 47

T

Trimming	76
----------------	----

U

USB Connection Cable	80, 82
USB Mode	23, 80, 83

V

Video Output	23, 86
--------------------	--------

W

White Balance	62
White Balance Fine Adjustment	62
White Set	62

Numerics

1-area-focusing	66
1-area-focusing (High speed)	66
3-area-focusing (High speed)	66
5-area-focusing	66

Spanish Quick Use Guide/Guía rápida en español

Ésta es una visión de conjunto que trata del procedimiento para grabar y reproducir las imágenes con la cámara.

1 Inserte las baterías.

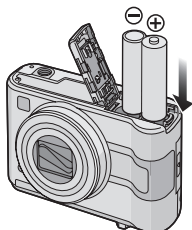

- Si no usa la tarjeta (opcional), puede grabar o reproducir las imágenes en la memoria integrada.

2 Encienda la cámara para tomar las imágenes.

- Ajuste el reloj.
- Seleccione el tipo de batería en uso en [TIPO BATERÍA] en el menú de [CONF.].

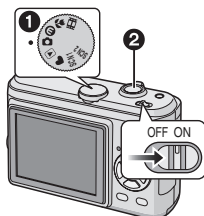

- 1 Ajuste el disco del modo a [📷].
- 2 Pulse el botón del obturador para tomar las imágenes.

3 Reproduzca las imágenes.

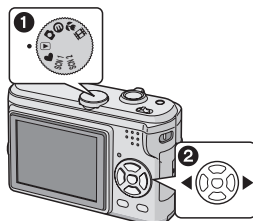

- 1 Ajuste el disco del modo a [▶].
- 2 Elija la imagen que quiere ver.



QuickTime and the QuickTime logo are trademarks or registered trademarks of Apple Computer, Inc., used under license.

**Panasonic Consumer Electronics Company,
Division of Panasonic Corporation of North America**

One Panasonic Way, Secaucus, NJ 07094

Panasonic Puerto Rico, Inc.

Ave. 65 de Infantería, Km. 9.5, San Gabriel Industrial Park, Carolina, Puerto Rico 00985

Panasonic Canada Inc.

5770 Ambler Drive, Mississauga, Ontario, L4W 2T3

© 2006 Matsushita Electric Industrial Co., Ltd.



VQT0U87

F1205Mn0 (10000 Ⓐ)

