

# Panasonic®

## Owner's Manual Blu-ray Disc™ Player

Model No. DMP-BDT330  
DMP-BDT230  
DMP-BDT225



Unless otherwise indicated, illustrations in this Owner's Manual are of DMP-BDT330.



### Firmware updates

Panasonic is constantly improving the unit's firmware to ensure that our customers are enjoying the latest technology. Panasonic recommends updating your firmware as soon as you are notified.

For details, refer to "Firmware updates" (⇒ 16) or <http://panasonic.jp/support/global/cs/> (This site is in English only.)

Thank you for purchasing this product.

Please read these instructions carefully before using this product, and save this manual for future use.

If you have any questions, contact:

U.S.A. and Puerto Rico : 1-800-211-PANA(7262)

Canada : 1-800-561-5505

Register online at [www.panasonic.com/register](http://www.panasonic.com/register) (U.S. customers only)

P

PC



VQT4V26-4

# IMPORTANT SAFETY INSTRUCTIONS

Read these operating instructions carefully before using the unit. Follow the safety instructions on the unit and the applicable safety instructions listed below. Keep these operating instructions handy for future reference.

- 1 Read these instructions.
- 2 Keep these instructions.
- 3 Heed all warnings.
- 4 Follow all instructions.
- 5 Do not use this apparatus near water.
- 6 Clean only with dry cloth.
- 7 Do not block any ventilation openings. Install in accordance with the manufacturer's instructions.
- 8 Do not install near any heat sources such as radiators, heat registers, stoves, or other apparatus (including amplifiers) that produce heat.
- 9 Do not defeat the safety purpose of the polarized or grounding-type plug. A polarized plug has two blades with one wider than the other. A grounding-type plug has two blades and a third grounding prong. The wide blade or the third prong are provided for your safety. If the provided plug does not fit into your outlet, consult an electrician for replacement of the obsolete outlet.
- 10 Protect the power cord from being walked on or pinched particularly at plugs, convenience receptacles, and the point where they exit from the apparatus.
- 11 Only use attachments/accessories specified by the manufacturer.
- 12 Use only with the cart, stand, tripod, bracket, or table specified by the manufacturer, or sold with the apparatus. When a cart is used, use caution when moving the cart/apparatus combination to avoid injury from tip-over.
- 13 Unplug this apparatus during lightning storms or when unused for long periods of time.
- 14 Refer all servicing to qualified service personnel. Servicing is required when the apparatus has been damaged in any way, such as power-supply cord or plug is damaged, liquid has been spilled or objects have fallen into the apparatus, the apparatus has been exposed to rain or moisture, does not operate normally, or has been dropped.



	<b>CAUTION</b> RISK OF ELECTRIC SHOCK DO NOT OPEN	
<p>CAUTION : TO REDUCE THE RISK OF ELECTRIC SHOCK, DO NOT REMOVE SCREWS. NO USER-SERVICEABLE PARTS INSIDE. REFER SERVICING TO QUALIFIED SERVICE PERSONNEL.</p>		



The lightning flash with arrowhead symbol, within an equilateral triangle, is intended to alert the user to the presence of uninsulated "dangerous voltage" within the product's enclosure that may be of sufficient magnitude to constitute a risk of electric shock to persons.



The exclamation point within an equilateral triangle is intended to alert the user to the presence of important operating and maintenance (servicing) instructions in the literature accompanying the appliance.

## THE FOLLOWING APPLIES IN THE U.S.A. AND CANADA

This device complies with Part 15 of FCC Rules and RSS-Gen of IC Rules. Operation is subject to the following two conditions:

- (1) This device may not cause interference, and
- (2) this device must accept any interference, including interference that may cause undesired operation of this device.

Contains FCC ID : NKR-P1

Contains IC ID : 4441A-P1

This transmitter must not be co-located or operated in conjunction with any other antenna or transmitter.

This product is restricted to indoor use due to its operation in the 5.15 to 5.25 GHz frequency range.

FCC and IC require this product to be used indoors for the frequency range 5.15 to 5.25 GHz to reduce the potential for harmful interference to co-channel Mobile Satellite systems. High power radars are allocated as primary users of the 5.25 to 5.35 GHz and 5.65 to 5.85 GHz bands. These radar stations can cause interference with and/or damage this product.

This equipment complies with FCC/IC radiation exposure limits set forth for an uncontrolled environment and meets the FCC radio frequency (RF) Exposure Guidelines in Supplement C to OET65 and RSS-102 of the IC radio frequency (RF) Exposure rules. This equipment has very low levels of RF energy that is deemed to comply without maximum permissive exposure evaluation (MPE). But it is desirable that it should be installed and operated keeping the radiator at least 20cm (7 7/8") or more away from person's body (excluding extremities: hands, wrists, feet and ankles).

## THE FOLLOWING APPLIES ONLY IN THE U.S.A.

### FCC Note:

This equipment has been tested and found to comply with the limits for a Class B digital device, pursuant to Part 15 of the FCC Rules. These limits are designed to provide reasonable protection against harmful interference in a residential installation. This equipment generates, uses and can radiate radio frequency energy and, if not installed and used in accordance with the instructions, may cause harmful interference to radio communications. However, there is no guarantee that interference will not occur in a particular installation. If this equipment does cause harmful interference to radio or television reception, which can be determined by turning the equipment off and on, the user is encouraged to try to correct the interference by one or more of the following measures:

- Reorient or relocate the receiving antenna.
- Increase the separation between the equipment and receiver.
- Connect the equipment into an outlet on a circuit different from that to which the receiver is connected.
- Consult the dealer or an experienced radio/TV technician for help.

**FCC Caution:** To assure continued compliance, follow the attached installation instructions and use only shielded interface cables when connecting to peripheral devices.

Any changes or modifications not expressly approved by the party responsible for compliance could void the user's authority to operate this equipment.

This device complies with Part 15 of the FCC Rules. Operation is subject to the following two conditions:

- (1) This device may not cause harmful interference, and
- (2) this device must accept any interference received, including interference that may cause undesired operation.

Declaration of Conformity

Trade Name: Panasonic

Model No.: DMP-BDT330

DMP-BDT230

DMP-BDT225

Responsible Party:

Panasonic Corporation of North America

Two Riverfront Plaza, Newark, NJ 07102-5490

Support Contact Telephone No.: 1-800-211-PANA (7262)

# Precautions

## WARNING

### Unit

- To reduce the risk of fire, electric shock or product damage,
- Do not expose this unit to rain, moisture, dripping or splashing.
  - Do not place objects filled with liquids, such as vases, on this unit.
  - Use only the recommended accessories.
  - Do not remove covers.
  - Do not repair this unit by yourself. Refer servicing to qualified service personnel.

### AC power supply cord

- The power plug is the disconnecting device. Install this unit so that the power plug can be unplugged from the socket outlet immediately.

### Small object

- Keep the Memory Card out of reach of children to prevent swallowing.

## CAUTION

### Unit

- This unit utilizes a laser. Use of controls or adjustments or performance of procedures other than those specified herein may result in hazardous radiation exposure.
- Do not place sources of naked flames, such as lighted candles, on this unit.

### Placement

- To reduce the risk of fire, electric shock or product damage,
- Do not install or place this unit in a bookcase, built-in cabinet or in another confined space. Ensure this unit is well ventilated.
  - Do not obstruct this unit's ventilation openings with newspapers, tablecloths, curtains, and similar items.
  - Do not place the unit on amplifiers/receivers or equipment that may become hot. The heat can damage the unit.

### Batteries

- Mishandling of batteries can cause electrolyte leakage, which can damage items the fluid contacts and may cause a fire.
- Danger of explosion if battery is incorrectly replaced. Replace only with the type recommended by the manufacturer.
  - When disposing the batteries, please contact your local authorities or dealer and ask for the correct method of disposal.
  - Do not mix old and new batteries or different types at the same time.
  - Do not heat or expose to flame.
  - Do not leave the battery(ies) in a car exposed to direct sunlight for a long period of time with doors and windows closed.
  - Do not take apart or short circuit.
  - Do not attempt to recharge alkaline or manganese batteries.
  - Do not use batteries if the covering has been peeled off.

Remove batteries if the remote control is not going to be used for a long period of time. Store in a cool, dark place.

## Information on Disposal in other Countries outside the European Union



This symbol is only valid in the European Union.  
If you wish to discard this product, please contact your local authorities or dealer and ask for the correct method of disposal.

## Wireless LAN connection

The following limits are in place regarding the usage of this unit. You must be aware of these limits before using this unit. Panasonic will in no way be responsible for any incidental damage which may arise due to a failure to obey these limits, or to any condition of use or disuse of this unit.

- **Data transmitted and received over radio waves may be intercepted and monitored.**

- **This unit contains delicate electronic components.**

- Please use this unit in the manner in which it was intended and follow the following points:
- Do not expose this unit to high temperatures or direct sunlight.
  - Do not bend, or subject this unit to strong impacts.
  - Keep this unit away from moisture.
  - Do not disassemble or alter this unit in any way.

## Restriction on use of unauthorized copied content

This unit adopts the following technology for copyright protection.

### Cinavia Notice

This product uses Cinavia technology to limit the use of unauthorized copies of some commercially-produced film and videos and their soundtracks. When a prohibited use of an unauthorized copy is detected, a message will be displayed and playback or copying will be interrupted.

More information about Cinavia technology is provided at the Cinavia Online Consumer Information Center at <http://www.cinavia.com>. To request additional information about Cinavia by mail, send a postcard with your mailing address to:

Cinavia Consumer Information Center, P.O. Box 86851, San Diego, CA, 92138, USA.

## To dispose or transfer this unit

The unit may keep the user settings information in the unit. If you discard this unit either by disposal or transfer, then follow the procedure to return all the settings to the factory presets to delete the user settings. (→ 35, "To return all settings to the factory preset.")

- The operation history may be recorded in the memory of this unit.

<b>CAUTION</b> – VISIBLE AND INVISIBLE LASER RADIATION WHEN OPEN, DO NOT STARE INTO BEAM. FDA 21CFRCLASS II (Ia)
<b>CAUTION</b> – CLASS 2 VISIBLE AND INVISIBLE LASER RADIATION WHEN OPEN, DO NOT STARE INTO THE BEAM. IEC60825-1:CLASS 2
<b>ATTENTION</b> – RAYONNEMENT LASER VISIBLE ET INVISIBLE, CLASSE 2. EN CAS D'OUVERTURE, NE PAS REGARDER DANS LE FAISCEAU.
<b>FORSIGTIG</b> – SYNLIG OG USYNLIG LASERSTRÅLING KLASSE 2. NÅR LÅGET ER ÅBENT, UNDGÅ AT SE LIGE IND I STRÅLEN.
<b>VARO</b> – AVATTAESSA OLET ALTTIINA LUOKAN 2 NÄKYVÄÄ JA NÄKYMÄTÖNTÄ LASERITÄYLLÄ. ÄLÄ TUIJOTA SÄTEESEEN.
<b>VARNING</b> – KLASS 2 SYNLIG OG USYNLIG LASERSTRÅLING NÄR DENNA DEL ÄR ÖPPNAD. STIRRA EJ IN I STRÅLEN.
<b>VORSICHT</b> – SICHTBARE UND UNSICHTBARE LASERSTRAHLUNG KLASSE 2. WENN ABDECKUNG GEÖFFNET, NICHT IN DEN STRAHL BLICKEIN.
<b>注意</b> – 打开时有可见及不可见激光辐射。避免光束照射。
<b>注意</b> – ここを開くとクラス2の可視及び不可視レーザー放射が出る。ビームをのぞき込まないこと。 VQLZP54

(Inside of product)

# Table of contents

## IMPORTANT SAFETY

INSTRUCTIONS . . . . .	2
Precautions . . . . .	3

## Getting started

Accessories . . . . .	5
Unit and media care . . . . .	5
Playable media . . . . .	6
Control reference guide . . . . .	8

## Connections & Settings

Connecting to a TV . . . . .	10
Connecting to an amplifier/receiver . . . . .	11
Connecting to the network . . . . .	13
Settings . . . . .	14

## Playback

Inserting or removing media . . . . .	17
HOME menu . . . . .	18
Multi User Mode . . . . .	19
Playback . . . . .	20
VIERA Connect (Enjoying Netflix, etc.) . . . . .	23
Home Network feature . . . . .	24
“HDMI CEC” . . . . .	26

## Settings

Option menu . . . . .	27
Setup menu . . . . .	29

## Reference

Troubleshooting guide . . . . .	35
Messages . . . . .	38
Specifications . . . . .	40
Limited Warranty . . . . .	45, 46
Referencia rápida en español (Spanish Quick Reference) . . . . .	47
Index . . . . .	Back cover

# Accessories

Check the supplied accessories before using this unit.

- 1 **Remote control**  
(N2QAYB000874)
- 2 **Batteries for remote control**
- 1 **AC power supply cord**  
(K2CB2CB00022)

## For Canada

The enclosed Canadian French label sheet corresponds to the English display on the unit.



- Product numbers provided in this Owner's Manual correct as of December 2012. These may be subject to change.
- Do not use AC power supply cord with other equipment.

## Using the remote control

Insert so the poles (+ and -) match those in the remote control.

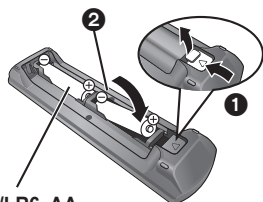

R6/LR6, AA  
(Alkaline or manganese batteries)

Point it at the remote control signal sensor on this unit. (⇒ 9)

# Unit and media care

## Clean this unit with a soft, dry cloth

- Never use alcohol, paint thinner or benzene to clean this unit.
- Before using chemically treated cloth, carefully read the instructions that came with the cloth.

## This unit's lens

Use the lens cleaner (not supplied) to clean the unit's lens.

## Clean discs

DO

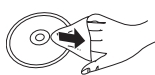

DO NOT









Wipe with a damp cloth and then wipe dry.

## Disc and card handling precautions

- Handle discs by the edges to avoid inadvertent scratches or fingerprints on the disc.
- Do not attach labels or stickers to discs.
- Do not use disc cleaning sprays, benzene, thinner, static electricity prevention liquids or any other solvent.
- Clean any dust, water, or foreign matter from the terminals on the rear side of the card.
- Do not use the following discs:
  - Discs with exposed adhesive from removed stickers or labels (rented discs, etc.).
  - Discs that are badly warped or cracked.
  - Irregularly shaped discs, such as heart shapes.

# Playable media

Device	Media markings	Device types	Contents format
BD		BD-Video	Video
		BD-RE	Video, JPEG, MPO
		BD-R	Video, MKV, Xvid <b>BDT330 for Canada</b>
DVD		DVD-Video	Video
		DVD-R	Video, AVCHD, MKV, Xvid <b>BDT330 for Canada</b> , JPEG, MPO, AAC, FLAC, MP3, WAV, WMA
		DVD-R DL	
		DVD-RW	Video, AVCHD
	—	+R/+RW/+R DL	
CD		Music CD	Music [CD-DA]
	—	CD-R CD-RW	MKV, Xvid <b>BDT330 for Canada</b> , JPEG, MPO AAC, FLAC, MP3, Music [CD-DA], WAV, WMA
SD		SD Memory Card (from 8 MB to 2 GB) SDHC Memory Card (from 4 GB to 32 GB) SDXC Memory Card (48 GB, 64 GB) (Compatible with both mini and micro types)	AVCHD, AVCHD 3D, MP4, JPEG, MPO
USB	—	USB devices (up to 2 TB)	MKV, MP4, MPEG2, Xvid <b>BDT330 for Canada</b> , JPEG, MPO, AAC, FLAC, MP3, WAV, WMA

• See pages 7 and 40 for more information on the types of content that can be played.

## ■ Discs that cannot be played in this unit

Any other disc that is not specifically supported or previously described.

- DVD-RAM
- Super Audio CD
- Photo CD
- DVD-Audio
- Video CD and Super Video CD
- HD DVD

## ■ Region management information

### BD-Video

This unit can play BD-Video discs supporting the region code "A".

Example:



### DVD-Video

This unit can play DVD-Video discs supporting the region number "1" or "ALL".

Example:



## ■ Finalize

DVD-R/RW/R DL, +R/+RW/+R DL and CD-R/RW recorded by a recorder needs to be finalized by the recorder to play on this unit. Please refer to the recorder's instructions.

## ■ BD-Video

- This unit supports high bit rate audio (Dolby® Digital Plus, Dolby® TrueHD, DTS-HD High Resolution Audio and DTS-HD Master Audio) adopted in BD-Video.
- **BDT230** **BDT225** : If "Dolby D/Dolby D +/Dolby TrueHD" is set to "PCM" and "DTS Neo:6" is set to "Off", the maximum possible number of Dolby® sound is 5.1ch PCM. (⇒ 30, 31)

## ■ 3D

- 3D videos and 3D still pictures can be played back when this unit is connected to a 3D compatible TV using a High Speed HDMI Cable.
- 2D video can be enjoyed as 3D virtually. (⇒ 28)

## ■ Music CD

- Operation and sound quality of CDs that do not conform to CD-DA specifications (copy control CDs, etc.) cannot be guaranteed.
- The digital audio content side of a DualDisc does not meet the technical specifications of the Compact Disc Digital Audio (CD-DA) format so playback may not be possible.

## ■ SD card

- miniSD Cards, microSD Cards, microSDHC Cards and microSDXC Cards can be used, but must be used with an adaptor card. These are usually supplied with such cards, or otherwise customer provided.
- To protect the card's contents, move the record prevention tab (on the SD card) to "LOCK".
- This unit is compatible with SD Memory Cards that meet SD Card Specifications FAT12 and FAT16 formats, as well as SDHC Memory Cards in FAT32 format and SDXC Memory Cards in exFAT.
- If the SD card is used with incompatible computers or devices, recorded contents may be erased due to the card being formatted etc.
- Usable memory may be slightly less than the card capacity.



## ■ USB device

- This unit does not guarantee connection with all USB devices.
- This unit does not support USB device charging.
- FAT12, FAT16, FAT32, and NTFS file systems are supported.
- This unit supports USB2.0 High Speed.
- This unit supports an HDD formatted in FAT32 and NTFS. If the HDD is not recognized, the power to the HDD may not be supplied. Supply power from an external source.



- It may not be possible to play the above media in some cases due to the type of media, the condition of the recording, the recording method, and how the files were created.
- The producers of the disc can control how discs are played, so you may not always be able to control play as described in this Owner's Manual. Read the disc's instructions carefully.

# Control reference guide

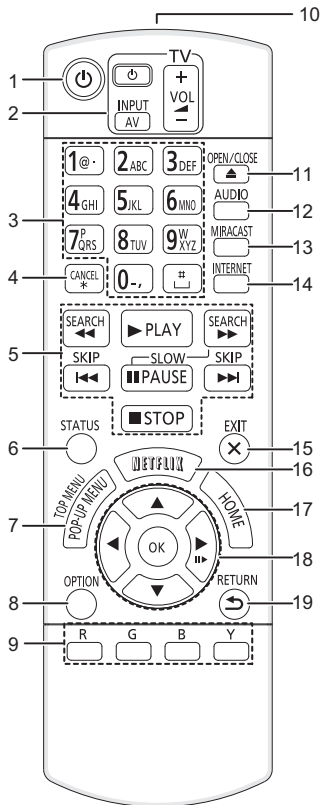

- 1 Turn the unit on and off
- 2 TV operation buttons  
You can operate the Panasonic TV using the unit's remote control. Some buttons may not work depending on the TV.  
[TV] : Turn the TV on and off  
[AV] : Change input  
[+ - VOL] : Adjust the volume
- 3 Select title numbers, etc./Enter numbers or characters
- 4 Cancel
- 5 Basic playback control buttons (⇒ 20)
- 6 Show status messages (⇒ 21)
- 7 Show Pop-up menu/Top menu (⇒ 21)
- 8 Show Option menu (⇒ 27)
- 9 Colored buttons (red, green, blue, yellow)  
Used for various purposes depending on the display.
- 10 Transmit the remote control signal
- 11 Open or close the disc tray (⇒ 17)
- 12 Select audio (⇒ 20)
- 13 Show Miracast™ screen (⇒ 24)
- 14 Show the Home screen of the VIERA Connect (⇒ 23)
- 15 Exit the menu screen
- 16 Show Netflix screen (⇒ 23)
- 17 Show HOME menu (⇒ 18)
- 18 [▲, ▼, ◀, ▶] : Move the highlight for selection  
[OK] : Confirm the selection  
[■▶▶] : Frame-by-frame (⇒ 20)
- 19 Return to previous screen

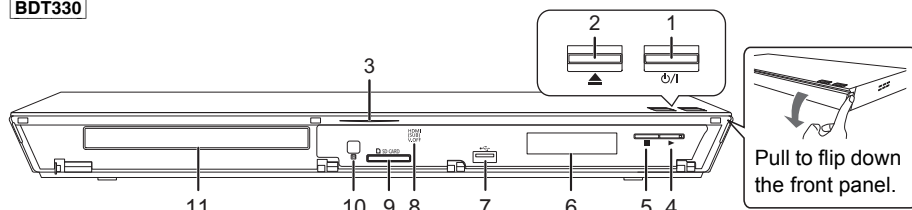

**BDT330**

- 1 **Standby/on switch (I/O)** (⇒ 14)  
Press to switch the unit from on to standby mode or vice versa. In standby mode, the unit still consumes a small amount of power.
  - 2 Open or close the disc tray (⇒ 17)
  - 3 Blue LED  
It is possible to set the LED to turn on/off. (⇒ 34)
  - 4 Start play (⇒ 20)
  - 5 Stop (⇒ 20)
  - 6 Display
  - 7 USB port (⇒ 17)
  - 8 V.OFF LED (Video off LED)  
It is possible to set the LED to turn on/off. (⇒ 34)
  - 9 SD card slot (⇒ 17)
  - 10 Remote control signal sensor  
Distance: Within approx. 7 m (23 feet)  
Angle: Approx. 20° up and down, 30° left and right
  - 11 Disc tray (⇒ 17)
- Rear panel terminals (⇒ 10–13)

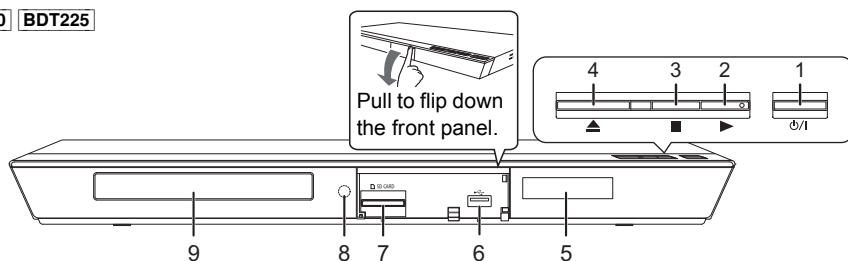
**BDT230 BDT225**

- 1 **Standby/on switch (I/O)** (⇒ 14)  
Press to switch the unit from on to standby mode or vice versa. In standby mode, the unit still consumes a small amount of power.
  - 2 Start play (⇒ 20)
  - 3 Stop (⇒ 20)
  - 4 Open or close the disc tray (⇒ 17)
  - 5 Display
  - 6 USB port (⇒ 17)
  - 7 SD card slot (⇒ 17)
  - 8 Remote control signal sensor  
Distance: Within approx. 7 m (23 feet)  
Angle: Approx. 20° up and down, 30° left and right
  - 9 Disc tray (⇒ 17)
- Rear panel terminals (⇒ 10–13)

# Connecting to a TV

Connect the power supply cord after making all connections.

- Before making any connections, we recommend that you temporarily disconnect all the units from AC power.
- Use the High Speed HDMI cables. Non-HDMI-compliant cables cannot be utilized. It is recommended that you use Panasonic's HDMI cable. When outputting 1080p signal, please use HDMI cables 5.0 meters (16.4 ft.) or less.

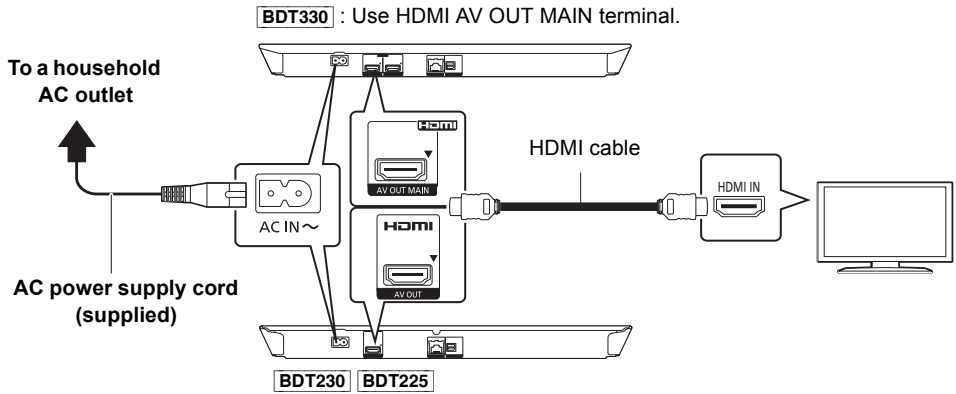

- This unit consumes a small amount of AC power ( $\Rightarrow$  40) even when turned off. For the purpose of power conservation, the unit can be disconnected if you will not be using it for extended period of time.

# Connecting to an amplifier/receiver

Perform either one of the following connections in accordance with your amplifier/receiver input terminal.

## HDMI AV OUT

**BDT330** : Use HDMI AV OUT MAIN terminal.

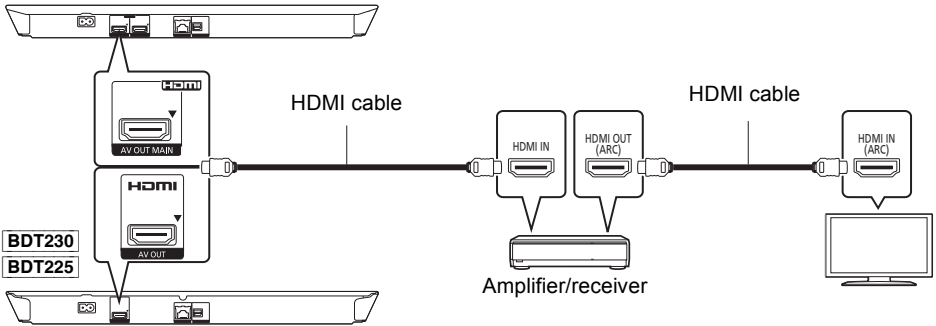

- Set "Digital Audio Output" (⇒ 30).
- When connecting to a non-3D compatible amplifier/receiver, connect this unit to a TV, then connect the TV and the amplifier/receiver. Please note, however, that the audio can only be up to 5.1ch.
- When using the TV or amplifier/receiver that does not have the indication of "(ARC)" (non-ARC-compatible) on the HDMI terminal, the amplifier/receiver and TV must also be connected using an optical digital cable in order to enjoy the TV's sound through the amplifier/receiver.

## HDMI AV OUT SUB **BDT330**

You can enjoy richer sound by using the HDMI AV OUT SUB terminal.

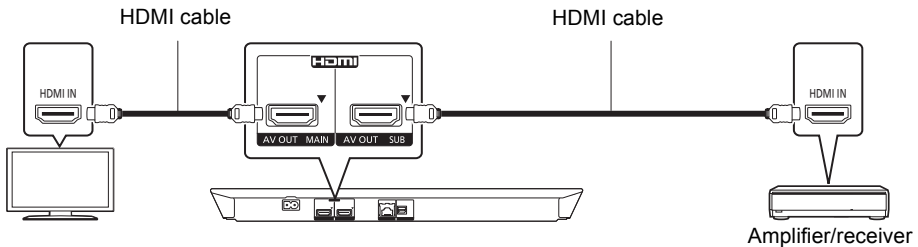

- Set "HDMI(SUB) Output Mode" to "V.OFF". (⇒ 30)
  - Audio is output in high resolution regardless of compatibility of the amplifier/receiver with 3D.
- It is possible to play back 3D videos and 3D still pictures when the connected TV is 3D compatible, even if the amplifier/receiver is not 3D compatible.
- The HDMI connection using HDMI AV OUT MAIN supports HDMI CEC (⇒ 26).  
The HDMI AV OUT SUB terminal is not compatible with the HDMI CEC.

## OPTICAL

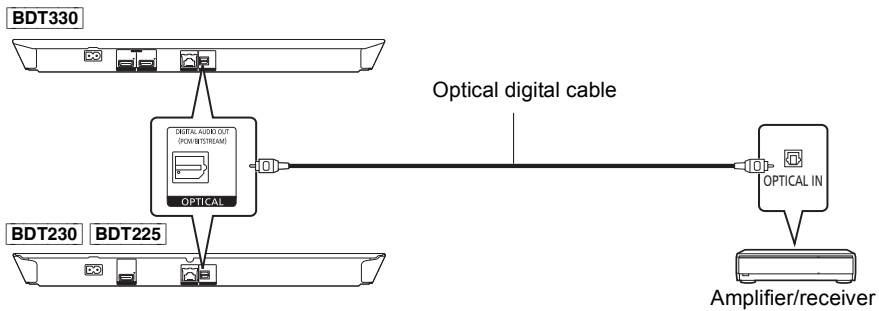

- Set "HDMI Audio Output" to "Off" (⇒ 30).
- Set "Digital Audio Output" (⇒ 30).

# Connecting to the network

The following services can be used when this unit is connected to broadband.

- Firmware can be updated (⇒ 16)
- You can enjoy BD-Live (⇒ 22)
- You can enjoy VIERA Connect (⇒ 23)
- You can access other devices (Home Network) (⇒ 24)
- This unit supports Wi-Fi Direct™ and can make a wireless connection to wireless devices without router. You can use this function when enjoying Home Network feature, etc. Internet access is not available while connected via Wi-Fi Direct™. (⇒ 24, 32)

For details about connection method, refer to the instructions supplied with the connected equipment.

## Wireless LAN connection

This unit has built-in Wi-Fi® and can be connected to a wireless router.



- For up-to-date compatibility information on your wireless router, refer to <http://panasonic.jp/support/global/cs/> (This site is in English only.)  
For additional information about this unit refer to <http://www.panasonic.com/help> (For U.S.A.)
- The unit is not compatible with public wireless LAN services provided in airports, stations, cafes, etc.
- See page 3 for the precautions for wireless LAN connection.

## LAN cable connection

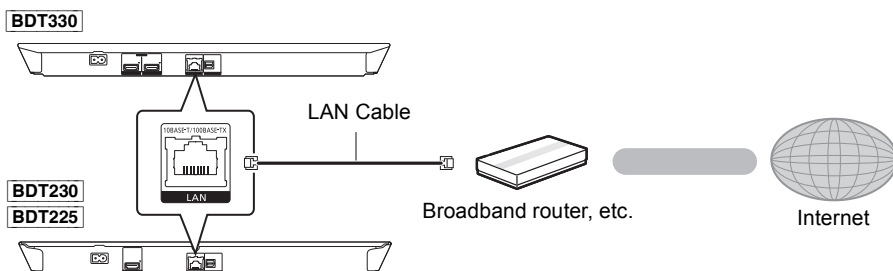

- Use category 5 or above straight LAN cables (STP) when connecting to peripheral devices.
- Inserting any cable other than a LAN cable in the LAN port can damage the unit.

# Settings

## Easy Settings

After connecting your new player for the first time and pressing [⏻], the basic settings screen will appear.

### Preparation

Turn on the TV and select the appropriate video input.

**1** Press [⏻].  
Setup screen appears.

**2** Follow the on-screen instructions to continue with the settings.



- You can perform this setup anytime by selecting "Easy Settings" in the Setup menu. (⇒ 33)

## Easy Network Setting

After completing "Easy Settings", you can perform "Easy Network Setting".

### Wired connection

Select "Wired" and press [OK].

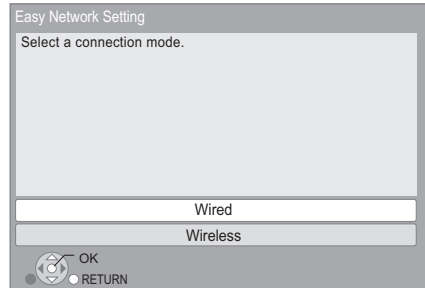

Follow the on-screen instructions to establish your connection settings.

### Wireless connection

**1** Select "Wireless" and press [OK].

**2** Select "Search for wireless network" or "WPS (PUSH button method)" and press [OK], then follow the on-screen instructions to continue with the settings.

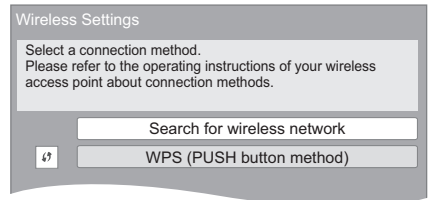

### ■ "WPS (PUSH button method)"

If you are using a wireless router that supports WPS (Wi-Fi Protected Setup™), you can easily perform the settings.

## ■ “Search for wireless network”

The available wireless networks will be displayed.

### To obtain your network name (SSID)\* and encryption key (password).

The default settings may be printed on the router. If the SSID and password have been changed, consult the person responsible for setting up your network.

e.g.

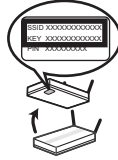

For more details, refer to the manual supplied with the wireless broadband router, or contact your Internet provider.

**For more information or assistance, refer to <http://www.panasonic.com/help> (U.S. customers only)**

- ① Select your network name and press [OK].
  - If your network name is not displayed, search again by pressing the red button on the remote control. Stealth SSID will not be displayed; in this case, enter manually.

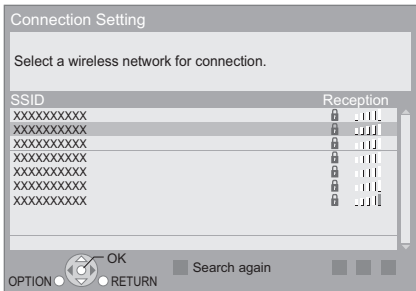

## When your wireless network is encrypted

- ② Press [OK] to select “Encryption Key”.

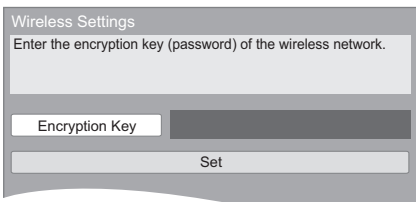

- ③ Enter your encryption key (password).
  - You can switch between capital and lower case letters by pressing the “Shift” key.



## To enter your network name (SSID) manually

If your network name (SSID) is not displayed in step ①, follow these steps.

- 1 To display the network name (SSID) input screen :
  - Press [HOME]
  - ⇒ press [OK] to select “Setup”
  - ⇒ select “Player Settings”
  - ⇒ select “Network” and press [OK]
  - ⇒ select “Network Settings” and press [OK]
  - ⇒ select “Wireless Settings” and press [OK]
  - ⇒ select “Connection Setting” and press [OK]
  - ⇒ select “Manual setting” and press [OK]
- 2 Press [OK] to select “SSID” and enter your SSID.

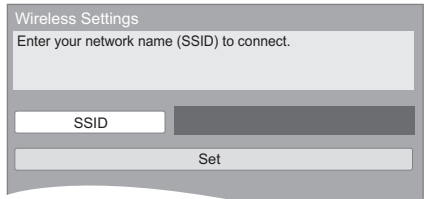

- If your wireless network is encrypted, go to step ②.



- Refer to the operating instructions of the hub or router.
- WPS (Wi-Fi Protected Setup) is a standard that facilitates settings relating to the connection and security of wireless LAN devices. To see whether your wireless router supports WPS, check the wireless router operating instructions.
- You can perform this setup anytime by selecting "Easy Network Setting" in the Setup menu. (⇒ 32)
- You can redo these settings individually using "Network Settings". (⇒ 32)
- Do not use this unit to connect to any wireless network for which you do not have usage rights.  
During automatic searches in a wireless network environment, wireless networks (SSID) for which you do not have usage rights may be displayed; however, using these networks may be regarded as illegal access.
- After performing network settings on this unit, the settings (encryption level, etc.) of the wireless router might change. When you have trouble getting online on your PC, perform the network settings on your PC in accordance with the settings of wireless router.
- Please be aware that connecting to a network without encryption may result in the content of the communication being illegitimately viewed by a third party, or the leaking of data such as personal or secret information.

\* SSID:

An SSID (Service Set Identification) is a name used by wireless LAN to identify a particular network.  
Transmission is possible if the SSID matches for both devices.

## Reprogramming the remote control

If you have more than one Panasonic player/recorder and the remote control operates both products at once, you will need to change the remote control code to prevent this occurrence.  
(⇒ 34, "Remote Control Code")

## Firmware updates

Occasionally, Panasonic may release updated firmware for this unit that may add or improve the way a feature operates. These updates are available free of charge.

This unit is capable of checking the firmware automatically when connected to the Internet via a broadband connection.

When a new firmware version is available, the following message is displayed.

New firmware is available.  
Please update firmware in Setup.

To update the firmware

**Press [HOME]**

⇒ **press [OK] to select "Setup"**

⇒ **select "Player Settings"**

⇒ **select "System" and press [OK]**

⇒ **select "Firmware Update" and press [OK]**

⇒ **select "Update Now" and press [OK]**

**DO NOT DISCONNECT** the unit from the AC power or perform any operation while the update takes place.

After the firmware is installed, "FIN" will be displayed on the unit's display. Unit will restart and the following screen will be displayed.

The firmware was updated.  
Current Version: X.XX

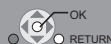

- **If downloading on this unit fails or this unit is not connected to the Internet, then you can download the latest firmware from the following website and burn it to a CD-R to update the firmware.**  
<http://panasonic.jp/support/global/cs/>  
(This site is in English only.)  
To show the firmware version on this unit.  
(⇒ 34, "Firmware Version Information")
- **Downloading will require several minutes. It may take longer or may not work properly depending on the connection environment.**
- **If you do not want to check for the latest firmware version, set "Automatic Update Check" to "Off". (⇒ 34)**



# Inserting or removing media

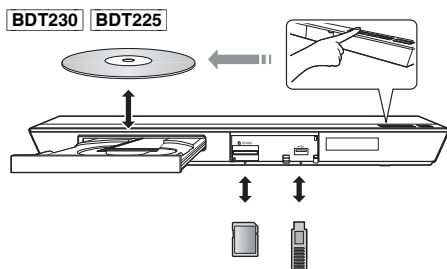
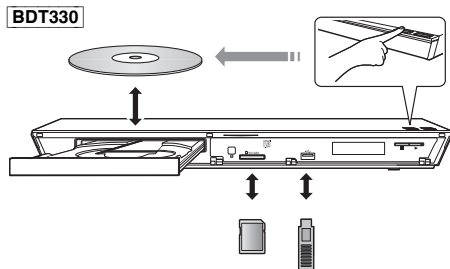

## Notes

- When inserting a media item, ensure that it is facing the right way up.
- When removing the SD card, press the center of the card and pull it straight out.
- If you connect a Panasonic product with a USB connection cable, the setup screen may be displayed on the connected equipment. For details, refer to the instructions for the connected equipment.

## CAUTION

Do not place objects in front of the unit. The disc tray may collide with objects when it is opened, and this may cause malfunction.

# HOME menu

Major functions of this unit can be operated from the HOME menu.

## Preparation

Turn on the TV and select the appropriate video input on the TV.

### 1 Press [POWER] to turn on the unit.

- After network service introduction banner is shown, the HOME menu is displayed.
  - When connected to the network, the banner content may be changed.
  - You can disable the “Start-up Banner” (⇒ 34).

### 2 Press [OK] or [▲, ▼, ◀, ▶] to select the item.

- If there are any other items, repeat this step.

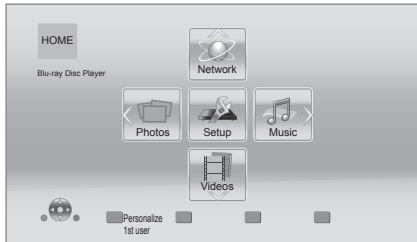

## Videos/Photos/Music

<b>Disc</b>	Play back the contents. (⇒ 20)
<b>USB</b>	• When multiple contents are recorded, select the types of contents or the title.
<b>SD Card</b>	

## Network

<b>Network Service</b>	Displays the Home screen of VIERA Connect. (⇒ 23)
<b>Home Network</b>	<b>DLNA Client</b> (⇒ 24)
	<b>Miracast</b> (⇒ 24)
	<b>Media Renderer</b> (⇒ 25)

## Setup

<b>Player Settings</b>	(⇒ 29)
<b>USB Management</b>	(⇒ 22)
<b>Wallpaper</b>	Changes the background of HOME menu.

## To show the HOME menu

Press [HOME].



- Items to be displayed may vary with the media.
- Where necessary, set “Mixed Data Disc Option” when using a disc with both data files (MP3, JPEG, MKV, etc.) and Video (BD-RE and AVCHD). (⇒ 34)

# Multi User Mode

Multi User Mode allows individuals to customize settings and switch to their saved settings easily. Up to 4 people can use the unit with their own settings.

The following settings can be personalized:

- The user icon
- The wallpaper of HOME menu
- The audio and picture settings (⇒ 27, 29)

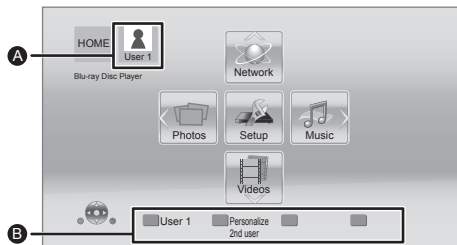

- A The user name and icon currently selected
- B Personalize a new user and switch between users with colored buttons.

## Personalizing a new user

- 1 Press [HOME].
- 2 Press the colored button that indicates new user personalization.
- 3 Select an item and change the settings according to the indications.

The following items can be set.

<b>Input Nickname</b>	Personalize a user name.
<b>Select Icon</b>	Personalize a user icon. <b>Select from Illustrations</b> The image can be selected from prepared illustrations. <b>Create from Photos</b> You can select a photo in recording media as an icon. (⇒ 27, "Icon Personalization")
<b>Select Wallpaper</b>	Personalize a background of the HOME menu. <ul style="list-style-type: none"><li>• In addition to default wallpapers, you can select a photo in recording media as a wallpaper. (⇒ 27, "Wallpaper")</li></ul>

- 4 Select "Confirm" and press [OK].

**To change the personalized user information**  
Select "Edit User Information" from Setup menu. (⇒ 34)

## Switching the user

Press the colored buttons in the HOME menu to switch to the user corresponding to the button.

# Playback

## 1 Insert the media.

Playback starts depending on the media.

## 2 Select the item to play and press [OK].

Repeat this procedure if necessary.



- DISCS CONTINUE TO ROTATE WHILE MENUS ARE DISPLAYED. Press [■STOP] when you have finished playback to protect the unit's motor, your TV screen and so on.
- MKV/Xvid **BDT330 for Canada**: Successive play is not possible.
- It is not possible to play back AVCHD and MPEG2 videos which have been dragged and dropped or copied and pasted to the media.
- To save on electricity, this unit is turned off automatically if there is no button operation for about 30 minutes when not playing back (such as when paused or displaying the menu, displaying still pictures, etc.). (Compatible with ENERGY STAR)

## Operations during playback

The following functions may not work depending on the media and contents.

### Stop

Press [■STOP].

The stopping point is memorized.

**Resume play function**

Press [▶PLAY] to restart from this point.

- The point is cleared if the media is removed.
- **On BD-Video discs including BD-J, the resume play function does not work.**

### Pause

Press [⏸PAUSE].

- Press [⏸PAUSE] again or [▶PLAY] to restart play.

### Search/Slow motion

**Search**

While playing, press [SEARCH◀◀] or [SEARCH▶▶].

**Slow motion**

While paused, press [SEARCH▶▶].

The speed increases up to 5 steps.

- Music, MP3, etc.: The speed is fixed to a single step.
- Press [▶PLAY] to revert to normal playback speed.

### Skip

While playing or paused, press [◀◀] or [▶▶].

Skip to the title, chapter or track.

### Frame-by-frame

While paused, press [▶] (⏪▶).

- Press and hold to change in succession forward.
- Press [▶PLAY] to revert to normal playback speed.

### Changing audio

Press [AUDIO].

You can change the audio channel number or soundtrack language, etc.

## Displaying menus and playback information

### Show top menu/pop-up menu

Press [POP-UP MENU/TOP MENU].

- Select the item and press [OK].

### Show the status messages

While playing, press [STATUS].

The status messages give you information about what is currently being played. Each time you press [STATUS], the display information may change or will disappear from the screen.

- Depending on media and contents, the display may change or may not appear.

e.g., BD-Video



- A** T: Title, C: Chapter, PL: Playlist
- B** Elapsed time in the title
- C** Current position
- D** Total time

e.g., JPEG



## Enjoying 3D video and photos

### Preparation

Connect this unit to a 3D compatible TV.

(⇒ 10, 11)

- Perform the necessary preparations for the TV.
- Play back following the instructions displayed on the screen.
- 3D Settings (⇒ 28, 31)



- Please refrain from viewing 3D images if you do not feel well or are experiencing visual fatigue. In the event that you experience dizziness, nausea, or other discomfort while viewing 3D images, discontinue use and rest your eyes.
- 3D video might not output the way it is set in "HDMI Resolution" and "24p(4K)/24p Output" [BDT330]/"24p Output" [BDT230] [BDT225]. (⇒ 29, 30)
- When playing back 3D photos from "Photos" screen, select from the "3D" list. (Still pictures in "2D" are played back in 2D.)  
If "2D" and "3D" indications are not displayed, press the red button on the remote control to switch the view of playback contents.

## Enjoying BD-Live

With "BD-Live" discs, you can enjoy bonus contents that use Internet access.

For this BD-Live function, connection of a USB device is necessary along with Internet connection.

- 1 Perform network connection and settings.**  
(⇒ 13, 14)
- 2 Connect a USB device with 1 GB or more free space.**
  - The USB device is used as the local storage.
- 3 Insert the disc.**

### ■ Deleting data on the USB device

Select "USB Management" in the HOME menu (⇒ 18), then select "BD-Video Data Erase" and press [OK].



- The usable functions and the operating method may vary with each disc, please refer to the instructions on the disc and/or visit their website.
- "BD-Live Internet Access" may need to be changed for certain discs (⇒ 33).

## Slideshow

Play a slideshow of photos and adjust various settings during the playback.

- 1 Insert the media.**
- 2 Select "Photos".**
- 3 Select an item and press the green button.**  
The following items can be set.

<b>Start Slideshow</b>	Start the slideshow. You can display still pictures in the selected folder one by one at a constant interval.
<b>Display Interval</b>	Change the display interval.
<b>Transition Effect</b>	Select the effect when sliding pictures.
<b>Repeat Play</b>	Set whether to repeat the slideshow.



- Still pictures displayed as "" cannot be played back with this unit.

# VIERA Connect (Enjoying Netflix, etc.)

VIERA Connect allows you to access some specific websites supported by Panasonic, and enjoy Internet contents such as photos, videos, etc. from VIERA Connect Home screen.

- Some services such as Netflix require a registered account.

For details of your Netflix account, refer to Netflix.

**VIERA Connect provides a variety of selected Internet services such as the following.**

- Online movie rental service
- Video browsing service

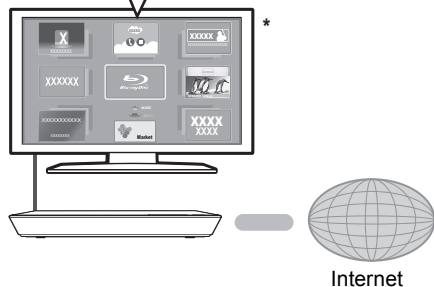

\* Images are for illustration purposes, contents may change without notice.

## Preparation

- Network connection (⇒ 13)
- Network setting (⇒ 14)

## 1 Press [INTERNET].

- Netflix can be accessed directly by pressing [NETFLIX] button.

## 2 Select the item and press [OK].

### To exit from VIERA Connect

Press [HOME].



- When playing content in the media, VIERA Connect cannot be accessed by pressing [INTERNET].
- In the following cases, settings are possible using the Setup menu items.
  - When restricting the use of VIERA Connect (⇒ 33, "Network Service Lock")
  - When correcting the displayed time (⇒ 32, "Time Zone", "DST")
- If using slow Internet connection, the video may not be displayed correctly. A high speed Internet service with a speed of at least 6 Mbps is recommended.
- Be sure to update the firmware when a firmware update notice is displayed on the screen. If the firmware is not updated, you may not be able to use VIERA Connect function properly. (⇒ 16)
- VIERA Connect Home screen is subject to change without notice.
- The services through VIERA Connect are operated by their respective service providers, and service may be discontinued either temporarily or permanently without notice. Therefore, Panasonic will make no warranty for the content or the continuity of the services.
- Some features of websites or content of the service may not be available.
- Some content may be inappropriate for some viewers.
- Some content may only be available for specific countries and may be presented in specific languages.

# Home Network feature

## Using Miracast™

You can enjoy the content you are viewing on a Miracast-compatible smartphone, etc. on the big screen of your TV.

- Compatible with Android™ devices, ver. 4.2 and above and Miracast certified.

For information on whether the smartphone, etc. supports Miracast, contact the manufacturer of the device.

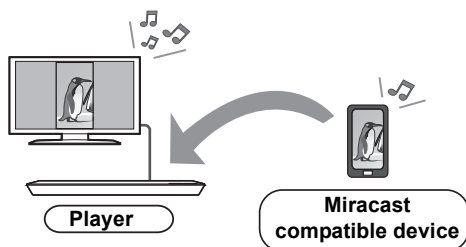

**1** Press [MIRACAST].

**2** Operate the Miracast compatible device.

- On the device, enable Miracast and select this unit (DMP-BDT330, DMP-BDT230 or DMP-BDT225) as the device to be connected.

For details, refer to the instructions supplied with the device.

### To exit from Miracast

Press [HOME].

## Playing back contents on the DLNA server

You can share photos, videos and music stored in the DLNA Certified media server (PC with Windows 7 installed, smartphone, etc.) connected to your home network, and enjoy the contents with this player.

- **About support format of DLNA (⇒ 41).**
- **Before using the DLNA feature, be sure to configure the DLNA server on your Home Network.**

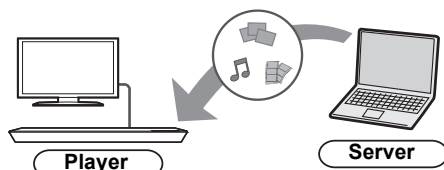

### Preparation

- ① Perform network connection (⇒ 13) and network settings (⇒ 14) of this unit.
- ② Perform Home Network settings of the connected equipment.
- ③ Add the contents and folder to the libraries of the Windows Media® Player or the smartphone, etc.
  - Playlist of Windows Media® Player can play back only the contents that are stored in the libraries.

**1** Press [HOME].

**2** Select “Network”.

**3** Select “Home Network”.

**4** Select “DLNA Client”.

- The list can be updated by pressing the red button on the remote control.
- The connection method can be switched to Wi-Fi Direct by pressing the green button on the remote control.

**5** Select the equipment and press [OK].

**6** Select the item to play and press [OK].

- You may be able to use convenient functions depending on the content by pressing [OPTION].

- Control Panel is displayed once the playback starts. Press [OK] if the Control Panel is not displayed, and press [RETURN] to hide the Control Panel.

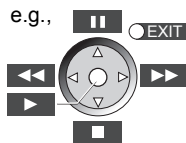

### To exit from Home Network

Press [HOME].



## Using the Digital Media Controller

You can use a smartphone or tablet as the Digital Media Controller (DMC) to play back contents from DLNA server on the Renderer (this unit).

**Possible applications:**

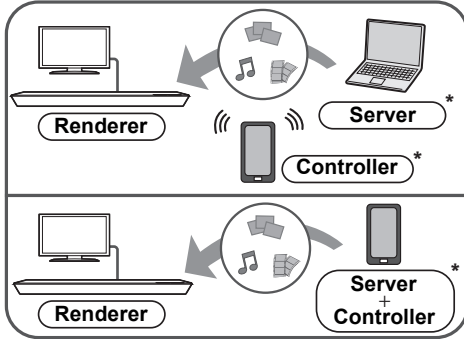

\* DMC compatible software should be installed.

### Preparation

Perform steps ① to ③. (⇒ 24)

- ④ Perform the "Remote Device Settings".  
(⇒ 32)
- You can register up to 16 devices.

- 1 Press [HOME].
- 2 Select "Network".
- 3 Select "Home Network".
- 4 Select "Media Renderer".
- 5 Select "Home Network" or "Wi-Fi Direct" and press [OK], then follow the indications on the screen.
- 6 Operate the DMC compatible devices.

To exit from Media Renderer screen

Press [HOME].



### About DLNA and Media renderer

For more details, refer to the following website and the operating instructions for each of the equipment.

<http://panasonic.jp/support/global/cs/>  
(This site is in English only.)

- Wi-Fi Direct connection while using Home Network feature is only temporary, and the network connection method returns to the original setting when exiting.
- Depending on the device or connection environment, the data transfer rate may decrease.
- Depending on the contents and the connected equipment, playback may not be possible.
- Items displayed in gray on the display cannot be played back by this unit.
- This unit can be played back via connected equipment only when controlled using DMC.

## “HDMI CEC”

This unit supports “HDMI CEC” (Consumer Electronics Control) function.

You can use this function by connecting the equipment with an HDMI cable\*. See the operating instructions for connected equipment for operational details.

\* **[BDT330]** : Only when connecting via an HDMI AV OUT MAIN terminal on this unit.

### Preparation

- ① Set “HDMI CEC” to “On” (⇒ 34). (The default setting is “On”.)
- ② Set the “HDMI CEC” operations on the connected equipment (e.g., TV).
- ③ Turn on all “HDMI CEC” compatible equipment and select this unit’s input channel on the connected TV so that the “HDMI CEC” function works properly.

**Repeat this procedure when the connections or settings are changed.**

## Automatic input switching Power on link

When play starts on the unit, the TV will automatically switch the input channel and the screen of this unit will be displayed.

Additionally when the TV is off, the TV will automatically turn on.

- **[BDT330]** : When “HDMI(SUB) Output Mode” (⇒ 30) is set to “Normal” and the power of the device connected to the HDMI AV OUT SUB is turned on, the Power on link to the device connected to the HDMI AV OUT MAIN will not work.

## Power off link

All connected equipment compatible with “HDMI CEC”, including this unit, automatically turns off when you switch the TV off.



- Operation cannot be guaranteed on all HDMI CEC devices.

# Option menu

A variety of playback operations and settings can be performed from this menu.

Available options differ depending on the playing contents and the condition of the unit.

## About Multi User Mode

 : Settings of the items with this indication are saved by the respective users registered in the HOME menu.

Please refer to page 19 for details about user registration and switching.

## 1 Press [OPTION].

- When playing music, select “Playback Settings” and press [OK].

e.g., BD-Video

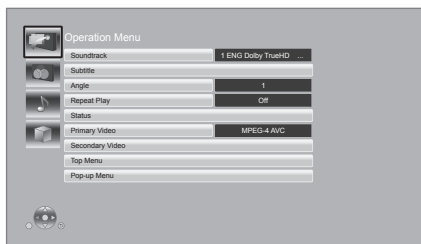

## 2 Select an item and change the settings.

### To exit the screen

Press [OPTION].

Regarding Language : (⇒ 42)

## Operation Menu

### ■ Soundtrack

Show or change the soundtrack.

### ■ Audio channel

Select the audio channel number.

### ■ Subtitle

Change the subtitle settings.

### ■ Angle

Select the number of the angle.

### ■ Repeat Play

Select the item that you want to repeat.

- The items displayed differ depending on the type of media.
- Select “Off” to cancel.

### ■ Shuffle

Select whether or not to play random.

### ■ Start Slideshow

Start the slideshow.

### ■ Status

Show the status messages.

### ■ Rotate Right

### ■ Rotate Left

Rotate the still picture.

### ■ Wallpaper

Set the still picture to the wallpaper of HOME menu. (⇒ 18)

### ■ Icon Personalization

Set the still picture as your user icon. (⇒ 19)

### ■ Video

The recording method of original video appears.

### ■ Primary Video

The recording method of original primary video appears.

## ■ Secondary Video

<b>Video</b>	Select on/off for images. The recording method of original video appears. <ul style="list-style-type: none"><li>• During search/slow motion or frame-by-frame, only the primary video is displayed.</li></ul>
<b>Soundtrack</b>	Select on/off for audio and the language.

## ■ Top Menu

Display Top Menu.

## ■ Pop-up Menu

Display Pop-up Menu.

## ■ Menu

Display Menu.

## Video Settings

### ■ Picture Mode

Select the picture quality mode during play.

- If you select "User", you can change settings in "Picture Adjustment".

### ■ Picture Adjustment

Specific picture quality settings can be changed.

### ■ Progressive

Select the method of conversion for progressive output to suit the type of material being played.

- When the content is distorted, change the settings from "Auto" to "Video".

### ■ 24p

Movies and other material recorded on DVD-Video at 24p are output at 24p.

This works only in the following cases:

- **BDT330**: "24p(4K)/24p Output" is set to "24p(4K)" or "24p" (⇒ 29).
- **BDT230** **BDT225**: "24p Output" is set to "On" (⇒ 30).

### ■ Reset to Default Video Settings

Return video settings to the factory preset.

## Audio Settings

### ■ Dialog Enhancer

The volume of the center channel is raised to make dialog easier to hear.

- This function is effective for audio from the HDMI terminal or the OPTICAL terminal only when "Digital Audio Output" is set to "PCM" (⇒ 30). (However, in this case, audio is output as 2ch from the OPTICAL terminal.)

## 3D Settings

### ■ Signal Format

<b>Original</b>	Keep original picture format.
<b>Side by side</b>	3D picture format comprising of left and right screens.
<b>2D to 3D</b>	Converts 2D pictures to 3D effect.

### ■ Distance

Set the amount of depth perception.

### ■ Pop-Out Level

3D position for the Option menu or message screen, etc. can be adjusted during 3D playback.

# Setup menu

Change the unit's settings if necessary. The settings remain intact even if you switch the unit to standby. Some items in the Setup menu are common to the Option menu. You can get the same effect with both menus.

## About Multi User Mode

 : Settings of the items with this indication are saved by the respective users registered in the HOME menu. Please refer to page 19 for details about user registration and switching.

- 1 Press [HOME].
- 2 Press [OK] to select "Setup".
- 3 Select "Player Settings".

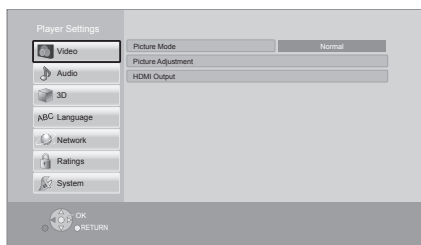

- 4 Select an item and change the settings.

## To exit the screen

Press [HOME].

## Video

### Picture Mode (⇒ 28)

### Picture Adjustment (⇒ 28)

### HDMI Output

Press [OK] to show the following settings:

#### > HDMI Resolution

The items supported by the connected devices are indicated on the screen as "\*". When any item without "\*" is selected, the images may be distorted.

- If "Auto" is selected, the best suited output resolution to the connected TV is automatically selected.
- To enjoy high-definition video up-converted to 1080p, you need to connect the unit directly to 1080p compatible HDTV (High Definition TV). If this unit is connected to an HDTV through other equipment, the other equipment must also be 1080p compatible.

#### > 24p(4K)/24p Output **BDT330**

This setting is for selecting the output method for content recorded in 24p\*1, such as movies.

24p(4K)	Outputs signals by upconverting them to 4K*2.
24p	Outputs in 24.

- Connect the compatible TV for each (4K or 1080/24p) output to the HDMI AV OUT MAIN terminal of this unit.
- "24p(4K)" works only when playing back in 2D.
- When playing DVD-Video, set this setting to "24p(4K)" or "24p", and then "24p" in "Video Settings" (⇒ 28) to "On".
- When BD-Video/DVD-Video images other than 24p are played, images are output at 60p.

(Continued on the next page.)

### ➤ 24p Output **BDT230** **BDT225**

When this unit is connected to a TV supporting 1080/24p output, movies and other material recorded at 24p\*1 are output at 24p.

- When playing DVD-Video, set to "On" and then set "24p" in "Video Settings" (⇒ 28) to "On".
- When BD-Video/DVD-Video images other than 24p are played, images are output at 60p.

### ➤ HDMI Color Mode

This setting is for selecting color-space conversion of the image signal.

### ➤ Deep Color Output

This setting is for selecting whether to use Deep Color output when a TV that supports Deep Color is connected.

### ➤ Contents Type Flag

Depending on the playback content, the TV will output adjusting to the optimal method when a TV that supports this function is connected.

### ➤ HDMI(SUB) Output Mode **BDT330**

Set to output the video from the HDMI AV OUT SUB terminal or not.

\*1 A progressive image recorded at a rate of 24 frames per second (motion-picture film). Many BD-Video movie contents are recorded in 24 frames/second in accordance with the film materials.

\*2 A high resolution image/display technology of approximately 4000 (width) × 2000 (height) pixels.

## Audio

### ■ Dialog Enhancer (⇒ 28)

### ■ Dynamic Range Compression

You can listen at low volumes but still hear dialog clearly.

(Dolby Digital, Dolby Digital Plus and Dolby TrueHD only)

- "Auto" is effective only when playing Dolby TrueHD.

### ■ Digital Audio Output

Press [OK] to show the following settings:

#### ➤ Dolby D/Dolby D +/Dolby TrueHD

#### ➤ DTS/DTS-HD

Select the audio signal to output.

- Select "PCM", when the connected equipment cannot decode the respective audio format. This unit decodes the audio format and transmits to the connected equipment.
- Not making the proper settings may result in noise.

#### ➤ BD-Video Secondary Audio

Select whether or not to mix the primary and secondary audio (including the button click sound). If "Off" is selected, the unit outputs the primary audio only.

#### ➤ HDMI Audio Output

This setting selects whether or not to output audio from HDMI.

- Select "Off" when the TV is connected to this unit via HDMI AV OUT terminal, and this unit is also connected to other devices, such as an amplifier/receiver via an OPTICAL terminal.

## ■ PCM Down Conversion

Select how to output audio with a sampling frequency of 96 kHz for the PCM output from the OPTICAL.

- If “On” is selected, the signals that are converted to 48 kHz are output.
- If “Off” is selected, and the connected equipment does not support 96 kHz, the sound will not be output normally.
- Signals are converted to 48 kHz despite the settings in the following cases:
  - when the signals have a sampling frequency of 192 kHz
  - when the disc has copy protection
  - when “BD-Video Secondary Audio” is set to “On”

## ■ Downmix

Select the downmix system of multi-channel to 2-channel sound.

- Select “Surround encoded”, when the connected equipment supports the virtual surround function.
- The downmix effect is not available when “Digital Audio Output” is set to “Bitstream”.
- The audio will be output in “Stereo” in the following cases:
  - AVCHD playback
  - Playback of secondary audio (including the button click sound).

## ■ DTS Neo:6

2ch (2.1ch) audio is expanded to 7ch (7.1ch) before it is output.

- This function works when the following conditions are met:
  - Audio is output from the HDMI AV OUT terminal.
  - Audio recorded at 96 kHz or lower is output.
  - “Digital Audio Output” is set to “PCM” when audio other than PCM is output.

## 3D

### ■ 3D BD-Video Playback

Select the playback method of 3D compatible video software.

### ■ 3D AVCHD Output

Select the output method of 3D AVCHD videos.

### ■ 3D Playback Precautions

Set to display or hide the 3D viewing warning screen when playing back the 3D compatible video software.

### ■ Pop-Out Level (⇒ 28)

## Language

### ■ Audio Language

Choose the language for audio.

- If “Original” is selected, the original language of each disc will be selected.
- Enter a code (⇒ 42) when you select “Other \*\*\*\*\*”.

### ■ Subtitle Language

Choose the language for the subtitle.

- If “Auto” is selected and the language selected for “Audio Language” is not available, subtitles of that language will automatically appear if available on that disc.
- Enter a code (⇒ 42) when you select “Other \*\*\*\*\*”.

### ■ Menu Language

Choose the language for the disc menus.

- Enter a code (⇒ 42) when you select “Other \*\*\*\*\*”.

### ■ Subtitle Text

Select a suitable item according to the language used for MKV/Xvid **BDT330 for Canada** subtitles text.

- This item is displayed only after playing back a file.

### ■ On-screen Language

Choose the language for menus and on-screen messages.

## Network

### ■ Easy Network Setting (⇒ 14)

#### ■ Network Settings

Perform network-related settings individually.  
Press [OK] to show the following settings:

##### ➤ LAN Connection Mode

Select the LAN connection method.

- Select "Wireless Master" when you make a direct wireless connection between this unit and a Home Network device. Internet connection is not available when this item is selected.

##### ➤ Wireless Settings

This allows the wireless router and connection settings to be set. Current connection settings and connection state can be checked.

##### Connection Setting

The wireless router connection wizard will be displayed.

##### Double Speed Mode Setting (2.4GHz)

Set the connection speed for a 2.4 GHz wireless format.

- If you connect using the "Double Speed Mode (40MHz)", 2 channels use the same frequency band, and there is consequently a greater risk of reception interference. This can cause the connection speed to drop or become unstable.

##### ➤ IP Address/DNS Settings

This is for checking the state of the network connection and setting the IP address and DNS-related.

Press [OK] to show the respective setting.

##### ➤ Proxy Server Settings

This is for checking the state of connection with the Proxy server and performing settings.

Press [OK] to show the respective setting.

### ➤ Network Service Settings (⇒ 23) (VIERA Connect)

Press [OK] to show the following settings:

#### Time Zone

Set the unit's time to match your location.

- Some VIERA Connect contents require the time zone to be set. Set the time zone if necessary.

#### DST

Select "On" when using Daylight Saving time.

### ➤ Network Drive Connection

It is possible to access the shared folder of equipment not compatible with DLNA, such as the Windows XP operating system, and play back video, still pictures, and music on this unit. For the setting and operation method of connected equipment, refer to the following website.

<http://panasonic.jp/support/global/cs/>  
(This site is in English only.)

### ➤ Remote Device Settings (⇒ 25)

Press [OK] to show the following settings:

#### Remote Device Operation

Enable to operate by DMC.

- If "On" is selected, "Quick Start" will be activated.

#### Setting Unit Name

Set the name of this unit to be displayed on the connected equipment.

#### Registration Type

Auto	Allow connection to all the equipment accessing this unit.
Manual	Set the permission for individual equipment connections accessing this unit.

#### Remote Device List

Registering/deregistering of the displayed equipment can be performed when "Manual" in "Registration Type" is selected.



### ➤ **BD-Live Internet Access (⇒ 22)**

You can restrict Internet access when BD-Live functions are used.

- If "Allow ( Limited )" is selected, Internet access is permitted only for BD-Live contents which have content owner certificates.

## **Ratings**

The following items use the same password. Don't forget your password.

### ■ **DVD-Video Ratings**

Set a ratings level to limit DVD-Video play.

### ■ **BD-Video Ratings**

Set an age limit of BD-Video play.

### ■ **Network Service Lock**

You can restrict the usage of VIERA Connect.

## **System**

### ■ **Easy Settings**

You can execute basic settings.



### ■ **Display Settings**

Press [OK] to show the following settings:

#### ➤ **TV Aspect**

Set to match the type of TV connected.

When connected to a 4:3 aspect TV and playing 16:9 ratio image:

<b>4:3 Pan &amp; Scan</b>	The sides are cut off so the picture fills the screen. When playing BD-Video, video is output as "4:3 Letterbox".	
<b>4:3 Letterbox</b>	Black bands appear at the top and bottom of the picture.	

When connected to a 16:9 widescreen TV and playing 4:3 ratio image:

<b>16:9</b>	Video is displayed as a 4:3 ratio image in the center of the screen.
<b>16:9 Full</b>	Video is displayed as a horizontally stretched 16:9 image.

#### ➤ **Screen Saver Function**

This is to prevent image retention on the screen.

- When this is set to "On":  
If a list of playback content is displayed and there is no operation for 10 minutes or more, the screen switches to HOME menu automatically.
- While playing and pausing, etc., this function is not available.

#### ➤ **Status Messages**

Choose whether to show status messages automatically.

### ➤ **HDMI CEC**

Set to use "HDMI CEC" function when connected via HDMI cable to a device that supports "HDMI CEC".

- Select "Off" when you do not want to use "HDMI CEC".

---

## ■ **Unit Settings**

Press [OK] to show the following settings:

---

### ➤ **Mixed Data Disc Option**

Select the playback contents on discs with both data files and Video.

- If "MP3/JPEG/MKV" is selected, the video menu function (except MKV/ Xvid **BDT330 for Canada**) cannot be played back.
- If "BDAV/AVCHD" is selected, data file cannot be played back.

---

### ➤ **Front Panel Display**

Changes the brightness of the unit's display.

- If "Auto" is selected, the display is set to bright and only dimmed during playback.

---

### ➤ **Blue LED** **BDT330**

Set whether to light the blue LED in the center of this unit when turned ON.

---

### ➤ **HDMI(SUB) V.OFF LED Control** **BDT330**

Set to light the HDMI (SUB) V.OFF LED or not.

- This will light when "HDMI(SUB) Output Mode" (⇒ 30) is set to "V.OFF", and the power of the connected equipment to the HDMI AV OUT SUB is on.

---

### ➤ **Edit User Information**

Change the user information registered in the HOME menu.

---

## ■ **Start-up Banner**

Select whether to display the banner after turning on this unit. (⇒ 18)

---

## ■ **Quick Start**

Speed of start-up from standby mode is increased.

- When set to "On", the internal control unit will be powered and the idle power consumption will increase compared to when set to "Off". (About the power consumption ⇒ 40)

---

## ■ **Remote Control Code**

Change the remote control code if other Panasonic products react to this remote control.

---

## ■ **Firmware Update (⇒ 16)**

Press [OK] to show the following settings:

---

### ➤ **Automatic Update Check**

When this equipment remains connected to the Internet, it will check for the latest firmware version when it is turned on and you can update it if necessary.

---

### ➤ **Update Now**

You can update the firmware manually if a firmware update is available.

---

## ■ **System Information**

Press [OK] to show the following settings:

---

### ➤ **License**

Information about the software used by this unit is displayed.

---

### ➤ **Firmware Version Information**

Display firmware version of this unit and wireless LAN module.

---

## ■ **Restore Default Settings**

This returns all values in the Setup menu and the Option menu to the default settings, except for some settings of network, ratings, remote control code, language, etc.

---

# Troubleshooting guide

Before requesting service, please perform the following steps.

## Do you have the latest firmware installed?

Panasonic is constantly improving the unit's firmware to ensure that our customers are enjoying the latest technology. (⇒ 16)



## Make the following checks and visit our website for more information.

For U.S.A. :

[www.panasonic.com/help](http://www.panasonic.com/help)

Enter the model number.

For Canada :

<http://www.panasonic.ca>



## Or visit our website to find a service center.

You can find a service center near you easily on our website.

## Other support information:

"Customer Services Directory (United States and Puerto Rico)" (⇒ 45) or "Limited Warranty (Only for CANADA)" (⇒ 46).

## The following do not indicate a problem with this unit:

- Regular disc rotating sounds.
- Image disturbance during search.
- Image disturbance when replacing 3D discs.

## ■ Unit does not respond to remote control or front panel buttons.

Disconnect AC power supply cord, wait 1 minute, then reconnect AC power supply cord.

## ■ Cannot eject disc.

- ① Turn the unit on.
- ② Press and hold [OK], the blue button and the yellow button on the remote control at the same time for more than 5 seconds.
  - "00RET" is displayed on the unit's display.
- ③ Press [▶] (right) repeatedly on the remote control until "06FTO" is displayed on the unit's display.
- ④ Press [OK].

## General operation

### To return to the factory preset.

- Select "Yes" in "Restore Default Settings" in the Setup menu. (⇒ 34)

### To return all settings to the factory preset.

- Reset the unit as follows:
  - ① Turn the unit on.
  - ② Press and hold [OK], the blue button and the yellow button on the remote control at the same time for more than 5 seconds.
    - "00RET" is displayed on the unit's display.
  - ③ Press [▶] (right) repeatedly on the remote control until "08FIN" is displayed on the unit's display.
  - ④ Press and hold [OK] for more than 5 seconds.

### The remote control does not work properly.

- Change the batteries in the remote control. (⇒ 5)
- The remote control and this unit are using different codes. If "SET □" is displayed on the unit's display when a button is pressed on the remote control, change the code on the remote control. (⇒ 38)

### The TV tuner mode is not displayed when the TV is switched on.

- This phenomenon may occur, depending on the TV setting, when "Quick Start" is set to "On".
- Depending on the TV, this phenomenon may be prevented by reconnecting the HDMI cable to a different HDMI input terminal or by changing the HDMI auto connection setting.

### You have forgotten your ratings password. You want to cancel the ratings level.

- The ratings level returns to the factory preset.
  - ① Turn the unit on.
  - ② Press and hold [OK], the blue button and the yellow button on the remote control at the same time for more than 5 seconds.
    - "00RET" is displayed on the unit's display.
  - ③ Press [▶] (right) repeatedly on the remote control until "03 VL" is displayed on the unit's display.
  - ④ Press [OK].

### **This unit does not recognize the USB connection correctly.**

- Disconnect and reconnect the USB cable. If it still does not recognize the connection, turn this unit off and on again.
- USB devices may not be recognized by this unit when connected using the following :
  - a USB hub
  - a USB extension cable
- If you connect USB HDD to this unit, use the USB cable that is supplied with the HDD.

## **Picture**

### **The images from this unit do not appear on the TV.**

#### **Picture is distorted.**

- An incorrect resolution is selected in “HDMI Resolution”. Reset the setting as follows:
  - ① Turn the unit on.
  - ② Press and hold [OK], the blue button and the yellow button on the remote control at the same time for more than 5 seconds.
    - “00RET” is displayed on the unit’s display.
  - ③ Press [▶] (right) repeatedly on the remote control until “04PRG” is displayed on the unit’s display.
  - ④ Press and hold [OK] for more than 5 seconds. Set the item again. (⇒ 29)
    - When Dolby Digital Plus, Dolby TrueHD, and DTS-HD audio are not output properly, select “Yes” in “Restore Default Settings” and make proper settings. (⇒ 34)
- When “3D BD-Video Playback” in the Setup menu is set to “Auto”, images may not be output depending on the connection method. After removing the disc from this unit, select “Set before play” in the Setup menu, and select “2D Playback” in the setup screen displayed when playing 3D discs. (⇒ 31)
- **BDT330** : When outputting in 24p (4K), images may be distorted depending on the HDMI cable. Use an HDMI cable that supports 4K output.

### **Video is not output.** **BDT330**

- Video from the HDMI AV OUT SUB terminal is not output when the “HDMI(SUB) Output Mode” is set to “V.OFF”. (⇒ 30)

### **Video is not output in high-definition.**

- Confirm that “HDMI Resolution” in the Setup menu is set properly. (⇒ 29)

### **3D video is not output.**

- Connect to a full high-definition TV.
- Is there a non-3D compatible amplifier/receiver connected between this unit and a TV? (⇒ 11)
- **BDT330** : If there is a non-3D compatible amplifier/receiver connected to the HDMI AV OUT SUB terminal, set the “HDMI(SUB) Output Mode” to “V.OFF”. (⇒ 11)
- Are the settings on this unit and the TV correct? (⇒ 21)
- Is the amplifier/receiver that is connected between this unit and TV on?
- Depending on the connected TV, the video being played back might switch to 2D video due to changes in resolution etc. Check the 3D setting on the TV.

### **3D video is not output correctly as 2D.**

- Select “Set before play” in the Setup menu, and select “2D Playback” in the setup screen displayed when playing 3D discs. (⇒ 31, “3D BD-Video Playback”)
- Discs that have recorded titles with Side by side (2 screen structure) and that can be enjoyed in 3D are played back in accordance with the settings of the TV.

### **No subtitles.**

- When progressive output is on, closed captions/subtitles cannot be displayed.

### **The subtitles overlap closed captions recorded on discs.**

- Turn off the subtitles or the closed caption setting on the TV. (⇒ 27)

### **A black band is displayed around the edge of the screen.**

#### **The aspect ratio of the screen is abnormal.**

- Confirm the “TV Aspect” is set properly. (⇒ 33)
- Adjust the aspect setting on the TV.

## Audio

### Cannot switch audio.

- The audio cannot switch, if “Digital Audio Output” is set to “Bitstream”. Set “Digital Audio Output” to “PCM”. (⇒ 30)

### Cannot hear the desired audio type.

- Check the connections and the “Digital Audio Output” settings. (⇒ 11, 30)
- **BDT330** : When connecting this unit to a TV via an HDMI AV OUT MAIN and to an amplifier/receiver via an HDMI AV OUT SUB, set “HDMI(SUB) Output Mode” to “V.OFF”. (⇒ 11)
- To output audio from a device connected with an HDMI cable, set “HDMI Audio Output” to “On” in the Setup menu. (⇒ 30)

### There is no sound coming out from the TV.

#### **BDT330**

- Audio may not output from the TV when the amplifier/receiver is connected to the HDMI AV OUT SUB, and “HDMI(SUB) Output Mode” (⇒ 30) is set to “V.OFF”. In such a case, output audio from the amplifier/receiver. To output audio from the TV, set the “HDMI(SUB) Output Mode” to “Normal”.

## Playback

### Disc cannot be played.

- The disc is dirty. (⇒ 5)
- The disc is not finalized. (⇒ 7)

### Still pictures (JPEG) do not play back normally.

- The images that were edited on the PC, such as Progressive JPEG, etc., may not be played back.

### I can't play back BD-Live.

- Confirm that this unit is connected to the broadband Internet. (⇒ 13)
- Connect this unit to the network by a wired connection.
- Confirm the “BD-Live Internet Access” settings. (⇒ 33)
- Confirm a USB device is connected to the USB port. (⇒ 17)

## Network

### I can't connect to the network.

- Confirm the network connection and settings. (⇒ 13, 14, 32)
- There may be obstacles that prevent the unit from detecting your home network. Bring the unit and the wireless router closer to each other. This unit may be able to detect your network name (⇒ 16, “SSID”).
- Check the operating instructions for each device and connect accordingly.

### Cannot play current title.

- Confirm the network connection and settings. (⇒ 13, 14, 32)

### When using wireless LAN connection, video from the DLNA Certified media server is not played back or video frames are dropped during playback.

- Higher transfer rate router such as 802.11n (2.4 GHz or 5 GHz) wireless router may solve the problem. If you use 802.11n (2.4 GHz or 5 GHz) wireless router, it is necessary to set the encryption type to “AES”. Simultaneous use with a microwave, cordless telephone etc. at 2.4 GHz may result in connection interruptions or other problems.
- On the “Wireless Settings” screen (⇒ 32), the continuous lighting of at least 4 “Reception” indicators is the target for a stable connection. If 3 or fewer indicators are lit or the connection is being interrupted, change the position or angle of your wireless router and see if the connection state improves. If there is no improvement, connect to a wired network and perform the “Easy Network Setting” (⇒ 14) again.

# Messages

Check the following when messages or service numbers are displayed on the screen or unit's display.

## On the TV

### Cannot play.

- You inserted an incompatible disc (Discs recorded in PAL video, etc.).

### Cannot display on this unit.

- You tried to play a non-compatible image.
- Confirm "SD" on the unit's display is not displayed and re-insert the card.

### No disc inserted.

- The disc may be upside down.

### ⊘ This operation is not available.

- Some operations are unsupported by the unit. (For example, reverse slow motion, etc.)

### IP address is not set.

- The "IP Address" in "IP Address/DNS Settings" is "----, ---, ---, ---". Set the "IP Address", "Subnet Mask", and "Default Gateway". (Select the automatic address acquisition if necessary.)

### The current wireless network security setting is weak. It is recommended to change to a stronger security setting.

- Set a stronger network security level referring to the wireless router operating instructions.

## On the unit's display

### NET

- While connecting to a network.

### No PLAY

- There is a viewing restriction on a BD-Video or DVD-Video. (⇒ 33)
- The media is dirty or badly scratched. The unit cannot play.

### REMOVE

- The USB device is drawing too much power. Remove the USB device.

### SET □ ("□" stands for a number.)

- The remote control and this unit are using different codes. Change the code on the remote control.

Press and hold [OK] and the indicated number button at the same time for more than 5 seconds.



### U59

- Temperature of this unit is hot and the unit switches to standby for safety reasons. Wait for about 30 minutes. Select a position with good ventilation when installing the unit.

### H□□ or F□□

#### ("□" stands for a number.)

- There is something unusual.
- Check the unit using the troubleshooting guide. If the service number remains displayed, do the following.
  - ① Disconnect the plug from the AC outlet, wait a few seconds, then reconnect it.
  - ② Press [⏻/|] to turn the unit on.

If the service number remains displayed despite doing the above, request service from the dealer. Inform the dealer of the service number when requesting service.

**START**

- The system is being restarted during the firmware update. Please do not turn off the unit.
- 

**UPD□/□**

(“□” stands for a number.)

- The firmware is being updated.  
Please do not turn off the unit.
- 

**FIN**

- The firmware update is complete.
-

# Specifications

## General

<b>Signal system</b>	NTSC
<b>Operating temperature range</b>	+5 °C to +35 °C (+41 °F to +95 °F)
<b>Operating humidity range</b>	10 % to 80 % RH (no condensation)
<b>Digital audio output</b>	Optical digital output (Optical terminal)
<b>HDMI AV output</b>	Output connector: <b>BDT330</b> Type A (19 pin) 2 system <b>BDT230</b> <b>BDT225</b> Type A (19 pin) 1 system
<b>SD card slot</b>	1 system
<b>USB slot</b>	USB2.0 1 system
<b>Ethernet</b>	10BASE-T/100BASE-TX 1 system
<b>Wireless LAN</b>	<b>Standard Compliance:</b> IEEE802.11 a/b/g/n
	<b>Frequency range:</b> 2.4 GHz/5 GHz band
	<b>Security:</b> WPA™/WPA2™ (Encryption Type: TKIP/AES, Authentication Type: PSK), WEP (64 bit/128 bit)
<b>LASER Specification</b>	<b>Class I LASER Product</b> <b>Wave length:</b> 785 nm (CDs)/ 660 nm (DVDs)/405 nm (BDs) <b>Laser power:</b> No hazardous radiation is emitted with the safety protection
<b>Power supply</b>	<b>AC 120 V, 60 Hz</b>
<b>Power consumption</b>	<b>Approx. 14 W</b>
<b>Power consumption in standby mode</b>	<b>Approx. 0.5 W</b>
<b>Power consumption in quick start standby mode</b>	<b>BDT330</b> <b>Approx. 6 W</b> <b>BDT230</b> <b>BDT225</b> <b>Approx. 5.5 W</b>
<b>Dimensions (W×H×D) Including the projecting parts</b>	<b>BDT330</b> Approx. 430 mm×41 mm×181 mm (Approx. 16 15/16"×1 5/8"× 7 3/16")
	<b>BDT230</b> <b>BDT225</b> Approx. 430 mm×38 mm×179 mm (Approx. 16 15/16"×1 1/2"× 7 1/16")
<b>Mass (Weight)</b>	<b>BDT330</b> <b>Approx. 1.6 kg (3.52 lbs)</b> <b>BDT230</b> <b>BDT225</b> <b>Approx. 1.4 kg (3.08 lbs)</b>

- Specifications are subject to change without notice.

## File format

File format	Extension	Reference
<b>MP3</b>	“.MP3”, “.mp3”	This unit supports ID3 tags, but only titles, artist names and album names can be displayed.
<b>JPEG</b>	“.JPG”, “.jpg”	<ul style="list-style-type: none"> <li>• MOTION JPEG and Progressive JPEG are not supported.</li> <li>• You may not be able to play back the file if you have edited the folder structure or the file name on a PC or other device.</li> </ul>
<b>MKV</b>	“.MKV”, “.mkv”	<ul style="list-style-type: none"> <li>• The video file and subtitles text file are inside the same folder, and the file names are the same except for the file extensions.</li> <li>• Some MKV/Xvid files may not play back, depending on the video resolution and frame rate condition.</li> </ul>
	<b>Subtitles text file</b> “.SRT”, “.srt”, “.SSA”, “.ssa”, “.ASS”, “.ass”	
	“.AVI”, “.avi”	
<b>BDT330 for Canada Xvid</b>	<b>Subtitles text file</b> “.SRT”, “.srt”, “.SUB”, “.sub”, “.TXT”, “.txt”	
<b>FLAC</b>	“.FLAC”, “.flac”	Maximum sampling rate: 192 kHz/24 bit
<b>WAV</b>	“.WAV”, “.wav”	Maximum sampling rate: 192 kHz/24 bit
<b>MPO</b>	“.MPO”, “.mpo”	3D still picture
<b>AAC</b>	“.M4A”, “.m4a”, “.AAC”, “.aac”	This unit supports ID3 tags. Maximum sampling rate: 48 kHz/320 kbps
<b>WMA</b>	“.WMA”, “.wma”	This unit supports ID3 tags. Maximum sampling rate: 48 kHz/355 kbps

- With certain recording states and folder structures, the play order may differ or playback may not be possible.



## Audio information

The audio output differs depending on which terminals are connected to the amplifier/receiver, and the settings on the unit. (⇒ 30, “Digital Audio Output”)

- The number of channels listed is the maximum possible number of output channels when connected to amplifier/receiver compatible with the respective audio format.

Output channel	Terminal	“Digital Audio Output”	
		“Bitstream”	“PCM”
	HDMI AV OUT <sup>3</sup>	Outputs using original audio <sup>1</sup>	BD-Video : 7.1ch PCM <sup>1,2</sup> DVD-Video : 5.1ch PCM
OPTICAL	Dolby Digital/ DTS Digital Surround	Down-mixed 2ch PCM	

<sup>1</sup> When “BD-Video Secondary Audio” is set to “On”, the audio will be output as Dolby Digital, DTS Digital Surround or 5.1ch PCM.

<sup>2</sup> **BDT230** **BDT225** :The maximum possible number of Dolby sound is 5.1ch PCM.

<sup>3</sup> When “DTS Neo:6” is set to “Cinema” or “Music”, 2ch (2.1ch) audio can be expanded to 7ch (7.1ch) and output. (⇒ 31)

## Supported format for DLNA

- File formats that are not supported by your DLNA server cannot be played.

### Video

Container	Video codec	Audio codec	Example of file extension
AVCHD	H.264	Dolby Digital	.mts
MP4	H.264	AAC	.mp4
PS	MPEG2	Dolby Digital Linear PCM	.mpg .mpeg
TS	MPEG2 H.264	AAC Dolby Digital	.m2ts .ts

### Photo

Format	Example of file extension
JPEG	.jpg

### Audio

Audio codec	Example of file extension
MP3	.mp3
FLAC	.flac
AAC	.m4a
WMA	.wma
Linear PCM	—

## Display languages list

Display Language	Language	Display Language	Language	Display Language	Language
ENG	English	JPN	Japanese	ARA	Arabic
FRA	French	CHI	Chinese	HIN	Hindi
DEU	German	KOR	Korean	PER	Persian
ITA	Italian	MAL	Malay	IND	Indonesian
ESP	Spanish	VIE	Vietnamese	MRI	Maori
NLD	Dutch	THA	Thai	BUL	Bulgarian
SVE	Swedish	POL	Polish	RUM	Romanian
NOR	Norwegian	CES	Czech	GRE	Greek
DAN	Danish	SLK	Slovak	TUR	Turkish
POR	Portuguese	HUN	Hungarian	*	Others
RUS	Russian	FIN	Finnish		

## Language code list

Language	Code	Language	Code	Language	Code
Abkhazian:	6566	Gujarati:	7185	Rhaeto-Romance:	
Afar:	6565	Hausa:	7265	Romanian:	8279
Afrikaans:	6570	Hebrew:	7387	Russian:	8285
Albanian:	8381	Hindi:	7273	Samoan:	8377
Amharic:	6577	Hungarian:	7285	Sanskrit:	8365
Arabic:	6582	Icelandic:	7383	Scots Gaelic:	7168
Armenian:	7289	Indonesian:	7378	Serbian:	8382
Assamese:	6583	Interlingua:	7365	Serbo-Croatian:	8372
Aymara:	6589	Irish:	7165	Shona:	8378
Azerbaijani:	6590	Italian:	7384	Sindhi:	8368
Bashkir:	6665	Japanese:	7465	Singhalese:	8373
Basque:	6985	Javanese:	7487	Slovak:	8375
Bengali; Bangla:	6678	Kannada:	7578	Slovenian:	8376
Bhutani:	6890	Kashmiri:	7583	Somali:	8379
Bihari:	6672	Kazakh:	7575	Spanish:	6983
Breton:	6682	Kirghiz:	7589	Sundanese:	8385
Bulgarian:	6671	Korean:	7579	Swahili:	8387
Burmese:	7789	Kurdish:	7585	Swedish:	8386
Byelorussian:	6669	Laotian:	7679	Tagalog:	8476
Cambodian:	7577	Latin:	7665	Tajik:	8471
Catalan:	6765	Latvian, Lettish:	7686	Tamil:	8465
Chinese:	9072	Lingala:	7678	Tatar:	8484
Corsican:	6779	Lithuanian:	7684	Telugu:	8469
Croatian:	7282	Macedonian:	7775	Thai:	8472
Czech:	6783	Malagasy:	7771	Tibetan:	6679
Danish:	6865	Malay:	7783	Tigrinya:	8473
Dutch:	7876	Malayalam:	7776	Tonga:	8479
English:	6978	Maltese:	7784	Turkish:	8482
Esperanto:	6979	Maori:	7773	Turkmen:	8475
Estonian:	6984	Marathi:	7782	Twì:	8487
Faroese:	7079	Moldavian:	7779	Ukrainian:	8575
Fiji:	7074	Mongolian:	7778	Urdu:	8582
Finnish:	7073	Nauru:	7865	Uzbek:	8590
French:	7082	Nepali:	7869	Vietnamese:	8673
Frisian:	7089	Norwegian:	7879	Volapük:	8679
Galician:	7176	Oriya:	7982	Welsh:	6789
Georgian:	7565	Pashto, Pushto:	8083	Wolof:	8779
German:	6869	Persian:	7065	Xhosa:	8872
Greek:	6976	Polish:	8076	Yiddish:	7473
Greenlandic:	7576	Portuguese:	8084	Yoruba:	8979
Guarani:	7178	Punjabi:	8065	Zulu:	9085
		Quechua:	8185		

"AVCHD", "AVCHD 3D", "AVCHD Progressive" and "AVCHD 3D/ Progressive" are trademarks of Panasonic Corporation and Sony Corporation.

Java is a registered trademark of Oracle and/or its affiliates.

Manufactured under license from Dolby Laboratories. Dolby and the double-D symbol are trademarks of Dolby Laboratories.

Manufactured under license under U.S. Patent Nos: 5,956,674; 5,974,380; 6,226,616; 6,487,535; 7,212,872; 7,333,929; 7,392,195; 7,272,567 & other U.S. and worldwide patents issued & pending. DTS-HD, the Symbol, & DTS-HD and the Symbol together are registered trademarks & DTS-HD Master Audio is a trademark of DTS, Inc. Product includes software. © DTS, Inc. All Rights Reserved.

HDMI, the HDMI Logo, and High-Definition Multimedia Interface are trademarks or registered trademarks of HDMI Licensing LLC in the United States and other countries.

This product is licensed under the AVC patent portfolio license and VC-1 patent portfolio license for the personal and non-commercial use of a consumer to (i) encode video in compliance with the AVC Standard and VC-1 Standard ("AVC/VC-1 Video") and/or (ii) decode AVC/VC-1 Video that was encoded by a consumer engaged in a personal and non-commercial activity and/or was obtained from a video provider licensed to provide AVC/VC-1 Video. No license is granted or shall be implied for any other use. Additional information may be obtained from MPEG LA, LLC. See <http://www.mpegla.com>.

VIERA Connect is a trademark of Panasonic Corporation.

MPEG Layer-3 audio coding technology licensed from Fraunhofer IIS and Thomson.

SDXC Logo is a trademark of SD-3C, LLC.

"DVD Logo" is a trademark of DVD Format/Logo Licensing Corporation.

The Wi-Fi CERTIFIED Logo is a certification mark of the Wi-Fi Alliance. The Wi-Fi Protected Setup Mark is a mark of the Wi-Fi Alliance.

"Wi-Fi", "Wi-Fi Protected Setup", "Wi-Fi Direct", "Miracast", "WPA" and "WPA2" are marks or registered marks of the Wi-Fi Alliance.

DLNA, the DLNA Logo and DLNA CERTIFIED are trademarks, service marks, or certification marks of the Digital Living Network Alliance.

Windows is a trademark or a registered trademark of Microsoft Corporation in the United States and other countries.

Android is a trademark of Google Inc.

This product incorporates the following software:

- (1) the software developed independently by or for Panasonic Corporation,
- (2) the software owned by third party and licensed to Panasonic Corporation,
- (3) the software licensed under the GNU General Public License, Version 2.0 (GPL V2.0),
- (4) the software licensed under the GNU LESSER General Public License, Version 2.1 (LGPL V2.1), and/or
- (5) open source software other than the software licensed under the GPL V2.0 and/or LGPL V2.1.

The software categorized as (3) - (5) are distributed in the hope that it will be useful, but WITHOUT ANY WARRANTY, without even the implied warranty of MERCHANTABILITY or FITNESS FOR A PARTICULAR PURPOSE. Please refer to the detailed terms and conditions thereof shown in the Player Settings menu.

At least three (3) years from delivery of this product, Panasonic will give to any third party who contacts us at the contact information provided below, for a charge no more than our cost of physically performing source code distribution, a complete machine-readable copy of the corresponding source code covered under GPL V2.0, LGPL V2.1 or the other licenses with the obligation to do so, as well as the respective copyright notice thereof.

Contact information: [oss-cd-request@gg.jp.panasonic.com](mailto:oss-cd-request@gg.jp.panasonic.com)

The source code and the copyright notice are also available for free in our website below.

<http://panasonic.net/avc/oss/bdplayer/AWBPM13A.html>



(1) MS/WMA

This product is protected by certain intellectual property rights of Microsoft Corporation and third parties. Use or distribution of such technology outside of this product is prohibited without a license from Microsoft or an authorized Microsoft subsidiary and third parties.

(2) MS/PlayReady/Final Product Labeling

This product contains technology subject to certain intellectual property rights of Microsoft. Use or distribution of this technology outside of this product is prohibited without the appropriate license(s) from Microsoft.

(3) MS/PlayReady/End User Notices

Content owners use Microsoft PlayReady™ content access technology to protect their intellectual property, including copyrighted content. This device uses PlayReady technology to access PlayReady-protected content and/or WMDRM-protected content. If the device fails to properly enforce restrictions on content usage, content owners may require Microsoft to revoke the device's ability to consume PlayReady-protected content. Revocation should not affect unprotected content or content protected by other content access technologies. Content owners may require you to upgrade PlayReady to access their content. If you decline an upgrade, you will not be able to access content that requires the upgrade.

(4) FLAC, WPA Supplicant

The software licenses are displayed when "License" in the Setup menu is selected. (⇒ 34)

---

Copyright 2004-2010 Verance Corporation. Cinavia™ is a Verance Corporation trademark. Protected by U.S. Patent 7,369,677 and worldwide patents issued and pending under license from Verance Corporation. All rights reserved.

---

# Limited Warranty (ONLY FOR U.S.A. AND PUERTO RICO)

## Panasonic Products Limited Warranty

### Limited Warranty Coverage (For USA and Puerto Rico Only)

If your product does not work properly because of a defect in materials or workmanship, Panasonic Corporation of North America (referred to as "the warrantor") will, for the length of the period indicated on the chart below, which starts with the date of original purchase ("warranty period"), at its option either (a) repair your product with new or refurbished parts, (b) replace it with a new or a refurbished equivalent value product, or (c) refund your purchase price. The decision to repair, replace or refund will be made by the warrantor.

Product or Part Name	Parts	Labor
Blu-ray Disc Player	1 Year	90 Days
All included Accessories (Except Non-Rechargeable Batteries)	90 Days	Not Applicable
Only Non-Rechargeable Batteries	10 Days	Not Applicable

During the "Labor" warranty period there will be no charge for labor. During the "Parts" warranty period, there will be no charge for parts. This Limited Warranty excludes both parts and labor for non-rechargeable batteries, antennas, and cosmetic parts (cabinet). This warranty only applies to products purchased and serviced in the United States or Puerto Rico. This warranty is extended only to the original purchaser of a new product which was not sold "as is".

**Mail-In Service**—Online or Telephone Repair Request

### Online Repair Request

To submit a new repair request and for quick repair status visit our Web Site at [www.panasonic.com/repair](http://www.panasonic.com/repair).

### Telephone Repair Request

You may contact us at: 1-800-211-PANA (7262)

When shipping the unit, carefully pack, include all supplied accessories listed in the Owner's Manual, and send it prepaid, adequately insured and packed well in a carton box. When shipping Lithium Ion batteries please visit our Web Site at [www.panasonic.com/BatteryHandling](http://www.panasonic.com/BatteryHandling) as Panasonic is committed to providing the most up to date information. Include a letter detailing the complaint, a return address and provide a daytime phone number where you can be reached. A valid registered receipt is required under the Limited Warranty.

**IF REPAIR IS NEEDED DURING THE WARRANTY PERIOD, THE PURCHASER WILL BE REQUIRED TO FURNISH A SALES RECEIPT/ PROOF OF PURCHASE INDICATING DATE OF PURCHASE, AMOUNT PAID AND PLACE OF PURCHASE. CUSTOMER WILL BE CHARGED FOR THE REPAIR OF ANY UNIT RECEIVED WITHOUT SUCH PROOF OF PURCHASE.**

### Limited Warranty Limits And Exclusions

This warranty ONLY COVERS failures due to defects in materials or workmanship, and DOES NOT COVER normal wear and tear or cosmetic damage. The warranty ALSO DOES NOT COVER damages which occurred in shipment, or failures which are caused by products not supplied by the warrantor, or failures which result from accidents, misuse, abuse, neglect, mishandling, misapplication, alteration, faulty installation, set-up adjustments, misadjustment of consumer controls, improper maintenance, power line surge, lightning damage, modification, introduction of sand, humidity or liquids, commercial use such as hotel, office, restaurant, or other business or rental use of the product, or service by anyone other than a Factory Service Center or other Authorized Servicer, or damage that is attributable to acts of God.

**THERE ARE NO EXPRESS WARRANTIES EXCEPT AS LISTED UNDER "LIMITED WARRANTY COVERAGE".**

**THE WARRANTOR IS NOT LIABLE FOR INCIDENTAL OR CONSEQUENTIAL DAMAGES RESULTING FROM THE USE OF THIS PRODUCT, OR ARISING OUT OF ANY BREACH OF THIS WARRANTY.**

(As examples, this excludes damages for lost time, travel to and from the servicer, loss of or damage to media or images, data or other memory or recorded content. The items listed are not exclusive, but for illustration only.)  
**ALL EXPRESS AND IMPLIED WARRANTIES, INCLUDING THE WARRANTY OF MERCHANTABILITY, ARE LIMITED TO THE PERIOD OF THE LIMITED WARRANTY.**

Some states do not allow the exclusion or limitation of incidental or consequential damages, or limitations on how long an implied warranty lasts, so the exclusions may not apply to you.

This warranty gives you specific legal rights and you may also have other rights which vary from state to state. If a problem with this product develops during or after the warranty period, you may contact your dealer or Service Center. If the problem is not handled to your satisfaction, then write to the warrantor's Consumer Affairs Department at the addresses listed for the warrantor.

**PARTS AND SERVICE, WHICH ARE NOT COVERED BY THIS LIMITED WARRANTY, ARE YOUR RESPONSIBILITY.**

### Customer Services Directory (United States and Puerto Rico)

Obtain Product Information and Operating Assistance; locate your nearest Dealer or Service Center; purchase

Parts and Accessories; or make Customer Service and

Literature requests by visiting our Web Site at:

<http://www.panasonic.com/help>

or, contact us via the web at:

<http://www.panasonic.com/contactinfo>

You may also contact us directly at:

1-800-211-PANA (7262)

Monday-Friday 9am-9pm,

Saturday-Sunday 10am-7pm EST

For hearing or speech impaired TTY users, TTY: 1-877-833-8855

### Accessory Purchases (United States and Puerto Rico)

Purchase Parts, Accessories and Owner's Manual online for all Panasonic Products by visiting our Web Site at:

<http://www.psfc.panasonic.com>

Or, send your request by E-mail to:

[npcparts@us.panasonic.com](mailto:npcparts@us.panasonic.com)

You may also contact us directly at:

1-800-332-5368 (Phone) 1-800-237-9080 (Fax Only)

(Monday-Friday 9am-9pm EST)

Panasonic National Parts Center

20421 84th Ave S., Kent, WA 98032

(We accept Visa, MasterCard, Discover Card, American Express)

For hearing or speech impaired TTY users, TTY: 1-866-605-1277

As of July 2013

The model number and serial number of this product can be found on either the back or the bottom of the unit. Please note them in the space provided below and keep for future reference.

MODEL NUMBER \_\_\_\_\_

SERIAL NUMBER \_\_\_\_\_

### User memo:

DATE OF PURCHASE \_\_\_\_\_  
DEALER NAME \_\_\_\_\_  
DEALER ADDRESS \_\_\_\_\_  
TELEPHONE NUMBER \_\_\_\_\_



# Referencia rápida en español

## (Spanish Quick Reference)

### Conexiones básicas

#### Conexión a un televisor compatible con HDMI

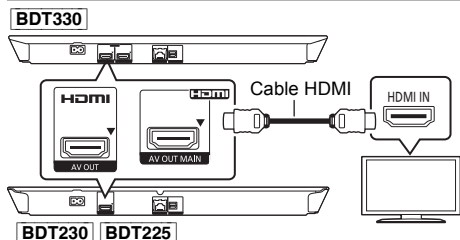

#### Conexión a un televisor compatible con HDMI y a un amplificador/receptor compatible con HDMI

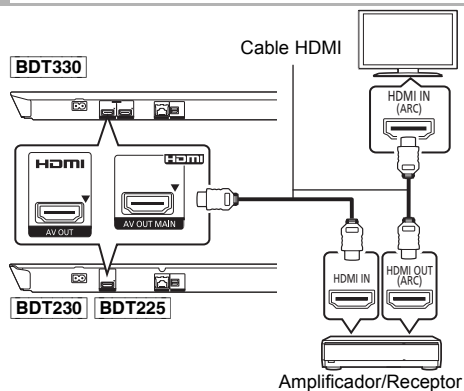

#### Conecte el cable de alimentación de CA por último

A una toma de corriente doméstica

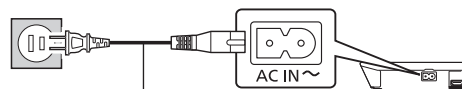

- Conéctelo cuando haya realizado el resto de conexiones.

#### Ahorro de energía

Esta unidad consume una pequeña cantidad de energía aunque esté ajustada en el modo de espera (Accionamiento rápido : Desactivado, aprox. 0,5 W). Para ahorrar energía cuando no vaya a utilizar la unidad durante mucho tiempo, desenchúfela de la toma de corriente.

### Reproducción básica

#### Preparación

Encienda el televisor y seleccione la entrada de vídeo adecuada en el televisor.

#### 1 Pulse [⏻] para encender la unidad.

Después de conectar su nuevo reproductor y pulsar el botón de encendido, aparecerá la pantalla de la configuración básica.

#### 2 Inserte el medio.

### Inicia la reproducción

Pulse [▶PLAY].

### Parada

Pulse [■STOP].

La posición de detención se memoriza.

#### Función de reanudación de la reproducción

Pulse [▶PLAY] para reiniciar la reproducción desde esta posición.

- La posición se borra si se abre la bandeja.
- En los discos BD-Vídeo incluidos los BD-J, la función de reanudación de la reproducción no funciona.

### Pausa

Pulse [⏸PAUSE].

- Pulse [⏸PAUSE] otra vez o [▶PLAY] para reiniciar la reproducción.

### Búsqueda/Cámara lenta

#### Búsqueda

Durante la reproducción, pulse [SEARCH◀◀] o [SEARCH▶▶].

#### Cámara lenta

Durante la pausa, pulse [SEARCH▶▶].

La velocidad aumenta hasta 5 pasos.

- Música y MP3, etc.: La velocidad está fija en un paso.
- Pulse [▶PLAY] para recuperar la velocidad de reproducción normal.

### Salto

Durante la reproducción o la pausa, pulse [◀◀] o [▶▶].

Salta hasta el título, capítulo o pista que desee reproducir.

# Index

<b>A</b> Audio		<b>M</b> Media Renderer . . . . . 25	<b>V</b> VIERA Connect . . . . . 23
Changing audio . . . . . 20		<b>Miracast</b> . . . . . 24	<b>W</b> Wireless LAN . . . . . 13
Language . . . . . 31, 42		<b>Multi User Mode</b> . . . . . 19	24p . . . . . 28, 29, 30
<b>B</b> BD-Live . . . . . 22		<b>N</b> Network	
<b>D</b> DLNA . . . . . 24		Connection . . . . . 13	
<b>F</b> File format . . . . . 40		Setting . . . . . 14, 32	
Firmware update . . . . . 16		<b>P</b> Pop-up menu . . . . . 21	
<b>H</b> HDMI CEC . . . . . 26		<b>Q</b> Quick Start . . . . . 34	
<b>L</b> LAN . . . . . 13		<b>R</b> Restore Default	
Language		Settings . . . . . 34	
Audio . . . . . 31		Resume play function . . . 20	
Menu . . . . . 31		<b>S</b> Subtitle . . . . . 27	
On-screen . . . . . 31		<b>U</b> USB device . . . . . 7	
Soundtrack . . . . . 27			
Subtitle . . . . . 27, 31			

USA Only: Disposal may be regulated in your community due to environmental considerations. For disposal or recycling information, please visit Panasonic website:  
<http://www.panasonic.com/environmental/>  
or call 1-888-769-0149.



As an ENERGY STAR® Partner,\* Panasonic has determined that this product meets the ENERGY STAR® guidelines for energy efficiency.

\* For Canada only: The word "Participant" is used in place of the word "Partner".

Panasonic Corporation of North America

Two Riverfront Plaza, Newark, NJ  
07102-5490  
<http://www.panasonic.com>

Panasonic Canada Inc.  
5770 Ambler Drive,  
Mississauga, Ontario,  
L4W 2T3  
[www.panasonic.ca](http://www.panasonic.ca)

En Sp