

Panasonic®

Owner's Manual Blu-ray Disc™ Player

Model No. **DP-UB150**

ULTRAHD™
Blu-ray

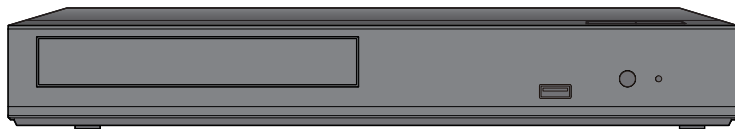
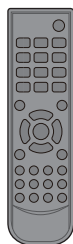

Firmware updates

Panasonic is constantly improving the unit's firmware to ensure that our customers are enjoying the latest technology. Panasonic recommends updating your firmware as soon as you are notified.

For details, refer to "Firmware updates" (⇒ 14) or <https://panasonic.jp/support/global/cs/> (This site is in English only.)

Thank you for purchasing this product.
Please read these instructions carefully before using this product, and save this manual for future use.

If you have any questions, visit :
<http://shop.panasonic.com/support>

Register online at <http://shop.panasonic.com/support> (U.S. customers only)

IMPORTANT SAFETY INSTRUCTIONS

Read these operating instructions carefully before using the unit. Follow the safety instructions on the unit and the applicable safety instructions listed below. Keep these operating instructions handy for future reference.

- 1 Read these instructions.
- 2 Keep these instructions.
- 3 Heed all warnings.
- 4 Follow all instructions.
- 5 Do not use this apparatus near water.
- 6 Clean only with dry cloth.
- 7 Do not block any ventilation openings. Install in accordance with the manufacturer's instructions.
- 8 Do not install near any heat sources such as radiators, heat registers, stoves, or other apparatus (including amplifiers) that produce heat.
- 9 Do not defeat the safety purpose of the polarized or grounding-type plug. A polarized plug has two blades with one wider than the other. A grounding-type plug has two blades and a third grounding prong. The wide blade or the third prong are provided for your safety. If the provided plug does not fit into your outlet, consult an electrician for replacement of the obsolete outlet.
- 10 Protect the power cord from being walked on or pinched particularly at plugs, convenience receptacles, and the point where they exit from the apparatus.
- 11 Only use attachments/accessories specified by the manufacturer.
- 12 Use only with the cart, stand, tripod, bracket, or table specified by the manufacturer, or sold with the apparatus. When a cart is used, use caution when moving the cart/apparatus combination to avoid injury from tip-over.
- 13 Unplug this apparatus during lightning storms or when unused for long periods of time.
- 14 Refer all servicing to qualified service personnel. Servicing is required when the apparatus has been damaged in any way, such as power-supply cord or plug is damaged, liquid has been spilled or objects have fallen into the apparatus, the apparatus has been exposed to rain or moisture, does not operate normally, or has been dropped.



	CAUTION RISK OF ELECTRIC SHOCK DO NOT OPEN	
<p>CAUTION: TO REDUCE THE RISK OF ELECTRIC SHOCK, DO NOT REMOVE SCREWS. NO USER-SERVICEABLE PARTS INSIDE. REFER SERVICING TO QUALIFIED SERVICE PERSONNEL.</p>		



The lightning flash with arrowhead symbol, within an equilateral triangle, is intended to alert the user to the presence of uninsulated "dangerous voltage" within the product's enclosure that may be of sufficient magnitude to constitute a risk of electric shock to persons.



The exclamation point within an equilateral triangle is intended to alert the user to the presence of important operating and maintenance (servicing) instructions in the literature accompanying the appliance.

FCC Note:

This equipment has been tested and found to comply with the limits for a Class B digital device, pursuant to Part 15 of the FCC Rules.

These limits are designed to provide reasonable protection against harmful interference in a residential installation. This equipment generates, uses, and can radiate radio frequency energy and, if not installed and used in accordance with the instructions, may cause harmful interference to radio communications. However, there is no guarantee that interference will not occur in a particular installation.

If this equipment does cause harmful interference to radio or television reception, which can be determined by turning the equipment off and on, the user is encouraged to try to correct the interference by one or more of the following measures:

- Reorient or relocate the receiving antenna.
- Increase the separation between the equipment and receiver.
- Connect the equipment into an outlet on a circuit different from that to which the receiver is connected.
- Consult the dealer or an experienced radio/TV technician for help.

FCC Caution: To assure continued compliance, follow the attached installation instructions and use only shielded interface cables when connecting to peripheral devices. Any changes or modifications not expressly approved by the party responsible for compliance could void the user's authority to operate this equipment.

This device complies with Part 15 of the FCC Rules.

Operation is subject to the following two conditions:

- (1) This device may not cause harmful interference, and
- (2) this device must accept any interference received, including interference that may cause undesired operation.

Supplier's Declaration of Conformity

Trade Name: Panasonic

Model No.: DP-UB150

Responsible Party: Panasonic Corporation of North America
Two Riverfront Plaza, Newark, NJ 07102-5490

Support Contact: <http://shop.panasonic.com/support>

Conforms to UL STD 62368-1.

PRIVACY POLICY (excerpt)

Panasonic Corporation, a company having its registered office of 1006, Oaza Kadoma, Kadoma City, Osaka 571-8501, Japan, automatically collects personal data such as IP address and/or Device ID from your device as soon as you connect it to the Internet. We do this to protect our customers and the integrity of our Service as well as to protect the rights or property of Panasonic. You have a right of access, rectification and objection to in certain circumstances, a right of erasure, restriction of processing, data portability and a right to object to other forms of processing. If you wish to exercise any of the above rights and/or wish to know more about the processing of your personal data in this context, please refer to the full text of our privacy policy displayed at "Legal Notices" of your device.

Precautions

WARNING

Unit

To reduce the risk of fire, electric shock or product damage,

- Do not expose this unit to rain, moisture, dripping or splashing.
- Do not place objects filled with liquids, such as vases, on this unit.
- Use the recommended accessories.
- Do not remove covers.
- Do not repair this unit by yourself. Refer servicing to qualified service personnel.

AC adaptor

The power plug is the disconnecting device.

Install this unit so that the power plug can be unplugged from the socket outlet immediately.

Small object

Keep the batteries out of reach of children to prevent swallowing.

CAUTION

Unit

- This unit utilizes a laser. Use of controls or adjustments or performance of procedures other than those specified herein may result in hazardous radiation exposure.
- Do not place sources of naked flames, such as lighted candles, on this unit.
- Some portions of this unit may become hot during use. When moving or cleaning this unit, disconnect the AC adaptor and wait for 3 minutes or longer.

Placement

To reduce the risk of fire, electric shock or product damage,

- Do not install or place this unit in a bookcase, built-in cabinet or in another confined space. Ensure this unit is well ventilated.
- Do not obstruct this unit's ventilation openings with newspapers, tablecloths, curtains, and similar items.
- Do not place the unit on amplifiers/receivers or equipment that may become hot. The heat can damage the unit.

Batteries

Mishandling of batteries can cause electrolyte leakage and may cause a fire.

- Danger of explosion if battery is incorrectly replaced. Replace only with the type recommended by the manufacturer.
- When disposing of the batteries, please contact your local authorities or dealer and ask for the correct method of disposal.
- Do not mix old and new batteries or different types at the same time.
- Do not heat or expose to flame.
- Do not leave the battery(ies) in a car exposed to direct sunlight for a long period of time with doors and windows closed.
- Do not take apart or short circuit.
- Do not recharge alkaline or manganese batteries.
- Do not use batteries if the covering has been peeled off.

Remove batteries if you do not intend to use the remote

control for a long period of time. Store in a cool, dark place.

Avoid the use in the following conditions

- High or low extreme temperatures during use, storage or transportation.
- Replacement of a battery with an incorrect type.
- Disposal of a battery into fire or a hot oven, or mechanically crushing or cutting of a battery, that can result in an explosion.
- Extremely high temperature and/or extremely low air pressure that can result in an explosion or the leakage of flammable liquid or gas.

AC adaptor

This AC adaptor operates on AC between 110 V and 240 V. But

- In the U.S.A. and Canada, the AC adaptor must be connected to a 120 V AC power supply only.
- When connecting to an AC supply outside of the U.S.A. or Canada, use a plug adaptor to suit the AC outlet configuration.

Restriction on use of unauthorized copied content

This unit adopts the following technology for copyright protection.

Cinavia Notice

This product uses Cinavia technology to limit the use of unauthorized copies of some commercially-produced film and videos and their soundtracks. When a prohibited use of an unauthorized copy is detected, a message will be displayed and playback or copying will be interrupted.

More information about Cinavia technology is provided at the Cinavia Online Consumer Information Center at <http://www.cinavia.com>. To request additional information about Cinavia by mail, send a postcard with your mailing address to:

Cinavia Consumer Information Center, P.O. Box 86851, San Diego, CA, 92138, USA.

To dispose or transfer this unit

The unit may keep the user settings information in the unit. If you discard this unit either by disposal or transfer, then follow the procedure to return all the settings to the factory presets to delete the user settings. (⇨ 25, "To return all settings to the factory preset.")

- The operation history may be recorded in the memory of this unit.

Table of contents

IMPORTANT SAFETY INSTRUCTIONS	2
Precautions	3

Getting Started

Accessories	5
Unit and media care	5
Playable media	6
Control reference guide	8
Connecting to a TV	10
Connecting to an amplifier/receiver	11
Connecting to the network	12
Settings	13

Playback

HOME menu	15
Playback	15
“HDMI CEC”	18
Option menu	19

Reference

Setup menu	21
Troubleshooting guide	25
Specifications	29
Licenses	31
Limited Warranty	33
Referencia rápida en español (Spanish Quick Reference)	34
Index	Back cover

To enjoy Ultra HD Blu-ray Disc featured with High Dynamic Range (HDR)

If you see a message about High Dynamic Range (HDR) compatible issue while an Ultra HD Blu-ray Disc is played back, please check your TV settings as follows.

An example of the message:

“This player is not connected to a High Dynamic Range (HDR) compatible TV.”

- 1) When you use a Panasonic TV that is compatible with 4K/High Dynamic Range (HDR) and was released in 2015 or later, enable the HDR setting of the TV. (This setting may not be available depending on the TV. Refer to the operating instructions of the TV for details.)
- 2) If you use a TV not from Panasonic, compatible with 4K and High Dynamic Range (HDR), please refer to the operating instructions of the TV.
- 3) When you play a High Dynamic Range (HDR) disc on a TV without High Dynamic Range (HDR) capability, the disc can be played back (in non-HDR quality) even if the message appears.

Accessories

Check the supplied accessories before using this unit.

1 Remote control

(N2QAYYA000217)

2 Batteries for remote control

1 AC adaptor

(TXH0009AA)



- Product numbers are provided in this Owner's Manual correct as of February 2020. These may be subject to change.
- Do not use AC adaptor with other equipment.
- Do not use any other AC adaptors except the supplied one.

■ Using the remote control

Insert the batteries to the terminal so that it (+ and -) matches those in the remote control.

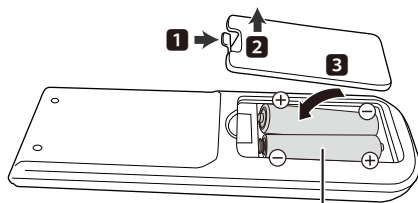

R03/LR03, AAA

(Alkaline or manganese batteries)

Point it at the remote control signal sensor on this unit. (⇒ 9)

Unit and media care

■ Clean this unit with a soft, dry cloth

- Never use alcohol, paint thinner or benzine to clean this unit.
- Before using chemically treated cloth, carefully read the instructions that came with the cloth.

■ This unit's lens

Use the lens cleaner (not supplied) to clean the unit's lens.

■ Clean discs

DO

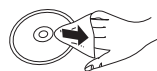

DO NOT









Wipe with a damp cloth and then wipe dry with a dry cloth.

■ Disc handling precautions

- Handle discs by the edges to avoid inadvertent scratches or fingerprints on the disc.
- Do not attach labels or stickers to discs.
- Do not use disc cleaning sprays, benzine, thinner, static electricity prevention liquids or any other solvent.
- Do not use the following discs:
 - Discs with exposed adhesive from removed stickers or labels (rented discs, etc.).
 - Discs that are badly warped or cracked.
 - Irregularly shaped discs, such as heart shapes.

Playable media

Device	Media markings	Device types	Contents format
BD		Ultra HD Blu-ray ^{*1,2}	Video
		BD-Video	Video
		BD-RE BD-RE DL	Video, MKV, MP4, MPEG2, JPEG, MPO, AAC, AIFF, ALAC, DSD (DFF, DSF), FLAC, MP3, WAV, WMA
		BD-R BD-R DL	
DVD		DVD-Video	Video
		DVD-R	Video, AVCHD, MKV, MP4, MPEG2, JPEG, MPO, AAC, AIFF, ALAC, DSD (DFF, DSF), FLAC, MP3, WAV, WMA
		DVD-R DL	
		DVD-RW	Video, AVCHD
	—	+R/+RW/+R DL	
CD		Music CD	Music [CD-DA]
	—	CD-R CD-RW	MKV, MP4, MPEG2, JPEG, MPO, AAC, AIFF, ALAC, FLAC, MP3, Music [CD-DA], WAV, WMA
USB	—	USB devices (up to 4 TB)	AVCHD, AVCHD 3D, MKV, MP4, MPEG2, JPEG, MPO, AAC, AIFF, ALAC, DSD (DFF, DSF), FLAC, MP3, WAV, WMA

• See pages 7 and 29 for more information on the types of content that can be played.

*1 See "Enjoying Ultra HD Blu-ray" (⇒ 17)

*2 Unless otherwise indicated, BD-Video content includes Ultra HD Blu-ray content in this Owner's Manual.

■ Types of discs that cannot be played by this unit

Any other disc that is not specifically supported or previously described.

- DVD-RAM
- Super Audio CD
- Photo CD
- DVD-Audio
- Video CD and Super Video CD
- HD DVD

■ Region management information

The unit can play back BD-Video/DVD-Video discs of the following regions codes, including "ALL":

Example: BD-Video DVD-Video



- The unit cannot playback DVD-Video discs in PAL format.

■ Finalize

Any DVD-R/RW/R DL, +R/+RW/+R DL and CD-R/RW that are recorded by a recorder need to be finalized by the recorder to play on this unit.

Please refer to the recorder's Owner's Manual.

■ BD-Video

- This unit supports high bit rate audio (Dolby® Digital Plus, Dolby® TrueHD, DTS-HD® High Resolution Audio and DTS-HD® Master Audio) adopted in BD-Video.
- If "Dolby Audio" is set to "PCM" and "DTS Neo:6" is set to "Off", the maximum possible number of Dolby® sound is 2 ch PCM. (⇒ 22)

■ 3D

3D videos and 3D still pictures can be played back when this unit is connected to a 3D compatible TV using a High Speed HDMI Cable.

■ Music CD

- Operation and sound quality of CDs that do not comply with CD-DA specifications (copy control CDs, etc.) cannot be guaranteed to work.
- The digital audio content side of a DualDisc does not meet the technical specifications of the Compact Disc Digital Audio (CD-DA) format so playback may not be possible.

■ USB device

- Connect a USB device while the Home screen is displayed.
- This unit does not guarantee connection with all USB devices.
- This unit does not support USB device charging.
- FAT12, FAT16, FAT32, and NTFS file systems are supported.
- This unit supports USB 2.0 High Speed.
- This unit supports an HDD formatted in FAT32 and NTFS. If the HDD is not recognized, the power to the HDD may not be supplied. Supply power from an external source.

■ BD-RE, BD-R

This unit may not correctly play back the audio portion of a video recorded to a disc in multiple languages with a Blu-ray disc recorder.



- It may not be possible to play the above media in some cases due to the type of media, the condition of the recording, the recording method, and how the files were created.
- The producers of the disc can control how discs are played, so you may not always be able to control play as described in this Owner's Manual. Read the disc's instructions carefully.

Control reference guide

■ Remote control

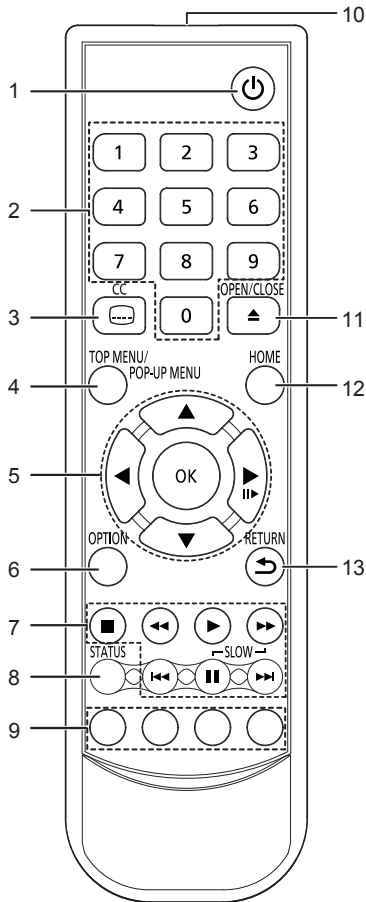

- 1 Turn the unit on and off
- 2 Select title numbers, etc./Enter numbers
- 3 Show Closed Caption setup screen
- 4 Show Top menu/Pop-up menu (⇒ 16)
- 5 [▲, ▼, ◀, ▶] : Move the highlight for selection
[OK] : Confirm the selection
(▢▶) : Frame-by-frame (⇒ 16)
- 6 Show Option menu (⇒ 19)
- 7 Basic playback control buttons (⇒ 15)
- 8 Show the status messages (⇒ 16)
- 9 Colored buttons (red, green, yellow, blue)
Used for various purposes depending on the screen
- 10 Transmit the remote control signal
- 11 Open or close the disc tray (⇒ 9)
- 12 Show HOME menu (⇒ 15)
- 13 Return to previous screen

■ Available keys for HDMI CEC (⇒ 18)

- 2 Number keys
- 5 [▲, ▼, ◀, ▶]/[OK] button
- 6 Option button
- 7 Basic playback control buttons
- 9 Colored buttons (red, green, yellow, blue)
- 13 Return button



- When other Panasonic devices respond to this remote control, change the remote control code of other Panasonic devices to other than code 1.

■ Front

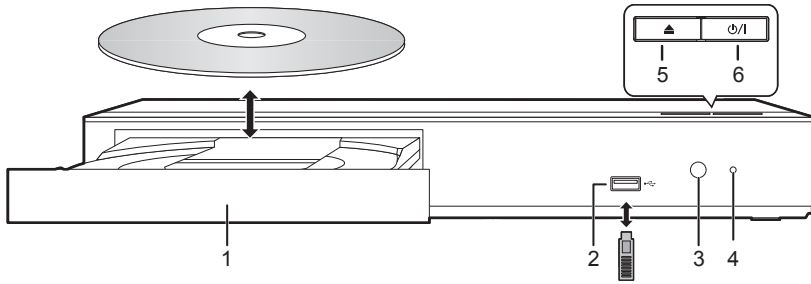

- | | |
|--------------------------------------------------------------------------------------------------------------------------------------------------------------------------------------------------------------------------------------------|------------------------------------------------------------------------------------------------------------------------------------------------------------------------------------------------------------------------------------------------------------------------------------------------------------------------------------------|
| <p>1 Disc tray</p> <p>2 USB port (≡ DC 5 V 500 mA)
This port supports USB 2.0 High Speed.</p> <p>3 Remote control signal sensor
Distance: Within approx. 7 m (23 feet)
Angle: Approx. 20° up and down, 30° left and right</p> | <p>4 POWER LED
The LED lights up when the unit is turned on, and flashes when error occurs. (⇒ 28)</p> <p>5 Open or close the disc tray</p> <p>6 Standby/on switch (⬆/⬇) (⇒ 13)
Press to switch the unit from on to standby mode or vice versa. In standby mode, the unit is still consuming a small amount of power.</p> |
|--------------------------------------------------------------------------------------------------------------------------------------------------------------------------------------------------------------------------------------------|------------------------------------------------------------------------------------------------------------------------------------------------------------------------------------------------------------------------------------------------------------------------------------------------------------------------------------------|

CAUTION

Do not place objects in front of the unit. The disc tray may collide with objects when it is opened, and this may cause malfunction.



- When inserting a media item, ensure that it is facing the correct way, which is the right side facing up.
- If you connect a Panasonic product with a USB connection cable, the setup screen may be displayed on the connected equipment. For details, refer to the instructions for the connected equipment.

■ Rear

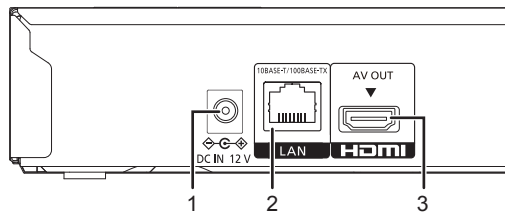

- | | |
|----------------------------------------------------------------|--------------------------------------|
| <p>1 DC IN (12 V) terminal (⇒ 10)</p> <p>2 LAN port (⇒ 12)</p> | <p>3 HDMI AV OUT terminal (⇒ 10)</p> |
|----------------------------------------------------------------|--------------------------------------|

The symbols on this product (including the accessories) represent the following.

~	AC
≡	DC
□	Class II equipment (The construction of the product is double-insulated.)

Connecting to a TV

4K images can be played back when this unit is connected to 4K compatible TV.

- Before making any connections, please disconnect all the units from AC power.
(Connect the AC adaptor after making all connections.)
- Use the High Speed HDMI cables. Non-HDMI-compliant cables cannot be utilized.
- This unit consumes a small amount of AC power (⇒ 29) even when turned off in standby mode.
For the purpose of energy conservation, the unit should be disconnected if you will not be using it for extended period of time.
- The unit is in the standby condition when the AC adaptor is connected. The primary circuit is always “live” as long as the AC adaptor is connected to an electrical outlet.

■ Enjoying 4K output

- To enjoy images in 4K/60p, you need an HDMI cable that supports 18 Gbps.
When outputting 1080p or 24p (4K) signal, please use HDMI cables 5.0 meters (16.4 ft.) or less.
It is recommended that you use Panasonic's HDMI cable.
- **If you connect this unit to a 4K-compatible TV and perform “Easy Setting”, 4K/60p will be automatically selected. (⇒ 13, 24)**
- To view Ultra HD Blu-ray content in 4K/HDR format, connect to the HDMI terminal of a device that supports HDCP2.2, 4K/60p (4:4:4), and HDR signals that meet Ultra HD Blu-ray standards.

Enjoying video and audio with a 4K-compatible TV

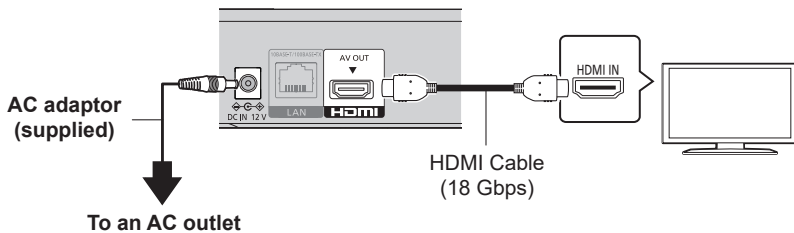

Connecting to an amplifier/receiver

Enjoying video with a 4K-compatible TV and audio with a 4K-compatible amplifier

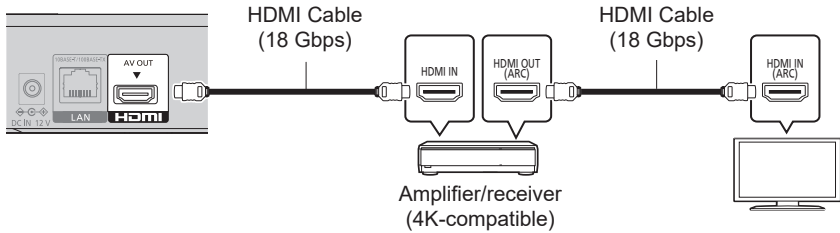

-  About ARC:
- When using the TV or amplifier/receiver that does not have the indication of “(ARC)” (non-ARC-compatible) on the HDMI terminal, the amplifier/receiver and TV must also be connected using an optical digital cable or coaxial cable in order to enjoy the TV's sound through the amplifier/receiver.

Connecting an amplifier to a 4K-compatible TV

3D or 4K images can be played back when this unit is connected to a 3D or 4K compatible TV.

- This connection only supports up to 5.1ch.
- To connect a TV and amplifier with an HDMI cable, connecting terminals on both the TV and amplifier must be ARC-compatible. (⇒ above, “About ARC”)

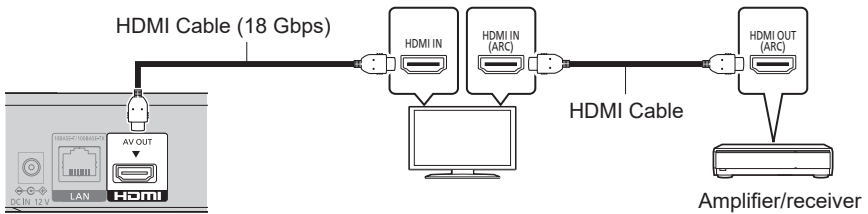

Connecting to the network

The following services can be used when this unit is connected to broadband.

- Firmware can be updated (⇒ 14)
- You can enjoy BD-Live (⇒ 17)

For details about connection method, refer to the instructions supplied with the connected equipment.

LAN cable connection

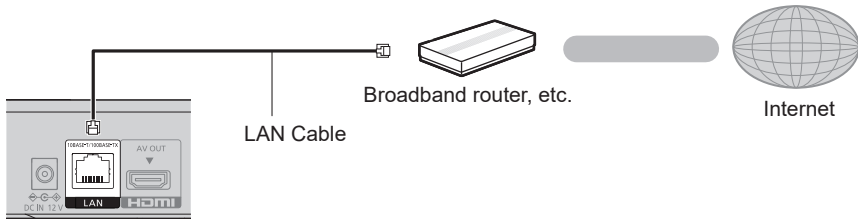

- Use category 5e or above straight LAN cables (STP) when connecting to peripheral devices.
- Inserting any cable other than a LAN cable in the LAN port can damage the unit.

Settings

The following settings can be performed anytime in the Setup menu. (⇒ 23, 24)

Easy Setting

After connecting your new player for the first time and pressing [⏻], the basic settings screen will appear.

Preparation

Turn on the TV and select the appropriate video input.

1 Press [⏻].

Setup screen appears.

2 Follow the on-screen instructions to continue with the settings.

(e.g., “Quick Start”)

■ When connected to a 4K/60p-compatible TV

When connected to a 4K/60p-compatible TV, you can set the video output format.

4K(50p/60p) Output

Start connection check with your 4K TV.
Once connection check is started and if the video is not displayed correctly, please wait for the next display.
The connection check could take up to 30 seconds to display the new message screen.

Start



Follow the on-screen instructions to set the format.



- To reconnect this unit to a 4K/60p-compatible TV after connecting this unit to a 2K-compatible TV and completing “Easy Setting”, set “4K60p Output” to “4K/60p(4:4:4)” or “4K/60p(4:2:0)”. (⇒ 21)

Easy Network Setting

After completing “Easy Setting”, you can perform “Easy Network Setting”.

Follow the on-screen instructions to establish your connection settings.

In your use of internet functions

You must agree to the terms of use for the Internet function and the privacy policy.
(⇒ 23, “Legal Notices”)



- Refer to the owner’s manuals of the hub or router.
- If you have trouble getting online on your PC after performing network settings on this unit, perform the network settings on your PC.

Firmware updates

This unit is capable of checking the firmware automatically when connected to the Internet via a broadband connection.

When a new firmware version is available, the following message is displayed.

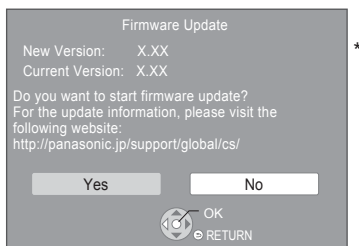

Select "Yes" to start downloading the firmware.

You cannot operate the unit until the update is complete. Don't remove the AC adaptor during the update. Removing the AC adaptor while the update is in progress may damage the unit. After the firmware is installed, unit will restart and the following screen will be displayed.

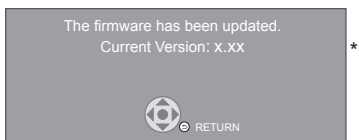

- You can also download the latest firmware from the following website and store it to a USB device to update the firmware.
<https://panasonic.jp/support/global/cs/>
(This site is in English only.)
When the update is complete, turn off and on the unit.
- To show the firmware version on this unit.
(⇒ 24, "Firmware Version Information")
- Downloading will require several minutes. It may take longer or may not work properly depending on the connection environment.

* "X.XX" represents the firmware version number.

HOME menu

Major functions of this unit can be operated from the HOME menu.

Preparation

Turn on the TV and select the appropriate video input.

1 Press [⏻] to turn on the unit.

It may take some time until the HOME menu is displayed.

2 Press [OK] or [◀, ▶] to select the item.

- Press [OK] or [▲, ▼] to select the item if necessary.

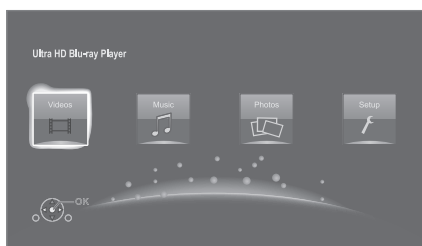

Videos/Music/Photos

Disc	Play back the contents. (⇒ right) <ul style="list-style-type: none"> • When multiple contents are recorded, select the types of contents or the title.
USB	<ul style="list-style-type: none"> • See "Playable media" (⇒ 6)

Setup

Player Settings	(⇒ 21)
Wallpaper	Changes the background of HOME menu.
USB Management	(⇒ 17)

To show the HOME menu

Press [HOME].



- Items to be displayed may vary with the media.

Playback

1 Insert the media.

Playback starts depending on the media.

2 Select the item to play and press [OK].

Repeat this step if necessary.



- DISCS CONTINUE TO ROTATE WHILE MENUS ARE DISPLAYED. Press [■] when you have finished playback to protect the unit's motor, your TV screen and so on.
- When the following conditions are met, still pictures are played back in 4K regardless of the image quality.
 - The unit is connected to a 4K compatible TV
 - "Resolution" is set to "Auto" or "4K" (⇒ 21)
- This unit can not output 4K images when playing back in 3D.
- It is not possible to play back AVCHD and MPEG2 videos which have been dragged and dropped or copied and pasted to the media.
- To enjoy BD-Video that supports Dolby Atmos® or DTS:X® (⇒ 22)

Operations during playback

Some operations may not work depending on the media and contents.

Stop

Press [■].

The stopping point is memorized.

Resume play function

Press [▶] to restart from this point.

- The point is cleared if the media is removed.
- On BD-Video discs including BD-J, the resume play function does not work.

Pause

Press [II].

- Press [II] again or [▶] to restart play.

Search/Slow motion

Search

While playing, press [◀◀] or [▶▶].

- Ultra HD Blu-ray, MKV, MP4 and MPEG2: Audio is not heard. (When “Voice Guidance Setting” is set to “On”, audio is not heard regardless of the media.)

Slow motion

While paused, press [▶▶].

- MKV, MP4 and MPEG2: Not effective.

The speed increases up to 5 steps.

- Music, MP3, etc.: The speed is fixed to a single step.
- Press [▶] to revert to normal playback speed.

Skip

While playing or paused, press [◀◀] or [▶▶].

Skip to the title, chapter or track.

Frame-by-frame

While paused, press [▶] (III▶).

- Each press shows the next frame.
- Press and hold to change in succession forward.
- Press [▶] to revert to normal playback speed.
- MKV, MP4 and MPEG2: Not effective.

Show top menu/pop-up menu

Press [TOP MENU/POP-UP MENU].

Select the item and press [OK].

Show the status messages

While playing, press [STATUS].

The status messages give you information about what is currently being played. Each time you press [STATUS], the display information may change or disappear from the screen.

- Depending on media and contents, the display may change or not appear.

e.g., Ultra HD Blu-ray

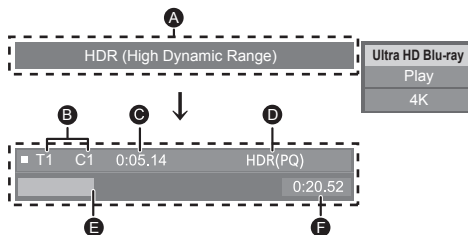

A Displayed when an HDR (High Dynamic Range) video signal is being output.

- “Dynamic Range Conversion Output” : The video signal is converted to SDR (Standard Dynamic Range)

B T: Title, P: Program, C: Chapter

C Elapsed time in the title

D Method of HDR (High Dynamic Range) video

E Current position

F Total time

e.g., JPEG

Date	11.12.2010	1/26
Size	500 x 375	
Manufacturer		
Equipment		

Enjoying Ultra HD Blu-ray

You can enjoy the playback of Ultra HD Blu-ray discs with this unit.

Preparation

- For 4K/HDR viewing, connect to a device (TV, etc.) and HDMI terminals that support HDCP2.2*¹, 4K/60p (4:4:4) and HDR signals that meet Ultra HD Blu-ray standards. (⇒ 10)

Due to copyright restrictions, it may not be possible to play back certain discs unless this unit is connected to the Internet.



- When connected to a device or terminal that does not support HDCP2.2*¹, this unit applies Dynamic Range Conversion*² to HDR signals to output them in 2K resolution. In addition, depending on the disc, it may not be possible to perform playback correctly.
- When connected to a device or terminal that supports 4K/60p (4:2:0/8 bit) and lower, this unit plays back 60p content by applying Dynamic Range Conversion*² to its HDR signals to output them.
- When connected to a device or terminal that does not support 4K resolution, this unit applies Dynamic Range Conversion*² to HDR signals to output them in 2K resolution.
- When connected to a device or terminal that does not support HDR, this unit applies Dynamic Range Conversion*² to HDR signals to output them. In addition, depending on the disc, it may not be possible to output content in 2K resolution or perform playback correctly.

*1 HDCP is a technology designed to prevent illegal copying. "2.2" represents a version.

*2 Dynamic Range Conversion is a function that converts HDR video signals into video signals suited to TVs that do not support HDR input.

Enjoying 3D video and photos

Preparation

- Connect this unit to a 3D compatible TV. (⇒ 10)
- Perform the necessary preparations for the TV.
- Play back following the instructions displayed on the screen.
- 3D Settings (⇒ 20, 23)



- Please refrain from viewing 3D images if you do not feel well or are experiencing visual fatigue. In the event that you experience dizziness, nausea, or other discomfort while viewing 3D images, discontinue use and rest your eyes.
- 3D video might not output the way it is set in "Resolution" and "24p Output" (⇒ 21).
- When playing back 3D photos from "Photos" screen, select from the "3D" list. (Still pictures in "2D" are played back in 2D.) If "2D" and "3D" indications are not displayed, press the red button on the remote control to switch the view of playback contents.

Enjoying BD-Live

With "BD-Live" discs, you can enjoy bonus contents that use Internet access.

For this BD-Live function, connection of a USB device is necessary along with Internet connection.

- 1 Perform network connection and settings.** (⇒ 12, 13)
- 2 Connect a USB device with 1 GB or more free space.**
 - The USB device is used as the local storage.
- 3 Insert the disc.**

■ **Deleting data on the USB device**
Select "USB Management" in the HOME menu (⇒ 15), then select "BD-Video Data Erase" and press [OK].



- The usable functions and the operating method may vary with each disc, please refer to the instructions on the disc and/or visit their website.
- "BD-Live Internet Access" may need to be changed for certain discs. (⇒ 23)

Slideshow

Play a slideshow of photos and adjust various settings during the playback.

- 1 Insert the media.
- 2 Select "View Photos".
- 3 Select an item and press the green button.

The following items can be set.

Start Slideshow	Start the slideshow. You can display still pictures in the selected folder one by one at a constant interval.
Display Interval	Change the display interval.
Transition Effect	Select the effect when sliding pictures.
Repeat Play	Set whether to repeat the slideshow.



- Still pictures displayed as "⊠" cannot be displayed as thumbnail with this unit.

"HDMI CEC"

This unit supports "HDMI CEC" (Consumer Electronics Control) function.

You can use this function by connecting the equipment that supports "HDMI CEC" with an HDMI cable.

See the owner's manuals for connected equipment for operational details.

Preparation

- ① Set "HDMI CEC" to "On" (⇒ 24). (The default setting is "On".)
- ② Set the "HDMI CEC" operations on the connected equipment (e.g., TV).
- ③ Turn on all "HDMI CEC" compatible equipment and select this unit's input channel on the connected TV so that the "HDMI CEC" function works properly.

Repeat this procedure when the connections or settings are changed.

Automatic input switching Power on link

When the unit starts playback, the TV will automatically switch the input channel and the screen of the unit will be displayed. Additionally when the TV is off, the TV will automatically turn on.

Power off link

All connected equipment compatible with "HDMI CEC", including this unit, automatically turns off when you switch the TV off.

Easy control only with TV remote control

By using the TV remote control, you can perform the same operations as you use the remote control of this unit. (⇒ 8)



- This unit supports the "HDMI CEC" (Consumer Electronics Control) function. However, operation cannot be guaranteed on all HDMI CEC devices.

Option menu

A variety of playback operations and settings can be performed from this menu.

Available options differ depending on the playing contents and the condition of the unit.

1 Press [OPTION].

e.g., Ultra HD Blu-ray

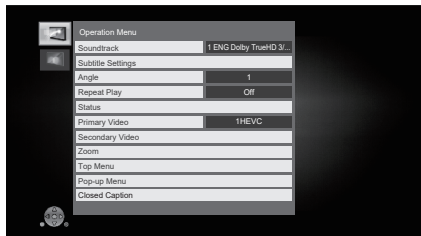

2 Select an item and change the settings.

To exit the screen

Press [OPTION].

Regarding Language : (⇒ 30)

Operation Menu

■ Soundtrack

Show or change the soundtrack.

■ Audio channel

Select the audio channel number.

■ Subtitles

■ Subtitle Settings

Change the subtitle settings.

■ Angle

Select the number of the angle.

■ Repeat Play

Select the item that you want to repeat.

- You can repeat the playback of a chapter, playlist, the entire disc, etc., but the items displayed will differ depending on the type of the media.
- Select "Off" to cancel.

■ Shuffle

Select whether to play shuffle or not.

■ Start Slideshow

Start the slideshow.

■ Status

Show the status messages.

■ Rotate Right

■ Rotate Left

Rotate the still picture.

■ Wallpaper

Set the still picture to the wallpaper of HOME menu. (⇒ 15)

■ Video

The recording method of original video appears.

■ Primary Video

The recording method of original primary video appears.

■ Secondary Video

Video	Select on/off for images. The recording method of original video appears. <ul style="list-style-type: none"> • During search/slow motion, only the primary video is displayed.
Soundtrack	Select on/off for audio and the language.

■ Zoom

Videos and pictures are magnified.

- On BD-Video discs including BD-J, the zoom function does not work.

■ Top Menu

Display Top Menu.

■ Pop-up Menu

Display Pop-up Menu.

■ Menu

Display Menu.

■ Closed Caption (⇒ 23)

You can only set "Manual setting" and "CC Reset" in the Setup menu.

These settings are also displayed by pressing [CC].

Video Settings

■ Dynamic Range Conversion Adjustment

When this unit is connected to a TV that does not support HDR (High Dynamic Range) input, HDR video is output converting to a SDR (Standard Dynamic Range) video signal. If you set a smaller value, their contrast will be reproduced more faithfully, but the entire screen will appear darker. To increase the brightness, set a larger value.

■ Picture Mode

Select the picture quality mode during play.

- If you select "User", you can change settings in "Picture Adjustment".
-

■ Picture Adjustment

Specific picture quality settings can be changed.

■ Progressive

Select the method of conversion for progressive output to suit the type of material being played.

- When the content is distorted, change the settings from "Auto" to "Video".
-

■ Reset to Default Video Settings

Return video settings to the factory defaults.

3D Settings

■ Signal Format

Original	Keep original picture format.
Side by side	3D picture format comprising of left and right screens.

■ Pop-Out Level

3D position for the Option menu or message screen, etc. can be adjusted during 3D playback.

Setup menu

Change the unit's settings if necessary. The settings remain intact even if you switch the unit to standby.

- 1 Press [HOME].
- 2 Select "Setup".
- 3 Select "Player Settings".

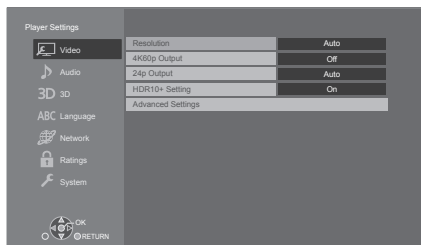

- 4 Select an item and change the settings.

To exit the screen

Press [HOME].

Video

■ Resolution

The items supported by the connected devices are indicated on the screen as "*". When any item without "*" is selected, the images may be distorted.

- If "Auto"*1 is selected, the best suited output resolution to the connected TV is automatically selected.

■ 4K60p Output

This unit automatically chooses to output images in 4K*2/60p when connected to a 4K/60p compatible TV.

- This item is available only when "Resolution" is set to "Auto" and "4K".
- To connect to a TV that supports 4K/60p (4:4:4/8 bit) or 4K/60p (4:2:2/12 bit), select "4K/60p(4:4:4)".

Images will not be output correctly with an HDMI cable that does not support 18 Gbps.

- To connect to a TV that supports 4K/60p (4:2:0/8 bit), select "4K/60p(4:2:0)".

■ 24p Output

Content recorded at 24p*3, such as BD-Video films, is output at 24p when played back.

- When this unit is connected to TV compatible with 4K/24p and "Resolution" is set to "Auto" or "4K", images will be output in 4K/24p.
- When this unit is connected to a TV compatible with 1080/24p and "Resolution" is set to "Auto", "1080i" or "1080p", images will be output in 1080/24p.
- If images output in 24p are distorted, change the setting to "Off".

■ HDR10+ Setting

You can set enable/disable of the HDR10+ function.

By changing this setting to "On", you can use the HDR10+ function under the following conditions:

- A device (TV, etc.) that supports HDR10+ is connected (⇒ 10).
- A disc that supports HDR10+ is played back.
- The "Video Settings" setting is disabled while using the HDR10+ function. (⇒ 20)

■ Advanced Settings

Press [OK] to show the following settings:

> Color Mode

This setting is for selecting color-space conversion of the image signal.

> Deep Color Output

Set the output method to be used when this unit is connected to a TV that supports Deep Color.

> HDR/Color Gamut Output

Set the output type for HDR (High Dynamic Range) material.

> 25p/50p Output

Set whether to output 25p/50p/50i material on Ultra HD Blu-ray/Blu-ray discs as 25p/50p material when a TV that supports 25p/50p is connected.

- If you select "Off", the output frame rate will be converted to 30p/60p.

► Contents Type Flag

Depending on the playback content, the TV will output adjusting to the optimal method when a TV that supports this function is connected.

- *1 It displays images at the highest resolution available on your TV.
- *2 A high resolution image/display technology of approximately 4000 (width) x 2000 (height) pixels.
- *3 A progressive image recorded at a rate of 24 frames per second (motion-picture film). Many BD-Video movie contents are recorded in 24 frames/second in accordance with the film materials.

Audio

■ Dynamic Range Compression

You can listen at low volumes but still hear dialog clearly.

(Dolby Digital, Dolby Digital Plus and Dolby TrueHD only)

- "Auto" is effective only when playing Dolby TrueHD.

■ Digital Audio Output

Press [OK] to show the following settings:

► Dolby Audio

► DTS/DTS-HD

► DSD Output Mode

Select the audio signal to output.

- Select "PCM" or "Off", when the connected equipment cannot decode the respective audio format. This unit decodes the audio format and transmits to the connected equipment.
- If you do not make proper settings the audio may be static or noisy.
- When playing DSD 11.2 MHz format file regardless of the settings for "DSD Output Mode", PCM signals are output from HDMI terminal.
- When "Voice Guidance Settings" is set to "On", regardless of the setting value of the following items (Dolby Audio, DTS/DTS-HD, DSD Output Mode), audio is output with PCM.
- If you set "Voice Guidance Setting" to "On", these settings will be fixed to "PCM".

► BD-Video Secondary Audio

Select whether or not to mix the primary and secondary audio (including the button click sound).

If "Off" is selected, the unit outputs the primary audio only.



• To enjoy BD-Video that supports Dolby Atmos® or DTS:X®

Connect this unit to an AV amplifier or similar device that supports it with an HDMI cable, and select the following settings:

- Dolby Audio: "Bitstream"
- DTS/DTS-HD: "Bitstream"
- BD-Video Secondary Audio: "Off"

Dolby Atmos is a trademark of Dolby Laboratories.

■ Downmix

Select the downmix system of multi-channel to 2-channel sound.

- Select "Surround encoded", when the connected equipment supports the virtual surround function.
- The downmix effect is not available when "Digital Audio Output" is set to "Bitstream".
- The audio will be output in "Stereo" in the following cases:
 - AVCHD playback
 - Playback of secondary audio (including the button click sound).

■ DTS Neo:6

2ch (2.1ch) audio is expanded to 7ch (7.1ch).

- This function works when the following conditions are met:
 - Audio recorded at 96 kHz or lower is output.
 - "Digital Audio Output" is set to PCM when audio other than "PCM" is output.

■ Voice Guidance Setting

Voice Guidance reads aloud various on-screen information, such as menu items, explanatory text, and currently-selected items. (It is also possible to display the "Voice Guidance Setting" screen by pressing and holding the [OPTION] button for at least 5 seconds while the HOME menu is displayed.)

- Information is read aloud in PCM audio format.
- When "On" is set, this unit operates in the manner described below.
 - "Dolby Audio" and "DTS/DTS-HD" in "Digital Audio Output" are fixed to "PCM". (⇒ left)
 - "DSD Output Mode" is set to "Off".

3D

■ 3D BD-Video Playback

Select the playback method of 3D compatible video software.

■ 3D AVCHD Output

Select the output method of 3D AVCHD videos.

■ 3D Playback Precautions

Set to display or hide the 3D viewing warning screen when playing back the 3D compatible video software.

Language

■ Audio Language

Choose the language for audio.

- If "Original" is selected, the original language of each disc will be selected.
- When the selected language is not recorded on the disc, or depending on how the navigation is created on the disc, it may playback in a different language than the selected language.
- Enter a code (⇒ 30) when you select "Other ****"

■ Subtitle Language

Choose the language for the subtitle.

- When "Auto" is selected, a subtitle for the language selected in the "Audio Language" is displayed only when the language other than the language selected in the "Audio Language" is played back.
- When the selected language is not recorded on the disc, or depending on how the navigation is created on the disc, it may playback in a different language than the selected language.
- Enter a code (⇒ 30) when you select "Other ****"

■ Menu Language

Choose the language for the disc menus.

- Enter a code (⇒ 30) when you select "Other ****"

■ Subtitle Text

Select a desired item according to the language used for MKV subtitles text.

- This item is displayed only after playing back a file.

■ On-Screen Language

Choose the language for menus and on-screen messages.

■ Closed Caption

Closed captioning services are dependent on contents, and the unit can display closed captions of both digital and analog types.

Press [OK] to show the following settings:

> Closed Caption Display

Set whether or not to display closed captions.

> Closed Caption Type

Select the closed caption type that matches the one of the content to be played back.

> Analog CC

Select the channel of analog closed captions.

> Digital CC

Select the channel of digital closed captions.

> Manual setting

Set the display style of closed captions.

> CC Reset

Restore the default "Closed Caption" settings.

Network

■ Easy Network Setting (⇒ 13)

■ Network Settings

Perform network-related settings individually. Press [OK] to show the following settings:

> IP Address/DNS Settings

This is for checking the state of the network connection and setting the IP address and DNS-related.

Press [OK] to show the respective setting.

> Proxy Server Settings

This is for checking the state of connection with the Proxy server and performing settings.

Press [OK] to show the respective setting.

> BD-Live Internet Access (⇒ 17)

You can restrict Internet access when BD-Live functions are used.

- If "Allow (Limited)" is selected, Internet access is permitted only for BD-Live contents which have content owner certificates.

■ Legal Notices

Displays the terms of service for the cloud services.

Ratings

The following items use the same password.
Don't forget your password.

■ DVD-Video Ratings

Set a ratings level to limit DVD-Video play.

■ BD-Video Ratings

Set an age limit of BD-Video (including Ultra HD Blu-ray) play.

System

■ Easy Setting

You can execute basic settings.

■ Display Settings

Press [OK] to show the following settings:

> Screen Saver Function

This is to prevent image retention on the screen.

- When this is set to "On":
If a list of playback content is displayed and there is no operation for 5 minutes or more, the screen switches to HOME menu automatically.
- While playing and pausing, etc., this function is not available.

> Status Messages

Choose whether to show status messages automatically.

> HDMI CEC

Set to use "HDMI CEC" function when connected via HDMI cable to a device that supports "HDMI CEC".

- Select "Off" when you do not want to use "HDMI CEC".

■ Quick Start

Speed of start-up from standby mode is increased.

- When set to "On", the internal control unit will be powered. The idle power consumption will increase so compared to when set to "Off".

■ Firmware Update (⇒ 14)

Press [OK] to show the following settings:

> Automatic Update Check

When this equipment remains connected to the Internet, it will check for the latest firmware version when it is turned on and you can update it if necessary.

> Update Now

You can update the firmware manually if a firmware update is available.

■ System Information

Press [OK] to show the following settings:

> License

Information about the software used by this unit is displayed.

> Firmware Version Information

Display firmware version of this unit.

■ Restore Default Settings

This returns all values in the Setup menu and the Option menu to the default settings, except for some settings of network, ratings, on-screen language, etc.

Troubleshooting guide

Before requesting service, please perform the following checks.

Do you have the latest firmware installed?

Panasonic is constantly improving the unit's firmware to ensure that our customers are enjoying the latest technology. (⇒ 14)



Make the following checks and visit our website for more information.

<http://shop.panasonic.com/support>



Or visit our website to find a service center.

You can find a service center near you easily on our website.

Other support information:

"Limited Warranty" (⇒ 33)

The following do not indicate a problem with this unit:

- Regular disc rotating sounds.
- Image disturbance during search.
- Image disturbance when replacing 3D discs.

■ Unit does not respond to remote control or unit's buttons.

Disconnect the AC adaptor, wait 1 minute, then reconnect the AC adaptor.

■ Cannot eject disc.

- ① While the unit is on
Press and hold [**▲**] on the main unit and the [0] on the remote control at the same time for more than 5 seconds.
– POWER LED starts to flash, and "00 RET" is displayed on the screen.
- ② Press [**▶**] (right) repeatedly on the remote control until "06 FTO" is displayed on the screen.
- ③ Press [OK].

General operation

To return to the factory default.

- ▶ Select "Yes" in "Restore Default Settings" in the Setup menu. (⇒ 24)

To return all settings to the factory preset.

- ▶ Reset the unit as follows:
 - ① While the unit is on
Press and hold [**▲**] on the main unit and the [0] on the remote control at the same time for more than 5 seconds.
– POWER LED starts to flash, and "00 RET" is displayed on the screen.
 - ② Press [**▶**] (right) repeatedly on the remote control until "08 FIN" is displayed on the screen.
 - ③ Press and hold [OK] for more than 5 seconds.

The remote control doesn't work properly.

- ▶ Change the batteries in the remote control. (⇒ 5)

Other Panasonic products respond to this remote control.

- ▶ Change the remote control code of other Panasonic products to other than code 1.

The TV tuner mode is not displayed when the TV is turned on.

- ▶ This phenomenon may occur, depending on the TV setting, when "Quick Start" is set to "On".
- ▶ Depending on the TV, this phenomenon may be prevented by reconnecting the HDMI cable to a different HDMI input terminal or by changing the HDMI auto connection setting.

This unit is turned off automatically.

- ▶ To save on electricity, this unit is turned off automatically depending on the media if there is no button operation for about 20 minutes when not playing back (such as when paused or displaying the menu, displaying still pictures, etc.).

**You have forgotten your ratings password.
You want to cancel the ratings level.**

- The ratings level returns to the factory defaults.
- ① While the unit is on
 - Press and hold [**▲**] on the main unit and the [0] on the remote control at the same time for more than 5 seconds.
 - POWER LED starts to flash, and “00 RET” is displayed on the screen.
- ② Press [**▶**] (right) repeatedly on the remote control until “03 VL” is displayed on the screen.
- ③ Press [OK].

The TV screen turns black.

- In the following cases, HDMI authentication takes place and a black screen is displayed:
 - When “24p Output” is set to “Auto”.
 - When the display is switched between 2D and 3D images.
 - When you quit the 4K playback by displaying another screen, including the HOME menu.

This unit does not recognize the USB connection correctly.

- Disconnect and re-connect the USB cable. If it still does not recognize the connection, turn this unit off and on again.
- USB devices may not be recognized by this unit when connected using the following :
 - a USB hub
 - a USB extension cable
- If you connect USB HDD to this unit, use the USB cable that is supplied with the HDD.
- If the USB HDD is not recognized, the power to the USB HDD may not be supplied. Supply power from an external source.

Picture

Images from this unit do not appear on the TV screen, or they are distorted.

- An incorrect resolution is selected in “Resolution”. Reset the setting as follows:
- The connected devices are changed. Reset the setting as follows:
 - ① While the unit is on
 - Press and hold [**▲**] on the main unit and the [8] on the remote control at the same time for more than 5 seconds.
 - ② Set the item again. (⇒ 21)
 - When Dolby Digital Plus, Dolby TrueHD, and DTS-HD[®] audio are not output properly, select “Yes” in “Restore Default Settings” (⇒ 24) and make proper settings.
 - “4K60p Output” will be set to “Off”.
Make the correct setting again. (⇒ 21)
 - When “3D BD-Video Playback” in the Setup menu is set to “Auto”, images may not be output depending on the connection method. After removing the disc from this unit, select “Set before play” in the Setup menu, and select “2D Playback” in the setup screen displayed when playing 3D discs. (⇒ 23)
 - When outputting in 4K, images may be distorted depending on the HDMI cable. Use an HDMI cable that supports 18 Gbps.

Video is not output in 4K or high-definition.

- Confirm that “Resolution” in the Setup menu is set properly. (⇒ 21)
- Confirm the HDMI cable, related connections and the compatibility of TV video input.
 - To output images in 4K, connect the HDMI cable to a 4K compatible terminal of the connected device. (⇒ 10)
 - To enjoy image in 4K/60p with the connected 4K-compatible TV, set “4K60p Output” to “4K/60p(4:4:4)” or “4K/60p(4:2:0)”. (⇒ 21)
 - If “4K60p Output” is set to “4K/60p(4:4:4)”, check to see if the connected HDMI cable supports 18 Gbps. (⇒ 10, 21)
 - When the unit is connected to a TV that supports formats up to 4K/60p(4:2:0) or “4K60p Output” is set to “4K/60p(4:2:0)”, material recorded in 4K/60p cannot be output in 4K/HDR.
To play back material recorded in 24p, set “24p Output” to “Auto”. (⇒ 21)

Cannot output video in HDR quality even when connected to an HDR-compatible TV.

- When connected to a device or terminal that does not support HDR, this unit applies Dynamic Range Conversion to HDR signals to output them. In addition, depending on the disc, it may not be possible to output content in 2K resolution or perform playback correctly. (⇒ 17)
- Video may not be output from your TV in HDR quality, depending on the content. Set "HDR/Color Gamut Output" to "HDR/BT.2020 (Auto)". (⇒ 21)

3D video is not output.

- Connect to a 3D compatible device (e.g., TV and amplifier/receiver).
- When a non-3D compatible amplifier/receiver is connected between this unit and a TV, 3D video is not output. (⇒ 11)
- Confirm the settings on this unit and the TV for 3D. (⇒ 17)

3D video is not output correctly as 2D.

- Select "Set before play" in the Setup menu, and select "2D Playback" in the setup screen displayed when playing 3D discs. (⇒ 23, "3D BD-Video Playback")
- Discs that have recorded titles with Side by side (2 screen structure) and that can be enjoyed in 3D are played back in accordance with the settings of the TV.

A black band is displayed around the edge of the screen.

The aspect ratio of the screen is abnormal.

- Adjust the aspect setting on the TV.

The screen brightness changes automatically.

- The screen brightness changes automatically to suit the scene while using the HDR10+ function.

No subtitles.

- When progressive output is on, closed captions/subtitles cannot be displayed.

The subtitles overlap closed captions recorded on discs.

- Turn off the subtitles or the closed caption setting on the TV. (⇒ 19)

Closed captions are not displayed.

- Confirm that the source content supports CC.
- Confirm the "Closed Caption Display" is set to "On". (⇒ 19, 23)
- Change the "Closed Caption Type" setting. (⇒ 19, 23)
- ⇒ Confirm the "Analog CC" or "Digital CC" is set properly (⇒ 19, 23)

Audio

Cannot hear the desired audio.

- Check the connections and the "Digital Audio Output" settings. (⇒ 11, 22)

There is no sound coming out.

- Refer to "Connecting to an amplifier/receiver" (⇒ 11) to check the audio output settings suited to the connections of your device.

Playback

Disc cannot be played.

- The disc is dirty. (⇒ 5)
- The disc is not finalized. (⇒ 7)
- Depending on the Ultra HD Blu-ray disc, it may not be possible to perform playback unless this unit is connected to the Internet.

Still pictures (JPEG) do not play back normally.

- The images that were edited on the PC, such as Progressive JPEG, etc., may not be played back.

I can't play back BD-Live.

- Confirm that this unit is connected to the broadband Internet. (⇒ 12)
- Confirm the "BD-Live Internet Access" settings. (⇒ 23)
- Confirm a USB device is connected to the USB port. (⇒ 9)

Network

I can't connect to the network.

- Confirm the network connection and settings. (⇒ 12, 13, 23)
- Check the owner's manuals for each device and connect accordingly.

Messages on the screen

No compatible content on the disc.

- You inserted an incompatible disc.

Cannot play this file.

- You tried to play a non-compatible video.

This disc is incompatible.

- You inserted an incompatible disc.
- The disc may be upside down.

⊖ This operation is not available.

- Some operations are unsupported by the unit.

IP address is not set.

- The "IP Address/DNS Settings" ⇒ "Advanced Settings" ⇒ "IP Address" is "---. ---. ---. ---". Set the "IP Address", "Subnet Mask", and "Default Gateway". (Select the automatic address acquisition if necessary.)

POWER LED

When the POWER LED is flashing other than during power up or down of this unit, check the message on the TV screen. If a message is not displayed on the TV screen, determine the type of the error by checking the way the POWER LED is flashing.

Symbols indicate the following states:

- | | |
|-------|-----------------|
| ◆ | Flash |
| — | No illumination |
| | Repetition |

◆◆◆◆◆◆◆.....

(Flashes)

- The copyright protected disc cannot be played back.
One of the devices connected to this unit (TV, amplifier, etc.) does not support copyright protection.

◆◆◆—◆◆◆—.....

(Flashes 3 times)

- The disc in use cannot be played back since the copyright information is invalid.

Specifications

General

Signal system	NTSC
Operating temperature range	+5 °C to +35 °C
Operating humidity range	10 % to 80 % RH (no condensation)
HDMI OUT (19 pin type A)	1 pc. Output Audio format : PCM, Dolby Digital, Dolby Digital Plus, Dolby TrueHD, DTS®, DTS-HD® High Resolution Audio, DTS-HD® Master Audio
USB port (Type A)	Front : 1 pc. DC 5 V, Max. 500 mA [High-Speed USB (USB 2.0)]
LAN (Ethernet) Port	1 pc. 10BASE-T/100BASE-TX
LASER Specification	Class 1 LASER Product Wave length: 770-800 nm (CDs)/ 650-666 nm (DVDs)/ 400-410 nm (BDs) Laser power: No hazardous radiation is emitted with the safety protection
Power supply	DC 12 V, 1.5 A (DC IN terminal)
Power consumption	Approx. 12 W
Power consumption in standby mode	Approx. 0.3 W (Quick Start: Off)
Dimensions (W x H x D) Including the projecting parts	320 mm x 46 mm x 193 mm (Approx. 12 5/8" x 1 13/16" x 7 5/8")
Mass (Weight)	Approx. 1.2 kg (2.7 lbs)

- Specifications are subject to change without notice.

File format

File format	Extension	Reference
MKV (Compression methods Video: H.264/HEVC Audio: AAC, PCM, Vorbis, FLAC)	“.MKV”, “.mkv”	<ul style="list-style-type: none"> • Resolution up to 3840x2160 30p, 4096x2160 24p. • The video file and subtitles text file are inside the same folder, and the file names are the same except for the file extensions. • Some MKV files may not be played back correctly, depending on the video resolution, frame rate condition, subtitle format and so on.
	Subtitles text file “.SRT”, “.srt”, “.SSA”, “.ssa”, “.ASS”, “.ass”	
mp4 (Compression methods Video: H.264/HEVC Audio: AAC)	“.MP4”, “.mp4”, “.MOV”, “.mov”	<ul style="list-style-type: none"> • Resolution up to 3840x2160 30p, 4096x2160 24p. (except MPEG2) • Some mp4/MPEG files may not be played back correctly, depending on the video resolution, frame rate condition and so on. • MOTION JPEG is not supported. • Depending on the audio compression method, only images may be played back and it may not be possible to output audio.
	MPEG (TS/PS) (Compression methods Video: MPEG2 /H.264*1/HEVC*1 Audio: AAC*1 /LPCM*2)	“.MPG”, “.mpg”, “.MPEG”, “.mpeg”, “.M2TS”, “.m2ts”, “.MTS”, “.mts”, “.TS”, “.ts”
JPEG	“.JPG”, “.jpg”, “.JPEG”, “.jpeg”	<ul style="list-style-type: none"> • MOTION JPEG and Progressive JPEG are not supported. • You may not be able to play back the file if you have edited the folder structure or the file name on a PC or other device.
MPO	“.MPO”, “.mpo”	3D still picture
MP3	“.MP3”, “.mp3”	This unit supports ID3 tags, but only titles, artist names and album names can be displayed.
FLAC	“.FLAC”, “.flac”	Maximum sampling rate: 192 kHz/24 bit
WAV	“.WAV”, “.wav”	Maximum sampling rate: 384 kHz/24 bit
AAC	“.M4A”, “.m4a”	This unit supports tags, but only titles, artist names and album names can be displayed. Maximum sampling rate: 48 kHz/320 kbps

File format	Extension	Reference
WMA	“.WMA”, “.wma”	This unit supports tags, but only titles, artist names and album names can be displayed. Maximum sampling rate: 48 kHz/385 kbps
DSD (DFF, DSF)	“.DSF”, “.dsf”, “.DFF”, “.dff”	2.8 MHz (2 ch/5.1 ch), 5.6 MHz (2 ch/5.1 ch), 11.2 MHz (2 ch only)
ALAC	“.M4A”, “.m4a”	This unit supports tags, but only titles, artist names and album names can be displayed. Maximum sampling rate: 192 kHz/24 bit
AIFF	“.aif”, “.aiff”	Maximum sampling rate: 384 kHz/24 bit

*1 TS only

*2 PS only

- With certain recording states and folder structures, the play order may differ or playback may not be possible.
- Up to 10,000 files and up to 300 folders can be displayed as playable data in each folder regardless of their format. (Even when the picture playback menu is displayed, for example, if a folder in the menu contains playable videos and music files, they are also counted as playable data.)

Audio information

The audio output differs depending on the settings on the unit. (⇒ 22, “Digital Audio Output”)

- The number of channels listed is the maximum possible number of output channels when connected to amplifier/receiver compatible with the respective audio format.

Output channel ⁴	Terminal	“Digital Audio Output”	
		“Bitstream” ⁷ / “On” ⁵	“PCM” ⁸ 1/ “Off” ⁵
HDMI OUT	Outputs using original audio ²	BD-Video : 7.1ch PCM ^{*2*3}	DVD-Video : 5.1ch PCM

*1 The maximum possible number of Dolby sound is 2ch PCM.

*2 When “BD-Video Secondary Audio” is set to “On”, the audio will be output as Dolby Digital, DTS[®] Digital Surround[™] or 5.1ch PCM. However, when playing BD-Video without secondary audio or navigation sounds, the audio is output as the original format.

*3 The audio output is amplified from 5.1ch or 6.1ch to 7.1ch depending on the DTS, Inc. specifications.

*4 When “DTS Neo:6” is set to “Cinema” or “Music”, 2ch (2.1ch) audio can be expanded to 7ch (7.1ch) and output. (⇒ 22)

*5 For “DSD Output Mode”

Language code list

Language	Code	Language	Code	Language	Code
Abkhazian:	6566	Gujarati:	7185	Rhaeto-Romance:	8277
Afar:	6565	Hausa:	7265	Romanian:	8279
Afrikaans:	6570	Hebrew:	7387	Russian:	8285
Albanian:	6381	Hindi:	7273	Samoan:	8377
Amharic:	6577	Hungarian:	7285	Sanskrit:	8365
Arabic:	6582	Icelandic:	7383	Scots Gaelic:	7168
Armenian:	7289	Indonesian:	7378	Serbian:	8382
Assamese:	6583	Interlingua:	7365	Serbo-Croatian:	8372
Aymara:	6589	Irish:	7165	Shona:	8378
Azerbaijani:	6590	Italian:	7384	Sindhi:	8368
Bashkir:	6665	Japanese:	7465	Singhalese:	8373
Basque:	6985	Javanese:	7487	Slovak:	8375
Bengali, Bangla:	6678	Kannada:	7578	Slovenian:	8376
Bhutani:	6890	Kashmiri:	7583	Somali:	8379
Bihari:	6672	Kazakh:	7575	Spanish:	6983
Breton:	6682	Kirghiz:	7589	Sundanese:	8385
Bulgarian:	6671	Korean:	7579	Swahili:	8387
Burmese:	7789	Kurdish:	7585	Swedish:	8386
Byelorussian:	6669	Laotian:	7679	Tagalog:	8476
Cambodian:	7577	Latin:	7665	Tajik:	8471
Catalan:	6577	Latvian, Lettish:	7686	Tamil:	8465
Chinese:	9072	Lingala:	7678	Tatar:	8484
Corsican:	6779	Lithuanian:	7684	Telugu:	8469
Croatian:	7282	Macedonian:	7775	Thai:	8472
Czech:	6783	Malagasy:	7771	Tibetan:	6679
Danish:	6865	Malay:	7783	Tigrinya:	8473
Dutch:	7876	Malayalam:	7776	Tonga:	8479
English:	6978	Maltese:	7784	Turkish:	8482
Esperanto:	6979	Maori:	7773	Turkmen:	8475
Estonian:	6984	Marathi:	7782	Twi:	8487
Faroeese:	7079	Moldavian:	7779	Ukrainian:	8575
Fiji:	7074	Mongolian:	7778	Urdu:	8582
Finnish:	7073	Nauru:	7865	Uzbek:	8590
French:	7082	Nepali:	7869	Vietnamese:	8673
Frisian:	7089	Norwegian:	7879	Volapük:	8679
Galician:	7176	Oriya:	7982	Welsh:	6789
Georgian:	7565	Pashto, Pushto:	8083	Wolof:	8779
German:	6869	Persian:	7065	Xhosa:	8872
Greek:	6976	Polish:	8076	Yiddish:	7473
Greenlandic:	7576	Portuguese:	8084	Yoruba:	8979
Guarani:	7178	Punjabi:	8065	Zulu:	9085
		Quechua:	8185		

Display languages list

Display Language	Language	Display Language	Language	Display Language	Language
ENG	English	JPN	Japanese	ARA	Arabic
FRA	French	CHI	Chinese	HIN	Hindi
DEU	German	KOR	Korean	PER	Persian
ITA	Italian	MAL	Malay	IND	Indonesian
ESP	Spanish	VIE	Vietnamese	MRI	Maori
NLD	Dutch	THA	Thai	BUL	Bulgarian
SVE	Swedish	POL	Polish	RUM	Romanian
NOR	Norwegian	CES	Czech	GRE	Greek
DAN	Danish	SLK	Slovak	TUR	Turkish
POR	Portuguese	HUN	Hungarian	*	Others
RUS	Russian	FIN	Finnish		

Licenses

"AVCHD", "AVCHD 3D", "AVCHD Progressive" and "AVCHD 3D/ Progressive" are trademarks of Panasonic Corporation and Sony Corporation.

Java is a registered trademark of Oracle and/or its affiliates.

Manufactured under license from Dolby Laboratories.

Dolby, Dolby Audio, and the double-D symbol are trademarks of Dolby Laboratories.

For DTS patents, see <http://patents.dts.com>.

Manufactured under license from DTS, Inc.

DTS, the Symbol, DTS and the Symbol together, DTS-HD, and the DTS-HD logo are registered trademarks or trademarks of DTS, Inc. in the United States and/or other countries.

© DTS, Inc. All Rights Reserved.

The product with Hi-Res Audio logo is conformed to High-Resolution Audio standard defined by Japan Audio Society. The logo is used under license from Japan Audio Society.

The terms HDMI and HDMI High-Definition Multimedia Interface, and the HDMI Logo are trademarks or registered trademarks of HDMI Licensing Administrator, Inc. in the United States and other countries.

<AVC>

This product is licensed under the AVC Patent Portfolio License for the personal use of a consumer or other uses in which it does not receive remuneration to (i) encode video in compliance with the AVC Standard ("AVC Video") and/or (ii) decode AVC Video that was encoded by a consumer engaged in a personal activity and/or was obtained from a video provider licensed to provide AVC Video. No license is granted or shall be implied for any other use. Additional information may be obtained from MPEG LA, L.L.C. See <http://www.mpegla.com>

<VC-1>

This product is licensed under the VC-1 Patent Portfolio License for the personal and non-commercial use of a consumer to (i) encode video in compliance with the VC-1 Standard ("VC-1 Video") and/or (ii) decode VC-1 Video that was encoded by a consumer engaged in a personal and non-commercial activity and/or was obtained from a video provider licensed to provide VC-1 Video. No license is granted or shall be implied for any other use. Additional information may be obtained from MPEG LA, L.L.C. See <http://www.mpegla.com>

"DVD Logo" is a trademark of DVD Format/Logo Licensing Corporation.

Windows is a trademark or a registered trademark of Microsoft Corporation in the United States and other countries.

Adobe is a trademark or registered trademark of Adobe Systems Incorporated in the United States and/or other countries.

Copyright 2004-2014 Verance Corporation. Cinavia™ is a Verance Corporation trademark. Protected by U.S. Patent 7,369,677 and worldwide patents issued and pending under license from Verance Corporation. All rights reserved.

HDR10+™ logo is a trademark of HDR10+ Technologies, LLC.

This product incorporates the following software:

- (1) the software developed independently by or for Panasonic Corporation,
- (2) the software owned by third party and licensed to Panasonic Corporation,
- (3) the software licensed under the GNU General Public License, Version 2.0 (GPL V2.0),
- (4) the software licensed under the GNU LESSER General Public License, Version 2.1 (LGPL V2.1), and/or
- (5) open source software other than the software licensed under the GPL V2.0 and/or LGPL V2.1.

The software categorized as (3) - (5) are distributed in the hope that it will be useful, but WITHOUT ANY WARRANTY, without even the implied warranty of MERCHANTABILITY or FITNESS FOR A PARTICULAR PURPOSE.

Please refer to the detailed terms and conditions thereof shown in the Player Settings menu.

At least three (3) years from delivery of this product, Panasonic will give to any third party who contacts us at the contact information provided below, for a charge no more than our cost of physically performing source code distribution, a complete machine-readable copy of the corresponding source code covered under GPL V2.0, LGPL V2.1 or the other licenses with the obligation to do so, as well as the respective copyright notice thereof.

Contact Information: oss-cd-request@gg.jp.panasonic.com

The source code and the copyright notice are also available for free in our website below.

<https://panasonic.net/cns/oss/>

(1) MS/WMA

This product is protected by certain intellectual property rights of Microsoft Corporation and third parties. Use or distribution of such technology outside of this product is prohibited without a license from Microsoft or an authorized Microsoft subsidiary and third parties.

(2) MS/PlayReady/Final Product Labeling

This product contains technology subject to certain intellectual property rights of Microsoft. Use or distribution of this technology outside of this product is prohibited without the appropriate license(s) from Microsoft.

(3) MS/PlayReady/End User Notices

Content owners use Microsoft PlayReady™ content access technology to protect their intellectual property, including copyrighted content. This device uses PlayReady technology to access PlayReady-protected content and/or WMDRM-protected content. If the device fails to properly enforce restrictions on content usage, content owners may require Microsoft to revoke the device's ability to consume PlayReady-protected content. Revocation should not affect unprotected content or content protected by other content access technologies. Content owners may require you to upgrade PlayReady to access their content. If you decline an upgrade, you will not be able to access content that requires the upgrade.

(4) Vorbis, FLAC

The software licenses are displayed when "License" in the Setup menu is selected. (⇒ 24)



Limited Warranty

Panasonic Products Limited Warranty

Limited Warranty Coverage (For USA Only)

If your product does not work properly because of a defect in materials or workmanship, Panasonic Corporation of North America (referred to as "the warrantor") will, for the length of the period indicated on the chart below, which starts with the date of original purchase ("warranty period"), at its option either (a) repair your product with new or refurbished parts, (b) replace it with a new or a refurbished equivalent value product, or (c) refund your purchase price. The decision to repair, replace or refund will be made by the warrantor.

Product or Part Name	Parts	Labor
Blu-ray Disc Player	1 Year	90 Days
All included Accessories (Except Non-Rechargeable Batteries)	90 Days	Not Applicable
Only Non-Rechargeable Batteries	10 Days	Not Applicable

During the "Labor" warranty period there will be no charge for labor. During the "Parts" warranty period, there will be no charge for parts. This Limited Warranty excludes both parts and labor for non-rechargeable batteries, antennas, and cosmetic parts (cabinet). This warranty only applies to products purchased and serviced in the United States. This warranty is extended only to the original purchaser of a new product which was not sold "as is".

Mail-In Service--Online Repair Request Online Repair Request

To submit a new repair request and for quick repair status visit our Web Site at <http://shop.panasonic.com/support>

When shipping the unit, carefully pack, include all supplied accessories listed in the Owner's Manual, and send it prepaid, adequately insured and packed well in a carton box. When shipping Lithium Ion batteries please visit our Web Site at <http://shop.panasonic.com/support> as Panasonic is committed to providing the most up to date information. Include a letter detailing the complaint, a return address and provide a daytime phone number where you can be reached. A valid registered receipt is required under the Limited Warranty.

IF REPAIR IS NEEDED DURING THE WARRANTY PERIOD, THE PURCHASER WILL BE REQUIRED TO FURNISH A SALES RECEIPT/PROOF OF PURCHASE INDICATING DATE OF PURCHASE, AMOUNT PAID AND PLACE OF PURCHASE. CUSTOMER WILL BE CHARGED FOR THE REPAIR OF ANY UNIT RECEIVED WITHOUT SUCH PROOF OF PURCHASE.

Limited Warranty Limits and Exclusions

This warranty ONLY COVERS failures due to defects in materials or workmanship, and DOES NOT COVER normal wear and tear or cosmetic damage. The warranty ALSO DOES NOT COVER damages which occurred in shipment, or failures which are caused by products not supplied by the warrantor, or failures which result from accidents, misuse, abuse, neglect, mishandling, misapplication, alteration, faulty installation, set-up adjustments, misadjustment of consumer controls, improper maintenance, power line surge, lightning damage, modification, introduction of sand, humidity or liquids, commercial use such as hotel, office, restaurant, or other business or rental use of the product, or service by anyone other than a Factory Service Center or other Authorized Servicer, or damage that is attributable to acts of God. **THERE ARE NO EXPRESS WARRANTIES EXCEPT AS LISTED UNDER "LIMITED WARRANTY COVERAGE". THE WARRANTOR IS NOT LIABLE FOR INCIDENTAL OR CONSEQUENTIAL DAMAGES RESULTING FROM THE USE OF THIS PRODUCT, OR ARISING OUT OF ANY BREACH OF THIS WARRANTY.**

(As examples, this excludes damages for lost time, travel to and from the servicer, loss of or damage to media or images, data or other memory or recorded content. The items listed are not exclusive, but for illustration only.)

ALL EXPRESS AND IMPLIED WARRANTIES, INCLUDING THE WARRANTY OF MERCHANTABILITY, ARE LIMITED TO THE PERIOD OF THE LIMITED WARRANTY.

Some states do not allow the exclusion or limitation of incidental or consequential damages, or limitations on how long an implied warranty lasts, so the exclusions may not apply to you.

This warranty gives you specific legal rights and you may also have other rights which vary from state to state. If a problem with this product develops during or after the warranty period, you may contact your dealer or Service Center. If the problem is not handled to your satisfaction, then write to:

Panasonic Corporation of North America
Consumer Affairs Department 8th Fl.
Two Riverfront Plaza
Newark NJ 07102-5490

PARTS AND SERVICE, WHICH ARE NOT COVERED BY THIS LIMITED WARRANTY, ARE YOUR RESPONSIBILITY.

Shop Accessories!

for all your Panasonic gear

Go to

<http://shop.panasonic.com/support>

Get everything you need to get the most out of your Panasonic products
Accessories & Parts for your Camera, Phone, A/V products, TV, Computers & Networking, Personal Care, Home Appliances, Headphones, Batteries, Backup Chargers & more...

Customer Services Directory

For Product Information, Operating Assistance, Parts, Owner's Manuals, Dealer and Service info go to <http://shop.panasonic.com/support>

For the hearing or speech impaired TTY: 1-877-833-8855

1912

The model number and serial number of this product can be found on either the back or the bottom of the unit. Please note them in the space provided below and keep for future reference.

MODEL NUMBER _____ DP-UB150 _____

SERIAL NUMBER _____

User memo:

DATE OF PURCHASE _____

DEALER NAME _____

DEALER ADDRESS _____

TELEPHONE NUMBER _____

Referencia rápida en español (Spanish Quick Reference)

Conexiones básicas

Conexión a un televisor compatible con HDMI

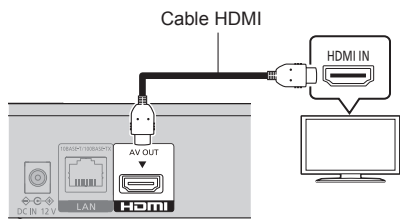

Conexión a un televisor compatible con HDMI y a un amplificador/receptor compatible con HDMI

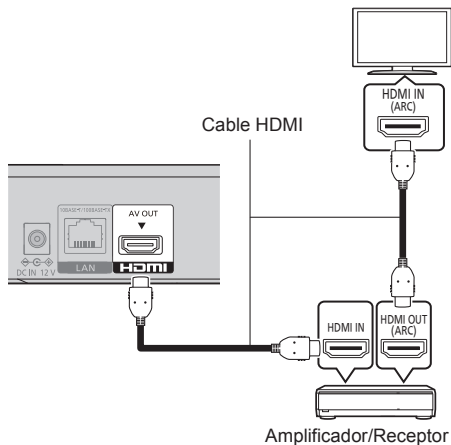

Conecte el adaptador de CA por último

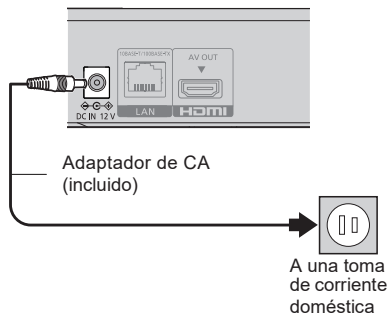

- Conéctelo cuando haya realizado el resto de conexiones.

Ahorro de energía

Esta unidad consume una pequeña cantidad de energía aunque esté ajustada en el modo de espera (Accionamiento rápido : Desactivado, aprox. 0,3 W). Para ahorrar energía cuando no vaya a utilizar la unidad durante mucho tiempo, desenchúfela de la toma de corriente.

Reproducción básica

Preparación

Encienda el televisor y seleccione la entrada de vídeo adecuada en el televisor.

1 Pulse [⏻] para encender la unidad.

Después de conectar su nuevo reproductor y pulsar el botón de encendido, aparecerá la pantalla de la configuración básica.

2 Inserte el medio.

Inicia la reproducción

Pulse [▶].

Detención

Pulse [■].

Se memoriza la posición de detención

Función de reanudación de la reproducción

Pulse [▶] para volver a iniciar a partir de esta posición.

- El punto se anula si se extrae el medio.
- En los discos BD-Vídeo que incluyen BD-J, la función de reanudación de la reproducción no funciona.

Pausa

Pulse [⏸].

- Vuelva a pulsar [⏸] o [▶] para reanudar la reproducción.

Búsqueda/Cámara lenta

Búsqueda

Durante la reproducción, pulse [◀◀] o [▶▶].

- Ultra HD Blu-ray, MKV, MP4 y MPEG2:
No se escucha sonido. (Cuando "Ajuste de la Guía por voz" está configurado como "Activado", el audio no se escucha con independencia del medio.)

Cámara lenta

Durante la pausa, pulse [▶▶].

- MKV, MP4 y MPEG2: No es eficaz.

La velocidad aumenta hasta 5 pasos.

- Música y MP3, etc.: La velocidad está fija en un solo paso.
- Pulse [▶] para volver a la velocidad de reproducción normal.

Saltar

Durante la reproducción o la pausa, pulse

[◀◀] o [▶▶].

Salte al título, capítulo o pista.

Index

A Audio Language	23	Soundtrack	19	U Ultra HD Blu-ray.	17
B BD-Live.	17	Subtitle	19, 23	USB device.	7
C Closed Caption	19, 23	N Network		24p	21
F File format	29	Connection	12	4K	13, 21
Firmware update	14	Setting.	13, 23		
H HDMI CEC.	18	P Pop-up Menu	19		
HDR.	4, 16	POWER LED.	9		
L LAN.	12	Q Quick Start	24		
Language		R Repeat Play	19		
Audio.	23	Restore Default			
Code list	30	Settings	24		
Menu.	23	Resume play function. . .	15		
On-screen	23	S Subtitle	19, 23		

USA Only: Disposal may be regulated in your community due to environmental considerations. For disposal or recycling information, please visit Panasonic website:

<https://www.panasonic.com/us/corporate/sustainability.html>

or call 1-888-769-0149.

CAUTION – VISIBLE AND INVISIBLE LASER RADIATION WHEN OPEN. DO NOT STARE INTO BEAM. FOR 21CFRCLASS II (IIa)
CAUTION – CLASS 2 VISIBLE AND INVISIBLE LASER RADIATION WHEN OPEN. DO NOT STARE INTO THE BEAM. IEC60825-1:CLASS 2
ATTENTION – RAYONNEMENT LASER VISIBLE ET INVISIBLE CLASSE 2. EN CAS D'OUVERTURE, NE PAS REGARDER DANS LE FAISCEAU.
FORSIGTIG – SYNLIG OG USYNLIG LASERSTRÅLING KLASSE 2. NÅR LÅGET ER ÅBENT, UNDGA AT SE LIGE IND I STRÅLEN.
VARO – AVATTAESSA OLET ALTTIINA LUOKAN 2 NÄKYVÄÄ JA NÄKYMÄTÖNÄ LASERSÄTEILYÄ, ÄLÄ TUJOTA SÄTEESEEN.
VARNING – KLASS 2 SYNLIG OCH OSYNLIG LASERSTRÅLNING NÄR DENNA DEL ÄR ÖPPNAD. STIRRA EJ IN I STRÅLEN.
VORSICHT – SICHTBARE UND UNSICHTBARE LASERSTRAHLUNG KLASSE 2. WENN ABDECKUNG GEÖFFNET, NICHT IN DEN STRAHL BLICKEN.
注意 – 打开时有可见及不可见激光辐射。避免光束照射。
注意 – ここを開くとクラス2の可視及び不可視レーザー放射が出る。ビームをのぞき込まないこと。 VQL2P54-1

(Inside of product)

Panasonic Corporation of North America



Two Riverfront Plaza, Newark, NJ 07102-5490

<http://shop.panasonic.com>