

Panasonic®

Owner's Manual High Definition Video Camera

Model No. **HC-V100**
HC-V100M

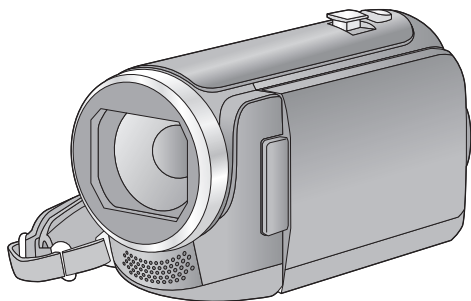

Before connecting, operating or adjusting this product, please read the instructions completely.

AVCHD™

HDMI

SD
XC™

DOLBY
DIGITAL
STEREO CREATOR

VIERA Link™

For USA and Puerto Rico assistance, please call: 1-800-211-PANA(7262) or,
contact us via the web at: <http://www.panasonic.com/contactinfo>

For Canadian assistance, please call: 1-800-561-5505 or visit us at www.panasonic.ca

Dear Customer,

Thank you for choosing Panasonic!

You have purchased one of the most sophisticated and reliable products on the market today. Used properly, we're sure it will bring you and your family years of enjoyment. Please take time to fill in the information on the right.

The serial number is on the tag located on the underside of your camera. Be sure to **retain this manual** as your convenient camera information source.

Date of Purchase _____

Dealer Purchased From _____

Dealer Address _____

Dealer Phone No. _____

Model No. _____

Serial No. _____

Safety Precautions

WARNING:

To reduce the risk of fire, electric shock or product damage,

- Do not expose this unit to rain, moisture, dripping or splashing.
- Do not place objects filled with liquids, such as vases, on this unit.
- Use only the recommended accessories.
- Do not remove covers.
- Do not repair this unit by yourself. Refer servicing to qualified service personnel.

CAUTION!

To reduce the risk of fire, electric shock or product damage,

- Do not install or place this unit in a bookcase, built-in cabinet or in another confined space. Ensure this unit is well ventilated.
- Do not obstruct this unit's ventilation openings with newspapers, tablecloths, curtains, and similar items.
- Do not place sources of naked flames, such as lighted candles, on this unit.

THE FOLLOWING APPLIES ONLY IN THE U.S.A.

FCC Note:

This equipment has been tested and found to comply with the limits for a Class B digital device, pursuant to Part 15 of the FCC Rules. These limits are designed to provide reasonable protection against harmful interference in a residential installation. This equipment generates, uses, and can radiate radio frequency energy and, if not installed and used in accordance with the instructions, may cause harmful interference to radio communications. However, there is no guarantee that interference will not occur in a particular installation. If this equipment does cause harmful interference to radio or television reception, which can be determined by turning the equipment off and on, the user is encouraged to try to correct the interference by one or more of the following measures:

- Reorient or relocate the receiving antenna.
- Increase the separation between the equipment and receiver.
- Connect the equipment into an outlet on a circuit different from that to which the receiver is connected.
- Consult the dealer or an experienced radio/TV technician for help.

FCC Caution: To assure continued compliance, follow the attached installation instructions and use only shielded interface cables with ferrite core when connecting to computer or peripheral devices.

Any changes or modifications not expressly approved by the party responsible for compliance could void the user's authority to operate this equipment.

Declaration of Conformity

Trade Name: Panasonic
Model No.: HC-V100P/HC-V100MP
Responsible Party: Panasonic Corporation of North America
One Panasonic Way, Secaucus, NJ 07094
Support Contact: Panasonic Consumer Marketing Company of North America
1-800-211-PANA (7262)

This device complies with Part 15 of the FCC Rules. Operation is subject to the following two conditions: (1) This device may not cause harmful interference, and (2) this device must accept any interference received, including interference that may cause undesired operation.



THE FOLLOWING APPLIES ONLY IN CANADA.

This Class B digital apparatus complies with Canadian ICES-003.

THE FOLLOWING APPLIES ONLY IN THE U.S.A. AND CANADA.

AC adaptor

This AC adaptor operates on AC between 100 V and 240 V.

But

- In the U.S.A. and Canada, the AC adaptor must be connected to a 120 V AC power supply only.
- When connecting to an AC supply outside of the U.S.A. or Canada, use a plug adaptor to suit the AC outlet configuration.
- When connecting to a supply of greater than AC 125 V, ensure the cord you use is suited to the voltage of the AC supply and the rated current of the AC adaptor.
- Contact an electrical parts distributor for assistance in selecting a suitable AC plug adaptor or AC cord set.

Install this unit so that the power cord can be unplugged from the socket outlet immediately if any problem occurs.

THE FOLLOWING APPLIES ONLY IN LATIN AMERICAN COUNTRIES.

Install this unit so that the AC mains lead can be unplugged from the socket outlet immediately if any problem occurs.

■ Concerning the battery

Battery pack (Lithium ion battery pack)

- Use the specified unit to recharge the battery pack.
- Do not use the battery pack with equipment other than the specified unit.
- Do not get dirt, sand, liquids, or other foreign matter on the terminals.
- Do not touch the plug terminals (+ and –) with metal objects.
- Do not disassemble, remodel, heat or throw into fire.

If any electrolyte should come into contact with your hands or clothes, wash it off thoroughly with water.

If any electrolyte should come into contact with your eyes, never rub the eyes. Rinse eyes thoroughly with water, and then consult a doctor.

Warning

Risk of fire, explosion and burns. Do not disassemble, heat above 60 °C (140 °F) or incinerate.

CAUTION

- Danger of explosion if battery is incorrectly replaced. Replace only with the type recommended by the manufacturer.
- When disposing the batteries, please contact your local authorities or dealer and ask for the correct method of disposal.

■ Product Identification Marking

Product	Location
High Definition Video Camera	Battery holder
AC adaptor	Bottom

U.S.A./CANADA CONSUMERS: ATTENTION:



A lithium ion battery that is recyclable powers the product you have purchased. Please call 1-800-8-BATTERY for information on how to recycle this battery.

Precautions

USE & LOCATION

WARNING

- **TO AVOID SHOCK HAZARD** ... Your camera and power supply should not be exposed to rain or moisture. Do not connect the power supply or operate your camera if it gets wet. Your camera has been designed for outdoor use, however it is not designed to sustain direct exposure to water, rain, sleet, snow, sand, dust, or a direct splashing from a pool or even a cup of coffee. This action could permanently damage the internal parts of your camera. Do not attempt to disassemble this unit. There are no user serviceable parts inside. Unplug your camera from the power supply before cleaning.
- **AS WITH ANY SMALL OBJECT, SD CARDS CAN BE SWALLOWED BY YOUNG CHILDREN. DO NOT ALLOW CHILDREN TO HANDLE THE SD CARD.**

CAUTION

- **DO NOT AIM YOUR CAMERA AT THE SUN OR OTHER BRIGHT OBJECTS**
- **DO NOT EXPOSE YOUR CAMERA TO EXTENDED HIGH TEMPERATURE** ... Such as, in direct sunlight, inside a closed car, next to a heater, etc... This action could permanently damage the internal parts of your camera.
- **AVOID SUDDEN CHANGES IN TEMPERATURE** ... If the unit is suddenly moved from a cold place to a warm place, moisture may form on the SD card and inside the unit.
- **DO NOT LEAVE YOUR CAMERA OR THE POWER SUPPLY TURNED ON WHEN NOT IN USE.**

- **STORAGE OF YOUR CAMERA** ... Store and handle your camera in a manner that will not subject it to unnecessary movement (avoid shaking and striking). Your camera contains a sensitive pick-up device which could be damaged by improper handling or storage.

CARE

- **TO CLEAN YOUR CAMERA** ... Do not use strong or abrasive detergents when cleaning your camera body.
- **TO PROTECT THE LENS** ... Do not touch the surface of the lens with your hand. Use a commercial camera lens solution and lens paper when cleaning the lens. Improper cleaning can scratch the lens coating.
- **TO PROTECT THE FINISH OF YOUR CAMERA** ... Before handling your camera, make sure your hands and face are free from any chemical products, such as suntan lotion, as it may damage the finish.

-If you see this symbol-

Information on Disposal in other Countries outside the European Union



This symbol is only valid in the European Union. If you wish to discard this product, please contact your local authorities or dealer and ask for the correct method of disposal.

■ About the recording format for recording motion pictures

You can select from either AVCHD or iFrame recording formats to record motion pictures using this unit. (→ 54)

AVCHD:

You can record high-definition quality images with this format. It is suitable for viewing on a large format TV or for saving to disc.

iFrame:

This is a recording format suitable for playing back or editing on Mac (iMovie'11). Using iMovie'11, iFrame motion pictures can be imported faster than AVCHD motion pictures. Also, the imported file size of iFrame motion pictures will be smaller than that of AVCHD motion pictures.

- It is not compatible with motion picture recorded in AVCHD format.

■ Indemnity about recorded content

Panasonic does not accept any responsibility for damages directly or indirectly due to any type of problems that result in loss of recording or edited content, and does not guarantee any content if recording or editing does not work properly. Likewise, the above also applies in a case where any type of repair is made to the unit (including any other non-built-in memory related component).

■ Handling of built-in memory [HC-V100M]

This unit is equipped with the built-in memory. When using this component, pay attention to the following points.

Back up data periodically.

The built-in memory is temporary storage. In order to avoid erasing data due to static electricity, electromagnetic waves, breakage, and failures, back up the data to a PC or disc. (→ 86)

- Access lamp [ACCESS] (→ 19)
illuminates while the SD card or built-in memory is being accessed (initialization, recording, playback, deleting, etc.). Do not perform the following operations when the lamp illuminates. It may damage the built-in memory or cause a malfunction in the unit.
 - Turn the unit off (remove the battery)
 - Insert and remove the USB cable
 - Expose the unit to vibrations or shock
- About disposing of or giving away this unit. (→ 109)

■ About Condensation (When the lens or the LCD monitor is fogged up)

Condensation occurs when the ambient temperature or humidity changes. Be careful of condensation since it causes lens or LCD monitor stains, fungus and camera malfunction.

- For more details about the cause and action required for condensation, refer to page 112.

■ Cards that you can use with this unit

SD Memory Card, SDHC Memory Card and SDXC Memory Card

- 4 GB or more Memory Cards that do not have the SDHC logo or 48 GB or more Memory Cards that do not have the SDXC logo are not based on SD Memory Card Specifications.
- Refer to page 24 for more details on SD cards.

■ For the purposes of this owner's manual

- SD Memory Card, SDHC Memory Card and SDXC Memory Card are referred to as the "SD card".
- Functions that can be used for motion picture recording/motion picture playback are indicated by **VIDEO** in this owner's manual.
- Functions that can be used for still picture recording/still picture playback are indicated by **PHOTO** in this owner's manual.
- Pages for reference are indicated by an arrow, for example: → 00

This owner's manual is designed for use with models **HC-V100** and **HC-V100M**. Pictures may be slightly different from the original.

- The illustrations used in this owner's manual show model **HC-V100**, however, parts of the explanation refer to different models.
- Depending on the model, some functions are not available.
- Features may vary, so please read carefully.
- Not all models may be available depending on the region of purchase.

Contents

Accessories.....	12
Quick Guide.....	13

Preparation

Names and Functions of Main Parts	17
Power supply	20
Inserting/removing the battery.....	20
Charging the battery	21
Charging and recording time.....	23
Recording to a card	24
Cards that you can use with this unit.....	24
Inserting/removing an SD card.....	25
Turning the unit on/off	26
Selecting a mode	27
Setting date and time	28

Basic

Before recording	29
Selecting a media to record [HC-V100M]	30
Recording motion pictures	31
Recording still pictures	33
Intelligent Auto Mode	34
Motion picture/ Still picture playback	36
Using the menu screen	39
Using the Setup Menu	40

Advanced (Recording)

Using the Zoom	47
Optical image stabilizer function	48
Recording functions of operation icons	49
Operation icons.....	49
Recording functions of menus	53
Manual recording	59
White Balance.....	59
Manual shutter speed/ Iris adjustment	61
Recording with Manual Focus	62

Advanced (Playback)

Playback Operations	63
Motion picture playback using operation icon.....	63
Creating still picture from motion picture	64
Repeat playback	64
Resuming the previous playback.....	65
Zooming in on a still picture during playback (Playback zoom).....	65
Various playback functions	66
Playing back motion pictures/ still pictures by date	66
Changing the playback settings and playing back the slide show	67
Deleting scenes/still pictures	69
Dividing a scene (AVCHD).....	71
Dividing a scene to partially delete (iFrame)	72
Protecting scenes/still pictures	73
Watching Video/ Pictures on your TV	74
Connecting with a HDMI mini cable	77
Connecting with the AV multi cable	77
Playback using VIERA Link™	78

Copy/Dubbing

Copying from Built-in Memory to SD card [HC-V100M]	80
Dubbing with a Blu-ray disc recorder, video devices, etc.	82

With a PC

What you can do with a PC	86
End User License Agreement	88
Operating environment	90
Installation	93
Connecting to a PC	94
About the PC display	96
Starting HD Writer LE 1.1	97
Reading the operating instructions of the software applications.....	97
If using Mac	98

Others

Indications	99
Messages	101
About recovery	102
Troubleshooting	103
Cautions for use	108
About copyright	113
Recording modes/approximate recordable time	114
Approximate number of recordable pictures	115
Specifications	116
Optional accessories	119
Accessory Order Form (For USA and Puerto Rico Customers).....	121
Limited Warranty (ONLY FOR U.S.A. AND PUERTO RICO)	122
Warranty (For Canadian Customers).....	124
Useful Information (Only For Latin American Countries).....	125
Index	126
Spanish Quick Use Guide/ Guía española para el uso rápido.....	128

Accessories

Check the accessories before using this unit.

Keep the accessories out of reach of children to prevent swallowing.

Product numbers correct as of Jan. 2012. These may be subject to change.

Battery pack

VW-VBK180



AC adaptor

(P/PC)

VSK0780

(PU)

VSK0781



AC cable

K2CA2CA00025



AV multi cable

K1HY12YY0016



USB cable

K2KYYYY00201

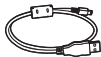

CD-ROM

Software



Quick Guide

■ Inserting the battery

Install the battery by inserting it in the direction shown in the figure.

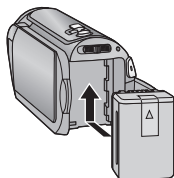

- Insert the battery until it clicks and locks.

■ Charging the battery

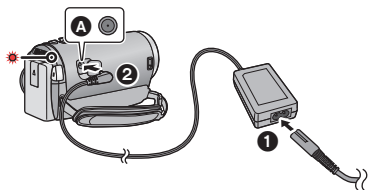

- **A** DC input terminal
- **1** Connect the AC cable to the AC adaptor, then the AC outlet.
- **2** Connect the AC adaptor to the DC input terminal [DC IN].
- The status indicator will flash red for approx. 2 seconds (off for approx. 1 second, on for approx. 1 second), indicating that charging has begun. It will turn off when the charging is completed.

■ Inserting/removing an SD card

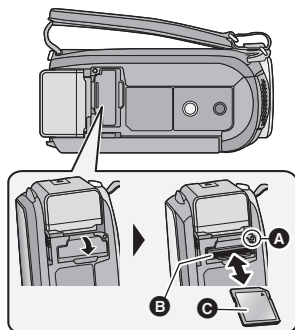

Access lamp [ACCESS] **A**

- When this unit is accessing the SD card or built-in memory, the access lamp lights up.
 - Check that the access lamp has gone off.
- 1) Open the SD card cover and insert/remove the SD card into/from the card slot **B**.
 - Face the label side **C** in the direction shown in the illustration and press it straight in as far as it will go.
 - Press the center of the SD card and then pull it straight out.
- 2) Securely close the SD card cover.
 - Securely close it until it clicks.

■ Turning the unit on/off

Turning the unit on and off with the power button

Press the power button to turn on the unit.

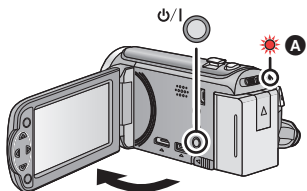

- A The status indicator lights on.
- To turn off the unit, hold down the power button until the status indicator goes off.

Turning the unit on and off with the LCD monitor

Opening the LCD monitor turns on the unit. Closing the LCD monitor turns off the unit.

To turn on the unit



- A The status indicator lights on.

To turn off the unit

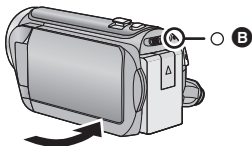



- B The status indicator goes off.



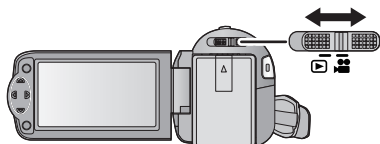

■ Selecting a mode

Operate the mode switch to change the mode to  or .



	Recording Mode (→ 31, 33)
	Playback Mode (→ 36, 63)

■ How to use the cursor button

- Use the cursor button to select the recording functions and playback operations, and to operate the menu screen.
- In this owner's manual, the cursor button is denoted as shown below or as  /  /  /  .
Example: For pressing the (down) button.



or **Press ▼**

■ Language selection

- 1) Press the MENU button, then select [SETUP] → [LANGUAGE].
- 2) Select desired language.

■ Selecting a media to record [HC-V100M]

- 1) Change the mode to  .
- 2) Select the menu.



MENU : [MEDIA SELECT]

- 3) Select the media to record motion pictures or still pictures using $\blacktriangle/\blacktriangledown/\blacktriangleleft/\blacktriangleright$, and press the ENTER button.
 - Select [VIDEO/SD CARD] or [PICTURE/SD CARD] to record to the SD card. Select [VIDEO/Built-inMemory] or [PICTURE/Built-inMemory] to record to the built-in memory.
 - The media is selected separately for motion pictures or still pictures is highlighted in yellow.
- 4) Press the MENU button.

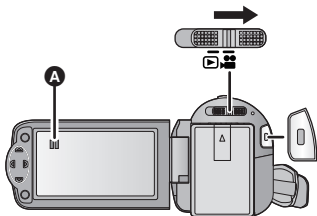

■ Recording motion pictures

- 1) Change the mode to  .
- 2) Open the LCD monitor.
- 3) Press the recording start/stop button to start recording.



- A** When you begin recording,  changes to .

■ Recording still pictures

- 1) Change the mode to  .
- 2) Open the LCD monitor.
- 3) Press the  button to take the picture.

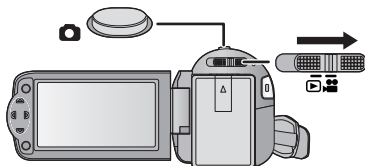

■ Motion picture/Still picture playback

- 1) Change the mode to  .
- 2) Select the play mode select icon **A** using $\blacktriangle/\blacktriangledown/\blacktriangleleft$ and press the ENTER button.

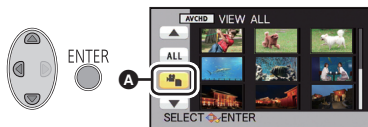

- 3) **HC-V100**
Select the [VIDEO/PICTURE] you wish to play back, then press the ENTER button.
HC-V100M
Select the [MEDIA] and [VIDEO/PICTURE] you wish to play back, then press the ENTER button.
 - Press the MENU button.
 - When a video item is selected, an icon will appear on the thumbnail display. (**AVCHD**, **i Frame**)

- 4) Select the scene or the still picture to be played back using ▲/▼/◀/▶, then press the ENTER button.



- When you select ▲/▼ and press the ENTER button, the next (previous) page is displayed.
- 5) Select the operation icon using ▲/▼/◀/▶.

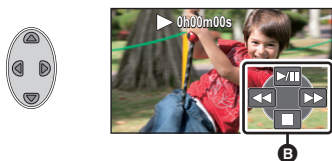

- B** Operation icon
- Press the ENTER button to display/not display the operation icon.

(Motion picture playback)

- ▶/||: Playback/Pause
- ◀◀: Rewind playback
- ▶▶: Fast forward playback
- : Stops the playback and shows the thumbnails.

(Still picture playback)

- ▶/||: Slide show (playback of the still pictures in numerical order) start/pause.
- ◀||: Plays back the previous picture.
- ||▶: Plays back the next picture.
- : Stops the playback and shows the thumbnails.

Names and Functions of Main Parts

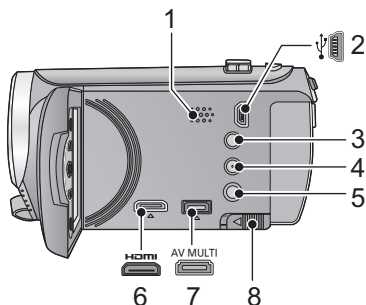

- 1 **Speaker**
 - 2 **USB terminal** [⏏] (→ 82, 94)
 - 3 **Intelligent auto/Manual button** [i/A/MANUAL] (→ 34, 59)
 - 4 **Optical image stabilizer/Delete button** [((())) O.I.S./ [] (→ 48, 69)
 - 5 **Power button** [⏻/] (→ 26)
 - 6 **HDMI mini connector** [HDMI] (→ 74, 78)
 - 7 **AV multi connector** [AV MULTI] (→ 74, 85)
 - 8 **Battery release lever** [BATT] (→ 20)
- Use the AV multi cable (only the supplied cable).

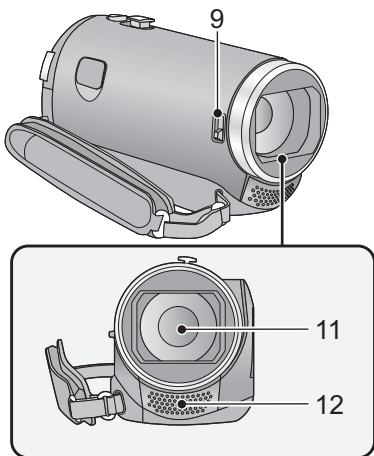

- 9 **Lens cover opening/closing switch**
When not using the unit, close the lens cover to protect the lens.
- Slide the opening/closing switch to open/close the cover.

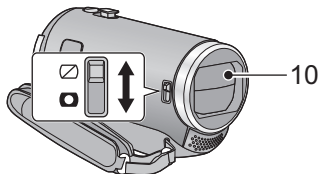

- 10 **Lens cover**
- 11 **Lens**
- 12 **Internal stereo microphones**

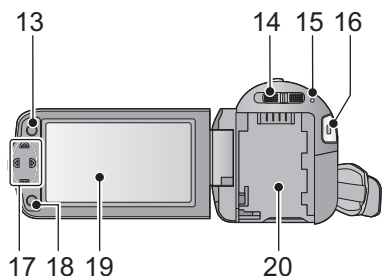

- 13 Menu button [MENU] (→ 39)
- 14 Mode switch (→ 27)
- 15 Status indicator (→ 26)
- 16 Recording start/stop button (→ 31)
- 17 Cursor button (→ 36, 39, 49)

- Use the cursor button to select the recording functions and playback operations, and to operate the menu screen.
 - In this owner's manual, the cursor button is denoted as shown below or as ▲/▼/◀/▶.
- Example: For pressing the (down) button



or Press ▼

- 18 Enter button [ENTER] (→ 36, 39, 49)
- 19 LCD monitor (→ 29)



- It can open up to 90°.

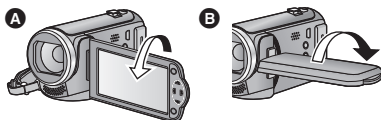

- It can rotate up to 180° **A** towards the lens or 90° **B** towards the opposite direction.

Due to limitations in LCD production technology, there may be some tiny bright or dark spots on the LCD monitor screen. However, this is not a malfunction and does not affect the recorded picture.

- 20 Battery holder (→ 20)

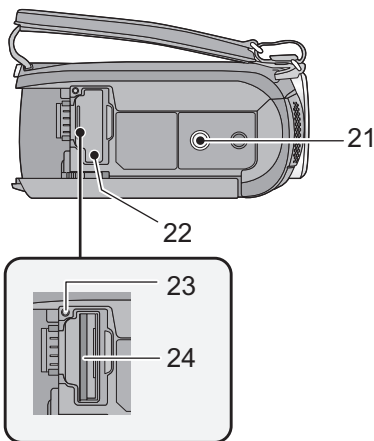

21 Tripod receptacle

- If you attach a tripod which has a 5.5 mm (0.22 ") screw or larger, it may damage this unit.

22 SD card cover (→ 25)

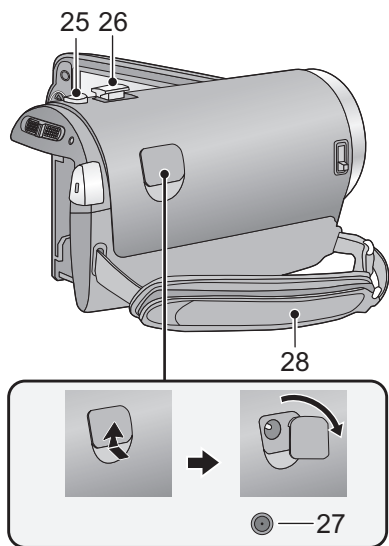

23 Access lamp [ACCESS] (→ 25)

24 Card slot (→ 25)



25 Photoshot button [] (→ 33)

26 Zoom lever [W/T] (In Recording Mode) (→ 47)

Thumbnail display switch [ / ] /
Volume lever [-VOL+] (In Playback Mode) (→ 37)

27 DC input terminal [DC IN] (→ 21)

- Do not use any other AC adaptors except the supplied one.

28 Grip belt

Adjust the length of the grip belt so that it fits your hand.

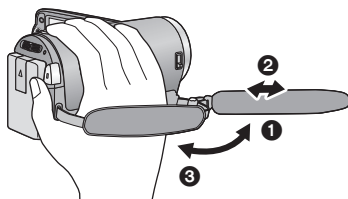

1 Flip the belt.

2 Adjust the length.

3 Replace the belt.

Power supply

■ About batteries that you can use with this unit

The battery that can be used with this unit is VW-VBK180/VW-VBK360.

- The unit has a function for distinguishing batteries which can be used safely. The dedicated battery (VW-VBK180/VW-VBK360) supports this function. The only batteries suitable for use with this unit are genuine Panasonic products and batteries manufactured by other companies and certified by Panasonic. (Batteries that do not support this function cannot be used). Panasonic cannot in any way guarantee the quality, performance or safety of batteries which have been manufactured by other companies and are not genuine Panasonic products.

It has been found that counterfeit battery packs which look very similar to the genuine product are made available to purchase in some markets. Some of these battery packs are not adequately protected with internal protection to meet the requirements of appropriate safety standards. There is a possibility that these battery packs may lead to fire or explosion. Please be advised that we are not liable for any accident or failure occurring as a result of use of a counterfeit battery pack. To ensure that safe products are used we would recommend that a genuine Panasonic battery pack is used.

Inserting/removing the battery

- Press the power button to turn off the unit. (→ 26)

Install the battery by inserting it in the direction shown in the figure.

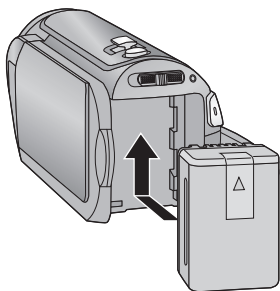

Insert the battery until it clicks and locks.

Removing the battery

Be sure to hold down the power button until the status indicator goes off. Then remove the battery while supporting the unit to prevent it from dropping.

Move the battery release lever in the direction indicated by the arrow and remove the battery when unlocked.

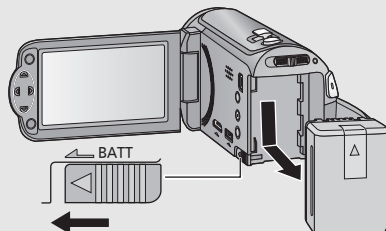

Charging the battery

When this unit is purchased, the battery is not charged. Charge the battery fully before using this unit for the first time.

The unit is in the standby condition when the AC adaptor is connected. The primary circuit is always “live” as long as the AC adaptor is connected to an electrical outlet.

Important:

- Use the supplied AC adaptor. Do not use the AC adaptor of another device.
- Do not use the AC cable with any other equipment as it is designed only for this unit. Also, do not use the AC cable from other equipment with this unit.
- The battery can also be charged using a battery charger (VW-BC10PP: optional).
- The battery will not be charged if the unit is turned on.
- It is recommended to charge the battery in a temperature between 10 °C and 30 °C (50 °F and 86 °F). (The battery temperature should also be the same.)

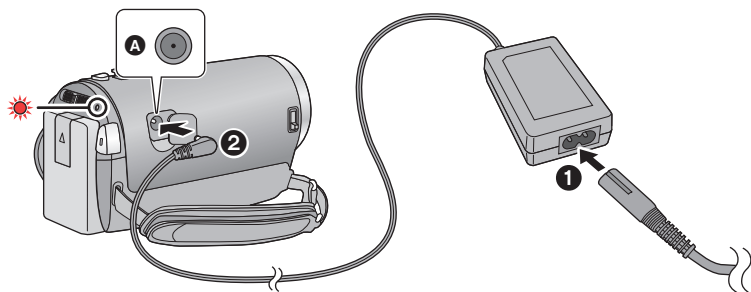

A DC input terminal

- Insert the plugs as far as they will go.

1 Connect the AC cable to the AC adaptor, then the AC outlet.

2 Connect the AC adaptor to the DC input terminal [DC IN].

- Be careful not to pinch the DC input terminal cover.
- The status indicator will flash red for approx. 2 seconds (off for approx. 1 second, on for approx. 1 second), indicating that charging has begun. It will turn off when the charging is completed.

■ Connecting to the AC outlet

If you turn on the unit while connecting with the AC adaptor, you can use the unit with power supplied from the outlet.

■ To charge by connecting to other device

It is possible to charge by connecting to other device with the USB cable (supplied). Please refer to page 95.

- If the status indicator flashes at a particularly fast or slow rate, refer to page 111.
- We recommend using Panasonic batteries (→ 12, 23, 119).
- If you use other batteries, we cannot guarantee the quality of this product.
- Do not heat or expose to flame.
- Do not leave the battery(ies) in a car exposed to direct sunlight for a long period of time with doors and windows closed.

Charging and recording time

■ Charging/Recording time

- Temperature: 25 °C (77 °F)/humidity: 60%RH
- Charging times in parentheses are when charging from the USB terminal.



Battery model number [Voltage/Capacity (minimum)]	Charging time	Recording mode	Maximum continuously recordable time	Actual recordable time
Supplied battery/ VW-VBK180 (optional) [3.6 V/1790 mAh]	2 h 25 min (5 h 45 min)	[HA], [HG], [HX]	2 h 35 min	1 h 20 min
		[iFrame]	3 h 10 min	1 h 35 min
VW-VBK360 (optional) [3.6 V/3580 mAh]	4 h 20 min (10 h 40 min)	[HA]	5 h 5 min	2 h 40 min
		[HG], [HX]	5 h 10 min	
		[iFrame]	6 h 15 min	3 h 15 min

- These times are approximations.
 - **The indicated charging time is for when the battery has been discharged completely. Charging time and recordable time vary depending on the usage conditions such as high/low temperature.**
-
- The actual recordable time refers to the recordable time when repeatedly starting/stopping recording, turning the unit on/off, moving the zoom lever etc.
 - The batteries heat up after use or charging. This is not a malfunction.

Battery capacity indication

- The display changes as the battery capacity reduces.



If there is less than 3 minutes remaining, then  will become red. If the battery discharges, then  will flash.

- The remaining battery capacity is displayed when using the Panasonic battery that you can use for this unit. The actual time can vary depending on your actual use.
- When using the AC adaptor or batteries made by other companies, the remaining battery capacity will not be shown.

Recording to a card

The unit can record still pictures or motion pictures to an SD card or built-in memory. To record to an SD card, read the following.

This unit (an SDXC compatible device) is compatible with SD Memory Cards, SDHC Memory Cards and SDXC Memory Cards. When using an SDHC Memory Card/SDXC Memory Card with other equipment, check the equipment is compatible with these Memory Cards.

Cards that you can use with this unit

Use SD cards conforming to Class 4 or higher of the SD Speed Class Rating* for motion picture recording.

Card type	Capacity
SD Memory Card	512 MB/1 GB/2 GB
SDHC Memory Card	4 GB/6 GB/8 GB/12 GB/16 GB/24 GB/32 GB
SDXC Memory Card	48 GB/64 GB

* SD Speed Class Rating is the speed standard regarding continuous writing. Check via the label on the card, etc.

e.g.:

CLASS 4

- Please confirm the latest information about SD Memory Cards/SDHC Memory Cards/SDXC Memory Cards that can be used for motion picture recording on the following website.

http://panasonic.jp/support/global/cs/e_cam

(This website is in English only.)

- Operation of the SD Card 256 MB or less is not guaranteed. Also, the SD Card 32 MB or less cannot be used for the motion picture recording.
- 4 GB or more Memory Cards that do not have the SDHC logo or 48 GB or more Memory Cards that do not have the SDXC logo are not based on SD Memory Card Specifications.
- The operation of Memory cards exceeding 64 GB cannot be guaranteed.
- When the write-protect switch **A** on SD card is locked, no recording, deletion or editing will be possible on the card.
- Keep the Memory Card out of reach of children to prevent swallowing.

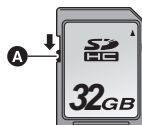

Inserting/removing an SD card

When using an SD card not from Panasonic, or one previously used on other equipment, for the first time on this unit, format the SD card. (→ 44) When the SD card is formatted, all of the recorded data is deleted. Once the data is deleted, it cannot be restored.

Caution:

Check that the access lamp has gone off.

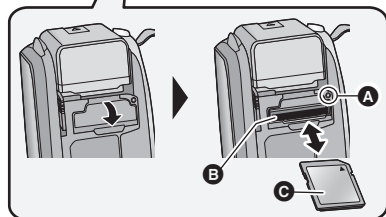
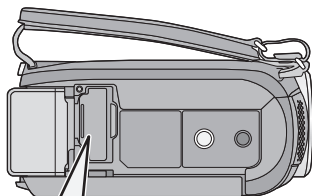

Access lamp [ACCESS] **A**

- When this unit is accessing the SD card or built-in memory, the access lamp lights up.

1 Open the SD card cover and insert/remove the SD card into/from the card slot **B**.

- Face the label side **C** in the direction shown in the illustration and press it straight in as far as it will go.
- Press the center of the SD card and then pull it straight out.

2 Securely close the SD card cover.

- Securely close it until it clicks.

- Do not touch the terminals on the back of the SD card.
- Do not apply strong shocks, bend, or drop the SD card.
- Electrical noise, static electricity or the failure of this unit or the SD card may damage or erase the data stored on the SD card.
- When the card access lamp is lit, do not:
 - Remove the SD card
 - Turn the unit off
 - Insert and remove the USB cable
 - Expose the unit to vibrations or shockPerforming the above while the lamp is on may result in damage to data/SD card or this unit.
- Do not expose the terminals of the SD card to water, dirt or dust.
- Do not place SD cards in the following areas:
 - In direct sunlight
 - In very dusty or humid areas
 - Near a heater
 - Locations susceptible to significant difference in temperature (condensation can occur).
 - Where static electricity or electromagnetic waves occur
- To protect SD cards, return them to their cases when you are not using them.
- About disposing of or giving away the SD card. (→ 111)

Turning the unit on/off

You can turn the unit on and off using the power button or by opening and closing the LCD monitor.

Turning the unit on and off with the power button

Open the LCD monitor and press the power button to turn on the unit.

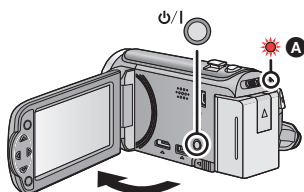

- A** The status indicator lights on.

To turn off the unit

Hold down the power button until the status indicator goes off.

Turning the unit on and off with the LCD monitor

Unit is turned on when the LCD monitor is opened, and unit is turned off when it is closed.

During normal use, opening and closing of the LCD monitor can be conveniently used to turn the unit on/off.

■ To turn on the unit

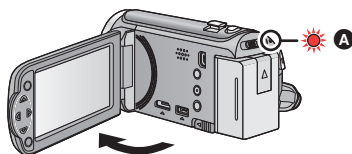

- A** The status indicator lights on.

■ To turn off the unit

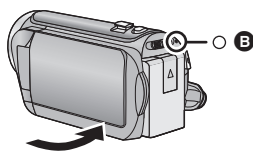

- B** The status indicator goes off.



- The unit will not turn off while recording motion pictures even if the LCD monitor is closed.
- In the following cases, opening the LCD monitor does not turn on the unit. Press the power button to turn on the unit.
 - When the unit is originally purchased
 - When you have turned off the unit using the power button

Selecting a mode

Change the mode to recording or playback.

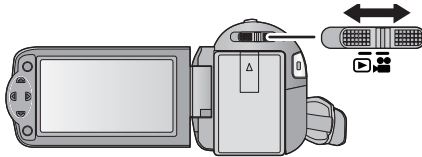
Operate the mode switch to change the mode to  or .



	Recording Mode (→ 31, 33)
	Playback Mode (→ 36, 63)

Setting date and time

When the unit is turned on for the first time, a message asking you to set the date and time will appear.

Select [YES] and perform Steps 2 to 3 below to set the date and time.

◇ Change the mode to  .

1 Select the menu. (→ 39)

 : [SETUP] → [CLOCK SET]

2 Select the date or time using ◀/▶ and set the desired value using ▲/▼.

A Displaying the World time setting (→ 40):

 [HOME]/  [DESTINATION]

- The year can be set between 2000 and 2039.
- The 12-hour system is used to display the time.



3 Press the ENTER button.

- A message prompting for World Time setting may be displayed. Perform the World Time setting by pressing the ENTER button. (→ 40)
- Press the MENU button to complete the setting.

-
- The date and time function is driven by a built-in lithium battery.
 - If the time display becomes [- -], the built-in lithium battery needs to be charged. To recharge the built-in lithium battery, connect the AC adaptor or attach the battery to this unit. Leave the unit as it is for approx. 24 hours and the battery will maintain the date and time for approx. 4 months. (The battery is still being recharged even if the unit is off.)

Before recording

■ Basic camera positioning

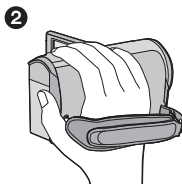
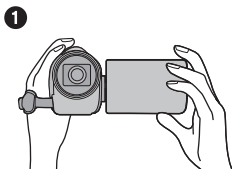

- ❶ Hold the unit with both hands.
- ❷ Put your hand through the grip belt.
 - When recording, make sure your footing is stable and there is no danger of colliding with another person or object.
 - When you are outdoors, record pictures with the sunlight behind you. If the subject is backlit, it will become dark in the recording.
 - Keep your arms near your body and separate your legs for better balance.
 - Do not cover the microphones with your hand etc.

■ Basic motion picture recording

- The unit should normally be held steady when recording.
- If you move the unit when recording, do so slowly, maintaining a constant speed.
- The zoom operation is useful for recording subjects you cannot get close to, but overuse of zoom in and zoom out can make the resulting motion picture less enjoyable to watch.

■ Recording yourself

Rotate the LCD monitor towards the lens side.

- The image is horizontally flipped as if you see a mirror image. (However, the image recorded is the same as a normal recording.)
- Only some indications will appear on the screen. When  appears, return the direction of the LCD monitor to normal position and check the warning/alarm indication. (→ 101)

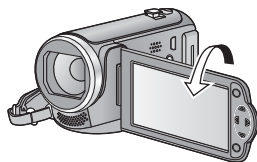

Selecting a media to record [HC-V100M]

The card and built-in memory can be selected separately to record motion pictures or still pictures.

- 1 Change the mode to .
- 2 Select the menu. (→ 39)

MENU : [MEDIA SELECT]

- 3 Select the media for recording the motion pictures and the media for recording the still pictures using ▲/▼/◀/▶, and press the ENTER button.

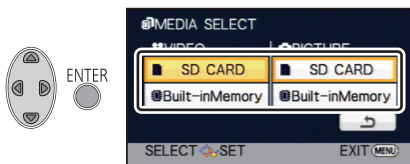

- The media is selected separately to motion pictures or still pictures is highlighted in yellow.
- Select  and press the ENTER button to return to the previous screen. (settings will not be changed)



- 4 Press the MENU button to complete the settings.

Recording motion pictures

- Open the lens cover before turning on the unit. (→ 17)

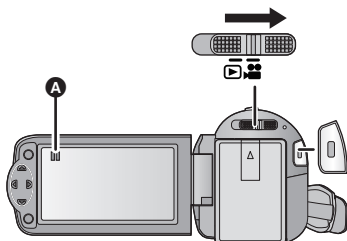
- 1** Change the mode to  and open the LCD monitor.
- 2** Press the recording start/stop button to start recording.



- A** When you begin recording,  changes to .

- 3** Press the recording start/stop button again to pause recording.

■ About the screen indications in the motion picture recording

	Recording mode
R 1h20m	Approximate remaining recordable time <ul style="list-style-type: none"> • When the remaining time is less than 1 minute, R 0h00m flashes red.
0h00m00s	Recording time elapsed <ul style="list-style-type: none"> • "h" is an abbreviation for hour, "m" for minute and "s" for second. • Each time the unit is put into recording pause, the counter display will be reset to 0h00m00s.



- **To change the recording format, change the Recording Mode. (→ 54)**

- The images recorded between pressing the recording start/stop button to start recording and pressing it again to pause recording become one scene.
When you record with the [REC MODE] set to [iFrame], the scenes longer than approximately 20 minutes will be automatically divided. (Recording will continue.)
- When [REC MODE] is set to [iFrame], screen will pause momentarily when the recording is paused.
- (Maximum recordable scenes on a single SD card or built-in memory)

Recording formats	[HA]/[HG]/[HX]	[iFrame]
Recordable scenes	Approx. 3900	Approx. 89100
Different dates (→ 66)	Approx. 200	Approx. 900

- Maximum number of recordable scenes and maximum number of different dates will be less than above table when there are both iFrame scenes and still pictures recorded on SD card or built-in memory.
- While recording is in progress, the recording will not stop even if the LCD monitor is closed.
- Please refer to page 114 for details about approximate recordable time.

About the compatibility of the recorded motion pictures

When motion picture is recorded in AVCHD format

- Only motion pictures recorded with the recording format set to AVCHD are supported by AVCHD compatible equipment. Images cannot be played with equipment that does not support AVCHD (ordinary DVD recorders). Confirm that your equipment supports AVCHD by referring to the operating instructions.
- It is not always possible to play back motion pictures recorded with the recording format set to AVCHD on AVCHD compatible equipment. In such a case, play back on this unit instead.

When motion picture is recorded in iFrame format

- You can play back on a Mac (iMovie'11).
- It is not compatible with motion picture recorded in AVCHD format.
- It is not always possible to play back motion pictures recorded with the recording format set to iFrame on iFrame compatible equipment. In such a case, play back on this unit instead.

Recording still pictures

Still picture recorded with size of **2.1M** (1920×1080) and an aspect ratio of 16:9.



- Open the lens cover before turning on the unit. (→ 17)

1 Change the mode to  and open the LCD monitor.

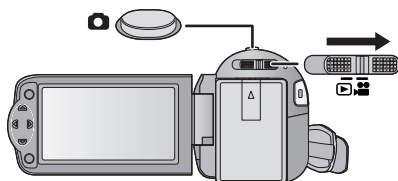
2 Press the  button.



■ About the screen indications in Still Picture Recording

	Quality of still pictures (→ 58)
	Size of still pictures
R3000	Remaining number of still pictures <ul style="list-style-type: none"> • Flashes in red when [0] appears.
	Still picture operation indicator (→ 100)



- During motion picture recording or when set to PRE-REC, you cannot record still pictures.
- Using a tripod is recommended when recording still pictures in dark places because the shutter speed becomes slow.
- To print a picture, save the picture to the SD card (→ 80) and print using a PC or a printer.
- The edges of still pictures recorded on this unit with a 16:9 aspect ratio may be cut at printing. Check the printer or photo studio before printing.
- Please refer to page 115 for details about the number of recordable pictures.

Intelligent Auto Mode

The following modes (appropriate for the condition) are set just by pointing the unit to what you want to record.



Intelligent auto/Manual button
Press this button to switch Intelligent Auto Mode/Manual Mode.

- Please refer to page 59 for details about Manual Mode.

	Mode	Effect
	Portrait	Faces are detected and focused automatically, and the brightness is adjusted so it is recorded clearly.
	Scenery	The whole landscape will be recorded vividly without whitening out the background sky, which may be very bright.
	Spotlight	Very bright object is recorded clearly.
	Low light	It can record very clearly even in a dark room or twilight.
	Normal	In modes other than those described above, the contrast is adjusted to give a clear picture.

- Depending on the recording conditions, the unit may not enter the desired mode.
- In the Portrait, Spotlight and Low light mode, the face will be surrounded by white frame when detected. In the Portrait mode, a subject that is bigger and close to center of the screen will be surrounded by an orange frame. (→ 55)
- Faces cannot be detected depending on the recording conditions, such as when faces are of certain sizes or at certain tilts or when digital zoom is used.

■ Intelligent Auto Mode

When switching to Intelligent Auto Mode, the Auto White Balance and Auto Focus operate and automatically adjust the color balance and focusing.

Depending on the brightness of the subject, etc., the aperture and shutter speed are automatically adjusted for optimum brightness.

- Color balance and focus may not be adjusted automatically depending on light sources or scenes. If so, manually adjust these settings. (→ 59, 62)

Automatic White Balance

The illustration shows the range over which Automatic White Balance functions.

- 1) The effective range of Automatic White Balance adjustment on this unit

- 2) Blue sky
- 3) Cloudy sky (rain)
- 4) Sunlight
- 5) White fluorescent lamp
- 6) Halogen light bulb
- 7) Incandescent light bulb
- 8) Sunrise or sunset
- 9) Candlelight

If the Automatic White Balance is not functioning normally, adjust the White Balance manually. (→ 59)

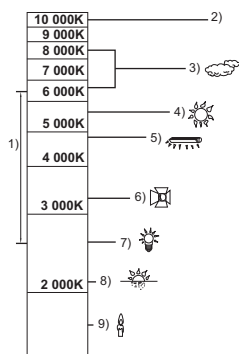

Auto Focus

The unit focuses automatically.

- Auto Focus does not work correctly in the following situations. Record pictures in the Manual Focus Mode. (→ 62)
 - Recording distant and close-up objects at the same time
 - Recording a subject behind dirty or dusty window
 - Recording a subject that is surrounded by objects with glossy surfaces or by highly reflective objects

Motion picture/Still picture playback

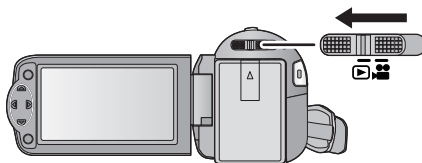

1 Change the mode to .

2 Select the play mode select icon  using $\blacktriangle/\blacktriangledown/\blacktriangleleft$ and press the ENTER button.



3 HC-V100

Select the [VIDEO/PICTURE] you wish to play back, then press the ENTER button.

HC-V100M

Select the [MEDIA] and [VIDEO/PICTURE] you wish to play back, then press the ENTER button.

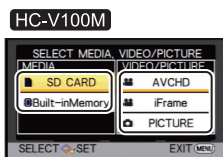
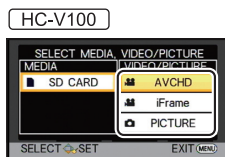

- Press the MENU button.
- When a video item is selected, an icon will appear on the thumbnail display. (AVCHD, iFrame)

4 Select the scene or the still picture to be played back using $\blacktriangle/\blacktriangledown/\blacktriangleleft/\blacktriangleright$, then press the ENTER button.



- When you select $\blacktriangle/\blacktriangledown$ and press the ENTER button, the next/previous page is displayed.

5 Select the operation icon using

▲/▼/◀/▶.



A Operation icon

- Press the ENTER button to display/not display the operation icon.



Motion picture playback	Still picture playback
<p>▶/ : Playback/Pause</p> <p>◀◀: Rewind playback</p> <p>▶▶: Fast forward playback</p> <p>■: Stops the playback and shows the thumbnails.</p>	<p>▶/ : Slide show (playback of the still pictures in numerical order) start/pause.</p> <p>◀ : Plays back the previous picture.</p> <p> ▶: Plays back the next picture.</p> <p>■: Stops the playback and shows the thumbnails.</p>

■ Change the thumbnail display

While the thumbnail is displayed, the thumbnail display changes in the following order if the zoom lever is operated to  side or  side.

20 scenes ↔ 9 scenes ↔ 1 scene

- 9 scenes display returns if the unit is turned off or the mode is changed.

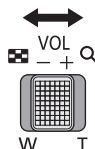

■ Speaker volume adjustment

Operate the volume lever to adjust the speaker volume during motion picture playback.

Towards "+": Increases the volume

Towards "-": Decreases the volume



- Sound will be heard only during normal playback.
- If pause play is continued for 5 minutes, the screen returns to the thumbnails.
- The elapsed time for playback indication will be reset to 0h00m00s for each scene.
- Switching of the AVCHD scenes may not play back smoothly. (→ 107)
- When playing back iFrame scenes, the image will pause momentarily and the screen may turn black when the scenes are switching.

Motion picture compatibility

- This unit is based on AVCHD format/MPEG-4 AVC file format.

AVCHD format

- Video signal for the AVCHD that can be played back with this unit is 1920×1080/60i.
- This unit may degrade or not play back motion pictures recorded or created on other products, and other products may degrade or not play back motion pictures recorded on this unit, even if the products support AVCHD. ( is displayed for videos that cannot be played back with this unit)

iFrame format

- Video signal for the iFrame that can be played back with this unit is 960×540/30p.
- Motion pictures recorded in iFrame and AVCHD are not compatible with each other.
- This unit may degrade or not play back motion pictures recorded or created on other products, and other products may degrade or not play back motion pictures recorded on this unit, even if the products support iFrame. ( is displayed for videos that cannot be played back with this unit)

Still picture compatibility

- This unit is compliant with the unified standard DCF (Design rule for Camera File system) established by JEITA (Japan Electronics and Information Technology Industries Association).
- The file format of still pictures supported by this unit is JPEG. (Not all JPEG formatted files will be played back.)
- This unit may degrade or not play back still pictures recorded or created on other products and other products may degrade or not play back still pictures recorded on this unit.

Using the menu screen

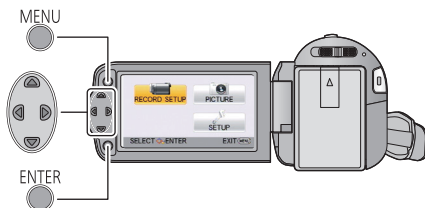

1 Press the MENU button.



To get back to the previous screen

Press ◀ of the cursor button.

2 Press ▲/▼/◀/▶ to select the top menu **A**, then press the ENTER button.

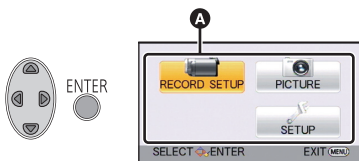

3 Select the submenu **B** using ▲/▼ and press ▶ or press the ENTER button.

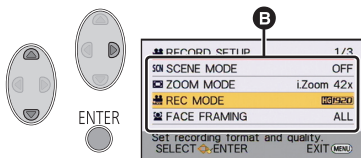

4 Select the desired item using ▲/▼/◀/▶, and press the ENTER button to set.

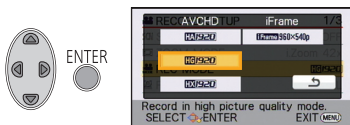

To exit the menu screen

Press the MENU button.

■ About the information display

Descriptions of the selected submenus and items displayed in Steps 3 and 4, and messages to confirm settings are displayed.

■ About the operation icons



Select and then press the ENTER button to switch the menu and thumbnail display page.



Select and then press the ENTER button to return to the previous screen in cases such as menu setting, etc.

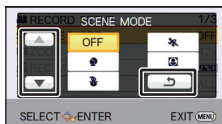

Using the Setup Menu

- The items displayed differ depending on the position or settings of the mode switch. Select the menu.

MENU : [SETUP] → desired setting

[DISPLAY] [ON]/[OFF]

The screen display can be changed to [ON] (all information displayed) or [OFF] (a portion of information displayed).

[EXT. DISPLAY] [SIMPLE]/[DETAIL]/[OFF]

Please refer to page 76.

[CLOCK SET]

Please refer to page 28.

[SET WORLD TIME]

It is possible to display and record the time at the travel destination by selecting your home region and the travel destination.

1 Select [SET WORLD TIME] and press the ENTER button.

- If the clock is not set, adjust the clock to the current time. (→ 28)
- When the [HOME] (your home region) is not set, the message appears. Press the ENTER button and proceed to Step 3.

2 (Only when setting your home region)

Select [HOME] using ◀/▶ and press the ENTER button.

3 (Only when setting your home region)

Select your home region using ◀/▶ and press the ENTER button.

• Press ▲ to set daylight saving time.

☀ appears and the summer time setting is turned on; the time difference from GMT is set forward by one hour. Press ▲ again to return to the normal time setting.

4 (Only when setting the region of your travel destination)

Select [DESTINATION] using ◀/▶ and press the ENTER button.



- When the home region is set for the first time, the screen for selecting home/travel destination appears after setting the home region successively. If the home region has already been set once, execute the menu operation for Step 1.



- A The current time
- B The time difference from GMT (Greenwich Mean Time)

- 5 (Only when setting the region of your travel destination)

Select your travel destination using ◀/▶ and press the ENTER button.

- Press ▲ to set daylight saving time.  appears and the summer time setting is turned on. The travel destination time and time difference from the home region time are set forward by one hour. Press ▲ again to return to the normal time setting.
- Close the setting by pressing the MENU button.  appears and the time of the travel destination is indicated.

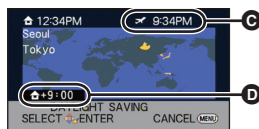

- C The local time at the selected travel destination
- D The time difference between the travel destination and the home region

To return the display to the home setting

Set the home region using Step 1 to 3, and close the setting by pressing the MENU button.

- If you cannot find your travel destination in the area shown on the screen, set it by using the time difference from your home region.

[DATE/TIME]

[DATE]/[D/T]/[OFF]

It is possible to change the date and time display mode.

[DATE FORMAT]

[Y/M/D]/[M/D/Y]/[D/M/Y]

It is possible to change the date format.

[ECONOMY (BATT)]

[ON]/[OFF]

When about 5 minutes have passed without any operation, this unit automatically turns off to save battery life.

- This unit will not automatically turn off even if [ECONOMY (BATT)] is set to [ON] in following cases:
 - Using the AC adaptor*
 - Using the USB cable for PC etc.
 - PRE-REC is used
 - During playback of the slide show
- * When [ECONOMY (AC)] is activated, this unit automatically turns off.

When about 30 minutes have passed without any operation while connecting the AC adaptor with this unit, the unit automatically turns off.

- This unit will not automatically turn off even if the [ECONOMY (AC)] is set to [ON] in following cases:
 - Using the USB cable for PC etc.
 - PRE-REC is used
 - During playback of the slide show

This unit is put into recording pause approx. 0.6 seconds after the LCD monitor is reopened.

- **When in Quick Start Standby Mode about 40% of the power used in Recording pause mode is being consumed, so the recording time will be reduced.**

- **HC-V100**

Quick Start will not work if there is no SD card inserted.

- **HC-V100M**

Quick Start will not work if the [SD CARD] is selected in the [MEDIA SELECT], even if there is no SD card inserted.

- **Change the mode to .**

- 1 Set [QUICK START] to [ON].**

- 2 Close the LCD monitor.**

The status indicator  flashes green and the unit goes into Quick Start Standby Mode.

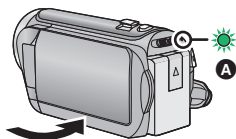

- 3 Open the LCD monitor.**

The status indicator  lights red and the unit is put into recording pause.

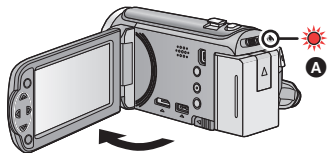

- Quick Start Standby Mode is canceled if
 - about 5 minutes have elapsed
 - mode is set to 
- It may take some time for Automatic White Balance to adjust.
- In the Quick Start Mode, the zoom magnification becomes approx. 1×.
- When it has gone into Quick Start Standby Mode automatically with the [ECONOMY (BATT)] (→ 41)/[ECONOMY (AC)], close the LCD monitor once and open it again.
- Turn the unit off using the power button.

[ALERT SOUND] [Mute] / [Mute] / [OFF]

Starting and stopping of recording and unit on/off can be confirmed with this sound.

[Mute] (Volume low) / [Mute] (Volume high)

2 Beeps for 4 times

When an error occurs. Check the sentence displayed on the screen. (→ 101)

[POWER LCD] [2+] / [1+] / [0] / [1-]

This makes it easier to view the LCD monitor in bright places including outdoors.

- These settings will not affect the images actually recorded.

[2+] (Makes even brighter) / [1+] (Makes brighter) / [0] (Normal) / [1-] (Makes less bright)

- When the AC adaptor is in use, the LCD monitor is set to [1+] automatically.
- When the LCD monitor is bright, the recordable time with the battery will be shorter.

[LCD SET]

It adjusts brightness and color density on the LCD monitor.

- These settings will not affect the images actually recorded.

- 1 Select **[LCD SET]** and press the **ENTER** button.
- 2 Select the item using **▲/▼**, and press the **ENTER** button to set.

[BRIGHTNESS]: Brightness of the LCD monitor

[COLOR]: Color level of the LCD monitor

- 3 Press **◀/▶** to adjust, and press the **ENTER** button.

- Press the MENU button to exit the menu screen.

[AV MULTI] [COMPONENT]/[AV OUT]

Please refer to page 77.

[COMPONENT OUT] [1080i]/[480i]

Please refer to page 77.

[HDMI RESOLUTION] [AUTO]/[1080i]/[480p]

Please refer to page 77.

[VIERA Link] [ON]/[OFF]

Please refer to page 78.

[TV ASPECT] [16:9]/[4:3]

Please refer to page 76.

[INITIAL SET]

Set to [YES] for changing the menu settings back to the default condition.

(Only when the mode is at the  position)

● Settings for [MEDIA SELECT]^{*}, [CLOCK SET] and [LANGUAGE] will not change.

* For users who have , this menu is not displayed.

HC-V100

[FORMAT CARD]

Please be aware that if a medium is formatted, then all the data recorded on the medium will erase and cannot be restored. Back up important data on a PC, disc, etc. (→ 86)

- When formatting is complete, press MENU button to exit the message screen.
- Perform a physical formatting of the SD card when the SD card is to be disposed/transferred. (→ 111)

- Do not turn this unit off or remove the SD card while formatting. Do not expose the unit to vibrations or shock.

Use this unit to format media.

Do not format an SD card using any other equipment such as a PC. The card may not be used on this unit.

HC-V100M

[FORMAT MEDIA]

Please be aware that if a medium is formatted, then all the data recorded on the medium will erase and cannot be restored. Back up important data on a PC, disc, etc. (→ 86)

- 1 Select [FORMAT MEDIA] and press the ENTER button.
- 2 Select [Built-inMemory] or [SD CARD] using ▲/◀/▶, then press the ENTER button.

- When formatting is complete, press MENU button to exit the message screen.
- Perform a physical formatting of the SD card when the SD card is to be disposed/transferred. (→ 111)
- Perform a physical formatting of the built-in memory when this unit is to be disposed/transferred. (→ 109)

- Do not turn this unit off or remove the SD card while formatting. Do not expose the unit to vibrations or shock.

Use this unit to format media.

Formatting built-in memory is only available with this unit.

Do not format an SD card using any other equipment such as a PC. The card may not be used on this unit.

[CARD STATUS]

The used space and remaining recordable time of the SD card can be checked.

- When the mode switch is set to  , remaining recordable time for the selected recording mode is displayed.
- Press the MENU button to close the indication.

-
- The SD card requires some space to store information and manage system files, so the actual usable space is slightly less than the indicated value. The usable space is generally calculated as 1 GB=1,000,000,000 bytes. The capacities of this unit, PCs and software are expressed as 1 GB=1,024×1,024×1,024=1,073,741,824 bytes. Therefore, the indicated value of the capacity appears to be smaller.

[MEDIA STATUS]

The used space and remaining recordable time of the SD card and built-in memory can be checked.

- Pressing the ENTER button switches between SD card and built-in memory display.
- When the mode switch is set to  , remaining recordable time for the selected recording mode is displayed.
- Press the MENU button to close the indication.

-
- The SD card or built-in memory requires some space to store information and manage system files, so the actual usable space is slightly less than the indicated value. The usable SD card/built-in memory space is generally calculated as 1 GB=1,000,000,000 bytes. The capacities of this unit, PCs and software are expressed as 1 GB=1,024×1,024×1,024=1,073,741,824 bytes. Therefore, the indicated value of the capacity appears to be smaller.

[DEMO MODE]

[ON]/[OFF]

This item is used to start the unit demonstration.

(Only when the mode is at the  position)

If [DEMO MODE] is switched to [ON] and you press the MENU button when there is no SD card inserted and while this unit is connected to the AC adaptor, the demonstration automatically starts.

If any operation takes place, the demonstration is canceled. However if no operations take place for approx. 5 minutes, the demonstration automatically starts again. To stop the demonstration, set [DEMO MODE] to [OFF] or insert an SD card.

[O.I.S. DEMO]

This item is used to start the Optical Image Stabilizer demo.

(Only when the mode is at the  position)

Select [O.I.S. DEMO] and press the ENTER button, the demonstration automatically starts. When you press MENU button, the demonstration will be canceled.

[LANGUAGE]

You can select the language on the screen display and the menu screen.

Using the Zoom

◇ Change the mode to .

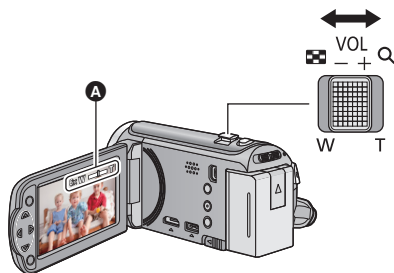

Zoom lever

T side:

Close-up recording (zoom in)

W side:

Wide-angle recording (zoom out)

A Zoom bar

- The zoom speed varies depending on the range over which the zoom lever is moved.
- Maximum zoom magnification can be set with [ZOOM MODE]. (→ 54)

■ About Zoom bar

Zoom bar is displayed during the zoom operation.

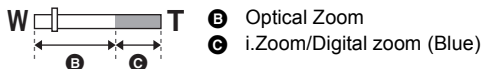

- If you take your finger off the zoom lever during zoom operation, the operation sound may be recorded. When returning the zoom lever to the original position, move it quietly.
- When the zoom magnification is 37 \times , the subjects are focused at about 1.6 m (5.2 feet) or more.
- When the zoom magnification is 1 \times , this unit can focus on a subject approx. 3 cm (1.2") away from the lens.

Optical image stabilizer function

Optical image stabilizer can stabilize the image without decreasing the image quality as much.

◇ Change the mode to  .

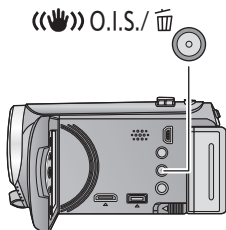

Optical image stabilizer/Delete button

Press the button to turn optical image stabilizer on/off.

 (On) → setting canceled

- When you wish to record as you walk, we recommend that you turn the optical image stabilizer on.
- When recording with a tripod, we recommend that you set the optical image stabilizer off.

-
- Stabilization may not be possible under strong camera shaking conditions.

Recording functions of operation icons

Select the operation icons to add different effects to the images to be recorded.

◇ Change the mode to .

1 Press the **ENTER** button to display the operation icons on the screen.











- The indication changes each time you press ▼ of the cursor button.
- Press the ENTER button to display/not-display the operation icon.

2 (e.g. Backlight Compensation)
Select an operation icon.



- Select the operation icon again to cancel the function.
- Refer to the respective pages for canceling the following functions.
 - Help Mode (→ 50)
 - Guidelines (→ 50)

Operation icons

	Fade
	Backlight Compensation
	Help Mode ^{*1}
	Guidelines
	Tele Macro ^{*1}
P.REC	PRE-REC ^{*1}
	Soft Skin Mode ^{*1,2}
	Intelligent Contrast Control ^{*2}
	Color Night Rec ^{*1,2}

*1 It is not displayed during recording.

*2 It is not displayed in the Intelligent Auto Mode.

- If you turn off the unit or change the mode to , Backlight Compensation, Tele Macro, PRE-REC and Color Night Rec functions are canceled.
- If you turn off the unit, the Fade function is canceled.
- It is possible to set from the menu.
(Except for the Help Mode and PRE-REC)

Fade

VIDEO

When you start recording, the image/audio gradually appears. (Fade in)

When you pause recording, the image/audio gradually disappears. (Fade out)

- The Fade setting is canceled when the recording stops.

■ To select the color for Fade in/out

MENU : [RECORD SETUP] → [FADE COLOR] →
[WHITE] or [BLACK]

(Fade in)



(Fade out)



- The thumbnails of scenes recorded using fade in become black (or white).
- If the recordable time runs out when you start recording, the recording fades out and stops automatically.

Backlight Compensation

VIDEO

PHOTO

This makes the image brighter to prevent darkening of a backlit subject.

Help Mode

VIDEO

PHOTO

Select the desired icon using the cursor button to display an explanation on the screen.

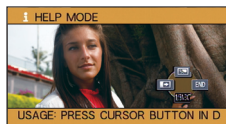

To exit the Help Mode

Press the MENU button or select [END].

- You cannot record or set functions while in Help Mode.

Guidelines

VIDEO

PHOTO

You can check if the image is level while recording. The function can also be used to estimate the balance of the composition.

It will switch every time the icon is selected.

 →  →  → Setting canceled

- The guidelines do not appear on the images actually recorded.



Tele Macro

VIDEO

PHOTO

A more impressive image can be obtained by focusing on the object only in close-up and shading off the background.

- The unit can focus on the subject at a distance of approx. 70 cm (28").
- If you set the Tele Macro function when the zoom is set to less than 37×, the zoom is automatically adjusted to 37×.

-
- Tele Macro function is canceled when the zoom magnification becomes lower than 37×.

PRE-REC

P.REC

This prevents you from missing a shot.

VIDEO

This allows recording of the pictures and sound to start approximately 3 seconds before the recording start/stop button is pressed.

- **PRE-REC** appears on the screen.

-
- **Aim the unit at the subject beforehand.**

- There is no beep sound.

- PRE-REC is canceled in the following cases.

- If you change the mode

- **HC-V100**

- If you remove the SD card

- **HC-V100M**

- If you remove the SD card while [MEDIA SELECT] is set to [VIDEO/SD CARD]

- If you press the MENU button

- If you turn the unit off

- If you start recording

- After 3 hours have passed

- After setting PRE-REC, if recording starts in less than 3 seconds, motion pictures taken 3 seconds before pressing the recording start/stop button cannot be recorded.

- Images displayed on the thumbnail in Playback Mode will differ from the motion pictures displayed at the start of playback.



Soft Skin Mode

VIDEO

PHOTO

This makes skin colors appear softer for a more attractive appearance.

This is more effective if you record a person closely from the torso up.

-
- If the background or anything else in the scene has colors similar to the skin color, they will also be smoothed.
 - If the brightness is insufficient, the effect may not be clear.
 - If you record a person in the distance, the face may not be recorded clearly. In this case, cancel Soft Skin Mode or zoom in on the face (close-up) to record.



Intelligent Contrast Control

VIDEO

PHOTO

This brightens parts that are in shadow and difficult to see and suppresses white saturation in bright parts at the same time. Both bright and dark parts can be recorded clearly.

- If there are extremely dark or bright parts or the brightness is insufficient, the effect may not be clear.



Color Night Rec

VIDEO

PHOTO

This function allows you to record color images in very low light situations. (Minimum required illumination: approx. 1 lx)

- **Recorded scene is seen as if frames were missed.**
- If set in a bright place, the screen may become washed out for a while.
- Bright dots that are usually invisible may be seen, but this is not a malfunction.
- Using a tripod is recommended.
- In darker areas, Auto Focus may focus a bit slower. This is normal.

Recording functions of menus

- Change the mode to .

[SCENE MODE]

VIDEO

PHOTO

When you record images in different situations, this mode automatically sets optimum shutter speeds and apertures.

 : [RECORD SETUP] → [SCENE MODE] → **desired setting**

[OFF]:

Cancel the setting

 **Sports:**

To make fast moving scenes less shaky with slow playback and pause of playback

 **Portrait:**

To make people stand out against the background

 **Spotlight:**

Improved quality when subject is brightly illuminated.

 **Snow:**

Improved image quality when shooting in snowy locations.

 **Beach:**

To make blue in the sea or sky vibrant

 **Sunset:**

To make red in the sunrise or sunset vibrant

 **Fireworks:**

To capture the fireworks in the night sky beautifully

 **Scenery:**

For spatial scenery

 **Night scenery:**

To capture the evening or night scenery beautifully.

 **Low light:**

For dark scenes, such as at dusk

- **(Sunset/Low light)**
 - The shutter speed is 1/30 or more.
- **(Sunset/Fireworks/Scenery/Night scenery)**
 - Image may get blurry when close object is recorded.
- **(Sports)**
 - During normal playback, the image movement may not look smooth.
 - Color and screen brightness may change under indoor lighting.
 - If the brightness is insufficient, the Sports Mode does not function. The  display flashes.
- **(Portrait)**
 - Color and screen brightness may change under indoor lighting.
- **(Fireworks)**
 - The shutter speed is 1/30.
 - Image may get washed out when recorded in bright surrounding.
- **(Night scenery)**
 - Using a tripod is recommended.

[ZOOM MODE]

VIDEO

PHOTO

Set the maximum zoom ratio.



: [RECORD SETUP] → [ZOOM MODE] → desired setting

[i.Zoom OFF]:	Up to 37×
[i.Zoom 42×]:	This zoom function allows you to maintain high-definition picture quality. (Up to 42×)
[D.Zoom 90×]:	Digital zoom (Up to 90×)
[D.Zoom 2000×]:	Digital zoom (Up to 2000×)

- The larger the digital zoom magnification, the more the image quality is degraded.

[REC MODE]

VIDEO

Switch the picture quality and recording format of the motion pictures to be recorded.



: [RECORD SETUP] → [REC MODE] → desired setting

[HA]/[HG]/[HX]*1:	Set the recording mode to AVCHD.
[iFrame]*2:	Set the recording mode to iFrame.

*1 Recording will have higher quality in the order of [HA], [HG] and [HX].

*2 [iFrame] is a format suitable for Mac (iMovie'11). It is recommended when using a Mac.

• Recordable time using the battery (→ 23)

- This function's default setting is [HG] mode.
- Please refer to page 114 about approximate recordable time.
- When the unit is moved a lot or moved quickly, or when a fast-moving subject is recorded (particularly when recording in [HX] mode), mosaic-type noise may appear at playback.

[FACE FRAMING]

VIDEO

PHOTO

Detected faces appear with frames.



: [RECORD SETUP] → [FACE FRAMING] → desired setting

[PRIMARY]:

Only the prioritized face framing is displayed.

[ALL]:

All face detection framings are displayed.

[OFF]:

Cancel the setting.



- Up to 15 frames are indicated. Larger faces and faces nearer to the center of the screen take preference over others.

■ Prioritized face framing

Prioritized face framing is displayed as orange frames. Focus and adjustment of brightness will be performed against the prioritized face framing.

- Prioritized face framing is only displayed with Portrait Mode in the Intelligent Auto Mode.
- The white frame is for face detection only.

[AGS]

VIDEO

If the unit continues to be tilted upside down from the normal horizontal position while recording motion pictures, it is automatically put into recording pause.



: [RECORD SETUP] → [AGS] → [ON]

- The AGS function may activate and cause the unit to pause the recording if you are recording a subject right above or right below you.

[AUTO SLOW SHTR]

VIDEO

PHOTO

You can record bright pictures even in dark places by slowing the shutter speed.

- **Switch to Manual Mode.** (→ 59)

MENU



: [RECORD SETUP] → [AUTO SLOW SHTR] → [ON]

- The shutter speed is set to 1/30 or more depending on the surrounding brightness.
- When the shutter speed becomes 1/30, the screen may be seen as if frames are missed and afterimages may appear.

[WIND CUT]

VIDEO

This is for reducing the wind noise coming into the built-in microphones.

- **Switch to Manual Mode.** (→ 59)

MENU



: [RECORD SETUP] → [WIND CUT] → [ON]

- This function's default setting is [OFF].
- When switching to Intelligent Auto Mode, [WIND CUT] is set to [OFF], and the setting cannot be changed.
- You may not see the full effect depending on the recording conditions.

When recording, the input level from the built-in microphones can be adjusted.

- **Switch to Manual Mode.** (→ 59)

1 Select the menu.

MENU : [RECORD SETUP] → [MIC LEVEL] → desired setting

[AUTO]: AGC is activated, and the recording level is adjusted automatically.

[SET+ **AGC]:** The desired recording level can be set. AGC is activated, reducing noise.

[SET]: The desired recording level can be set. You will be able to record natural-sounding audio.

2 (When [SET+ **AGC**]/[SET] is selected)

Press ◀/▶ to adjust.

- Adjust the microphone input level so that the last 2 bars of the gain value are not red. (Otherwise, the sound is distorted.) Select a lower setting for microphone input level.

3 Press the ENTER button to determine the microphone input level and then press the MENU button.

- □□□■ ■■■■ (Microphone input level meter) appears on the screen.

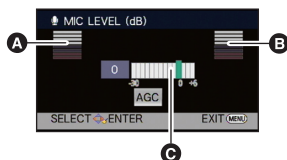



- A** Left
- B** Right
- C** Microphone input level

- In Intelligent Auto Mode this setting is set to [AUTO] and cannot be changed.
- The microphone input level meter shows the larger of the inputs from the 2 built-in microphones.
- You cannot record with the audio completely muted.

Selecting the picture quality.

 : **[PICTURE]** → **[QUALITY]** → **desired setting**

 : Still pictures with a high picture quality are recorded.

 : Priority is given to the number of still pictures recorded. Still pictures are recorded in normal picture quality.

You can add a shutter sound when recording still pictures.

 : **[PICTURE]** → **[SHTR SOUND]** → **desired setting**

 : Volume low

 : Volume high

[OFF]: Cancel the setting.

Manual recording

◇ Change the mode to  .

Press the **iA/MANUAL** button to switch to Manual Mode.

- **MNL** appears on the screen.

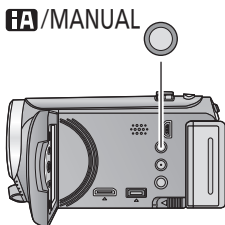

WB	White Balance
SHTR	Manual Shutter Speed (→ 61)
IRIS	Iris Adjustment (→ 61)
MF	Focus (→ 62)

- Press the ENTER button to display/not display the manual icon.
- The page changes with each press of ▼.

White Balance

Automatic White Balance function may not reproduce natural colors depending on the scenes or lighting conditions. If so, you can adjust the White Balance manually.







- Press the **iA/MANUAL** button to switch to Manual Mode.

1 Select **[WB]** using the cursor button.

2 Press ◀/▶ to select White Balance Mode.

- Select the optimal mode by confirming the color on the screen.





Icon	Mode/Recording conditions
	Auto White Balance adjustment
	Sunny mode: Outdoors under a clear sky
	Cloudy mode: Outdoors under cloudy sky, or in shade
	Indoor mode 1: Incandescent light, video lights like in the studio, etc.
	Indoor mode 2: Color fluorescent lamps, sodium lamps in gymnasiums, etc.
	Manual adjustment mode: <ul style="list-style-type: none"> • Mercury-vapor lamps, sodium lamps, some fluorescent lights • Lights used for wedding receptions at hotels, stage spotlights in theaters • Sunrise, sunset, etc.

- To return to auto setting, select **AWB** or press the i/MANUAL button.

■ To set the White Balance manually

1 Press ◀▶ to select , and fill the screen with a white subject.

2 Press ▲ to set.

- When the  display stops flashing and then lights constantly, the setting is complete.
- If the  display continues flashing, the White Balance cannot be set. In this case, use other White Balance Modes.

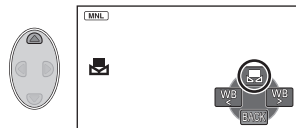

- If you turn on the unit with the lens cover closed, the Auto White Balance will not be performed correctly. Always open the lens cover before turning on the unit.
- When the  display flashes, the Manual White Balance previously adjusted is stored. Whenever recording conditions change, re-set the White Balance.
- When setting both the White Balance and the iris/gain, set the White Balance first.
- **AWB** is not displayed on the screen when **AWB** is being set.

Manual shutter speed/Iris adjustment

Shutter Speed:

Adjust it when recording fast-moving subjects.

Iris:

Adjust it when the screen is too bright or too dark.

- Press the **iA/MANUAL** button to switch to Manual Mode. (→ 59)

1 Select **[SHTR]** or **[IRIS]** using the cursor button.

2 Press **◀/▶** to adjust settings.

A **SHTR** : Shutter speed:

1/60 to 1/8000

- If **[AUTO SLOW SHTR]** is set to **[ON]**, the shutter speed will be set between 1/30 and 1/8000.
- The shutter speed closer to 1/8000 is faster.

B **IRIS** : Iris/Gain value:

CLOSE (↔ **F16 to F2.0**) ↔ **OPEN** (↔ **0dB to 18dB**)

- Value closer to **CLOSE** darken the image.
- Value closer to **18dB** brighten the image.
- When the iris value is adjusted to brighter than **OPEN**, it changes to the gain value.
- To return to auto setting, press the **iA/MANUAL** button.



- When setting both the shutter speed and the iris/gain value, set the shutter speed and then set the iris/gain value.

Manual shutter speed adjustment

- You may see a band of light around an object that is shining very bright, or highly reflective.
- During normal playback, image movement may not look smooth.
- If you record an extremely bright object or record under indoor lighting, color and screen brightness may change or a horizontal line may appear on the screen. In this case, record in the Intelligent Auto Mode or set the shutter speed to 1/60 in areas where the power supply frequency is 60 Hz, or 1/100 in areas of 50 Hz.

Manual iris/gain adjustment

- If the gain value is increased, the noise on the screen increases.
- Depending on the zoom magnification, there are iris values that are not displayed.

Recording with Manual Focus

If auto focusing is difficult due to the conditions, then use Manual Focus.

- Press the i/MANUAL button to switch to Manual Mode. (→ 59)

1 Press ▼ to switch the manual icon.

2 Select [MF] using the cursor button to change to Manual Focus.

- MF appears on the screen.

3 Press ◀/▶ to adjust the focus.

MF
+ : To focus on a close subject

MF
- : To focus on a faraway subject





- To restore Auto Focus, select [AF] or press the i/MANUAL button.

Playback Operations

Motion picture playback using operation icon

VIDEO

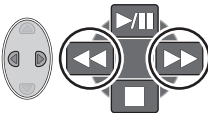

For details on the basic playback operations, refer to page 36.

Playback operation	Cursor button/ Playback display	Operating steps
Fast forward/ rewind playback	<p>During Playback</p> 	<p>Press ► of the cursor button during playback to fast forward. (Press ◀ to rewind.)</p> <ul style="list-style-type: none"> Press again to speed up fast forward/rewind (the screen display will change from ►► to ►►►). Normal playback is restored when you press ▲.
Slow-motion playback	<p>During Pause</p> 	<p>With the playback paused, press and hold ► of the cursor button. (Press and hold ◀ for slow rewind playback)</p> <p>Slow-motion playback will continue over the period that the button is pressed.</p> <ul style="list-style-type: none"> Normal playback is restored when you press ▲. When slow-motion pictures are played back in reverse, they will be shown continuously at approximately 2/3rd the speed of normal playback.
Frame-by-frame playback The motion picture is advanced one frame at a time.		<p>With the playback paused, press ► of the cursor button. (Press ◀ to advance the frames one at a time in the reverse direction.)</p> <ul style="list-style-type: none"> Normal playback is restored when you press ▲. When the frames are advanced one at a time in the reverse direction, they will be shown in intervals of 0.5 seconds (AVCHD). When the frames are advanced one at a time in the reverse direction, they will be shown in intervals of 1 second (iFrame).

Creating still picture from motion picture

VIDEO

A single frame from the recorded motion picture can be saved as a still picture. The picture size of the still picture to be created will differ depending on the recording mode of the recorded motion picture.

Recording mode	Aspect ratio	Picture size after creating still picture	
[HA]/[HG]/[HX]	16:9		1920×1080
[iFrame]			960×540

Press the  button at the location to be saved as a still picture during the playback.

- It is convenient to use Pause, Slow-motion Playback and Frame-by-frame Playback.
- The date the motion picture was recorded will be registered as date of the still picture.
- Quality will be different from the normal still picture.

Repeat playback

VIDEO

Playback of the first scene starts after playback of the last scene finishes.

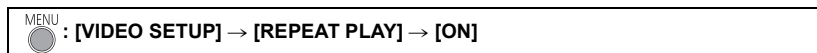

The  indication appears on the full screen views.

- All the scenes are played back repeatedly. (When playing back motion pictures by date, all the scenes on the selected date are played back repeatedly.)

Resuming the previous playback

VIDEO

If playback of a scene was stopped halfway, the playback can be resumed from where it was stopped.

 : [VIDEO SETUP] → [RESUME PLAY] → [ON]

If playback of a motion picture is stopped,  appears on the thumbnail view of the stopped scene.

- The memorized resume position is cleared if you turn off the unit or change the mode. (The setting of [RESUME PLAY] does not change.)

Zooming in on a still picture during playback (Playback zoom)

PHOTO

You can zoom in on still pictures during playback.

1 Move the zoom lever to side.

- You can zoom to a maximum of 4 \times . ($\times 1 \rightarrow \times 2 \rightarrow \times 4$)

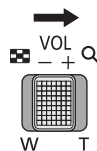

2 Shift the position of the zoomed portion using the cursor button.

- The location of the zoom displays for about 1 second when zooming in/zooming out or moving the displayed location.
- The more a picture is enlarged, the more its quality deteriorates.



- A** Displayed location of the zoom

Zooming out from the zoomed still picture

Move the zoom lever to  side to zoom out. ($\times 4 \rightarrow \times 2 \rightarrow \times 1$)

Various playback functions

Playing back motion pictures/still pictures by date

VIDEO PHOTO

The scenes or the still pictures recorded on the same day can be played back in succession.

- 1** Select the date select icon using the cursor button, then press the ENTER button.

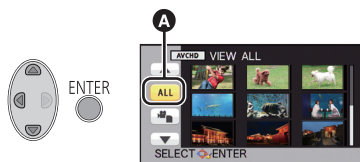

A Date select icon

- 2** Select the playback date, then press the ENTER button.

The scenes or the still pictures recorded on the date selected are displayed as thumbnails.

- 3** Select the scene or the still picture to be played back, then press the ENTER button.

- Playing back of all the scenes or the still pictures returns if the unit is turned off or the mode is changed.
- Even if the scenes have been recorded on the same day, they will be displayed separately in the following cases. -1, -2 ... are added after the date displayed on the list by date.
 - When the number of scenes exceeds 99
 - When the number of recorded still pictures exceeds 999
- [540p] is displayed after the date in the list by date for scenes recorded using iFrame.
- [↓] is displayed after the date in the list by date for the still pictures created from the motion picture. (→ 64)

Changing the playback settings and playing back the slide show

PHOTO

- 1** Select  using the cursor button, then press the ENTER button.



- 2** (Only when you would like to change the settings)
Select the desired item and press the ENTER button.

[DATE SETUP]: Select the date to be played back.

[SLIDE INTERVAL]: Selects the interval between still pictures at playback.

[MUSIC SELECT]: Select the music to be played on playback.

- 3** (When [DATE SETUP] is selected)
Select the playback date, then press the ENTER button.



(When [SLIDE INTERVAL] is selected)

Select the desired item and press the ENTER button.

[SHORT]: Approx. 1 second

[NORMAL]: Approx. 5 seconds

[LONG]: Approx. 15 seconds

(When [MUSIC SELECT] is selected)

Select the desired sound and press the ENTER button.

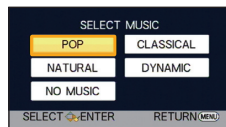

4 Select [START] and press the ENTER button.

5 Select the playback operation. (→ 36)

- When the playback is finished or stopped, the screen to select [REPLAY], [SELECT AGAIN] or [EXIT] is displayed. Select the desired item and press the ENTER button.
- To adjust the volume of music during playback of the slide show, operate the volume lever. (→ 37)

Deleting scenes/still pictures

Deleted scenes/still pictures cannot be restored, so perform appropriate confirmation of the contents before proceeding with deletion.

◇ Change the mode to  .



To delete the scene or still picture being played back

Press the Optical image stabilizer/Delete button while scenes or still pictures to be deleted are being played back.

■ To delete scenes or still pictures from the thumbnail display

1 Press the Optical image stabilizer/Delete button while the thumbnail view screen is displayed.

2 Select [ALL SCENES] or [SELECT] using the cursor button, then press the ENTER button.

- All the scenes or still pictures displayed as thumbnails will be deleted by selecting [ALL SCENES].

(In case of playing back scenes or still pictures by date, all the scenes or still pictures on the selected date will be deleted.)

- Protected scenes/still pictures cannot be deleted.

3 (When [SELECT] is selected in Step 2)

Select the scene/still picture to be deleted, then press the ENTER button.

- The scene/still picture is selected and the  indication appears on the thumbnail. Press the ENTER button again to cancel the operation.
- Up to 99 scenes can be selected to be deleted.

4 (When [SELECT] is selected in Step 2)

Select [Delete], and press the ENTER button, or the Optical image stabilizer/Delete button.

- To continuously delete other scenes/still pictures, repeat steps 3-4.

When you stop deleting halfway

Press the MENU button while deleting.

- The scenes or still pictures that have already been deleted when the deletion is canceled cannot be restored.

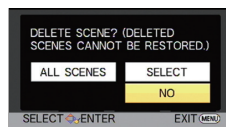

To complete editing

Press the MENU button.

- You can also delete scenes by pressing the MENU button, selecting [EDIT SCENE] → [DELETE] → [ALL SCENES] or [SELECT].
- You can also delete still pictures by pressing the MENU button, selecting [PICT. SETUP] → [DELETE] → [ALL SCENES] or [SELECT].
- Scenes which cannot be played back (the thumbnails are displayed as ) cannot be deleted.
- In case of [ALL SCENES], the deletion may take time if there are many scenes or still pictures.
- If you delete scenes recorded on other products or still pictures conforming to DCF standard with this unit, all the data related to the scenes/still pictures may be deleted.
- When still pictures recorded on an SD card by other products are deleted, a still picture (other than JPEG) that cannot be played back on this unit may be erased.

Dividing a scene (AVCHD)

VIDEO

It is possible to divide an AVCHD scene. Any unwanted parts in the scene can be deleted after dividing.

- Change the mode to , and set [VIDEO/PICTURE] of the play mode selection to [AVCHD]. (→ 36)

1 Select the menu.

 : [EDIT SCENE] → [DIVIDE] → [SET]

2 Select the scene you wish to divide using the cursor button and press the ENTER button.

3 Select to set the dividing point.

- It is convenient to use Slow-motion Playback and Frame-by-frame Playback. (→ 63)
- Select [YES] to continue dividing the same scene. To continue dividing other scenes, select [NO] and repeat Steps 2-3.



4 Press the MENU button to complete dividing.

- Unwanted parts can be deleted. (→ 69)

To delete all the divided points

 : [EDIT SCENE] → [DIVIDE] → [CANCEL ALL]

- The scenes that were deleted after division cannot be recovered.
- You cannot divide a scene if the number of scenes of a given date would exceed 99 scenes.
- It may not be possible to divide scenes with a short recording time.
- Data that has been recorded or edited on another device cannot be divided and the divided points cannot be deleted.

Dividing a scene to partially delete (iFrame)

VIDEO

Divide the iFrame scene, and delete unnecessary parts.

This divides the recorded scenes in two and deletes the front half or back half.

The scenes that were deleted after division cannot be recovered.

- Change the mode to , and set [VIDEO/PICTURE] of the play mode selection to [iFrame]. (→ 36)

1 Select the menu.

 : [EDIT SCENE] → [SPLIT&DELETE]

2 Select the scene you wish to divide using the cursor button and press the ENTER button.

3 Select to set the dividing point.

- It is convenient to use Slow-motion Playback and Frame-by-frame Playback. (→ 63)
- Set to at least 2 seconds for the portions to be deleted and at least 3 seconds for the portion that is to remain.

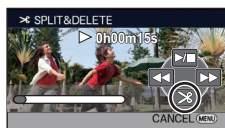

4 Select the part for deletion, then press the ENTER button.

5 Select [YES] and press the ENTER button to confirm (play back) the part for deletion.

- A confirmation message appears when [NO] is selected. Proceed to Step 7.

6 Stop the playback.

- A confirmation message appears.

7 Select [YES] and press the ENTER button.

- To continue dividing and deleting other scenes, repeat Steps 2-7.

To complete dividing

- Press the MENU button.

- It may not be possible to divide scenes with a short recording time.
- The actual division may slightly slip off the previously designated dividing point.

Protecting scenes/still pictures

VIDEO

PHOTO

Scenes/still pictures can be protected so that they are not deleted by mistake.

(Even if you protect some scenes/still pictures, formatting the media will delete them.)

- Change the mode to  .

1 Select the menu.

MENU



: [VIDEO SETUP] or [PICT. SETUP] → [SCENE PROTECT]

2 Select the scene/still picture to be protected using the cursor button, then press the ENTER button.

- The scene/still picture is selected and the  indication appears on the thumbnail. Press the ENTER button again to cancel the operation.
- Press the MENU button to complete the settings.

Watching Video/Pictures on your TV

Confirm the terminals on your TV and use a cable compatible with the terminals. Image quality may vary with the connected terminals.

- A High quality
- 1 HDMI terminal
- 2 Component terminal
- 3 Video terminal



- Use the AV multi cable (supplied) or HDMI mini cable (optional) and check the output settings. (→ 77)
- HDMI is the interface for digital devices. If you connect this unit to an HDMI compatible high definition TV and then play back the recorded high-definition images, you can enjoy them in high resolution with high quality sound.

1 Connect this unit to a TV.

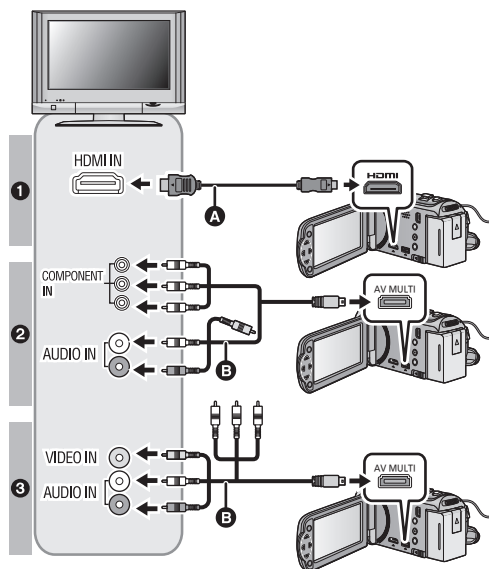

- A HDMI mini cable (optional)
- Be sure to connect to the HDMI terminal.
- B AV multi cable (supplied)

Picture quality

- 1 High-definition images when connecting to HDMI terminal
- 2 High-definition images when connecting to component terminal compatible with 1080i Standard images when connecting to component terminal compatible with 480i
- 3 Standard images when connecting to video terminal

- Check that the plugs are inserted as far as they can go.
- Always use a genuine Panasonic HDMI mini cable (RP-CDHM15, RP-CDHM30: optional).
- Do not use any other AV multi cables except the supplied one.
- When connecting to the component terminal of the TV, the yellow plug of the AV multi cable is not required.
- When connecting to the AV terminal of the TV, do not connect the component terminal plug of the AV multi cable. Image may not display when the component terminal plug is connected simultaneously.

2 Select the video input on the TV.

- Example:
Select the [HDMI] channel with an HDMI mini cable.
Select the [Component] or [Video 2] channel with an AV multi cable.
(The name of the channel may differ depending on the connected TV.)
- Check the input setting (input switch) and the audio input setting on the TV. (For more information, please read the operating instructions for the TV.)

3 Change the mode to to play back.

- When connected to a television, the unit does not output sound in playback mode. Also, the volume cannot be adjusted on the unit, so please make volume adjustments on your television.
- Operation icon will disappear when connected with an HDMI mini cable. Press the ENTER button to display operation icon.

Cables	Reference items
A HDMI mini cable (optional)	<ul style="list-style-type: none"> • Connecting with a HDMI mini cable (→ 77) • Playback using VIERA Link™ (→ 78)
B AV multi cable (supplied)	<ul style="list-style-type: none"> • Connecting with the AV multi cable (→ 77)

- When the AV multi cable is connected to this unit, the setup screen of the AV multi destination is displayed on the screen of this unit. Select either [COMPONENT] or [AV OUT] in accordance with the terminal connecting to the TV. (→ 77)
- If the HDMI mini cable and AV multi cable are connected at the same time, output will be prioritized in order of the HDMI mini cable, AV multi cable.
- No audio will be played on the TV during recording mode.

■ **To watch images on a regular TV (4:3) or when both sides of the images do not appear on the screen**

Change the menu setting to display the images correctly. (Check the TV setting.)

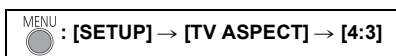

- When this setting is set to [4:3] and the unit is connected to a television using the AV multi cable, the image may appear in a shrunken form.

Example of images with a [16:9] aspect ratio on a regular TV (4:3)

[TV ASPECT] setting	
[16:9]	[4:3]

- If a wide-screen TV is connected, adjust the aspect setting on the TV. (Refer to the operating instructions of the TV for details.)

Refer to the following support site for information about Panasonic TVs with an SD card slot for playing back your pictures.

<http://panasonic.net/>

- It may not be possible to play back [iFrame] scenes.
- For details on how to play back, please read the operating instructions for the TV.

■ **To display the on-screen information on the TV**

When the menu setting is changed, the information displayed on the screen (operation icon and time code etc.) can be displayed/not displayed on the TV.

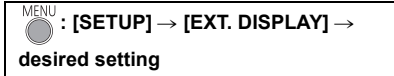

[SIMPLE]*: Information partially displayed

[DETAIL]: All information displayed

[OFF]: Not displayed

- * This setting is only available in Recording Mode.

Connecting with a HDMI mini cable

Select the desired method of HDMI output.

 : [SETUP] → [HDMI RESOLUTION] → [AUTO]/[1080i]/[480p]

- [AUTO] determines the output resolution automatically based on information from the connected TV.
If the images are not output on the TV when the setting is [AUTO], switch to the method [1080i] or [480p] which enables the images to be displayed on your TV. (Please read the operating instructions for the TV.)

Connecting with the AV multi cable

AV multi connector output setting can be changed.

 : [SETUP] → [AV MULTI] → **desired setting**

[COMPONENT]: When connecting to the component terminal

[AV OUT]: When connecting to the video terminal

Changing the component output setting

 : [SETUP] → [COMPONENT OUT] → **desired setting**

[1080i]: When connecting to the component terminal on the TV compatible with 1080i. (Playback is in high-definition quality.)

[480i]: When connecting to the component terminal on the TV compatible with 480i. (Playback is in standard quality.)

Playback using VIERA Link™

What is the VIERA Link (HDAVI Control™)?

- VIERA Link™ is a new name for EZ Sync™.
- This function allows you to use your remote control for Panasonic TV for easy operations when this unit has been connected to a VIERA Link compatible device using an HDMI mini cable (optional) for automatic linked operations. (Not all operations are possible.)
- VIERA Link is a unique Panasonic function built on an HDMI control function using the standard HDMI CEC (Consumer Electronics Control) specification. Linked operations with HDMI CEC compatible devices made by other companies are not guaranteed. When using devices made by other companies that are compatible with VIERA Link, refer to the operating instructions for the respective devices.
- This unit is compatible with VIERA Link Ver.5. VIERA Link Ver.5 is the newest Panasonic version and is also compatible with existing Panasonic VIERA Link devices. (As of Nov. 2011)

◇ Change the mode to  .

1 Select the menu.

MENU : [SETUP] → [VIERA Link] → [ON]

- If you are not using VIERA Link, set to [OFF].

2 Connect this unit to a Panasonic TV compatible with VIERA Link with a HDMI mini cable.

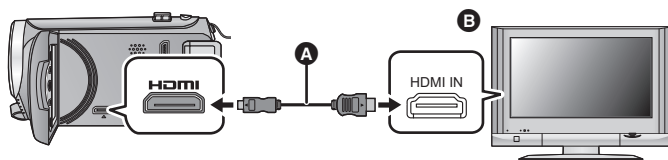

- A** HDMI mini cable (optional)
- B** Panasonic TV compatible with VIERA Link
- It is recommended to connect this unit to an HDMI terminal other than the HDMI1 if there are 2 or more HDMI input terminals on the TV.
- VIERA Link must be activated on the connected TV. (Read the operating instructions of the TV for how to set, etc.)
- Always use a genuine Panasonic HDMI mini cable (RP-CDHM15, RP-CDHM30: optional).

3 Operate with the remote control for the TV.

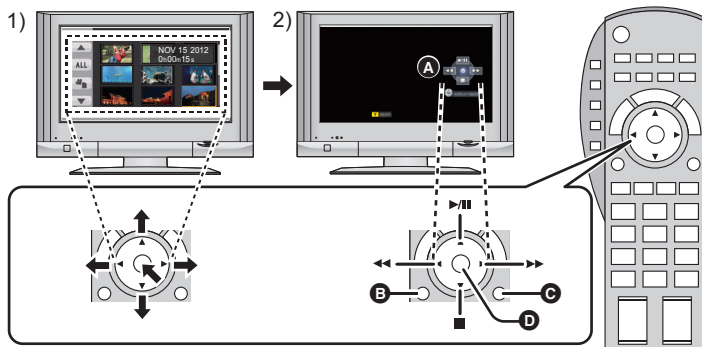

- 1) Press the button up, down, left or right to select a scene or still picture to be played back, and then press the button in the center to set it.
- 2) Activate the operation icons that are displayed on TV screen with the remote control for the TV.

A Operation icons

B Display operation icons

C Cancel operation icons

D Display/Cancel operation icons

- The following operations are available by pressing the color buttons on the remote control.
 - Green: Switching the number of scenes/still pictures in thumbnail display (9 thumbnails → 20 thumbnails → 9 thumbnails...)
 - Yellow: Deleting scenes/still pictures
 - Red: Zoom out from still picture
- To change the media for playback and [VIDEO/PICTURE], change the play mode selection using the cursor button on the unit. (→ 36)

■ Other linked operations

Turning the unit off:

If you use the remote control for the TV to turn off the power, this unit also turns off.

Automatic input switching:

If you connect with an HDMI mini cable and then turn on this unit, the input channel on the TV automatically switches to this unit's screen. If the TV's power is in standby status, it will turn on automatically (if [Set] has been selected for the TV's [Power on link] setting).

- Depending on the HDMI terminal on the TV, the input channel may not switch automatically. In this case, use the remote control for the TV to switch the input channel.

-
- If you are unsure whether or not the TV and AV amplifier you are using are compatible with VIERA Link, read the operating instructions for the devices.
 - Available linked operations between this unit and a Panasonic TV is different depending on the types of Panasonic TVs even if they are compatible with VIERA Link. Refer to the operating instructions of the TV for the operations that support on the TV.
 - Operation is not possible with a cable that is not based on the HDMI standard.

Copying from Built-in Memory to SD card [HC-V100M]

Motion pictures or still pictures recorded with this unit can be copied from a built-in memory to an SD card inserted in this unit.

■ Check the used space of the SD card

It is possible to check the used space of the SD card by [MEDIA STATUS] (→ 45).

- Depending on the media condition, some remaining capacity of the SD card may not be used.
- If the remaining capacity on a single SD card is not enough, you can copy to multiple SD cards following the instruction on the screen. In this case, the last scene copied to an SD card is automatically divided to fit the space on the SD card.
- If you divide the scenes (→ 71), and copy by scene selection, it is possible to copy matching the remaining capacity of the SD card, or only the necessary parts.

Copying

- If there is not much remaining capacity in the SD card, a confirmation message asking to copy after deleting all data on the SD card is displayed. Be aware that deleted data cannot be restored.



1 Change the mode to .

- Use a sufficiently charged battery or the AC adaptor.

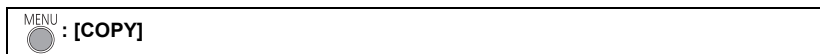
2 Select the menu.



3 Following the screen display, select the desired item using the cursor button, and press the ENTER button.

- Select  and press the ENTER button to return to the previous screen.
- (When [SELECT SCENES] is selected)
When you press the ENTER button, the scene/still picture is selected and  indication appears on the thumbnail. Press the ENTER button again to cancel the operation.
- (When [SELECT DATE] is selected)
When you press the ENTER button, a date is selected and surrounded by red. Press the ENTER button again to cancel the operation.
- Up to 99 scenes/still pictures or 99 dates can be set in succession.
- If 2 or more SD cards are necessary to copy, change the card following the instructions on the screen.

4 Press the MENU button when the copy complete message is displayed.

- The thumbnail view of the copy destination is indicated.

When you stop copying halfway

Press the MENU button while copying.



If you will delete the motion pictures or still pictures after copying is complete, be sure to play back the motion pictures or still pictures to check that they have been copied to correctly before deleting.

- Depending on the following conditions, the time it takes for copying may be longer.
 - The number of recorded scenes is large.
 - The temperature of the unit is high.
- If some motion pictures or still pictures have already been recorded to the copy destination, then the same date may be assigned or images may not display by date when the list by date is selected.
- Protection setting will be cleared on the copied motion pictures and still pictures when copying motion pictures and still pictures with protection setting.
- The order in which the scenes or still pictures were copied cannot be changed.

Dubbing with a Blu-ray disc recorder, video devices, etc.

■ Check before dubbing

Check the equipment used for dubbing.

Equipment used for dubbing	Dubbing picture quality	To dub
Equipment with SD card slot	High-definition picture quality*	Insert the SD card directly (→ 83) 
Equipment with USB terminal	High-definition picture quality*	Connect with supplied USB cable (→ 83) 
Equipment without SD card slot or USB terminal	Standard picture quality This can be played back on equipment not compatible with high-definition (AVCHD), so it is convenient if you are dubbing for distribution.	Connect with supplied AV multi cable (→ 85) 

- * Some equipment may not be compatible with high-definition (AVCHD) picture quality. In such a case, connect with the AV multi cable and dub with standard picture quality. (→ 85)
- For the positions of the SD card slot, USB terminal, or terminal for connecting the AV multi cable, refer to the operating instructions of the equipment used.
 - The iFrame scenes cannot be dubbed by inserting the SD cards or by connecting with the USB cable. To dub iFrame scenes, refer to page 85.

You can dub using a Panasonic Blu-ray disc recorder or high-definition (AVCHD) compatible DVD recorder.

- Depending on the recorders or the media to be copied to, you may not be able to copy in high-definition (AVCHD) picture quality. For further details, see the operating instructions of your recorder.
- Note that the equipment described may not be available in certain countries and regions.

■ To dub using equipment with an SD card slot

You can dub by directly inserting an SD card.

● HC-V100M

To copy scenes or still pictures from the built-in memory to an SD card, see page 80.

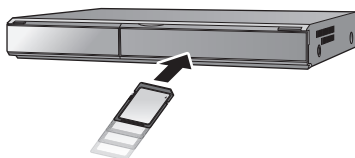

■ To dub using equipment with a USB terminal

You can dub by connecting a USB cable.

- Use the AC adaptor to free you from worrying about the battery running down.
- Turn on the unit (This function is available in all modes).

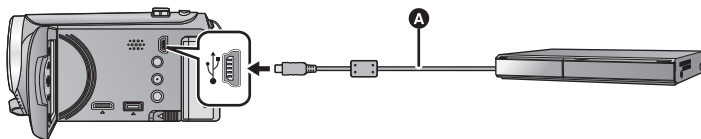

A USB cable (supplied)

- Insert the plugs as far as they will go.

1 Connect the unit to the Blu-ray disc recorder or high-definition (AVCHD) compatible DVD recorder.

- The USB function selection screen will appear on the screen of the unit.

2 Select [RECORDER] using the cursor button on the unit and press the ENTER button.

- When you select an option other than [RECORDER], reconnect the USB cable.

● HC-V100

When using the battery, the LCD monitor turns off after about 5 seconds. Press the cursor button to turn the LCD monitor on.

3

HC-V100M

Select the media you wish to dub, then press the ENTER button.

- When using the battery, the LCD monitor turns off after about 5 seconds. Press the cursor button to turn the LCD monitor on.

4

Dub through operations on the Blu-ray disc recorder or high-definition (AVCHD) compatible DVD recorder.

- Do not press the ENTER button of the unit during dubbing.

About the screen indication of the unit

- When the unit is accessing the SD card, card access icon () appears on the unit screen or the access lamp is on.

- **HC-V100M**

When the unit is accessing the built-in memory, built-in memory access icon () appears on the unit screen or the access lamp is on.

- Be careful not to disconnect the USB cable, AC adaptor or battery while the unit is accessing media, as this may result in the loss of recorded content.

-
- Do not use any other USB cables except the supplied one. (Operation is not guaranteed with any other USB cables.)
 - When this unit is connected to a Panasonic Blu-ray disc recorder or a DVD recorder using a USB cable while the unit is turned on, power is also supplied from the connected equipment to this unit.
 - For details on dubbing and playback methods, read the operating instructions of the Blu-ray disc recorder or DVD recorder.
 - When you connect the unit to a Blu-ray disc recorder, a dubbing operations screen may appear on the television connected to the Blu-ray disc recorder. In this case as well, perform the operations of Steps 1 to 4.
 - You cannot change the mode of the unit or turn off the unit while it is connected to a Blu-ray disc recorder or DVD recorder. Disconnect the USB cable before performing either of these operations.
 - If the battery runs down during dubbing, a message will appear. Operate the Blu-ray disc recorder to cancel the dubbing.

■ Dubbing using equipment without an SD card slot or a USB terminal, or using a video device

You can dub by connecting an AV multi cable.

- **Images are dubbed in standard quality.**
- Use the AC adaptor to free you from worrying about the battery running down.

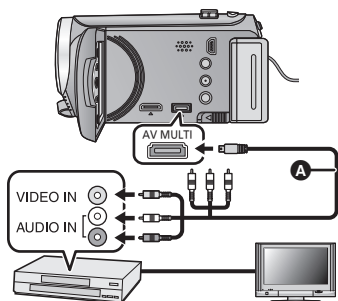

Change the video input on the video device and TV that this unit is connected to.

- The channel set will differ depending on the terminal to which the unit is connected.
 - See the operating instructions of the video device for details.
 - Insert the plugs as far as they will go.
 - Do not use any other AV multi cables except the supplied one.
- A** AV multi cable (supplied)

- Change the mode to .

1 Connect this unit to a video device and start playback on this unit.

2 Start recording on the connected device.

- To stop recording (dubbing), stop playback on this unit after stopping recording on the recorder.

-
- If the date and time display and function indication are not wanted, cancel them before dubbing. (→ 40, 76)
 - Turn off the operation icon by pressing the ENTER button when dubbing (→ 37).
 - For setting when connecting the AV multi cable, refer to page 77.

If the dubbed images are played back on a wide-screen TV, the images may be stretched vertically.

In this case, refer to the operating instruction of the device you are connecting to or read the operating instructions of the wide-screen TV and set the aspect ratio to 16:9.

What you can do with a PC

HD Writer LE 1.1

You can copy the motion/still picture data to the HDD of PCs or write to media like Blu-ray discs, DVD discs or SD cards using HD Writer LE 1.1, the software installed in the supplied CD-ROM.

Refer to the operating instructions of HD Writer LE 1.1 (PDF file) for details on how to use it.

■ Smart wizard

The Smart wizard screen is automatically displayed when you connect this unit to a PC with HD Writer LE 1.1 installed. (→ 94)



Copy to PC:

You can copy motion/still picture data to the HDD of PCs.

Copy to disc:

You can copy to disc in high-definition picture quality or conventional standard picture quality (MPEG2 format).

- Select the function you wish to use and follow the on-screen instructions for easy copying.

What can be done with the HD Writer LE 1.1	Data type
Copying data to a PC	Motion picture and still picture
Copying in Blu-ray disc/AVCHD format: <ul style="list-style-type: none"> • iFrame scenes cannot be copied in Blu-ray disc/AVCHD format. 	
Copying in DVD-Video format: <ul style="list-style-type: none"> • Converted to conventional standard quality (MPEG2 format). 	Motion picture
Editing: Editing motion picture data copied on an HDD of a PC <ul style="list-style-type: none"> • Dividing, Trimming, Still picture, Title, Effect, Transition, BGM, Delete partially • Converting the motion picture data to MPEG2 • Converting part of motion picture into still picture 	
Online sharing: You can upload motion pictures on the Internet and share them with your family and friends.	
Playing back on a PC: Play back the motion picture data in high-definition picture quality on a PC.	
Formatting discs: Depending on the type of disc that you use, formatting is necessary.	Motion picture

- It is possible to play back on a PC using an image viewer standard to Windows or commercially available image browsing software, and copy pictures to a PC using Windows Explorer.
- Please refer to page 98 for details about using a Mac.

Important Notice

- When using an SDXC Memory Card, check the following support site.
<http://panasonic.net/avc/sdcard/information/SDXC.html>
- Do not insert a disc recorded in AVCHD format with HD Writer LE 1.1 in a device that does not support the AVCHD format. In some cases the disc may get stuck in the device. The disc will not play back on devices that do not support the AVCHD format.
- When inserting a disc containing recorded motion pictures into other devices, a message prompting you to format the disc may be displayed. Do not format the disc, since deleted data cannot be restored later.

-
- Data cannot be written from a PC to the unit.
 - **HC-V100M**
It is impossible to write data to the built-in memory on this unit from a PC.
 - Motion pictures that have been recorded on another device cannot be written to the software supplied with this unit. To write motion picture data recorded with the Panasonic High Definition Video Camera sold previously, use the HD Writer supplied with the unit.
 - When motion picture data is written to and read from the SD card, correct operation of the unit cannot be guaranteed if software other than that supplied with the unit is used.
 - Do not start the software supplied with this unit and other software at the same time. Close any other software if you start the software supplied with this unit and close the software supplied with this unit if you start any other software.

End User License Agreement

Before opening the CD-ROM package, please read the following.

You ("Licensee") are granted a license for the Software defined in this End User License Agreement ("Agreement") on condition that you agree to the terms and conditions of this Agreement.

Article 1 License

Licensee is granted the right to use the software, including the information recorded or described on the CD-ROM, instruction manuals, and any other media provided to Licensee (collectively "Software"), but all applicable rights to patents, copyrights, trademarks and trade secrets in the Software are not transferred to Licensee.

Article 2 Use by a Third Party

Licensee may not use, copy, modify, transfer, rent, lease, lend or allow any third party, whether free of charge or not, to use, copy or modify the Software, except as expressly provided for in this Agreement.

Article 3 Restrictions on Copying the Software

Licensee may make a single copy of the Software in whole or a part solely for back-up purpose.

Article 4 Computer

Licensee may use the Software only on one computer, and may not use it on more than one computer. Further, Licensee may not use the Software for commercial software hosting services.

Article 5 Reverse Engineering, Decompiling or Disassembly

Licensee may not reverse engineer, decompile, or disassemble the Software, except to the extent either of them is permitted under law or regulation of the country where Licensee resides. Panasonic, or its distributors will not be responsible for any defects in the Software or damage to Licensee caused by Licensee's reverse engineering, decompiling, or disassembly of the Software.

Article 6 Indemnification

The Software is provided "AS-IS" without warranty of any kind, either expressed or implied, including, but not limited to, warranties of non-infringement, merchantability and/or fitness for a particular purpose. Further, Panasonic does not warrant that the operation of the Software will be uninterrupted or error free. Panasonic or any of its distributors will not be liable for any damage suffered by Licensee arising from or in connection with Licensee's use of the Software.

Article 7 Export Control

Licensee agrees not to export or re-export to any country the Software in any form without the appropriate export licenses under regulations of the country where Licensee resides, if necessary.

Article 8 Termination of License

The right granted to Licensee hereunder will be automatically terminated if Licensee contravenes any of the terms and conditions of this Agreement. In this event, Licensee must destroy the Software and related documentation together with all the copies thereof at Licensee's own expense.

Article 9 With regard to MICROSOFT SQL SERVER COMPACT 3.5 produced by Microsoft Corporation

(1) Licensee shall use the MICROSOFT SQL SERVER COMPACT 3.5 only when included in the Software, and shall not use the MICROSOFT SQL SERVER COMPACT 3.5 in any other configuration or method. Licensee shall not publish the MICROSOFT SQL SERVER COMPACT 3.5 or work around any technical limitations in the MICROSOFT SQL SERVER COMPACT 3.5.

(2) Licensee shall not use, copy, distribute, regrant for use or otherwise handle the Software in any way beyond the range of use granted under Article 9 (1), and shall not conduct operations such as reverse engineering, decompilation, disassembling, etc. of the MICROSOFT SQL SERVER COMPACT 3.5.

(3) All rights, including copyright, patent rights etc. relating to the MICROSOFT SQL SERVER COMPACT 3.5 shall belong to Microsoft Corporation. Licensee shall not claim any rights related to the MICROSOFT SQL SERVER COMPACT 3.5 whatsoever.

Operating environment

- Even if the system requirements mentioned in this owner's manual are fulfilled, some PCs cannot be used.
- A CD-ROM drive is necessary to install the supplied software applications. (A compatible Blu-ray disc/DVD writer drive and media are necessary for writing to a Blu-ray disc/DVD.)
- Operation is not guaranteed in the following cases.
 - When 2 or more USB devices are connected to a PC, or when devices are connected through USB hubs or by using extension cables.
 - Operation on an upgraded OS.
 - Operation on an OS other than the one pre-installed.
- This software is not compatible with Microsoft Windows 3.1, Windows 95, Windows 98, Windows 98SE, Windows Me, Windows NT and Windows 2000.

■ Operating environment for HD Writer LE 1.1

PC	IBM PC/AT compatible PC
OS	Windows 7 (32 bit/64 bit) Starter/Home Basic/Home Premium/Professional/Ultimate (SP1) Windows Vista (32 bit) Home Basic/Home Premium/Business/Ultimate (SP2) Windows XP (32 bit) (SP3)
CPU	Intel Pentium 4 2.8 GHz or higher (including compatible CPU) <ul style="list-style-type: none"> ● Intel Core 2 Duo 2.16 GHz or higher or AMD Athlon 64 X2 Dual-Core 5200+ or higher is recommended when using playback function or MPEG2 output function. ● Intel Core 2 Quad 2.6 GHz or higher is recommended when using the editing function.
RAM	Windows 7: 1 GB or more (32 bit)/2 GB or more (64 bit) Windows Vista: 1 GB or more Windows XP: 512 MB or more (1 GB or more recommended)
Display	High Color (16 bit) or more (32 bit or more recommended) Desktop resolution of 1024×768 pixels or more (1920×1080 pixels or more recommended) Windows 7/Windows Vista: DirectX 9.0c compatible video card (DirectX 10 recommended) Windows XP: DirectX 9.0c compatible video card Compatible with DirectDraw overlay PCI Express™ ×16 compatible recommended Video memory of 256 MB or more recommended

Free hard disk drive space	Ultra DMA — 100 or more 450 MB or more (for installing the software) <ul style="list-style-type: none"> When writing to a DVD/Blu-ray disc/SD, the twice amount of free space as the disc is necessary.
Sound	DirectSound Support
Interface	USB port [Hi-Speed USB (USB 2.0)]
Other requirements	Mouse or equivalent pointing device Internet connection

- Supplied CD-ROM is available for Windows only.
- Input is not supported in languages other than English, German, French, Simplified Chinese and Russian.
- Operation cannot be guaranteed on all Blu-ray disc/DVD drives.
- Operation is not guaranteed on Microsoft Windows Vista Enterprise, Windows XP Media Center Edition, Tablet PC Edition and Windows 7 Enterprise.
- This software is not compatible with a multi-boot environment.
- This software is not compatible with a multi-monitor environment.
- If using Windows XP, only an administrative account user can use this software. If using Windows Vista/Windows 7, only administrative and standard account users can use this software. (An administrative account user should install and uninstall this software.)

■ To use the HD Writer LE 1.1

You will need a high performance PC depending on the functions to be used. It may not properly play back or properly operate depending on the environment of the PC used. Refer to the operating environment and notes.

-
- Operation during the playback may become slow if the CPU or memory is not fulfilling the requirements of the operating environment.
 - Always use the most current driver for the video card.
 - Always make sure there is enough capacity on the HDD in the PC. It may become inoperable or the operation may stop suddenly if the capacity gets low.

■ Operating environment for the card reader function (mass storage)

PC	IBM PC/AT compatible PC
OS	Windows 7 (32 bit/64 bit) or SP1 Windows Vista (32 bit) (SP2) Windows XP (32 bit) (SP3)
CPU	Windows 7/Windows Vista: 1 GHz or higher 32-bit (×86) or 64-bit (×64) processor (including compatible CPU) Windows XP: Intel Pentium III 450 MHz or higher or Intel Celeron 400 MHz or higher
RAM	Windows 7: 1 GB or more (32 bit)/2 GB or more (64 bit) Windows Vista Home Basic: 512 MB or more Windows Vista Home Premium/Business/Ultimate/Enterprise: 1 GB or more Windows XP: 512 MB or more (1 GB or more recommended)
Interface	USB port
Other requirements	Mouse or equivalent pointing device

- The USB equipment operates with the driver installed as standard in the OS.

Installation

When installing the software, log on to your computer as the Administrator or with a username with equivalent authorization. (If you do not have authorization to do this, consult your manager.)

- Before starting the installation, close all applications that are running.
- Do not perform any other operations on your PC while the software is being installed.
- Explanation of operations is based on Windows 7.

1 Insert the CD-ROM into the PC.

- The [AutoPlay] screen is displayed automatically. Click [Run setup.exe] → [Yes].
- If Windows 7 is in use or the [AutoPlay] screen is not displayed automatically, select [Start] → [Computer] (or double-click on [Computer] on the desktop), and then double-click [Panasonic].

2 Click [Yes].

- Operate following the instruction on the screen.
- If the country or region cannot be selected, select [NTSC Area].

The PC must be rebooted for the application to work.

■ Uninstalling HD Writer LE 1.1

Follow the steps below to uninstall any software applications that you no longer require.

1 Select [Start] → [Control Panel] → [Uninstall a program].

2 Select [HD Writer LE 1.1], then click [Uninstall].

- Proceed with the uninstallation by following the on-screen instructions.
- After uninstalling the software, be sure to reboot the PC.

Connecting to a PC

- Connect this unit to the PC after the software applications are installed.
- Remove the supplied CD-ROM from your PC.

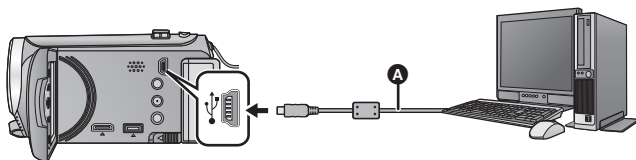

A USB cable (supplied)

- Insert the plugs as far as they will go.

1 Connect this unit to the AC adaptor.

- Use the AC adaptor to free you from worrying about the battery running down.

2 Turn on the unit.

- This function is available in all modes.

3 Connect this unit to a PC.

- The USB function selection screen will appear.

4 Select [PC] using the cursor button on the unit and press the ENTER button.

- The Smart wizard screen is automatically displayed when HD Writer LE 1.1 is installed.
- This unit is automatically recognized as an external drive of the PC. (→ 96)
- When you select an option other than [PC], reconnect the USB cable.
- When using the battery, the LCD monitor turns off after about 5 seconds. Press the cursor button to turn the LCD monitor on.



-
- Do not use any other USB cables except the supplied one. (Operation is not guaranteed with any other USB cables.)
 - When this unit is connected to a PC using a USB cable while the unit is turned on, power is also supplied from the PC to this unit.
 - **When the unit is connected to a PC, it cannot be turned off. Disconnect the USB cable, before turning this unit off.**
 - When performing reading/writing between a PC and an SD card, be aware that some SD card slots built into PCs and some SD card readers are not compatible with the SDHC Memory Card or SDXC Memory Card.
 - When using an SDXC Memory Card, check the following support site.
<http://panasonic.net/avc/sdcard/information/SDXC.html>

■ To disconnect USB cable safely

Select the  icon in task tray displayed on the PC, and then click [Eject Panasonic Camcorder].

- Depending on your PC's settings, this icon may not be displayed.

About the screen indication of the unit

- Do not disconnect the USB cable, the battery, or the AC adaptor while the access lamp is on or card access icon () appears on the unit screen.
- **HC-V100M**
Do not disconnect the USB cable, the battery or the AC adaptor while the access lamp is on or built-in memory access icon () appears on the unit screen.
- If the screen does not change when the unit is operated while connected to a PC, disconnect the battery and/or AC adaptor, wait approximately 1 minute, reconnect the battery and/or AC adaptor, wait approximately 1 minute again, and then turn the unit back on. (Data may be destroyed when above operation is performed while accessing the SD card or built-in memory.)

■ Charging the battery by connecting it to different devices

When using the battery, if you turn off the unit and connect it to a PC, Panasonic Blu-ray disc recorder or Panasonic DVD recorder, the battery will charge.

- **When connecting this unit to a PC for the first time, make sure to connect this unit to the PC with this unit turned on.**
- Insert the USB cable securely all the way. It will not operate properly if it is not inserted all the way.
- Do not use any other USB cables except the supplied one. (Operation is not guaranteed with any other USB cables.)
- Be sure to connect the unit directly to the PC, Blu-ray disc recorder or DVD recorder.
- During charging, the status indicator flashes.
- You cannot charge when the status indicator flashes rapidly, or when it does not light at all. Charge using the AC adaptor. (→ 21)
- It will take 2 or 3 times longer to charge compared to when using the AC adaptor.
- If the status indicator flashes at a particularly fast or slow rate, refer to page 111.

About the PC display

When the unit is connected to a PC, it is recognized as an external drive.

- Removable disk (Example:  CAM_SD (F:)) is displayed in [Computer].

We recommend using HD Writer LE 1.1 to copy motion picture data.

Using Windows Explorer or other programs on the PC to copy, move or rename files and folders recorded with this unit will result in them being unusable with HD Writer LE 1.1.

It is impossible to write data to the built-in memory or SD card on the unit from a PC.

Example folder structure of an SD card:

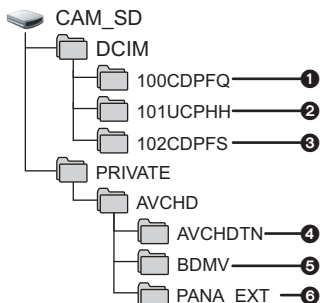

HC-V100M

Example folder structure of built-in memory:

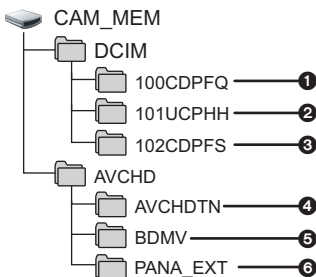

The following data will be recorded.

- ❶ Up to 999 still pictures in JPEG format ([S1000001.JPG] etc.)
- ❷ iFrame format motion picture files ([S1000001.MP4] etc.)
- ❸ JPEG format still pictures created from the motion picture
- ❹ The motion picture thumbnails
- ❺ AVCHD format motion picture files ([00000.MTS] etc.)
- ❻ For management

■ Copying your still pictures to your PC

Card reader function (mass storage)

Still pictures recorded with this unit can be copied to the PC with Explorer or other programs.

- 1 Double-click the folder that contains the still pictures. ([DCIM] → [100CDPFQ] etc.)
- 2 Drag and drop the still pictures onto the destination folder (on the PC's HDD).

- Do not delete the SD card's folders. Doing so may make the SD card unusable in this unit.
- When data not supported by this unit has been recorded on a PC, it will not be recognized by this unit.
- Always use this unit to format SD cards.

Starting HD Writer LE 1.1

- To use the software, log on as an Administrator or as user name for standard user account (only for Windows 7/Windows Vista).
The software cannot be used with the user name for a guest account.

(On the PC)

Select [Start] → [All Programs] → [Panasonic] → [HD Writer LE 1.1] → [HD Writer LE].

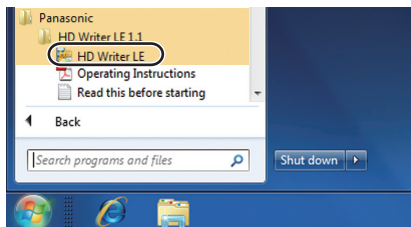

- For details on how to use the software applications, read the PDF operating instructions of the software.

Reading the operating instructions of the software applications

- You will need Adobe Acrobat Reader 5.0 or later or Adobe Reader 7.0 or later to read the PDF operating instructions.

Select [Start] → [All Programs] → [Panasonic] → [HD Writer LE 1.1] → [Operating Instructions].

If using Mac

- HD Writer LE 1.1 is not available for Mac.
- iMovie'11 supported. For details about iMovie'11, please contact Apple Inc.

■ Operating environment

PC	Mac
OS	Mac OS X 10.7.2
CPU	Intel Core 2 Duo or better
RAM	2 GB or more
Interface	USB port
Other requirements	Mouse or equivalent pointing device

- Even if the system requirements mentioned in this owner's manual are fulfilled, some PCs cannot be used.
- The USB equipment operates with the driver installed as standard in the OS.
- Supplied CD-ROM is available for Windows only.

■ Copying still pictures on PC

1 Connect this unit to a PC via the supplied USB cable.

- The USB function selection screen will appear.

2 Select [PC] using the cursor button on the unit and press the ENTER button.

- This unit is automatically recognized as an external drive of Mac.
- When you select an option other than [PC], reconnect the USB cable.
- When using the battery, the LCD monitor turns off after about 5 seconds. Press the cursor button to turn the LCD monitor on.

3 Double-click [CAM_SD] displayed on the desktop.

- For users who have [HC-V100M], [CAM_SD] and [CAM_MEM] are displayed on the desktop.
- Files are stored in [100CDPFQ] folder etc. in the [DCIM] folder.

4 Using a drag-and-drop operation, move the pictures you want to acquire or the folder storing those pictures to any different folder on the PC.

■ To disconnect USB cable safely

Drag [CAM_SD] disk icon to the [Trash], and then disconnect the USB cable.

- For users who have [HC-V100M], [CAM_SD] and [CAM_MEM] are displayed on the desktop.

-
- Do not use any other USB cables except the supplied one. (Operation is not guaranteed with any other USB cables.)

Indications

* **HC-V100M** only

■ Recording indications

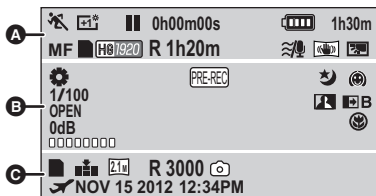

A



Intelligent Auto Mode (→ 34)

MNL Manual Mode (→ 59)

Scene Mode (→ 53)

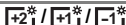

Power LCD (→ 43)

(Red) Recording

(Green) Recording pause

0h00m00s Elapsed recording time (→ 31)

(“h” is an abbreviation for hour, “m” for minute and “s” for second.)

Image Stabilizer (→ 48)

Remaining battery power (→ 23)

1h30m Remaining battery time (→ 23)

MF Manual Focus (→ 62)

Built-in memory recording possible status (motion picture)*

(White) Card recording possible status (motion picture)

(Green) Recognizing the card (motion picture)

H61920 / H61920 / HX1920 / i Frame

Recording Mode (→ 54)

R 1h20m Remaining time for motion picture recording (→ 31)

Wind cut (→ 56)

Backlight Compensation (→ 50)

B

AWB / / / / / White Balance (→ 59)

PRE-REC PRE-REC (→ 51)

1/100 Shutter Speed (→ 61)

OPEN/F2.0 Iris value (→ 61)

0dB Gain value (→ 61)

Microphone Level (→ 57)









Soft Skin Mode (→ 51)

Tele Macro (→ 51)

W / **B** Fade (White), Fade (Black) (→ 50)

Color Night Rec function (→ 52)

Intelligent Contrast Control (→ 52)

	Built-in memory recording possible status (still picture)*
 (White)	Card recording possible status (still picture)
 (Green)	Recognizing the card (still picture)
	Picture Quality (→ 58)
	Number of recording pixels for still pictures (→ 33, 64)
In Playback Mode, the picture size is not displayed for still pictures recorded with other products that have different picture sizes from the sizes shown above.	
R3000	Remaining number of still pictures (→ 33)
 (White)	Still picture recording icon
 (Red)	Recording still picture
	World time setting (→ 40)
NOV 15 2012	Date indication (→ 28)
12:34PM	Time indication (→ 28)

■ Playback indications



Display during playback (→ 36, 63)

0h00m00s Playback Time (→ 36)

No.10 Scene Number

 Repeat Playback (→ 64)

 Resume Playback (→ 65)

100-0001 Still picture folder/file name

 Protected motion pictures/still pictures (→ 73)

 AVCHD recorded scene (→ 36)

 iFrame recorded scene (→ 36)

■ Indication of connection to other devices

 Accessing the card (→ 84, 95)

 Accessing the built-in memory (→ 84, 95)*

■ Confirmatory indications

-- **(Time display)** The built-in battery is low. (→ 28)

 Warning for recording yourself (→ 29)

 SD card is not inserted or is incompatible.

Messages

Major confirmation/error messages to be indicated on the screen in text.

* **HC-V100M** only

PERIODICALLY MAKE BACK UP OF DATA IN BUILT-IN MEMORY.*

We recommend backing up important recorded motion pictures and still pictures periodically to a PC, disc, etc. to protect it. (→ 86) This message does not indicate that there is a problem with this unit.

CHECK CARD.

This card is not compatible or it cannot be recognized by the unit.

If this message appears even though motion pictures and still pictures are recorded on an SD card, the card may be unstable. Reinsert the SD card, then turn the unit off and then on again.

THIS BATTERY CANNOT BE USED.

- Use a battery that is compatible with this unit. (→ 20)
If using a Panasonic battery compatible with this unit, remove the battery and then insert it again. If the message appears even after repeating this several times, this unit needs repair. Detach the power and contact consumer support. (→ 123, 124, 125) Do not attempt to repair it by yourself.
- You are attempting to connect an AC adaptor not compatible with this unit. Use the supplied AC adaptor. (→ 21)

About recovery

If faulty management information is found, the messages may appear and a repair is performed. (Repairing may take time depending on the error.)

-  is displayed when abnormal management information is detected when the scenes are displayed in thumbnail.
- If the unit is turned off during video recording, scenes of less than 30 seconds are not recorded.

-
- Use a sufficiently charged battery or the AC adaptor.
 - Depending on the condition of the data, it may not be possible to completely repair the data.
 - If recovery fails, it will not be possible to play back scenes recorded before the unit turned off.
 - When data recorded on another device is recovered, it may not be possible to play back the data on this unit or the other device.
 - If recovery fails, turn the unit off and on again after waiting a while. If recovery fails repeatedly, format a media on the unit. Please be aware that if a media is formatted, then all the data recorded on the media will be erased.
 - If the thumbnail information is recovered, displaying the thumbnails may become slower.

Troubleshooting

■ It is not a malfunction in the following cases

A clicking sound is heard when the unit is shaken.	<ul style="list-style-type: none"> ● This is the sound of the lens moving and is not a defect. This sound will no longer be heard when the unit is turned on and change the mode to .
Object seems to be warped.	<ul style="list-style-type: none"> ● Object seems to be warped slightly when the object moves across the image very fast, but this is because the unit is using MOS for the image sensor. This is not a malfunction.



Power

Problem	Check points
<p>This unit cannot be turned on.</p> <p>This unit does not stay on long enough.</p> <p>Battery runs down quickly.</p>	<ul style="list-style-type: none"> ● Charge the battery again to ensure it is sufficiently charged. (→ 21) ● In cold places, the battery using time becomes shorter. ● The battery has a limited life. If the operating time is still too short even after the battery is fully charged, the battery has worn out and needs to be replaced.
<p>This unit is turned off automatically.</p>	<ul style="list-style-type: none"> ● If the unit turns off when you turn off the power to the TV using the TV remote control, the VIERA Link is at work. If you are not using the VIERA Link, set [VIERA Link] to [OFF]. (→ 78)
<p>This unit cannot be operated even though it is turned on.</p> <p>This unit does not operate normally.</p>	<ul style="list-style-type: none"> ● Remove the battery or AC adaptor, wait about 1 minute and then reconnect the battery or AC adaptor. Then about 1 minute later, turn on the unit again. (Conducting the above operation while the media is being accessed may damage the data on the media.) ● If normal operation is still not restored, detach the power connected, and contact consumer support. (→ 123, 124, 125)
<p>“ERROR OCCURRED. PLEASE TURN UNIT OFF, THEN TURN ON AGAIN.” is displayed.</p>	<ul style="list-style-type: none"> ● The unit has automatically detected an error. Restart the unit by turning the unit off and on. ● The unit will be turned off in about 1 minute if the unit is not turned off and on. ● Repair is needed if it is repeatedly displayed even if it is restarted. Detach the power connected, contact consumer support. (→ 123, 124, 125) Do not attempt to repair the unit by yourself.



Indication

Problem	Check points
Remaining battery indication is not displayed properly.	<ul style="list-style-type: none"> The remaining battery capacity indication is an approximation. If the remaining battery capacity indication is not displayed correctly, fully charge the battery, discharge it and then charge it again.
The remaining time indication or the elapsed time indication is not shown.	<ul style="list-style-type: none"> [DISPLAY] of the [SETUP] is [OFF]. (→ 40)

Recording

Problem	Check points
The unit arbitrarily stops recording.	<ul style="list-style-type: none"> Use an SD card that can be used for motion picture recording. (→ 24) The recordable time may have shortened due to the deterioration of the data writing speed or repeated recording and deletion. Using the unit, format the SD card or built-in memory. (→ 44) If [AGS] is [ON], record in the normal horizontal position or set [AGS] to [OFF]. (→ 55)
Auto Focus function does not work.	<ul style="list-style-type: none"> Switch to Intelligent Auto Mode. If you are trying to record a scene that is hard to bring into focus in Auto Focus Mode, use the Manual Focus Mode to adjust the focus. (→ 35, 62)
“ENVIRONMENT TOO DARK, OR LENS COVER CLOSED.” is displayed.	<ul style="list-style-type: none"> Before turning on the unit, open the lens cover. This message may also be displayed when recording in a very dark location.
Color balance of images is strange when recording in a place such as a gymnasium.	<ul style="list-style-type: none"> In a place with multiple light sources, such as a gymnasium or a hall, set the White Balance setting to  (Indoor mode 2). If you cannot record clearly with the  (Indoor mode 2), set it to  (Manual adjustment mode). (→ 59)
Color or brightness of the image changes, or you may see horizontal bars in the image. The LCD monitor flickers indoors.	<ul style="list-style-type: none"> Color or brightness of the image may change, or you may see horizontal bars in the image when the object is recorded under fluorescent light, mercury light or sodium light, etc., but this is not a malfunction. Record in Intelligent Auto Mode or set the shutter speed to 1/60 in areas where the power supply frequency is 60 Hz, or 1/100 in areas of 50 Hz.

Playback

Problem	Check points
Scenes/still pictures cannot be played back.	<ul style="list-style-type: none"> ● Any scenes/still pictures where the thumbnails are displayed as  cannot be played back. ● Motion pictures recorded with other devices may not be possible to play back on this unit. ( is displayed.)
Scenes cannot be deleted.	<ul style="list-style-type: none"> ● Release the protect setting. (→ 73) ● Any scenes/still pictures where the thumbnails are displayed as  cannot be deleted. If the scenes/still pictures are unnecessary, format the media to erase the data. (→ 44) Please be aware that if a media is formatted then all the data recorded on the media is erased and cannot be recovered. Back up important data on a PC, disc etc.

With other products

Problem	Check points
<p>Video or audio is not output even though it is connected to TV correctly.</p> <p>The images are squeezed horizontally.</p>	<ul style="list-style-type: none"> ● Please read the operating instructions of your TV and select the channel that matches the input used for the connection. ● Change the [TV ASPECT] setting to match the aspect ratio of the TV. (→ 76) ● Change the setting of the unit depending on the cable connecting to the TV. (→ 77) ● No audio will be played on the TV during recording mode. ● When connected to a television, the unit does not output sound in playback mode. Also, the volume cannot be adjusted on the unit, so please make volume adjustments on your television.
If the SD card is inserted in another device, it is not recognized.	<ul style="list-style-type: none"> ● Check that the device is compatible with the capacity or type of SD card (SD Memory Card/SDHC Memory Card/SDXC Memory Card) that you inserted. Refer to the operating instructions of the device for details.
When connected by the USB cable, this unit is not detected by the other devices.	<ul style="list-style-type: none"> ● When connected to other devices using only the battery, reconnect using the AC adaptor.

With other products

Problem	Check points
VIERA Link does not work.	<p>(Setting on this unit)</p> <ul style="list-style-type: none"> ● Connect with a HDMI mini cable (optional). (→ 78) ● Set [VIERA Link] to [ON]. (→ 78) ● Turn the unit off and then back on again. <p>(Setting on other devices)</p> <ul style="list-style-type: none"> ● If the TV input does not switch automatically, switch the input using the TV remote control. ● Check the VIERA Link setting on the connected device. ● Please refer to the operating instructions of the connected device.
Cannot copy scenes on the SD card by connecting to other equipment with the USB cable.	<ul style="list-style-type: none"> ● Other equipment might have not recognized the SD card. Unplug the USB cable once, and reconnect it.

With a PC

Problem	Check points
When connected by the USB cable, this unit is not detected by the PC.	<ul style="list-style-type: none"> ● After re-inserting the SD card into the unit, reconnect the supplied USB cable. ● Select another USB terminal on the PC. ● Check the operating environment. (→ 90, 98) ● Connect the supplied USB cable again after restarting the PC and turning on this unit again.
When the USB cable is disconnected, an error message will appear on the PC.	<ul style="list-style-type: none"> ● To disconnect the USB cable safely, double-click the icon in the task tray and follow the instructions on the screen. 
Cannot see the PDF operating instructions for HD Writer LE 1.1.	<ul style="list-style-type: none"> ● You will need Adobe Acrobat Reader 5.0 or later or Adobe Reader 7.0 or later to read the PDF operating instructions for HD Writer LE 1.1.

Others

Problem	Check points
If the SD card is inserted in this unit, it is not recognized.	<ul style="list-style-type: none"> ● If the SD card is formatted on a PC, it may not be recognized by this unit. Use this unit to format SD cards. (→ 44)

■ If AVCHD scenes do not change smoothly

The images may be still for several seconds at the joins between the scenes if the following operations are performed when multiple scenes have been continuously played back using another unit.

- Just how smoothly the scenes will be played back depends on the playback unit.
Depending on the unit used, the images may stop moving and become still for a moment even when none of the following conditions are applicable.
- A continuous recording of motion picture data that exceeds 4 GB may momentarily stop at every 4 GB of data when played back with another device.
- It may not play back smoothly when the editing of scenes was done with the HD Writer LE 1.1, but it will play back smoothly if you set the seamless settings in the HD Writer LE 1.1. Refer to the operating instructions for the HD Writer LE 1.1.

Principal reasons for not playing back smoothly
● When the scenes were recorded on different dates
● When scenes lasting under 3 seconds have been recorded
● When PRE-REC was used for recording
● When deleting scenes
● When selected scenes are copied from the built-in memory to an SD card
● When scenes recorded more than 99 scenes on the same date

Cautions for use

About this unit

The unit and the SD card become warm during use. This is not a malfunction.

Keep this unit as far away as possible from electromagnetic equipment (such as microwave ovens, TVs, video games etc.).

- If you use this unit on top of or near a TV, the pictures and/or sound on this unit may be disrupted by electromagnetic wave radiation.
- Do not use this unit near cell phones because doing so may result in noise adversely affecting the pictures and/or sound.
- Recorded data may be damaged, or pictures may be distorted, by strong magnetic fields created by speakers or large motors.
- Electromagnetic wave radiation generated by microprocessors may adversely affect this unit, disturbing the pictures and/or sound.
- If this unit is adversely affected by electromagnetic equipment and stops functioning properly, turn this unit off and remove the battery or disconnect AC adaptor. Then reinsert the battery or reconnect AC adaptor and turn this unit on.

Do not use this unit near radio transmitters or high-voltage lines.

- If you record near radio transmitters or high-voltage lines, the recorded pictures and/or sound may be adversely affected.

Make sure to use the supplied cords and cables. If you use optional accessories, use the cords and the cables supplied with them.

Do not extend the cords and the cables.

Do not spray insecticides or volatile chemicals onto the unit.

- If the unit is sprayed with such chemicals, its body may be marred and the surface finish may peel off.
- Do not leave rubber or plastic products in contact with the unit for a long time.

When you use the unit in a sandy or dusty place such as a beach, do not let sand or fine dust get into the body and terminals of the unit.

Also, keep the unit away from sea water.

- Sand or dust may damage the unit. (Care should be taken when inserting and removing a card.)
- If sea water splashes onto the unit, wipe off the water with a well wrung cloth. Then wipe the unit again with a dry cloth.

When carrying the unit, do not drop or bump it.

- A strong impact can break the unit's casing, causing it to malfunction.

Cleaning

- Before cleaning, detach the battery or pull the AC cable from the AC outlet, and then wipe the unit with a soft, dry cloth.
- If the unit is very dirty, dip a cloth in water and squeeze firmly, and then wipe the unit with the damp cloth. Next, dry the unit with a dry cloth.
- Use of benzine, paint thinner, alcohol, or dishwashing liquid may alter the camera body or peel the surface finish. Do not use these solvents.
- When using a chemical dust cloth, follow the instructions that came with the cloth.

Do not use the unit for surveillance purposes or other business uses.

- This unit was designed for consumer intermittent use. It was not intended for continuous use, or for any industrial or commercial application resulting in prolonged use.
- In certain situations, continuous use could cause the unit to overheat and cause a malfunction. Such use is strongly discouraged.

When you are not going to use the unit for an extended time

- When storing the unit in a cupboard or cabinet, it is recommended that you place a desiccant (silica gel) in with it.

HC-V100M

When disposing of or giving away this unit, note that:

- Formatting and deletion simply change the file management information and cannot be used to completely erase the data in built-in memory of this unit. The data can be recovered using commercially available software or the like.
- We recommend that you physically format the built-in memory before disposing of or giving away this unit.

For the physical format, connect the unit to the AC adaptor, set the mode switch to , select [SETUP] → [FORMAT MEDIA] → [Built-inMemory] from the menus, and then press and hold down the Optical image stabilizer/Delete button for approximately 3 seconds on the screen below. When the built-in memory data deletion screen appears, select [YES], and then follow the on-screen instructions.

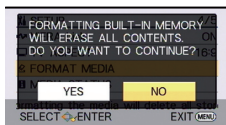

- Please look after the data in your built-in memory carefully. Panasonic will not be held responsible in the unlikely case that private data is divulged.

About the battery

The battery used in this unit is a rechargeable lithium-ion battery. It is susceptible to humidity and temperature and the effect increases the more the temperature rises or falls. In cold areas, the full charge indication may not appear or the low battery indication may appear about 5 minutes after starting use. At high temperatures, the protection function may be triggered, making it impossible to use the unit.

Be sure to detach the battery after use.

- If the battery is left attached, a minute amount of current continues to flow even if the unit is off. Keeping the unit in this state may result in over discharge of the battery. This may result in you not being able to use the battery even after it is charged.
- The battery should be stored in the vinyl bag so metal does not come into contact with the terminals.
- The battery should be stored in a cool place free from humidity, with as constant temperature as possible. (Recommended temperature: 15 °C to 25 °C (59 °F to 77 °F), Recommended humidity: 40%RH to 60%RH)

- Extremely high temperatures or low temperatures will shorten the life of the battery.
- If the battery is kept in high-temperature, high-humidity, or oily-smoky places, the terminals may rust and cause malfunctions.
- To store the battery for a long period of time, we recommend that you charge it once every year and store it again after you have completely used up the charged capacity.
- Dust and other matter attached to the battery terminals should be removed.

Prepare spare batteries when going out for recording.

- Prepare batteries enough to last for 3 to 4 times the period you are planning to record for. Cold places such as a ski resort can shorten recording time.

If you drop the battery accidentally, check to see if the terminals are damaged.

- Inserting a battery with damaged terminals can damage the unit.

Do not throw old battery into fire.

- Heating a battery or throwing it into a fire may result in an explosion.

If the operating time is very short even after the battery has been recharged, the battery has worn out. Please purchase a new battery.

About the AC adaptor

- If the temperature of the battery is extremely high or extremely low, charging may take time or the battery may not be charged.
- If you use the AC adaptor near a radio, radio reception may be disturbed. Keep the AC adaptor 1 m (3.3 feet) or more away from the radio.
- When using the AC adaptor, it may generate whirring sounds. However, this is normal.
- After use, be sure to disconnect the AC adaptor. (If it is left connected, a minute amount of current is consumed.)
- Always keep the electrodes of the AC adaptor and battery clean.

About status indicator during charging

When the status indicator is flashing at a particularly fast or slow rate, the following should be considered.

Flashing with approx. 4 second period (off for approx. 2 seconds, on for approx. 2 seconds):

- When the battery is over discharged or the temperature of the battery is too high or low. It can be charged, but it may take a few hours to complete the charging normally.
- It will flash in approx. 2 second intervals when normal charging resumes. Even in such cases, it may start flashing in approx. 4 second intervals until charging is completed depending on the conditions of use.

Flashing with approx. 0.5 second period (off for approx. 0.25 second, on for approx. 0.25 second):

- The battery is not charged. Remove the battery from the unit, and try charging again.
- Check that the terminals of the unit or battery are not dirty or covered with a foreign object, and connect the battery correctly once again. If a foreign object or dirt is present, turn off the unit before removing.
- The battery or environment is at an extremely high or low temperature. Wait until the temperature has returned to an appropriate level and try charging again. If you are still unable to charge, there may be a fault in the unit, battery or AC adaptor.

Off:

- Charging has finished.
- If the status indicator stays off despite the charging being unfinished, there may be a fault in the unit, battery or AC adaptor. Refer to page 109 for details on the battery.

About the SD card

When disposing of or giving away the SD card, note that:

- Formatting and deletion of this unit or computer only changes the file management information and does not completely delete the data in the SD card.
- It is recommended that the SD card is physically destroyed or the SD card is physically formatted using this unit when disposing of or giving away the SD card.

HC-V100

For the physical format, connect the unit to the AC adaptor, set the mode switch to , select [SETUP] → [FORMAT CARD] → [YES] from the menus, and then press and hold down the Optical image stabilizer/Delete button for approximately 3 seconds on the screen below. When the SD card data deletion screen appears, select [YES], and then follow the on-screen instructions.

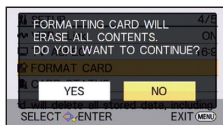

HC-V100M

For the physical format, connect the unit to the AC adaptor, set the mode switch to , select [SETUP] → [FORMAT MEDIA] → [SD CARD] from the menus, and then press and hold down the Optical image stabilizer/Delete button for approximately 3 seconds on the screen below. When the SD card data deletion screen appears, select [YES], and then follow the on-screen instructions.

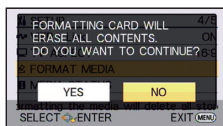

- The customer is responsible for the management of the data in the SD card.

LCD monitor

- When the LCD monitor gets dirty, wipe it with a soft cloth, such as eyeglass cleaner.
- In a place with drastic temperature changes, condensation may form on the LCD monitor. Wipe it with a soft cloth, such as eyeglass cleaner.
- When the unit has become very cold, for example due to storage in a cold area, its LCD monitor will be slightly darker than usual immediately after the unit is turned on. The normal brightness will be restored when the unit's internal temperature rises.

Extremely high precision technology is employed to produce the LCD Monitor screen featuring a total of approximately 230,000 dots. The result is more than 99.99% effective dots with a mere 0.01% of the dots inactive or always lit. However, this is not a malfunction and does not affect the recorded picture.

About condensation

When condensation forms on the unit, the lens will cloud up and the unit may not work properly. Make every effort to ensure that condensation does not form. If it does form, take the actions described below.

Causes of condensation

Condensation takes place when the ambient temperature or humidity is changed as follows.

- When this unit is brought inside from the cold (e.g. a ski slope) to a warm room.
- When this unit is moved from an air-conditioned car to outside.
- When a cold room has been warmed up quickly.
- When cool wind from an air conditioner is directly blown onto this unit.
- After rain showers.
- When this unit is in a very humid place where the air is thick with steam. (e.g. a heated swimming pool)

Helpful hint

If, for example, you have used this unit for recording on a ski slope and are taking it into a heated room, place the unit inside a plastic bag, remove as much of the air from inside the bag as possible, then seal the bag. Leave the unit for about an hour in the room so the temperature of the unit is close to the ambient temperature of the room, then use it.

About copyright

■ Carefully observe copyright laws

Whatever you have recorded and created can be used for your personal entertainment only. Under copyright laws, other materials cannot be used without obtaining permission from the holders of the copyrights.

■ Licenses

- SDXC Logo is a trademark of SD-3C, LLC.
- “AVCHD” and the “AVCHD” Logo are trademarks of Panasonic Corporation and Sony Corporation.
- Manufactured under license from Dolby Laboratories.
Dolby and the double-D symbol are trademarks of Dolby Laboratories.
- HDMI, the HDMI Logo, and High-Definition Multimedia Interface are trademarks or registered trademarks of HDMI Licensing LLC in the United States and other countries.
- VIERA Link™ is a trademark of Panasonic Corporation.
- EZ Sync™ is a trademark of Panasonic Corporation.
- HDAVI Control™ is a trademark of Panasonic Corporation.
- Microsoft®, Windows® and Windows Vista® are either registered trademarks or trademarks of Microsoft Corporation in the United States and/or other countries.
- Microsoft product screen shot(s) reprinted with permission from Microsoft Corporation.
- IBM and PC/AT are registered trademarks of International Business Machines Corporation of the U.S.
- Intel®, Pentium®, Celeron® and Intel®Core™ are trademarks of Intel Corporation in the U.S. and/or other countries.
- AMD Athlon™ is a trademark of Advanced Micro Devices, Inc.
- iMovie, Mac and Mac OS are trademarks of Apple Inc. registered in the U.S. and other countries.
- Other names of systems and products mentioned in these instructions are usually the registered trademarks or trademarks of the manufacturers who developed the system or product concerned.

This product is licensed under the AVC patent portfolio license for the personal and non-commercial use of a consumer to (i) encode video in compliance with the AVC Standard (“AVC Video”) and/or (ii) decode AVC Video that was encoded by a consumer engaged in a personal and non-commercial activity and/or was obtained from a video provider licensed to provide AVC Video. No license is granted or shall be implied for any other use. Additional information may be obtained from MPEG LA, LLC. See <http://www.mpegla.com>.

Recording modes/approximate recordable time

- SD cards are only mentioned with their main memory size. The stated times are the approximate recordable times for continuous recording.

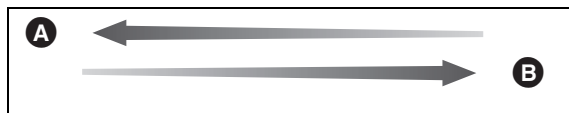

Recording mode		[HA]	[HG]	[HX]
Picture size/frame rate		1920×1080/60i	1920×1080/60i	1920×1080/60i
SD card	4 GB	30 min	40 min	1 h
	16 GB	2 h	2 h 40 min	4 h 10 min
	64 GB	8 h 30 min	11 h	16 h 50 min
HC-V100M Built-in memory	16 GB	2 h	2 h 40 min	4 h 10 min

- A** Favors image quality
- B** Favors recording time

Recording mode		[iFrame]
Picture size/frame rate		960×540/30p
SD card	4 GB	19 min
	16 GB	1 h 20 min
	64 GB	5 h 20 min
HC-V100M Built-in memory	16 GB	1 h 20 min



- If recording for long periods, prepare batteries for 3 or 4 times the period you wish to record for. (→ 23)
- The default setting is [HG] mode.
- Maximum continuously recordable time for one scene: 6 hours
- The recording is paused once when the recording time for one scene exceeds 6 hours, and the recording will automatically resume after a few seconds.
- The recordable time may be reduced if recording with a lot of action is recorded or recording of short scene is repeated.
- Use time in the row of 4 GB in above table as a guideline for the time that can be copied onto one DVD disc (4.7 GB).

Approximate number of recordable pictures

- SD cards are only mentioned with their main memory size. The stated number is the approximate number of recordable pictures.

(When [QUALITY] is set to )

Picture size		 1920×1080
Aspect ratio		16:9
SD card	4 GB	3400
	16 GB	14000
	64 GB	57000
HC-V100M Built-in memory	16 GB	14000

- When [QUALITY] is set to , the numbers of recordable pictures are larger than the numbers shown in the table above.
- **The number of recordable pictures depends on whether  and  are used together and on the subject being recorded.**
- Maximum number of recordable pictures that can be displayed is 99999.
If the number of recordable pictures exceeds 99999, the number will not change when the picture is taken until the number of recordable pictures is less than 99999.
- The memory capacity indicated on the label of an SD card is the total of the capacity for copyright protection and management and the capacity which can be used on the unit, a PC etc.

Specifications

High Definition Video Camera

Information for your safety

Power source:	DC 5.0 V (When using AC adaptor) DC 3.6 V (When using battery)
Power consumption:	Recording; 3.4 W Charging; 7.7 W

Motion picture recording format:

[AVCHD]; AVCHD format compliant
[iFrame]; MPEG-4 AVC file format compliant (.MP4)

Motion picture compression:

MPEG-4 AVC/H.264

Audio compression:

[AVCHD]; Dolby Digital/2 ch
[iFrame]; AAC/2 ch

Recording mode and transfer rate:

[HA]; Average 17 Mbps (VBR)
[HG]; Average 13 Mbps (VBR)
[HX]; Average 9 Mbps (VBR)
[iFrame]; Maximum 28 Mbps (VBR)

For picture size and recordable time of a motion picture, refer to page 114.

Still picture recording format:

JPEG (Design rule for Camera File system, based on Exif 2.2 standard)
Refer to page 115 for the number of recordable pictures.

Recording media:

SD Memory Card (FAT12 and FAT16 system compliant)
SDHC Memory Card (FAT32 system compliant)
SDXC Memory Card (exFAT system compliant)
Refer to page 24 for details on SD cards usable in this unit.

HC-V100M

Built-in memory; 16 GB

Image sensor:

1/5.8" 1MOS image sensor
Total; 1500 K
Effective pixels;

Motion picture/Still picture; 1300 K to 1120 K (16:9)

Lens:

Auto Iris, 34× Optical Zoom, F1.8 to F4.0

Focal length;

2.38 mm to 81 mm

Macro (Full range AF)

35 mm equivalent;

Motion picture/Still picture; 32.5 mm to 1206 mm (16:9)

Minimum focus distance;

Normal; Approx. 3 cm (1.2") (Wide)/Approx. 1.6 m (5.2 feet) (Tele)

Tele macro; Approx. 70 cm (28") (Tele)

Zoom:

i.Zoom OFF 37×, 42× i.Zoom, 90×/2000× Digital Zoom

Image stabilizer function:

Optical (Active mode)

Monitor:

2.7" wide LCD monitor (Approx. 230 K dots)

Microphone:

Stereo

Speaker:

1 round speaker, dynamic type

White balance adjustment:

Auto tracking white balance system

Standard illumination:

1,400 lx

Minimum required illumination:

Approx. 4 lx (1/30 with Low Light mode in the Scene Mode)

Approx. 1 lx with the Color Night Rec function

AV multi connector video output level:

Component video output level;

Y; 1.0 Vp-p, 75 Ω

Pb; 0.7 Vp-p, 75 Ω

Pr; 0.7 Vp-p, 75 Ω

AV video output level;

1.0 Vp-p, 75 Ω, NTSC system

HDMI mini connector video output level:

HDMI™ 1080i/480p

AV multi connector audio output level (Line):

316 mV, 600 Ω, 2 ch

HDMI mini connector audio output level:

[AVCHD]; Dolby Digital/Linear PCM

[iFrame]; Linear PCM

USB:

Reader function

SD card; Read only (No copyright protection support)

HC-V100M

Built-in memory; Read only

Hi-Speed USB (USB 2.0), USB terminal Type Mini B

Battery charging function (Charges from USB terminal when the main unit is off)

Dimensions:

51.5 mm (W)×59.5 mm (H)×112.5 mm (D)
[2.028 " (W)×2.343 " (H)×4.429 " (D)] (including projecting parts)

Mass (Weight):

HC-V100

Approx. 181 g (Approx. 0.399 lbs.)
[without battery (supplied) and an SD card (optional)]

HC-V100M

Approx. 183 g (Approx. 0.403 lbs.)
[without battery (supplied)]

Mass (Weight) in operation:

HC-V100

Approx. 225 g (Approx. 0.496 lbs.)
[with battery (supplied) and an SD card (optional)]

HC-V100M

Approx. 225 g (Approx. 0.496 lbs.)
[with battery (supplied)]

Operating temperature:

0 °C to 40 °C (32 °F to 104 °F)

Operating humidity:

10%RH to 80%RH

Battery operation time:

See page 23

AC adaptor

Information for your safety

Power source:	AC 100 V to 240 V, 50/60 Hz (VSK0780) AC 110 V to 240 V, 50/60 Hz (VSK0781)
Power consumption:	12 W
DC output:	DC 5.0 V, 1.6 A







Dimensions:

49 mm (W)×24 mm (H)×79 mm (D) [1.93 " (W)×0.94 " (H)×3.11 " (D)]

Mass (Weight):

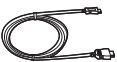
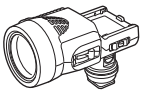
Approx. 91 g (Approx. 0.20 lbs.)

Optional accessories

Accessory No.	Figure	Description
VW-BC10PP		Battery charger
VW-VBK180* ¹		Rechargeable Lithium Ion Battery Pack
VW-VBK360* ¹		Rechargeable Lithium Ion Battery Pack
RP-CDHM15 RP-CDHM30		HDMI mini cable
VW-LDC103PP* ²		Video DC Light
VZ-LL10PP		Light bulb for video DC light
VW-SK12PP		Shoe adaptor
VW-ACK180PP		Accessory kit

*1 Please refer to page 23, concerning the battery charging time and available recording time.

*2 To use the VW-LDC103PP, the shoe adaptor/VW-SK12PP and the battery pack/VW-VBG130, VW-VBG260 are required. To charge the battery pack/VW-VBG130, VW-VBG260, the AC adaptor/VW-AD21PP-K, VW-AD20PP-K is required.

Accessory No.	Figure	Description
RP-SDL16GU1K RP-SDL08GU1K RP-SDL04GU1K RP-SDL02GU1K		Class 4 16 GB SDHC Memory Card Class 4 8 GB SDHC Memory Card Class 4 4 GB SDHC Memory Card Class 4 2 GB SD Memory Card
RP-SDU64GE1K RP-SDU32GU1K RP-SDU16GU1K RP-SDU08GU1K RP-SDU04GU1K		Class 10 64 GB SDXC Memory Card Class 10 32 GB SDHC Memory Card Class 10 16 GB SDHC Memory Card Class 10 8 GB SDHC Memory Card Class 10 4 GB SDHC Memory Card

NOTE:

Accessories and/or model numbers may vary by country. Please consult your local dealer.

Product numbers correct as of Jan. 2012. These may be subject to change.

Accessory Order Form (For USA and Puerto Rico Customers)

Please photocopy this form when placing an order.

1. Model # _____
 2. Items Ordered _____

Accessory #	Description	Price Each	Quantity	Total Price
Shipping & Handling				\$6.95
Subtotal				
Your State & Local Sales Tax				
Total				

3. Method of payment (check one)

- American Express
 VISA Credit Card # _____
 MasterCard Expiration Date _____
 Discover Customer Signature _____

(Please do not send cash)

4. Shipping information (UPS delivery requires complete street address)

Ship To:

Mr.

Mrs.

Ms. _____

First Last

Phone#:

Day () _____

Street Address _____

Night () _____

City State Zip

TO OBTAIN ANY OF OUR ACCESSORIES YOU CAN DO ANY OF
 THE FOLLOWING:
 VISIT YOUR LOCAL PANASONIC DEALER
 OR
 CALL PANASONIC'S ACCESSORY ORDER LINE AT 1-800-332-5368
 [6 AM-6 PM M-F, PACIFIC TIME]
 OR
 MAIL THIS ORDER TO: PANASONIC NATIONAL PARTS CENTER
 20421 84th Ave. S., Kent, WA 98032

In CANADA, please contact your local Panasonic dealer for more information on Accessories.

Limited Warranty (ONLY FOR U.S.A. AND PUERTO RICO)

**Panasonic Consumer Marketing Company of North America,
Division of Panasonic Corporation of North America**
One Panasonic Way, Secaucus, New Jersey 07094

Panasonic Camcorder Products Limited Warranty

Limited Warranty Coverage (For USA and Puerto Rico Only)

If your product does not work properly because of a defect in materials or workmanship, Panasonic Consumer Marketing Company of North America (referred to as "the warrantor") will, for the length of the period indicated on the chart below, which starts with the date of original purchase ("warranty period"), at its option either (a) repair your product with new or refurbished parts, (b) replace it with a new or a refurbished equivalent value product, or (c) refund your purchase price. The decision to repair, replace or refund will be made by the warrantor.

Product or Part Name	Parts	Labor
Camcorder	1 year	90 days
SD Memory Cards, Rechargeable Batteries (defective exchange)	90 days	Not Applicable

During the "Labor" warranty period there will be no charge for labor. During the "Parts" warranty period, there will be no charge for parts. This Limited Warranty excludes both parts and labor for non-rechargeable batteries, antennas, and cosmetic parts (cabinet). This warranty only applies to products purchased and serviced in the United States or Puerto Rico. This warranty is extended only to the original purchaser of a new product which was not sold "as is".

Carry-In or Mail-In Service

To find a service center please visit <http://www.panasonic.com/help> or call 1-800-211-PANA (7262).

When shipping the unit, carefully pack, include all supplied accessories listed in the Owner's Manual, and send it prepaid, adequately insured and packed well in a carton box. When shipping Lithium Ion batteries please visit our Web Site at www.panasonic.com/BatteryHandling as Panasonic is committed to providing the most up to date information. Include a letter detailing the complaint, a return address and provide a daytime phone number where you can be reached. A valid registered receipt is required under the Limited Warranty.

IF REPAIR IS NEEDED DURING THE WARRANTY PERIOD, THE PURCHASER WILL BE REQUIRED TO FURNISH A SALES RECEIPT/PROOF OF PURCHASE INDICATING DATE OF PURCHASE, AMOUNT PAID AND PLACE OF PURCHASE. CUSTOMER WILL BE CHARGED FOR THE REPAIR OF ANY UNIT RECEIVED WITHOUT SUCH PROOF OF PURCHASE.

Limited Warranty Limits And Exclusions

This warranty ONLY COVERS failures due to defects in materials or workmanship, and DOES NOT COVER normal wear and tear or cosmetic damage. The warranty ALSO DOES NOT COVER damages which occurred in shipment, or failures which are caused by products not supplied by the warrantor, or failures which result from accidents, misuse, abuse, neglect, mishandling, misapplication, alteration, faulty installation, set-up adjustments, misadjustment of consumer controls, improper maintenance, power line surge, lightning damage, modification, introduction of sand, humidity or liquids, commercial use such as hotel, office, restaurant, or other business or rental use of the product, or service by anyone other than a Factory Service Center or other Authorized Servicer, or damage that is attributable to acts of God.

THERE ARE NO EXPRESS WARRANTIES EXCEPT AS LISTED UNDER "LIMITED WARRANTY COVERAGE".

THE WARRANTOR IS NOT LIABLE FOR INCIDENTAL OR CONSEQUENTIAL DAMAGES RESULTING FROM THE USE OF THIS PRODUCT, OR ARISING OUT OF ANY BREACH OF THIS WARRANTY.

(As examples, this excludes damages for lost time, travel to and from the servicer, loss of or damage to media or images, data or other memory or recorded content. The items listed are not exclusive, but for illustration only.)

ALL EXPRESS AND IMPLIED WARRANTIES, INCLUDING THE WARRANTY OF MERCHANTABILITY, ARE LIMITED TO THE PERIOD OF THE LIMITED WARRANTY.

Some states do not allow the exclusion or limitation of incidental or consequential damages, or limitations on how long an implied warranty lasts, so the exclusions may not apply to you.

This warranty gives you specific legal rights and you may also have other rights which vary from state to state. If a problem with this product develops during or after the warranty period, you may contact your dealer or Service Center. If the problem is not handled to your satisfaction, then write to the warrantor's Consumer Affairs Department at the addresses listed for the warrantor.

PARTS AND SERVICE, WHICH ARE NOT COVERED BY THIS LIMITED WARRANTY, ARE YOUR RESPONSIBILITY.

Customer Services Directory (United States and Puerto Rico)

Obtain Product Information and Operating Assistance; locate your nearest Dealer or Service Center; purchase Parts and Accessories; or make Customer Service and Literature requests by visiting our Web Site at:

<http://www.panasonic.com/help>

or, contact us via the web at:

<http://www.panasonic.com/contactinfo>

You may also contact us directly at:

1-800-211-PANA (7262)

Monday-Friday 9am-9pm, Saturday-Sunday 10am-7pm EST

For hearing or speech impaired TTY users, TTY: 1-877-833-8855

Accessory Purchases (United States and Puerto Rico)

Purchase Parts, Accessories and Instruction Books online for all Panasonic Products by visiting our Web Site at:

<http://www.pstc.panasonic.com>

Or, send your request by E-mail to:

npcparts@us.panasonic.com

You may also contact us directly at:

1-800-332-5368 (Phone) 1-800-237-9080 (Fax Only)

(Monday-Friday 9am-9pm EST)

Panasonic National Parts Center

20421 84th Ave. S., Kent, WA 98032

(We accept Visa, MasterCard, Discover Card, American Express)

For hearing or speech impaired TTY users, TTY: 1-866-605-1277

As of January 2012

Warranty (For Canadian Customers)

Panasonic Canada Inc.

5770 Ambler Drive, Mississauga, Ontario L4W 2T3

PANASONIC PRODUCT – LIMITED WARRANTY

Panasonic Canada Inc. warrants this product to be free from defects in material and workmanship under normal use and for a period as stated below from the date of original purchase agrees to, at its option either (a) repair your product with new or refurbished parts, (b) replace it with a new or a refurbished equivalent value product, or (c) refund your purchase price. The decision to repair, replace or refund will be made by Panasonic Canada Inc.

Camcorder Products - One (1) year, parts and labour

This warranty is given only to the original purchaser, or the person for whom it was purchased as a gift, of a Panasonic brand product mentioned above sold by an authorized Panasonic dealer in Canada and purchased and used in Canada, which product was not sold "as is", and which product was delivered to you in new condition in the original packaging.

IN ORDER TO BE ELIGIBLE TO RECEIVE WARRANTY SERVICE HEREUNDER, A PURCHASE RECEIPT OR OTHER PROOF OF DATE OF ORIGINAL PURCHASE, SHOWING AMOUNT PAID AND PLACE OF PURCHASE IS REQUIRED

LIMITATIONS AND EXCLUSIONS

This warranty ONLY COVERS failures due to defects in materials or workmanship, and DOES NOT COVER normal wear and tear or cosmetic damage. The warranty ALSO DOES NOT COVER damages which occurred in shipment, or failures which are caused by products not supplied by Panasonic Canada Inc., or failures which result from accidents, misuse, abuse, neglect, mishandling, misapplication, alteration, faulty installation, set-up adjustments, misadjustment of consumer controls, improper maintenance, improper batteries, power line surge, lightning damage, modification, introduction of sand, humidity or liquids, commercial use such as hotel, office, restaurant, or other business or rental use of the product, or service by anyone other than an Authorized Servicer, or damage that is attributable to acts of God.

Dry cell batteries are also excluded from coverage under this warranty. Rechargeable batteries are warranted for ninety (90) days from date of original purchase.

THIS EXPRESS, LIMITED WARRANTY IS IN LIEU OF ALL OTHER WARRANTIES, EXPRESS OR IMPLIED, INCLUDING ANY IMPLIED WARRANTIES OF MERCHANTABILITY AND FITNESS FOR A PARTICULAR PURPOSE. IN NO EVENT WILL PANASONIC CANADA INC. BE LIABLE FOR ANY SPECIAL, INDIRECT OR CONSEQUENTIAL DAMAGES RESULTING FROM THE USE OF THIS PRODUCT OR ARISING OUT OF ANY BREACH OF ANY EXPRESS OR IMPLIED WARRANTY. (As examples, this warranty excludes damages for lost time, travel to and from the Authorized Servicer, loss of or damage to media or images, data or other memory or recorded content. This list of items is not exhaustive, but for illustration only.)

In certain instances, some jurisdictions do not allow the exclusion or limitation of incidental or consequential damages, or the exclusion of implied warranties, so the above limitations and exclusions may not be applicable. This warranty gives you specific legal rights and you may have other rights which vary depending on your province or territory.

WARRANTY SERVICE

For product operation and information assistance, please contact:

Our Customer Care Centre: Telephone: 1-800-995-8649
Fax #: (905) 238-2360
Email link: camcorderconciierge@ca.panasonic.com

For defective product exchange within the warranty period, please contact the original dealer or our Customer Care Centre.

Useful Information (Only For Latin American Countries)

Customer Service

Customer Service Directory

Obtain product information and operative assistant; localize the closer distributor or Service Center; buy spare parts and accessories by our web site to Latin American:

<http://www.lar.panasonic.com>

Also you may contact us directly by our Contact Center:

Panama	800-PANA (800-7262)
Colombia	01-8000-94PANA (01-8000-947262)
Ecuador	1800-PANASONIC (1800-726276)
Costa Rica	800-PANA737 (800-7262737)
El Salvador	800-PANA (800-7262)
Guatemala	1-801-811-PANA (1-801-811-7262)
Chile	800-390-602 From a cell phone: 797-5000
Venezuela	800-PANA-800 (800-7262-800)
Uruguay	0-800-PANA (0-800-7262)
Peru	0800-00726
Argentina	0800-333-PANA (0800-333-7262) 0810-321-PANA (0810-321-7262)
Paraguay	0800-11-PANA (0800-11-7262)

Mexico Service

To obtain information in the Republic of Mexico contact us at:

[email: atencion.clientes@mx.panasonic.com](mailto:atencion.clientes@mx.panasonic.com)

Or you may contact us in the next following phones numbers:

01800-VIP-PANA (01800-847-7262) - Interior
(55) 5000-1200 - Mexico D.F. and Metropolitan Area

Index

■ A

AC adaptor	21, 110
Alert sound	43
Anti-Ground-Shooting (AGS)	55
Approximate number of recordable pictures	115
Auto focus	35
Auto slow shutter	56
Automatic face framing	55
Automatic white balance	35
AV multi connector	17, 74, 85
AV multi connector output	77
AVCHD	8

■ B

Backlight compensation	50
Battery	20, 109
Battery capacity indication	23
Built-in memory	8

■ C

Card	24
Card status	45
Changing the display style	41
Charging time	23
Cleaning	108
Color night rec function	52
Component out	77
Copy	
Dubbing	82, 85
From built-in memory to SD card	80
Creating still picture from motion picture	64

■ D

Date and time display	41
Date and time setting	28
Delete	69
Demo mode	46
Digital zoom	54
Display	40
Dividing a scene (AVCHD)	71
Dividing a scene to partially delete (iFrame)	72

■ E

Economy (AC adaptor)	42
Economy (Battery)	41

■ F

Fade	50
Fade color	50
Focus	62
Formatting	44
Frame-by-frame playback	63

■ G

Gain	61
Grip belt	19
Guidelines	50

■ H

HD Writer LE 1.1	86, 97
HDMI mini connector	17, 74, 78
HDMI resolution	77
Help mode	50

■ I

i.Zoom	54
iFrame	8
Indications	99
Initial setting	44
Intelligent Auto Mode	34
Intelligent contrast control	52
Iris	61

■ L

Language	46
LCD monitor	18, 112
LCD set	43
Limited Warranty (Canada)	124
Limited Warranty (USA and Puerto Rico)	122

■ M

Manual focus	62
Manual recording	59
Media select	30
Media status	45
Menu	39
Microphone level	57
Mode switch	27
Motion picture compatibility	38

■ O

Operation icons	49
Optical image stabilizer demo	46
Optical image stabilizer function	48

■ P

Picture quality	58
Playback Operations	63
Playback zoom	65
Playing back motion pictures/ still pictures by date	66
Power button	26
Power LCD	43
PRE-REC	51
Protect	73

■ Q

Quick start	42
-------------	----

■ R

Recordable time	23, 114
Recording format	8, 54
Recording modes	54
Recording time elapsed	31
Recovery	102
Remaining number of still pictures	33
Remaining time left for recording	31

Repeat playback	64
Resume playback	65

■ S

Scene mode	53
Scene protect	73
SD Memory Card	24
SD Speed Class Rating	24
SDHC Memory Card	24
SDXC Memory Card	24
Self-recording	29
Shutter sound	58
Shutter speed	61
Slide show	37, 67
Slow-motion playback	63
Soft skin mode	51
Still picture compatibility	38

■ T

Tele macro	51
Tripod receptacle	19
TV aspect	76

■ U

Useful Information (Latin American Countries)	125
--	-----

■ V

VIERA Link	78
Volume adjustment	37

■ W

White balance	59
Wind cut	56
World time setting	40

■ Z

Zoom	47
Zoom mode	54

Spanish Quick Use Guide/Guía española para el uso rápido

■ Insertar la batería

Meta la batería insertándola en la dirección señalada en la figura.

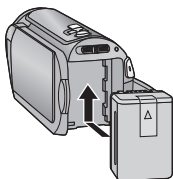

- Introduzca la batería hasta que haga clic y se cierre.

■ Carga de la batería

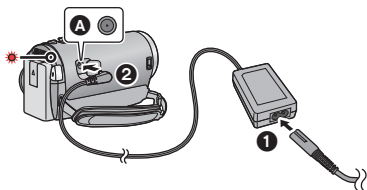

- A** Terminal de entrada de CC
- 1** Conecte el cable de CA al adaptador de CA, luego a la toma de CA.
- 2** Conecte el adaptador de CA al terminal de entrada de CC [DC IN].
- El indicador de estado parpadea en rojo en intervalos de aproximadamente 2 segundos (aprox. 1 segundo apagado y 1 segundo encendido), para indicar que se ha iniciado la carga.
Se apagará cuando se completa la carga.

■ Insertar/extraer una tarjeta SD

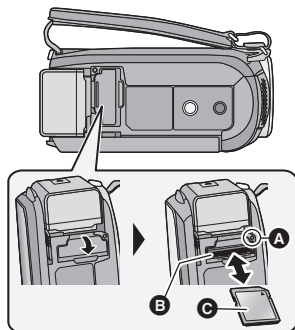

Testigo de acceso [ACCESS] **A**

- Cuando el dispositivo accede a la tarjeta SD o a la memoria integrada, se enciende el testigo de acceso.
 - Verificar que la lámpara de acceso se haya apagado.
- 1) Abra la tapa de la tarjeta SD e introduzca (retire) la tarjeta SD en (desde) la ranura correspondiente **B**.
 - Oriente el lado de la etiqueta **C** en la dirección mostrada en la ilustración e introdúzcalo hasta el fondo.
 - Presione el centro de la tarjeta SD, luego sáquela recta.
 - 2) Cierre de forma segura la tapa de la tarjeta SD.
 - Círrerlo firmemente hasta que haga clic.

■ Encender/apagar el dispositivo

Encender y apagar el dispositivo con el botón de alimentación

Pulse el botón de alimentación para encender el dispositivo.

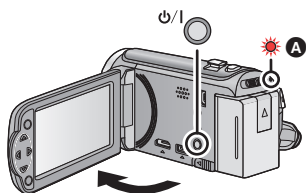

- A El indicador de estado se ilumina.
- Para apagar la unidad, mantenga pulsado el botón de alimentación hasta que el indicador de estado se apague.

Encendido y apagado del monitor LCD

El dispositivo se enciende al abrir el monitor LCD, y se apaga al cerrarlo.

Para encender el dispositivo

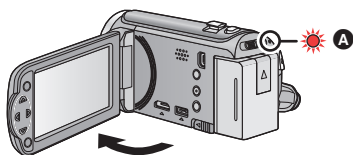

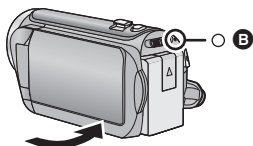

- A El indicador de estado se ilumina.

Para apagar el dispositivo





- B El indicador de estado se apaga.



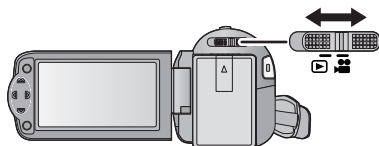

■ Selección del modo

Utilizando el selector de modo, cambie el modo a  o .



	Modo de grabación (→ 31, 33)
	Modo de reproducción (→ 36, 63)

■ Sobre como usarlo boton del cursor

- Utilice el botón del cursor para seleccionar las funciones de grabación y las operaciones de reproducción, y para hacer funcionar la pantalla de menús.
- En estas instrucciones de funcionamiento, el botón del cursor se denomina como se muestra a continuación o como  /  /  / .

Ejemplo: Al presionar el botón (abajo)



○ Pulse ▼

■ Selección del idioma

- 1) Pulse el botón MENU, luego seleccione [CONFIGURAR] → [LANGUAGE].
- 2) Seleccione el idioma deseado.

■ Seleccionar un medio para grabar [HC-V100M]

- 1) Cambie el modo a  .
- 2) Seleccione el menú.





- 3) Seleccione el medio para grabar las películas o fotografías usando ▲/▼/◀/▶ y pulse el botón ENTER.
- Seleccione [VÍDEO/TARJETA SD] o [IMAGEN/TARJETA SD] para grabar en la tarjeta SD.
Seleccione [VÍDEO/MEM INTERNA] o [IMAGEN/MEM INTERNA] para grabar en la memoria integrada.
 - El medio se selecciona de forma separada para las películas o fotografías y se resalta en amarillo.
- 4) Pulse el botón MENU.

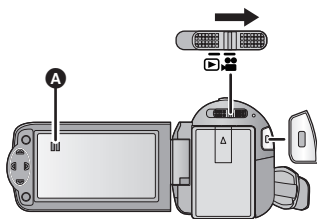

■ Grabación de películas

- 1) Cambie el modo a  .
- 2) Abra el monitor LCD.
- 3) Pulse el botón de inicio/parada de grabación para iniciar la grabación.



- A Cuando comienza a grabar,  cambia a .

■ Grabación de películas

- 1) Cambie el modo a  .
- 2) Abra el monitor LCD.
- 3) Para tomar una imagen pulse el botón  a tope.

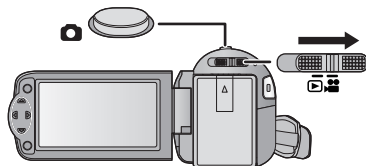

■ Reproducción de película/ fotografía

- 1) Cambie el modo a  .
- 2) Seleccione el icono de selección de modo de reproducción (A) usando ▲/▼/◀/▶ y pulse el botón ENTER.

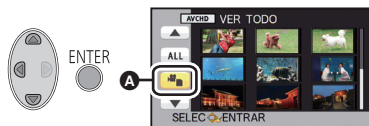

- 3) **[HC-V100]**
Seleccione el [VIDEO/FOTO] que desea reproducir, luego pulse el botón ENTER.
- [HC-V100M]**
Seleccione el [SOPORTE] y [VIDEO/ FOTO] que desea reproducir, luego pulse el botón ENTER.
- Pulse el botón MENU.
 - When a video item is selected, an icon will appear on the thumbnail display. ([AVCHD], [Frame])

- 4) Seleccione la escena o la fotografía que desea reproducir usando ▲/▼/◀/▶, y pulse el botón ENTER.



- Cuando selecciona ▲/▼ y pulsa el botón ENTER, se visualiza la página siguiente (anterior).
- 5) Seleccione la icono de funcionamiento usando ▲/▼/◀/▶.



- B** Icono de funcionamiento
- Pulse el botón ENTER para visualizar (no visualizar) el icono de funcionamiento.

(Reproducción de películas)

- ▶/||: Reproducción/Pausa
- ◀◀: Rebobinado (durante la reproducción)
- ▶▶: Avance rápido (durante la reproducción)
- : Detener la reproducción y visualizar las miniaturas.

(Reproducción de fotografías)

- ▶/||: Iniciar o hacer una pausa en la presentación de diapositivas (reproducción de las fotografías que contiene en orden numérico).
- ◀||: Reproducción de la imagen anterior.
- ||▶: Reproducción de la siguiente imagen.
- : Detener la reproducción y visualizar las miniaturas.

**Panasonic Consumer Marketing Company of North America,
Division of Panasonic Corporation of North America**
One Panasonic Way, Secaucus, NJ 07094

Panasonic Canada Inc.
5770 Ambler Drive, Mississauga, Ontario, L4W 2T3

