

Panasonic®

Operating Instructions High Definition Video Camera

Model No. **HDC-SD10PP**
HDC-TM10PP

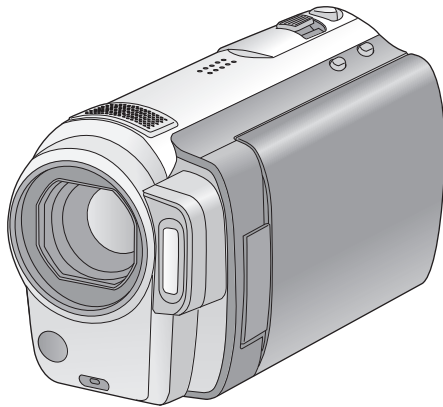

Before connecting, operating or adjusting this product, please read the instructions completely.
Spanish Quick Use Guide is included.
Guía para rápida consulta en español está incluida.

AVCHD™

DOLBY
DIGITAL
STEREO CREATOR

HDMI™
HIGH-DEFINITION MULTIMEDIA INTERFACE

SD
HC
CLASS 4

VIERA Link™

PictBridge

For USA and Puerto Rico assistance, please call: 1-800-211-PANA(7262) or,
contact us via the web at: <http://www.panasonic.com/contactinfo>

For Canadian assistance, please call: 1-800-561-5505 or visit us at www.panasonic.ca

VQT2D01

Things You Should Know

Thank you for choosing Panasonic!

You have purchased one of the most sophisticated and reliable products on the market today. Used properly, we're sure it will bring you and your family years of enjoyment. Please take time to fill in the information on the right.

The serial number is on the tag located on the back of your camera. Be sure to **retain this manual** as your convenient camera information source.

Date of Purchase _____

Dealer Purchased From _____

Dealer Address _____

Dealer Phone No. _____

Model No. _____

Serial No. _____

Safety Precautions

WARNING:

TO REDUCE THE RISK OF FIRE, ELECTRIC SHOCK OR PRODUCT DAMAGE,

- DO NOT EXPOSE THIS APPARATUS TO RAIN, MOISTURE, DRIPPING OR SPLASHING AND THAT NO OBJECTS FILLED WITH LIQUIDS, SUCH AS VASES, SHALL BE PLACED ON THE APPARATUS.
- USE ONLY THE RECOMMENDED ACCESSORIES.
- DO NOT REMOVE THE COVER (OR BACK); THERE ARE NO USER SERVICEABLE PARTS INSIDE. REFER SERVICING TO QUALIFIED SERVICE PERSONNEL.

CAUTION!

DO NOT INSTALL OR PLACE THIS UNIT IN A BOOKCASE, BUILT-IN CABINET OR IN ANOTHER CONFINED SPACE. ENSURE THE UNIT IS WELL VENTILATED. TO PREVENT RISK OF ELECTRIC SHOCK OR FIRE HAZARD DUE TO OVERHEATING, ENSURE THAT CURTAINS AND ANY OTHER MATERIALS DO NOT OBSTRUCT THE VENTILATION VENTS.

The socket outlet shall be installed near the equipment and easily accessible. The mains plug of the power supply cord shall remain readily operable. To completely disconnect this apparatus from the AC Mains, disconnect the power supply cord plug from AC receptacle.

The following mark and symbols are located on bottom of the unit.



CAUTION
RISK OF ELECTRIC SHOCK
DO NOT OPEN



CAUTION: TO REDUCE THE RISK OF ELECTRIC SHOCK, DO NOT REMOVE SCREWS. NO USER-SERVICEABLE PARTS INSIDE. REFER SERVICING TO QUALIFIED SERVICE PERSONNEL.



The lightning flash with arrowhead symbol, within an equilateral triangle, is intended to alert the user to the presence of uninsulated "dangerous voltage" within the product's enclosure that may be of sufficient magnitude to constitute a risk of electric shock to persons.



The exclamation point within an equilateral triangle is intended to alert the user to the presence of important operating and maintenance (servicing) instructions in the literature accompanying the appliance.

THE FOLLOWING APPLIES ONLY IN THE U.S.A.

FCC Note:

This equipment has been tested and found to comply with the limits for a Class B digital device, pursuant to Part 15 of the FCC Rules. These limits are designed to provide reasonable protection against harmful interference in a residential installation. This equipment generates, uses, and can radiate radio frequency energy and, if not installed and used in accordance with the instructions, may cause harmful interference to radio communications. However, there is no guarantee that interference will not occur in a particular installation. If this equipment does cause harmful interference to radio or television reception, which can be determined by turning the equipment off and on, the user is encouraged to try to correct the interference by one or more of the following measures:

- Reorient or relocate the receiving antenna.
- Increase the separation between the equipment and receiver.
- Connect the equipment into an outlet on a circuit different from that to which the receiver is connected.
- Consult the dealer or an experienced radio/TV technician for help.

FCC Caution: To assure continued compliance, follow the attached installation instructions and use only shielded interface cables with ferrite core when connecting to computer or peripheral devices.

Any changes or modifications not expressly approved by the party responsible for compliance could void the user's authority to operate this equipment.

Declaration of Conformity

Trade Name: Panasonic
Model No.: HDC-SD10PP/HDC-TM10PP
Responsible party: Panasonic Corporation of North America
One Panasonic Way, Secaucus, NJ 07094
Support Contact: Panasonic Consumer Electronics Company
1-800-211-PANA (7262)

This device complies with Part 15 of the FCC Rules. Operation is subject to the following two conditions: (1) This device may not cause harmful interference, and (2) this device must accept any interference received, including interference that may cause undesired operation.



THE FOLLOWING APPLIES ONLY IN CANADA.

This Class B digital apparatus complies with Canadian ICES-003.

Battery pack (Lithium ion battery pack)

- Use the specified unit to recharge the battery pack.
- Do not use the battery pack with equipment other than the specified unit.
- Do not get dirt, sand, liquids, or other foreign matter on the terminals.
- Do not touch the plug terminals (+ and –) with metal objects.
- Do not disassemble, remodel, heat or throw into fire.

If any electrolyte should come into contact with your hands or clothes, wash it off thoroughly with water.

If any electrolyte should come into contact with your eyes, never rub the eyes. Rinse eyes thoroughly with water, and then consult a doctor.

Warning

Risk of fire, explosion and burns. Do not disassemble, heat above 60 °C (140 °F) or incinerate.

AC adaptor

This AC adaptor operates on AC between 110 V and 240 V.

But

- In the U.S.A. and Canada, the AC adaptor must be connected to a 120V AC power supply only.
- When connecting to an AC supply outside of the U.S.A. or Canada, use a plug adaptor to suit the AC outlet configuration.
- When connecting to a supply of greater than AC 125V, ensure the cord you use is suited to the voltage of the AC supply and the rated current of the AC adaptor.
- Contact an electrical parts distributor for assistance in selecting a suitable AC plug adaptor or AC cord set.

■ Concerning the AC adaptor

Product Identification Marking is located on the bottom of unit.

U.S.A./CANADA CONSUMERS: ATTENTION:



A lithium ion/polymer battery that is recyclable powers the product you have purchased. Please call 1-800-8-BATTERY for information on how to recycle this battery.

<For USA-California only>

This product contains a CR Coin Cell Lithium Battery which contains Perchlorate Material – special handling may apply.

See www.dtsc.ca.gov/hazardouswaste/perchlorate.

IMPORTANT SAFETY INSTRUCTIONS

Read these operating instructions carefully before using the unit. Follow the safety instructions on the unit and the applicable safety instructions listed below. Keep these operating instructions handy for future reference.

- 1) Read these instructions.
- 2) Keep these instructions.
- 3) Heed all warnings.
- 4) Follow all instructions.
- 5) Do not use this apparatus near water.
- 6) Clean only with dry cloth.
- 7) Do not block any ventilation openings. Install in accordance with the manufacturer's instructions.
- 8) Do not install near any heat sources such as radiators, heat registers, stoves, or other apparatus (including amplifiers) that produce heat.
- 9) Do not defeat the safety purpose of the polarized or grounding-type plug. A polarized plug has two blades with one wider than the other. A grounding-type plug has two blades and a third grounding prong. The wide blade or the third prong are provided for your safety. If the provided plug does not fit into your outlet, consult an electrician for replacement of the obsolete outlet.
- 10) Protect the power cord from being walked on or pinched particularly at plugs, convenience receptacles, and the point where they exit from the apparatus.
- 11) Only use attachments/accessories specified by the manufacturer.
- 12) Use only with the cart, stand, tripod, bracket, or table specified by the manufacturer, or sold with the apparatus. When a cart is used, use caution when moving the cart/apparatus combination to avoid injury from tip-over.
- 13) Unplug this apparatus during lightning storms or when unused for long periods of time.
- 14) Refer all servicing to qualified service personnel. Servicing is required when the apparatus has been damaged in any way, such as power-supply cord or plug is damaged, liquid has been spilled or objects have fallen into the apparatus, the apparatus has been exposed to rain or moisture, does not operate normally, or has been dropped.



Precautions

USE & LOCATION

WARNING

- **TO AVOID SHOCK HAZARD** ... Your camera and power supply should not be exposed to rain or moisture. Do not connect the power supply or operate your camera if it gets wet. Your camera has been designed for outdoor use, however it is not designed to sustain direct exposure to water, rain, sleet, snow, sand, dust, or a direct splashing from a pool or even a cup of coffee. This action could permanently damage the internal parts of your camera. Do not attempt to disassemble this unit. There are no user serviceable parts inside. Unplug your camera from the power supply before cleaning.
- **AS WITH ANY SMALL OBJECT, SD CARDS CAN BE SWALLOWED BY YOUNG CHILDREN. DO NOT ALLOW CHILDREN TO HANDLE THE SD CARD.**

CAUTION

- **DO NOT AIM YOUR CAMERA AT THE SUN OR OTHER BRIGHT OBJECTS**
- **DO NOT LEAVE THE CAMERA WITH THE EVF AIMED DIRECTLY AT THE SUN AS THIS MAY CAUSE DAMAGE TO THE INTERNAL PARTS OF THE EVF**
- **DO NOT EXPOSE YOUR CAMERA TO EXTENDED HIGH TEMPERATURE** ... Such as, in direct sunlight, inside a closed car, next to a heater, etc... This action could permanently damage the internal parts of your camera.
- **AVOID SUDDEN CHANGES IN TEMPERATURE** ... If the unit is suddenly moved from a cold place to a warm place, moisture may form on the SD card and inside the unit.
- **DO NOT LEAVE YOUR CAMERA OR THE POWER SUPPLY TURNED ON WHEN NOT IN USE.**
- **STORAGE OF YOUR CAMERA** ... Store and handle your camera in a manner that will not subject it to unnecessary movement (avoid shaking and striking). Your camera contains a sensitive pick-up device which could be damaged by improper handling or storage.

CARE

- **TO CLEAN YOUR CAMERA** ... Do not use strong or abrasive detergents when cleaning your camera body.
- **TO PROTECT THE LENS** ... Do not touch the surface of the lens with your hand. Use a commercial camera lens solution and lens paper when cleaning the lens. Improper cleaning can scratch the lens coating.
- **TO PROTECT THE FINISH OF YOUR CAMERA** ... Before handling your camera, make sure your hands and face are free from any chemical products, such as suntan lotion, as it may damage the finish.

-If you see this symbol-

Information on Disposal in other Countries outside the European Union



This symbol is only valid in the European Union.

If you wish to discard this product, please contact your local authorities or dealer and ask for the correct method of disposal.

■ Indemnity concerning recording content

The manufacturer shall in no event be liable for the loss of recordings due to malfunction or defect of this unit, its accessories or recordable media.

IMPORTANT

■ Carefully observe copyright laws

Whatever you have recorded and created can be used for your personal entertainment only. Under copyright laws, other materials cannot be used without obtaining permission from the holders of the copyrights.

These operating instructions are designed for use with models **(HDC-SD10)** and **(HDC-TM10)**. Pictures may be slightly different from the original.

- The illustrations used in these operating instructions show model **(HDC-SD10)**,

however, parts of the explanation refer to different models.

- Depending on the model, some functions are not available.
- Features may vary, so please read carefully.

■ Cards that you can use with this unit

SD Memory Card and SDHC Memory Card

- 4 GB (or more) Memory Cards that do not have the SDHC logo are not based on SD Memory Card Specifications.
- Refer to page 24 for more details on SD cards.

■ For the purposes of these operating instructions

- SD Memory Card and SDHC Memory Card are referred to as the “SD card”.
- Functions that can be used for motion picture recording/motion picture playback are indicated by **VIDEO** in these operating instructions.
- Functions that can be used for still picture recording/still picture playback are indicated by **PHOTO** in these operating instructions.
- Pages for reference are indicated by an arrow, for example: → 00

■ Licenses

- SDHC Logo is a trademark.
- “AVCHD” and the “AVCHD” Logo are trademarks of Panasonic Corporation and Sony Corporation.
- Manufactured under license from Dolby Laboratories. Dolby and the double-D symbol are trademarks of Dolby Laboratories.
- HDMI, the HDMI Logo and the High-Definition Multimedia Interface are the registered trademarks or trademarks of HDMI Licensing LLC.
- VIERA Link™ is a trademark of Panasonic Corporation.
- EZ Sync™ is a trademark of Panasonic Corporation.
- HDAVI Control™ is a trademark of Panasonic Corporation.
- “x.v.Color” is trademark.
- Microsoft®, Windows®, Windows Vista® and DirectX® are either registered trademarks or

trademarks of the Microsoft Corporation in the United States and/or other countries.

- Microsoft product screen shot(s) reprinted with permission from Microsoft Corporation.
- IBM and PC/AT are registered trademarks of International Business Machines Corporation of the U.S.
- Intel®, Core™, Pentium® and Celeron® are the registered trademarks or trademarks of the Intel Corporation in the United States and other countries.
- AMD Athlon™ is a trademark of the Advanced Micro Devices, Inc.
- iMovie and Mac are trademarks of Apple Inc., registered in the U.S. and other countries.
- PowerPC is a trademark of International Business Machines Corporation.
- Other names of systems and products mentioned in these instructions are usually the registered trademarks or trademarks of the manufacturers who developed the system or product concerned.

This product is licensed under the AVC patent portfolio license for the personal and non-commercial use of a consumer to (i) encode video in compliance with the AVC Standard (“AVC Video”) and/or (ii) decode AVC Video that was encoded by a consumer engaged in a personal and non-commercial activity and/or was obtained from a video provider licensed to provide AVC Video. No license is granted or shall be implied for any other use. Additional information may be obtained from MPEG LA, LLC. See <http://www.mpegla.com>.

Contents

Accessories.....	10
Features.....	11
Quick Guide.....	12

Preparation

Before using

1 Handling of Built-in Memory [HDC-TM10]	15
2 Parts identification and handling	16

Setup

1 Power supply	19
Charging the battery	19
Inserting/removing the battery	20
Charging and recording time	21
Connecting to the AC outlet.....	23
2 Preparation of SD cards.....	24
Cards that you can use with this unit... ..	24
Inserting/removing an SD card	25
3 Turning the unit on/off	26
Turning the power on and off with the power button.....	26
Turning the power on and off with the LCD monitor	26
4 Selecting a mode.....	27
5 How to use the touch screen.....	28
6 Using the menu screen	29
Language selection	30
Menu list	30
7 Setting date and time	34
World time setting (Displaying the time of the travel destination)	35
8 Adjusting LCD monitor	36
LCD monitor adjustment.....	36
Touch screen calibration.....	37
Recording Yourself	37

Recording

Recording (Basic)

1 Before recording	38
Intelligent auto mode.....	39
Quick start.....	41
Quick power on	41
2 Recording motion pictures	42
Recording modes/approximate recordable time	44
PRE-REC	45
Shooting guide	45
3 Recording still pictures	46
Picture quality.....	47
Simultaneous recording (recording still pictures while recording motion pictures).....	48
Number of recordable pictures.....	48
4 Zoom in/out function	49
Zoom mode	49
5 Optical image stabilizer function.....	50
6 AF tracking	51
7 Recording with the video light.....	52

Recording (Advanced)

1 Recording functions of operation icons.....	53
Operation icons.....	53
2 Recording functions of menus	56
3 Manual recording	66
White balance	67
Manual shutter speed/iris adjustment... ..	68
Manual focus adjustment	69
Picture adjustment	69

Playback

Playback

- 1 Motion picture playback** 70
 - Creating still picture from motion picture 73
 - Highlight&Time frame index..... 73
 - Playing back motion pictures by date ... 74
 - Intelligent scene selection 74
 - Highlight playback 75
 - Repeat playback..... 76
 - Resuming the previous playback..... 76
- 2 Still picture playback**..... 77
 - Playing back still pictures by date..... 79

Editing

- 1 Deleting scenes/still pictures** 80
- 2 Dividing a scene to partially delete** ... 82
- 3 Protecting scenes/still pictures** 83
- 4 DPOF setting**..... 84
- 5 Copying between SD card and Built-in Memory [HDC-TM10]**..... 85
 - Confirming remaining capacity on the copy destination..... 85
 - Copying 86
- 6 Relay scene combining [HDC-TM10]** 88
- 7 Formatting**..... 89

With a TV

- 1 Watching Video/Pictures on your TV** 90
 - Connecting with a HDMI mini cable..... 93
 - Connecting with the component cable... 93
- 2 Playback using VIERA Link™ (HDAVI Control™)**..... 94

Backup

With other products

- 1 Connecting a DVD burner to copy to/ play back a disc** 96
 - Preparing for copying/playing back 96
 - Copying to discs 98
 - Playing back the copied disc 101
 - Managing the copied disc (Formatting, Auto protect, Displaying disc information) 102
- 2 Dubbing images onto other video devices** 103
- 3 With a printer (PictBridge)** 104

With a PC

Before using

- 1 What you can do with a PC** 107
 - End User License Agreement 109
- 2 Operating environment**..... 110

Setup

- 1 Installation** 112
- 2 Connecting to a PC** 114
 - About the PC display..... 116

Using with a PC

- 1 Starting HD Writer AE 1.5** 117
 - Reading the operating instructions of the software applications..... 117
- 2 If using Mac** 118

Others

Indications

- 1 Indications** 119
- 2 Messages** 122
 - About recovery 123

Helpful hints

- 1 Functions that cannot be used simultaneously** 124
- 2 Troubleshooting** 126

Cautions for use

Specifications

Optional accessories

- Accessory Order Form (For USA and Puerto Rico Customers)..... 142

Request for Service Notice (USA and Puerto Rico Only)

Limited Warranty (United States and Puerto Rico)

Customer Services Directory (United States and Puerto Rico)

Warranty (For Canadian Customers)

Index

Spanish Quick Use Guide/Guía española para el uso rápido

Accessories

Check the accessories before using this unit.

Battery pack

VW-VBG070



AC adaptor

VSK0697



AC cable

K2CA2CA00025



DC cable

K2GJ2DC00022



AV cable

K2KYYYY00054 or
K2KC4CB00027



Component cable

K1HY10YY0005 or
K1HY10YY0009



USB cable

K1HY04YY0032



Stylus pen

VFC4394



CD-ROM

Software



Features

Very clear high definition pictures

This unit can record detailed high definition images.



High definition images (1920×1080)*

A Number of available scan lines 1080

* If the recording mode is HA/HG/HX.



Standard images (720×480)

B Number of available scan lines 480

What is AVCHD?

This is a format for recording and playing back highly detailed high definition images.

Images are recorded based on the MPEG-4 AVC/H.264 codec for compressing images.

- Since the recording method is different from an ordinary DVD video etc., the data is not compatible.

Compatibility with other products

With other products	Available function	Picture quality
Watching Video/ Pictures on your TV (→ 90 to 95)	Playback with the HDMI mini cable – Playback using VIERA Link™ (HDAVI Control™) (→ 94)	High definition images
	Playback with the component cable [1080i]	Standard images
	Playback with the component cable [480i]	
	Playback with the AV cable	
Using a DVD burner (→ 96 to 102)	Connecting a DVD burner to copy to/play back a disc – Playing back the copied disc (→ 101)	High definition images
		Standard images
What you can do with a PC (→ 107 to 108)	Copying data to a PC and editing	High definition images
	Writing data to BD/DVD discs and SD cards	Standard images
	Converting the motion picture data to MPEG2	
	Creating a DVD Video disc	
Dubbing images onto other video devices (→ 103)	Dubbing images when connecting with the AV cable	Standard images

Quick Guide

■ Charging the battery

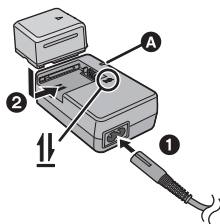

Charging lamp [CHARGE] A

Lights up:
Charging
Goes off:
Charging completed

- 1 Connect the AC cable to the AC adaptor and the AC outlet.
- 2 Insert the battery into the AC adaptor by aligning the arrows.

■ Inserting the battery

Open the LCD monitor and install the battery by inserting it in the direction shown in the figure.

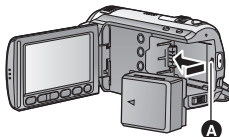

- A Insert the battery until it clicks and locks.

■ Inserting/removing an SD card

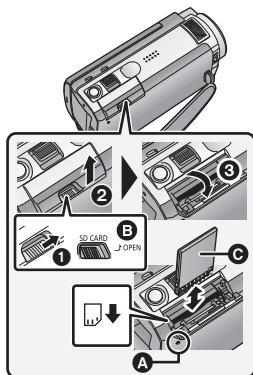

Access lamp [ACCESS] A

- When this unit is accessing the SD card or built-in memory, the access lamp lights up.

- 1) Open the SD card cover by sliding the OPEN lever B.
- While sliding the lever, push up on the SD card cover to open.
- 2) Insert/remove the SD card.
 - Face the terminal side C in the direction shown in the illustration and press it straight in as far as it will go.
 - Press the center of the SD card and then pull it straight out.
- 3) Return the SD card cover to its original position and press down to close.
 - Securely close it until it clicks.

■ How to turn on the power

Turning the power on and off with the power button

Press the power button to turn on the power.

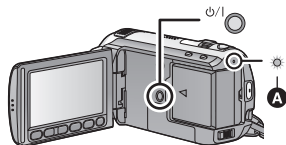

- A Status indicator lights.
 - To turn off the power, hold down the power button until the status indicator goes off.

Turning the power on and off with the LCD monitor

Power is turned on when the LCD monitor is opened, and power is turned off when it is closed.

■ To turn on the power

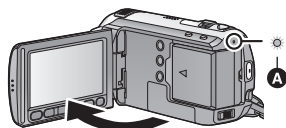



- A The status indicator lights.

■ To turn off the power





- B The status indicator goes off.

■ Selecting a mode

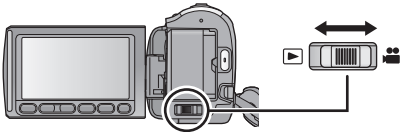
Operate the mode switch to change the mode to  or .



	Recording mode (→ 42, 46)
	Playback mode (→ 70, 77)

■ How to use the touch screen

You can operate by directly touching the LCD monitor (touch screen) with your finger. It is easier to use the stylus pen (supplied) for detailed operation or if it is hard to operate with your fingers.

Touch and release the touch screen to select icon or picture.

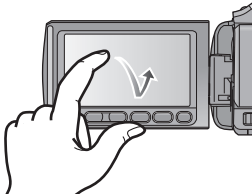

■ Language selection



- 1) Press the MENU button, then touch [SETUP] → [LANGUAGE].
- 2) Touch [English].

■ Recording motion pictures

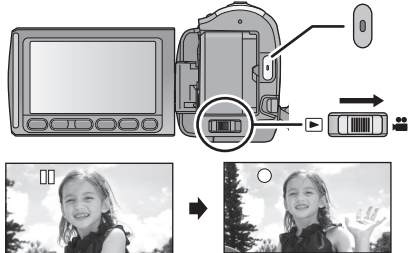
- 1) Change the mode to .
- 2) Open the LCD monitor.
 - For users who have **[HDC-SD10]**, proceed to step 4.
- 3) **[HDC-TM10]**
Press the MENU button, then touch [MEDIA SELECT] → [Built-in Memory] or [SD CARD].
- 4) Press the recording start/stop button to start recording.



■ Recording still pictures

- 1) Change the mode to .
- 2) Open the LCD monitor.
 - For users who have **[HDC-SD10]**, proceed to step 4.
- 3) **[HDC-TM10]**
Press the MENU button, then touch [MEDIA SELECT] → [Built-in Memory] or [SD CARD].
- 4) Press the  button fully to take the picture.

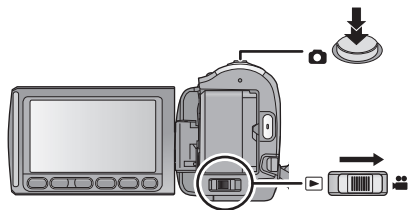

■ Motion picture playback

- 1) Change the mode to  .
- 2) Touch the play mode select icon **A** to select desired media to be played back.



- Touch [VIDEO/SD CARD] to play back the SD card.

[HDC-TM10]

Touch [VIDEO/Built-in Memory] to play back the built-in memory.

- 3) Touch the scene to be played back.



- 4) Select the playback operation by touching the operation icon.



-
- ▶/||: Playback/Pause
 - ◀◀: Rewind playback
 - ▶▶: Fast forward playback
 - : Stops the playback and shows the thumbnails.

■ Still picture playback

- 1) Change the mode to  .
- 2) Touch the play mode select icon **A** to select desired media to be played back.



- Touch [PICTURE/SD CARD] to play back the SD card.

[HDC-TM10]

Touch [PICTURE/Built-in Memory] to play back the built-in memory.

- 3) Touch the still picture to be played back.



- 4) Select the playback operation by touching the operation icon.



-
- ▶/||: Slide show (playback of the still pictures in numerical order) start/pause.
 - ◀||: Plays back the previous picture.
 - ||▶: Plays back the next picture.
 - : Stops the playback and shows the thumbnails.

This unit is equipped with the built-in 8 GB memory. When using this component, pay attention to the following points.

Indemnity about recorded content

Panasonic does not accept any responsibility for damages directly or indirectly due to any type of problems that result in loss of recording or edited content, and does not guarantee any content if recording or editing does not work properly. Likewise, the above also applies in a case where any type of repair is made to the unit (including any other non-built-in memory related component).

■ Back up data periodically.

The built-in memory is temporary storage. In order to avoid erasing data due to static electricity, electromagnetic waves, breakage, and failures, back up the data to a PC or DVD disc. (→ 96, 107)

■ Access lamp [ACCESS] **A**

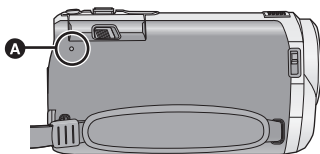

- The lamp illuminates while the SD card or built-in memory is being accessed (initialization, recording, playback, deleting etc.).
- Do not perform the following operations when the lamp illuminates. It may damage the built-in memory or cause a malfunction in the unit.
 - Turn the unit off
 - Insert and remove the USB cable
 - Expose the unit to vibrations or shock
- About disposing of or giving away this unit. (→ 134)

Parts identification and handling

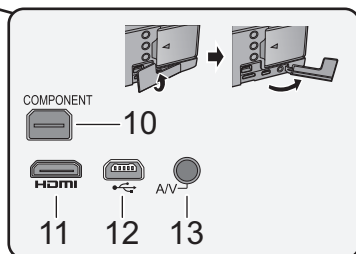
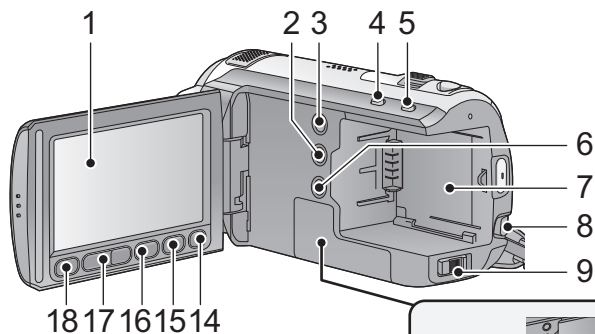

1 LCD monitor (Touch screen) (→ 28, 36)

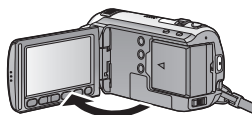

- It can open up to 90°.

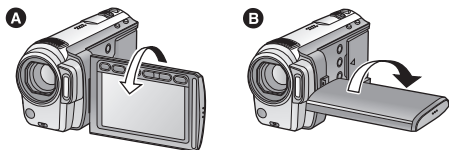

- It can rotate up to 180° **A** towards the lens or 90° **B** towards the opposite direction.

Due to limitations in LCD production technology, there may be some tiny bright or dark spots on the LCD monitor screen. However, this is not a malfunction and does not affect the recorded picture.

- 2 Manual button [MANUAL] (→ 66)**
3 PRE-REC button [PRE-REC] (→ 45)

- 4 Intelligent auto button [iA] (→ 39)**
5 Optical image stabilizer button [O.I.S.] (→ 50)
6 Power button [ON/OFF] (→ 26)
7 Battery holder (→ 20)
8 Battery release lever [BATT] (→ 20)
9 Mode switch (→ 27)
10 Component terminal [COMPONENT] (→ 90)
11 HDMI mini connector [HDMI] (→ 90, 94)
12 USB terminal [USB] (→ 96, 104, 114)
13 Audio-video output terminal [A/V] (→ 90, 103)

- Use the AV cable (only the supplied cable).
- 14 Delete button [DELETE] (→ 80)**
- 15 Video light button [LIGHT] (→ 52)**
- 16 Menu button [MENU] (→ 29)**
- 17 Adjust zoom buttons (→ 49)**
- These buttons function in the same manner as the zoom lever. Changing the thumbnail display and adjusting the volume can be done.
- 18 Sub recording start/stop button (→ 38)**
- This button functions in the same manner as the recording start/stop button.

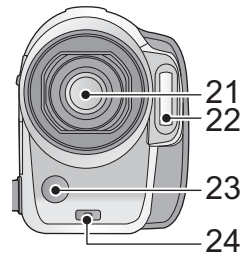
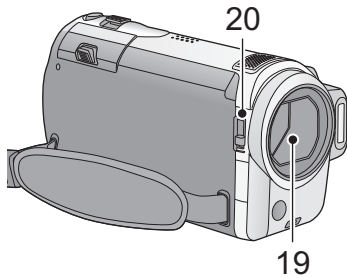

19 Lens cover

20 Lens cover opening/closing switch

When not using the unit, close the lens cover to protect the lens.

21 Lens

22 Built-in flash (→ 63)

23 Video light (→ 52)

24 Recording lamp (→ 31)

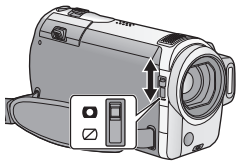

- Slide the opening/closing switch to open/close the cover.

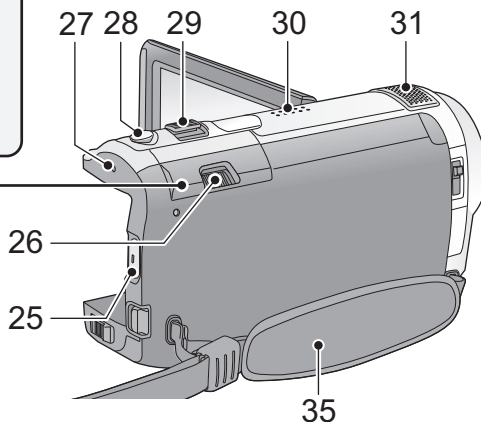
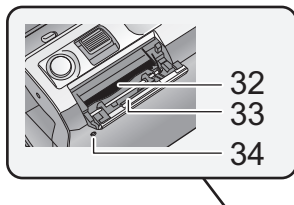

25 Recording start/stop button (→ 42)

26 SD card open lever [OPEN] (→ 25)

27 Status indicator (→ 26)

28 Photoshot button [] (→ 46)

29 Zoom lever [W/T] (In recording mode) (→ 49)

Thumbnail display switch/Volume lever
[-  /VOL+] (In playback mode) (→ 71)

30 Speaker

31 Internal stereo microphones

32 Card slot (→ 25)

33 SD card cover (→ 25)

34 Access lamp [ACCESS] (→ 15, 25)

35

35 Grip belt

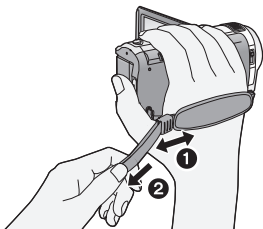

- ❶ Adjust the length to fit your hand.
- ❷ Pull to adjust the length.

When carrying the unit with your hand down (→ 38)



Pass your hand through the strap part.

36

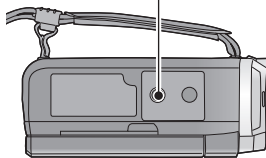

36 Tripod receptacle

This is a hole for attaching the unit to the optional tripod. (For details on mounting the tripod, refer to the operating instructions for the tripod.)

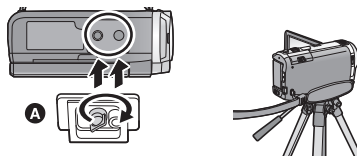

A Camera base

Be sure that the grip belt stays clear of the video light **B** when the tripod is used as shown below.

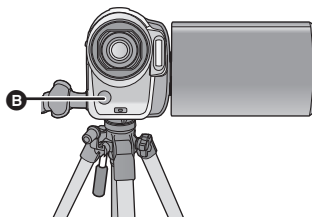

■ About batteries that you can use with this unit

The battery that can be used with this unit is VW-VBG070/VW-VBG130/VW-VBG260/VW-VBG6.

- This unit has a function to distinguish the batteries that can be used, and the batteries (VW-VBG070/VW-VBG130/VW-VBG260/VW-VBG6) are compatible with this function. (The batteries that are not compatible to this function cannot be used.)
- To use the VW-VBG260/VW-VBG6 for this unit, the battery pack holder kit VW-VH04 (optional) is required.

It has been found that counterfeit battery packs which look very similar to the genuine product are made available to purchase in some markets. Some of these battery packs are not adequately protected with internal protection to meet the requirements of appropriate safety standards. There is a possibility that these battery packs may lead to fire or explosion. Please be advised that we are not liable for any accident or failure occurring as a result of use of a counterfeit battery pack. To ensure that safe products are used we would recommend that a genuine Panasonic battery pack is used.

Charging the battery

When this unit is purchased, the battery is not charged. Charge the battery before using this unit.

Important:

If the DC cable is connected to the AC adaptor, then the battery will not charge. Remove the DC cable from the AC adaptor.

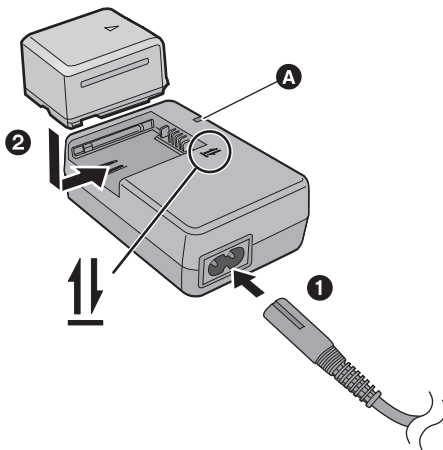

Charging lamp [CHARGE] **A**

Lights up:

Charging (Battery charging time: → 21)

Goes off:

Charging completed

Flashing:

Make sure that the terminals of the battery or the AC adaptor are not exposed to dirt, foreign objects or dust, then reconnect them properly.

(→ 135)

1 Connect the AC cable to the AC adaptor and the AC outlet.

2 Insert the battery into the AC adaptor by aligning the arrows.

- We recommend using Panasonic batteries (→ 10, 21, 140).
- If you use other batteries, we cannot guarantee the quality of this product.
- Do not heat or expose to flame.
- Do not leave the battery(ies) in an automobile exposed to direct sunlight for a long period of time with doors and windows closed.

Inserting/removing the battery

Open the LCD monitor and install the battery by inserting it in the direction shown in the figure.

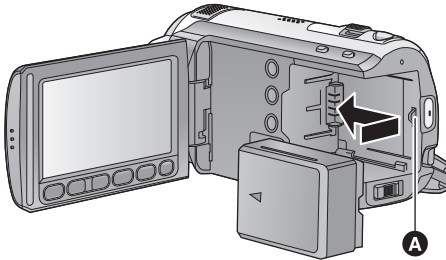

A Insert the battery until it clicks and locks.

Removing the battery

Be sure to hold down the power button until the status indicator goes off. Then remove the battery while supporting the unit to prevent it from dropping.

Move the BATTERY lever in the direction indicated by the arrow and remove the battery when unlocked.

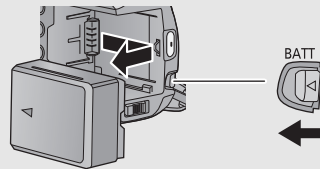

CAUTION

Danger of explosion if battery is incorrectly replaced. Replace only with the same or equivalent type recommended by the manufacturer. Dispose of used batteries according to the manufacturer's instructions.

Charging and recording time

■ Charging/Recording time

- Temperature: 25 °C (77 °F)/humidity: 60%

HDC-SD10			
Battery model number [Voltage/Capacity (minimum)]	Charging time	Maximum continuously recordable time	Actual recordable time
Supplied battery/ VW-VBG070 (optional) [7.2 V/725 mAh]	1 h 35 min	1 h 20 min	50 min
VW-VBG130 (optional) [7.2 V/1250 mAh]	2 h 35 min	2 h 15 min	1 h 25 min
VW-VBG260 (optional)* [7.2 V/2500 mAh]	4 h 40 min	4 h 25 min	2 h 45 min
VW-VBG6 (optional)* [7.2 V/5400 mAh]	9 h 25 min	10 h 55 min	6 h 45 min







HDC-TM10			
Battery model number [Voltage/Capacity (minimum)]	Charging time	Maximum continuously recordable time	Actual recordable time
Supplied battery/ VW-VBG070 (optional) [7.2 V/725 mAh]	1 h 35 min	1 h 20 min	50 min
VW-VBG130 (optional) [7.2 V/1250 mAh]	2 h 35 min	2 h 15 min	1 h 25 min
VW-VBG260 (optional)* [7.2 V/2500 mAh]	4 h 40 min	4 h 20 min	2 h 40 min
VW-VBG6 (optional)* [7.2 V/5400 mAh]	9 h 25 min	10 h 45 min	6 h 40 min

* The battery pack holder kit VW-VH04 (optional) is necessary.

- These times are approximations.
- **The indicated charging time is for when the battery has been discharged completely. Charging time and recordable time vary depending on the usage conditions such as high/low temperature.**

-
- The actual recordable time refers to the recordable time when repeatedly starting/stopping recording, turning the unit on/off, moving the zoom lever etc.
 - The batteries heat up after use or charging. This is not a malfunction.

Battery capacity indication

- The display changes as the battery capacity reduces.  →  →  →  → 
If there is less than 3 minutes remaining, then  will become red. If the battery discharges, then () will flash.
- The remaining battery capacity is displayed when using the Panasonic battery that you can use for this unit. It may take time to display the remaining battery capacity. The actual time can vary depending on your actual use.
- The maximum amount of remaining battery capacity able to be indicated is 9 hours 59 minutes. If the actual remaining time exceeds 9 hours 59 minutes, the indication will stay green and will not change until the remaining time falls below 9 hours 59 minutes.
- When changing modes, the time indication will turn off momentarily in order to recalculate the remaining battery capacity time.
- When using the AC adaptor or batteries made by other companies, the remaining battery capacity will not be shown.

Connecting to the AC outlet

Important:

While the DC cable is connected to the AC adaptor, the battery will not charge.

- Do not use the AC cable with any other equipment as it is designed only for this unit. Also, do not use the AC cable from other equipment with this unit.

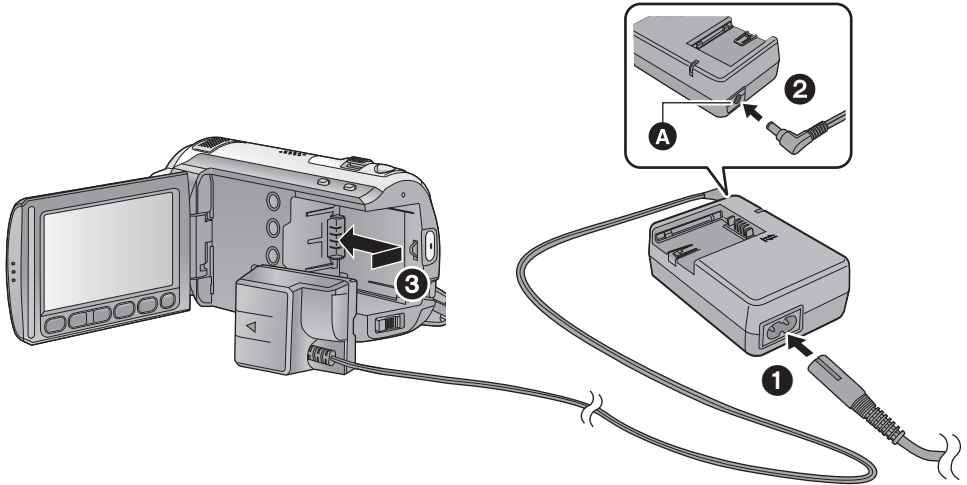

A DC output terminal

1 Connect the AC cable to the AC adaptor and the AC outlet.

2 Connect the DC cable to the AC adaptor.

3 Insert the DC cable.

- Always use the supplied AC adaptor or a genuine Panasonic AC adaptor (VW-AD21PP; optional).
- When removing the AC adaptor, be sure to hold down the power button until the status indicator goes off. Then remove the AC adaptor.

Preparation of SD cards

This unit (an SDHC compatible device) is compatible with both SD Memory Cards and SDHC Memory Cards. When using an SDHC Memory Card on another device, confirm that the device supports the SDHC Memory Card.

Cards that you can use with this unit

Use SD cards conforming to Class 4 or higher of the SD Speed Class Rating* for motion picture recording.

Card type	Capacity	Motion picture recording	Still picture recording
SD Memory Card	8 MB 16 MB	Cannot be used.	Can be used.
	32 MB 64 MB 128 MB 256 MB 512 MB	Cannot be guaranteed in operation. The recording may suddenly stop during motion picture recording depending on the SD card you use. (→ 127)	
	1 GB	RP-SDV01G	
	2 GB	RP-SDV02G, RP-SDM02G, RP-SDW02G, RP-SDP02G	
	4 GB	RP-SDV04G, RP-SDM04G, RP-SDW04G, RP-SDP04G	
SDHC Memory Card	6 GB	RP-SDM06G	
	8 GB	RP-SDV08G, RP-SDW08G, RP-SDP08G	
	12 GB	RP-SDM12G, RP-SDP12G	
	16 GB	RP-SDV16G, RP-SDW16G, RP-SDP16G	
	32 GB	RP-SDV32G, RP-SDW32G	

* The SD Speed Class Rating is the speed standard for successive writes.

- 4 GB or more Memory Cards that do not have the SDHC logo are not based on SD Memory Card Specifications.

- When the write-protect switch **A** on SD card is locked, no recording, deletion or editing will be possible on the card.
- Keep the Memory Card out of reach of children to prevent swallowing.

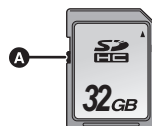

Inserting/removing an SD card

When using an SD card not from Panasonic, or one previously used on other equipment, for the first time on this unit, format the SD card. (→ 89) When the SD card is formatted, all of the recorded data is deleted. Once the data is deleted, it cannot be restored. Copy valuable data onto a PC, DVD disc etc. before proceeding with the formatting. (→ 96, 107)

Caution:

When the SD card is removed while the access lamp is lit, this unit may malfunction or the data recorded on the SD card may be lost.

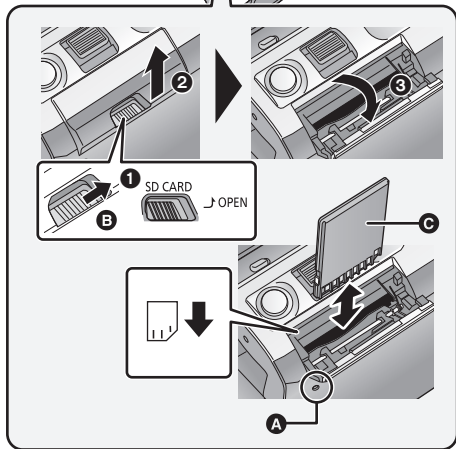
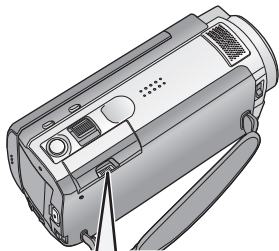

Access lamp [ACCESS] **A**

- When this unit is accessing the SD card or built-in memory, the access lamp lights up.

1 Open the SD card cover by sliding the OPEN lever **B**.

- While sliding the lever, push up on the SD card cover to open.

2 Insert/remove the SD card.

- Face the terminal side **C** in the direction shown in the illustration and press it straight in as far as it will go.
- Press the center of the SD card and then pull it straight out.

3 Return the SD card cover to its original position and press down to close.

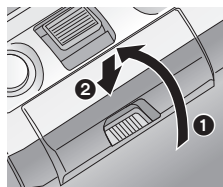

- Securely close it until it clicks.

- Do not touch the terminals on the back of the SD card.
- Do not apply strong shocks, bend, or drop the SD card.
- Electrical noise, static electricity or the failure of this unit or the SD card may damage or erase the data stored on the SD card.
- When the card access lamp is lit, do not:
 - Remove the SD card
 - Turn the unit off
 - Insert and remove the USB cable
 - Expose the unit to vibrations or shockPerforming the above while the lamp is on may result in damage to data/SD card or this unit.

- Do not expose the terminals of the SD card to water, garbage or dust.
- Do not place SD cards in the following areas:
 - In direct sunlight.
 - In very dusty or humid areas.
 - Near a heater.
 - Locations susceptible to significant difference in temperature (condensation can occur).
 - Where static electricity or electromagnetic waves occur.
- To protect SD cards, return them to their cases when you are not using them.

Turning the unit on/off

You can turn the power on and off using the power button or by opening and closing the LCD monitor.

Turning the power on and off with the power button

Press the power button to turn on the power.

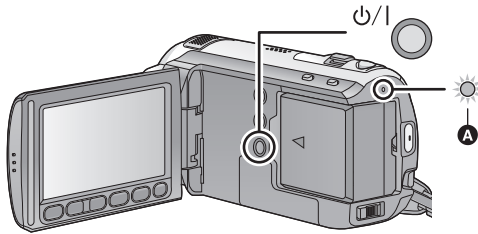

A The status indicator lights.

To turn off the power

Hold down the power button until the status indicator goes off.

Turning the power on and off with the LCD monitor

Power is turned on when the LCD monitor is opened, and power is turned off when it is closed.

During normal use, opening and closing of the LCD monitor can be conveniently used to turn the power on/off.

■ To turn on the power

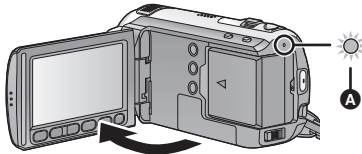

A The status indicator lights.

■ To turn off the power

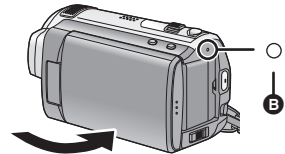

B The status indicator goes off.



In the following cases, opening the LCD monitor does not turn on the power. Press the power button to turn on the power.

- When the unit is purchased
- When you have turned off the power using the power button



When not using the unit, turn off the power using the power button.

Selecting a mode

Change the mode to recording or playback.

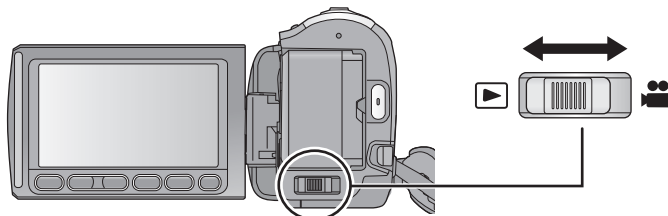
Operate the mode switch to change the mode to  or .



	Recording mode (→ 42, 46)
	Playback mode (→ 70, 77)

You can operate by directly touching the LCD monitor (touch screen) with your finger. It is easier to use the stylus pen (supplied) for detailed operation or if it is hard to operate with your fingers.

■ Touch

Touch and release the touch screen to select icon or picture.

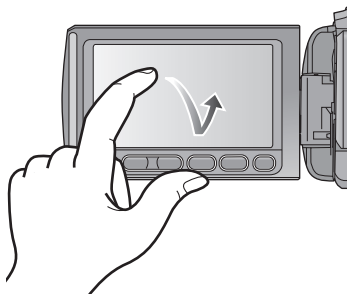

- Touch the center of the icon.
- Touching the touch screen will not operate while you are touching another part of the touch screen.

■ About the Stylus pen

The stylus pen (supplied) can be stored on the unit as shown when it is not being used. Remove the stylus pen from the unit when it is to be used.

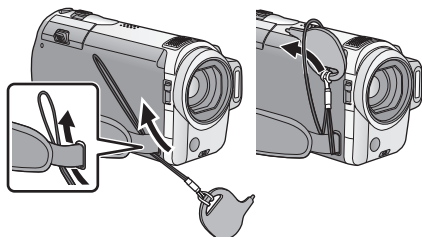

- Only use the supplied stylus pen.
- Do not tuck the stylus pen with the LCD monitor.

■ About the operation icons

▲ / ▼ / ◀ / ▶ :

These icons are used to switch the menu and thumbnail display page, for item selection and setting etc.

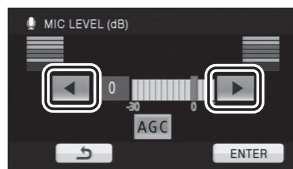
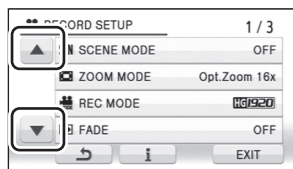

↶ :
Touch to return to the previous screen such as when setting menus

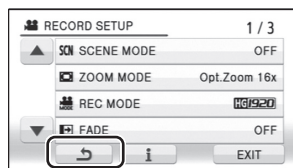

- Wipe the LCD monitor with a soft cloth, such as eye glass cleaner, when it gets dirty with finger prints etc.
- Do not touch on the LCD monitor with hard pointed tips, such as ball point pens.
- Do not touch the LCD monitor with your finger nails, or rub or press with strong force.
- It may become hard to see or hard to recognize the touch when the LCD protection sheet is affixed.
- Perform the touch screen calibration when the touch is not recognized or wrong location is recognized. (→ 37)

Using the menu screen

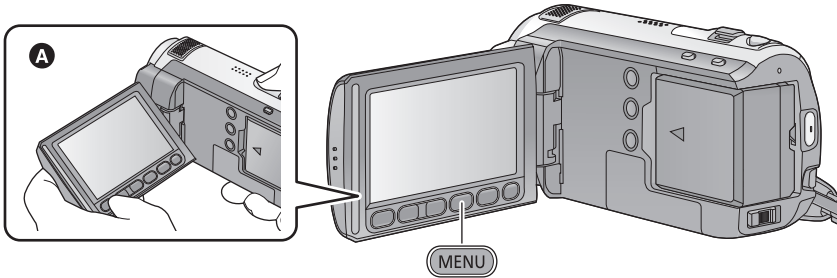

- A** It is recommended to hold the LCD monitor with your thumb and index finger when pressing the buttons on the LCD monitor.

1 Press the MENU button.



2 Touch the top menu **A**.

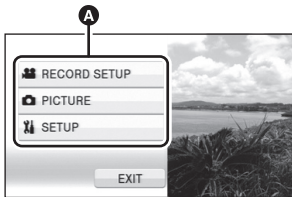

3 Touch the submenu **B**.

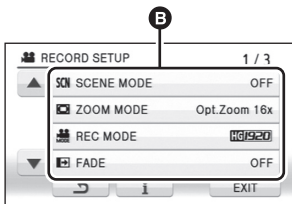

- Next (previous) page can be displayed by touching \blacktriangle / \blacktriangledown .
- Information display setting is completed when **i** is surrounded by yellow after touching it.

4 Touch the desired item to enter the setting.

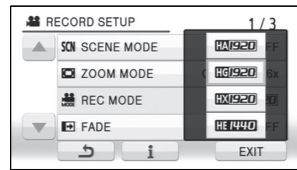

5 Touch [EXIT] or press the MENU button to exit the menu setting.

■ About **i** information display setting

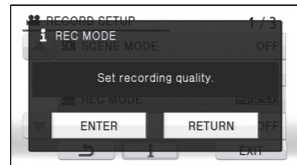

An explanation or setting confirmation message of the submenu or item being touched gets displayed in step 3 and 4. Touch the **i** to cancel the information display setting.

Language selection

You can select the language on the screen display and the menu screen.

1 Press the **MENU** button, then touch **[SETUP]** → **[LANGUAGE]**.

2 Touch **[English]**.

Menu list

Part of the menu will not be used depending on the used functions. (→ 124)

Recording mode

*1 It is not displayed when the Intelligent auto mode is on.

*2 These menus are only for **[HDC-TM10]**.

*3 **[HDC-TM10]** when the **[MEDIA SELECT]** is set to **[SD CARD]**.

*4 **[HDC-TM10]** It will be displayed only when the **[MEDIA SELECT]** is set to **[Built-in Memory]**.

RECORD SETUP

[SCENE MODE] (→ 56)

[ZOOM MODE] (→ 49)

[GUIDE LINES]*1 (→ 57)

[REC MODE] (→ 44)

[DIGITAL CINEMA]*1 (→ 57)

[RELAY REC]*4 (→ 58)

[FADE] (→ 54)

[FADE COLOR] (→ 54)

[AGS] (→ 58)

[AUTO SLOW SHTR]*1 (→ 59)

[FACE FRAMING] (→ 59)

[BACKLIGHT COMPENS.] (→ 54)

[INTELLIGENT CONTRAST]*1 (→ 54)

[SOFT SKIN MODE]*1 (→ 54)

[TELE MACRO] (→ 54)

[MAGICPIX]*1 (→ 54)

[Digital Cinema Color]*1 (→ 60)

[SHOOTING GUIDE] (→ 45)

[WIND CUT]*1 (→ 60)

[ZOOM MIC]*1 (→ 60)

[MIC LEVEL]*1 (→ 61)

[PICTURE ADJUST]*1 (→ 69)

[MF ASSIST]*1 (→ 69)

PICTURE

[QUALITY] (→ 47)

[HI-SPEED BURST]*¹ (→ 62)

[SELF TIMER] (→ 63)

[FLASH] (→ 63)

[FLASH LEVEL]*¹ (→ 63)

[RED EYE]*¹ (→ 64)

[SHTR SOUND] (→ 64)

MEDIA SELECT*²

When recording to the SD card, select [SD CARD]. When recording to the built-in memory, select [Built-in Memory].

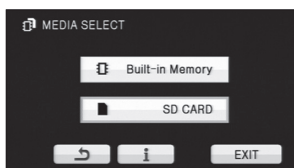

SETUP

[DISPLAY]

The screen indications are selected as shown in the illustration below.

[OFF]

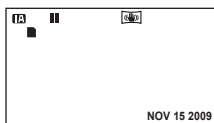

[ON]

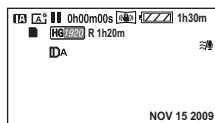

[EXT. DISPLAY] (→ 92)

[CLOCK SET] (→ 34)

[SET WORLD TIME] (→ 35)

[DATE/TIME] (→ 34)

[DATE FORMAT] (→ 34)

[ECONOMY]

[OFF]:

The power saving function is not activated.

[5 MINUTES]:

When about 5 minutes have passed without any operation, this unit automatically turns off to save battery life.

- The power save function will not activate when:
 - connected to AC adaptor
 - using the USB cable for PC, DVD burner, printer etc.
 - PRE-REC is used

[QUICK POWER ON] (→ 41)

[QUICK START] (→ 41)

[REC LAMP]

The recording lamp lights up during recording and flashes when the self-timer is counting down. When this is set to [OFF], it does not light during recording.

[ALERT SOUND]

Touch screen operation, starting and stopping of recording and power on/off can be confirmed with this sound.

2 Beeps for 4 times

When an error occurs. Check the sentence displayed on the screen. (→ 122)

[POWER LCD] (→ 36)

[LCD SET] (→ 36)

[COMPONENT OUT] (→ 93)

[HDMI RESOLUTION] (→ 93)

[VIERA Link] (→ 94)

[TV ASPECT] (→ 92)

[INITIAL SET]

Set to [YES] for changing the menu settings back to the default condition.
(Settings for [MEDIA SELECT]^{*2}, [CLOCK SET] and [LANGUAGE] will not be changed.)

[FORMAT CARD]^{*3} (→ 89)

[FORMAT Built-in Memory]^{*4} (→ 89)

[CALIBRATION] (→ 37)

[DEMO MODE]

This item is used to start the unit demonstration.

(Only when the mode is at the  position)

[HDC-SD10]

If [DEMO MODE] is switched to [ON] when there is no SD card inserted, the demonstration automatically starts.

[HDC-TM10]

If [DEMO MODE] is switched to [ON] when there is no SD card inserted and while this unit is connected to the AC adaptor, the demonstration automatically starts.

If any operation takes place, the demonstration is canceled. However if no operations take place for approx. 10 minutes, the demonstration automatically starts again. To stop the demonstration, set [DEMO MODE] to [OFF] or insert an SD card.

[O.I.S. DEMO]

This item is used to start the optical image stabilizer demo.

(Only when the mode is at the  position)

If [O.I.S. DEMO] is switched to [YES], the demonstration automatically starts.

When you touch [EXIT], the demonstration will be canceled.

[LANGUAGE] (→ 30)

▶ Playback mode

- *1 When the disc playback is selected while a DVD burner (optional) is connected, or when [INTEL. SCENE] (→ 74) is selected, this does not appear.
- *2 Only when the disc playback is selected while a DVD burner (optional) is connected, this appears.
- *3 These menus are only for [HDC-TM10].
- *4 This appears only when the [VIDEO/SD CARD] or [PICTURE/SD CARD] is selected.
- *5 [HDC-TM10] This appears only when the [VIDEO/Built-in Memory] or [PICTURE/Built-in Memory] is selected.

([🎞] motion picture playback)

VIDEO SETUP

[REPEAT PLAY]	(→ 76)
[RESUME PLAY]	(→ 76)
[SCENE PROTECT]*1	(→ 83)
[GUIDE LINES]	(→ 57)

EDIT SCENE*1

[DIVIDE]	(→ 82)
[DELETE]	(→ 81)

COPY*1*3

[] → []	(→ 86)
[] → []	(→ 86)
[RELAY SCENE COMBINE]	(→ 88)
[RELAY INFO CANCEL]	(→ 88)

DISC SETUP*2

[FORMAT DISC]	(→ 102)
[AUTO PROTECT]	(→ 102)
[DISC STATUS]	(→ 102)

SETUP

[FORMAT CARD]*4	(→ 89)
[CARD STATUS]*4	(→ 85)
[FORMAT Built-in Memory]*5	(→ 89)
[Built-in Memory STATUS]*5	(→ 85)

- For any other menus that are not described above, refer to menus with the same names for the recording mode.

([📷] still picture playback)

PICT. SETUP*1

[SCENE PROTECT]	(→ 83)
[DPOF SET]*4	(→ 84)
[DELETE]	(→ 81)

- For any other menus that are not described above, refer to menus with the same names for the recording mode and motion picture playback.

Setting date and time

When the unit is turned on for the first time, a message asking you to set the date and time will appear. Select [YES] and perform steps 2 to 3 below to set the date and time.

◇ Change the mode to .



1 Select the menu. (→ 29)

[SETUP] → [CLOCK SET] → [YES]

2 Touch the date or time to be set, then set the desired value using / .

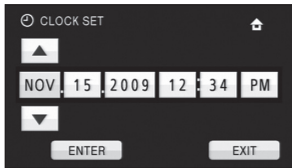
 / .



- The year will change as follows: 2000, 2001, ..., 2039, 2000, ...
- The 12-hour system is used to display the time.
-  appears on the right top of the screen when [SET WORLD TIME] (→ 35) is set to [HOME], while  appears when it is set to [DESTINATION].

3 Touch [ENTER].

- The clock function starts at [00] seconds.
- A message prompting for World time setting may be displayed. Perform the World time setting by touching the screen. (→ 35)
- Touch [EXIT] or press the MENU button to complete the setting.

Changing the date and time display mode

Select the menu. (→ 29)

[SETUP] → [DATE/TIME] → desired display style

[DATE]

NOV 15 2009

[D/T]

12:34PM
NOV 15 2009

[OFF]

- The date and time disappear from the screen after being displayed for a few seconds.

Changing the date format

Select the menu. (→ 29)

[SETUP] → [DATE FORMAT] → desired display style

Display style	Screen display
[Y/M/D]	2009. 11. 15
[M/D/Y]	NOV 15 2009
[D/M/Y]	15. 11. 2009

- The date and time function is driven by a built-in lithium battery.
- If the time display becomes [- -], the built-in lithium battery needs to be charged. To recharge the built-in lithium battery, connect the AC adaptor or attach the battery to this unit. Leave the unit as it is for approx. 24 hours and the battery will maintain the date and time for approx. 6 months. (The battery is still being recharged even if the power is off.)

World time setting (Displaying the time of the travel destination)

It is possible to display and record the time at the travel destination by selecting your home region and the travel destination.

1 Select the menu. (→ 29)

[SETUP] → [SET WORLD TIME] → [YES]

- If the clock is not set, adjust the clock to the current time. (→ 34)
- When the [HOME] (your home region) is not set, the message appears. Touch [ENTER] and proceed to Step 3.

2 (Only when setting your home region)

Touch [HOME].

- Touch [ENTER].

3 (Only when setting your home region)

Touch ◀/▶ to select your home region and touch [ENTER].

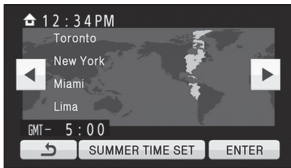

- Touch [SUMMER TIME SET] to set daylight saving time. ☀🌙 appears and the summer time setting is turned on; the clock is set forward by one hour. Touch [SUMMER TIME SET] again to return to the normal time setting.
- The current time appears on the left top of the screen. The time difference from GMT (Greenwich Mean Time) appears on the left bottom of the screen.

4 (Only when setting the region of your travel destination)

Touch [DESTINATION].

- Touch [ENTER].
- When the home region is set for the first time, the screen for selecting home/travel destination appears after setting the home region successively. If the home region has

already been set once, execute the menu operation for Step 1.

5 (Only when setting the region of your travel destination)

Touch ◀/▶ to select your travel destination and touch [ENTER].

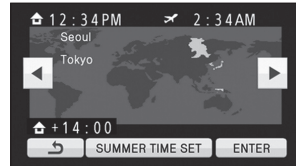

- Touch [SUMMER TIME SET] to set daylight saving time. ☀🌙 appears and the summer time setting is turned on; the clock is set forward by one hour. Touch [SUMMER TIME SET] again to return to the normal time setting.
- The local time at the selected travel destination appears on the right top of the screen. The time difference between the travel destination and the home region appears on the left bottom of the screen.
- Close the setting by pressing the MENU button. ✈ appears and the time of the travel destination is indicated.

To return the display to the home setting

Set the home region using Step 1 to 3, and close the setting by touching [EXIT] or pressing the MENU button.

- If you cannot find your travel destination in the area shown on the screen, set it by using the time difference from your home region.

Adjusting LCD monitor

- These settings will not affect the images actually recorded.

LCD monitor adjustment

■ Power LCD

This makes it easier to view the LCD monitor in bright places including outdoors.

Select the menu. (→ 29)

[SETUP] → [POWER LCD] → desired setting

*:

Makes even brighter

*:

Makes brighter

*:

Normal

*:

Makes less bright

*:

Brightness of the LCD is automatically adjusted depending on the ambient brightness.

(It is not displayed in the manual mode or in the playback mode.)

- If you use the AC adaptor, the * indication appears and the screen becomes brighter automatically when the power is turned on.
- The recordable time will become shorter when you use this unit with the LCD monitor lit up.

■ Adjusting the brightness and color level of the LCD monitor

It adjusts brightness and color density on the LCD monitor.

1 Select the menu. (→ 29)

[SETUP] → [LCD SET] → [YES]

2 Touch the desired setting item.

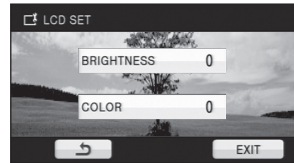

[BRIGHTNESS]:

Brightness of the LCD monitor

[COLOR]:

Color level of the LCD monitor

3 Touch / to adjust settings.



- After adjustments are made if no operations are performed for a few seconds, the bar will disappear.

4 Touch [ENTER].

- Touch [EXIT] or press the MENU button to exit the menu screen.

Touch screen calibration

Perform the touch screen calibration if a different object to the one touched is selected.

1 Select the menu. (→ 29)

[SETUP] → [CALIBRATION] → [YES]

- Touch [ENTER].

2 Touch the [+] with the supplied stylus pen and enter in calibration.



- Touch the [+] in the order it is displayed.
(5 locations)

3 Touch [ENTER].

- Calibration cannot be performed when the LCD monitor is turned 180°.

Recording Yourself

- ◇ Change the mode to  .

Rotate the LCD monitor towards the lens side.



- The image is horizontally flipped as if you see a mirror image. (However the image recorded is the same as a normal recording.)

- Only some indications will appear on the screen. When  appears, return the direction of the LCD monitor to normal position and check the warning/alarm indication. (→ 122)

Before recording

Basic camera positioning

- When you are outdoors, record pictures with the sunlight behind you. If the subject is backlit, it will become dark in the recording.
- When recording, make sure your footing is stable and there is no danger of colliding with another person or object.

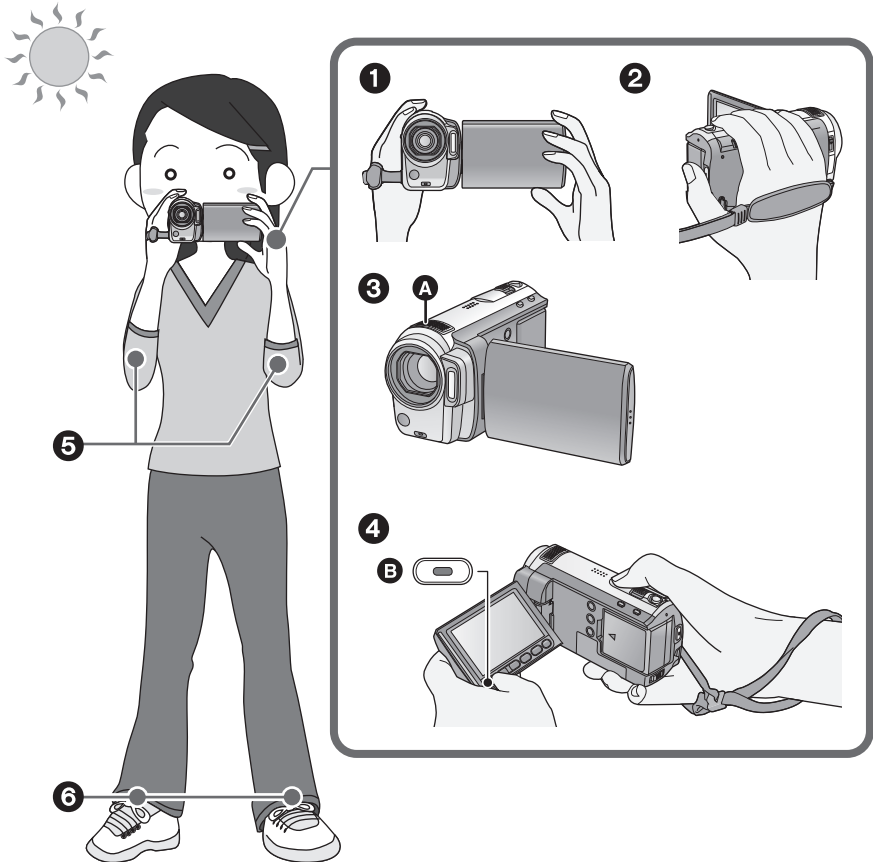

- 1 Hold the unit with both hands.
- 2 Put your hand through the grip belt.
- 3 Do not cover the microphones **A**.
- 4 It is convenient to use the Sub-recording Start/Stop button **B** when holding the unit around your waist.
- 5 Keep your arms near your body.
- 6 Separate your legs for better balance.

Intelligent auto mode





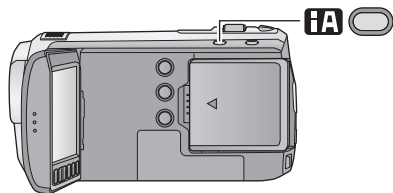



The following modes appropriate for the condition are set just by pointing the unit to what you want to record.

- When this unit is purchased, the Intelligent auto mode is set to on.



Intelligent auto button

Press this button to switch on/off the Intelligent auto mode.

Mode	Scene/Effect
iA Portrait  	When the object is a person <hr/> Faces are detected and focused automatically, and the brightness is adjusted so it is recorded clearly.
iA Scenery  	Recording outdoors <hr/> The whole landscape will be recorded vividly without whiting out the background sky, which may be very bright.
iA Spotlight  	Under a spotlight <hr/> Very bright object is recorded clearly.
iA Low light  	Dark room or twilight <hr/> It can record very clearly even in a dark room or twilight.

Mode	Scene/Effect
iA Normal	Other situations <hr/> Contrast is adjusted automatically for clear image.

- Modes are selected automatically by the unit, so it may not choose desired mode depending on the recording conditions.
- Brightness may change suddenly or flicker when set to on.
- In the Portrait mode, a subject that is bigger and close to center of the screen will be surrounded by an orange frame. (→ 59)
- Optical image stabilizer function (→ 50) is set to Active mode/ON in all modes.
- The setting of microphone level is fixed to [AUTO].
- In the following case, faces may not be detected in some recording conditions.
 - Faces are not full-faces
 - Faces tilt
 - Faces are not completely exposed (for instance wearing sunglasses)
 - The size of a face is small on the screen
 - When the digital zoom is used
- The function may not operate properly in some recording conditions, even if faces are detected.

■ When Intelligent auto mode is set to off:

When the Intelligent auto mode is set to off, the Auto white balance and Auto focus operate and automatically adjust the color balance and focusing.

Depending on the brightness of the subject etc., the aperture and shutter speed are automatically adjusted for an optimum brightness.

- Color balance and focus may not be adjusted automatically depending on light sources or scenes. If so, manually adjust these settings. (→ 66)

Automatic white balance

White balance adjustment recognizes the color of light and adjusts so the white color will become a purer white. The unit determines the hue of light, thereby judging the recording condition, and selects the closest hue setting.

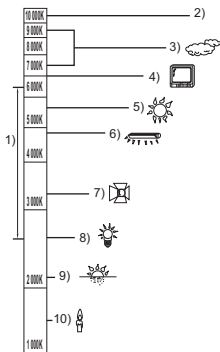

The illustration above shows the range over which the Auto white balance functions.

- 1) The effective range of automatic white balance adjustment on this unit
- 2) Blue sky
- 3) Cloudy sky (rain)
- 4) TV screen
- 5) Sunlight
- 6) White fluorescent lamp
- 7) Halogen light bulb
- 8) Incandescent light bulb
- 9) Sunrise or sunset
- 10) Candlelight

Automatic white balance adjustment does not function normally when there are multiple light sources or the light source is other than the stored white balance. In such cases, use the manual white balance adjustment mode.

Auto focus

The lens is moved forward or backward automatically to bring the subject into focus.

Auto focus has the following characteristics.

- Adjusts so that the vertical lines of a subject are seen more clearly.
- Attempts to bring an object with higher contrast into focus.

Auto focus does not work correctly in the following situations. Record pictures in the manual focus mode.

- Recording distant and close-up objects at the same time
- Recording a subject behind a dirty or dusty window
- Recording a subject that is surrounded by objects with glossy surfaces or by highly reflective objects
- Recording a subject in dark surroundings
- Recording a fast-moving subject
- Recording a subject with little contrast

Quick start

This unit will resume recording pause mode about 0.6 seconds after the LCD monitor is reopened.

- When in Quick Start Standby mode about 70% of the power used in Recording Pause mode is being consumed, so the recording time will be reduced.
- Start time will not shorten if there is no SD card inserted.

[HDC-TM10]

Start time will be shorten if the [Built-in Memory] is selected in the [MEDIA SELECT], even if there is no SD card inserted.

- ◇ Change the mode to .

1 Select the menu. (→ 29)

[SETUP] → [QUICK START] → [ON]

2 Close the LCD monitor while the mode is set to .

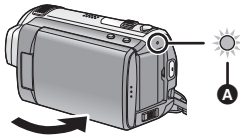

The status indicator **A** flashes green and the unit goes into quick start standby mode.

3 Open the LCD monitor.

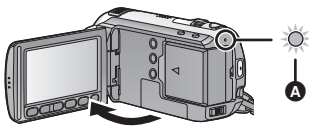

The status indicator **A** lights red and the unit is put into recording pause.

- Quick Start Standby Mode is canceled if
 - about 5 minutes have elapsed
 - mode is set to  with the LCD monitor closed.
- Time for Quick Start will be more than 0.6 seconds slower when the digital cinema is used.
- It may take some time for Automatic White Balance to adjust.
- In the Quick start mode, the zoom magnification becomes 1×.

- If [ECONOMY] (→ 31) is set to [5 MINUTES] and the unit automatically goes into Quick Start Standby Mode, close the LCD monitor and then open it again.
- Turn the unit off using the power button.

Quick power on

When the power is turned on with the mode set to , the unit will enter the recording pause mode after about 1.9 seconds.

- ◇ Change the mode to .

Select the menu. (→ 29)

[SETUP] → [QUICK POWER ON] → [ON]

- This function's default setting is [ON].
- In the Quick power on mode, the zoom magnification becomes 1×.

Recording motion pictures

VIDEO

This unit records high definition images that are compatible with the AVCHD format.

- Use an SD card that can be used for motion picture recording. (→ 24)
- Open the lens cover before turning on the power. (→ 17)

HDC-TM10 :

■ When selecting media

Select the menu. (→ 29)

[MEDIA SELECT] → [Built-in Memory] or [SD CARD]

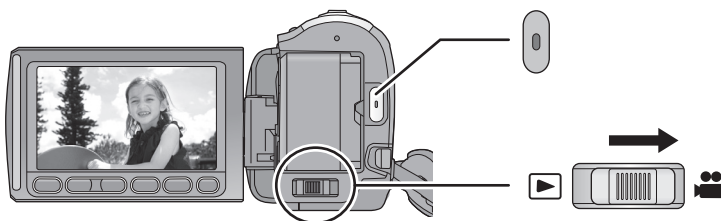

1 Change the mode to .

2 Open the LCD monitor.

You cannot start recording while the LCD monitor is closed.

- For users who have **HDC-SD10**, proceed to step 4.

3 **HDC-TM10**

Select the media to record from the menu.

Select whether to record motion pictures to the SD card or the built-in memory.

- You cannot set the recording media for motion pictures and still pictures separately.

4 Press the recording start/stop button to start recording.



- While recording is in progress, the recording will not stop even if the LCD monitor is closed.

5 Press the recording start/stop button again to pause recording.

About the compatibility of the recorded motion pictures

- They are not compatible with devices other than those that support AVCHD. Images cannot be played with equipment that does not support AVCHD (ordinary DVD recorders). Confirm that your equipment supports AVCHD by referring to the operating instructions.
- There are some cases where the recorded motion pictures cannot be played back, even if the device supports AVCHD. In such cases, play the recorded motion picture with this unit instead.

• Still pictures can be recorded while recording the motion picture. (→ 48)

- The images recorded between pressing the recording start/stop button to start recording and pressing it again to pause recording become one scene.
- Maximum number of recordable scenes: 3900
Maximum number of different dates: 200 (→ 74)
When either of them reaches to the maximum limit, additional scenes cannot be recorded.
(In the case of SD cards it is the maximum number of recordable scenes per card.)
- A continuous recording of motion picture data that exceeds 4 GB may momentarily stop at every 4 GB of data when played back with another device.

■ Screen indications in the recording mode



A Recording mode

B Remaining time left for recording

(When the remaining time is less than 1 minute, [R 0h00m] flashes red.)

C Recording time elapsed

Each time the unit is put into recording pause, the counter display will be reset to "0h00m00s".

Recording modes/approximate recordable time

Switch the picture quality of the motion pictures to be recorded.

Select the menu. (→ 29)

[RECORD SETUP] → [REC MODE] → desired setting

		HA*1	HG*2	HX*3	HE*4
SD card	1 GB	7 min	9 min	14 min	21 min
	2 GB	15 min	20 min	30 min	45 min
	4 GB	30 min	40 min	1 h	1 h 30 min
	6 GB	45 min	1 h	1 h 30 min	2 h 15 min
	8 GB	1 h	1 h 20 min	2 h	3 h
	12 GB	1 h 30 min	2 h	3 h	4 h 30 min
	16 GB	2 h	2 h 40 min	4 h	6 h
32 GB	4 h	5 h 20 min	8 h	12 h	
HDC-TM10 Built-in memory	8 GB	1 h	1 h 20 min	2 h	3 h

A Favors image quality

B Favors recording time

1 1920×1080: Motion pictures can be recorded with the highest picture quality.

*2 1920×1080: Motion pictures can be recorded with high picture quality.

*3 1920×1080: Motion pictures can be recorded with normal picture quality.

*4 1440×1080: Motion pictures can be recorded for a longer time.

* This means the highest quality for this unit.

● **The recording is in high definition picture quality in all recording modes.**

- Maximum continuously recordable time for one scene: 12 hours
- The recording is paused once when the recording time for one scene exceeds 12 hours, and the recording will automatically resume after a few seconds.
- If a recording with a lot movements is recorded, the recording time is reduced.
- The recordable time may be reduced if recording of short scene is repeated.
- Use time in the row of 4 GB in above table as a guideline for the time that can be copied onto one DVD disc (4.7 GB).

● **Recordable time using the battery (→ 21)**

- Mosaic-pattern noise may appear on a playback image in the following cases.
 - When there is a complicated pattern in the background
 - When the unit is moved too fast
 - When a subject with sharp movements has been recorded (Particularly if it has been recorded in HE mode.)

■ **Back up data periodically.**

The built-in memory is temporary storage. In order to avoid erasing data due to static electricity, electromagnetic waves, breakage, and failures, back up the data to a PC or DVD disc. (→ 96, 107)

PRE-REC

This prevents you from missing a shot.

This allows recording of the pictures and sound to start approximately 3 seconds before the recording start/stop button is pressed.

1 Press the PRE-REC button.

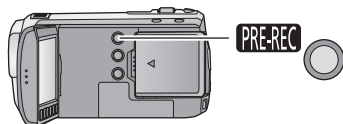

PRE-REC appears on the screen.

- Aim this unit at the subject and position it securely.

2 Press the recording start/stop button to start recording.

- There is no beep sound.
- After recording starts, the PRE-REC setting is canceled.

- PRE-REC is canceled in the following cases.

- If you change the mode.
- If you open the SD card cover.

([HDC-TM10])

If you open the SD card cover when the [MEDIA SELECT] is set to [SD CARD] in Recording mode.)

- If you press the MENU button.
- If you turn the unit off.
- When the remaining time left for recording motion pictures is less than 1 minute, PRE-REC cannot be set.
- If you start recording less than 3 seconds after pressing the PRE-REC button, or while the PRE-REC indication flashes within about 3 seconds after initiating the Quick Start operation, motion pictures taken 3 seconds before pressing the recording start/stop button cannot be recorded.
- When the recording start/stop button is pressed, image shake and operation sound may be recorded.
- Images displayed on the thumbnail in playback mode will differ from the motion pictures displayed at the start of playback.

Shooting guide

Message is displayed when this unit is moved rapidly.

Select the menu. (→ 29)

[RECORD SETUP] → [SHOOTING GUIDE]
→ [ON]

- This function's default setting is [ON].



When "CAMERA PANNING IS TOO FAST." appears, move the unit slowly while recording.

- Set to [OFF] to turn off the message indication.
- Message will not appear while pausing the recording. (Message will appear even if it is pausing the recording if [DEMO MODE] is set to [ON])
- In some recording conditions, messages may not appear.

Recording still pictures

PHOTO

The number of pixels recorded for still pictures is [2.1M] 1920×1080 [(16:9)]. Still pictures can also be recorded while recording motion pictures.

- Open the lens cover before turning on the power. (→ 17)

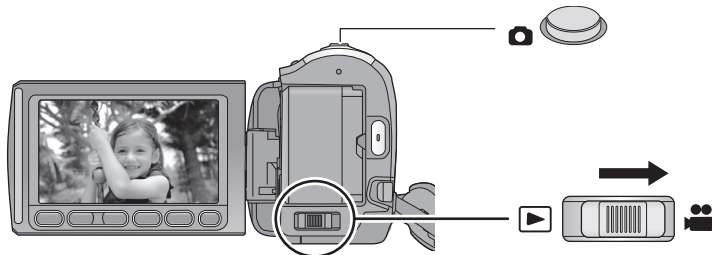

1 Change the mode to .

2 Open the LCD monitor.

- For users who have [HDC-SD10], proceed to step 4.

3 [HDC-TM10]

Select the media to record from the menu. (→ 42)

Select whether to record still pictures to the SD card or the built-in memory.

- You cannot set the recording media for motion pictures and still pictures separately.

4 Press the button halfway. (For auto focus only)

Focus indication appears and the unit focuses on the subject automatically.



- If you set the Optical Image Stabilizer function (→ 50) to Active mode/ON, then the image stabilizer function will be more effective. ([MEGA] (MEGA optical image stabilizer) will be displayed.)

Focus indication:

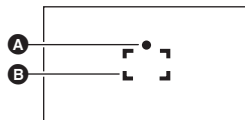

- **A** Focus indication
 - (The white lamp flashes.): Focusing
 - (The green lamp lights up.): When in focus
- No mark: When focusing is unsuccessful.
- **B** Focus area (area inside brackets)

5 Press the button fully.



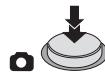





- In order to take better still pictures, the screen will brighten when the  button is fully pressed.



- The sound cannot be recorded while recording still pictures.
- The edges of still pictures recorded on this unit with a 16:9 aspect ratio may be cut at printing. Check the printer or photo studio before printing.

■ About the screen indications when the button is pressed



- : Flash (→ 63)
- : Flash level (→ 63)
- : Red eye reduction (→ 64)
- : Quality of still pictures
- : Size of still pictures
- R3000: Remaining number of still pictures (Flashes in red when [0] appears.)
- : Still picture operation indicator (→ 120)
- : MEGA optical image stabilizer (→ 46)
- : Optical image stabilizer (→ 50)

■ About the focus indication

- The focus indication indicates the status of the auto focus.
- The focus indication does not appear in Manual Focus Mode.
- The focus indication does not appear or has difficulty focusing in the following cases.
 - When the zoom magnification is high.
 - When the unit is shaken.
 - When the subject is moving.
 - When the subject stands in front of a light source.
 - When close subjects and far subjects are included in the same scene.
 - When the scene is dark.
 - When there is a bright part in the scene.
 - When the scene is filled with only horizontal lines.
 - When the scene lacks contrast.

■ About the focusing area

When there is a contrasting object ahead or behind the subject in the focus area, the subject may not be focused. If so, move the contrasting object out of the focus area.



- Focus area is not displayed in the following conditions.
 - When the Intelligent Auto (Portrait Mode) is used.
 - When the Digital Zoom (more than approx. 16×) is used.
 - When AF tracking is used.

Picture quality

Selecting the picture quality.

Select the menu. (→ 29)

[PICTURE] → [QUALITY] → desired setting

- : Still pictures with a high picture quality are recorded.
 - : Priority is given to the number of still pictures recorded. Still pictures are recorded in normal picture quality.
-
- If the [QUALITY] is set to , mosaic-pattern noise may appear on a playback image depending on the picture content.

Simultaneous recording (recording still pictures while recording motion pictures)

You can record still pictures even while recording motion pictures.



◇ Change the mode to .



While recording motion pictures, press the  button fully (press to the bottom) to take the picture.



- While recording motion pictures or during the PRE-REC operation, the following arrangements are applied so that motion picture recording takes preference over still picture recording. For vivid still pictures, we recommend pausing motion picture recording and taking still pictures after releasing the PRE-REC mode.
 - Image quality is different from ordinary still pictures.
 - Pressing the  button halfway is disabled.
 - The remaining usable capacity (number of pictures that can be taken) indication does not appear.

Number of recordable pictures

	Picture size	21M (1920×1080)	
			
SD card	8 MB	4	6
	16 MB	10	17
	32 MB	20	32
	64 MB	47	74
	128 MB	94	150
	256 MB	200	320
	512 MB	410	640
	1 GB	820	1290
	2 GB	1670	2630
	4 GB	3290	5160
	6 GB	5000	7860
	8 GB	6690	10520
HDC-TM10 Built-in memory	8 GB	6690	10520

- The numbers shown in the table are approximations.
- The number of recordable pictures depends on whether  and  are used together and on the subject being recorded.
- The memory capacity indicated on the label of an SD card is the total of the capacity for copyright protection and management and the capacity which can be used on the unit, a PC etc.

Zoom in/out function

The maximum optical zoom ratio is 16×.

◇ **Change the mode to**  .

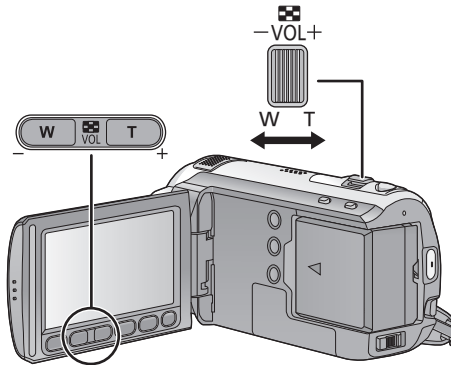

Zoom lever/Adjust zoom buttons

T side:

Close-up recording (zoom in)

W side:

Wide-angle recording (zoom out)

- The zoom speed varies depending on the range over which the zoom lever is moved.
- The adjust zoom buttons are useful for making fine adjustments to the zoom magnification.

Zoom mode

VIDEO **PHOTO**

Set the maximum optical zoom ratio. If the zoom magnification exceeds 16×, then the digital zoom function will be activated.

Select the menu. (→ 29)

[RECORD SETUP] → [ZOOM MODE] → desired setting

[Opt.Zoom 16×]:

Optical zoom (Up to 16×)

[D.Zoom 40×]:

Digital zoom (Up to 40×)

[D.Zoom 1000×]:

Digital zoom (Up to 1000×)

- This function's default setting is [Opt.Zoom 16×].
- The larger the digital zoom magnification, the more the image quality is degraded.

- If you take your finger off the zoom lever during zoom operation, the operation sound may be recorded. When returning the zoom lever to the original position, move it quietly.
- When the zoom magnification is 16×, the subjects are focused at approx. 1.2 m (3.9 feet) or more.
- When the zoom magnification is 1×, this unit can focus on a subject approx. 4 cm (1.6") away from the lens. (Macro function)
- The zoom speed does not vary when operating with the adjust zoom button.

Optical image stabilizer function

VIDEO PHOTO

Optical image stabilizer can stabilize the image without decreasing the image quality as much.

◇ Change the mode to  .

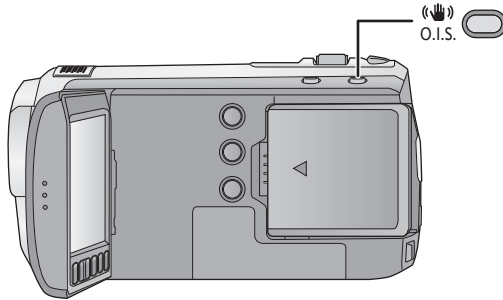

Optical image stabilizer button
Pressing the button changes the optical image stabilizer setting.

 →  → OFF

- Set the Intelligent Auto mode to off before setting the Optical Image Stabilizer function to off.



 : **Active mode**

This setting gives more stabilization and is suitable for recording when moving.

 : **ON**

This setting is suitable for recording in a stable state such as scenery.

O.I.S.: Optical Image Stabilizer

- This function's default setting is  (Active mode).
- When recording using the tripod, it is recommended to set to  (ON).
- Stabilization may not be possible under strong shaking conditions.

VIDEO PHOTO

It is possible to set the focus and exposure to the subject specified on the touch screen. The focus and exposure will keep following the subject automatically even if it moves. (Dynamic tracking)

◆ Change the mode to .

■ About target frame



1 Touch .



-  will be displayed on the screen.

2 Touch the object and lock the target.



- A** Target frame
- When you touch the head of the object, the target frame on the head gets locked and tracking starts.
 - Touch the object to be changed again when you want to change the target.
 - When the Intelligent auto mode is selected, the setting becomes  (normal) and touched object is tracked. Selection becomes  (portrait) when target frame is locked on a face.

3 Start recording.

- When you touch [RETURN], the tracking function will be canceled.



- When target lock fails, the target frame blinks in red and then disappears. In such cases, touch the object again and lock the target.
 - When the  button is pressed halfway, the focus is set to the object that is locked. The target frame turns green when it focuses, and the target cannot be changed.
-
- This function cannot be used in Manual mode.
 - When you touch an area which does not permit target locking, the available target lock range is displayed in a red frame.
 - It may track different objects or may not lock the target depending on the recording conditions such as the following:
 - When the object is too large or too small
 - When color of the object is similar to the background
 - When using zoom
 - When the camera is shaking
 - When more than one object overlaps
 - When the scene is dark
 - When the subject moves quickly
 - A message will be displayed when an object becomes unable to be tracked half-way through. In such cases, touch the object one more time.
 - AF tracking will be canceled in the following cases.
 - When the mode is changed
 - When the power is turned off
 - When the Scene mode is set
 - When the Intelligent auto mode is set to on/off
 - After setting [DISPLAY] to [OFF] if no operation is performed for a few seconds, the operation icon disappears. Touch the screen to display the icon again. When the AF tracking is used, the icon does not disappear.

Recording with the video light

VIDEO	PHOTO
-------	-------

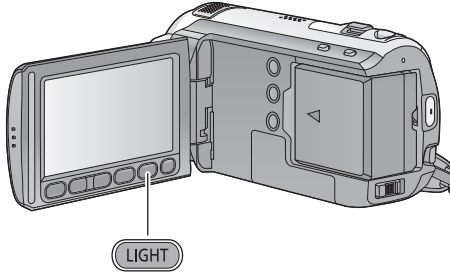

The video light enables brightening of the images taken in a dimly-lit place.

◇ Change the mode to  .



Video light button

Each time the button is pressed, the indication changes by one setting in the following order.



 →  /  → **Setting canceled**

 : Always on.

 /  :

Turns on/off automatically according to brightness of the surroundings.

- Lights up when the lens cover is closed.

- This function's default setting is  /  .
- Auto video light will turn on/off in conjunction with Low Light mode in Intelligent auto mode.
- Using the video light reduces battery time.
- The subject should be within 1.2 m (4 feet) of the unit.
- Do not look directly into the light.
- Using the MagicPix function at the same time will make conditions even brighter.
- If you turn off the power or change the mode, the video light is turned off.
- Set the video light to off where using a light is prohibited.



Recording functions of operation icons

Select the operation icons to add different effects to the images to be recorded.

◇ Change the mode to  .

1 Touch  to display the operation icons on the screen.













- Touch  to change the page and touch / to display/not-display the operation icon.

2 (e.g. Backlight compensation)
Select an operation icon.







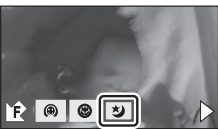



- Select the operation icon again to cancel the function.

Operation icons

<p> Backlight compensation</p> 	<p> Intelligent contrast control*</p> 	<p> Fade</p> 	<p> Soft skin mode*</p> 
<p> Tele macro</p> 	<p> MagicPix*</p> 		

* It is not displayed when the Intelligent auto mode is on.

- If you turn off the power or change the mode to  , MagicPix, Backlight compensation and tele macro functions are canceled.
- If you turn off the power, the Fade function is canceled.
- It is possible to set from the menu. (→ 30)
- After setting [DISPLAY] to [OFF] if no operation is performed for a few seconds, the operation icon disappears. Touch the screen to display the icon again.

Function	Effect
<p> Backlight compensation</p> <p><input type="checkbox"/> VIDEO <input type="checkbox"/> PHOTO</p>	<p>This makes the image brighter to prevent darkening of a backlit subject.</p>
<p> Intelligent contrast control</p> <p><input type="checkbox"/> VIDEO <input type="checkbox"/> PHOTO</p>	<p>This brightens parts that are in shadow and difficult to see and suppresses white saturation in bright parts at the same time. Both bright and dark parts can be recorded clearly.</p>
<p> Fade</p> <p><input type="checkbox"/> VIDEO</p> <p>(Fade in)</p>  <p>(Fade out)</p> 	<p>When you start recording, the image/audio gradually appears. (Fade in) When you pause recording, the image/audio gradually disappears. (Fade out)</p> <ul style="list-style-type: none"> • The Fade setting is canceled when the recording stops. <p>■ To select the color for Fade in/out Select the menu. (→ 29) [RECORD SETUP] → [FADE COLOR] → [WHITE] or [BLACK]</p>
<p> Soft skin mode</p> <p><input type="checkbox"/> VIDEO <input type="checkbox"/> PHOTO</p>	<p>This makes skin colors appear softer for a more attractive appearance. This is more effective if you record a person closely from the torso up.</p>
<p> Tele macro</p> <p><input type="checkbox"/> VIDEO <input type="checkbox"/> PHOTO</p>	<p>A more impressive image can be obtained by focusing on the object only in closeup and shading off the background.</p> <ul style="list-style-type: none"> • The unit can focus on the subject at a distance of approx. 50 cm (20"). • If the magnification is 16× or less, then it is automatically set to 16×.
<p> MagicPix</p> <p><input type="checkbox"/> VIDEO <input type="checkbox"/> PHOTO</p>	<p>This function allows you to record color images in very low light situations. (Minimum required illumination: approx. 1 lx)</p>

 **Intelligent contrast control:**

- If there are extremely dark or bright parts or the brightness is insufficient, the effect may not be clear.

 **Fade:**

- The thumbnails of scenes recorded using fade in become black (or white).

 **Soft skin mode:**

- If the background or anything else in the scene has colors similar to the skin color, they will also be smoothed.
- If the brightness is insufficient, the effect may not be clear.
- If you record a person in the distance, the face may not be recorded clearly. In this case, cancel Soft Skin mode or zoom in on the face (close-up) to record.

 **Tele macro:**











- The tele macro function is canceled when the zoom magnification becomes lower than 16×.



 **MagicPix:**

- **Recorded scene is seen as if frames were missed.**
- If set in a bright place, the screen may become washed out for a while.
- Bright dots that are usually invisible may be seen, but this is not a malfunction.
- Using a tripod is recommended.
- In darker areas, Auto Focus may focus a bit slower. This is normal.



Recording functions of menus

◇ Change the mode to  .

Function	Effect/Setting method
<p>Scene mode</p> <p> </p>	<p>When you record images in different situations, this mode automatically sets optimum shutter speeds and apertures.</p> <hr/> <p>Select the menu. (→ 29) [RECORD SETUP] → [SCENE MODE] → desired setting</p> <hr/> <p> Sports: To make fast moving scenes less shaky with slow playback and pause of playback</p> <p> Portrait: To make people stand out against the background</p> <p> Spotlight: Improved quality when subject is brightly illuminated.</p> <p> Snow: Improved image quality when shooting in snowy locations.</p> <p> Beach: To make blue in the sea or sky vibrant</p> <p> Sunset: To make red in the sunrise or sunset vibrant</p> <p> Fireworks: To capture the fireworks in the night sky beautifully</p> <p> Scenery: For spatial scenery</p> <p> Low light: For dark scenes, such as at dusk</p> <ul style="list-style-type: none"> • Set [SCENE MODE] to [OFF] to cancel the function.







Function	Effect/Setting method
<p>Guide line</p> <p>VIDEO PHOTO</p> 	<p>You can check if the image is level while recording or playing back motion pictures and still pictures. The function can also be used to estimate the balance of the composition.</p> <hr/> <ul style="list-style-type: none"> • The Intelligent auto mode is set to off. (→ 39) <p>Select the menu. (→ 29) [RECORD SETUP] → [GUIDE LINES] → desired setting</p> <p>When motion picture playback is selected while the mode is set to . (→ 70) [VIDEO SETUP] → [GUIDE LINES] → desired setting</p> <ul style="list-style-type: none"> • The guide lines do not appear on the images actually recorded. • Set to [OFF] to cancel the guide line.
<p>Digital cinema</p> <p>VIDEO</p>	<p>Use this function to record an image with vivid color, like an image on a movie film.</p> <hr/> <ul style="list-style-type: none"> • The Intelligent auto mode is set to off. (→ 39) • Set the recording mode to HA or HG. (→ 44) <p>Select the menu. (→ 29) [RECORD SETUP] → [DIGITAL CINEMA] → [ON]</p> <ul style="list-style-type: none"> • The shutter speed is 1/48 or more. (When [AUTO SLOW SHTR] is [ON], it is 1/24 or more.) • The images may not appear smooth.







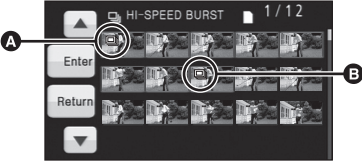







Function	Effect/Setting method
<p data-bbox="98 130 206 150">HDC-TM10</p> <p data-bbox="87 153 288 180">Relay recording</p> <p data-bbox="292 185 361 205">VIDEO</p>	<p data-bbox="389 122 1005 172">It is possible to continuously record motion picture to an SD card when there is no space available in the built-in memory.</p> <hr/> <p data-bbox="389 205 689 232">Select the menu. (→ 29)</p> <p data-bbox="389 236 824 260">[RECORD SETUP] → [RELAY REC] → [ON]</p> <ul data-bbox="389 263 1025 655" style="list-style-type: none"> • ⇨ □ is displayed on the screen. ⇨ □ will disappear when space in the built-in memory is gone and the recording to the SD card starts. • It allows you to record only to SD card from built-in memory. • Relay recording can only be performed once. • Combine the scenes that were relay recorded using the [RELAY SCENE COMBINE] into the SD card. (→ 88) • Once the relay recorded scene and the scene that was recorded on the SD card after that are combined into the SD card using the [RELAY SCENE COMBINE], it will be possible to perform the relay recording again. If the [RELAY REC] is set to [ON] without performing the [RELAY SCENE COMBINE], a message is displayed. You will be able to perform relay recording by touching [YES], but you will not be able to perform the [RELAY SCENE COMBINE] after that.
<p data-bbox="87 675 337 765">Auto Ground-Directional Standby (AGS)</p> <p data-bbox="292 769 361 790">VIDEO</p> 	<p data-bbox="389 675 1014 749">If the unit continues to be tilted upside down from the normal horizontal position while recording motion pictures, it is automatically put into recording pause.</p> <hr/> <p data-bbox="389 782 689 809">Select the menu. (→ 29)</p> <p data-bbox="389 813 748 837">[RECORD SETUP] → [AGS] → [ON]</p>



Function	Effect/Setting method
<p>Auto slow shutter</p> <p>VIDEO PHOTO</p>	<p>You can record bright pictures even in dark places by slowing the shutter speed.</p> <hr/> <ul style="list-style-type: none"> • The Intelligent auto mode is set to off. (→ 39) <p>Select the menu. (→ 29) [RECORD SETUP] → [AUTO SLOW SHTR] → [ON]</p> <ul style="list-style-type: none"> • The shutter speed is set to 1/30 or more depending on the surrounding brightness.
<p>Automatic face framing</p> <p>VIDEO PHOTO</p> <p>[OFF]: Not display</p> <p>[PRIMARY]: Only the prioritized face framing is displayed.</p> <p>[ALL]: All face detection framings are displayed.</p> 	<p>In the Intelligent auto mode, detected faces appear with frames.</p> <hr/> <p>Select the menu. (→ 29) [RECORD SETUP] → [FACE FRAMING] → desired setting</p> <ul style="list-style-type: none"> • This function's default setting is [ALL]. • Up to 15 frames are indicated. Larger faces and faces nearer to the center of the screen take preference over others. <p>■ Prioritized face framing</p> <p>Prioritized face framing is displayed in orange. Focus and adjustment of brightness will be performed against the prioritized face framing.</p> <ul style="list-style-type: none"> • Focus will be set to prioritized face framing when the  button is pressed halfway when recording still pictures. Prioritized face framing will turn to green when the focus is set.

Function	Effect/Setting method
Digital cinema color <div style="border: 1px solid black; padding: 2px; display: inline-block;">VIDEO</div>	<p>Recording motion pictures with more vivid colors, using x.v.Color™ technology.</p> <hr/> <ul style="list-style-type: none"> • The Intelligent auto mode is set to off. (→ 39) <p>Select the menu. (→ 29) [RECORD SETUP] → [Digital Cinema Color] → [ON]</p> <ul style="list-style-type: none"> • For more realistic colors, use an HDMI mini cable with a TV that supports the x.v.Color™.
Wind noise reduction <div style="border: 1px solid black; padding: 2px; display: inline-block;">VIDEO</div>	<p>This is for reducing the wind noise coming into the built-in microphones depending on the wind strength.</p> <hr/> <ul style="list-style-type: none"> • The Intelligent auto mode is set to off. (→ 39) <p>Select the menu. (→ 29) [RECORD SETUP] → [WIND CUT] → [ON]</p> <ul style="list-style-type: none"> • This function's default setting is [ON].
Zoom microphone <div style="border: 1px solid black; padding: 2px; display: inline-block;">VIDEO</div>	<p>Directivity of the microphone is synchronized with the zoom operation. Sounds near the front of the unit are recorded more clearly if you zoom in (close-up) and surrounding sounds are recorded more realistically if you zoom out (wide angle).</p> <hr/> <ul style="list-style-type: none"> • The Intelligent auto mode is set to off. (→ 39) <p>Select the menu. (→ 29) [RECORD SETUP] → [ZOOM MIC] → [ON]</p>

Function	Effect/Setting method
<p>Microphone level</p> <p style="text-align: right;">VIDEO</p> <p>[AUTO]: AGC is activated, and the recording level is adjusted automatically.</p> <p>[SET+AGC]/[SET]: The desired recording level can be set.</p> <p>AGC: Auto Gain Control</p>	<p>When recording, the input level from the built-in microphones can be adjusted.</p> <hr/> <ul style="list-style-type: none"> • The Intelligent auto mode is set to off. (→ 39) <p>1 Select the menu. (→ 29) [RECORD SETUP] → [MIC LEVEL] → [SET+AGC]/[SET]</p> <p>2 Touch ◀/▶ to adjust the microphone input level.</p> <div data-bbox="532 399 890 603" data-label="Image"> </div> <ul style="list-style-type: none"> • Touch AGC to activate/disactivate AGC. When AGC is activated, the icon is surrounded by yellow and the amount of sound distortion can be reduced. When AGC is disactivated, natural recording can be performed. • A gain value for each of the 2 directions is displayed. (The input level of the microphones cannot be set individually.) • Adjust the microphone input level so that the last 2 bars of the gain value are not red. (Otherwise, the sound is distorted.) Select a lower setting for microphone input level. <p>3 Touch [ENTER] to determine the microphone input level and then touch [EXIT].</p> <div data-bbox="548 1034 873 1207" data-label="Image"> </div> <ul style="list-style-type: none"> • Microphone input level meter



Function	Effect/Setting method
<p>Hi-speed burst shooting</p> <p style="text-align: right;">PHOTO</p> <p>[24 frames/sec] 72 still pictures are recorded continuously at the rate of 24 per second. The picture size is 2.1M (1920×1080).</p> <p>[60 frames/sec] 180 still pictures are recorded continuously at the rate of 60 per second. The picture size is 0.9M (1280×720).</p>	<p>Recording is done continuously at the rate of 24 or 60 still pictures per second. Use this function to record an object with fast movement.</p> <hr/> <ul style="list-style-type: none"> • The Intelligent auto mode is set to off. (→ 39) <p>1 Select the menu. (→ 29) [PICTURE] → [HI-SPEED BURST] → desired setting</p> <p>2 Press the  button.</p> <ul style="list-style-type: none"> •  flashes in red during recording. • First press the  button halfway, then press it fully to set the focus and record. It will automatically focus if you press fully once, so it is convenient when recording objects moving back and forth. <p>3 Touch [Record] or [Delete].</p>  <p>[Record]: Pictures are stored. [Delete]: All pictures are deleted.</p> <p>4 (Only when [Record] is selected in step 3) Touch [REC ALL] or [SELECT].</p> <p>[REC ALL] :All pictures are stored. [SELECT] :Pictures are stored by specifying range.</p> <p>5 (Only when [SELECT] is selected in step 4) Touch the range of pictures that will be stored.</p>  <ul style="list-style-type: none"> A Start point* B Finish point <ul style="list-style-type: none"> • Previous (Next) page is displayed by touching  / . <p>* Only select the picture for start point if only 1 picture is to be stored.</p> <p>A confirmation message is displayed when [Enter] is touched after selecting the start point and finish point. Touch [YES] to store the pictures.</p> <ul style="list-style-type: none"> • Set [HI-SPEED BURST] to [OFF] to cancel the function.

Function	Effect/Setting method
<p>Self-timer</p> <p style="text-align: right; border: 1px solid black; padding: 2px;">PHOTO</p>	<p>This is for recording still pictures using the timer.</p> <hr/> <p>Select the menu. (→ 29) [PICTURE] → [SELF TIMER] → [10 SECONDS] or [2 SECONDS] [10 SECONDS]: Records after 10 seconds [2 SECONDS]: Records after 2 seconds</p> <ul style="list-style-type: none"> • When the  button is pressed, a still picture is recorded after the  10 or  2 display and the recording lamp flash for the time which has been set. • After recording, the self-timer is canceled. • In Auto focus mode, if the  button is pressed halfway once and then fully, the lens focuses on the subject when the button is pressed halfway. • If the  button is pressed fully all at once, the lens focuses on the subject just before recording. <hr/> <p>To stop the timer midway through Press the MENU button.</p>
<p>Built-in flash</p> <p style="text-align: right; border: 1px solid black; padding: 2px;">PHOTO</p>	<p>When the  button is pressed, the flash is activated and the picture will be recorded. Use the built-in flash in order to record still pictures in dark places.</p> <hr/> <p>Select the menu. (→ 29) [PICTURE] → [FLASH] → [ON] or [AUTO]</p> <ul style="list-style-type: none"> • This function's default setting is [AUTO]. • When the  button is pressed halfway, the flash indicator will appear on the screen. <p>[ON]:  [AUTO]:  [OFF]: </p> <ul style="list-style-type: none"> • The unit automatically determines if the flash is necessary even when it has been set to [OFF] by detecting the ambient brightness. (If it determines that the flash is necessary, the  indication lights up in red when the  button is pressed halfway.) <p>■ To adjust the brightness of the flash</p> <ul style="list-style-type: none"> • The Intelligent auto mode is set to off. (→ 39) <p>Select the menu. (→ 29) [PICTURE] → [FLASH LEVEL] → desired setting</p> <p> -: Less bright  ± 0: Normal  +: Much brighter</p>

Function	Effect/Setting method
Red eye reduction 	Reduces the phenomena where human eyes become red from flashes. <hr/> <ul style="list-style-type: none"> • The Intelligent auto mode is set to off. (→ 39) Select the menu. (→ 29) [PICTURE] → [RED EYE] → [ON]
Shutter sound 	You can add a shutter sound when recording still pictures. <hr/> Select the menu. (→ 29) [PICTURE] → [SHTR SOUND] → [ON] <ul style="list-style-type: none"> • This function's default setting is [ON].

Scene mode:

Sports

- During normal playback, the image movement may not look smooth.
- Color and screen brightness may change under indoor lighting.
- If the brightness is insufficient, the Sports mode does not function. The  /  display flashes.

Portrait

- Color and screen brightness may change under indoor lighting.

Sunset

- The shutter speed is 1/30 or more. (When [DIGITAL CINEMA] is [ON], it is 1/24 or more.)
- Image may get blurry when a close object is recorded.

Fireworks

- The shutter speed is 1/30. (When [DIGITAL CINEMA] is [ON], it is 1/24.)
- Image may get blurry when a close object is recorded.
- Image may get washed out when recorded in bright surroundings.

Scenery

- Image may get blurry when a close object is recorded.

Low light

- The shutter speed is 1/30 or more. (When [DIGITAL CINEMA] is [ON], it is 1/24 or more.)

Digital cinema:

- Recordings made with [DIGITAL CINEMA] are converted and recorded as 60i.



Relay recording:

- It does not allow the relay recording of still pictures. However, even still pictures are recorded to the SD card after relay recording.
-  is displayed on the thumbnail display during the playback of a scene that was relay recorded on the built-in memory.

Auto Ground-Directional Standby:

- The AGS function may activate and cause the unit to pause the recording if you are recording a subject right above or right below you.

Auto slow shutter:

- When the shutter speed becomes 1/30, the screen may be seen as if frames are missed and afterimages may appear.

Digital cinema color:

- When motion pictures recorded while this function is turned [ON] are played back with a TV not compatible with x.v.Color™, colors may not be reproduced properly.
- To play back images recorded in Digital cinema color with vivid colors of wider color ranges, a device compatible with x.v.Color™ is required. When these images are played back with devices other than ones compatible with x.v.Color™, it is recommended to record the images after this function is turned [OFF].
- x.v.Color™ is a name for devices that are compatible with the xvYCC format, an international standard for expanded color in motion pictures, and that follow the rules for signal transmission.

Wind noise reduction:

- When the Intelligent auto mode is set to on, [WIND CUT] is set to [ON], and the setting cannot be changed.
- The sound quality may be changed if this function is activated in strong winds.

Microphone level:

- When the Intelligent auto mode is on, the setting is fixed to [AUTO] and cannot be changed.
- When [ZOOM MIC] is [ON], the volume will be different depending on the zoom rate.
- The microphone input level meter shows the largest volume for the microphones.
- You cannot record with the audio completely muted.



Hi-speed burst shooting:

- If you turn off the power or change the mode, this function is canceled.
- The maximum number of times you can record on a media is 15.
(In the case of SD cards it is the maximum number of recordable scenes per card.)
- Color balance and brightness on the screen may change with some light sources such as fluorescent lamps.
- Image quality is different from ordinary still picture recording.

Self-timer:

- The self-timer standby mode is canceled in the following cases.
 - If you turn the unit off.
 - If you change the mode.
 - If you press the recording start/stop button to start motion picture recording.
- Setting the self-timer to [2 SECONDS] is a good way to prevent image shake when the  button is pressed while using a tripod etc.

Built-in flash:

- Set the flash to [OFF] where using a flash is prohibited.
- If the  indication etc. flashes when the  button is pressed halfway, the flash is not activated.
- The available range of the flash is approx. 1 m to 2.5 m (3.3 feet to 8.2 feet) in dark places.
- Using the flash fixes a shutter speed to 1/500 or slower.

Red eye reduction:

- The flash is activated 2 times.
- Red eye phenomenon may appear depending on the recording conditions.
- When faces are detected in the Intelligent auto mode, the red eye reduction is set to on.

Manual recording

Touch the operation icon to adjust white balance, shutter speed, iris and manual focus.

◇ **Change the mode to**  .

Press the MANUAL button.

- **MNL** appears on the screen.

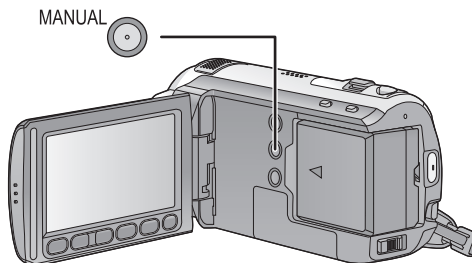

Perform the setting by touching the desired item to be set.

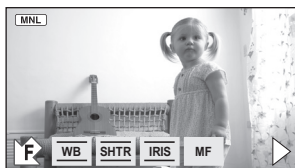

- Touch ► to change the page and touch  to display/not-display the operation icon.

 White balance (→ 67)

 Manual shutter speed (→ 68)

 Aperture adjustment (→ 68)

 Manual focus (→ 69)

White balance

VIDEO PHOTO

The automatic white balance function may not reproduce natural colors depending on the scenes or lighting conditions. If so, you can adjust the white balance manually. The unit can record pictures in a natural hue if it can recognize the reference color white.





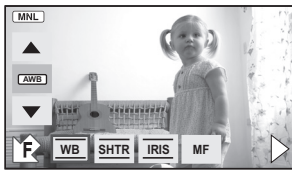

- Press the **MANUAL** button. (→ 66)

1 Touch [WB].

2 Touch / to select White Balance mode.



- Select the optimal mode by confirming the color on the screen.

Icon	Mode/Recording conditions
	Auto white balance adjustment
	Sunny mode Outdoors under a clear sky
	Cloudy mode Outdoors under cloudy sky
	Indoor mode 1 Incandescent light, video lights like in the studio, etc.
	Indoor mode 2 Color fluorescent lamps, sodium lamps in gymnasiums etc.
	Manual adjustment mode <ul style="list-style-type: none"> • Mercury-vapor lamps, sodium lamps, some fluorescent lights • Lights used for wedding receptions at hotels, stage spotlights in theaters • Sunrise, sunset, etc.

- Set the white balance mode to **AWB** or press the **MANUAL** button again to restore to the automatic adjustment.

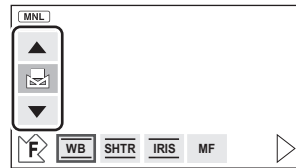

■ To set the white balance manually

- 1 Select , fill the screen with a white subject.

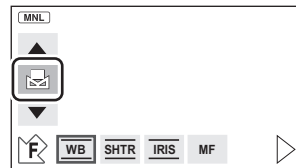

- 2 Touch and set the blinking .



- When the screen turns black instantly and the  display stops flashing and then lights constantly, the setting is complete.
- If the  display continues flashing, the white balance cannot be set. In this case, use other white balance modes.

- If you turn on the power with the lens cover closed, the auto white balance will not be performed correctly. Always open the lens cover before turning on the power.
- When the  display flashes, the manual white balance previously adjusted is stored. Whenever recording conditions change, re-set the white balance.
- When setting both the white balance and the iris/gain, set the white balance first.
- **AWB** is not displayed on the screen when **AWB** is being set.

Shutter Speed:

Adjust it when recording fast-moving subjects.

Iris:

Adjust it when the screen is too bright or too dark.

- Press the **MANUAL** button. (→ 66)

1 Touch [SHTR] or [IRIS].

2 Touch ▲/▼ to adjust settings.



SHTR Shutter speed:

1/60 to 1/8000

- If [AUTO SLOW SHTR] is set to [ON], the shutter speed will be set between 1/30 and 1/8000.
- If [DIGITAL CINEMA] is set to [ON], the shutter speed will be set between 1/48 and 1/8000. (When [AUTO SLOW SHTR] is set to [ON], the range is 1/24 to 1/8000.)
- The shutter speed closer to 1/8000 is faster.

IRIS Iris/Gain value:

CLOSE → (F16 to F2.0) → OPEN → (0dB to 18dB)

- Value closer to [CLOSE] darkens the image.
 - Value closer to [18dB] brightens the image.
 - When the iris value is adjusted to brighter than [OPEN], it changes to the gain value.
 - Press the **MANUAL** button again to restore to the automatic adjustment.
-
- When setting both the shutter speed and the iris/gain value, set the shutter speed and then set the iris/gain value.

Manual shutter speed adjustment

- If you increase the shutter speed manually, the noise on the screen may increase.
- You may see a band of light around an object that is shining very bright, or highly reflective.
- During normal playback, image movement may not look smooth.
- If you record an extremely bright object or record under indoor lighting, color and screen brightness may change or a horizontal line may appear on the screen. In this case, record in auto mode or set the shutter speed to 1/60 in areas where the power supply frequency is 60 Hz, or 1/100 in areas of 50 Hz.

Manual iris/gain adjustment

- If the gain value is increased, the noise on the screen increases.
- Depending on the zoom magnification, there are iris values that are not displayed.

Manual focus adjustment

VIDEO PHOTO

If auto focusing is difficult due to the conditions, then use manual focus.

- Press the **MANUAL** button. (→ 66)

1 (When MF assist function is used)
Select the menu. (→ 29)

[RECORD SETUP] → [MF ASSIST] → [ON]

- This function's default setting is [ON].

2 Touch [MF] icon.



- In Manual Focus mode, [AF] icon appears on the screen.

3 Adjust the focus by touching MF + / MF -

MF + / MF -



The center of the screen is enlarged. The normal screen returns approximately 2 seconds after you finish bringing the subject into focus.

- The center of the screen is not enlarged when [MF ASSIST] is [OFF].
- To return to Auto Focus, touch [AF] icon or press the **MANUAL** button again.
- MF assist does not work when the digital zoom is used.
- The part of the screen that is enlarged is not enlarged on the image actually recorded.

Picture adjustment

VIDEO PHOTO

Adjust the quality of the image while recording. Adjust by outputting to a TV while adjusting the quality of the image.

- Press the **MANUAL** button. (→ 66)

1 Select the menu. (→ 29)

[RECORD SETUP] → [PICTURE ADJUST] → [YES]

2 Touch the desired setting items.

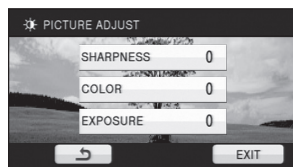

[SHARPNESS]:

Sharpness of the edge

[COLOR]:

Depth of the color of the image

[EXPOSURE]:

Brightness of the image

3 Touch ◀/▶ to adjust settings.



- After adjustments are made, if no operations are performed for a few seconds, the bar will disappear.

4 Touch [ENTER].

- Touch [EXIT] or press the **MENU** button to complete the settings. ✖ appears on the screen.

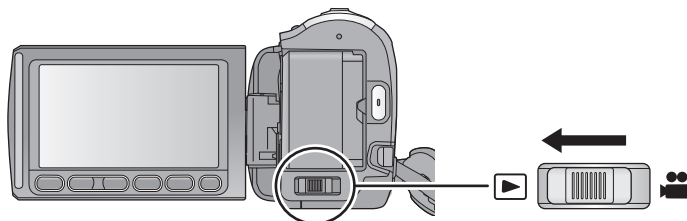

1 Change the mode to .

2 Touch the play mode select icon  to select desired media to be played back.





- Touch [VIDEO/SD CARD] to play back the SD card.

 (HDC-TM10)

Touch [VIDEO/Built-in Memory] to play back the built-in memory.



3 Touch the scene to be played back.



- Next (previous) page can be displayed by touching /.

4 Select the playback operation by touching the operation icon.



- ▶/||: Playback/Pause
- ◀◀: Rewind playback
- ▶▶: Fast forward playback
- : Stops the playback and shows the thumbnails.
- ▶: Displays the direct playback bar. (→ 72)
- Touch / to display/not-display the operation icon.

■ Change the thumbnail display

During step 3, the thumbnail display changes in the following order if the zoom lever is operated to + side or - side.

20 scenes ↔ 9 scenes ↔ 1 scene
↔ Highlight&Time frame index



- Refer to page 73 for information about Highlight&Time frame index.
- 9 scenes display returns if the power is turned off or the mode is changed.
- It is possible to operate with the adjust zoom button.
- Switch to 1 scene display to check the recording date and recording time.

■ Speaker volume adjustment

Move the volume lever to adjust the speaker volume during playback.

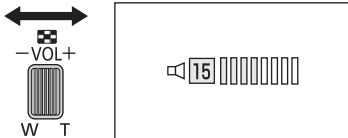

Towards “+”:

Increases the volume

Towards “-”:

Decreases the volume

- It is possible to operate with the adjust zoom button.

■ Fast forward/rewind playback

Touch ►► during playback to fast forward.
(Touch ◀◀ to rewind.)



- The fast forward/rewind speed increases if you touch ►►/◀◀ again. (The display on the screen changes from ►► to ►►►.)
- Normal playback is restored when you touch ►/||.

■ Slow-motion playback

1 Pause the playback.

- When the operation icon disappears, touch the screen to display the icon again.

2 Continue touching ►/||.

(◀◀ is for slow rewind playback)
Playback is slow while touching.



- Normal playback is restored when you touch ►/||.
- When slow-motion pictures are played back in reverse, they will be shown continuously at approximately 2/3rd the speed of normal playback (intervals of 0.5 seconds).

■ Frame-by-frame playback

The motion picture is advanced one frame at a time.

1 Pause the playback.

- When the operation icon disappears, touch the screen to display the icon again.

2 Touch .

(Touch  to advance the frames one at a time in the reverse direction.)



- Normal playback is restored when you touch .
- When the frames are advanced one at a time in the reverse direction, they will be shown in intervals of 0.5 seconds.

■ Direct playback

1 Touch to display the direct playback bar.



2 Touch the direct playback bar **A**.



- The playback is paused and the image is skipped until the position you touched.
- Playback starts again when you release the touch screen.
- Touch  to display the operation icon.

Motion picture compatibility

- This unit is based on the AVCHD format.
- The video signal that can be played back on this unit is 1920×1080/60i, 1920×1080/24p or 1440×1080/60i.
- This unit may degrade or not play back motion pictures recorded or created on other products, and other products may degrade or not play back motion pictures recorded on this unit, even if the products support AVCHD.

- Sound will be heard only during normal playback.
- If pause play is continued for 5 minutes, the screen returns to the thumbnails.
- Any scenes where the thumbnails are displayed as  cannot be played back.
- The elapsed time for playback indication will be reset to "0h00m00s" for each scene.

Creating still picture from motion picture

A single frame from the recorded motion picture can be saved as a still picture.

1 Pause at the scene you want to save as a still picture during playback.

- It is convenient to use slow-motion playback and frame-by-frame playback.

2 Press the button fully.

Still picture is recorded.

(HDC-TM10)

Still picture is recorded and will be saved on the same media as the motion picture.)

- Date the motion picture was recorded will be registered as date of the still picture.
- Quality will be different from the normal still picture.

Highlight&Time frame index

An image of one scene is displayed as a thumbnail at set time interval. Scene can be played back from any midway point of the scene you wish to see.

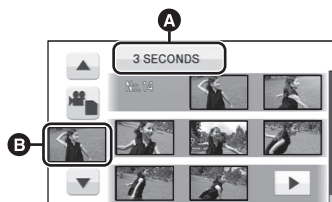

- Move the zoom lever to + side and change over the thumbnail display to Highlight&Time frame index. (→ 71)

1 Touch the set time selection.



A Set time selection

B Scene selection

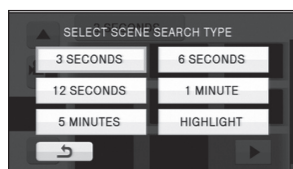

- Next (previous) scene can be displayed by touching /.

2 Touch and select time to be set.



- A portion judged to be clearly recorded will be detected and displayed in thumbnail if you select [HIGHLIGHT]. The thumbnail may not be displayed if the part recognized as clearly recorded cannot be detected.

3 Touch the thumbnail to be played back.

- Next (previous) thumbnail can be displayed by touching /.

Playing back motion pictures by date

Scenes recorded on the same day can be played back in succession.

1 Touch the date select icon.

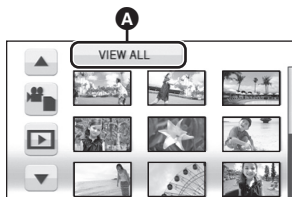

A Date select icon

2 Touch the playback date.



The scenes recorded on the date selected are displayed as thumbnails.

3 Touch the scene to be played back.

- Playing back of all the scenes returns if the power is turned off or the mode is changed.
 - Even if scenes are recorded on the same day, they are grouped separately in the following cases.
 - When the number of scenes exceeds 99
 - When the media is repaired
 - When the recording mode is changed from HA/HG/HX to HE* or HE to HA/HG/HX*
- * -1, -2... is added after the recording date displayed on the screen.

Intelligent scene selection

Play back the scenes excluding a portion of the scene judged to have failed to shoot due to fast movement of this unit, camera shake, or focus error.

1 Touch .



2 Touch [INTEL. SCENE].

3 Touch the scene to be played back.

- Up to 9 sections can be skipped for a single scene.
- When motion pictures are skipped, the image stops momentarily.
- The position of sections to be skipped may vary depending on the type of recording, with some having no skipped parts.
- Divided scene will not be skipped.
- Playing back all the scenes returns if the power is turned off or the mode is changed.
- For data that are edited with the editing function of HD Writer AE 1.5, the Intelligent scene selection is disabled.
- Deletion of scenes cannot be done during the Intelligent scene selection.
- Highlight&Time frame index display does not appear.

Highlight playback

Part that was recognized as clearly recorded is extracted from a long recording, and it can be played back in short time with music added.

1 Touch .



2 Touch [HIGHLIGHT].

3 Touch the desired item.

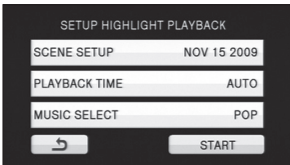

[SCENE SETUP]:

Select the scene or date to be played back.

[PLAYBACK TIME]:

Select the time to play back. (→ 76)

[MUSIC SELECT]:

Select the music to be played on playback.
(→ 76)

4 Touch [START].

- The playback time is displayed, and the unit is put into playback pause.

5 Select the playback operation. (→ 70)



- When the playback is finished or stopped, the screen to select [REPLAY], [SELECT AGAIN] or [EXIT] is displayed.
Touch the desired item.

■ Scene setting

- 1) Touch [SELECT SCENES] or [SELECT DATE].



- 2) (When [SELECT SCENES] is selected)
Touch the scene to be played back.

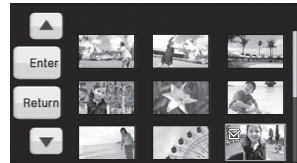

- Up to 99 scenes can be selected in succession.
- When touched, the scene is selected and ✓ is displayed. Touch the scene again to cancel the operation.

(When [SELECT DATE] is selected)
Touch the date to be played back.



- A maximum of 7 days can be selected.
 - When touched, the date is selected and surrounded by red.
Touch the date again to cancel the operation.
- 3) Touch [Enter]/[ENTER] to complete the settings.

■ Playback time setting

Touch the playback time to set.

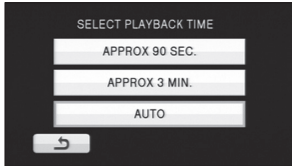

- The playback time of [AUTO] is a maximum of approx. 5 minutes.
- Playback time may become shorter than the setting, or it may not even play back if the part recognized as clearly recorded is short.

■ Music setting

1) Touch your favorite music.

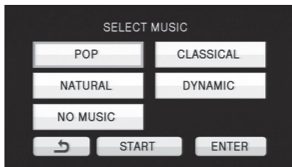

- When [NO MUSIC] is selected, the audio recorded at the time of shooting is played back.
- 2) Touch [ENTER].

To test the music audio:

Touch [START] and start the audio testing.



- Touch the other music option to change the music to be tested.
- When you touch [STOP], the music playback stops.
- When you touch [ENTER], the music being tested is set.

-
- The scene in the vicinity of the split may not play back when the scene is split. (→ 82)
 - Playing back of all the scenes returns if the power is turned off or the mode is changed.

Repeat playback

Playback of the first scene starts after playback of the last scene finishes.

Select the menu. (→ 29)

[VIDEO SETUP] → [REPEAT PLAY] → [ON]

The  indication appears on the full screen views.

- All the scenes are played back repeatedly. (When playing back motion pictures by date, all the scenes on the selected date are played back repeatedly.)

Resuming the previous playback

If playback of a scene was stopped halfway, the playback can be resumed from where it was stopped.

Select the menu. (→ 29)

[VIDEO SETUP] → [RESUME PLAY] → [ON]

If playback of a motion picture is stopped,  appears on the thumbnail view of the stopped scene.

- This function's default setting is [ON].

-
- The memorized resume position is cleared if you turn off the power or change the mode. (The setting of [RESUME PLAY] does not change.)

PHOTO

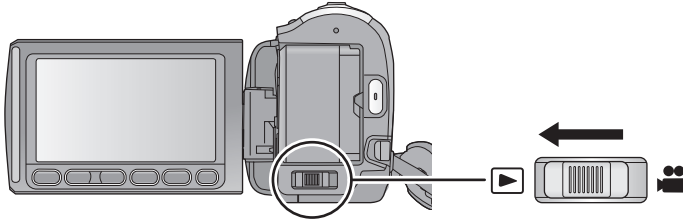

1 Change the mode to .

2 Touch the play mode select icon  to select desired media to be played back.



- Touch [PICTURE/SD CARD] to play back the SD card.



 (HDC-TM10)

Touch [PICTURE/Built-in Memory] to play back the built-in memory.

3 Touch the still picture to be played back.



The selected still picture is played back on the full screen, and the operation icon is automatically displayed on the screen.

- Next (previous) page can be displayed by touching /.

4 Select the playback operation by touching the operation icon.



- ▶/||: Slide show (playback of the still pictures in numerical order) start/pause.
- ◀|||: Plays back the previous picture.
- |||▶: Plays back the next picture.
- : Stops the playback and shows the thumbnails.
- Touch / to display/not-display the operation icon.

Change the thumbnail display

During step 3, the thumbnail display changes in the following order if the zoom lever is operated to + side or - side.

20 still pictures ↔ 9 still pictures
 ↔ 1 still picture

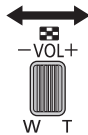

- 9 still pictures display returns if the power is turned off or the mode is changed.
- It is possible to operate with the adjust zoom button.
- Switch to 1 still picture display to check the recording date and file number.

Changing the playback settings for the slide show

- 1) Touch .



- 2) Touch the interval of playback for the slide show.



[SHORT]:

Approx. 1 sec

[NORMAL]:

Approx. 5 sec

[LONG]:

Approx. 15 sec

- 3) Touch the desired sound.

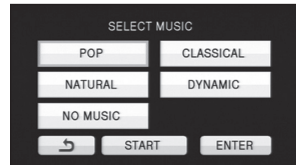

- During slide show or audio testing, speaker volume can be adjusted by the volume lever. (→ 71)

(To test the music audio)

Touch [START] and start the audio testing.

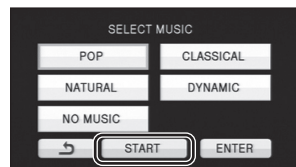

- Touch the other music option to change the music to be tested.
 - When you touch [STOP], the music playback stops.
- 4) Touch [ENTER].

Still picture compatibility

- This unit is compliant with the unified standard DCF (Design rule for Camera File system) established by JEITA (Japan Electronics and Information Technology Industries Association).
- The file format of still pictures supported by this unit is JPEG. (Not all JPEG formatted files will be played back.)
- This unit may degrade or not play back still pictures recorded or created on other products and other products may degrade or not play back still pictures recorded on this unit.

- Any still pictures where the thumbnails are displayed as  cannot be played back.

Playing back still pictures by date

Still pictures recorded on the same day can be played back in succession.

1 Touch the date select icon.

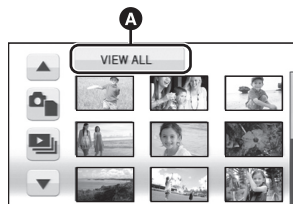



- A** Date select icon

2 Touch the playback date.



The still pictures recorded on the date selected are displayed as thumbnails.

3 Touch the still picture to be played back.

- Playing back of all the still pictures returns if the power is turned off or the mode is changed.
- Even if still pictures are recorded on the same day, they are grouped separately in the following cases.
 - When the number of still pictures exceeds 999
 - When pictures are recorded in Hi-speed Burst Shooting mode ( is indicated after the date in the list by date).
-  is displayed after the date in the list by date for the still pictures created from the motion picture. (→ 73)

VIDEO PHOTO

Deleted scenes/still pictures cannot be restored, so perform appropriate confirmation of the contents before proceeding with deletion.

◇ Change the mode to  .

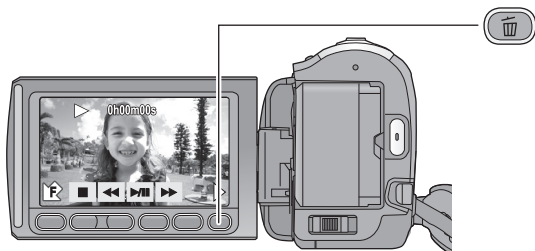

To delete by confirming images being played back

Press the  button while scenes or still pictures to be deleted are being played back.

- When the confirmation message appears, touch [YES].

■ Deleting multiple scenes/still pictures from the thumbnail display

1 Press the  button while the thumbnail view screen is displayed.

2 Touch [SELECT] or [ALL SCENES].

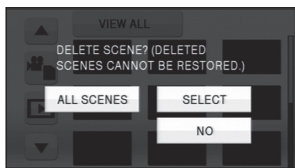

- When [ALL SCENES] is selected, all the scenes or still pictures on the selected media will be deleted. When the confirmation message appears, touch [YES]. (In case of playing back scenes or still pictures by date, all the scenes or still pictures on the selected date will be deleted.)
- Protected scenes/still pictures cannot be deleted.

3 (Only when [SELECT] is selected in step 2)
Touch the scene/still picture to be deleted.

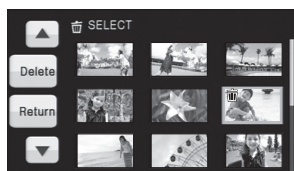

- When touched, the scene/still picture is selected and the  indication appears on the thumbnail. Touch the scene/still picture again to cancel the operation.
- Up to 99 scenes can be selected to be deleted.

4 (Only when [SELECT] is selected in step 2)
Touch [Delete] or press the  button.

- When the confirmation message appears, touch [YES].

(Only when [SELECT] is selected in step 2)

To continue deleting other scenes

Repeat steps 3-4.

When you stop deleting halfway

Touch [CANCEL] or press the MENU button while deleting.

- The scenes or still pictures that have already been deleted when the deletion is canceled cannot be restored.

To complete editing

Press the MENU button.

-
- You can also delete scenes by pressing the MENU button, selecting [EDIT SCENE] → [DELETE] → [ALL SCENES] or [SELECT].
 - You can also delete still pictures by pressing the MENU button, selecting [PICT. SETUP] → [DELETE] → [ALL SCENES] or [SELECT].
 - When the Intelligent Scene Selection or Highlight Playback is selected, scenes cannot be deleted.
 - To delete an unwanted part of a scene, divide the scene first, and then delete the unnecessary part. (→ 82)
 - Scenes/still pictures which cannot be played back (the thumbnails are displayed as ) cannot be deleted.
 - In case of [ALL SCENES], the deletion may take time if there are many scenes or still pictures.
 - When you delete scenes/still pictures, use a battery with sufficient battery power or use the AC adaptor.
 - If you delete scenes recorded on other products or still pictures conforming to DCF standard with this unit, all the data related to the scenes/still pictures may be deleted.
 - When still pictures recorded on an SD card by other products are deleted, a still picture (other than JPEG) that cannot be played back on this unit may be erased.

Dividing a scene to partially delete

VIDEO

To delete an unnecessary portion of a scene, first divide the scene and then delete the unnecessary portion.

◇ Change the mode to .

1 Touch the play mode select icon to select the desired media to divide a scene. (→ 70)

2 Select the menu. (→ 29)

[EDIT SCENE] → [DIVIDE] → [SET]

3 Touch the scene to be divided.



4 Touch  to set the dividing point.



- Using slow-motion playback or frame-by-frame playback makes it easy to search for the point where you want to divide the scene. (→ 71)
- When the confirmation message appears, touch [YES].
- Touch [YES] to continue dividing the same scene. To continue dividing other scenes, touch [NO] and repeat steps 3-4.

5 Press the MENU button to complete dividing.

6 Delete the unnecessary scene. (→ 80)

To delete all the divided points

[DIVIDE] → [CANCEL ALL]

- When the confirmation message appears, touch [YES].
 - All divided points set on this unit will be canceled.
 - The scenes that were deleted after division cannot be recovered.
-
- When [INTEL. SCENE] is selected, scenes cannot be divided.
 - Scenes cannot be divided if the number of scenes played back on a selected date has reached 99.
 - It may not be possible to divide scenes with a short recording time.
 - Data that has been recorded or edited on another device cannot be divided and the divided points cannot be deleted.

Protecting scenes/still pictures

VIDEO PHOTO

Scenes/still pictures can be protected so that they are not deleted by mistake.

(Even if you protect some scenes/still pictures, formatting the media will delete them.)

◇ Change the mode to  .

1 Select the menu. (→ 29)

[VIDEO SETUP] or [PICT. SETUP] →
[SCENE PROTECT] → [YES]

2 Touch the scene/still picture to be protected.



- When touched, the scene/still picture is selected and the **ON** indication appears on the thumbnail. Touch the scene/still picture again to cancel the operation.
 - Press the MENU button to complete the settings.
-
- When [INTEL. SCENE] is selected while playing back motion pictures, scenes cannot be protected.

PHOTO

You can write the data selecting still pictures to be printed and the number of prints (DPOF data) onto the SD card.

◇ **Change the mode to**  **and touch the play mode select icon to select [PICTURE/SD CARD]. (→ 77)**

■ What is DPOF?

DPOF (Digital Print Order Format) is a format which allows the user of a digital camera to define which captured images on the SD card are to be printed, together with information on the number of copies they wish to print. (Please note: Not all commercial printing services support this feature at this time.)

1 Select the menu. (→ 29)

[PICT. SETUP] → [DPOF SET] → [SET]

2 Touch the still picture to be set.

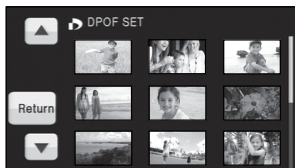

3 Touch / to set the number of prints.



- Up to 999 prints can be selected. (Prints for set number can be printed with a printer that supports DPOF.)
- To cancel the setting, set the number of prints to [0].

4 Touch [ENTER].

- To continuously set other still pictures, repeat steps 2-4.
- Press the MENU button to complete the settings.

To cancel all DPOF settings

[DPOF SET] → [CANCEL ALL]

- When the confirmation message appears, touch [YES].
- Copy still pictures saved in the built-in memory to an SD card before setting DPOF.
- You cannot add the recording date to pictures to be printed with the DPOF settings.

Copying between SD card and Built-in Memory [HDC-TM10]

VIDEO PHOTO

Motion pictures or still pictures recorded with this unit can be copied between an SD card inserted in this unit and a built-in memory.

Confirming remaining capacity on the copy destination

- If the remaining capacity on a single SD card is not enough, you can copy to multiple SD cards following the instruction on the screen.
In this case, the last scene copied to an SD card is automatically divided to fit the space on the SD card.
- If you divide the scenes (→ 82), and copy by scene selection, it is possible to copy matching the remaining capacity of the media, or only the necessary parts.

Media information display

- ◇ Change the mode to  and touch the play mode select icon to select desired media to confirm the media information. (→ 70, 77)

Select the menu. (→ 29)

SD card information display

[SETUP] → [CARD STATUS] → [YES]

Built-in memory information display

[SETUP] → [Built-in Memory STATUS] → [YES]

- Touch [EXIT] or press the MENU button to close the indication.
-
- The 8 GB built-in memory requires some space to store information and manage system files, so the actual usable space is slightly less than the indicated value. The usable built-in memory space is generally calculated as 1 GB=1,000,000,000 bytes. The capacities of this unit, PCs and software are expressed as 1 GB=1,024×1,024×1,024=1,073,741,824 bytes. Therefore, the indicated value of the capacity appears to be smaller.

Copying

- If there is not much remaining capacity in the SD card, a confirmation message asking to copy after deleting all data on the SD card is displayed. Be aware that deleted data cannot be restored.
- Refer to page 87 for approximate time for copying.

1 Change the mode to .

- Use a sufficiently charged battery or the AC adaptor.

2 Select the menu. (→ 29)

(When copying from built-in memory to SD card)

[COPY] → [ → ] → [YES]

(When copying from SD card to built-in memory)

[COPY] → [ → ] → [YES]

- When there are relay-recorded scenes in the built-in memory, a message appears on the screen. Before copying, store all of the relay scenes in the SD card. (→ 88)

3 Touch the desired item.

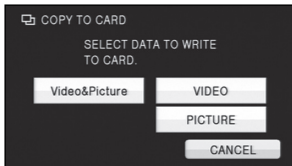

[Video&Picture]:

All scenes are copied in order of motion pictures, then still pictures.
Proceed to step 7.

[VIDEO]:

Motion pictures are copied.

[PICTURE]:

Still pictures are copied.

4 (Only when [VIDEO]/[PICTURE] is selected in step 3)

Touch the desired item.

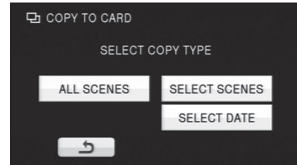

[ALL SCENES]:

All motion pictures or still pictures are copied.
Proceed to step 7.

[SELECT SCENES]:

Some motion pictures or still pictures are selected for copying.

[SELECT DATE]:

Copy by selecting the date.

5 (Only when [SELECT SCENES] is selected in step 4)

Touch the scene/still picture to be copied.

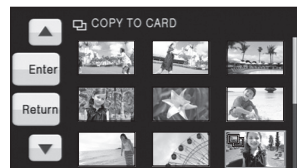

- When touched, the scene/still picture is selected and the  indication appears on the thumbnail. Touch the scene/still picture again to cancel the operation.
- Up to 99 scenes/still pictures can be set in succession.

(Only when [SELECT DATE] is selected in step 4)

Touch the date to be copied.



- When touched, the date is selected and surrounded by red. Touch the date again to cancel the operation.
- Up to 99 dates can be set in succession.

6 (Only when [SELECT SCENES]/ [SELECT DATE] is selected in step 4) Touch [Enter]/[ENTER].

7 When the confirmation message appears, touch [YES].

- If 2 or more SD cards are necessary to copy, change the card following the instructions on the screen.

8 Touch [EXIT] when the copy complete message is displayed.

- The thumbnail view of the copy destination is indicated.

When you stop copying halfway

Touch [CANCEL] or press the MENU button while copying.

Approximate time for copying
To copy a 4 GB SD card with full motion pictures to a built-in memory:
10 min to 20 min
To copy 600 still pictures (approx. 600 MB):
5 min to 10 min

If you will delete the motion pictures or still pictures after copying is complete, be sure to play back the motion pictures or still pictures to check that they have been copied to correctly before deleting.

- It is impossible to compress motion pictures or still pictures on the copy source into the capacity that can be accommodated by the usable space on the copy destination.
- Depending on the following conditions, the time it takes for copying may be longer.
 - The number of recorded scenes is large.
 - The temperature of the unit is high.
- If some motion pictures or still pictures have already been recorded to the copy destination, then the same date may be assigned or images may not display by date when the list by date is selected.
- Motion pictures that have been recorded on another device may not be copied. Data recorded on a PC with HD Writer AE 1.5, etc. cannot be copied.
- Protection and DPOF settings will be cleared on the copied motion pictures and still pictures when copying motion pictures and still pictures with protection and DPOF settings.
- The order in which the scenes or still pictures were copied cannot be changed.

Relay scene combining

[HDC-TM10]

VIDEO

You can combine the relayed scene (→ 58) in the built-in memory and the continued scene in the SD card to be one into the SD card.

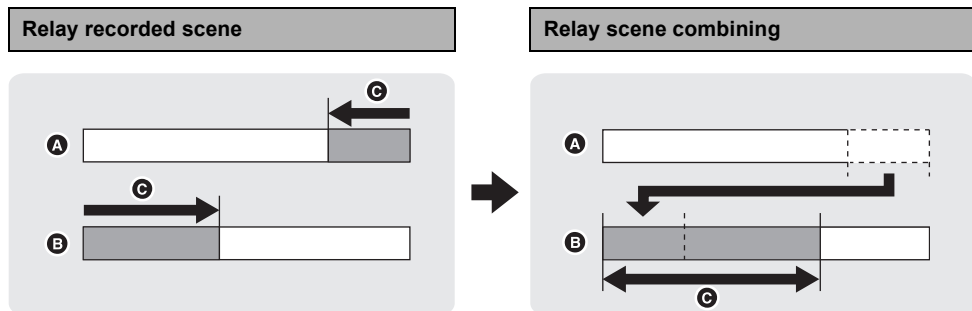

- A** Built-in memory
- B** SD card
- C** Range of relay recording

- Change the mode to and touch the play mode select icon to select the desired media. (→ 70)

1 Insert the SD card that was used for relay recording.

2 Select the menu. (→ 29)

[COPY] → [RELAY SCENE COMBINE] → [YES]

3 When the confirmation message appears, touch [YES].

- Combine the relayed scenes into a SD card.
- Scene in the built-in memory will be deleted.

4 Touch [EXIT] when the relay scene combining complete message is displayed.

- The thumbnail view of the SD card is indicated.

- Relay recording information will be deleted when the relay scenes are combined, and relay recording will be possible again.
- When the relayed scenes in the built-in memory or SD card are deleted, combining of the relayed scenes will not be possible.

To cancel relay information

[COPY] → [RELAY INFO CANCEL] → [YES]

- When the relay information is canceled, combining of the relayed scenes will not be possible anymore.
- When the confirmation message appears, touch [YES].

Combining of the relay scene cannot be performed if the available space on the SD card is less than the volume of the relayed scene in the built-in memory. It is recommended to combine the relay scene using a DVD burner or the HD Writer AE 1.5.

Please be aware that if a medium is formatted, then all the data recorded on the medium will be erased and cannot be restored. Back up important data on a PC, DVD disc etc. (→ 96, 107)

◇ Change the mode to  or , and select desired media to be formatted. (→ 42, 70, 77)

Select the menu. (→ 29)

Formatting SD cards

[SETUP] → [FORMAT CARD] → [YES]

HDC-TM10

Formatting Built-in memory

[SETUP] → [FORMAT Built-in Memory] → [YES]

- When the confirmation message appears, touch [YES].
- When formatting is complete, touch [EXIT] to exit the message screen.

HDC-TM10

- Perform a physical formatting of the built-in memory when this unit is to be disposed/transferred. (→ 134)
-
- Do not turn this unit off or remove the SD card, while formatting. Do not expose the unit to vibrations or shock.

Use this unit to format media.

Formatting built-in memory is only available with this unit.

Do not format an SD card using any other equipment such as a PC. The card may not be used on this unit.

1

Watching Video/Pictures on your TV

VIDEO PHOTO

Confirm the terminals on your TV and use a cable compatible with the terminals. Image quality may vary with the connected terminals.



- ① High quality
- ② HDMI terminal
- ③ Component terminal
- ④ Video terminal

- Use the supplied component cable and AV cable. Use of the following Panasonic HDMI mini cables is recommended to connect the unit to the HDMI terminal.
- Do not simultaneously connect an HDMI mini cable and Component cable to this unit.

1 Connect this unit to a TV.

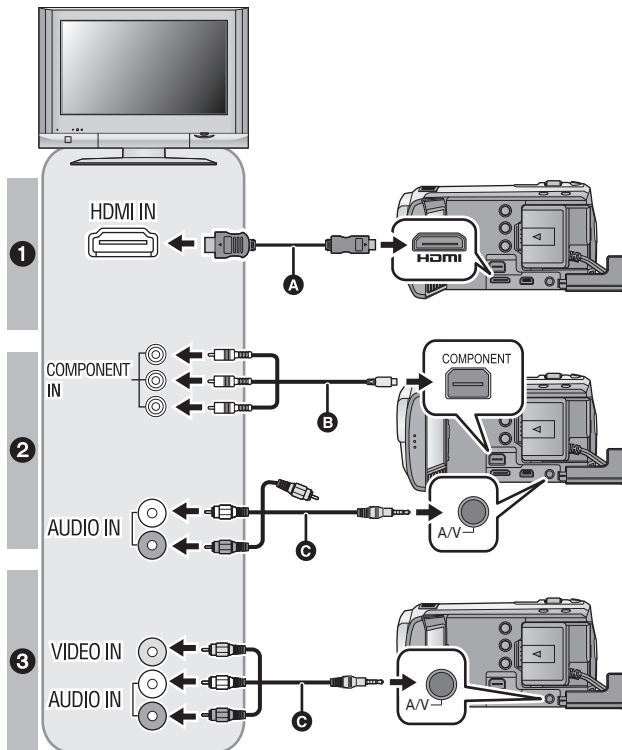

- Ⓐ HDMI mini cable (optional)
- Ⓑ Component cable (supplied)
- Ⓒ AV cable (supplied)

Picture quality

- ① High definition images when connecting to HDMI terminal
- ② High definition images when connecting to component terminal compatible with 1080i
Standard images when connecting to component terminal compatible with 480i
- ③ Standard images when connecting to video terminal

- Check that the plugs are inserted as far as they go.
- Do not use any other cables except a genuine Panasonic HDMI mini cable (RP-CDHM15, RP-CDHM30; optional).
- Do not use any other component cables except the supplied one.
- The component terminal is for outputting images only so be sure to also connect the AV cable. (It is not necessary to connect the yellow plug.)
- Do not use any other AV cables except the supplied one.

2 Select the video input on the TV.

- Example:
 Select the [HDMI] channel with a HDMI mini cable.
 Select the [Component] channel with a component cable.
 Select the [Video 2] channel with an AV cable.
 (The name of the channel may differ depending on the connected TV.)

3 Change the mode to to play back.

- The image and audio are output on the TV.

Cables	Reference items
A HDMI mini cable (optional)	<ul style="list-style-type: none"> • Connecting with a HDMI mini cable (→ 93) • Playback using VIERA Link™ (HDAVI Control™) (→ 94)
B Component cable (supplied)	<ul style="list-style-type: none"> • Connecting with the component cable (→ 93)

If the image or audio from this unit does not appear on the TV

- Check the connections.
- Check that the plugs are inserted as far as they go.
- **Check the input setting (input switch) and the audio input setting on the TV. (For more information, please read the operating instructions for the TV.)**
- **Check the setting of the unit. (→ 93)**



■ **To watch images on a regular TV (4:3) or when both sides of the images do not appear on the screen**

Change the menu setting to display the images correctly. (Check the TV setting.)

Select the menu. (→ 29)

[SETUP] → [TV ASPECT] → [4:3]

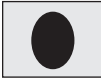
Example of images with a 16:9 aspect ratio on a regular TV (4:3)

[TV ASPECT] setting	
[16:9]	[4:3]
	

- If a wide-screen TV is connected, adjust the aspect setting on the TV. (Refer to the operating instructions of the TV for details.)

■ **To display the on-screen information on the TV**

When the menu setting is changed, the information displayed on the screen (operation icon and time code etc.) can be displayed/not displayed on the TV.

Select the menu. (→ 29)

[SETUP] → [EXT. DISPLAY] → **desired setting**

[OFF]:

Not displayed

[SIMPLE]*:

Information partially displayed

[DETAIL]:

All information displayed

* This setting is only available in recording mode.

- When the unit is purchased, the recording mode is set to [SIMPLE] and playback mode is set to [OFF].
- When the power is turned off, the settings return to these values.

-
- When connecting with a HDMI mini cable, be sure to connect to a HDMI input terminal. Do not connect to a HDMI output terminal on other products.
 - When an HDMI mini cable or component cable is simultaneously connected with an AV cable, the output from the HDMI mini cable or component cable is prioritized.

Refer to the following support site for information about Panasonic TVs with an SD card slot for playing back your pictures.

<http://panasonic.net/>

- For details on how to play back, please read the operating instructions for the TV.

Connecting with a HDMI mini cable

What is HDMI?

HDMI is the interface for digital devices. If you connect this unit to a HDMI compatible high definition TV and then play back the recorded high definition images, you can enjoy them in high resolution with high quality sound.

If you connect this unit to a Panasonic TV compatible with VIERA Link, linked operations (VIERA Link) are possible. (→ 94)

Select the desired method of HDMI output.

Select the menu. (→ 29)

[SETUP] → [HDMI RESOLUTION] → **desired setting**

[AUTO]:

The output resolution is automatically set based on the information from the connected TV.

Information from the connected TV	Output resolution
720p, 1080i	1080i
Others	480p

[1080i]:

The interlace method with 1080 available scan lines is used for output.

[480p]:

The progressive method with 480 available scan lines is used for output.

Interlace method/progressive method

i= interlace scanning is scanning the screen with half of the effective scanning lines every 1/60 seconds, where p= progressive scanning is a high density image signal that is scanning the screen with all the effective scanning lines every 1/60 seconds.

- If the images are not output on the TV when the setting is [AUTO], switch to the method [1080i] or [480p] which enables the images to be displayed on your TV. (Please read the operating instructions for the TV.)

Connecting with the component cable

Component output setting can be changed.

Select the menu. (→ 29)

[SETUP] → [COMPONENT OUT] → **desired setting**

[480i]:

When connecting to the component terminal on the TV compatible with 480i.
(Playback is in standard quality.)

[1080i]:

When connecting to the component terminal on the TV compatible with 1080i.
(Playback is in high definition quality.)

Playback using VIERA Link™ (HDAVI Control™)

VIDEO PHOTO

What is the VIERA Link?

- VIERA Link™ is a new name for EZ Sync™.
- This function allows you to use your remote control for the Panasonic TV for easy operations when this unit has been connected to a VIERA Link compatible device using a HDMI mini cable (optional) for automatic linked operations. (Not all operations are possible.)
- VIERA Link is a unique Panasonic function built on a HDMI control function using the standard HDMI CEC (Consumer Electronics Control) specification. Linked operations with HDMI CEC compatible devices made by other companies are not guaranteed. When using devices made by other companies that are compatible with VIERA Link, refer to the operating instructions for the respective devices.
- This unit is compatible with VIERA Link Ver.4. VIERA Link Ver.4 is the newest Panasonic version and is also compatible with existing Panasonic VIERA Link devices. (As of Dec 2008)

◇ Change the mode to  .

1 Select the menu. (→ 29)

[SETUP] → [VIERA Link] → [ON]

- The default setting is [ON].
- If you are not using VIERA Link, set to [OFF].

2 Connect this unit to a Panasonic TV compatible with VIERA Link with a HDMI mini cable.

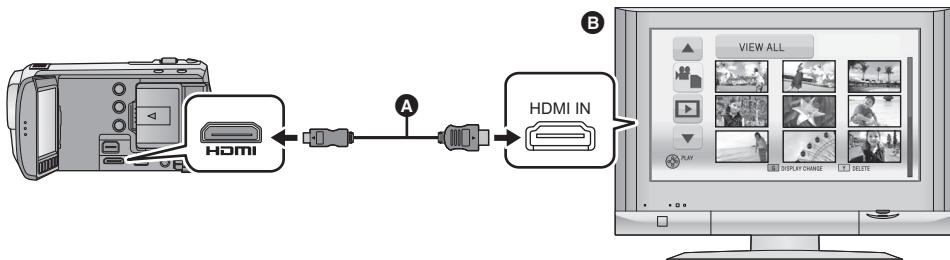

- A** HDMI mini cable (optional)
- B** Panasonic TV compatible with VIERA Link
- It is recommended to connect this unit to an HDMI terminal other than the HDMI1 if there are 2 or more HDMI input terminals on the TV.
- VIERA Link must be activated on the connected TV. (Read the operating instructions of the TV for how to set etc.)
- Do not use any other cables except a genuine Panasonic HDMI mini cable (RP-CDHM15, RP-CDHM30; optional).

3 Operate with the remote control for the TV.

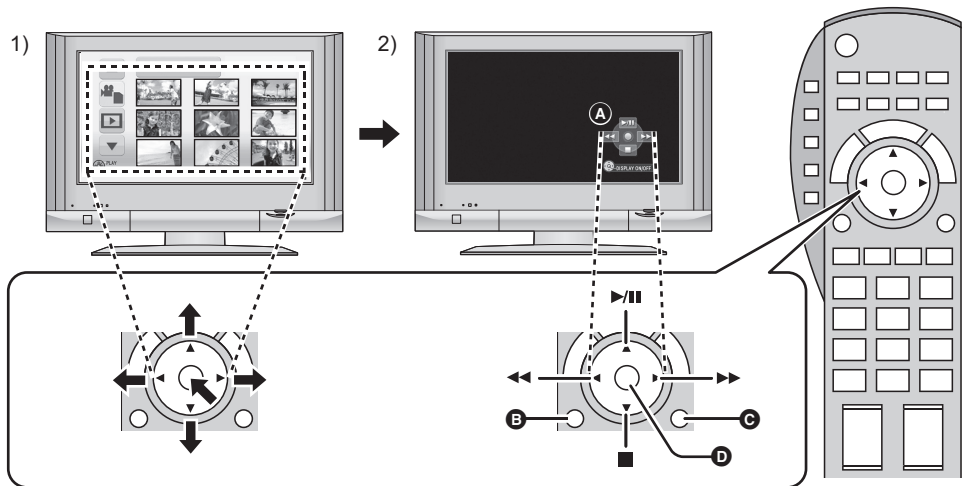

1) Press the button up, down, left or right to select a scene or still picture to be played back, and then press the button in the center to set it.

2) Activate the operation icons that are displayed on TV screen with the remote control for the TV.

A Operation icons

B Display operation icons

C Cancel operation icons

D Display/Cancel operation icons

• The following operations are available by pressing the color buttons on the remote control.

– Green: Switching the number of scenes/still pictures in thumbnail display

(9 thumbnails → 20 thumbnails → 9 thumbnails...)

– Yellow: Deleting scenes/still pictures

■ Other linked operations

Turning the power off:

If you use the remote control for the TV to turn off the power, the power on this unit also turns off.

Automatic input switching:

If you connect with a HDMI mini cable and then turn on the power on this unit, the input channel on the TV automatically switches to this unit's screen. If the TV's power is in standby status, it will turn on automatically (if [Set] has been selected for the TV's [Power on link] setting).

- Depending on the HDMI terminal on the TV, the input channel may not switch automatically. In this case, use the remote control for the TV to switch the input channel.
- If VIERA Link does not work properly, refer to page 129.

• If you are unsure whether or not the TV and AV amplifier you are using are compatible with VIERA Link, read the operating instructions for the devices.

• Available linked operations between this unit and a Panasonic TV is different depending on the types of Panasonic TVs even if they are compatible with VIERA Link. Refer to the operating instructions of the TV for the operations that support on the TV.

• Operation is not possible with a cable that is not based on the HDMI standard.

Connecting a DVD burner to copy to/play back a disc

VIDEO PHOTO

Motion pictures or still pictures recorded with this unit can be copied to a DVD disc by connecting a DVD burner (optional) to this unit using a Mini AB USB Connection Cable (supplied with DVD burner). The copied DVD disc can also be played back.

- Please read the operating instructions of the DVD burner for how to use it.

Preparing for copying/playing back

We recommend using Panasonic DVD burner VW-BN1/VW-BN2.

■ About discs that can be used for copying

Disc type*1	DVD-RAM	DVD-RW	DVD-R/DVD-R DL
Copy*2	○	○	○
Additional copy*3	○	—	—
Format*4	○	○	—

*1 Only 12 cm size disc can be used.

*2 Use a new disc. You can additionally copy only to a DVD-RAM. When you copy to DVD-RW, DVD-R or DVD-R DL, the disc is automatically finalized to allow playback on other devices and additional copying will not be possible.

*3 Only DVD-RAM copied with the DVD burner or HD Writer AE 1.5 can additionally copy.

*4 Connect this unit and a DVD burner before formatting. If you format a used disc, you can copy on that disc. Please be aware that if a disc is formatted, then all the data recorded on the disc will be erased. (→ 102)

- We recommend using the discs that have been recommended in the operating instructions of the DVD burner. Refer to the operating instructions of the DVD burner for details about recommended discs, disc handling etc.
- The following cannot be copied on the same disc.
 - Motion pictures and still pictures
 - High-definition picture quality and existing standard picture quality

1 Connect the AC adaptor (supplied with DVD burner) to the DVD burner.

- You cannot supply power to the DVD burner from this unit.

2 Connect this unit to the AC adaptor and change the mode to .

3 Connect this unit to the DVD burner with the Mini AB USB Connection Cable (supplied with DVD burner).

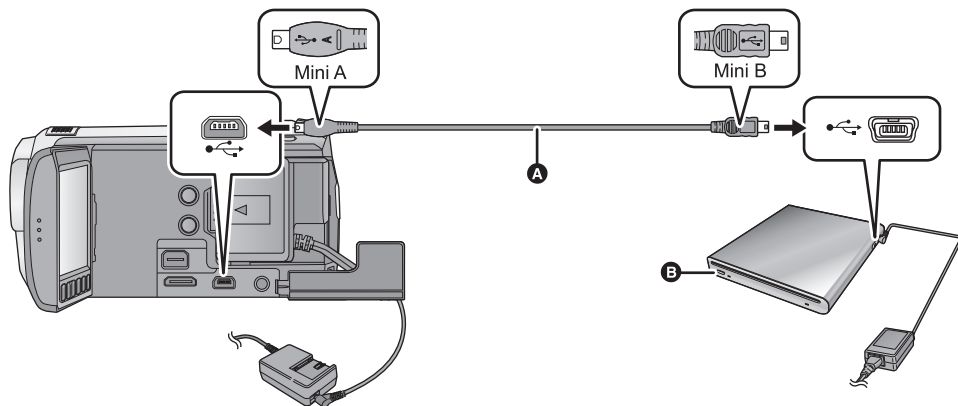

A Mini AB USB Connection Cable (supplied with DVD burner)

B DVD burner (optional)

- Insert the plugs as far as they will go.

4 Insert the disc in the DVD burner.

- Insert the DVD disc with the recording side down when using the DVD burner.

5 Touch the desired item.

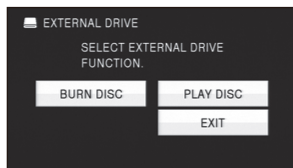

• [BURN DISC]: Refer to page 98 for how to copy discs.

• [PLAY DISC]: Refer to page 101 for how to play back the copied discs.

To terminate the connection with the DVD burner

Touch [EXIT].

- Disconnect the Mini AB USB Connection Cable from this unit.

Copying to discs

- You cannot copy from multiple SD cards to 1 disc. (You can additionally copy only to a DVD-RAM.)
- Motion pictures and still pictures cannot both be copied to a single disc.
- Confirm that auto protection is [ON] before copying data. (→ 102)
- [HDC-TM10] When copying a scene in the built-in memory to a disc that includes a scene that was relay recorded, the continued scene that is on the SD card will be copied together to the disc.
- Refer to page 100 for Approximate time for copying to a disc.

1 Connect this unit to the DVD burner to prepare for copying. (→ 96)

- For users who have [HDC-SD10], proceed to step 3.

2 [HDC-TM10] Touch copy source media.

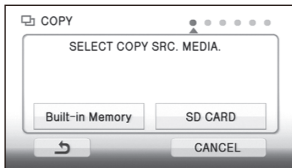

3 Touch the desired item to be copied.

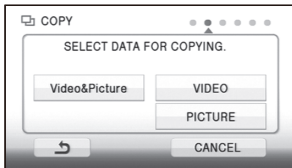

When [Video&Picture] is selected, all scenes are copied in order of motion pictures, then still pictures.

(Since motion pictures and still pictures are copied to separate discs, 2 or more discs are required.)

- It will return to the previous step by touching .

4 (Only when [Video&Picture]/[VIDEO] is selected in step 3)

Touch the recording method for copying.

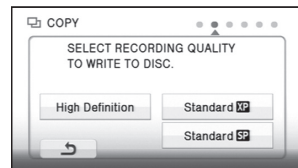

[High Definition]:

The images recorded in high definition picture quality with this unit are copied as they are.

[Standard (XP)]/[Standard (SP)]:

Images are converted into the original standard picture quality and then copied.

Since XP has a higher picture quality compared to SP, the data capacity becomes large so that you may need more discs for copying than SP.

- Touch [NEXT] to proceed to step 8, when [Video&Picture] is selected in step 3.

5 (Only when [VIDEO]/[PICTURE] is selected in step 3)

Touch the desired item.

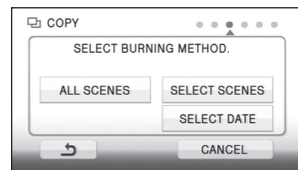

[ALL SCENES]:

All motion pictures or still pictures are copied. Touch [NEXT] to proceed to step 8.

[SELECT SCENES]:

Some scenes are selected for copying.

[SELECT DATE]:

Copy by selecting the date.

- 6** (Only when [SELECT SCENES] is selected in step 5)

Touch the scene you want to copy.

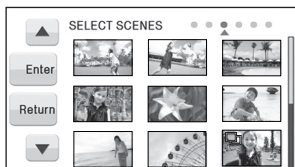

- When touched, the scene is selected and the  indication appears on the thumbnail. Touch the scene again to cancel the operation.
- Up to 99 scenes can be selected in succession.

(Only when [SELECT DATE] is selected in step 5)

Touch the date you want to copy.

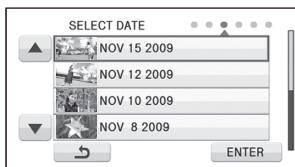

- When touched, the date is selected and surrounded by red. Touch the date again to cancel the operation.
- Up to 99 dates can be selected in succession.

Before you delete the data on the media after copying is complete, be sure to play back the discs to check that they have been copied to correctly. (→ 101)

Important Notice

- When connecting an optional DVD burner and this unit for copying a disc, do not insert a disc with recorded motion pictures in high definition picture quality into devices that do not support the AVCHD format. In some cases the disc may get stuck in the device. The disc will not play back on devices that do not support the AVCHD format.
- When inserting a disc containing recorded motion/still pictures into other devices, a message prompting you to format the disc may be displayed. Do not format the disc, since deleted data cannot be restored later.

- 7** (Only when [SELECT SCENES]/[SELECT DATE] is selected in step 5)

Touch [Enter]/[ENTER].

- Touch [NEXT].

8 Touch [START].

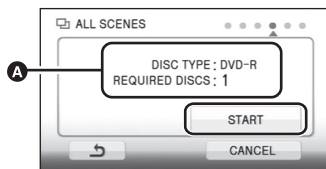

- A** The number of discs necessary for copying by disc type
- When 2 or more discs are necessary for copying, follow the on-screen instructions to switch discs.
- You may need more discs than displayed number of discs when you are copying additionally to a used DVD-RAM.
- Eject the disc after copying is completed.
- When the copied disc is played back on another device and the list of scenes is displayed, they are ordered by date.

Approximate time for copying to a disc

To copy motion pictures to the full capacity of a disc

Disc type	Copy time		
	[High Definition]	[Standard (XP)]	[Standard (SP)]
DVD-RAM	Approx. 50 min to 80 min	Approx. 90 min to 120 min	Approx. 135 min to 180 min
DVD-RW*	Approx. 35 min to 75 min		
DVD-R*	Approx. 15 min to 45 min		

* Even if the data capacity to be copied is small, the time it takes for copying may be about the same as the time shown in the table.

- When copying motion pictures in standard picture quality to a disc, the recordable time of [Standard (XP)] is approx. 60 minutes and that of [Standard (SP)] is approx. 120 minutes.

To copy 600 still pictures (approx. 600 MB)

Disc type	Copy time
DVD-RAM/DVD-RW/DVD-R	Approx. 30 min to 40 min

- Copy time of DVD-R DL is approximately 2 to 3 times that of DVD-R.
- Depending on the following conditions, the time it takes for copying may be longer than the above times.
 - When the number of recorded scenes is large
 - When the temperature of the DVD burner has become high

• The disc that was copied to can be played back by connecting this unit and a DVD burner. (→ 101)

- Do not turn off this unit or the DVD burner or disconnect the Mini AB USB Connection Cable while copying. Also, do not shake this unit or the DVD burner.
- It is impossible to stop copying halfway.
- The order in which the scenes were copied cannot be changed.
- Data that has been recorded on another device may not be copied.
- When 2 or more discs are necessary for copying, the last scene copied to a disc is automatically divided to fit the space on the disc.
- Copying may be completed using less discs than the number displayed if scenes were automatically divided.
- When the disc that was copied to is played back on another device, the picture may momentarily stop at the points where the scenes switch. (→ 131)
- Discs copied in [Standard (XP)]/[Standard (SP)] cannot be used in the Intelligent Scene Selection, Highlight Playback or [HIGHLIGHT] in Highlight&Time frame index.

Playing back the copied disc

- Only discs that have been copied by connecting this unit to the DVD burner or created with HD Writer AE 1.5 can be played back. It may not be possible to play back discs copied/played back on other devices or software.

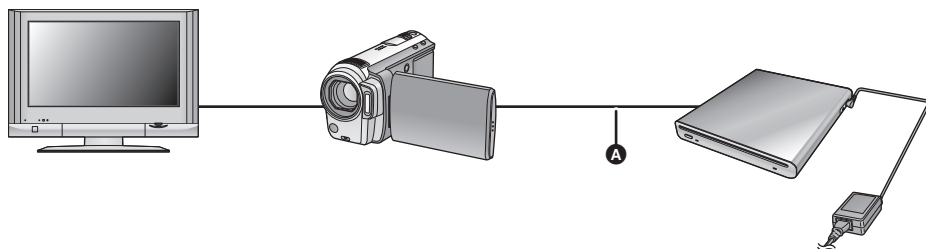

- **A** Mini AB USB Connection Cable (supplied with DVD burner)

1 Connect this unit to the DVD burner to prepare for playback. (→ 96)

- When playing back on a TV, connect this unit to the TV with HDMI mini cable, component cable or AV cable. (→ 90)

2 Touch the scene or still picture to be played back and then play it back.

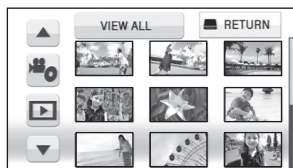

- The playback operation is performed the same as when playing back motion pictures or still pictures. (→ 70, 77)
 - It will return to Step 5 on page 97 when [RETURN] is selected in the thumbnail screen.
-
- It is also possible to switch the media to play back by touching the Play Mode Select icon. It is possible to select [VIDEO/DISC] or [PICTURE/DISC] when the DVD burner is connected.
 - Black bands may appear on the left and right of the screen when it is played back connected to a TV with 4:3 ratio.

Managing the copied disc (Formatting, Auto protect, Displaying disc information)

- Connect this unit to the DVD burner and then touch [PLAY DISC]. (→ 96)

■ Formatting discs

This is for initializing DVD-RAM and DVD-RW discs.

Please be aware that if a disc is formatted, then all the data recorded on the disc will be erased. Back up important data on a PC etc.

Select the menu. (→ 29)

[DISC SETUP] → [FORMAT DISC] → [YES]

- When the confirmation message appears, touch [YES].
 - When formatting is complete, touch [EXIT] to exit the message screen.
-
- Connect this unit and the DVD burner to format discs. You may no longer be able to use the discs if you format them on another device such as a PC etc.

■ Auto protect

You can protect (write protect) a DVD-RAM or DVD-RW disc when copying motion pictures or still pictures in high definition picture quality to the disc.

1 Select the menu. (→ 29)

[DISC SETUP] → [AUTO PROTECT] → [ON]

- The default setting is [ON].
- If a disc that you copied to is inserted in another device without protecting it, a message may be displayed prompting you to format the disc. We recommend setting [AUTO PROTECT] to [ON] in order to prevent accidental deletion.

2 Copy to the disc. (→ 98)

- The copied disc is write protected when it is ejected if [AUTO PROTECT] is [ON].

To release the disc protection

- If you format a disc, the auto protection is released. Please be aware that all the data recorded on the disc is erased and cannot be recovered.
- The disc will need to be re-formatted on the device you will use.

■ Displaying disc information

Information such as the type of recorded disc, the number of recorded scenes and whether or not the disc is finalized is displayed.

Select the menu. (→ 29)

[DISC SETUP] → [DISC STATUS] → [YES]

- Touch [EXIT] to exit the information screen.

Dubbing images onto other video devices

VIDEO

Images played back on this unit can be dubbed onto a DVD recorder or video device.

- **Images are dubbed in standard quality.**
- Use the AC adaptor to free you from worrying about the battery running down.

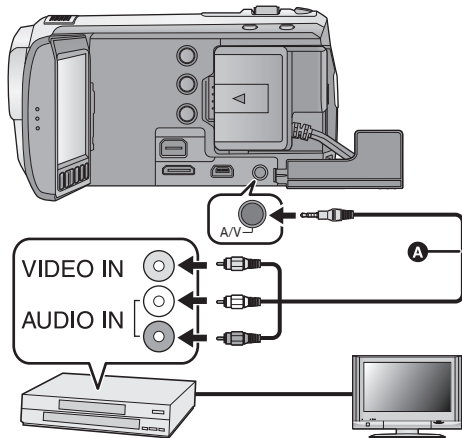

Change the video input on the video device and TV that this unit is connected to.

- The channel set will differ depending on the terminal to which the unit is connected.
 - See the operating instructions of the video device for details.
 - Insert the plugs as far as they will go.
 - Do not use any other AV cables except the supplied one.
- A** AV cable (supplied)

1 Connect this unit to a video device and then change the mode to .

2 Start playback on this unit.

3 Start recording on the connected device.

- To stop recording (dubbing), stop playback on this unit after stopping recording on the recorder.
- If the date and time display and function indication are not wanted, cancel them before dubbing. (→ 34, 92)

If the dubbed images are played back on a wide-screen TV, the images may be stretched vertically. In this case, refer to the operating instructions for the device you are connecting to or read the operating instructions of the wide-screen TV and set the aspect ratio to 16:9.

PHOTO

To print pictures by directly connecting this unit to the printer, use a printer compatible with PictBridge. (Read the operating instructions for the printer.)

PictBridge is an industry standard from the Camera & Imaging Products Association (CIPA) for direct printing. It allows images to be printed directly from digital cameras to a printer, without having to connect the camera to a PC.

- Use the AC adaptor to free you from worrying about the battery running down.
- **Turn on this unit. (This function is available in all modes.)**

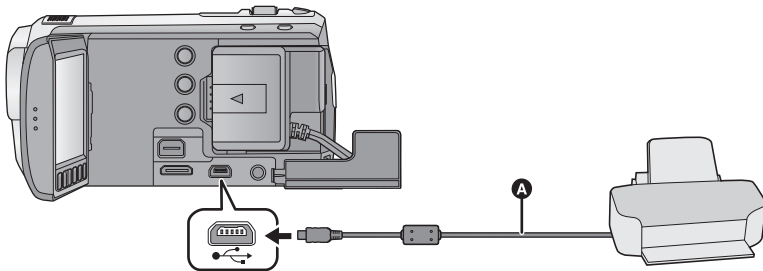

- **A** USB cable (supplied)

- Insert the plugs as far as they will go.

1 Connect this unit to a printer.

The USB function selection screen will appear.

- Connect the printer directly to this unit. Do not use a USB hub.
- Do not use any other USB cables except the supplied one. (Operation is not guaranteed with any other USB cables.)

- **HDC-SD10**

If the [PictBridge] indication does not appear or continues to flash, disconnect and then reconnect the USB cable.

2 Touch [PRINTER].

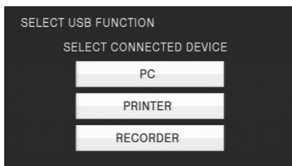

- When you select an option other than [PRINTER], reconnect the USB cable.
- For users who have **HDC-SD10**, proceed to step 4.

3 **HDC-TM10**

Select print source media and touch the icon.

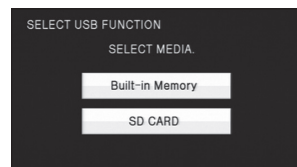

- If the [PictBridge] indication does not appear or continues to flash, disconnect and then reconnect the USB cable.

4 Touch a still picture to be printed.



5 Touch / to set the number of prints.

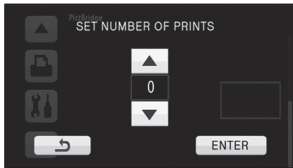

- Touch [ENTER] after the number of prints is set.
- You can set up to 9 prints.
- To cancel the setting, set the number of prints to [0].
- Up to 99 files can be set in succession.

6 Touch .

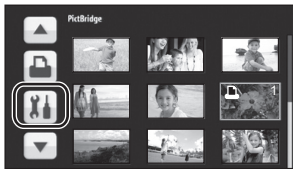

7 Touch [DATE PRINT] to select the date print setting.

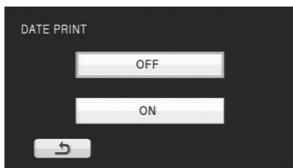

- If the printer is not capable of date printing, this setting is unavailable.

8 Touch [PAPER SIZE] to select the paper size setting.

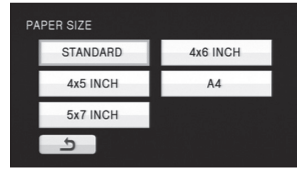

[STANDARD]: Size specific to the printer

[4×5 INCH]: L size

[5×7 INCH]: 2L size

[4×6 INCH]: Postcard size

[A4]: A4 size

- You cannot set paper sizes not supported on the printer.

9 Touch [PAGE LAYOUT] to select the desired layout setting.

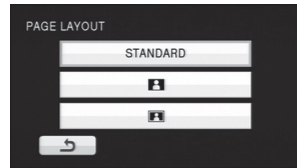

[STANDARD]: Layout specific to the printer

 : No frame print

 : Frame print

- You cannot set page layouts not supported on the printer.

- Touch  .

10 Touch to print the pictures.

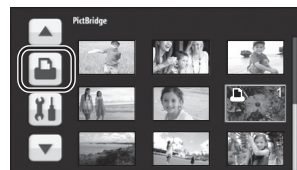

- When the confirmation message appears, touch [START].
 - Exit PictBridge by disconnecting the USB cable (supplied) after the pictures have been printed.
-

When you stop printing halfway

Touch [CANCEL].

- A confirmation message appears. If [YES] is selected, the number of prints set is canceled and the screen returns to step 4. If [NO] is selected, all the settings are kept and the screen returns to step 4.
-
- Avoid the following operations during printing. These operations disable proper printing.
 - Disconnecting the USB cable
 - Opening the SD card cover and removing the SD card
 - Changing the mode
 - Turn the unit off
 - The edges of still pictures recorded in this unit with a 16:9 aspect ratio may be cut off. When using a printer with a trimming or borderless printing function, cancel this function before printing. (Refer to the operating instructions of the printer for details.)
 - When the unit is connected directly to the printer, the DPOF settings cannot be used.

What you can do with a PC

HD Writer AE 1.5

You can copy the motion/still picture data to the HDD of PCs or write to media like Blu-ray discs (BD), DVD discs or SD cards using HD Writer AE 1.5, the software installed in the supplied CD-ROM. Refer to the operating instructions of HD Writer AE 1.5 (PDF file) for details on how to use it.

■ Smart wizard

The Smart wizard screen is automatically displayed when you connect this unit to a PC with HD Writer AE 1.5 installed. (→ 114)



Copy to PC:

You can copy motion/still picture data to the HDD of PCs.

Copy to disc:

You can copy to disc in high definition picture quality or conventional standard picture quality (MPEG2 format).

- Select the function you wish to use and follow the on-screen instructions for easy copying.

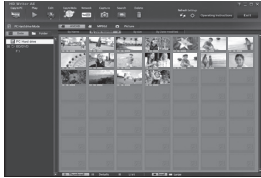
Available function	Data type	Software required
Copying data to a PC	Motion picture and still picture	CD-ROM (supplied): HD Writer AE 1.5
Copying in BD/AVCHD format		
Copying in DVD-Video format: • Converted to conventional standard quality (MPEG2 format).	Motion picture	
Editing: Editing motion picture data copied on an HDD of a PC • Title, Transition, Delete partially, Divide Scene • Converting the motion picture data to MPEG2 • Converting part of motion picture into still picture		
Playing back on a PC: Play back the motion picture data in high definition picture quality on a PC.		
Formatting discs: Depending on the type of disc that you use, formatting is necessary.		

Available function	Data type	Software required
Playing back on a PC	Still picture	HD Writer AE 1.5 or standard Windows picture viewer or a commercially available picture viewer
Copying still pictures to a PC (→ 116)		Windows Explorer
Refer to page 118 if using a Mac.		

Important Notice

- Do not insert a disc recorded in AVCHD format with HD Writer AE 1.5 in a device that does not support the AVCHD format. In some cases the disc may get stuck in the device. The disc will not play back on devices that do not support the AVCHD format.
- When inserting a disc containing recorded motion pictures into other devices, a message prompting you to format the disc may be displayed. Do not format the disc, since deleted data cannot be restored later.

● (HDC-TM10)

It is impossible to write data to the built-in memory on this unit from a PC.

- Motion pictures that have been recorded on another device cannot be written to the software supplied with this unit. To write motion picture data recorded with the Panasonic High Definition Video Camera sold previously, use the HD Writer supplied with the unit.
- We cannot guarantee operation if you use software other than that supplied to read/write motion picture.
- Do not start the software supplied with this unit and other software at the same time. Close any other software if you start the software supplied with this unit and close the software supplied with this unit if you start any other software.
- Be sure to use the supplied USB cable when connecting this unit and a PC. (Operation is not guaranteed with any other USB cables.)
- We recommend reading or writing the data from SD card or PC by connecting this unit and PC with the supplied USB cable. In some cases, the SDHC memory card might not be compatible with the SD card slot that is built in the PC or the SD card reader/writer that you use. Moreover, the SD card might be damaged if it is inserted anywhere other than the SD card slot. Be sure to insert it in card slot for the SD card.

■ To use the HD Writer AE 1.5

You will need a high performance PC depending on the functions to be used. It may not properly play back or properly operate depending on the environment of the PC used. Refer to the operating environment and notes on page 110.

- Operation during the playback may become slow if the CPU or memory is not fulfilling the requirements of the operating environment.
- Always use the most current driver for the video card.
- Always make sure there is enough capacity on the HDD in the PC. It may become inoperable or the operation may stop suddenly if the capacity gets low.

End User License Agreement

Before opening the CD-ROM package, please read the following.

You ("Licensee") are granted a license for the Software defined in this End User License Agreement ("Agreement") on condition that you agree to the terms and conditions of this Agreement. If Licensee does not agree to the terms and conditions of this Agreement, promptly return the Software to Panasonic Corporation ("Panasonic"), its distributors or dealers from which you made the purchase.

Article 1 License

Licensee is granted the right to use the software, including the information recorded or described on the CD-ROM, instruction manuals, and any other media provided to Licensee (collectively "Software"), but all applicable rights to patents, copyrights, trademarks and trade secrets in the Software are not transferred to Licensee.

Article 2 Use by a Third Party

Licensee may not use, copy, modify, transfer or allow any third party, whether free of charge or not, to use, copy or modify the Software, except as expressly provided for in this Agreement.

Article 3 Restrictions on Copying the Software

Licensee may make a single copy of the Software in whole or a part solely for back-up purpose.

Article 4 Computer

Licensee may use the Software only on one computer, and may not use it on more than one computer.

Article 5 Reverse Engineering, Decompiling or Disassembly

Licensee may not reverse engineer, decompile, or disassemble the Software, except to the extent either of them is permitted under law or regulation of the country where Licensee resides. Panasonic, or its distributors will not be responsible for any defects in the Software or damage to Licensee caused by Licensee's reverse engineering, decompiling, or disassembly of the Software.

Article 6 Indemnification

The Software is provided "AS-IS" without warranty of any kind, either expressed or implied, including, but not limited to, warranties of non-infringement, merchantability and/or fitness for a particular purpose. Further, Panasonic does not warrant that the operation of the Software will be uninterrupted or error free. Panasonic or any of its distributors will not be liable for any damage suffered by Licensee arising from or in connection with Licensee's use of the Software.

Article 7 Export Control

Licensee agrees not to export or re-export to any country the Software in any form without the appropriate export licenses under regulations of the country where Licensee resides, if necessary.

Article 8 Termination of License

The right granted to Licensee hereunder will be automatically terminated if Licensee contravenes any of the terms and conditions of this Agreement. In this event, Licensee must destroy the Software and related documentation together with all the copies thereof at Licensee's own expense.

Operating environment

- Even if the system requirements mentioned in these operating instructions are fulfilled, some PCs cannot be used.
- A CD-ROM drive is necessary to install the supplied software applications. (A compatible BD/DVD writer drive and media are necessary for writing to a BD/DVD.)
- Operation is not guaranteed in the following cases.
 - When 2 or more USB devices are connected to a PC, or when devices are connected through USB hubs or by using extension cables.
 - Operation on an upgraded OS.
 - Operation on an OS other than the one pre-installed.
- This software is not compatible with Microsoft Windows 3.1, Windows 95, Windows 98, Windows 98SE, Windows Me, Windows NT and Windows 2000.

■ Operating environment for HD Writer AE 1.5

PC	IBM PC/AT compatible PC
OS	Microsoft Windows XP Home Edition Service Pack 2/Service Pack 3 Microsoft Windows XP Professional Service Pack 2/Service Pack 3 Microsoft Windows Vista Home Basic or Service Pack 1 Microsoft Windows Vista Home Premium or Service Pack 1 Microsoft Windows Vista Ultimate or Service Pack 1 Microsoft Windows Vista Business or Service Pack 1
CPU	Intel Pentium III 1.0 GHz or higher (including compatible CPU) <ul style="list-style-type: none"> • Intel Core 2 Duo 2.16 GHz or higher, Intel Pentium D 3.2 GHz or higher or AMD Athlon™ 64 X2 Dual-Core 5200+ or higher is recommended when a playback function or MPEG2 output function is used. • Intel Core 2 Quad 2.6 GHz or higher is recommended when using the editing or Continuous Photo Playback function.
RAM	Windows Vista: 1 GB or more Windows XP: 512 MB or more (1 GB or more recommended)
Display	High Color (16 bit) or more (32 bit or more recommended) Desktop resolution of 1024×768 pixels or more (1280×1024 pixels or more recommended) Windows Vista: DirectX 9.0c compatible video card (DirectX 10 recommended) with DirectDraw overlay Windows XP: DirectX 9.0c compatible video card Compatible with DirectDraw overlay PCI Express™×16 compatible recommended
Free hard disk drive space	Ultra DMA — 100 or more 450 MB or more (for installing the application) <ul style="list-style-type: none"> • When writing to a DVD/BD/SD, more than double the amount of free space as the disc being created is necessary.

Sound	DirectSound Support
Interface	USB port [Hi-Speed USB (USB 2.0)]
Other requirements	Mouse or equivalent pointing device Internet connection

- Supplied CD-ROM is available for Windows only.
- Input is not supported in languages other than English, German, French and Simplified Chinese.
- Operation cannot be guaranteed on all BD/DVD drives.
- Operation is not guaranteed on Microsoft Windows Vista Enterprise, Windows XP Media Center Edition, Tablet PC Edition and not compatible with 64 bit operation systems.
- This software is not compatible with a multi-boot environment.
- This software is not compatible with a multi-monitor environment.
- If using Windows XP, an administrative account user only can use this software. If using Windows Vista, administrative account and standard account users only can use this software. (An administrative account user should install and uninstall this software.)

■ Operating environment for the card reader function (mass storage)

PC	IBM PC/AT compatible PC
OS	Microsoft Windows XP Home Edition Service Pack 2/Service Pack 3 Microsoft Windows XP Professional Service Pack 2/Service Pack 3 Microsoft Windows Vista Home Basic or Service Pack 1 Microsoft Windows Vista Home Premium or Service Pack 1 Microsoft Windows Vista Ultimate or Service Pack 1 Microsoft Windows Vista Business or Service Pack 1 Microsoft Windows Vista Enterprise or Service Pack 1
CPU	Windows Vista: 32-bit (×86) Intel Pentium III 1.0 GHz or higher processor Windows XP: Intel Pentium III 450 MHz or higher or Intel Celeron 400 MHz or higher
RAM	Windows Vista Home Basic: 512 MB or more Windows Vista Home Premium/Ultimate/Business/Enterprise: 1 GB or more Windows XP: 128 MB or more (256 MB or more recommended)
Interface	USB port
Other requirements	Mouse or equivalent pointing device

- The USB equipment operates with the driver installed as standard in the OS.

When installing the software, log on to your computer as the Administrator or with a user name with equivalent authorization. (If you do not have authorization to do this, consult your manager.)

- Before starting the installation, close all applications that are running.
- Do not perform any other operations on your PC while the software is being installed.

For Windows Vista:

If [User Account Control] dialog appears, click [Continue].

1 Insert the CD-ROM into the PC.

- If the installation screen does not appear automatically, double-click the CD-ROM drive icon in [My Computer (Computer)].

2 Click [Next].

3 Select where the application is to be installed, then click [Next].

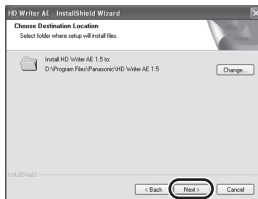

4 Select [Yes] or [No] to create shortcut.

5 Select the country or region where you live, then click [Next].

- If the country or region cannot be selected, select [NTSC Area].

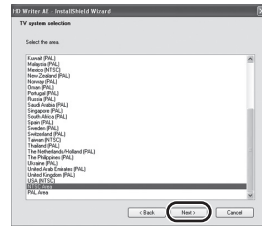

- When the confirmation message appears, click [Yes].

6 Click [Install] to start the installation process.

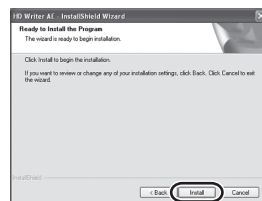

- A message regarding the playback in the environment used may be displayed depending on the performance of the PC used. Click [OK] after confirming.

7 When installation is complete, some notes will appear

Check the contents, then close the window.

8 Select **[Yes, I want to restart my computer now.]**, then click **[Finish]**.



The PC must be rebooted for the application to work.

■ Uninstalling HD Writer AE 1.5

Follow the steps below to uninstall any software applications that you no longer require.

1 Select **[start] → ([Settings] →) [Control Panel] → [Add or Remove Programs (Applications)]** or **[Uninstall a program]**.

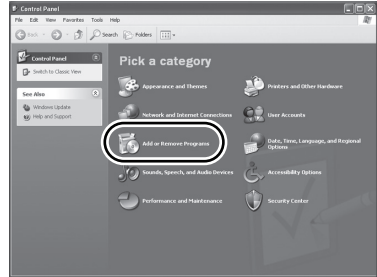

2 Select **[HD Writer AE 1.5]**, then click **[Change/Remove]** (**[Change or Remove]** or **[Add/Remove]**) or **[Uninstall]**.

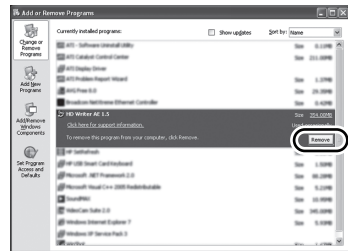

- Proceed with the uninstallation by following the on-screen instructions.
- After uninstalling the software, be sure to reboot the PC.

Connecting to a PC

- Connect this unit to the PC after the software applications are installed.
- Remove the supplied CD-ROM from your PC.

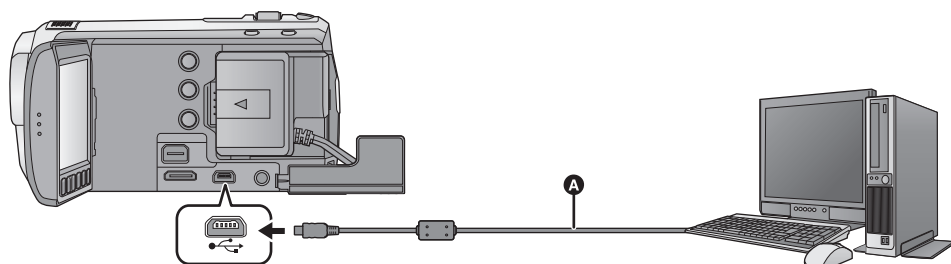

- A** USB cable (supplied)

1 Connect this unit to the AC adaptor.

- It is possible to use the unit connected to the PC with the batteries only, but you will not be able to write data into the unit.

2 Turn on the unit.

- This function is available in all modes.

3 Connect this unit to a PC.

The USB function selection screen will appear.

- Insert the USB connectors as far as they will go.
- Do not use any other USB cables except the supplied one. (Operation is not guaranteed with any other USB cables.)

- When you select an option other than [PC], reconnect the USB cable.

- **When the unit is connected to a PC, its power cannot be turned off. Disconnect the USB cable, before turning this unit off.**

- Do not disconnect the USB cable or the AC adaptor while the access lamp is on or card access icon () appears on the unit screen.

- **HDC-TM10**
Do not disconnect the USB cable or the AC adaptor while the access lamp is on or built-in memory access icon () appears on the unit screen.

4 Touch [PC].

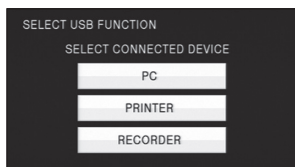

- The Smart wizard screen is automatically displayed when HD Writer AE 1.5 is installed.
- This unit is automatically recognized as an external drive of the PC. (→ 116)

■ If the driver has not been recognized properly

Use the following methods to enable it to be recognized.

Method 1:

Turn off the unit and your PC once and try verifying again.



Method 2:

Remove the SD card and try verifying again.

Method 3:

Try connecting the unit to another USB port on your PC.

■ To disconnect USB cable safely

- 1 Double click the  () icon in task tray displayed on the PC.
 - Depending on your PC's settings, this icon may not be displayed.
- 2 Select [USB Mass Storage Device] and click [Stop].
- 3
Verify [MATSHITA HDC-SD10/SD USB Device] is selected and click [OK].

Verify [MATSHITA HDC-TM10/SD USB Device] or [MATSHITA HDC-TM10/MEM USB Device] is selected and click [OK].

About the PC display

When the unit is connected to a PC, it is recognized as an external drive.

- Removable disk (Example: ) is displayed in [My Computer (Computer)].

We recommend using HD Writer AE 1.5 to copy or write back motion picture data. Using Windows Explorer or other programs on the PC to copy, move or rename files and folders recorded with this unit will result in them being unusable with HD Writer AE 1.5. It is impossible to write data to the built-in memory on the unit from a PC.

Example folder structure of an SD card:

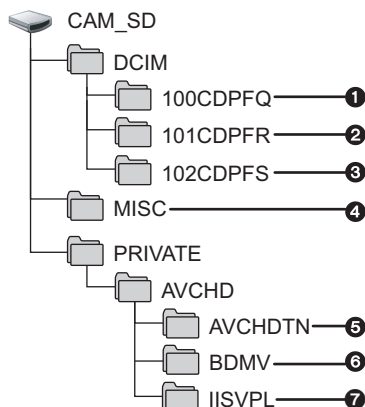

HDC-TM10

Example folder structure of built-in memory:

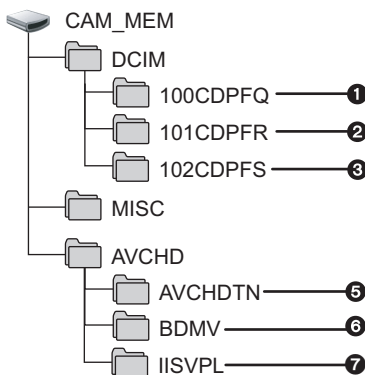

The following data will be recorded.

- 1 Up to 999 still pictures in JPEG format ([S1000001.JPG] etc.)
- 2 JPEG format still pictures recorded in Hi-speed Burst Shooting Mode
- 3 JPEG format still pictures created from the motion picture
- 4 The DPOF setting files
- 5 The motion picture thumbnails
- 6 AVCHD format motion picture files ([00000.MTS] etc.)
- 7 Files for Intelligent Scene Selection playback

■ Copying your still pictures to your PC

Card reader function (mass storage)

Still pictures recorded with this unit can be copied to the PC with Explorer or other programs.

- 1 Double click the folder that contains the still pictures. ([DCIM] → [100CDPFQ] etc.)
- 2 Drag and drop the still pictures onto the destination folder (on the PC's HDD).

- Do not delete the SD card's folders. Doing so may make the SD card unuseable in this unit.
- When data not supported by this unit has been recorded on a PC, it will not be recognized by this unit.
- Always use this unit to format SD cards.

Starting HD Writer AE 1.5

- When using HD Writer AE 1.5 on Windows XP, log on to your computer as Administrator (or with a login name equally authorized). If you log on with a login name other than Administrator, you cannot use the applications.
- When using HD Writer AE 1.5 on Windows Vista, log on to your computer as Administrator (or with a login name equally authorized) or with the user name for a standard user account. If you log on with a user name for a guest user account, the software cannot be used.

(On the PC)

Select [start] → [All Programs (Programs)] → [Panasonic] → [HD Writer AE 1.5] → [HD Writer AE].



- For details on how to use the software applications, read the PDF operating instructions of the software.

Reading the operating instructions of the software applications

- You will need Adobe Acrobat Reader 5.0 or later or Adobe Reader 7.0 or later to read the PDF operating instructions.

Select [start] → [All Programs (Programs)] → [Panasonic] → [HD Writer AE 1.5] → [Operating Instructions].



If using Mac

- HD Writer AE 1.5 is not available for Mac.
- iMovie'09 supported. For details about iMovie'09, please contact Apple Inc.

■ Operating environment

PC	Mac
OS	Mac OS X 10.5.6
CPU	Intel Core Duo Intel Core 2 Duo
RAM	1 GB or more
Interface	USB port

- Even if the system requirements mentioned in these operating instructions are fulfilled, some PCs cannot be used.
- The USB equipment operates with the driver installed as standard in the OS.
- Supplied CD-ROM is available for Windows only.

■ Copying still pictures on PC

1 Connect this unit to a PC via the supplied USB cable.

- The USB function selection screen will appear.

2 Touch [PC].

3 Double-click [CAM_SD] or [CAM_MEM] displayed on the desktop.

- Files are stored in [100CDPFQ] or [101CDPFR] folder etc. in the [DCIM] folder.

4 Using a drag-and-drop operation, move the pictures you want to acquire or the folder storing those pictures to any different folder on the PC.

■ To disconnect USB cable safely

Drag [CAM_SD] or [CAM_MEM] disk icon to the [Trash], and then disconnect the USB cable.

* (HDC-TM10) only

■ Recording indications

Motion picture recording

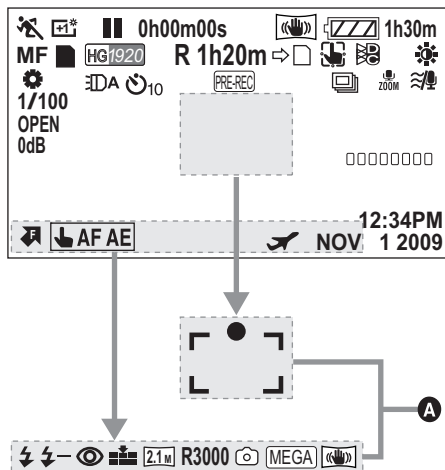

A Still picture recording
(when the button is pressed halfway)



Remaining battery power
(→ 22)

1h30m Remaining battery time (→ 22)

R 1h20m Remaining time for motion picture recording (→ 43)

0h00m00s Elapsed recording time (→ 43)

NOV 1 2009 Date indication (→ 34)

12:34PM Time indication (→ 34)



World time setting (→ 35)

Motion picture recording mode
(→ 44)



HA mode



HG mode



HX mode



HE mode



Built-in memory recording possible status*

■ (White) Card recording possible status

■ (Green) Recognizing the card

●/II (Red) Recording

II (Green) Recording pause

PRE-REC PRE-REC (→ 45)

MNL Manual mode (→ 66)

Intelligent auto mode (→ 39)



Normal mode



Portrait mode



Scenery mode



Spotlight mode



Low light mode



Operation icon is displayed/not displayed. (→ 53)

MF Manual focus (→ 69)

White balance (→ 67)



Auto white balance



Sunny mode



Cloudy mode



Indoor mode 1



Indoor mode 2













































Manual adjustment mode

1/100 Shutter speed (→ 68)

















OPEN, F2.0 Iris value (→ 68)

0dB Gain value (→ 68)

	Scene mode (→ 56)
	Sports mode
	Portrait mode
	Spotlight mode
	Snow mode
	Beach mode
	Sunset mode
	Fireworks mode
	Scenery mode
	Low light mode
	Power LCD (→ 36)
	Image stabilizer (→ 50)
	AF tracking (→ 51)
	Relay recording (→ 58)*
	Video light (→ 52)
	Picture adjustment (→ 69)
	Digital cinema (→ 57)
	Hi-speed burst shooting (→ 62)
	Digital cinema color (→ 60)
	Zoom magnification indication (→ 49)
	Zoom microphone (→ 60)
	Wind noise reduction (→ 60)
	Microphone level (→ 61)
	Backlight compensation (→ 54)
	Soft skin mode (→ 54)
	Tele macro (→ 54)
	Fade (White), Fade (Black) (→ 54)
	MagicPix function (→ 54)
	Intelligent contrast control (→ 54)
	Focus indication (→ 46)
	Focus indication (→ 46)
	Self-Timer recording (→ 63)
	Flash (→ 63)
	Flash level (→ 63)



	Red eye reduction (→ 64)
	Picture quality (→ 47)
	Number of recording pixels for still pictures (→ 48)
	1920×1080
	Remaining number of still pictures (→ 47)
	(White) Still picture recording possible status
	(Red) Recording still picture
	MEGA OIS (→ 46)

■ Playback indications



	Playback (→ 70, 78)
	Pause (→ 70, 78)
	Fast forward/rewind playback (→ 71)
	Last/first scene paused
	Slow motion playback (→ 71)
	Frame-by-frame playback (→ 72)
	Next/Previous still picture (→ 78)
	Operation icon is displayed/not displayed. (→ 70, 77)
0h00m00s	Playback time
	Intelligent scene selection (→ 74)
No.10	Scene number
	Volume adjustment (→ 71)
	Repeat playback (→ 76)
	Resume playback (→ 76)
100-0001	Still picture folder/file name (→ 77)
PictBridge	When a printer compatible with PictBridge is connected (→ 104)
 1	DPOF already set (to more than 1) (→ 84)
	Protected motion pictures/still pictures (→ 83)
	Relay recorded scene (→ 58)*
	Number of recording pixels for still pictures (→ 48, 62)
	1920×1080
	1280×720

The picture size is not displayed for still pictures recorded with other products that have different picture sizes from the sizes shown above.









■ PC connection indications

	Accessing the card (When connected to a PC) (→ 114)
	Accessing the built-in memory (When connected to a PC) (→ 114)*

■ Confirmatory indications

-- (Time display)	The built-in battery is low. (→ 34)
	The warning/alarm indication appears when LCD monitor is rotated towards the lens side. Return the direction of the LCD monitor to normal position and check the warning/alarm indication.
	No SD card is inserted/unusable card.

■ Confirmatory indications when a DVD burner is connected

	Disc playback (→ 101)
	Scene copied in [Standard (XP)]
	Scene copied in [Standard (SP)]
	Disc type (→ 96)
	DVD-RAM
	DVD-RW
	DVD-R
	DVD-R DL (Dual layer on single side)
	Unusable disc

Major confirmation/error messages to be indicated on the screen in text.

RECOMMEND DATA BACK UP PERIODICALLY.*

We recommend backing up important recorded motion pictures and still pictures periodically to a PC, DVD disc etc. to protect it. This message does not indicate that there is a problem with this unit.

CHECK CARD.

This card is not compatible or it cannot be recognized by the unit.

If this message appears even though motion pictures and still pictures are recorded on an SD card, the card may be unstable. Reinsert the SD card, then turn the power off and then on again.

THIS BATTERY CANNOT BE USED.

- Use a battery that is compatible with this unit. (→ 19)
If using a Panasonic battery compatible with this unit, remove the battery and then insert it again. If the message appears even after repeating this several times, this unit needs repair. Detach the power and contact consumer support. (→ 145, 146) Do not attempt to repair it by yourself.
- You are attempting to connect an AC adaptor not compatible with this unit. Use the supplied AC adaptor. (→ 23)

CANNOT CHECK CONNECTED DEVICE. DISCONNECT THE USB CABLE FROM THIS UNIT.

- The DVD burner is not correctly connected.
Disconnect and then reconnect the Mini AB USB Connection Cable.
- Connect a DVD burner that is compatible with this unit. (→ 96)

PLEASE CHECK EXTERNAL DRIVE OR DISC.

A disc that cannot be used when connecting the unit to the DVD burner has been inserted, or the DVD burner is not recognized properly. Connect the Mini AB USB Connection Cable again and insert a disc to copy the data. (→ 96)

DISCONNECT USB CABLE.

The unit cannot correctly establish the connection to the PC or printer. Disconnect and then reconnect the USB cable.

* HDC-TM10 only

About recovery

If faulty management information is found, one of the following messages may appear. Be sure to follow directions in the messages. (Repairing may take time depending on the error.)

CONTROL DATA ERROR HAS BEEN DETECTED. (SD CARD)

CONTROL DATA ERROR DETECTED IN THE BUILT-IN MEMORY.*

THUMBNAIL DATA ERROR IS DETECTED.

* [HDC-TM10] only

- The following message is displayed when abnormal management information is detected when the scenes are displayed in thumbnail. To perform the repair, touch the scene with [!] in the thumbnail, and start the playback. Please be aware that if the repair fails, scenes with [I] will be deleted.

SOME SCENES NEED REPAIRING. PLAY SCENES TO BE REPAIRED. (IRREPARABLE SCENES WILL BE DELETED.)

-
- Use a sufficiently charged battery or the AC adaptor.
 - Depending on the condition of the data, it may not be possible to completely repair the data.
 - When data recorded on another device is recovered, it may not be possible to play back the data on this unit or the other device.
 - If recovery fails, turn the power of the unit off and on again after waiting a while. If recovery fails repeatedly, format a media on the unit. Please be aware that if a media is formatted, then all the data recorded on the media will be erased.
 - If the thumbnail information is recovered, displaying the thumbnails may become slower.

Functions that cannot be used simultaneously

Some functions in this unit are disabled or cannot be selected due to the unit's specifications.

Functions	Conditions which disable the functions
Motion picture recording	<ul style="list-style-type: none"> • When the Hi-speed Burst Shooting mode is on
PRE-REC	<ul style="list-style-type: none"> • When the Hi-speed Burst Shooting mode is on
Intelligent auto mode	<ul style="list-style-type: none"> • In Manual Mode • When the MagicPix function is used • When the Digital Cinema is used • When the Hi-speed Burst Shooting mode is on
AF tracking	<ul style="list-style-type: none"> • When the Digital Cinema is used • When the Scene Mode is used
Scene mode	<ul style="list-style-type: none"> • When the MagicPix function is used • When the Hi-speed Burst Shooting mode is on
Digital zoom	<ul style="list-style-type: none"> • When the Digital Cinema is used • When the Hi-speed Burst Shooting mode is on
Guide lines	<ul style="list-style-type: none"> • When the Intelligent auto mode is on • When the AF tracking is used
Change of recording mode	<ul style="list-style-type: none"> • When the Hi-speed Burst Shooting mode is on
Digital cinema	<ul style="list-style-type: none"> • When the Motion Picture Recording mode is HX/HE • When the zoom mode is set to [D.Zoom 40×] or [D.Zoom 1000×] • When the Hi-speed Burst Shooting mode is on • When the AF tracking is used • When the Intelligent auto mode is on
Fade	<ul style="list-style-type: none"> • When PRE-REC is used • When the Hi-speed Burst Shooting mode is on
AGS	<ul style="list-style-type: none"> • When the Hi-speed Burst Shooting mode is on
Auto slow shutter	<ul style="list-style-type: none"> • When the Hi-speed Burst Shooting mode is on • When the Scene Mode is used
Backlight compensation	<ul style="list-style-type: none"> • When the MagicPix function is used • When the iris/gain is set
Intelligent contrast control	<ul style="list-style-type: none"> • When the MagicPix function is used • When the iris/gain is set
Soft skin mode	<ul style="list-style-type: none"> • When the Intelligent auto mode is on

Functions	Conditions which disable the functions
Tele macro	<ul style="list-style-type: none"> ● When the Sunset, Fireworks or Scenery mode of Scene mode is used
MagicPix	<ul style="list-style-type: none"> ● When the Hi-speed Burst Shooting mode is on ● When the Digital Cinema is used ● When the AF tracking is used
Soft skin mode (Set and cancel)	<ul style="list-style-type: none"> ● While recording ● When PRE-REC is used
Tele macro (Set and cancel)	
MagicPix (Set and cancel)	
Digital cinema color	<ul style="list-style-type: none"> ● When the MagicPix function is used ● When the Hi-speed Burst Shooting mode is on
Shooting guide	<ul style="list-style-type: none"> ● When the AF tracking is used
Wind noise reduction	<ul style="list-style-type: none"> ● When the Hi-speed Burst Shooting mode is on
Zoom microphone	<ul style="list-style-type: none"> ● When the Hi-speed Burst Shooting mode is on ● When the Intelligent auto mode is on
Microphone level	<ul style="list-style-type: none"> ● When the Hi-speed Burst Shooting mode is on
MF assist function	<ul style="list-style-type: none"> ● When Digital Zoom (16× or higher) is used
Hi-speed burst shooting mode	<ul style="list-style-type: none"> ● When the zoom mode is set to [D.Zoom 40×] or [D.Zoom 1000×] ● When the AF tracking is used ● When the Intelligent auto mode is on
Flash	<ul style="list-style-type: none"> ● While recording motion pictures ● When PRE-REC is used ● When the MagicPix function is used ● When the Hi-speed Burst Shooting mode is on ● When the Sunset or Fireworks mode of Scene mode is used.
Shutter sound	<ul style="list-style-type: none"> ● While recording motion pictures ● When PRE-REC is used
Change of white balance	<ul style="list-style-type: none"> ● When Digital Zoom (16× or higher) is used ● When the MagicPix function is used ● When the Beach, Sunset or Fireworks mode of Scene mode is used
Adjusting the shutter speed, iris/gain	<ul style="list-style-type: none"> ● When the MagicPix function is used ● When the Scene mode is used ● When the Hi-speed Burst Shooting mode is on

Troubleshooting

Problem

This unit cannot be turned on.

This unit does not stay on long enough.

Battery runs down quickly.

This unit is turned off automatically.





A clicking sound is heard when the unit is shaken about.

Remaining battery indication is not displayed properly.

Check points

- Charge the battery using the AC adaptor. (→ 19)
 - The battery protection circuit may have operated. Attach the battery to the AC adaptor for 5 to 10 seconds. If the unit still cannot be used, the battery is faulty.
 - The battery is affected by ambient temperature. In cold places, the battery using time becomes shorter.
 - The battery has a limited life. If the operating time is still too short even after the battery is fully charged, the battery has worn out and needs to be replaced.
- ▶▶▶
- If you connect to a TV compatible with VIERA Link with a HDMI mini cable and turn off the power on the TV with the remote control for the TV, the power on this unit also turns off. If you are not using VIERA Link, set [VIERA Link] to [OFF]. (→ 94)
 - When this unit is connected to a DVD burner to copy or play back images (a disc is being accessed), the power turns off automatically if the Mini AB USB Connection Cable is removed.
- ▶▶▶
- This is the sound of the lens moving and is not a defect. This sound will no longer be heard when the unit's power is turned on.
- ▶▶▶
- The remaining battery capacity indication is an approximation. If you think the remaining battery capacity indication is not displayed correctly, fully charge the battery, discharge it and then charge it again. (Even if this operation is performed, it may not be possible to display the remaining battery capacity correctly if the battery was used for a long period of time where the temperature was low or high or if the battery was repeatedly charged.)

Problem	Check points
<p>This unit cannot be operated though it is turned on.</p> <p>This unit does not operate normally.</p>	<ul style="list-style-type: none"> • Turn on the power again. If normal conditions are not restored yet, remove the battery or AC adaptor, wait about 1 minute and then reconnect the battery or AC adaptor. Then about 1 minute later, turn on the power again. (Conducting the above operation while the media is being accessed may damage the data on the media.) • If normal operation is still not restored, detach the power connected, and contact consumer support. (→ 145, 146)
<p>Recording does not start although power is supplied to this unit and the SD card is correctly inserted.</p>	<ul style="list-style-type: none"> • A message is displayed and you cannot record when the built-in memory does not operate normally, or when the SD card cover cannot be closed due to failure of the SD card cover. In this case, press the recording start/stop button to display the media change message, allowing you to change the recording media.
<p>Item other than the touched one is selected.</p>	<ul style="list-style-type: none"> • Calibrate the touch screen. (→ 37)
<p>The remaining time indication or the elapsed time indication is not shown.</p>	<ul style="list-style-type: none"> • If you set [SETUP] → [DISPLAY] → [OFF], indications other than warnings and date etc. are not displayed. (→ 31)
<p>The unit arbitrarily stops recording.</p>	<ul style="list-style-type: none"> • Use an SD card that can be used for motion picture recording. (→ 24) When the unit stops while a usable SD card for recording motion pictures (→ 24) is used, the data writing rate has deteriorated. We recommend formatting the SD card being used. (→ 89) • If [AGS] is [ON], record in the normal horizontal position or set [AGS] to [OFF]. (→ 58) • Repeated recording and deletion of motion pictures may reduce the usable time for recording on a media you use. In that case, format the media.
<p>AF tracking does not work when the object is touched.</p>	<ul style="list-style-type: none"> • Touch the part of the object that has specific color such as the part that is different from the surrounding. (→ 51)
<p>Auto focus function does not work.</p>	<ul style="list-style-type: none"> • Set the Intelligent auto mode to on or off. • If you are trying to record a scene which is hard to bring into focus in Auto Focus mode, use the Manual Focus mode to adjust the focus. (→ 40, 69)

Problem	Check points
<p>“ENVIRONMENT TOO DARK, OR LENS COVER CLOSED.” is displayed.</p>	<ul style="list-style-type: none"> • Before turning on the power, open the lens cover. • This message may also be displayed when recording in a very dark location.
<p>Color balance of images is strange when recording in a place such as a gymnasium.</p>	<ul style="list-style-type: none"> • In a place with multiple light sources, such as a gymnasium or a hall, set the white balance setting to  (Indoor mode2). If you cannot record clearly with the  (Indoor mode2), set it to  (Manual adjustment mode). (→ 67)
<p>Some playback images are skipped automatically.</p> <p>Scene does not play back to the end.</p>	<ul style="list-style-type: none"> • Playback of  (Intelligent scene selection) is set. Return to normal playback. (→ 74)
<p>Although this unit is correctly connected to a TV, images cannot be seen.</p> <p>The images are squeezed horizontally.</p>	<ul style="list-style-type: none"> • Please read the operating instructions of your TV and select the channel that matches the input used for the connection. • Change the [TV ASPECT] setting to match the aspect ratio of the TV. • Change the setting of the unit depending on the cable connecting to the TV. (→ 90, 93)
<p>Scenes cannot be deleted.</p>	<ul style="list-style-type: none"> • Release the protect setting. (→ 83) • Any scenes/still pictures where the thumbnails are displayed as  cannot be deleted. If the scenes/still pictures are unnecessary, format the media to erase the data. (→ 89) Please be aware that if a media is formatted then all the data recorded on the media is erased and cannot be recovered. Back up important data on a PC, disc etc.
<p>If the SD card is inserted in this unit, it is not recognized.</p>	<ul style="list-style-type: none"> • If the SD card is formatted on a PC, it may not be recognized by this unit. Use this unit to format SD cards. (→ 89)
<p>If the SD card is inserted in another device, it is not recognized.</p>	<ul style="list-style-type: none"> • Check that the device is compatible with the capacity or type of SD card (SD Memory Card/SDHC Memory Card) that you inserted. Refer to the operating instructions of the device for details.

Problem

Color or brightness of the image changes, or you may see horizontal bars in the image.



Object seems to be warped.



White round spots like soap bubbles appear on the recorded picture.



"ERROR OCCURRED. PLEASE TURN UNIT OFF, THEN TURN ON AGAIN." is displayed.



VIERA Link does not work.



Check points

- Color or brightness of the image may change, or you may see horizontal bars in the image when the object is recorded under fluorescent light, mercury light or sodium light, etc., but this is not a malfunction. In this case, record in Auto Mode or set the shutter speed to 1/60 in areas where the power supply frequency is 60 Hz, or 1/100 in areas of 50 Hz.

- Object seems to be warped slightly when the object moves across the image very fast, but this is because the unit is using MOS for the image sensor. This is not a malfunction.

- If you take a picture with the flash in a dark place or indoors, white round spots may appear on the picture caused by the flash reflecting of particles of dust in the air. This is not a malfunction.



A characteristic of this is that the number of round spots and their position differ in every picture.



- The unit has automatically detected an error. Restart the unit by turning the power off and on.
- The power will be turned off in about 1 minute if the power is not turned off and on.
- Repair is needed if it is repeatedly displayed even if it is restarted. Detach the power connected, contact consumer support. (→ 145, 146) Do not attempt to repair the unit by yourself.

[Setting on this unit]

- Connect with a HDMI mini cable (optional). (→ 94)
- Press the MENU button, then touch [SETUP] → [VIERA Link] → [ON]. (→ 94)
- Turn the power to the unit off and then back on again.

[Setting on other devices]

- Depending on HDMI terminal of the TV, the input channel may not switch automatically. In this case, use the remote control for the TV to switch input. (For details on how to switch input, please read the operating instructions for the TV.)
- Check the VIERA Link setting on the connected device.
- Set the setting to control the VIERA Link of the TV to [Off] once, and the back to [On] again. (Refer to the operating instructions of the TV for details.)

Problem	Check points
<p>When connected by the USB cable, this unit is not detected by the PC.</p>	<ul style="list-style-type: none"> ● Select another USB terminal on the PC. ● Check the operating environment. (→ 110) ● Connect the supplied USB cable again after restarting the PC and turning on this unit again.
<p>When the USB cable is disconnected, an error message will appear on the PC.</p>	<ul style="list-style-type: none"> ● To disconnect the USB cable safely, double-click the  () icon in the task tray and follow the instructions on the screen.
<p>The power of the DVD burner cannot be turned on.</p>	<ul style="list-style-type: none"> ● When the unit is connected to the DVD burner, use the respective AC adaptors for both this unit and the DVD burner.
<p>Cannot see the PDF operating instructions for HD Writer AE 1.5.</p>	<ul style="list-style-type: none"> ● You will need Adobe Acrobat Reader 5.0 or later or Adobe Reader 7.0 or later to read the PDF operating instructions for HD Writer AE 1.5.
<p>Cannot copy scenes on the SD card by connecting to other equipment with the USB cable.</p>	<ul style="list-style-type: none"> ● Other equipment might have not recognized the SD card. Unplug the USB cable once, and reconnect it.

■ If scenes do not change smoothly when played back on another device

The images may be still for several seconds at the joins between the scenes if the following operations are performed when multiple scenes have been continuously played back using another unit.

- Just how smoothly the scenes will be played back depends on the playback unit. Depending on the unit used, the images may stop moving and become still for a moment even when none of the following conditions are applicable.
- It may not play back smoothly when the editing of scenes was done with the HD Writer AE 1.5, but it will play back smoothly if you set [Seamless settings] in the HD Writer AE 1.5. Refer to the operating instructions for the HD Writer AE 1.5.

■ When the scenes were recorded on different dates

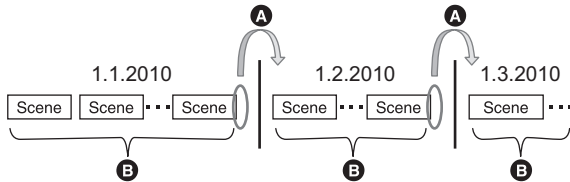

- A** The image will be still for several seconds wherever the date changes.
- B** The images are played back smoothly if the scenes were recorded on the same date.

■ When scenes lasting under 3 seconds have been recorded

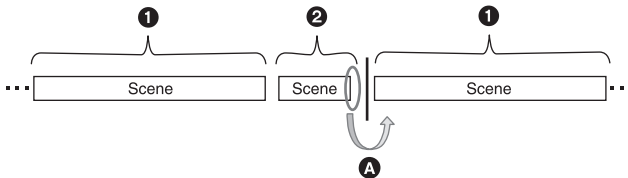

- 1** 3 or more seconds
- 2** Under 3 seconds
- A** The image will be still for several seconds after a scene which lasts under 3 seconds.

■ When PRE-REC was used for recording

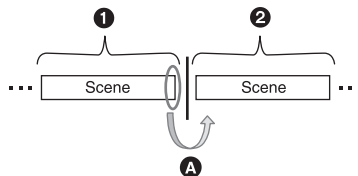

- 1** Normal recording
- 2** PRE-REC recording
- A** The picture momentarily stops at the end of the last scene that was recorded normally before PRE-REC recording.

■ When deleting scenes

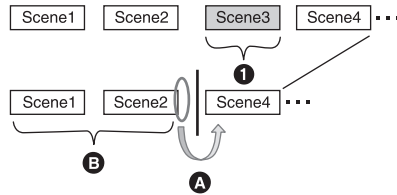

- ① Scene to be deleted
- Ⓐ The image will be still for several seconds wherever a scene was deleted.
- Ⓑ The images of consecutive scenes where there are no deletions are played back smoothly one after another.

■ When selected scenes are copied between an SD card and the built-in memory or when selected scenes are copied to a disc in a connected DVD burner.

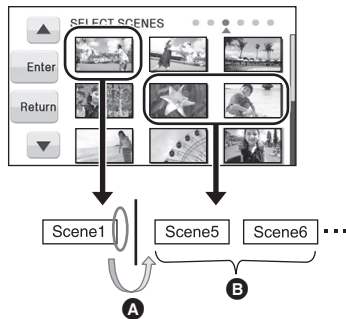

- Ⓐ If you select a scene other than the next scene, the picture may momentarily stop at the point where the scenes switch.
- Ⓑ The point where the scenes switch will be played back smoothly if you select the scenes in order.

■ Other cases

- If you record more than 99 scenes in the same date, scenes will be still for a few seconds at the switch of the scene per 99 scenes.
- When the recording mode was changed from HA/HG/HX to HE or from HE to HA/HG/HX, the picture momentarily stops where the scenes switch between HA/HG/HX and HE modes.

Cautions for use

About this unit

The unit and the SD card become warm during use. This is not a malfunction.

Keep the High Definition Video Camera as far away as possible from electromagnetic equipment (such as microwave ovens, TVs, video games etc.).

- If you use the High Definition Video Camera on top of or near a TV, the pictures and sound on the High Definition Video Camera may be disrupted by electromagnetic wave radiation.
- Do not use the High Definition Video Camera near cell phones because doing so may result in noise adversely affecting the pictures and sound.
- Recorded data may be damaged, or pictures may be distorted, by strong magnetic fields created by speakers or large motors.
- Electromagnetic wave radiation generated by microprocessors may adversely affect the High Definition Video Camera, disturbing the pictures and sound.
- If the High Definition Video Camera is adversely affected by electromagnetic equipment and stops functioning properly, turn the High Definition Video Camera off and remove the battery or disconnect AC adaptor. Then reinsert the battery or reconnect AC adaptor and turn the High Definition Video Camera on.

Do not use the High Definition Video Camera near radio transmitters or high-voltage lines.

- If you record near radio transmitters or high-voltage lines, the recorded pictures and sound may be adversely affected.

Make sure to use the supplied cords and cables. If you use optional accessories, use the cords and the cables supplied with them. Do not extend the cords and the cables.

Do not spray insecticides or volatile chemicals onto the unit.

- If the unit is sprayed with such chemicals, its body may be marred and the surface finish may peel off.

- Do not leave rubber or plastic products in contact with the unit for a long time.

When you use the unit in a sandy or dusty place such as a beach, do not let sand or fine dust get into the body and terminals of the unit.

Also, keep the unit away from sea water.

- Sand or dust may damage the unit. (Care should be taken when inserting and removing a card.)
- If sea water splashes onto the unit, wipe off the water with a well wrung cloth. Then wipe the unit again with a dry cloth.

When carrying the unit, do not drop or bump it.

- A strong impact can break the unit's casing, causing it to malfunction.

Cleaning

- Before cleaning, detach the battery or pull the AC cable from the AC outlet, and then wipe the unit with a soft, dry cloth.
- If the unit is very dirty, dip a cloth in water and squeeze firmly, and then wipe the unit with the damp cloth. Next, dry the unit with a dry cloth.
- Use of benzine, paint thinner, alcohol, or dishwashing liquid may alter the camera body or peel the surface finish. Do not use these solvents.
- When using a chemical dust cloth, follow the instructions that came with the cloth.

Do not use the unit for surveillance purposes or other business uses.

- This unit was designed for consumer intermittent use. It was not intended for continuous use, or for any industrial or commercial application resulting in prolonged use.
- In certain situations, continuous use could cause the unit to overheat and cause a malfunction. Such use is strongly discouraged.

When you are not going to use the unit for an extended time

- When storing the unit in a cupboard or cabinet, it is recommended that you place a desiccant (silica gel) in with it.

When disposing of or giving away this unit, note that:

- Formatting and deletion simply change the file management information and cannot be used to completely erase the data in built-in memory of this unit. The data can be recovered using commercially available software or the like.
- We recommend that you physically format the built-in memory before disposing of or giving away this unit.
- To physically format the built-in memory, connect the unit via the AC adaptor, select [FORMAT Built-in Memory] → [YES] from the menu, and then press and hold the delete button on the screen below for about 3 seconds. When the built-in memory data deletion screen appears, select [YES], and then follow the on-screen instructions.

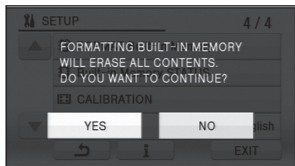

- Please look after the data in your built-in memory carefully. Panasonic will not be held responsible in the unlikely case that private data is divulged.

About the battery

The battery used in this unit is a rechargeable lithium-ion battery. It is susceptible to humidity and temperature and the effect increases the more the temperature rises or falls. In cold areas, the full charge indication may not appear or the low battery indication may appear about 5 minutes after starting use. At high temperatures, the protection function may be triggered, making it impossible to use the unit.

Be sure to detach the battery after use.

- If the battery is left attached, a minute amount of current continues to flow even if the unit's power is off. Keeping the unit in this state may result in over discharge of the battery. This may result in you not being able to use the battery even after it is charged.
- The battery should be stored in the vinyl bag so metal does not come into contact with the terminals.
- The battery should be stored in a cool place free from humidity, with as constant temperature as possible. (Recommended temperature: 15 °C to 25 °C (59 °F to 77 °F), Recommended humidity: 40% to 60%)
- Extremely high temperatures or low temperatures will shorten the life of the battery.
- If the battery is kept in high-temperature, high-humidity, or oily-smoky places, the terminals may rust and cause malfunctions.
- To store the battery for a long period of time, we recommend you charge it once every year and store it again after you have completely used up the charged capacity.
- Dust and other matter attached to the battery terminals should be removed.

Prepare spare batteries when going out for recording.

- Prepare batteries enough to last for 3 to 4 times the period you are planning to record for. Cold places such as a ski resort can shorten recording time.

If you drop the battery accidentally, check to see if the terminals are damaged.

- Attaching a battery with damaged terminals can damage the unit or AC adaptor.

Do not throw an old battery into fire.

- Heating a battery or throwing it into a fire may result in an explosion.

If the operating time is very short even after the battery has been recharged, the battery has worn out. Please purchase a new battery.

About the AC adaptor

- If the temperature of the battery is extremely high or extremely low, charging may take time or the battery may not be charged.
- If the charging lamp keeps flashing, make sure that the terminals of the battery or the AC adaptor are not exposed to dirt, foreign objects or dust, then reconnect them properly. Disconnect the AC cable from the AC outlet when you remove dirt, foreign objects or dust on the terminals of the battery or the AC adaptor. If the charging lamp is still flashing, the temperature of the battery may be extremely high or extremely low or something may be wrong with the battery or AC adaptor. Contact consumer support. (→ 145, 146)
- If you use the AC adaptor near a radio, radio reception may be disturbed. Keep the AC adaptor 1 m (3.3 feet) or more away from the radio.
- When using the AC adaptor, it may generate whirring sounds. However, this is normal.
- After use, be sure to disconnect the AC adaptor. (If it is left connected, a minute amount of current is consumed.)
- Always keep the electrodes of the AC adaptor and battery clean.

LCD monitor

- When the LCD monitor gets dirty, wipe it with a soft cloth such as eye glass cleaner.
- In a place with drastic temperature changes, condensation may form on the LCD monitor. Wipe it with a soft cloth and eye glass cleaner.
- When the unit has become very cold, for example due to storage in a cold area, its LCD monitor will be slightly darker than usual immediately after the power is turned on. The normal brightness will be restored when the unit's internal temperature rises.

Extremely high precision technology is employed to produce the LCD Monitor screen featuring a total of approximately 230,000 pixels. The result is more than 99.99% effective pixels with a mere 0.01% of the pixels inactive or always lit. However, this is not a malfunction and does not affect the recorded picture.

About condensation

When condensation forms on the unit, the lens will cloud up and the unit may not work properly. Make every effort to ensure that condensation does not form. If it does form, take the actions described below.

Causes of condensation

Condensation takes place when the ambient temperature or humidity is changed as follows.

- When this unit is brought inside from the cold (e.g. a ski slope) to a warm room.
- When this unit is moved from an air-conditioned car to outside.
- When a cold room has been warmed up quickly.
- When cool wind from an air conditioner is directly blown onto this unit.
- After summer afternoon showers of rain.
- When this unit is in a very humid place where the air is thick with steam. (e.g. a heated swimming pool)

Helpful hint

If, for example, you have used this unit for recording on a ski slope and are taking it into a heated room, place the unit inside a plastic bag, remove as much of the air from inside the bag as possible, then seal the bag. Leave the unit for about an hour in the room so the temperature of the unit is close to the ambient temperature of the room, then use it.

Specifications

High Definition Video Camera

Information for your safety

Power source:	DC 9.3 V (When using AC adaptor) DC 7.2 V (When using battery)
Power consumption:	Recording: <input type="checkbox"/> HDC-SD10 5.5 W <input type="checkbox"/> HDC-TM10 5.6 W

	HDC-SD10	HDC-TM10
Signal system	1080/60i	
Recording format	AVCHD format compliant	
Image sensor	1/6" 1MOS image sensor Total: 1470 K Effective pixels: Motion picture: 1170 K Still picture: 1170 K	
Lens	Auto Iris, F1.8 to F2.8 Focal length: 2.95 mm to 47.2 mm Macro (Full range AF) 35 mm equivalent: Motion picture/Still picture: 44.1 mm to 706 mm (16:9) Minimum focus distance: Normal: approx. 4 cm (1.6") (Wide)/approx. 1.2 m (3.9 feet) (Tele) Tele macro: approx. 50 cm (20") (Tele)	
Filter diameter	30.5 mm	
Zoom	16× optical zoom, 40×/1000× digital zoom	
Monitor	2.7" wide LCD monitor (approx. 230 K pixels)	
Microphone	Stereo (with a zoom microphone function)	
Speaker	1 round speaker, dynamic type	
White balance adjustment	Auto tracking white balance system	
Standard illumination	1,400 lx	
Minimum required illumination	Approx. 9 lx (1/30 in Low light mode) Approx. 1 lx with the MagicPix function	

		HDC-SD10	HDC-TM10
AV terminal video output level		1.0 Vp-p, 75 Ω, NTSC system	
Component terminal video output level		Y: 1.0 Vp-p, 75 Ω Pb: 0.7 Vp-p, 75 Ω Pr: 0.7 Vp-p, 75 Ω	
HDMI mini connector video output level		HDMI™ (x.v.Color™) 1080i/480p	
AV terminal audio output level (Line)		316 mV, 600 Ω, 2 ch	
HDMI mini connector audio output level		2 ch (Linear PCM)	
USB	SD card	Read/Write (No copyright protection support)	
	Built-in memory	–	Read only
		Hi-Speed USB (USB 2.0), USB terminal Type Mini AB PictBridge-compliant	
Flash		Available range: Approx. 1.0 m to 2.5 m (3.3 feet to 8.2 feet)	
Dimensions		47.5 mm (W)×63 mm (H)×114.5 mm (D) [1.87" (W)×2.48" (H)×4.51" (D)] (excluding projecting parts)	
Mass (Weight)		Approx. 227 g (Approx. 0.50 lbs.) [without battery (supplied) and an SD card (optional)]	Approx. 227 g (Approx. 0.50 lbs.) [without battery (supplied)]
Mass (Weight) in operation		Approx. 278 g (Approx. 0.61 lbs.) [with battery (supplied) and an SD card (optional)]	Approx. 278 g (Approx. 0.61 lbs.) [with battery (supplied)]
Operating temperature		0 °C to 40 °C (32 °F to 104 °F)	
Operating humidity		10% to 80%	
Battery operation time		See page 21	

Motion pictures

		HDC-SD10	HDC-TM10
Recording media	SD card	SD Memory Card: 1 GB, 2 GB (FAT12 and FAT16 system compliant) SDHC Memory Card: 4 GB, 6 GB, 8 GB, 12 GB, 16 GB, 32 GB (FAT32 system compliant)	
	Built-in memory	–	8 GB
Compression		MPEG-4 AVC/H.264	
Recording mode and transfer rate		HA: Approx. 17 Mbps (VBR) HG: Approx. 13 Mbps (VBR) HX: Approx. 9 Mbps (VBR) HE: Approx. 6 Mbps (VBR) Refer to page 44 for the recordable time.	
Picture size		HA/HG/HX: 1920×1080/60i HE: 1440×1080/60i	
Audio compression		Dolby Digital/2 ch	

Still pictures

		HDC-SD10	HDC-TM10
Recording media	SD card	SD Memory Card: 8 MB, 16 MB, 32 MB, 64 MB, 128 MB, 256 MB, 512 MB, 1 GB, 2 GB (FAT12 and FAT16 system corresponding) SDHC Memory Card: 4 GB, 6 GB, 8 GB, 12 GB, 16 GB, 32 GB (FAT32 system corresponding)	
	Built-in memory	–	8 GB
Compression		JPEG (Design rule for Camera File system, based on Exif 2.2 standard), DPOF corresponding	
Picture size		1920×1080 Refer to page 48 for the number of recordable pictures.	

AC adaptor







Information for your safety

Power source:	AC 110 V to 240 V, 50/60 Hz
Power consumption:	19 W
DC output:	DC 9.3 V, 1.2 A (Unit operation) DC 8.4 V, 0.65 A (Battery charging)

Dimensions	92 mm (W)×33 mm (H)×61 mm (D) [3.6 " (W)×1.3 " (H)×2.4 " (D)]
Mass (Weight)	Approx. 115 g (Approx. 0.25 lbs.)

Specifications may change without prior notice.

Optional accessories

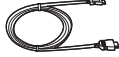
Accessory No.	Figure	Description
VW-AD21PP-K*1		AC adaptor with AC Cable and DC Cables
VW-VBG070*2		Rechargeable Lithium Ion Battery Pack
VW-VBG130*2		Rechargeable Lithium Ion Battery Pack
VW-VBG260*2		Rechargeable Lithium Ion Battery Pack <ul style="list-style-type: none"> • The battery pack holder kit VW-VH04 (optional) is necessary.
VW-VBG6*2		Rechargeable Lithium Ion Battery Pack <ul style="list-style-type: none"> • The battery pack holder kit VW-VH04 (optional) is necessary.
VW-VH04		Battery pack holder kit
RP-CDHM15 RP-CDHM30		HDMI mini cable

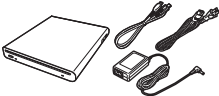
Accessory No.	Figure	Description
RP-SDM12GU1K RP-SDM06GU1K RP-SDM04GU1K RP-SDM02GU2A RP-SDM02GU1A		Class 4 12 GB SDHC Memory Card Class 4 6 GB SDHC Memory Card Class 4 4 GB SDHC Memory Card Class 4 2 GB SD Memory Card (Package of 2 cards) Class 4 2 GB SD Memory Card
RP-SDV32GU1K RP-SDV16GU1K RP-SDV08GU1K RP-SDV04GU1K RP-SDV02GU1A		Class 6 32 GB SDHC Memory Card Class 6 16 GB SDHC Memory Card Class 6 8 GB SDHC Memory Card Class 6 4 GB SDHC Memory Card Class 6 2 GB SD Memory Card
RP-SDP16GU1K RP-SDP12GU1K RP-SDP08GU1K RP-SDP04GU1K RP-SDP02GU1K		Class 4 16 GB SDHC Memory Card Class 4 12 GB SDHC Memory Card Class 4 8 GB SDHC Memory Card Class 4 4 GB SDHC Memory Card Class 4 2 GB SD Memory Card
RP-SDW32GU1K RP-SDW16GU1K RP-SDW08GU1K RP-SDW04GU1K RP-SDW02GU1K		Class 10 32 GB SDHC Memory Card Class 10 16 GB SDHC Memory Card Class 10 8 GB SDHC Memory Card Class 10 4 GB SDHC Memory Card Class 6 2 GB SD Memory Card
VW-BN1 VW-BN2		

*1 The supplied DC cables cannot be used on this unit.

*2 Please refer to page 21, concerning the battery charging time and available recording time.

NOTE:

Accessories and/or model numbers may vary by country. Please consult your local dealer.

Accessory Order Form (For USA and Puerto Rico Customers)

Please photocopy this form when placing an order.

1. Model # _____

2. Items Ordered

Accessory #	Description	Price Each	Quantity	Total Price
Subtotal				
Your State & Local Sales Tax				
Shipping & Handling				6.95
Total Enclosed				

3. Method of payment (check one)

- Check of Money Order enclosed (NO C.O.D.SHIPMENTS)
- VISA Credit Card # _____
- MasterCard Expiration Date _____
- Discover Customer Signature _____

Make Check or Money Order Payable to: PANASONIC ACCESSORIES

(Please do not send cash)

4. Shipping information (UPS delivery requires complete street address)

Ship To:

Mr.

Mrs.

Ms.

First _____ Last _____

Phone#:

Day () _____

Street Address _____

Night () _____

City _____ State _____ Zip _____

TO OBTAIN ANY OF OUR ACCESSORIES YOU CAN DO ANY OF
THE FOLLOWING:
VISIT YOUR LOCAL PANASONIC DEALER
OR
CALL PANASONIC'S ACCESSORY ORDER LINE AT 1-800-332-5368
[6 AM-6 PM M-F, PACIFIC TIME]
OR
MAIL THIS ORDER TO: PANASONIC SERVICE AND TECHNOLOGY COMPANY ACCESSORY ORDER OFFICE
20421 84th Avenue South Kent, WA. 98032

In CANADA, please contact your local Panasonic dealer for more information on Accessories.

Request for Service Notice (USA and Puerto Rico Only)

Please photocopy this form when making a request for service notice, in the unlikely event this product needs service.

Request for Service Notice:

- Please include your **proof of purchase**.
(Failure to do so will delay your repair.)
 - To further speed your repair, please provide an explanation of what is wrong with the unit and any symptom it is exhibiting.
-
-
-
-

Mail this completed form and your Proof of Purchase along with your unit to:
Panasonic Camera and Digital Service Center
1590 Touhy Ave.
Elk Grove Village, IL 60007

Limited Warranty (United States and Puerto Rico)

PANASONIC CONSUMER ELECTRONICS COMPANY,
DIVISION OF PANASONIC CORPORATION OF NORTH AMERICA
One Panasonic Way, Secaucus, New Jersey 07094

Panasonic Video Products Limited Warranty

Limited Warranty Coverage

If your product does not work properly because of a defect in materials or workmanship, Panasonic Consumer Electronics Company (referred to as "the warrantor") will, for the length of the period indicated on the chart below, which starts with the date of original purchase ("warranty period"), at its option either (a) repair your product with new or refurbished parts, or (b) replace it with a new or refurbished product. The decision to repair or replace will be made by the warrantor.

Product	Parts	Labor	Service	Contact Number
Camcorder	One (1) Year (except CCD Image Sensor) CCD Image Sensor - 6 (Six) Months	Ninety (90) Days Ninety (90) Days	Carry-In or Mail-In	1-800-211-PANA(7262)
DVD/VCR Deck, A/V Mixer	One (1) Year	Ninety (90) Days	Carry-In or Mail-In	1-800-211-PANA(7262)
TV/VCR, TV/DVD, TV/DVD/VCR Combination	One (1) Year (except CRT) CRT - Two (2) Years	Ninety (90) Days Ninety (90) Days	Carry-In: 21" CRT and Smaller In-Home or Carry-In: 22" CRT and Larger	1-800-211-PANA(7262)
TV/HDR Combination	One (1) Year (except CRT) CRT - Two (2) Years	Ninety (90) Days Ninety (90) Days	In-Home or Carry-In	1-888-843-9788
Rechargeable Batteries (in exchange for defective item)	Ten (10) Days	Not Applicable	Carry-In or Mail-In	1-800-211-PANA(7262)
Tape (in exchange for defective item)	Five (5) Days	Not Applicable	Carry-In or Mail-In	1-800-211-PANA(7262)
Memory Cards (in exchange for defective item)	Ninety (90) Days	Not Applicable	Carry-In or Mail-In	1-800-211-PANA(7262)

During the "Labor" warranty period there will be no charge for labor. During the "Parts" warranty period, there will be no charge for parts. You must carry-in or mail-in (prepaid) your product or arrange for in-home service, as applicable, during the warranty period. If non-rechargeable batteries are included, they are not warranted. This warranty only applies to products purchased and serviced in the United States or Puerto Rico. This warranty is extended only to the original purchaser of a new product which was not sold "as is". A purchase receipt or other proof of the original purchase date is required for warranty service.

Carry-In, Mail-in (Prepaid) or In-Home Service

For Carry-In, Mail-In (prepaid) or In-Home Service (as applicable) in the United States and Puerto Rico call toll free contact number listed above or visit Panasonic Web Site: <http://www.panasonic.com>

In-Home service, if applicable, requires clear, complete and easy access to the product by the authorized servicer and does not include removal or re-installation of an installed product. It is possible that certain in-home repairs will not be completed in-home, but will require that the product, or parts of the product, be removed for shop diagnosis and/or repair and then returned.

Limited Warranty Limits And Exclusions

This warranty ONLY COVERS failures due to defects in materials or workmanship, and DOES NOT COVER normal wear and tear or cosmetic damage, nor does it cover markings or retained images on the picture tube resulting from viewing fixed images (including, among other things, letterbox pictures on standard 4:3 screen TV's, or non-expanded standard 4:3 pictures on wide screen TV's, or onscreen data in a stationary and fixed location). The warranty ALSO DOES NOT COVER damages which occurred in shipment, or failures which are caused by products not supplied by the warrantor, or failures which result from accidents, misuse, abuse, neglect, bug infestation, mishandling, misapplication, alteration, faulty installation, set-up adjustments, misadjustment of consumer controls, improper maintenance, power line surge, lightning damage, modification, or commercial use (such as in a hotel, office, restaurant, or other business), rental use of the product, service by anyone other than a Factory Service Center or other Authorized Servicer, or damage that is attributable to acts of God.

THERE ARE NO EXPRESS WARRANTIES EXCEPT AS LISTED UNDER "LIMITED WARRANTY COVERAGE". THE WARRANTOR IS NOT LIABLE FOR INCIDENTAL OR CONSEQUENTIAL DAMAGES RESULTING FROM THE USE OF THIS PRODUCT, OR ARISING OUT OF ANYBREACH OF THIS WARRANTY.

(As examples, this excludes damages for lost time, cost of having someone remove or re-install an installed unit if applicable, or travel to and from the servicer, loss of media or images, data or other memory or recorded content. The items listed are not exclusive, but are for illustration only.)

ALL EXPRESS AND IMPLIED WARRANTIES, INCLUDING THE WARRANTY OF MERCHANTABILITY, ARE LIMITED TO THE PERIOD OF THE LIMITED WARRANTY.

Some states do not allow the exclusion or limitation of incidental or consequential damages, or limitations on how long an implied warranty lasts, so the exclusions may not apply to you. This warranty gives you specific legal rights and you may also have other rights which vary from state to state. If a problem with this product develops during or after the warranty period, you may contact your dealer or Service Center. If the problem is not handled to your satisfaction, then write to the warrantor's Consumer Affairs Department at the addresses listed for the warrantor.

PARTS AND SERVICE (INCLUDING COST OF AN IN-HOME SERVICE CALL, WHERE APPLICABLE) WHICH ARE NOT COVERED BY THIS LIMITED WARRANTY ARE YOUR RESPONSIBILITY.

Customer Services Directory (United States and Puerto Rico)

Service in Canada: As per Servicentre listed in Canadian warranty information on page 146.

Obtain Product Information and Operating Assistance; locate your nearest Dealer or Service Center; purchase Parts and Accessories; or make Customer Service and Literature requests by visiting our Web Site at:

<http://www.panasonic.com/help>

or, contact us via the web at:

<http://www.panasonic.com/contactinfo>

You may also contact us directly at:

1-800-211-PANA (7262),

Monday-Friday 9 am-9 pm; Saturday-Sunday 10 am-7 pm, EST

For hearing or speech impaired TTY users, TTY : 1-877-833-8855

Accessory Purchases (United States and Puerto Rico)

Purchase Parts, Accessories and Instruction Books online for all Panasonic Products by visiting our Web Site at:

<http://www.pstc.panasonic.com>

or, send your request by E-mail to:

npcparts@us.panasonic.com

You may also contact us directly at:

1-800-332-5368 (Phone) 1-800-237-9080 (Fax Only) (Monday – Friday 9 am to 9 pm, EST.)

Panasonic Service and Technology Company

20421 84th Avenue South,

Kent, WA 98032

(We Accept Visa, MasterCard, Discover Card, American Express, and Personal Checks)

For hearing or speech impaired TTY users, TTY : 1-866-605-1277

Product Repairs (United States and Puerto Rico)

MAIL TO:

Centralized Factory Service Center

Panasonic Camera and Digital Service Center

1590 Touhy Ave.

Elk Grove Village, IL 60007

Please carefully pack and ship, prepaid and insured, to the Elk Grove Village Centralized Factory Service Center.

As of October 2008

Warranty (For Canadian Customers)

Panasonic Canada Inc.

5770 Ambler Drive, Mississauga, Ontario L4W 2T3

PANASONIC PRODUCT – LIMITED WARRANTY

Panasonic Canada Inc. warrants this product to be free from defects in material and workmanship and agrees to remedy any such defect for a period as stated below from the date of original purchase.

Camcorder Product – One (1) year, parts and labour

LIMITATIONS AND EXCLUSIONS

This warranty does not apply to products purchased outside Canada or to any product which has been improperly installed, subjected to usage for which the product was not designed, misused or abused, damaged during shipping, or which has been altered or repaired in any way that affects the reliability or detracts from the performance, nor does it cover any product which is used commercially. Dry cell batteries are also excluded from coverage under this warranty.

This warranty is extended to the original end user purchaser only. A purchase receipt or other proof of date of original purchase is required before warranty service is performed.

THIS EXPRESS, LIMITED WARRANTY IS IN LIEU OF ALL OTHER WARRANTIES, EXPRESS OR IMPLIED, INCLUDING ANY IMPLIED WARRANTIES OF MERCHANTABILITY AND FITNESS FOR A PARTICULAR PURPOSE.

IN NO EVENT WILL PANASONIC CANADA INC. BE LIABLE FOR ANY SPECIAL, INDIRECT OR CONSEQUENTIAL DAMAGES.

In certain instances, some jurisdictions do not allow the exclusion or limitation of incidental or consequential damages, or the exclusion of implied warranties, so the above limitations and exclusions may not be applicable.

WARRANTY SERVICE

FOR PRODUCT OPERATION ASSISTANCE, please contact:

Our Customer Care Centre:	Telephone #:	(905) 624-5505
	1-800 #:	1-800-561-5505
	Fax #:	(905) 238-2360
	Email link:	"Customer support" on www.panasonic.ca

FOR PRODUCT REPAIRS, please locate your nearest Authorized Servicentre at www.panasonic.ca :

Link: "Servicentres™ locator" under "Customer support"

IF YOU SHIP THE PRODUCT TO A SERVICENTRE

Carefully pack and send prepaid, adequately insured and preferably in the original carton.

Include details of the defect claimed, and proof of date of original purchase.

Index

■ A

A/V terminal	16, 90, 103
AC adaptor	19, 23, 135
AF tracking	51
Alert sound	32
Auto focus	40
Auto Ground-Directional Standby (AGS)	58
Auto slow shutter	59
Automatic face framing	59
Automatic white balance	40
AVCHD	11

■ B

Backlight compensation	54
Battery	19, 134
Battery capacity indication	22
Built-in memory	15
Built-in memory information display	85

■ C

Card	24
Charging time	21
Component terminal	16, 90
Copy	
Disc	98
From built-in memory to SD card	86
From SD card to built-in memory	86
Creating still picture from motion picture	73
Customer Services Directory	145

■ D

Date and time display	34
Date and time setting	34
Delete	80
Demo mode	32
Digital cinema	57
Digital cinema color	60
Digital zoom	49
Display	31
Dividing a scene to partially delete	82
DPOF setting	84
Dubbing	103
DVD burner	96

■ E

Economy	31
---------	----

■ F

Fade	54
Flash	63
Focus	46, 69
Format	89, 102
Frame-by-frame playback	72

■ G

Gain	68
Grip belt	18
Guide line	57

■ H

HDMI mini connector	16, 90, 94
High definition	11
Highlight playback	75
Highlight&Time frame index	73
Hi-speed burst shooting mode	62

■ I

Indications	119
Initial setting	32
Intelligent auto mode	39
Intelligent contrast control	54
Intelligent scene selection	74
Iris	68

■ L

Language	30
LCD monitor	16, 36, 135
Limited Warranty (Canada)	146
Limited Warranty (USA and Puerto Rico)	144

■ M

MagicPix function	54
Manual focus	69
Menu	29
MF assist	69
Microphone level	61
Mode switch	27
Motion picture compatibility	72

■ N

Number of recordable pictures	48
-------------------------------	----

■ O

Operation icons	53
Optical image stabilizer	
Active mode	50
Optical image stabilizer demo	32

■ P

PictBridge	104
Picture adjustment	69
Picture quality	47
Playing back motion pictures by date	74
Playing back still pictures by date	79
Power button	26
Power LCD	36
PRE-REC	45
Protect	83

■ Q

Quick power on	41
Quick start	41

■ R

Recordable time	.21, 44
Recording lamp	.31
Recording modes	.44
Recording time elapsed	.43
Recovery	.123
Red eye reduction	.64
Relay recording	.58
Remaining number of still pictures	.47
Remaining time left for recording	.43
Repeat playback	.76
Request for Service Notice (USA and Puerto Rico Only)	.143
Resume playback	.76

■ S

Scene mode	.56
SD card information display	.85
SD Memory Card	.24
SD Speed Class Rating	.24
SDHC Memory Card	.24
Self-recording	.37
Self-timer recording	.63
Shooting guide	.45
Shutter sound	.64
Shutter speed	.68
Simultaneous recording	.46, 48
Slide show	.78
Slow-motion playback	.71
Soft skin mode	.54
Still picture compatibility	.79
Stylus pen	.28
Sub recording start/stop button	.16, 38

■ T

Tele macro	.54
Touch screen	.28
Touch screen calibration	.37
Tripod receptacle	.18

■ V

Video light	.52
VIERA Link	.94
Volume adjustment	.71

■ W

White balance	.67
Wind noise reduction	.60
World time setting	.35

■ Z

Zoom	.49
Zoom microphone	.60
Zoom mode	.49

Spanish Quick Use Guide/Guía española para el uso rápido

■ Carga de la batería

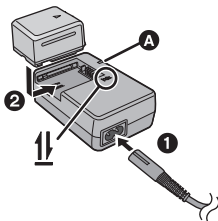

Luz indicadora de carga [CHARGE] (A)

Encendida:
Carga en curso

Apagada:
Carga completada

- 1) Conecte el cable de CA al adaptador de CA y a la toma de CA.
- 2) Instale la batería en el adaptador de CA alineando las flechas.

■ Inserción de la batería

Abra el monitor LCD y coloque la batería introduciéndola en la dirección mostrada en la figura.

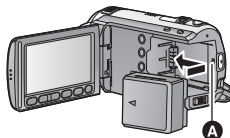

- (A) Inserte la batería hasta que dispase y se bloquee.

■ Insertar/extraer una tarjeta SD

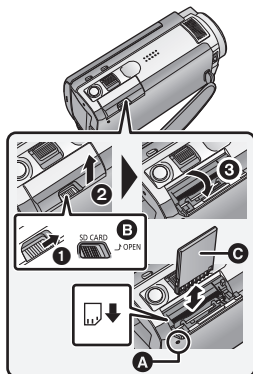

Lámpara de acceso [ACCESS] (A)

- Cuando la unidad accede a la tarjeta SD o a la memoria integrada, se enciende la lámpara de acceso.

- 1) Abra la tapa de la tarjeta SD empujando la OPEN palanca (B).
- Cuando deslice la palanca, empuje hacia arriba la tapa de la tarjeta SD para abrirla.
- 2) Inserte/quite la tarjeta SD.
- Oriente el lado terminal (C) en la dirección mostrada en la ilustración e introdúzcalo hasta el fondo.
- Presione el centro de la tarjeta SD, luego sáquela fuera recta.
- 3) Devuelva la tapa de la tarjeta SD a su posición original y empuje hacia abajo para cerrar.
- Cíerrela firmemente hasta que dispase.

■ Cómo encender la unidad

Encender y apagar el dispositivo con el botón de alimentación

Pulse el botón de alimentación para encender el dispositivo.

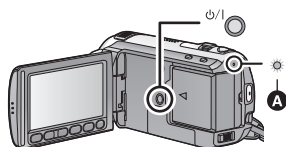

- (A) El indicador de estado se ilumina.
- Para apagar la unidad, mantenga pulsado el botón de alimentación hasta que el indicador de estado se apague.

Cómo encender y apagar la unidad con la pantalla LCD

El dispositivo se enciende al abrir el monitor LCD, y se apaga al cerrarlo.

■ Para encender la unidad

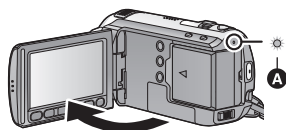



- (A) El indicador de estado se ilumina.
- Para apagar la unidad





- (B) El indicador de estado se apaga.

■ Selección del modo

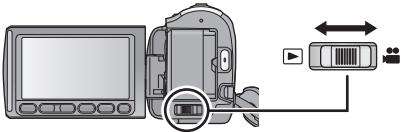
Utilice el selector de modo para cambiar el modo a  o .



	Modo de grabación (→ 42, 46)
	Modo de reproducción (→ 70, 77)

■ Cómo usar la pantalla táctil

Puede actuar directamente tocando el monitor LCD (pantalla táctil) con su dedo.

Es más sencillo utilizar el lápiz electrónico (suministrado) para operaciones detalladas o bien si es difícil de actuar con los dedos.

Toque y suelte la pantalla táctil para seleccionar el icono o la imagen.

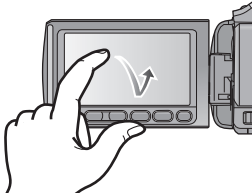

■ Selección del idioma



- 1) Pulse el botón MENU, luego toque [CONFIGURAR] → [LANGUAGE].
- 2) Toque [Español].

■ Grabación de películas

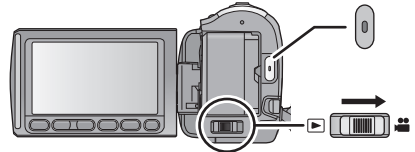
- 1) Cambie el modo a .
- 2) Abra la pantalla LCD.
 - Para usuarios quienes tienen **HDC-SD10**, proceda al Paso 4.
- 3) **HDC-TM10**
Pulse el botón MENU, luego toque [SELEC MEDIO] → [MEM INTERNA] o [TARJETA SD].
- 4) Pulse el botón de inicio/parada de grabación para iniciar la grabación.



■ Grabación de fotografías

- 1) Cambie el modo a .
- 2) Abra la pantalla LCD.
 - Para usuarios quienes tienen **HDC-SD10**, proceda al Paso 4.
- 3) **HDC-TM10**
Pulse el botón MENU, luego toque [SELEC MEDIO] → [MEM INTERNA] o [TARJETA SD].
- 4) Para tomar una imagen pulse el botón  a tope.

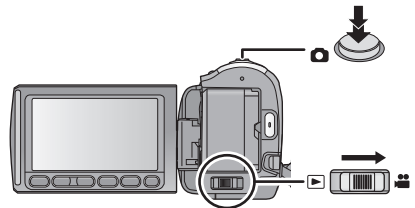

■ Reproducción de películas

- 1) Cambie el modo a .
- 2) Toque el icono **A** de selección del modo de reproducción para seleccionar el medio deseado a ser reproducido.



- Toque [VÍDEO/TARJETA SD] para reproducir la tarjeta SD.

HDC-TM10





Toque [VÍDEO/MEM INTERNA] para reproducir la memoria integrada.

- 3) Toque la escena que desea reproducir.



- 4) Seleccione la operación de reproducción tocando el icono operacional.



- : Reproducción/Pausa
- : Rebobinado durante la reproducción
- : Avance rápido durante la reproducción
- : Detener la reproducción y visualizar las miniaturas.

■ Reproducción de fotografías

- 1) Cambie el modo a .
- 2) Toque el icono **A** de selección del modo de reproducción para seleccionar el medio deseado a ser reproducido.



- Toque [IMAGEN/TARJETA SD] para reproducir la tarjeta SD.

HDC-TM10





Toque [IMAGEN/MEM INTERNA] para reproducir la memoria integrada.

- 3) Toque la fotografía que desea reproducir.



- 4) Seleccione la operación de reproducción tocando el icono operacional.



- : Iniciar o hacer una pausa en la presentación de diapositivas (reproducción de las fotografías contenidas en orden numérico).
- : Reproducir la imagen anterior.
- : Reproducir la imagen siguiente.
- : Detener la reproducción y visualizar las miniaturas.

Panasonic Consumer Electronics Company,
Division of Panasonic Corporation of North America
One Panasonic Way, Secaucus, NJ 07094

Panasonic Canada Inc.
5770 Ambler Drive, Mississauga, Ontario, L4W 2T3



VQT2D01
F0509ML0 (5000 (A))



© Panasonic Corporation 2009
Printed in Japan