

Panasonic®

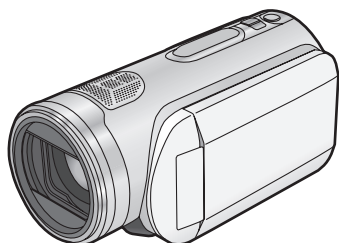

Operating Instructions High Definition Video Camera

Model No. **HDC-SD1PP**

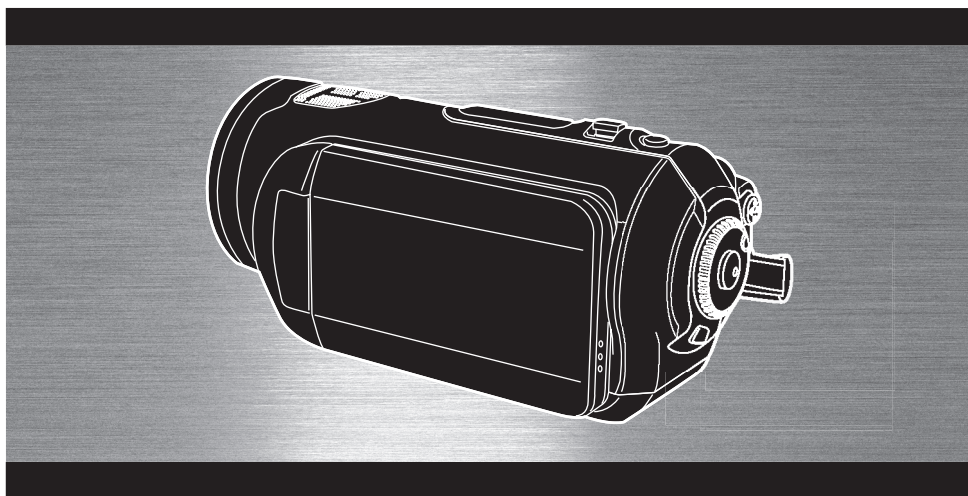

Before connecting, operating or adjusting this product, please read the instructions completely.
Spanish Quick Use Guide is included.
Guía para rápida consulta en español está incluida.

AVCHD

DD DOLBY
DIGITAL
5.1 CREATOR

HDMI™
HIGH-DEFINITION MULTIMEDIA INTERFACE

PictBridge

SD
HC
CLASS^e

HI-SPEED
CERTIFIED USB™

EZSYNC™
HDAVI Control

LEICA
DICOMAR

For USA assistance, please call: 1-800-211-PANA(7262) or, contact us via the web at: <http://www.panasonic.com/contactinfo>

For Canadian assistance, please call: 1-800-561-5505 or visit us at www.panasonic.ca

VQT1A24

Things You Should Know

Thank you for choosing Panasonic!

You have purchased one of the most sophisticated and reliable products on the market today. Used properly, we're sure it will bring you and your family years of enjoyment. Please take time to fill in the information on the right.

The serial number is on the tag located on the underside of your camera. Be sure to **retain this manual** as your convenient camera information source.

Date of Purchase _____

Dealer Purchased From _____

Dealer Address _____

Dealer Phone No. _____

Model No. _____

Serial No. _____

Safety Precautions

WARNING:

TO REDUCE THE RISK OF FIRE, ELECTRIC SHOCK OR PRODUCT DAMAGE,

- DO NOT EXPOSE THIS APPARATUS TO RAIN, MOISTURE, DRIPPING OR SPLASHING AND THAT NO OBJECTS FILLED WITH LIQUIDS, SUCH AS VASES, SHALL BE PLACED ON THE APPARATUS.
- USE ONLY THE RECOMMENDED ACCESSORIES.
- DO NOT REMOVE THE COVER (OR BACK); THERE ARE NO USER SERVICEABLE PARTS INSIDE. REFER SERVICING TO QUALIFIED SERVICE PERSONNEL.

CAUTION!

DO NOT INSTALL OR PLACE THIS UNIT IN A BOOKCASE, BUILT-IN CABINET OR IN ANOTHER CONFINED SPACE. ENSURE THE UNIT IS WELL VENTILATED. TO PREVENT RISK OF ELECTRIC SHOCK OR FIRE HAZARD DUE TO OVERHEATING, ENSURE THAT CURTAINS AND ANY OTHER MATERIALS DO NOT OBSTRUCT THE VENTILATION VENTS.

The socket outlet shall be installed near the equipment and easily accessible. The mains plug of the power supply cord shall remain readily operable. To completely disconnect this apparatus from the AC Mains, disconnect the power supply cord plug from AC receptacle.

The following mark and symbols are located on bottom of the unit.



CAUTION

**RISK OF ELECTRIC SHOCK
DO NOT OPEN**



CAUTION: TO REDUCE THE RISK OF ELECTRIC SHOCK, DO NOT REMOVE SCREWS. NO USER-SERVICEABLE PARTS INSIDE. REFER SERVICING TO QUALIFIED SERVICE PERSONNEL.



The lightning flash with arrowhead symbol, within an equilateral triangle, is intended to alert the user to the presence of uninsulated "dangerous voltage" within the product's enclosure that may be of sufficient magnitude to constitute a risk of electric shock to persons.



The exclamation point within an equilateral triangle is intended to alert the user to the presence of important operating and maintenance (servicing) instructions in the literature accompanying the appliance.

THE FOLLOWING APPLIES ONLY IN THE U.S.A.

FCC Note:

This equipment has been tested and found to comply with the limits for a Class B digital device, pursuant to Part 15 of the FCC Rules. These limits are designed to provide reasonable protection against harmful interference in a residential installation. This equipment generates, uses, and can radiate radio frequency energy and, if not installed and used in accordance with the instructions, may cause harmful interference to radio communications. However, there is no guarantee that interference will not occur in a particular installation. If this equipment does cause harmful interference to radio or television reception, which can be determined by turning the equipment off and on, the user is encouraged to try to correct the interference by one or more of the following measures:

- Reorient or relocate the receiving antenna.
- Increase the separation between the equipment and receiver.
- Connect the equipment into an outlet on a circuit different from that to which the receiver is connected.
- Consult the dealer or an experienced radio/TV technician for help.

FCC Caution: To assure continued compliance, follow the attached installation instructions and use only shielded interface cables with ferrite core when connecting to computer or peripheral devices.

Any changes or modifications not expressly approved by the party responsible for compliance could void the user's authority to operate this equipment.

Declaration of Conformity

Trade Name: Panasonic
Model No.: HDC-SD1
Responsible party: Panasonic Corporation of North America
One Panasonic Way, Secaucus, NJ 07094
Support Contact: Panasonic Consumer Electronics Company
1-800-211-PANA (7262)

This device complies with Part 15 of the FCC Rules. Operation is subject to the following two conditions: (1) This device may not cause harmful interference, and (2) this device must accept any interference received, including interference that may cause undesired operation.

THE FOLLOWING APPLIES ONLY IN CANADA

This Class B digital apparatus complies with Canadian ICES-003.

Batteries

1) Battery pack (Lithium ion battery pack)

- Use the specified unit to recharge the battery pack.
- Do not use the battery pack with equipment other than the specified unit.
- Do not get dirt, sand, liquids, or other foreign matter on the terminals.
- Do not touch the plug terminals (+ and –) with metal objects.
- Do not disassemble, remodel, heat or throw into fire.

2) Button-type battery (Lithium battery)

- Insert with poles aligned.
- Do not touch the terminals (+ and –) with metal objects.
- Do not recharge, disassemble, remodel, heat or throw into fire.
- Keep out of reach of children

If any electrolyte should come into contact with your hands or clothes, wash it off thoroughly with water.

If any electrolyte should come into contact with your eyes, never rub the eyes. Rinse eyes thoroughly with water, and then consult a doctor.

Warning

Risk of fire, explosion and burns. Do not disassemble.

Do not heat the batteries above the following temperatures or incinerate.

Button-type battery 60 °C (140 °F)

Battery pack 60 °C (140 °F)

AC adaptor

This AC adaptor operates on AC between 110 V and 240 V.

But

- In the U.S.A. and Canada, the AC adaptor must be connected to a 120V AC power supply only.
- When connecting to an AC supply outside of the U.S.A. or Canada, use a plug adaptor to suit the AC outlet configuration.
- When connecting to a supply of greater than AC 125V, ensure the cord you use is suited to the voltage of the AC supply and the rated current of the AC adaptor.
- Contact an electrical parts distributor for assistance in selecting a suitable AC plug adaptor or AC cord set.

Marking sign is located on bottom of the unit.

U.S.A./CANADA CONSUMERS: ATTENTION:



A lithium ion/polymer battery that is recyclable powers the product you have purchased. Please call 1-800-8-BATTERY for information on how to recycle this battery.

<For USA-California only>

This product contains a CR Coin Cell Lithium Battery which contains Perchlorate Material – special handling may apply.

See www.dtsc.ca.gov/hazardouswaste/perchlorate.

IMPORTANT SAFETY INSTRUCTIONS

Read these operating instructions carefully before using the unit. Follow the safety instructions on the unit and the applicable safety instructions listed below. Keep these operating instructions handy for future reference.

- 1) Read these instructions.
- 2) Keep these instructions.
- 3) Heed all warnings.
- 4) Follow all instructions.
- 5) Do not use this apparatus near water.
- 6) Clean only with dry cloth.
- 7) Do not block any ventilation openings. Install in accordance with the manufacturer's instructions.
- 8) Do not install near any heat sources such as radiators, heat registers, stoves, or other apparatus (including amplifiers) that produce heat.
- 9) Do not defeat the safety purpose of the polarized or grounding-type plug. A polarized plug has two blades with one wider than the other. A grounding-type plug has two blades and a third grounding prong. The wide blade or the third prong are provided for your safety. If the provided plug does not fit into your outlet, consult an electrician for replacement of the obsolete outlet.
- 10) Protect the power cord from being walked on or pinched particularly at plugs, convenience receptacles, and the point where they exit from the apparatus.
- 11) Only use attachments/accessories specified by the manufacturer.
- 12) Use only with the cart, stand, tripod, bracket, or the table specified by the manufacturer, or sold with the apparatus. When a cart is used, use caution when moving the cart/apparatus combination to avoid injury from tip-over.
- 13) Unplug this apparatus during lightning storms or when unused for long periods of time.
- 14) Refer all servicing to qualified service personnel. Servicing is required when the apparatus has been damaged in any way, such as power-supply cord or plug is damaged, liquid has been spilled or objects have fallen into the apparatus, the apparatus has been exposed to rain or moisture, does not operate normally, or has been dropped.



Precautions

USE & LOCATION

WARNING

- **TO AVOID SHOCK HAZARD** ... Your camera and power supply should not be exposed to rain or moisture. Do not connect the power supply or operate your camera if it gets wet. Your camera has been designed for outdoor use, however it is not designed to sustain direct exposure to water, rain, sleet, snow, sand, dust, or a direct splashing from a pool or even a cup of coffee. This action could permanently damage the internal parts of your camera. Do not attempt to disassemble this unit. There are no user serviceable parts inside. Unplug your camera from the power supply before cleaning.
- **AS WITH ANY SMALL OBJECT, SD CARDS CAN BE SWALLOWED BY YOUNG CHILDREN. DO NOT ALLOW CHILDREN TO HANDLE THE SD CARD.**

CAUTION

- **DO NOT AIM YOUR CAMERA AT THE SUN OR OTHER BRIGHT OBJECTS**
- **DO NOT LEAVE THE CAMERA WITH THE EVF AIMED DIRECTLY AT THE SUN AS THIS MAY CAUSE DAMAGE TO THE INTERNAL PARTS OF THE EVF**
- **DO NOT EXPOSE YOUR CAMERA TO EXTENDED HIGH TEMPERATURE** ... Such as, in direct sunlight, inside a closed car, next to a heater, etc... This action could permanently damage the internal parts of your camera.
- **AVOID SUDDEN CHANGES IN TEMPERATURE** ... If the unit is suddenly moved from a cold place to a warm place, moisture may form on the SD card and inside the unit.
- **DO NOT LEAVE YOUR CAMERA OR THE POWER SUPPLY TURNED ON WHEN NOT IN USE.**
- **STORAGE OF YOUR CAMERA** ... Store and handle your camera in a manner that will not subject it to unnecessary movement (avoid shaking and striking). Your camera contains a sensitive pick-up device which could be damaged by improper handling or storage.

CARE

- **TO CLEAN YOUR CAMERA** ... Do not use strong or abrasive detergents when cleaning your camera body.
- **TO PROTECT THE LENS** ... Do not touch the surface of the lens with your hand. Use a commercial camera lens solution and lens paper when cleaning the lens. Improper cleaning can scratch the lens coating.
- **TO PROTECT THE FINISH OF YOUR CAMERA** ... Before handling your camera, make sure your hands and face are free from any chemical products, such as suntan lotion, as it may damage the finish.

-If you see this symbol-

Information on Disposal in other Countries outside the European Union



This symbol is only valid in the European Union.

If you wish to discard this product, please contact your local authorities or dealer and ask for the correct method of disposal.

■ Indemnity concerning recording content

The manufacturer shall in no event be liable for the loss of recordings due to malfunction or defect of this unit, its accessories or recordable media.

IMPORTANT

■ Carefully observe copyright laws

Whatever you have recorded and created can be used for your personal entertainment only. Under copyright laws, other materials cannot be used without obtaining permission from the holders of the copyrights.

■ Cards that you can use with this unit

SD Memory Card and SDHC Memory Card

For the purposes of these operating instructions, the following cards are referred to as "the SD card".

SD Memory Card

SDHC Memory Card

- SDHC Logo is a trademark.
- miniSD Logo is a trademark.
- "AVCHD" and the "AVCHD" Logo are the trademarks of Matsushita Electric Industrial Co., Ltd. and the Sony Corporation.
- Manufactured under license from Dolby Laboratories.
"Dolby" and the double-D symbol are trademarks of Dolby Laboratories.
- HDMI, the HDMI Logo and the High-Definition Multimedia Interface are the registered trademarks or trademarks of HDMI Licensing LLC.
- HDAVI Control™ is a trademark of Matsushita Electric Industrial Co., Ltd.
- LEICA is a registered trademark of Leica microsystems IR GmbH and DICOMAR is a registered trademark of Leica Camera AG.
- Microsoft®, Windows® and DirectX® are either registered trademarks or trademarks of the Microsoft Corporation in the United States and/or other countries.
- Microsoft product screen shot(s) reprinted with permission from Microsoft Corporation.

- IBM and PC/AT are registered trademarks of International Business Machines Corporation of the U.S.
- Intel®, Pentium® and Celeron® are the registered trademarks or trademarks of the Intel Corporation in the United States and other countries.
- Other names of systems and products mentioned in these instructions are usually the registered trademarks or trademarks of the manufacturers who developed the system or product concerned.

This product is licensed under the AVC patent portfolio license for the personal and non-commercial use of a consumer to (i) encode video in compliance with the AVC Standard ("AVC Video") and/or (ii) decode AVC Video that was encoded by a consumer engaged in a personal and non-commercial activity and/or was obtained from a video provider licensed to provide AVC Video. No license is granted or shall be implied for any other use. Additional information may be obtained from MPEG LA, LLC. See <http://www.mpegla.com>.

Contents

Quick Guide	10
-------------------	----

Before using

Features of the High Definition Video	
Camera.....	13
Accessories	18
Parts identification and handling	19
Using the LCD monitor	24
Using the remote control.....	24
Cards that you can use with this unit.....	26

Setup

Charging the battery	28
Inserting/removing the battery	29
Charging time and recordable time....	30
Connecting to the AC outlet.....	31
Selecting a mode (Turning the unit on/off)	32
Quick start	33
Inserting/removing an SD card	34
How to use the cursor button	35
Using the menu screen.....	39
Setting date and time	41
Switching the language	42
Adjusting LCD monitor	42

Recording

Before recording	43
Auto Ground-Directional Standby (AGS)	44
Recording motion pictures	45
Recording modes/recordable time available for the motion picture	47
Recording still pictures (JPEG)	48
Picture Quality/Approximate Number of Recordable Pictures on an SD Card	51
Various recording functions	52
Zoom in/out function	52
Recording yourself	53
Backlight compensation function	54
Fade in/fade out function	54
MagicPix function	55
Soft skin mode	56
Tele macro function	56
Self-timer recording.....	57
Built-in flash	57
Image stabilizer function	59
Guide line function	59
Wind noise reduction function.....	60
Microphone level.....	60
Zebra display	62
Color bar	62
Manual recording functions	63
Scene mode.....	63
Manual focus adjustment.....	64
White balance	65
Manual shutter speed/aperture adjustment.....	66

Playback

Motion picture playback	68
Playing back motion pictures by date	71
Repeat playback	71
Resuming the previous playback	72
Still picture (JPEG) playback	72

Contents

Editing

Editing scenes	74
Deleting scenes.....	74
Protecting scenes.....	75
Editing still pictures	76
Deleting still pictures	76
Protecting still pictures	77
DPOF setting.....	78

Card management

Formatting	79
Formatting an SD card	79

With other products

With a TV	80
Playback using EZ Sync™ (HDAVI Control™).....	87
Dubbing images onto a connected DVD recorder or video device	89
With a printer (PictBridge)	90

With a computer

Before using with a computer	92
What you can do with a computer	92
Contents on provided CD-ROM	93
End User License Agreement	94
Operating environment.....	95
Installation	97
Installing HD Writer Ver1.0E for SD1	97
Reading the operating instructions of the software applications	98
Software application uninstallation	98
Connection and recognition	99
Connection and recognition procedures..	99
About the computer display	100
To disconnect USB cable safely.....	101
Verifying the unit is correctly recognized by the computer	101
Using HD Writer Ver1.0E for SD1	102
If using Macintosh	104

Others

Menus and Indications	105
Menu list.....	105
Menus related to [ADVANCED] and [SETUP]	107
Indications.....	108
Messages.....	110
Functions that cannot be used simultaneously	113
Troubleshooting	114
Cautions for use	120
Explanation of terms	123
Specifications	125
Optional accessories	128
Accessory Order Form (For USA Customers)	129
Request for Service Notice (USA Only)	130
Limited Warranty (For USA Customers)	131
Customer Services Directory	132
Warranty (For Canadian Customers)	133
Index	134
Spanish Quick Use Guide/Guía española para el uso rápido	136

Quick Guide

Charging the battery

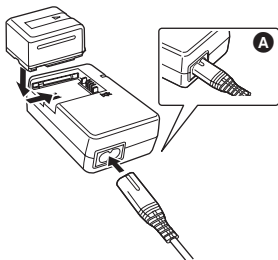

- 1) Connect the AC cable to the AC adaptor and the AC outlet.
- 2) Put the battery on the battery mount by aligning the mark, and then securely plug it in.
 - The output plug of the AC cable is not completely connected to the AC adaptor jack. As shown in **A**, there is a gap.

Inserting the battery

- 1) Open the battery cover.
 - Push **A** while sliding it.

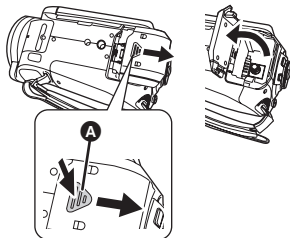

- 2) Insert the battery until it clicks paying attention to the direction of the battery.
 - Push the center of the battery until it locks.

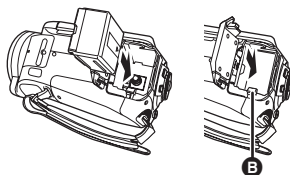

- 3) Close the battery cover.

Removing the battery

- 1) Open the battery cover.

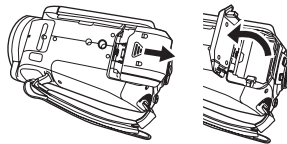

- 2) Remove the battery.

- Move **A** in the direction of the arrow to unlock it and then remove the battery.

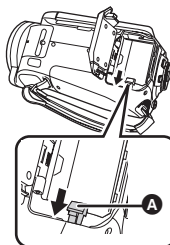

- 3) Close the battery cover.

How to turn on the power

While pressing the lock release button, set the mode dial to ,  or .

- Rotate the mode dial while at the same time pressing in the lock release button **A** if changing from OFF to another mode.
- Align with the status indicator **B**.

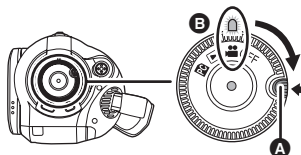

How to turn off the power

Set the mode dial to OFF.

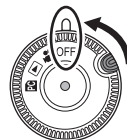

■ Inserting/removing an SD card

- 1) Set the mode dial to OFF.
- 2) Open the LCD monitor and then open the card slot cover.

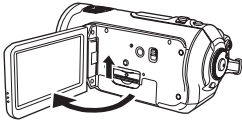

- 3) Insert/remove the SD card into/from the card slot.

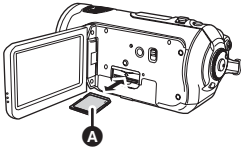

- When inserting an SD card, face the label side **A** upwards and press it straight in as far as it goes.

- 4) Securely close the card slot cover.

■ Recording motion pictures

- 1) Rotate the mode dial to select  .

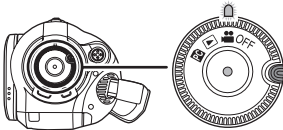

- 2) Open the LCD monitor.
- 3) Press the recording start/stop button to start recording.

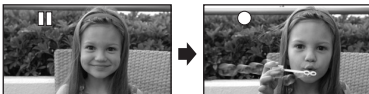

- 4) Press the recording start/stop button again to pause recording.

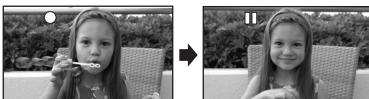

■ Recording still pictures (JPEG)

- 1) Rotate the mode dial to select  .

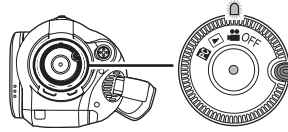

- 2) Open the LCD monitor.
- 3) Press the PHOTO SHOT button halfway in order to adjust focusing. (For auto focusing only)

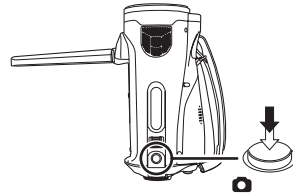

- 4) Press the PHOTO SHOT button fully to take the picture.

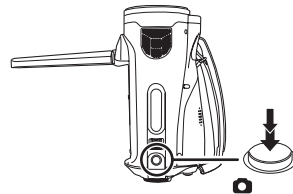

■ Motion picture playback

- 1) Rotate the mode dial to select  .

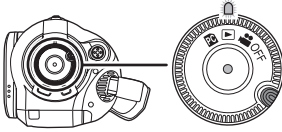

- 2) Press the cursor button up and then left to select the  (motion picture playback) tab.

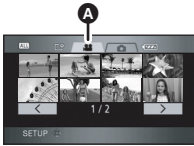

A Motion picture playback tab

- 3) Select the scene to be played back.



B Previous page





C Next page

D Scene number

- 4) Press the cursor button.



- 5) Move the cursor button to operate.

- : Playback/Pause
-  (Move and hold): Review playback
-  (Move and hold): Cue playback
- : Stops the playback and shows the thumbnails.

■ Still picture (JPEG) playback

- 1) Rotate the mode dial to select  .

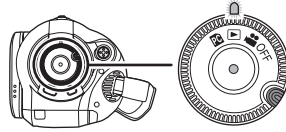

- 2) Press the cursor button up and then right to select the  (still picture playback) tab.

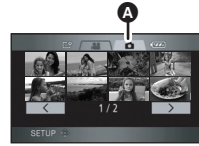

A Still picture playback tab

- 3) Select the file to be played back.



B Previous page

C Next page





D File number display

E Folder/file name

- 4) Press the cursor button.



- 5) Move the cursor button to operate.

- : Slide show (playback of the still pictures on the SD card in numerical order) start/pause.
- : Plays back the previous picture.
- : Plays back the next picture.
- : Stops the playback and shows the thumbnails.

Before using

Features of the High Definition Video Camera

Very clear high definition pictures

This unit is an AVCHD format video camera for recording highly detailed high definition images on an SD card.

You can watch images in high-resolution HD video if you connect this unit and a high definition TV and then play back the images. (→ 80)

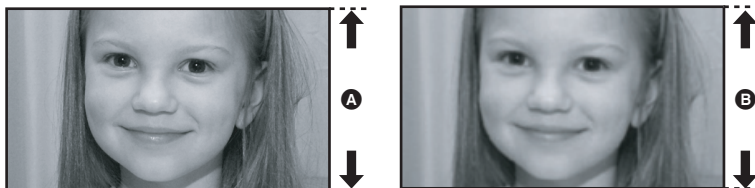

A High definition images (1440×1080)

Number of available scan lines 1080

B Standard images (720×480)

Number of available scan lines 480

High definition images

- High definition images have more than approximately 2 times the number of available scan lines and more than 4 times the number of pixels compared with standard images.
- The still pictures above are images for explanation purposes.

What is the AVCHD?

This is a format for recording and playing back highly detailed high definition images.

Images are recorded based on the MPEG-4 AVC/H.264 codec for compressing images and audio is recorded in Dolby Digital.

About the SDHC Memory Card supplied with this unit and the compatibility of the recorded motion pictures

About the SDHC Memory Card (Be careful about the following.)

- It is not compatible with devices other than those that support SDHC.
- If you use the SDHC Memory Card in another device, use a device that is SDHC compatible. (→ 26)

About the compatibility of the recorded motion pictures

- They are not compatible with devices other than those that support the AVCHD. Refer to the operating instructions of the device for details.
- The recorded motion pictures cannot be played back in a device that is not compatible (does not support the AVCHD).
- There are some cases where the recorded motion pictures cannot be played back, even if the device supports the AVCHD. In such cases, play the recorded motion picture with this unit instead.

Existing DVD recorders and DVD players that do not support the AVCHD



Watching high definition images

If you connect this unit and a high definition TV with a HDMI cable (optional) and then play back the pictures, you can enjoy watching them in high definition.

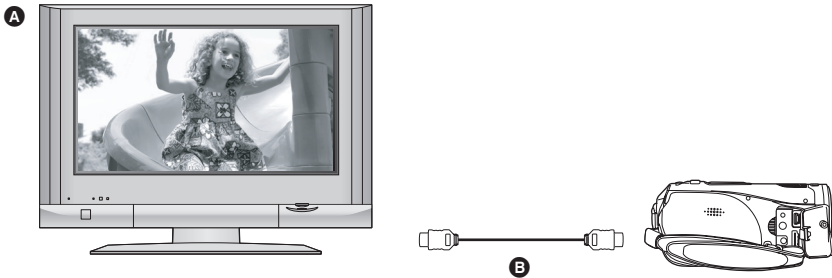

A High definition TV

B HDMI cable (optional)

- If you connect this unit to a TV that does not support high definition, the images will be standard quality.

■ When connecting to a TV that does not have a HDMI terminal

Connecting with the component cable and the AV cable

Connecting with the AV cable

- The pictures cannot be played in high definition. They will be played back in standard quality.

Using the remote control for the TV for playback

If you connect this unit to a Panasonic TV compatible with EZ Sync™ (HDAVI Control™) with a HDMI cable, you can use the remote control for the TV for playback. Refer to the operating instructions of the TV for details.

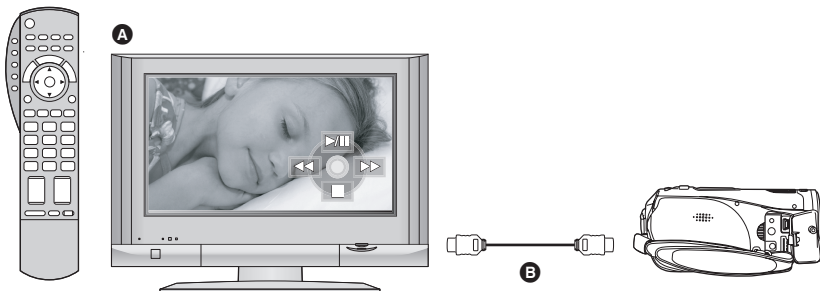

A TV compatible with EZ Sync

B HDMI cable (optional)

Other linked operations

Turning the power on and off

If you turn off the power on the TV with the remote control for the TV, the power on this unit also turns off.

Automatic input switching

If you connect with a HDMI cable and then turn on the power on this unit, the input channel on the TV automatically switches to this unit's screen. If the TV's power is in standby status, it will turn on automatically (if [Set] has been selected for the TV's [Power on link] setting).

- Depending on HDMI terminal of the TV, the input channel may not switch automatically. In this case, use the remote control for the TV to switch input. (For details on how to switch input, please read the operating instructions for the TV.)

Listening in 5.1 channel surround sound

This unit has 5 internal microphones and a Dolby Digital 5.1 Creator so you can record sound with presence that is even closer to the actual sound. The low bass area is sent to the 0.1 channel subwoofer and you can playback sound with three-dimensional presence if you connect to a device that is compatible with the 5.1 surround system.

Internal microphones

The 5 mounted internal microphones give better directivity.

- Far-away sounds can be recorded more clearly with the zoom microphone function. (→ 53)

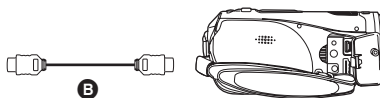
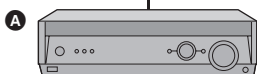

A AV amplifier with HDMI terminal

B HDMI cable (optional)

- Refer to the operating instructions of the TV, AV amplifier, speakers etc. for details on how to connect.
- If you record with an external microphone, the recording is in stereo 2 channel sound.
- Optical digital cables cannot be used for the connection. Connect to an AV amplifier with an HDMI terminal.

Saving the data on the SD card

When the SD card is full or to prevent the data from being deleted, use the supplied software (HD Writer Ver1.0E for SD1) to copy the data on the SD card to the hard disk of the computer.

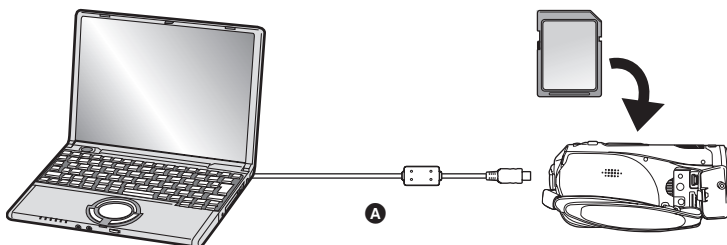

A USB cable (supplied)

What you can do with HD Writer

[Copy to PC]

You can copy motion picture data and still picture data on an SD card to the hard disk of the computer.

[Write data to media]

You can copy motion picture data from the hard disk of the computer to an SD card or a DVD disc.

[Copy between media]

You can copy motion picture data from an SD card to a DVD disc or from a DVD disc to an SD card.

[Easy editing]

You can easily edit (split, merge, delete etc.) motion picture data that was copied to the hard disk of the computer.

- For details on how to use the software application, read the PDF operating instructions.

Important note

Do not insert a disc created with the supplied HD Writer Ver1.0E for SD1 in a device that does not support the AVCHD format. It may no longer be possible to eject it. Also, the disc cannot be played back on devices that do not support the AVCHD format.

The SD Media Storage (USA only)

The SD Media Storage (VW-PT2: optional) is convenient if you are on the move. It is an extremely compact, lightweight and easy to carry HDD (hard disk).

- If you insert an SD card with recorded motion pictures and still pictures in the SD Media Storage, the data can easily be saved to the SD Media Storage by pressing the copy button only.
- You can save all the data from approximately ten 4 GB cards (one 4 GB card is supplied) to its 40 GB HDD capacity.



Accessories

Check the accessories before using this unit.

SDHC memory card (4 GB)



Battery pack

VW-VBG130



AC adaptor

VW-AD21PP



AC cable

K2CA2CA00029



DC cable

K2GJYYC00001



Remote control

N2QAEC000023



Button-type battery

CR2025



AV cable

K2KZ9CB00002



Component cable

K2KZ9DB00004



USB cable

K2KZ4CB00011



CD-ROM



Parts identification and handling

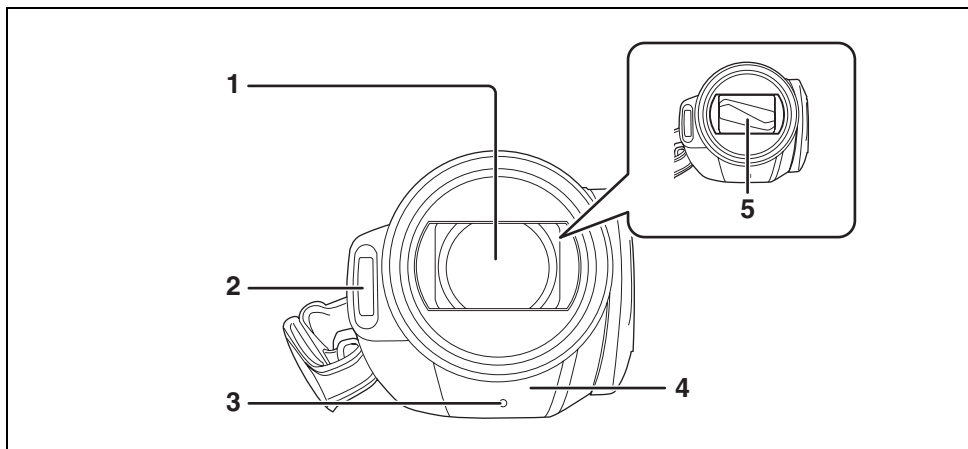

- 1) Lens (LEICA DICOMAR)
- 2) Built-in flash (→ 57)
- 3) Recording lamp (→ 107)
- 4) White balance sensor/remote control sensor (→ 25, 66)
- 5) Lens cover

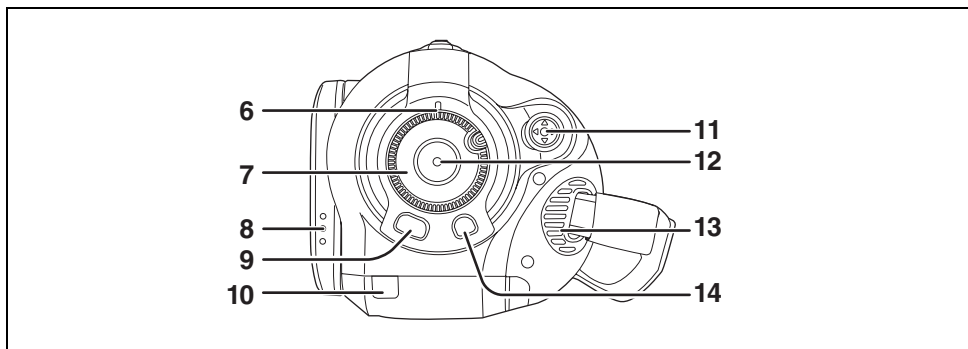

- 6) Status indicator (→ 32)
- 7) Mode dial (→ 32)
- 8) LCD monitor open latch (→ 24)
- 9) Menu button [MENU] (→ 39)
- 10) Battery cable cover (→ 22)
- 11) Cursor button (→ 35)
- 12) Recording start/stop button (→ 45)
- 13) Cooling fan (inlet)
- 14) Delete button [⏏] (→ 74, 76)

■ About the cooling fan

- The cooling fan rotates to prevent the internal temperature rising. Take care not to cover the inlet and outlet when using this unit.

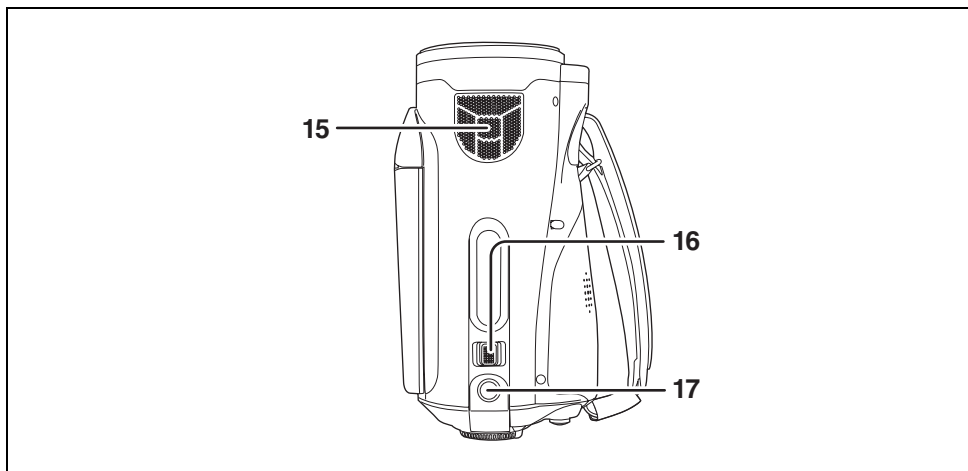

- 15) Internal microphones (5.1 channel support)
- 16) Zoom lever [W/T] (In recording mode) (→ 52)
Volume lever [-VOL+] (In playback mode) (→ 70)
- 17) Photoshot button [] (→ 48)

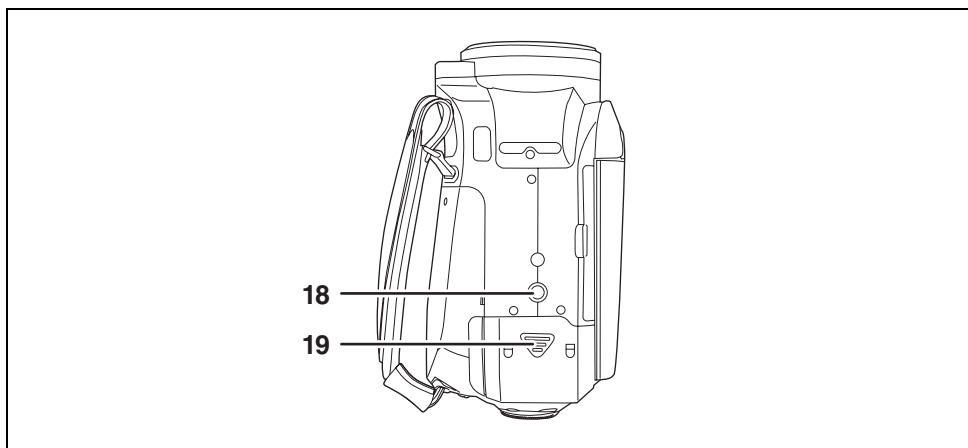

- 18) Tripod receptacle (→ 23)
- 19) Battery cover (→ 29)

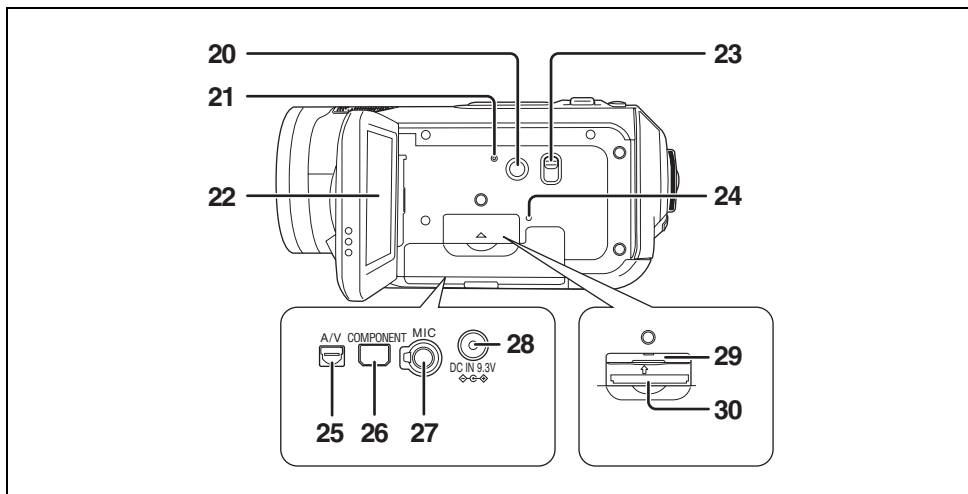

20) Power LCD button [POWER LCD] (→ 42)

21) Reset button [RESET] (→ 118)

22) LCD monitor (→ 24)

Due to limitations in LCD production technology, there may be some tiny bright or dark spots on the LCD monitor screen. However, this is not a malfunction and does not affect the recorded picture.

23) Mode select switch [AUTO/MANUAL/FOCUS] (→ 44, 63)

24) Card access lamp [ACCESS] (→ 35)

25) Audio-video output terminal [A/V] (→ 84, 86, 89)

- Use the supplied AV cable only.

26) Component terminal [COMPONENT] (→ 84)

27) Microphone terminal [MIC]

- A compatible plug-in powered microphone can be used as an external microphone.
- When the unit is connected with the AC adaptor, sometimes noise may be heard depending on the microphone type. In this case, please switch to the battery for the power supply and the noise will stop.

28) DC input terminal [DC IN 9.3V] (→ 31)

29) Card slot cover (→ 34)

30) Card slot (→ 34)

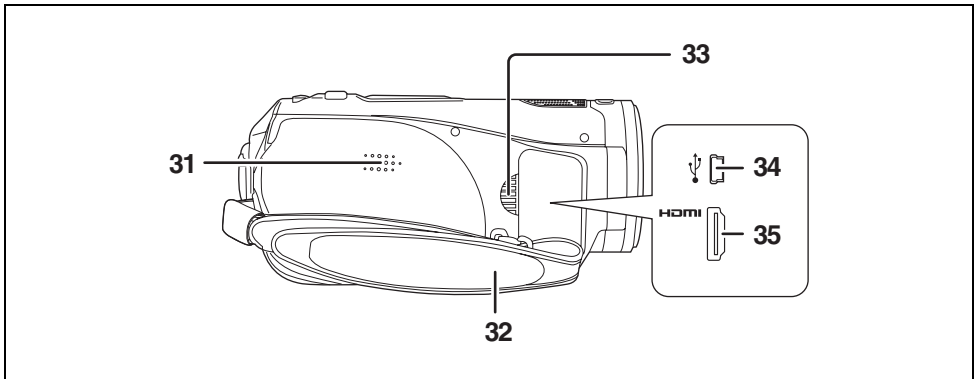

- 31) Speaker
- 32) Grip belt (→ 23)
- 33) Outlet
- 34) USB terminal [⏏] (→ 90, 99)
- 35) HDMI terminal [HDMI] (→ 81, 83, 87)

Battery cable cover

Open the battery cable cover when you use the battery pack holder kit (VW-VH04; optional).

1 Open the battery cover.

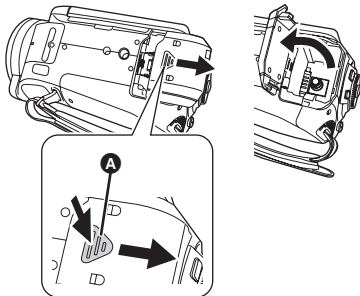

- Push **A** while sliding it.

2 Open the battery cable cover.

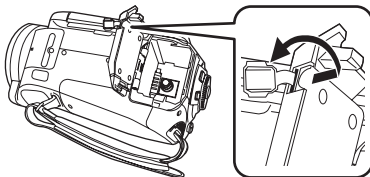

3 Attach the battery pack holder kit.

- Read the operating instructions of the battery pack holder kit for details on how to use it.

4 Close the battery cover.

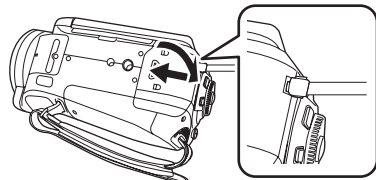

- The cable of the battery pack holder kit can pass through the hole.
- Keep the battery cable cover closed when using this unit normally.

Using grip belt

Adjust the length of the grip belt so that it fits your hand, and hold it properly.

1 Flip the belt.



2 Put your hand through the grip belt.

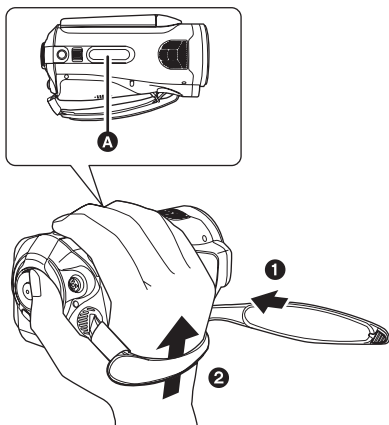

A Rubber grip

1 Loosen the belt.

2 Put your hand through the belt as far as it goes.

- Slip your hand through the belt as far as it goes so that your fingers will grip the rubber area firmly.

3 Replace the belt.

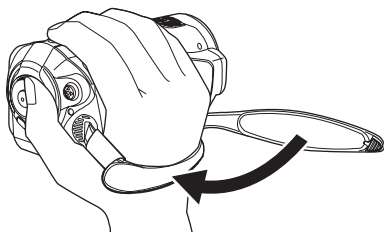

- Tighten up the belt so that your hand remains firmly in place.

Lens hood

Rotate the lens hood counter-clockwise **A** to remove it. In order to attach it, place into slot **B**, and then rotate it clockwise **C**.

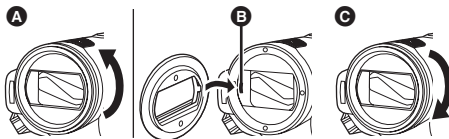

Tripod receptacle

The tripod receptacle is a hole used to mount a tripod for the unit. Use of Panasonic's VW-CT45 (optional) standard tripod is recommended. (For details on mounting the tripod, refer to the operating instructions for the tripod.)

- You cannot use a tripod with a fixed tripod pin.

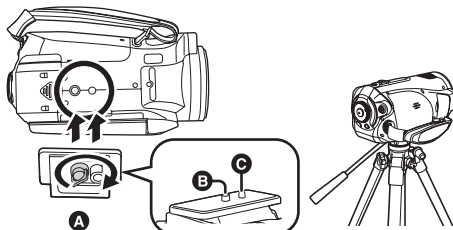

A Camera base

B Screw for mounting the unit

C Tripod pin

- You can perform operations easily using the remote control when the tripod is used. (→ 24)
- The battery cover cannot be opened when the tripod is used. Insert the battery before attaching this unit to the tripod. (→ 29)

Using the LCD monitor

You can record the image while viewing it on the LCD monitor.

- 1 Place your finger on LCD monitor open latch and pull the LCD monitor out in the direction of the arrow.

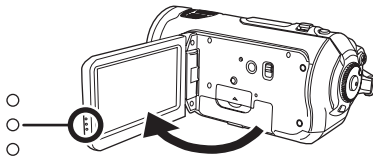

- It can open up to 90°.

- 2 Adjust the angle of the LCD monitor as desired.

A

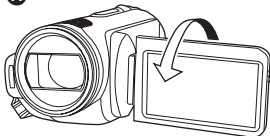

B

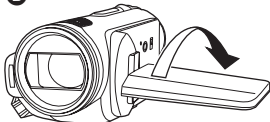

- It can be rotated 180° towards the lens **A** and 90° towards the opposite direction **B**.

- The brightness and color level of the LCD monitor can be adjusted. (→ 42)
- The unit may be damaged or fail if the LCD monitor is forcibly opened or rotated.
- Check that the terminal cover is closed before closing the LCD monitor.

Using the remote control

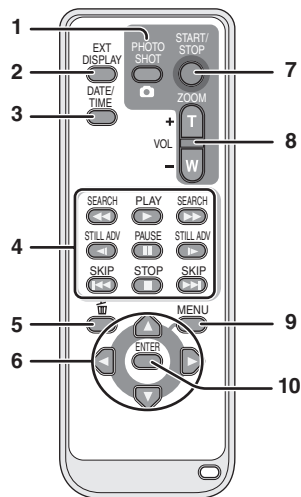

- 1) Photoshot button []*
- 2) On-screen display button [EXT DISPLAY] (→ 80)
- 3) Date/time button [DATE/TIME] (→ 41)
- 4) Playback operation buttons (→ 68, 69, 70)
- 5) Delete button []*
- 6) Direction buttons [, , ,] (→ 40)
- 7) Recording start/stop button [START/STOP]*
- 8) Zoom/volume buttons [ZOOM, VOL]*
- 9) Menu button [MENU]* (→ 40)
- 10) Enter button [ENTER] (→ 40)

* means that these buttons function in the same manner as the corresponding buttons on the unit.

■ Install a button-type battery

Install the supplied button-type battery in the remote control before using it.

- 1 While pressing the stopper **A**, pull out the battery holder.

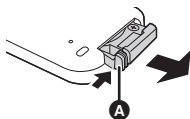

- 2 Set the button-type battery with its (+) mark facing upward and then put the battery holder back in place.

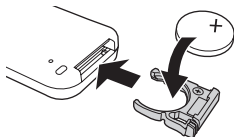

Concerning the button-type battery

- When the button-type battery runs down, replace it with a new battery (part number: CR2025). The battery should normally last about 1 year, however this depends on how frequently the unit is used.
- Keep the button-type battery out of the reach of children.

CAUTION

Danger of explosion if battery is incorrectly replaced. Replace only with the same or equivalent type recommended by the manufacturer. Dispose of used batteries according to the manufacturer's instructions.

Replace battery with Panasonic PART NO. CR2025 only. Use of another battery may present a risk of fire or explosion. Caution: Battery may explode if mistreated. Dispose of used battery promptly. Keep away from children. Do not recharge, disassemble or dispose of in fire.

■ Remote control usable range

The distance between the remote control and the unit's remote control sensor **A**: Within approx. 5 m (16 feet)

Angle: Approx. 10° up and 15° down, left, and right

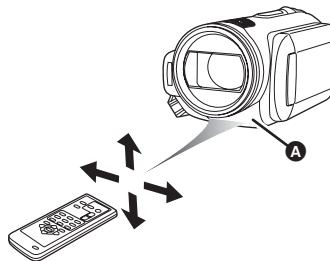

- The remote control is intended for indoor operation. Outdoors or under strong light, the unit may not operate properly even within the usable ranges.

Cards that you can use with this unit

Card type	SD Memory Card			SDHC Memory Card
Capacity	8 MB, 16 MB	32 MB, 64 MB, 128 MB	256 MB, 512 MB, 1 GB, 2 GB	4 GB
Motion picture recording	Cannot be used.	Cannot be guaranteed in operation.*	Refer to "About SD cards that you can use for motion picture recording".	
Still picture recording	Can be used.			

*The recording may suddenly stop during motion picture recording depending on the SD card you use. (→ 46)

This unit (an SDHC compatible device) is compatible with both SD Memory Cards and SDHC Memory Cards. You can use SDHC Memory Cards on devices that are compatible with them. However, you cannot use SDHC Memory Cards on devices that are only compatible with SD Memory Cards. (When using an SDHC Memory Card on another device, always read the operating instructions of that device.)

About SD cards that you can use for motion picture recording

We recommend using SD Memory cards and SDHC Memory cards conforming to Class 2 or higher of the SD Speed Class Rating or the following SD cards made by Panasonic for motion picture recording.

Card type	Pro High Speed SD Memory Card	Super High Speed SD Memory Card	High Speed SD Memory Card	SDHC Memory Card
256 MB	—	RP-SDH256	—	—
512 MB	RP-SDK512	RP-SDH512*	RP-SDR512	—
1 GB	RP-SDK01G	RP-SDH01G*	RP-SDQ01G* RP-SDR01G	—
2 GB	RP-SDK02G	—	RP-SDQ02G* RP-SDR02G	—
4 GB	—	—	—	RP-SDR04G

*No longer made.

- Operation in motion picture recording is not guaranteed with an SD card memory from 32 MB to 4 GB except the cards above. (The recording may suddenly stop during motion picture recording.)
- For the purposes of these operating instructions, SD Memory Card and SDHC Memory Card are referred to as the "SD card".
- This unit supports SD Memory Cards formatted in FAT12 system and FAT16 system based on SD Memory Card Specifications and SDHC Memory Cards formatted in FAT32 system.
- If you wish to use Memory Cards that are 4 GB, SDHC Memory Cards only can be used.

- 4 GB (or more) Memory Cards that do not have the SDHC logo are not based on SD Memory Card Specifications.
- Use this unit to format SD cards. If an SD card is formatted on other products (such as a computer), the time spent for recording may become longer and you may not be able to use the SD card. (→ 79) **(Do not format it on a PC etc.)**
- When the write-protect switch **A** on SD Card is locked, no recording, deletion or editing will be possible on the card.



- Keep the Memory Card out of reach of children to prevent swallowing.
- A MultiMediaCard cannot be used on this unit.

■ CLASS 2 (SD Speed Class Rating Class 2)

This indicates a Class 2 rating in the high speed standards (SD Speed Class) stipulated by the SD Card Association for high speed writing between SD compatible products and SD Memory cards.

If you use a Class 2 card compatible with the SD Speed Class in an SD compatible product, you can obtain stable recording by using an SD card conformed with Class 2 or more.

■ Handling precautions

- Do not expose the terminals of the card to water, garbage or dust.
- Do not place in the following areas:
 - In direct sunlight.
 - In very dusty or humid areas.
 - Near a heater.
 - Locations susceptible to significant difference in temperature (condensation can occur).
 - Where static electricity or electromagnetic waves occur.
- To protect cards, return them to their cases when you are not using them.

Setup

Charging the battery

When this unit is purchased, the battery is not charged. Charge the battery before using this unit.

- **Connect the battery to an AC adaptor to recharge it.**
The battery cannot be recharged by simply inserting it into the unit.
- **If the DC cable is connected to the AC adaptor, then the battery will not charge.**
Remove the DC cable from the AC adaptor.
- **The Panasonic battery that can be used with this unit is VW-VBG130. Other Panasonic batteries will not work. (→ 30)**

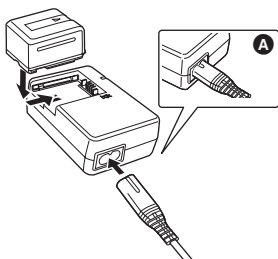

1 Connect the AC cable to the AC adaptor and the AC outlet.

- Remove the DC cable beforehand.

2 Put the battery on the battery mount by aligning the mark, and then securely plug it in.

- The output plug of the AC cable is not completely connected to the AC adaptor jack. As shown in **A**, there is a gap.

■ Charging lamp

Lights up: Charging

Goes off: Charging completed

Flashing: Make sure that the terminals of the battery or the AC adaptor are not exposed to dirt, foreign objects or dust, then reconnect them properly. Disconnect the AC cable from the AC outlet when you remove dirt, foreign objects or dust on the terminals of the battery or the AC adaptor. If the charging lamp is still flashing, something may be wrong with the battery or AC adaptor. Contact your dealer.

- Battery charging time (→ 30)
- We recommend using Panasonic batteries (VW-VBG130).
- If you use other batteries, we cannot guarantee the quality of this product.

Inserting/removing the battery

Inserting the battery

1 Open the battery cover.

- Push **A** while sliding it.

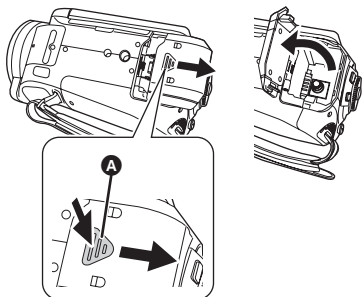

2 Insert the battery until it clicks paying attention to the direction of the battery.

- Push the center of the battery until it locks.

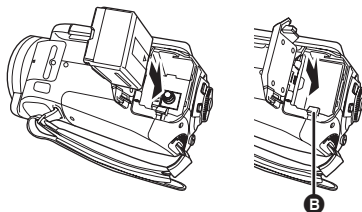

3 Close the battery cover.

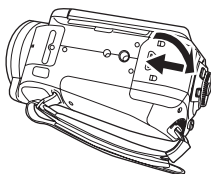

Removing the battery

1 Open the battery cover.

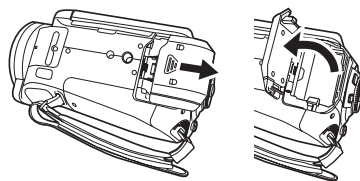

2 Remove the battery.

- Move **A** in the direction of the arrow to unlock it and then remove the battery.

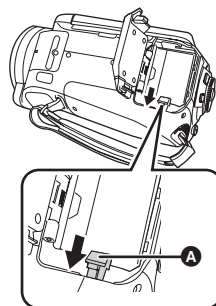

3 Close the battery cover.

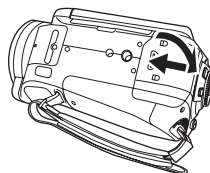

- Be sure to set the mode dial to OFF and check that the status indicator is off before removing the battery.
- The battery cover opens up to 180°.

CAUTION

Danger of explosion if battery is incorrectly replaced. Replace only with the same or equivalent type recommended by the manufacturer. Dispose of used batteries according to the manufacturer's instructions.

Charging time and recordable time

About batteries that you can use for this unit

The Panasonic battery that can be used with this unit is VW-VBG130.

VW-VBG130 comes with a function to check whether the battery and unit can be safely used together.

- Batteries made by other companies which have been certified by Panasonic may be used with this unit, but we offer no guarantee as to the quality, performance or safety of such batteries.
- In order to safely use the unit, we recommend that you use genuine Panasonic batteries which have been subject to our quality control process.
- We cannot accept any liability whatsoever for damages to the unit or accidents caused by non-genuine Panasonic batteries (including those that have been certified by Panasonic).
- Exercise care when purchasing batteries. Many fake or imitation batteries have been found among those sold at unusually low prices and those which customers cannot check for themselves before purchasing.

Charging time

The times shown in the tables below are for when the temperature is 25 °C (77 °F) and the humidity is 60%. If the temperature is higher or lower than 25 °C (77 °F), the charging time will become longer.

Battery model number	Voltage/capacity	Charging time
Supplied battery/ VW-VBG130 (optional)	7.2 V/1320 mAh	2 h 20 min

- The charging time shown in the table are approximations.
- "2 h 20 min" indicates 2 hours 20 minutes.
- When you charge a battery that has not been used for long time, the charging time will become longer.

Recordable time

- The times shown in the table below are for when the temperature is 25 °C (77 °F) and the humidity is 60%. These times are approximations.
- The actual recordable time refers to the recordable time on a card when repeatedly starting/stopping recording, turning the unit on/off, moving the zoom lever etc.

Battery model number	Voltage/capacity	Maximum continuously recordable time	Actual recordable time
Supplied battery/ VW-VBG130 (optional)	7.2 V/1320 mAh	1 h 5 min	40 min

- The recordable time shown in the table are approximations.
 - "1 h 5 min" indicates 1 hour 5 minutes.
-
- The recordable times will vary depending on the status of use. These times are approximations.
 - The recordable time will become shorter in the following case:
 - The recordable time will become shorter when you use this unit with the LCD monitor lit up by pressing the POWER LCD button.
 - The batteries heat up after use or charging. This unit will also heat up while being used. This is not a malfunction.
 - Be aware that the operating time of the battery will become shorter in low temperatures. We recommend charging a spare battery for use when recording.

About the remaining battery capacity indication

The remaining battery capacity is displayed in minutes when using the Panasonic battery that you can use for this unit. It may take time to display the remaining battery capacity.

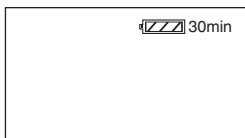

- The display changes as the battery capacity reduces.



If there is less than 3 minutes remaining, then the red battery icon will become red. If the battery discharges, then the red battery icon will flash.

- The remaining battery capacity may not be displayed correctly where the temperature is low or high or if the battery was not used for a long period of time.

To correctly display the remaining battery capacity, recharge the battery, discharge it and then charge it again. (Even if this operation is performed, it may not be possible to display the remaining battery capacity correctly if the battery was used for a long period of time where the temperature is low or high or if the battery was repeatedly charged.)

- The times of remaining battery capacity indication will vary depending on the status of use. These times are approximations.
- When turning the mode dial to switch modes, the time indication will turn off in order to recalculate the remaining battery capacity time.
- When using batteries made by other companies, the remaining battery capacity will not be shown.

Connecting to the AC outlet

- Even if the battery is inserted in this unit, it will not charge.

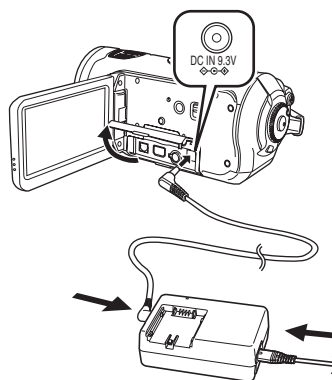

- 1 Connect the AC cable to the AC adaptor.
- 2 Connect the DC cable to the AC adaptor.
- 3 Open the terminal cover on this unit and connect the DC cable to the DC input terminal [DC IN 9.3V].



- Do not use the AC cable with any other equipment as it is designed only for this unit. Do not use the AC cable from other equipment with this unit.
- Put the battery on the AC adaptor to charge it. (→ 28)
- While the DC cable is connected to the AC adaptor, the battery will not charge.

Selecting a mode (Turning the unit on/off)

Rotate the mode dial to switch to recording, playback, PC connection or power OFF.

- Rotate the mode dial slowly.

How to turn on the power

While pressing the lock release button, set the mode dial to ,  or .

- Rotate the mode dial while at the same time pressing in the lock release button **A** if changing from OFF to another mode.
- Align with the status indicator **B**.

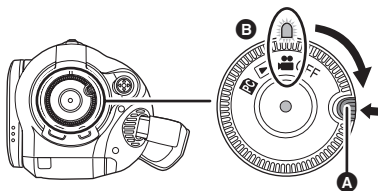

The status indicator lights and the power turns on.

- The lens cover opens in recording mode.
- When the unit is turned on for the first time, a message asking you to set the date and time will appear. Select [YES] and set the date and time. (→ 41)

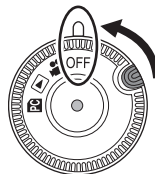

How to turn off the power

Set the mode dial to OFF.



The status indicator goes off and the power turns off.

- The lens cover closes when the mode dial is set to OFF.

	Recording mode (→ 45, 48) Use this to record motion pictures and still pictures on an SD card.
	Playback mode (→ 68, 72) Use this to play back motion pictures and still pictures recorded on an SD card.
	PC Connection mode (→ 99) Use this to import motion pictures and still pictures recorded on an SD card with a computer by using HD Writer Ver1.0E for SD1 etc.
OFF	The power turns off.

- Do not forcefully rotate the mode dial.

Turning the power on and off with the LCD monitor

The power can be turned on and off with the LCD monitor when the mode dial is set to .

■ To turn on the power

Open the LCD monitor.

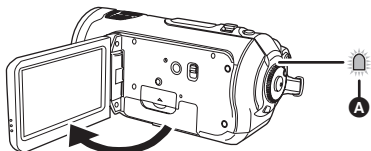

The status indicator **A** lights and the power turns on.

■ To turn off the power

Close the LCD monitor.

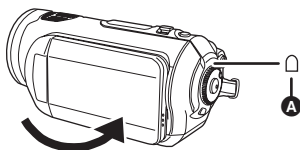

The status indicator **A** goes off and the power turns off. (If [QUICK START] (→ 33) is set to [ON], the unit goes into quick start standby mode and the status indicator lights green.)

- The power will not turn off while recording a motion picture even if the LCD monitor is closed.

Set the mode dial to OFF when this unit is not being used.

Quick start

When quick start is ON the battery power is still being consumed, even when the LCD monitor is closed.

This unit will resume recording/pause mode about 1.7 seconds after the LCD monitor is reopened.

- When in quick start standby mode about 70% of the power used in recording/pause mode is being consumed, so the recording time will be reduced.
- This is only activated in the following case.
 - When the mode dial is set to  and an SD card is inserted.

- 1 Press the MENU button, then select [SETUP] → [QUICK START] → [ON] and press the cursor button.

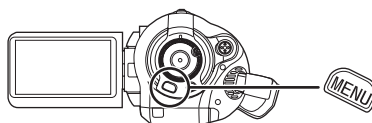

- 2 Close the LCD monitor while the mode dial is set to .

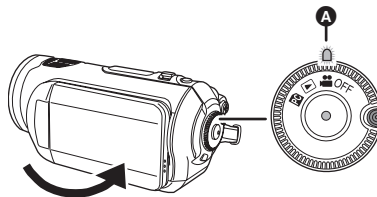

The status indicator **A** lights green and the unit goes into quick start standby mode.

- The lens cover does not close.

3 Open the LCD monitor.

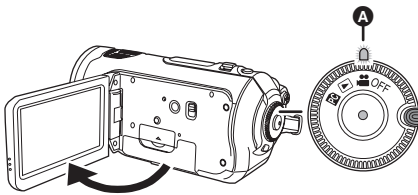

The status indicator **A** lights red and the unit is put into recording pause approx. 1.7 seconds after it is turned on.

■ To cancel Quick start

Press the MENU button, then select [SETUP] → [QUICK START] → [OFF] and press the cursor button.

- The status indicator goes off, the lens cover closes and the power turns off if the mode dial is set to OFF while the unit is in quick start standby mode.
 - The status indicator goes off and the power turns off if quick start standby mode continues for approx. 5 minutes.
-
- Quick start standby mode is canceled, the status indicator goes off and the power turns off in the following cases.
 - the mode dial is switched
 - the battery is removed
 - When this unit is quick-started with the white balance on automatic, it may take some time until the white balance is adjusted if the scene being recorded has a light source different from the scene last recorded. (When the MagicPix function is used, however, the white balance of the scene last recorded is retained.)
 - When this unit is quick-started, the zoom magnification becomes 1× and the picture size may differ from what it was before quick start standby mode.
 - If [POWER SAVE] (→ 107) is set to [5 MINUTES] and the unit automatically goes into quick start standby mode, close the LCD monitor and then open it again.

Inserting/removing an SD card

Be sure to set the mode dial to OFF before inserting/removing an SD card.

If the SD card is inserted or removed while the power is on, this unit may malfunction or the data recorded on the SD card may be lost.

1 Set the mode dial to OFF.

- Check that the status indicator has gone off.

2 Open the LCD monitor and then open the card slot cover.

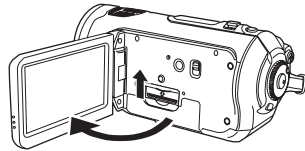

3 Insert/remove the SD card into/from the card slot.

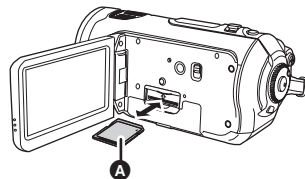

- When inserting an SD card, face the label side **A** upwards and press it straight in as far as it goes.
- When removing the SD card, press the center of the SD card and then pull it straight out.

4 Securely close the card slot cover.

Concerning the SD card

- Do not touch the terminals on the back of the SD card.
- Electrical noise, static electricity or the failure of this unit or the SD card may damage or erase the data stored on the SD card. Save important data recorded on this unit to a PC using the USB cable (supplied), HD Writer Ver1.0E for SD1 etc. (→ 102) (We recommend using HD Writer Ver1.0E for SD1 to acquire data recorded on this unit.)
- When using an SD card on which data has been written many times, the remaining time left for recording may be reduced. (→ 46)

Card access lamp

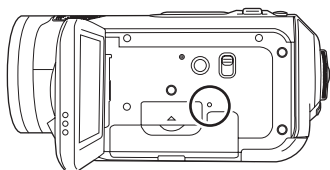

- When this unit accesses the SD card (reading, recording, playback, erasing etc.), the access lamp lights up.
- If the following operations are performed when the access lamp is lit, then the SD card or the recorded data may be damaged or this unit may malfunction.
 - Opening the card slot cover and removing the SD card
 - Operating the mode dial
 - Removing the battery or disconnecting the AC adaptor

How to use the cursor button

This unit has a cursor button **A** for selecting functions, performing operations etc. so it is easy to operate this unit with one hand.

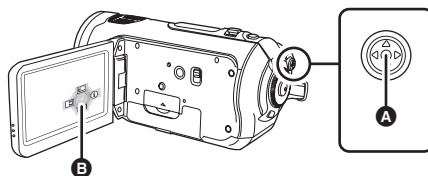

- B** Operating the operation icons and menu screens that are displayed

Basic operations

The following describes operations on the menu screen and selection of files on the thumbnail view screen etc.

Move the cursor button up, down, left, or right to select an item or scene, and then press the cursor button to set it.



- 1** Select by moving up.
 - 2** Select by moving down.
 - 3** Select by moving left.
 - 4** Select by moving right.
 - 5** Press the cursor button to set the item.
- Menu screen operations (→ 39)

Operations during recording

- ◇ Rotate the mode dial to select .

1 Press the center of the cursor button, and icons will be displayed on the screen.



- The indication disappears when the center of the cursor button is pressed again.
- The indication changes each time the cursor button is moved down.

2 Move the cursor button up, left or right to select an item.

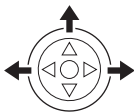

Operations during playback

- ◇ Rotate the mode dial to select .

1 Move the cursor button up, down, left or right to select the scene to be played back and press the cursor button.

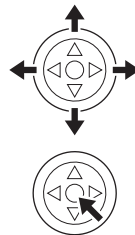

- The selected scene is played back on the full screen.
- The operation icon is automatically displayed on the screen.

2 Move the cursor button up, down, left or right to operate.

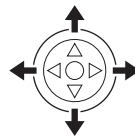

- The operation icon appears or disappears each time the center of the cursor button is pressed.

About the operation icons displayed in each mode

Recording mode



Icon	Direction	Function	Page	
(1/3)		▲	Backlight compensation	54
		◀	Fade	54
		▶	Help mode	39
(2/3)		▲	MagicPix	55
		◀	Soft skin mode	56
		▶	Tele macro	56
(3/3)		▲	Self-timer	57
		◀	Flash	57
		▶	Red eye reduction	58

Set the AUTO/MANUAL/FOCUS switch to MANUAL.

In manual mode [MANUAL] (4/4)		▲	White balance	65
		◀	Iris or gain value	66
		▶	Shutter speed	66

Set the AUTO/MANUAL/FOCUS switch to FOCUS.

In manual focus mode [FOCUS] (5/5)		◀▶	Manual focus adjustment	64
--	--	----	-------------------------	----

- The shaded operation icons are not displayed while recording.
- About switching between AUTO and MANUAL (→ 44)

▶ Playback mode (In motion picture playback)

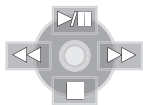

Icon	Direction	Function	Page
▶/	▲	Playback/pause	68
■	▼	Stop playback and show thumbnails	68
◀◀	◀	Rewind (during playback)	68
◀		Reverse slow/frame playback (during pause)	69
▶▶	▶	Fast forward (during playback)	68
▶		Forward slow/frame playback (during pause)	69

▶ Playback mode (In still picture playback)

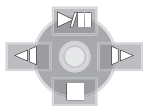

Icon	Direction	Function	Page
▶/	▲	Slide show start/pause	73
■	▼	Stop playback and show thumbnails	73
◀	◀	Playback previous picture (during pause)	73
▶	▶	Playback next picture (during pause)	73

Help mode

The help mode explains the operation icons displayed when the AUTO/MANUAL/FOCUS switch is set to AUTO in recording mode.

◇ Rotate the mode dial to select  .

1 Press the cursor button to display the icon.



2 Move the cursor button right to select [].



3 Move the cursor button up, left or right to select the desired icon.



An explanation of the selected icon scrolls at the bottom of the screen.

- The indication changes each time the cursor button is moved down.

To exit the help mode



Press the MENU button or select [END].

- When the help mode is used, functions cannot be set.
- When the help mode is used, motion pictures and still pictures cannot be recorded.

Using the menu screen

Refer to “Menu list” (→ 105) for information about the menus.

1 While stopped, press the MENU button.



- The menu displayed differs depending on the position of the mode dial.
- Do not switch the mode dial when the menu is displayed.

2 Move the cursor button up or down in order to select the desired top menu **A**.



3 Move the cursor button right or press the cursor button.

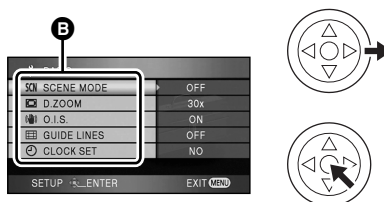

- The submenu **B** is displayed.

4 Move the cursor button up or down in order to select the submenu item.

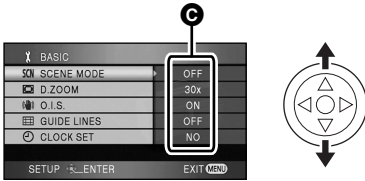

C Current settings on menus

5 Move the cursor button right or press the cursor button.



6 Move the cursor button up or down in order to select the desired item.

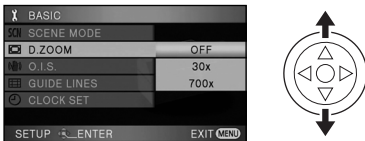

7 Press the cursor button to enter the selection.



To get back to the previous screen

Move the cursor button left.

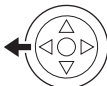

To exit the menu screen

Press the MENU button.



- The menu screen does not appear during recording or playing. You cannot start other operations while the menu screen appears.

Operating with remote control

The menu screen transition is the same as when the buttons on the main unit are used.

1 Press the MENU button.

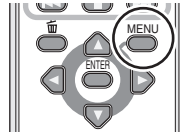

2 Select a menu item.

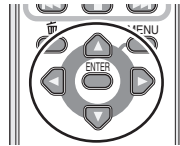

- Use the direction buttons (▲, ▼, ◀, ▶) and ENTER button in place of the cursor button on the main unit.

3 Press the MENU button to exit the menu screen.

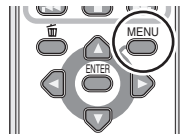

Setting date and time

When the unit is turned on for the first time, a message asking you to set the date and time will appear.

- Move the cursor button up or down to select [YES], press the center of the cursor button and then perform steps 2 and 3 below to set the date and time.

If the screen shows the incorrect date and time, then adjust it.

◇ Rotate the mode dial to select  .

- 1 Press the MENU button, then select [BASIC] → [CLOCK SET] → [YES] and press the cursor button.

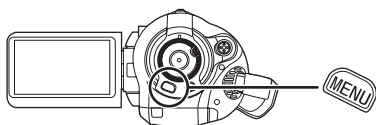

- 2 Move the cursor button left or right to select the item to be set. Then, move the cursor button up or down to set the desired value.



- The year will change as follows: 2000, 2001, ..., 2039, 2000, ...
- The 12-hour system is used to display the time.

- 3 Press the cursor button to enter the selection.

- The clock function starts at [00] seconds when the cursor button is pressed.
- After pressing the MENU button to finish the setting, check the date and time display.

Changing the date and time display style

Press the MENU button, then select [SETUP] → [DATE/TIME] → desired display style and press the cursor button.

- You can also show or change the date and time display by repeatedly pressing the DATE/TIME button on the remote control.

[DATE]

DEC 15 2007

[D/T]

DEC 15 2007 3:30PM

[OFF]

Changing the display style

Press the MENU button, then select [SETUP] → [DATE FORMAT] → desired display style and press the cursor button.

Display style	Screen display
[Y/M/D]	2007.12.15
[M/D/Y]	DEC 15 2007
[D/M/Y]	15.12.2007

- The date and time function are driven by a built-in lithium battery.
- Make sure to check the time before recording.
- If the time display becomes [- -], the built-in lithium battery has run down. Use the following steps to charge the battery. When you turn on the power for the first time after charging, a message asking you to set the date and time will appear. Select [YES] and set the date and time.

To recharge the built-in lithium battery:

If you connect the AC adaptor or insert the battery in this unit, the built-in lithium battery will be recharged. Leave the unit as it is for approx. 24 hours and the battery will save the date and time for approx. 6 months. (The battery is still being recharged even if the mode dial is set to OFF.)

Switching the language

You can switch the language on the screen display or the menu screen.

- 1 Press the MENU button, then select [LANGUAGE] and press the center of the cursor button.



- 2 Select [English] and press the center of the cursor button.

Adjusting LCD monitor

Adjusting the brightness and the color level of the LCD monitor

- 1 Press the MENU button, then select [SETUP] → [LCD SET] → [YES] and press the cursor button.

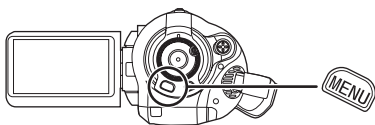

- 2 Move the cursor button up or down to select the item to be adjusted. Then, press the cursor button and move the cursor button left or right to make the adjustment.

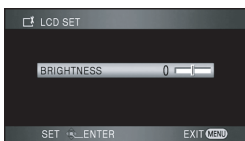

The bar display moves.

- After adjustments are made if no operations are performed for about 2 seconds, the bar will disappear.

- Press the MENU button to exit the menu screen.

[BRIGHTNESS]: Brightness of the LCD monitor
[COLOR]: Color level of the LCD monitor

- These settings will not affect the images actually recorded.

■ In order to increase the brightness of the entire LCD monitor

Press the POWER LCD button.

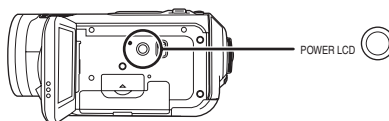

The [] indication appears on the LCD monitor.

- Press the POWER LCD button if the surroundings are bright and the LCD monitor is difficult to see. The entire LCD monitor will become approx. twice as bright as usual.

- When the POWER LCD button is pressed again, the [] indication disappears and the original brightness is restored.

- This will not affect the images to be recorded.

- If you turn on the unit when the AC adaptor is used, this function will automatically be activated.

- This function cannot be used in PC Connection mode.

Recording

Before recording

First, format the SD card if one which has been used on another device is going to be used for the first time on this unit. (→ 79) When the SD card is formatted, all of the recorded data is deleted. Once the data is deleted, it cannot be restored. Copy valuable data onto a PC or other device before proceeding with the formatting.

We recommend using HD Writer Ver1.0E for SD1 to import data recorded on this unit. (→ 102)

Basic camera positioning

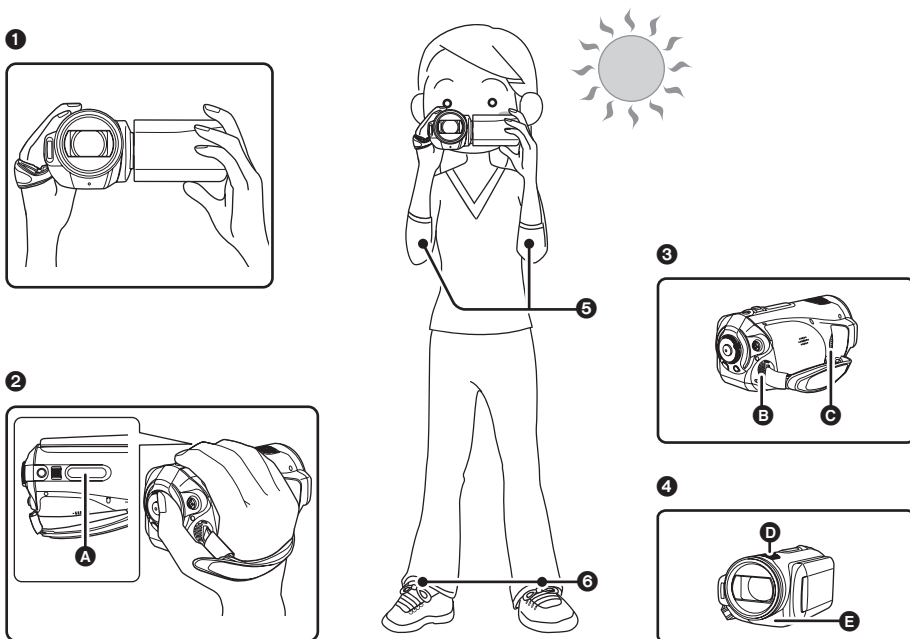

- 1 Hold the unit with both hands.
- 2 Put your hand through the grip belt. Place your fingers on the rubber grip **A** and grasp the unit firmly.
- 3 Do not cover inlet **B** or outlet **C** of the cooling fan with your hand as it will prevent heat release. If heat builds up inside the unit, it could be damaged.
- 4 Do not cover the microphones **D** or the sensors **E** with your hands.
- 5 Keep your arms near your body.
- 6 Slightly open your legs.
 - When you are outdoors, record pictures with the sunlight behind you. If the subject is backlit, it will become dark in the recording.
 - When recording, make sure your footing is stable and there is no danger of colliding with another person or object.

About auto mode

Set the AUTO/MANUAL/FOCUS switch to AUTO, and color balance (white balance) and focusing will be adjusted automatically.

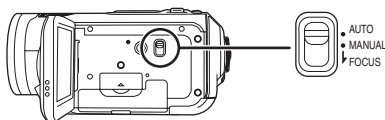

- Automatic white balance (→ 123)
- Auto focus (→ 124)

Depending on the brightness of the subject etc., the aperture and shutter speed are automatically adjusted for an optimum brightness.

(The shutter speed is adjusted to a maximum of 1/250 in recording mode.)

- Color balance and focus may not be adjusted automatically depending on light sources or scenes. If so, manually adjust these settings.
 - Scene mode setting (→ 63)
 - White balance setting (→ 65)
 - Shutter speed setting (→ 66)
 - Iris/gain value setting (→ 66)
 - Manual focus setting (→ 64)

Auto Ground-Directional Standby (AGS)

This function prevents unnecessary recording when you forget to pause recording and walk with the unit tilted upside down while recording continues.



- If the unit continues to be tilted upside down from the normal horizontal position while recording motion pictures, it is automatically put into recording pause.

Turning the AGS function on/off

- ◇ Rotate the mode dial to select  . Press the MENU button, then select [VIDEO] → [AGS] → [ON] or [OFF] and press the cursor button.

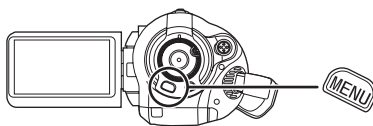

- This function's default setting is [OFF].
- The AGS function may activate and cause the unit to pause the recording if you are recording a subject right above or right below you. In these cases, set [AGS] to [OFF] then continue the recording.
- Use the recording start/stop button to pause the recording. The AGS function is only a backup function for when you forget to pause the recording.
- The time it takes the unit to be put into recording pause after being tilted upside down varies depending on the operating conditions.

Recording motion pictures

Record motion pictures on an SD card.

- Use an SD card that can be used for motion picture recording. (→ 26)
- This unit records high definition images that are compatible with the 16:9 aspect ratio of a wide-screen TV.

1 Rotate the mode dial to select

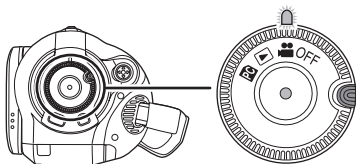

The lens cover opens automatically.

2 Open the LCD monitor.

3 Press the recording start/stop button to start recording.

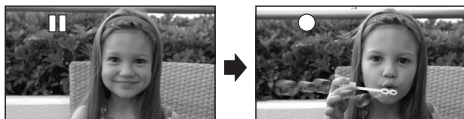
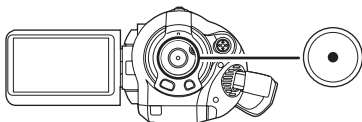

- While recording is in progress, the recording will not stop even if the LCD monitor is closed.

To end the recording

Press the recording start/stop button again to pause recording.

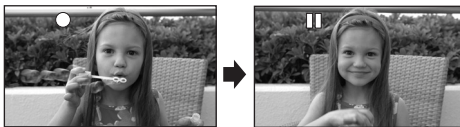

- [●] and [||] are red during recording. Do not move this unit until [||] is green.
- The images recorded between pressing the recording start/stop button to start recording and pressing it again to pause recording become one scene.
- When about 5 minutes have passed without any operation in recording pause, the unit automatically turns off to prevent the battery from running down. When you want to use the unit, turn it on again. This setting can also be set to [OFF]. (→ 107, [POWER SAVE])

■ Screen indications in the recording mode



- A Recording mode**
- B Remaining time left for recording**
(When the remaining time is less than 1 minute, [R0min] flashes red.)
- C Recording time elapsed**

- Maximum number of recordable scenes: 999 (It may not be possible to record 999 scenes even if there is available memory on the SD card.)
- Maximum number of recordable scenes with different dates: 99
(In some cases, scenes shot on the same day will be recorded with different dates. (→ 71))
- SD cards with more than the maximum scenes or different dates cannot be used with this unit.
- Sound is recorded from the internal microphones on the top of this unit. Take care not to block this microphone.
- Put the unit in pause mode when connecting or disconnecting an external microphone with the MIC terminal. If an external microphone is connected or disconnected while recording, the audio will not be recorded properly.
- Each time the unit is put into recording pause, the counter display will be reset to "0h00m00s".
- When recording motion pictures, do not remove the battery or disconnect the AC adaptor. Also do not remove the SD card while the card access lamp is lit. If you do either of the above, the scene recovery message is displayed and the recovery operation will begin when the SD card is next inserted or the power is turned back on. (→ 112)

■ When recording stops suddenly during motion picture recording

When using an SD card other than one that can be used for motion picture recording (→ 26), the recording may stop suddenly. At this time, the following message appears.

When motion pictures are to be recorded, use a Panasonic SD card or another SD card which can be used to record motion pictures. (→ 26)

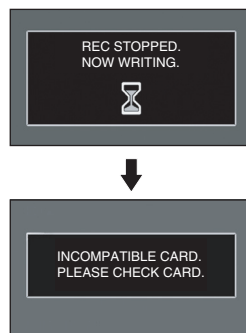

Even if you use an SD card that can be used for motion picture recording (→ 26), this kind of message may appear.

The data on the card has been written many times and the data writing speed has reduced. We recommend formatting the SD card being used. (→ 79) When an SD card is formatted, all the data recorded on it will be deleted so copy valuable data to the PC prior to formatting. (→ 102) (When acquiring data recorded on this unit, we recommend using HD Writer Ver1.0E for SD1 to acquire it. (→ 102))

Recording modes/recordable time available for the motion picture

Switch the picture quality of the motion pictures to be recorded.

◇ Rotate the mode dial to select  .

Press the MENU button, then select [VIDEO]

→ [REC MODE] → desired item and press the cursor button.



Approximate recording times of motion pictures per SD card made by Panasonic

SD card memory	HF	HN	HE
256 MB	2 min	3 min	5 min
512 MB	5 min	7 min	10 min
1 GB	10 min	15 min	22 min
2 GB	20 min	30 min	45 min
4 GB	40 min	1 h	1 h 30 min

HF :

Motion pictures can be recorded with the highest picture quality.

HN :

Motion pictures can be recorded with normal picture quality.

HE :

Motion pictures can be recorded for longer.

- The recordable time shown in the table are approximations.
- **Motion pictures can be recorded with the high definition picture quality.**
- This unit records in CBR in **HF** mode. CBR is an abbreviation for Constant Bit Rate. CBR recording does not vary the bit rate (amount of data in a fixed time).
- This unit records in VBR in **HN/HE** mode. VBR is an abbreviation for Variable Bit Rate. VBR recording automatically varies the bit rate (amount of data in a fixed time) depending on the subject being recorded. This means if a subject with sharp movements is recorded, the recording time is reduced.
- Sound is recorded with the Dolby Digital 5.1 Creator. (when recording with the built-in microphone)

● Recordable time using the battery (→ 30)

- 8 MB and 16 MB SD cards cannot be used for motion picture recording.
- If the write protection switch on the SD card is set to LOCK, it cannot be used for recording. (→ 27)
- If an SD card is recorded on or erased many times, it may no longer be possible to record motion pictures even if there is available memory on the SD card. In this case, after saving the data on PC, format the SD card.
- Mosaic-pattern noise may appear on a playback image in the following cases.
 - When there is a complicated pattern in the background
 - When the unit is moved too much or too fast
 - When a subject with sharp movements has been recorded (Particularly if it has been recorded in **HE** mode.)

Recording still pictures (JPEG)

Record the still picture on an SD card.

- This number of recording pixels for still pictures is compatible with the 16:9 aspect ratio of a wide-screen TV. They are recorded at 1920×1080.

1 Rotate the mode dial to select

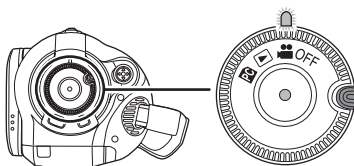

The lens cover opens automatically.

2 Open the LCD monitor.

3 Press the PHOTO SHOT button halfway in order to adjust focusing. (For auto focusing only)

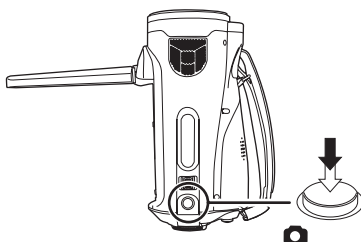

The shutter speed and the iris/gain value are fixed and the unit focuses on the subject automatically.

- If you set [O.I.S.] (→ 59) to [ON], then the image stabilizer function will be more effective. ([MEGA] (MEGA optical image stabilizer) will be displayed.)

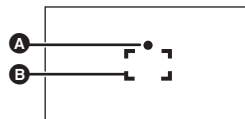

- A** Focus indication
○ (The white lamp flashes.):
Focusing
● (The green lamp lights up.):
When in focus
No mark:
When focusing is unsuccessful.
- B** Focus area

4 Press the PHOTO SHOT button fully to take the picture.

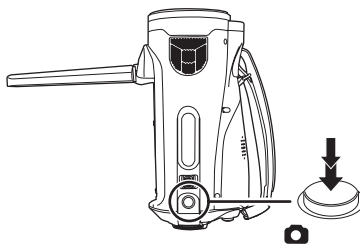

- In order to take better still pictures, the screen will brighten when recording.

To record still pictures clearly

- When zooming in on the subject with a magnification of 4× or higher, it is difficult to reduce the slight shaking from holding this unit by hand. We recommend decreasing the zoom magnification and approaching the subject when recording.
- When recording still pictures, hold the unit firmly with your hands and keep your arms stationary at your side so as not to shake the unit.
- You can record stable pictures without shaking by using a tripod and the remote control.

• For information about the number of recordable still pictures on an SD card (→ 51)

- The sound cannot be recorded.
- If the write protection switch on the SD card is set to LOCK, it cannot be used for recording.
- The PHOTO SHOT button on the remote control cannot be pressed halfway.

- If the [PICT. QUALITY] is set to [], mosaic-pattern noise may appear on a playback image depending on the picture content.
- While this unit accesses the SD card (is displayed/the card access lamp is lit), do not perform the following operations. The SD card or the recorded data may be damaged.
 - Turn the unit off.
 - Open the card slot cover and remove the SD card.
 - Operate the mode dial.
- Other products may degrade or not playback still pictures recorded on this unit.
- The edges of still pictures recorded on this unit with a 16:9 aspect ratio may be cut at printing. Check the printer or photo studio before printing.

About the screen indications only when the PHOTO SHOT button is pressed halfway

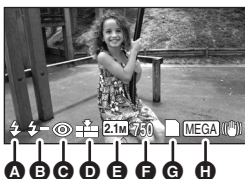

- A** Flash (→ 57)
- B** Flash level (→ 58)
- C** Red eye reduction (→ 58)
- D** Quality of still pictures
- E** Size of still pictures
- F** Remaining number of still pictures
(Flashes in red when [0] appears.)
- G** Card indication (→ 108)
- H** MEGA optical image stabilizer (→ 59)

About the focus indication

- The focus indication indicates the status of the auto focus.
- The focus indication does not appear in manual focus mode.
- Focus on a subject manually when it is not easily focused automatically.
- You can record still pictures on the card even if the focus indication does not appear, but pictures may be recorded without being focused.
- The focus indication does not appear or has difficulty displaying in the following cases.
 - When the zoom magnification is high.
 - When the unit is shaken.
 - When the subject is moving.
 - When the subject stands in front of a light source.
 - When close subjects and far subjects are included in the same scene.
 - When the scene is dark.
 - When there is a bright part in the scene.
 - When the scene is filled with only horizontal lines.
 - When the scene lacks contrast.
 - When recording motion pictures
 - When the MagicPix function is used.

Concerning the focusing area

When there is a contrasting object ahead or behind the subject in the focus area, the subject may not be focused. If so, move the contrasting object out of the focus area.

- Even when it is still difficult to focus, adjust the focus manually.
- The focusing area is not displayed when the digital zoom (more than approx. 12×) is used.

Switching the shutter effect on/off

You can add a shutter sound when recording still pictures.

Press the MENU button, then select [PICTURE] → [SHTR EFFECT] → [ON] or [OFF] and press the cursor button.

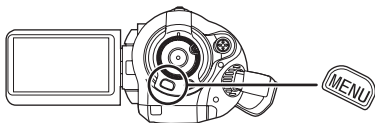

- This function's default setting is [ON].
- This function does not work during motion picture recording.

About simultaneous recording (recording still pictures while recording motion pictures)

You can record still pictures even while recording motion pictures.

While recording motion pictures, press the PHOTO SHOT button fully (press to the bottom) to take the picture.

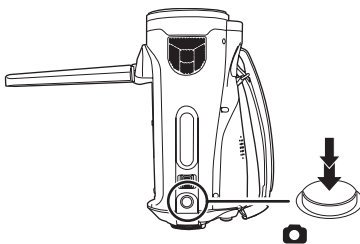

- This function is not activated if the PHOTO SHOT button is pressed halfway.
- The screen indications that appear only when the PHOTO SHOT button is pressed halfway will be displayed. (→ 49) However, the remaining number of still pictures will not be displayed.
- The picture quality is different from normal still picture recording because priority is given to the motion picture recording. We recommend pausing the motion picture recording to record a still picture with better picture quality.



Picture Quality/Approximate Number of Recordable Pictures on an SD Card

Picture quality

Selecting the picture quality.

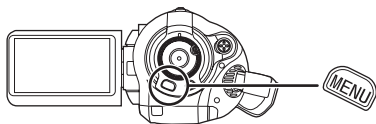

Press the **MENU** button, then select **[PICTURE]** → **[PICT. QUALITY]** → desired item and press the cursor button.





-  : Still pictures with a high picture quality are recorded.
-  : Priority is given to the number of still pictures recorded. Still pictures are recorded in normal picture quality.

Approximate Number of Recordable Pictures on an SD Card

Picture quality and number of recordable pictures

Picture size	2.1M (1920×1080)	
Picture quality		
8 MB	4	6
16 MB	10	17
32 MB	20	32
64 MB	47	74
128 MB	94	150
256 MB	200	320
512 MB	410	640
1 GB	820	1290
2 GB	1670	2630
4 GB	3290	5160

- The number of recordable pictures depends on whether  and  are used together and on the subject being recorded.
- The numbers shown in the table are approximations.

Various recording functions

Zoom in/out function

You can zoom in up to 12× optically.

- ◇ Rotate the mode dial to select  .
- Move the zoom lever.**

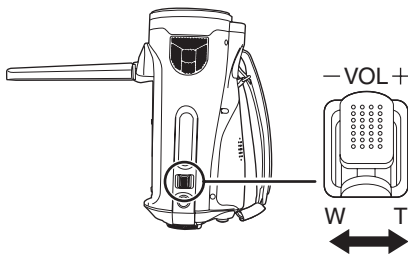

- T side:** Close-up recording (zoom in)
- W side:** Wide-angle recording (zoom out)

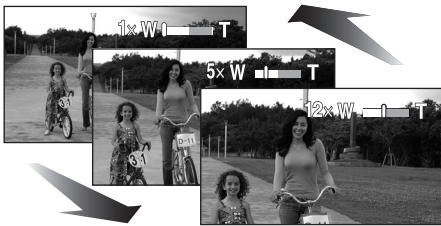

- If you take your finger off the zoom lever during zoom operation, the operation sound may be recorded. When returning the zoom lever to the original position, move it quietly.
- When zooming in while holding this unit by hand, we recommend using the image stabilizer function. (→ 59)
- When distant subjects are brought closer, they are focused at about 1.2 m (3.9 feet) or more.
- When the zoom magnification is 1×, this unit can focus on a subject approx. 4 cm (1.6") away from the lens. (Macro function)
- The zoom speed varies depending on the range over which the zoom lever is moved. (The zoom speed does not vary when operating with the remote control.)

- If the zoom lever is pushed to the end, you can zoom from 1× up to 12× in as fast as approx. 1.8 seconds.
- When the zoom speed is high, the subject may not be focused easily.

Digital zoom function

If the zoom magnification exceeds 12×, then the digital zoom function will be activated. The maximum magnification provided by the digital zoom can be switched.

- ◇ Rotate the mode dial to select  .
- Press the MENU button, then select [BASIC] → [D.ZOOM] → desired item and press the cursor button.**

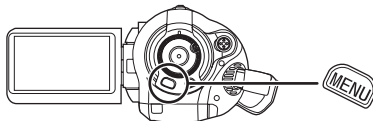

- [OFF]: Optical zoom only (Up to 12×)
- [30×]: Up to 30×
- [700×]: Up to 700×
- If [30×] or [700×] is selected, the digital zoom range is displayed in blue while zooming.

- The larger the digital zoom magnification, the more the image quality is degraded.

About using the zoom microphone function

The zoom microphone is linked to the zooming operation and the sound sensitivity direction (directivity) of the microphone changes as you zoom. Far away sounds are recorded more clearly if you zoom in (close-up) and the surrounding sound is recorded with presence if you zoom out (wide angle).

◇ Rotate the mode dial to select  .
Press the MENU button, then select [VIDEO] → [ZOOM MIC] → [ON] and press the cursor button.

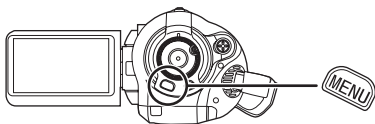

- The zoom microphone function does not work with an external microphone.
- When zooming in, surrounding sounds are suppressed and the sound near the front of the unit is recorded. When recording music recitals or other events where you wish to record quality sound and keep a realistic sensation even when zooming in, we recommend that you turn the zoom microphone function off.

Recording yourself

You can record yourself while viewing the LCD monitor.

◇ Rotate the mode dial to select  .
Rotate the LCD monitor towards the lens side.

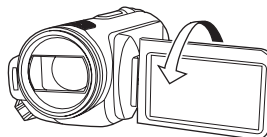

The image is horizontally flipped as if you see a mirror image. (However the image recorded is the same as a normal recording.)

- When the LCD monitor is rotated towards the lens side, the icon will not be displayed even if you press the cursor button.
- Only some indications will appear on the screen. When  appears, return the direction of the LCD monitor to normal position and check the warning/alarm indication. (→ 110)

Backlight compensation function

This is for preventing a backlit subject from being darkened.

Use this function when the light is emanating from behind the subject and the subject appears dark.

◇ Rotate the mode dial to select  .

1 Press the cursor button. Then move the cursor button down to display the icon shown in the illustration.



2 Move the cursor button up to select [].



The image on the screen will become brighter.

To return to normal recording

Select [] again.

- If you turn off the power or operate the mode dial, the backlight compensation function is canceled.

Fade in/fade out function

Fade in: The image and audio gradually appear.

Fade out: The image and audio gradually disappear.

◇ Rotate the mode dial to select  .

1 Press the cursor button. Then move the cursor button down to display the icon shown in the illustration.



2 Move the cursor button left to select [].



3 Press the recording start/stop button.

Start recording. (Fade in)



When you start recording, the image/audio gradually appears.

4 Press the recording start/stop button.

Pause recording. (Fade out)



The image/audio gradually disappears. After the image/audio completely disappears, recording stops.

- After recording, the fade setting is canceled.

To cancel fading

Select [] again.

To select the color for fade in/out

The color which appears in fading pictures can be selected.

Press the MENU button, then select [VIDEO] → [FADE COLOR] → [WHITE] or [BLACK] and press the cursor button.

- If you turn off the power, the fade function is canceled.
- While the fade in/fade out function is selected, it takes several seconds to display the image when you start recording. It also takes several seconds to pause recording.
- The thumbnails of scenes recorded using fade in become black (or white).

MagicPix function

This allows recording in dark locations.

This function allows you to record color subjects in dark locations (Minimum required illumination: approx. 2 lx) to stand out against the background.

Attach this unit to a tripod, and you can record images free from vibration.

- Recorded scene is seen as if frames were missed.

◇ Rotate the mode dial to select .

1 Press the cursor button. Then move the cursor button down to display the icon shown in the illustration.



2 Move the cursor button up to select [].

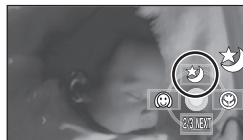

To cancel the MagicPix function

Select [] again.

- The focus indication does not appear even if the PHOTO SHOT button is pressed halfway.
- When using auto focus, it will take some time to focus in dark areas. If there is difficulty focusing with auto focus, manually adjust the focus.
- The flash cannot be used.
- The MagicPix function makes the signal charging time of CCD up to approximately 8× longer than usual, so that dark scenes can be recorded brightly. For this reason, bright dots that are usually invisible may be seen, but this is not a malfunction.
- If you turn off the power or operate the mode dial, the MagicPix function is canceled.
- If set in a bright place, the screen may become whitish for a while.

Soft skin mode

This makes skin colors appear softer for a more attractive appearance.

This is more effective if you record a subject more closely from the torso up.

◇ Rotate the mode dial to select .

1 Press the cursor button. Then move the cursor button down to display the icon shown in the illustration.



2 Move the cursor button left to select [].



To cancel the soft skin mode

Select [] again.

- If the background or anything else in the scene has colors similar to the skin color, they will also be smoothed.
- If the brightness is insufficient, the effect may not be clear.
- If you record a person in the distance, the face may not be recorded clearly. In this case, cancel soft skin mode or zoom in on the face (close-up) to record.

Tele macro function

This is for close-ups bringing only what you want to record into focus.

By focusing only on the subject and blurring the background, the image can be impressive.

The unit can focus on the subject at a distance of approx. 60 cm (24").

◇ Rotate the mode dial to select .

1 Press the cursor button. Then move the cursor button down to display the icon shown in the illustration.



2 Move the cursor button right to select [].



- If the magnification is 12× or less, then it is automatically set to 12×.

To cancel the tele macro function

Select [] again.

- If a sharper focus cannot be achieved, adjust the focus manually. (→ 64)
- In the following cases, the tele macro function is canceled.
 - The zoom magnification becomes lower than 12×.
 - The power is turned off or the mode dial is operated.

Self-timer recording

You can record still pictures on an SD card using the timer.

◇ Rotate the mode dial to select  .

1 Press the cursor button. Then move the cursor button down to display the icon shown in the illustration.

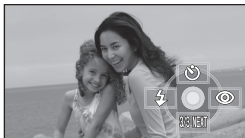

2 Move the cursor button up to select [T].



Each time the cursor button is pressed up, the indication changes by one setting in the following order:

[T₁₀] → [T₂] → setting canceled

T₁₀: Records after 10 seconds

T₂: Records after 2 seconds

3 Press the PHOTO SHOT button.

A still picture is recorded after the [T₁₀] or [T₂] display and the recording lamp flashes for the time which has been set.

- After recording, the self-timer is canceled.
- If you press the PHOTO SHOT button halfway and then fully in auto focus mode, the subject is focused when the button is pressed halfway.
- When you press the PHOTO SHOT button fully in auto focus mode, the subject is focused just before recording.

To stop the timer midway through

Press the MENU button. (The self-timer setting is canceled.)

- The self-timer is canceled if the power is turned off or the mode dial is operated.
- The self-timer standby mode is canceled when you press the recording start/stop button to start motion picture recording. Even if you press the recording start/stop button while the self-timer is counting down, motion picture recording is not possible.
- Depending on the time taken to bring the subject into focus, the recording may take longer than set to start.
- Setting the self-timer to [T₂] is a good way to prevent image shake when the PHOTO SHOT button is pressed while using a tripod etc.

Built-in flash

Use the built-in flash in order to record still pictures in dark places.

◇ Rotate the mode dial to select  .

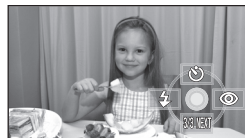

1 Press the cursor button. Then move the cursor button down to display the icon shown in the illustration.



2 Move the cursor button left to select [F].



- Each time the cursor button is pressed left, the indication changes by one setting in the following order: [FLASH ON] → [FLASH AUTO] → [FLASH OFF]
- When the PHOTO SHOT button is pressed halfway, the flash indicator will appear in the bottom left corner of the screen.

[FLASH ON]:	
[FLASH AUTO]:	
[FLASH OFF]:	

- When [FLASH AUTO] is set, the ambient brightness is automatically detected, and the flash will activate only when necessary. (If the flash is not necessary, the [⚡A] indicator will not appear when the PHOTO SHOT button is pressed halfway.)
- This function's default setting is [FLASH AUTO].

3 Press the PHOTO SHOT button.

The flash is activated and the picture will be recorded.

When the flash is not used

Set the flash to [FLASH OFF].

- Do not block the flash with your hand or by other means.
- The unit automatically determines if the flash is necessary even when it has been set to [FLASH OFF] by detecting the ambient brightness. (If it determines that the flash is necessary, the [⚡] indication lights up in red when the PHOTO SHOT button is pressed halfway.)
- If the [⚡] indication etc. flashes or is not displayed when the PHOTO SHOT button is pressed halfway, the flash is not activated.
- The available range of the flash is approx. 1 m to 2.5 m (3.3 feet to 8.2 feet) in dark places. Pictures will appear dark or reddish when they are recorded by using the flash at distances greater than 2.5 m (8.2 feet).
- Using the flash fixes the shutter speed of 1/750 or faster to 1/500.
- The picture may become out of focus in dark places. If so, adjust the focus manually.
- The picture may appear dark if the flash is lit in front of a white background.
- Set the flash to [FLASH OFF] where using a flash is prohibited.
- If the flash will be activated a large number of times, it may take longer to charge it.

Red eye reduction function

Reduces the phenomena where human eyes become red from flashes.

- 1 Press the cursor button. Then move the cursor button down to display the icon shown in the illustration.



- 2 Move the cursor button right to select [👁].



- The flash is activated 2 times. Do not move until the second flash is finished.
- Use this when you take pictures of people in dark places.
- Red eye phenomenon may appear depending on the recording conditions.

To adjust the brightness of the flash

Press the MENU button, then select [PICTURE] → [FLASH LEVEL] → desired item and press the cursor button.

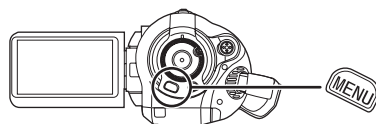

- [⚡-]: If the brightness is too high.
- [⚡±0]: In normal recording
- [⚡+]: If the brightness is insufficient.

Image stabilizer function

This is for reducing image shakes (jitter) during recording.

Reduces the image shaking (jitter) due to hand movement when recording.

- ◇ Rotate the mode dial to select  .
- Press the MENU button, then select [BASIC] → [O.I.S.] → [ON] and press the cursor button.

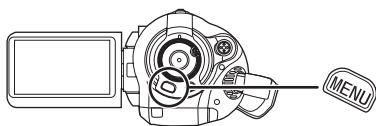

To cancel the image stabilizer function



Press the MENU button, then select [BASIC] → [O.I.S.] → [OFF] and press the cursor button.

- This function's default setting is [ON].
- In still picture recording mode, pressing the PHOTO SHOT button halfway increases the effect of the image stabilizer function. (MEGA optical image stabilizer)
- In the following cases, the image stabilizer function may not work effectively.
 - When the digital zoom is used
 - When the unit is shaken greatly
 - When you record a moving subject while tracking it

Guide line function

This is for viewing the slope and the balance of the image while recording or playing back.

You can check if the image is level while recording or playing back motion pictures and still pictures. The function can also be used to estimate the balance of the composition.

- ◇ Rotate the mode dial to select  or rotate the mode dial to  and then select the  (motion picture playback) tab. (→ 68)

Press the MENU button, then select [BASIC] or [PLAY SETUP] → [GUIDE LINES] → desired item and press the cursor button.

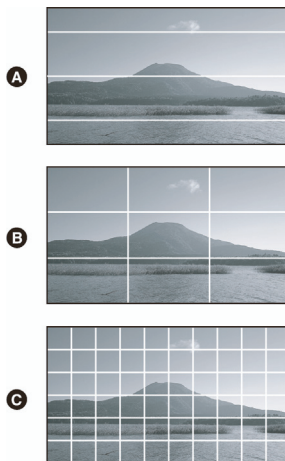
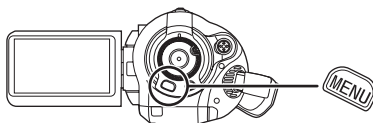

- A [HORIZONTAL]
- B [GRID1]
- C [GRID2]

To cancel the guide line function

Press the MENU button, then select [BASIC] or [PLAY SETUP] → [GUIDE LINES] → [OFF] and press the cursor button.

- The guide lines do not appear on the images actually recorded.

Wind noise reduction function

This is for reducing the wind noise coming into the microphone when recording.

- ◇ Rotate the mode dial to select  .

Press the MENU button, then select [VIDEO] → [WIND CUT] → [ON] and press the cursor button.

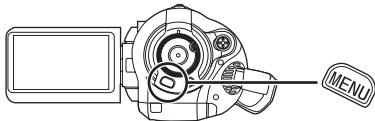

To cancel the wind noise reduction function

Press the MENU button, then select [VIDEO] → [WIND CUT] → [OFF] and press the cursor button.

- This function's default setting is [ON].
- The wind noise reduction depends on the wind strength. (The surround effect may be reduced if this function is activated in strong winds. However, the surround effect is automatically restored when the wind weakens.)
- The wind noise reduction function does not work with an external microphone.

Microphone level

This is for adjusting the microphone input level.

When recording, the input level from the built-in microphones and the external microphone terminal can be adjusted.

- ◇ Rotate the mode dial to select  .

- 1 Press the MENU button, then select [VIDEO] → [MIC LEVEL] → [SET+AGC] or [SET] and press the cursor button.

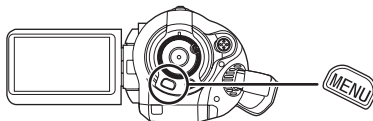

AGC: Auto Gain Control

[AUTO]: AGC is activated, and the recording level is adjusted automatically.

[SET+AGC]: The desired recording level can be set. AGC will also be activated to reduce the amount of sound distortion.

[SET]: AGC is not activated and so natural recording can be performed.

2 Move the cursor button left or right to adjust the microphone input level.

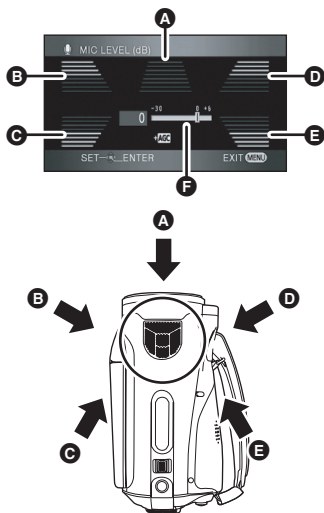

A Center

B Front left

C Back left

D Front right

E Back right

F Microphone input level

- A gain value for each of the 5 built-in microphones is displayed. (The input level of the microphones cannot be set individually.)

3 Press the center of the cursor button to set and then press the MENU button to finish the setting.

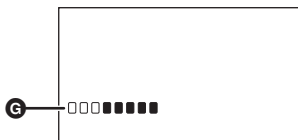

G Microphone input level meter

- Microphone input level meter is displayed on the screen.

To return to automatic setting

Press the MENU button, then select [VIDEO] → [MIC LEVEL] → [AUTO], and press the cursor button.

- Adjust the gain value so that the last 2 bars of the microphone input level on the center of the screen are not red. (Otherwise, the sound is distorted.) Select a lower setting for gain value or set [MIC LEVEL] to [AUTO].
- The front left and front right gain values only work when input is from an external microphone.
- The microphone input level meter shows the largest volume for the microphones.
- When [ZOOM MIC] is [ON], the volume will be different depending on the zoom rate. Set [ZOOM MIC] to [OFF] or set the microphone input level after adjusting the zoom rate. (→ 53)

Zebra display

This is for displaying the parts that are too bright.

Parts where white saturation (color saturation) is likely to occur (extremely brightly lit or shiny parts) are displayed with diagonal lines (zebra pattern).

◇ Rotate the mode dial to select  .
Press the MENU button, then select [ADVANCED] → [ZEBRA] → [ON] and press the cursor button.



A Zebra pattern

- You can record an image with little white saturation if you manually adjust the shutter speed or brightness (iris/gain) (→ 66).

To cancel the zebra display

Press the MENU button, then select [ADVANCED] → [ZEBRA] → [OFF] and press the cursor button.

- The zebra pattern does not appear on the images actually recorded.

Color bar

This is for displaying a color bar to check the color tone.

This unit displays a 7 color bar which is useful for adjusting the picture quality of the TV or the external monitor.

◇ Rotate the mode dial to select  .
Press the MENU button, then select [ADVANCED] → [COLOR BAR] → [ON] and press the cursor button.



To cancel the color bar

Press the MENU button, then select [ADVANCED] → [COLOR BAR] → [OFF] and press the cursor button.

- This function is canceled when the power is turned off.
- The icon will not be displayed even if you press the cursor button.

Manual recording functions

Scene mode

This is for recording in various situations.

When you record images in different situations, this mode automatically sets optimum shutter speeds and apertures.

◇ Rotate the mode dial to select  .

1 Set the AUTO/MANUAL/FOCUS switch to MANUAL.

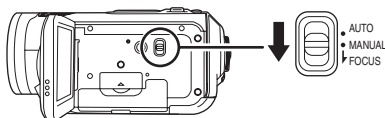

2 Press the MENU button, then select [BASIC] → [SCENE MODE] → desired item and press the cursor button.

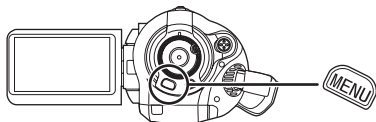

[] Sports

To record sports scenes or scenes where there are quick motions

[] Portrait

To make people stand out against the background

[] Low light

To make the scene brighter in dark conditions

[] Spotlight

To make the subject under a spotlight look more attractive

[] Surf & snow

To record images in bright places such as ski slopes and beaches

To cancel the scene mode function

Press the MENU button, then select [BASIC] → [SCENE MODE] → [OFF].

- You can also cancel the scene mode function by setting the AUTO/MANUAL/FOCUS switch to AUTO.

Sports mode

- For slow-motion playback or playback pause of recorded pictures, this mode helps diminish camera shake.
- During normal playback, the image movement may not look smooth.
- Avoid recording under fluorescent light, mercury light or sodium light because the color and brightness of the playback image may change.
- If you record a subject illuminated with strong light or a highly reflective subject, vertical lines of light may appear.
- If the brightness is insufficient, the sports mode does not function. The [] display flashes.
- If this mode is used indoors, the screen may flicker.

Portrait mode

- If this mode is used indoors, the screen may flicker. If so, change the scene mode setting to [OFF].

Low light mode

- Extremely dark scenes may not be able to be recorded finely.

Spotlight mode

- If the recording subject is extremely bright, the recorded image may become whitish and the periphery of the recorded image extremely dark.

Surf & snow mode

- If the subject is extremely bright, the recorded image may become whitish.

Manual focus adjustment

If auto focusing is difficult due to the conditions, then manual focusing is available.

◇ Rotate the mode dial to select  .

- 1 (When MF assist function is used)
Press the MENU button, then select [ADVANCED] → [MF ASSIST] → [ON] and press the cursor button.

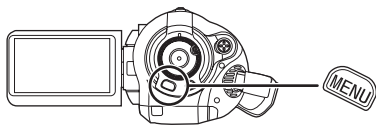

- The default setting is [ON].

- 2 Set the AUTO/MANUAL/FOCUS switch to MANUAL.

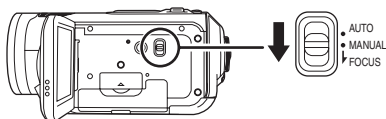

- 3 Move the switch down and set it to FOCUS position.



The manual focus indication [MF] and the icon shown in the illustration appear.

- 4 Move the cursor button left or right to bring the subject into focus.



The center of the screen is enlarged. The normal screen returns approximately 2 seconds after you finish bringing the subject into focus.

- The center of the screen is not enlarged when [MF ASSIST] is [OFF].

To restore to the automatic adjustment

Press the AUTO/MANUAL/FOCUS switch down again to the FOCUS position.

- You can also restore the auto focusing by setting the AUTO/MANUAL/FOCUS switch to AUTO.

- The subject may not be in focus when zoomed in if focusing with a wide angle. First, zoom in on the subject, and then focus on it.



About the MF assist function

The center of the screen is enlarged during manual focus adjustment. This allows you to focus on the subject more easily.

- MF assist does not work if the zoom magnification is more than 12×.
- The part of the screen that is enlarged is not enlarged on the image actually recorded.
- The zebra pattern does not appear on the part of the screen that is enlarged when [ZEBRA] is [ON].

White balance

This is for recording in natural colors.

The automatic white balance function may not reproduce natural colors depending on the scenes or lighting conditions. If so, you can adjust the white balance manually.

◇ Rotate the mode dial to select  .

1 Set the AUTO/MANUAL/FOCUS switch to MANUAL.



The icon shown in the illustration is displayed automatically.

2 Move the cursor button up to select [WB].



3 Move the cursor button left or right to select the white balance mode.



[AWB]: Auto white balance adjustment

[]: Indoor mode (for recording under incandescent lamps)
 ●Incandescent lights, halogen lamps

[]: Outdoor mode
 ●Outdoors under a clear sky

[]: Manual adjustment mode
 ●Mercury-vapor lamps, sodium lamps, some fluorescent lights

- Lights used for wedding receptions at hotels, stage spotlights in theatres
- Sunrise, sunset etc.

To restore to the automatic adjustment

Set the white balance mode to [AWB].

- You can also restore the automatic adjustment by setting the AUTO/MANUAL/FOCUS switch to AUTO.

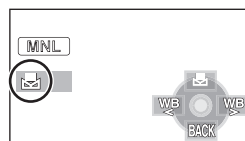

To set the white balance manually

1 Select [], fill the screen with a white subject.

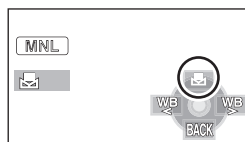

2 Move the cursor button up to select [].



- When the [] display changes from flashing to on, setting is complete.
- When the [] display continues flashing, the white balance cannot be set because the place is dark etc. In this case, use the automatic white balance.

About the white balance sensor

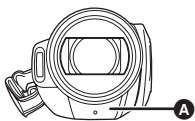

The white balance sensor **A** detects the type of light source during recording.

Do not cover the white balance sensor during recording, or it may not function properly.

About the black balance adjustment

This is one of the 3CCD system functions that automatically adjusts the black when the white balance is set in the manual adjustment mode. When the black balance is adjusted, the screen will temporarily be black. (The black balance cannot be adjusted manually.)



- 1 Black balance adjustment in progress. (Flashes.)
- 2 White balance adjustment in progress. (Flashes.)
- 3 Adjustment completed. (Lights up.)

- When the [WB] display flashes, the manual white balance previously adjusted is stored. Whenever recording conditions change, re-set the white balance for correct adjustment.
- When setting both the white balance and the iris/gain, set the white balance first.

Manual shutter speed/aperture adjustment

Shutter Speed:

Adjust it when recording fast-moving subjects.

Aperture:

Adjust it when the screen is too bright or too dark.

- ◇ Rotate the mode dial to select .

1 Set the AUTO/MANUAL/FOCUS switch to MANUAL.



The icon shown in the illustration is displayed automatically.

2 Move the cursor button left or right to select [IRIS] (aperture) or [SHTR] (shutter speed).



3 Move the cursor button left or right to make the adjustment.



A Shutter speed:

1/60 to 1/8000

- The shutter speed closer to 1/8000 is faster.

B Iris/Gain value:

CLOSE → (F16 to F2.0) → OPEN → (0dB to 18dB)

- Value closer to [CLOSE] darken the image.
- Value closer to [18dB] brighten the image.

- When the iris value is adjusted to brighter than [OPEN], it changes to the gain value.

To restore to automatic adjustment

Set the AUTO/MANUAL/FOCUS switch to AUTO.

- When setting both the shutter speed and the iris/gain value, set the shutter speed and then set the iris/gain value.

Manual shutter speed adjustment

- Avoid recording under fluorescent light, mercury light or sodium light because the color and brightness of the playback image may change.
- If you increase the shutter speed manually, the gain value will increase automatically depending on how much the sensitivity lowers and the noise on the screen may increase.
- When recording still pictures, we recommend setting the shutter speed to 1/500 or less for even more beautiful pictures.
- You may see vertical lines of light in the playback image of a brightly shining subject or highly reflective subject, but this is not a malfunction.
- During normal playback, image movement may not look smooth.
- When recording in an extremely bright place, the screen may change color or flicker. If so adjust the shutter speed manually to [1/60] or [1/100].

Manual iris/gain adjustment

- If the gain value is increased, the noise on the screen increases.
- Depending on the zoom magnification, there are iris values that are not displayed.

Playback

Motion picture playback

Play back motion pictures.

1 Rotate the mode dial to select

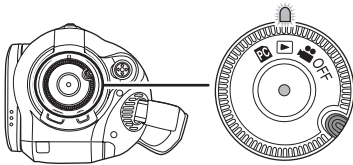

The lens cover closes.

2 Press the cursor button up and then left to select the (motion picture playback) tab.

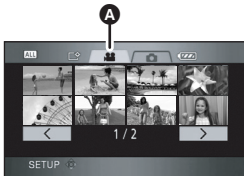

A Motion picture playback tab

The motion pictures are displayed as thumbnails (reduced-size images).

3 Select the scene to be played back.







B Previous page

C Next page

D Scene number

The selected scene will be encircled by a yellow frame.

- If 9 or more scenes have been recorded, the next (or previous) page can be displayed by moving the cursor button left and right or moving the cursor button down, selecting  /  by moving the cursor button left and right and then pressing the center of the cursor button.
- The scene number display switches to the page number when the motion picture playback tab or  /  is selected.

4 Press the cursor button.



The selected scene is played back on the full screen.

- The operation icon is automatically displayed on the screen.

5 Move the cursor button to operate.

- ▶/||: Playback/Pause
- ◀◀ (Move and hold): Review playback*
- ▶▶ (Move and hold): Cue playback*
- : Stops the playback and shows the thumbnails.

* Press the ◀◀ or ▶▶ button on the remote control.

About motion picture compatibility

- This unit is based on the AVCHD format.
- The video signal that can be played back on this unit is 1440×1080/60i.
- This unit may degrade or not playback motion pictures recorded or created on other products, and other products may degrade or not playback motion pictures recorded on this unit, even if the products support the AVCHD.

- No sound will be heard except during normal playback.
- If pause play is continued for 5 minutes, the screen returns to the thumbnails.
- When the amount of time recorded on the scene is short, playback may not be possible.
- Scenes which cannot be displayed as thumbnails (the thumbnails are displayed as ) cannot be played back. An error message appears and the screen shows the thumbnails.
- The power will not turn off even if the LCD monitor is closed.
- The date/time displayed may be different from the recording date/time and it may take time to display the thumbnail display when playing back motion pictures not recorded on this unit.
- The remaining time for playback indication will be reset to "0h00m00s" each scene.

Skip playback (to the start of a scene)

(Operation is possible with the remote control only.)

Press the  or  button on the remote control during playback.

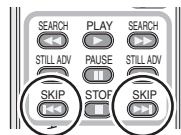

Slow-motion playback

- 1 Move the cursor button up during playback to pause the playback.
- 2 Move and hold the cursor button right. (Slow-motion pictures will be played back in reverse when you move and hold the cursor button left.)



- Normal playback is restored when you move the cursor button up.
- When slow-motion pictures are played back in reverse, they will be shown continuously at intervals of 0.5 seconds.

Operating with the remote control

Press the  or  button.

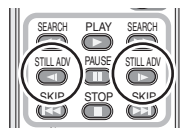

Frame-by-frame playback

The motion picture is advanced one frame at a time.

- 1 Move the cursor button up during playback to pause the playback.
- 2 Move the cursor button right. (The frames will be advanced one at a time in the reverse direction when you move the cursor button left.)



- Normal playback is restored when you move the cursor button up.
- When the frames are advanced one at a time in the reverse direction, they will be shown in intervals of 0.5 seconds.

Operating with the remote control

- 1) Press the **||** button.



- 2) Press the **◀** or **▶** button.

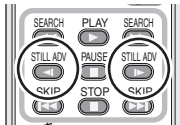

To adjust the volume

Adjust the speaker volume during playback.

Move the volume lever to change the volume level.

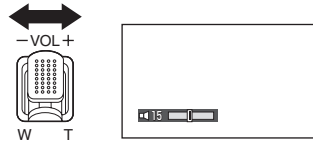

Towards “+”: increases the volume
Towards “-”: decreases the volume

- The further the [] indicator moves to the right, the higher the volume level becomes.
- When the adjustment is completed, the volume setting display will disappear.

Playing back motion pictures by date

Recorded scenes are grouped by date on this unit.

Scenes recorded on the same day can be played back in succession.

- 1 Press the MENU button, then select [PLAY SETUP] → [PLAY MODE] → [BY DATE] and press the cursor button.

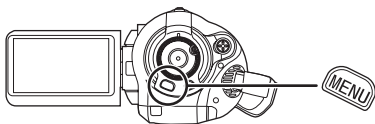

- 2 Select the date for playback, then press the cursor button.



The scenes recorded on the same day are displayed as thumbnails.

- 3 Select the scene to be played back.

To return to playing back all the scenes

Press the MENU button, then select [PLAY SETUP] → [PLAY MODE] → [VIEW ALL] and press the cursor button.

- When [PLAY MODE] is set to [VIEW ALL], all recorded motion pictures will be played back in succession. ([ALL] is displayed.)
- Playing back all the scenes returns if the power is turned off or the mode dial is operated.
- Even if scenes are recorded on the same day, they are grouped separately in the following cases.
 - When the number of scenes exceeds 99
 - When the card is repaired

Repeat playback

Playback of the first scene starts after playback of the last scene finishes.

- Press the MENU button, then select [PLAY SETUP] → [REPEAT PLAY] → [ON] and press the cursor button.

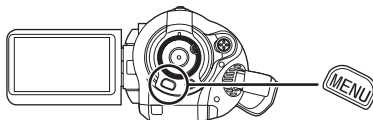

The [↺] indication appears on the thumbnail and full screen views.

- The following scenes can be played back repeatedly.
 - When [PLAY MODE] is set to [VIEW ALL]: All the scenes on the SD card
 - When [PLAY MODE] is set to [BY DATE]: All the scenes on the selected date

To cancel the repeat playback function

Press the MENU button, then select [PLAY SETUP] → [REPEAT PLAY] → [OFF] and press the cursor button.

Resuming the previous playback

If playback of a scene was stopped halfway, the playback can be resumed from where it was stopped.

Press the **MENU** button, then select **[PLAY SETUP]** → **[RESUME PLAY]** → **[ON]** and press the cursor button.

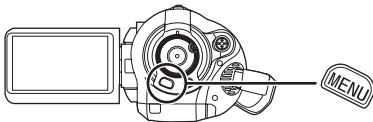

If playback of a motion picture is stopped, [>>>] appears on the thumbnail view of the stopped scene.

To cancel the resume playback function

Press the **MENU** button, then select **[PLAY SETUP]** → **[RESUME PLAY]** → **[OFF]** and press the cursor button.

- The memorized resume position is cleared if you turn off the power or operate the mode dial. (The **[RESUME PLAY]** setting is kept.)

Still picture (JPEG) playback

Play back the still pictures recorded on the card.

1 Rotate the mode dial to select

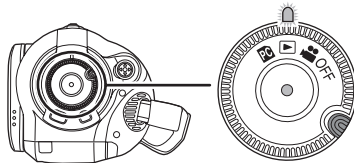

The lens cover closes.

2 Press the cursor button up and then right to select the (still picture playback) tab.

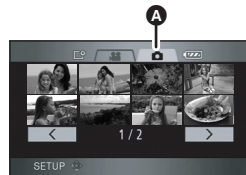

A Still picture playback tab





The still pictures recorded on the SD card are displayed as thumbnails (reduced-size images).

3 Select the file to be played back.



- B Previous page
- C Next page
- D File number display
- E Folder/file name

The selected file will be encircled by a yellow frame.

- If 9 or more files have been recorded, the next (or previous) page can be displayed by moving the cursor button left and right or moving the cursor button down, selecting  /  by moving the cursor button left and right and then pressing the center of the cursor button.
- The file number display switches to the page number when the still picture playback tab or  /  is selected.

4 Press the cursor button.



The selected file is played back on the full screen.

- The operation icon is automatically displayed on the screen.

5 Move the cursor button to operate.

- ▶/||: Slide show (playback of the still pictures on the SD card in numerical order) start/pause.
- ◀: Plays back the previous picture.
- ▶: Plays back the next picture.
- : Stops the playback and shows the thumbnails.

■ About still picture compatibility

- This unit is compliant with the unified standard DCF (Design rule for Camera File system) established by JEITA (Japan Electronics and Information Technology Industries Association).
 - The file format supported by this unit is JPEG. (Not all JPEG formatted files will be played back.)
 - If a non-standard file is played back, the folder/file name may not be displayed.
 - This unit may degrade or not play back data recorded or created on other products and other products may degrade or not play back data recorded on this unit.
-
- While this unit accesses the SD card (the access lamp is lit), do not remove the SD card.
 - Do not operate the mode dial during the slide show.
 - It takes time to display the file depending on the number of pixels of the file.
 - Files which cannot be displayed as thumbnails (the thumbnails are displayed as ) cannot be played back.
 - If you attempt to play back a file which is a different format or a damaged file, an error message appears and the screen shows the thumbnails.
 - The date/time displayed may be different from the recording date/time and it may take time to display the thumbnail display when playing back still pictures not recorded on this unit.
 - The power will not turn off even if the LCD monitor is closed.

Editing



Editing scenes

Deleting scenes

This is for deleting scenes recorded on SD cards.

The deleted scenes cannot be restored.

Deleting scenes one at a time

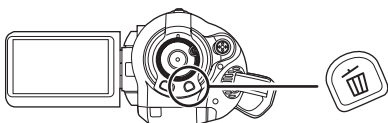

- ◇ Rotate the mode dial to select  and then select the  (motion picture playback) tab.

- 1 Press the  button during playback.



- 2 When the confirmation message appears, select [YES], then press the cursor button.

Deleting multiple scenes from the thumbnail display

- ◇ Rotate the mode dial to select  and then select the  (motion picture playback) tab.

- 1 Press the  button while the thumbnail view screen is displayed.

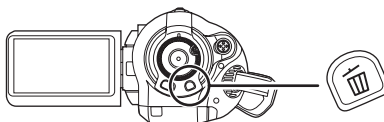

- 2 Move the cursor button up or down to select [ALL SCENES] or [SELECT] and press the cursor button.



- When [ALL SCENES] is selected, the following scenes except the protected scenes will be deleted. Proceed to step 5.
 - When [PLAY MODE] is set to [VIEW ALL]: All the scenes on the SD card
 - When [PLAY MODE] is set to [BY DATE]: All the scenes selected by date

- 3 (Only when [SELECT] is selected in step 2) Select the scene to be deleted, then press the cursor button.



The selected scene is encircled by a red frame.

- When the cursor button is pressed again, the selected scene will be canceled.
- Up to 50 scenes can be set in succession.

4 (Only when [SELECT] is selected in step 2)
Press the  button.

5 When the confirmation message appears, select [YES], then press the cursor button.

(Only when [SELECT] is selected in step 2)

To continue deleting other scenes

Repeat steps 3-5.

To complete editing



Press the MENU button.

- Scenes which cannot be played back (the thumbnails are displayed as ) cannot be deleted.
- Protected scenes cannot be deleted.
- Do not open the card slot cover while deleting. The deletion will stop.
- In case of [ALL SCENES], the deletion may take time if there are many scenes on the SD card.
- Do not turn off this unit while deleting.
- When you delete scenes, use a battery with sufficient battery power or use the AC adaptor.
- If you delete scenes recorded on other products with this unit, all the data related to the scenes may be deleted.

Protecting scenes

This is for preventing scenes from being deleted by mistake.

Scenes can be protected so that they are not deleted by mistake. (Even if you protect some scenes on an SD card, formatting the SD card will delete them.)

- ◇ Rotate the mode dial to select  and then select the  (motion picture playback) tab.

1 Press the MENU button, then select [PLAY SETUP] → [SCENE PROTECT] → [YES] and press the cursor button.

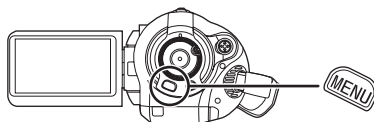

2 Select the scene to be protected and then press the center of the cursor button.



The  indication appears and the scene is protected.

- Press the cursor button again to cancel the setting.
- 2 or more scenes can be set in succession.

To complete the settings

Press the MENU button.



Editing still pictures

Deleting still pictures

This is for deleting still picture files recorded on SD cards.

The deleted files cannot be restored.

Deleting files one at a time

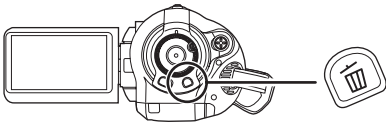

- ◇ Rotate the mode dial to select  and then select the  (still picture playback) tab.

- 1 Press the  button during playback.



- 2 When the confirmation message appears, select [YES], then press the cursor button.

Deleting multiple files from the thumbnail display

- ◇ Rotate the mode dial to select  and then select the  (still picture playback) tab.

- 1 Press the  button while the thumbnail view screen is displayed.

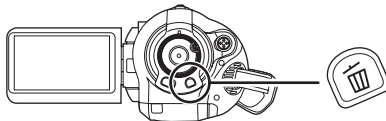

- 2 Move the cursor button up or down to select [ALL SCENES] or [SELECT] and press the cursor button.

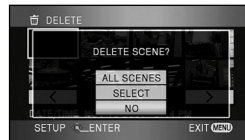

- When [ALL SCENES] is selected, all files on the SD card except the protected files will be erased. Proceed to step 5.

- 3 (Only when [SELECT] is selected in step 2) Select the file to be deleted, then press the cursor button.

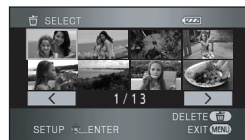

The selected file is encircled by a red frame.

- When the cursor button is pressed again, the selected file will be canceled.
- Up to 50 files can be set in succession.

- 4 (Only when [SELECT] is selected in step 2) Press the  button.

5 When the confirmation message appears, select [YES], then press the cursor button.

(Only when [SELECT] is selected in step 2)

To continue deleting other files

Repeat steps 3-5.

To complete editing

Press the MENU button.

■ Deleting still picture files recorded on an SD card by other products



A still picture file (other than JPEG) that cannot be played back on this unit may be erased.

- Protected files cannot be deleted.
- Do not open the card slot cover while deleting. The deletion will stop.
- In case of [ALL SCENES], the deletion may take time if there are many files on the SD card.
- Do not turn off this unit while deleting.
- When you delete files, use a battery with sufficient battery power or use the AC adaptor.
- If files conforming to DCF standard are deleted, all the data related to the files will be deleted.

Protecting still pictures

This is for preventing still picture files from being deleted by mistake.

Files recorded on an SD card can be protected so that they are not deleted by mistake. (Even if you protect some files on an SD card, formatting the SD card will delete them.)

- ◇ Rotate the mode dial to select  and then select the  (still picture playback) tab.

- 1 Press the MENU button, then select [PLAY SETUP] → [SCENE PROTECT] → [YES] and press the cursor button.

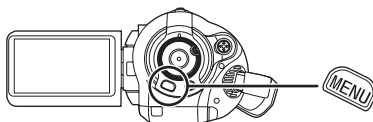

- 2 Select the file to be protected and then press the center of the cursor button.



The  indication appears and the file is protected.

- Press the cursor button again to cancel the setting.
- You can also select multiple files in succession.



To complete the settings

Press the MENU button.

DPOF setting

This is for writing the printing data on an SD card.

You can write the data of the still pictures to be printed and the number of prints (DPOF data) onto the SD card.

◇ Rotate the mode dial to select  and then select the  (still picture playback) tab.

1 Press the MENU button, then select [PLAY SETUP] → [DPOF SET] → [SET] and press the cursor button.

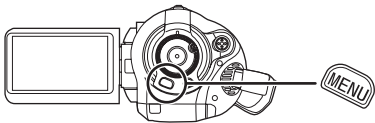

2 Select the file to be set and then press the center of the cursor button.



The number of prints set to be in DPOF is displayed.

3 Move the cursor button up or down to select the number of prints, then press the cursor button.

- You can select from 0 to 999. (The selected number of pictures can be printed with the printer supporting DPOF.)
- To cancel the setting, set the number of prints to [0].
- You can also select multiple files in succession.

To complete the settings

Press the MENU button.

To cancel all DPOF settings

Press the MENU button, then select [PLAY SETUP] → [DPOF SET] → [CANCEL ALL] and press the cursor button.

- When the confirmation message appears, select [YES], then press the cursor button.

What is DPOF?

DPOF stands for Digital Print Order Format. This enables picture printing information to be written onto an SD card so that it can be used on a system supporting DPOF.



- The DPOF setting can be established for up to 999 prints.
- DPOF setting made on other devices may not be recognized by this unit. Please perform the DPOF settings on this unit.
- You cannot add the recording date to pictures to be printed with the DPOF settings.

Card management

Formatting

Formatting an SD card This is for initializing cards.

Please be aware that if an SD card is formatted, then all the data recorded on the card will be erased. Store important data on a computer etc.

- ◇ Rotate the mode dial to select  or .

- 1 Press the MENU button, then select [SETUP] → [FORMAT CARD] → [YES] and press the cursor button.

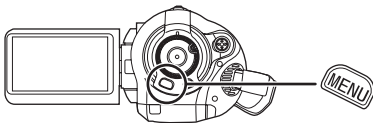

- 2 When the confirmation message appears, select [YES], then press the cursor button.

- When formatting is complete, press the MENU button to exit the message screen.

- Use this unit to format SD cards. If an SD card is formatted on other products (such as a computer), the time spent for recording may become longer and you may not be able to use the SD card.
- Depending on the type of SD card being used, it may take time to format.
- During formatting, do not turn this unit off.
- When you format the SD card, use a battery with sufficient battery power or the AC adaptor.
- Do not remove the SD card while formatting.

With other products

With a TV

Playback on TV

The motion pictures and still pictures recorded on this unit can be played back on a TV screen. Connect this unit to a TV with one of the following terminals. When connecting to a HDMI terminal, a connection cable (optional) is necessary.

- ◇ Difference in picture quality depending on the terminal used for connection

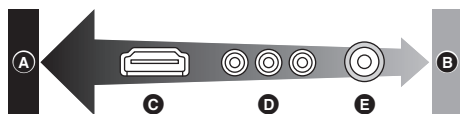

- A** High quality
- B** Standard quality
- C** HDMI terminal
- D** Component terminal
- E** Video terminal

TV/Devices you use	Reference items
TV with a HDMI terminal	① Connecting with a HDMI cable (optional) (→ 81)
TV with a HDMI terminal and AV amplifier with a HDMI terminal	② Listening in 5.1 channel sound (→ 83)
TV with a component terminal	③ Connecting with the component cable (supplied) and the AV cable (supplied) (→ 84)
Other TVs	④ Connecting with the AV cable (supplied) (→ 86)

- Do not use any other AV cables except the supplied one.
- Do not use any other component cables except the supplied one.

- Use the AC adaptor to free you from worrying about the battery running down.

■ To display the on-screen information on the TV

The information displayed on the screen (operation icon and time code etc.) can be displayed on the TV.

Press the EXT DISPLAY button on the remote control.

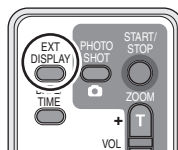

- Press the button again to erase the information.
- The screen on this unit will not change.

■ To watch images with a 16:9 aspect ratio on a regular TV (4:3)

When playing back motion pictures or still pictures recorded on this unit with a 16:9 aspect ratio on a TV with a 4:3 aspect ratio, the images on the screen may be squeezed horizontally. In this case, change the menu setting to play back the pictures in the original aspect ratio. (Depending on the TV setting, the pictures may not be displayed correctly. For more information, please read the operating instructions of your TV.)

Press the MENU button, then select [SETUP] → [TV ASPECT] → [4:3] and press the cursor button.

Example of images with a 16:9 aspect ratio on a regular TV (4:3)

[TV ASPECT] setting	
[16:9]	[4:3]

1 Connecting with a HDMI cable (optional)

What is HDMI?

HDMI is the next-generation interface for digital devices. When this unit is connected to a HDMI compatible device, the image and audio can be output with a digital signal. If you connect this unit and a HDMI compatible high definition TV and then play back the recorded high definition images (→ 13), you can enjoy them in high resolution with high quality sound.

If you connect this unit to a Panasonic TV compatible with EZ Sync™ (HDAVI Control™), linked operations are possible. (→ 87)

1 Connect this unit and a TV with the HDMI cable (optional).

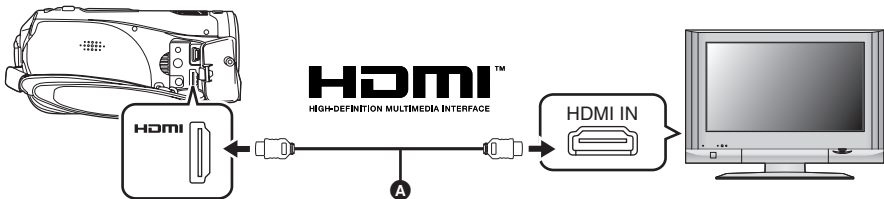

Use a HDMI cable (optional) **A** with the logo shown above.

2 Set the mode dial to to turn on the power.

3 Select the input channel on the TV.

Example: Select the [HDMI] channel etc.

(The name of the channel may differ depending on the connected TV.)

4 Start playback on this unit.

The image and audio are output on the TV.

■ If the image or audio from this unit is not output on the TV

- Check that the plugs are inserted as far as they go.
- Check the connected terminal.
- Check the input setting (input switch) and the audio input setting on the TV. (For more information, please read the operating instructions for the TV.)
- Check [HDMI RESOLUTION]. (→ 82)

■ About the settings when connecting with HDMI

When this unit is connected to another device with a HDMI cable, the output setting on this unit can be changed.

HDMI output resolution

You can switch the method to output the images.

Press the MENU button, then select [SETUP] → [HDMI RESOLUTION] → desired item and press the cursor button.

[AUTO]: The output resolution is automatically set based on the information from the connected TV.

Information from the connected TV	Output resolution
720p, 1080i	1080i
Others	480p

[1080i]: The interlace method with 1080 available scan lines is used for output.

[480p]: The progressive method with 480 available scan lines is used for output.

- If the images are not output on the TV when the setting is [AUTO], switch to the method [1080i] or [480p] which enables the images to be displayed on your TV. (Please read the operating instructions for the TV.)
- Be sure to connect to an HDMI input terminal. Do not connect to an HDMI output terminal on other products.

1080i

This is an interlace scan method which scans 1080 scan lines to display a high definition image. The 1080 available scan lines are divided in half and scanned on the screen alternatively every 1/60th of a second. The number of available scan lines is more than double the 480 scan lines used to display standard images until now so the images have clearer detail and a lot of presence.

480p

This is a progressive scan method which scans all 480 available scan lines on the screen at the same time every 1/60th of a second. This method reduces the flickering as the scan lines are not scanned on the screen alternatively like in the interlace method.

480i

This is an interlace scan method in which the 480 available scan lines are divided in half and scanned on the screen alternatively every 1/60th of a second.

Interlace method/progressive method

Video signals until now (NTSC) are referred to as 480i (i is short for interlace) whereas a high-density video signal that doubles the number of scan lines is called 480p (p is short for progressive).

The component terminal and the HDMI terminal on this unit are also compatible with high definition image output 1080i. It is necessary to have a compatible TV to enjoy progressive and high definition images.

② Listening in 5.1 channel sound

If you connect this unit and an AV amplifier with a HDMI terminal with a HDMI cable and then playback, you can listen to 5.1 channel sound recorded from the internal microphones.

- Please read the operating instructions for the AV amplifier, speakers and TV for more information about how to connect them etc.

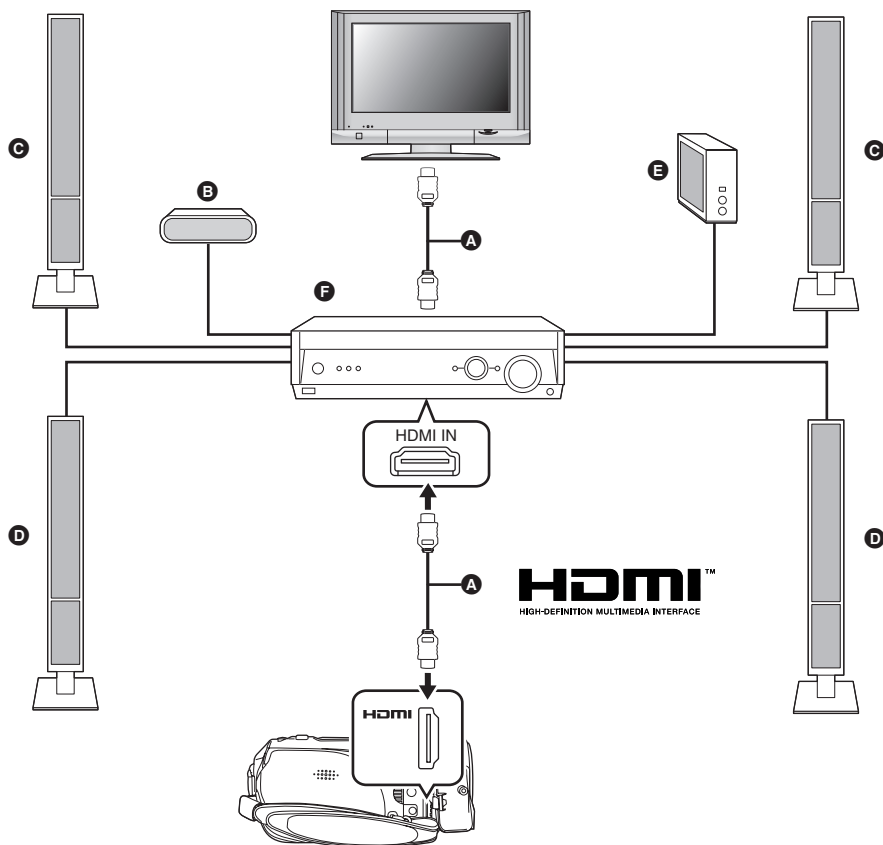

- **A** HDMI cable (optional)
 - Use a HDMI cable (optional) with the logo shown above.
- **B** Center speaker
- **C** Front speaker
- **D** Surround speaker
- **E** Subwoofer
- **F** AV amplifier (optional)

● If you connect this unit to a Panasonic AV amplifier and Panasonic TV that are compatible with EZ Sync™ (HDAVI Control™), linked operations become possible. (→ 87)

● Audio recorded from an external microphone is in stereo (2ch).

3 Connecting with the component cable (supplied) and the AV cable (supplied)

1 Connect this unit and a TV with the component cable (supplied) and the AV cable (supplied).

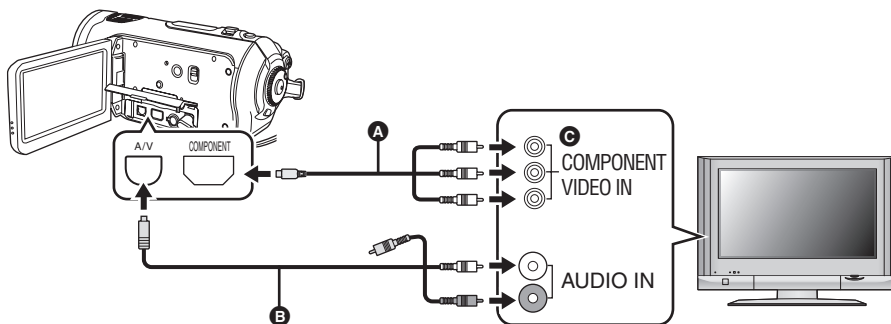

A Component cable (supplied)

B AV cable (supplied)

• Connect to terminals of the same color.

• The component terminal **C** is for outputting images only so be sure to also connect the AV cable. (Insert it in the audio input terminal for the component terminal input. Refer to the operating instructions of the TV for details.)

2 Set the mode dial to to turn on the power.

3 Select the input channel on the TV.

Example: Select the [Component] channel etc.

(The name of the channel may differ depending on the connected TV.)

4 Start playback on this unit.

The image and audio are output on the TV.

■ About the setting when connecting the component terminals

When this unit is connected to a TV with the component cable, the output setting on this unit can be changed. Set it to match the terminal on the TV that you connect to.

Press the MENU button, then select [SETUP] → [COMPONENT OUT] → desired item and press the cursor button.

[480i]: When connecting to the component terminal on the TV compatible with 480i.
(Playback is in standard quality.)

[1080i]: When connecting to the component terminal on the TV compatible with 1080i.
(Playback is in high definition quality.)

■ If the image or audio from this unit is not output on the TV

- Check that the plugs are inserted as far as they go.
- Check the connected terminal.
- **Check the TV's input setting (input switch).**
(For more information, please read the operating instructions for the TV.)

-
- If the images are not displayed correctly on a wide-screen TV, adjust the aspect setting on the TV. (Refer to the operating instructions of the TV for details.) If the pictures are displayed squeezed horizontally on a regular TV (4:3), change the setting on this unit. (→ 80)

4 Connecting with the AV cable (supplied)

1 Connect this unit and a TV with the AV cable (supplied).

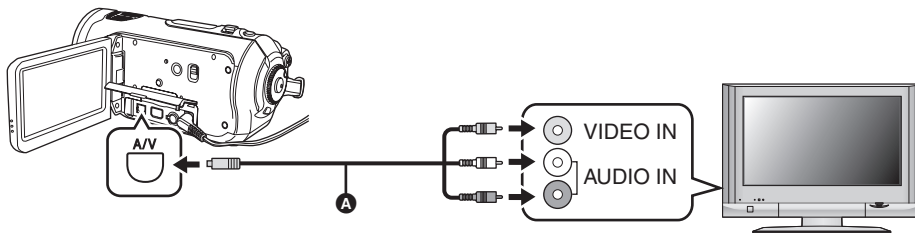

A AV cable (supplied)

2 Set the mode dial to to turn on the power.

3 Change the input channel on the TV.

Example: Select the [Video 2] channel etc.

(The name of the channel may differ depending on the connected terminal.)

4 Start playback on this unit.

The image and audio are output on the TV.

■ If the image or audio from this unit is not output on the TV

- Check that the plugs are inserted as far as they go.
 - Check the connected terminal.
 - Check the TV's input setting (input switch). (For more information, please read the operating instructions for the TV.)
-
- When a HDMI cable is connected at the same time, priority is given to the output from the HDMI cable.
 - When the component cable is connected at the same time, priority is given to the component cable for image output.
 - If the images are not displayed correctly on a wide-screen TV, adjust the aspect setting on the TV. (Refer to the operating instructions of the TV for details.) If the pictures are displayed squeezed horizontally on a regular TV (4:3), change the setting on this unit. (→ 80)

Playback using EZ Sync™ (HDAVI Control™)

If you connect this unit to a Panasonic TV compatible with EZ Sync™ (HDAVI Control™) with a HDMI cable, the following linked operations become possible.

- You can use the remote control for the TV to control playback on this unit.
- If you use the remote control for the TV to turn off the power, the power on this unit also turns off. (When recording motion pictures, formatting, deleting, recovering or connecting the unit to a computer with a USB cable, the power will not turn off.)
- If you connect with a HDMI cable and then turn on the power on this unit, the input channel on the TV automatically switches to this unit's screen. If the TV's power is in standby status, it will turn on automatically (if [Set] has been selected for the TV's [Power on link] setting).
 - Depending on the HDMI terminal on the TV, the input channel may not switch automatically. In this case, use the remote control for the TV to switch the input channel. (For details on how to switch input, please read the operating instructions for the TV.)
- If EZ Sync does not work properly, refer to page 119.

1 Connect this unit and a Panasonic TV compatible with EZ Sync with a HDMI cable (optional).

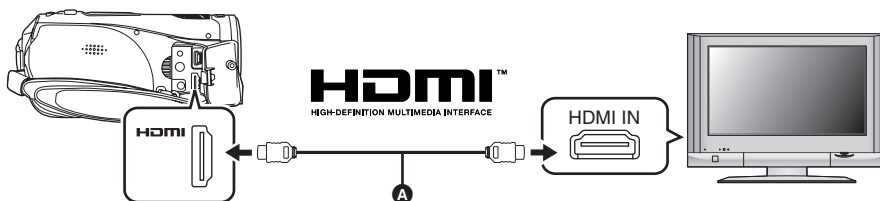

- Use a HDMI cable (optional) **A** with the logo shown above.
- If the TV has two or more HDMI input terminals, it is recommended to connect this unit to HDMI2 or HDMI3.

2 Set so that EZ Sync is activated on the connected TV.

- Read the operating instructions of the TV for how to set etc.

3 Set the mode dial to to turn on the power.

4 Press the MENU button, then select [SETUP] → [EZ Sync] → [ON] and press the cursor button.

- The default setting is [ON].

5 Operate with the remote control for the TV.

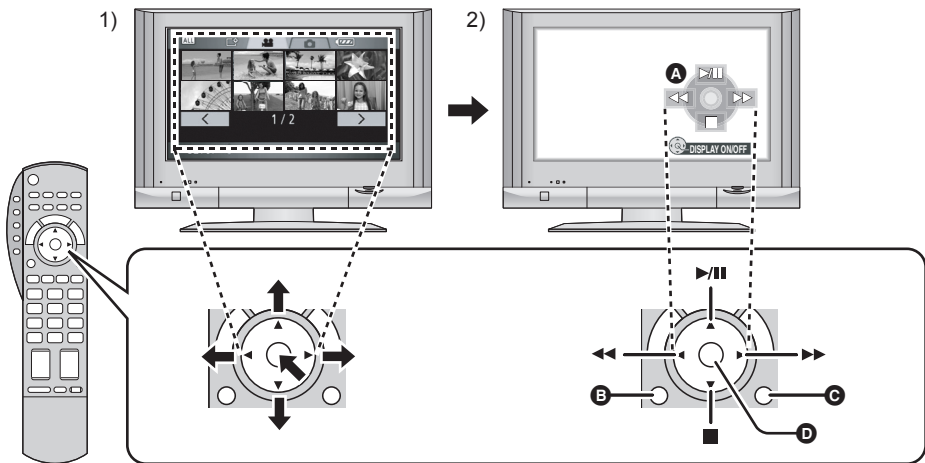

- 1) Press the button up, down, left or right to select a scene or file to be played back, and then press the button in the center to set it.
 - 2) Activate the operation icons that are displayed on TV screen with the remote control for the TV.
 - A** Operation icons
 - B** Display operation icons
 - C** Cancel operation icons
 - D** Display/Cancel operation icons
- The playback operation is performed the same as on this unit.
 - Playing back motion pictures (→ 68)
 - Playing back still pictures (→ 72)

To cancel EZ Sync™ (HDAVI Control™)

Press the MENU button, then select [SETUP] → [EZ Sync] → [OFF] and press the cursor button.

- If you are unsure whether or not the TV and AV amplifier you are using are compatible with EZ Sync, read the operating instructions for the devices.
- Available linked operations between this unit and a Panasonic TV is different depending on the types of Panasonic TVs even if they are compatible with EZ Sync. Refer to the operating instructions of the TV for the operations that support on the TV.
- Operation is not possible with a cable that is not based on the HDMI standard. We recommend Panasonic cables.
Part numbers: RP-CDHG15 (1.5 m/4.9 feet), RP-CDHG30 (3.0 m/9.8 feet), RP-CDHG50 (5.0 m/16.4 feet), etc.

Dubbing images onto a connected DVD recorder or video device

This is for dubbing images recorded on this unit onto a DVD recorder, video device etc.

- Images are dubbed in standard quality.
- Use the AC adaptor to free you from worrying about the battery running down.

1 Connect this unit and a video device.

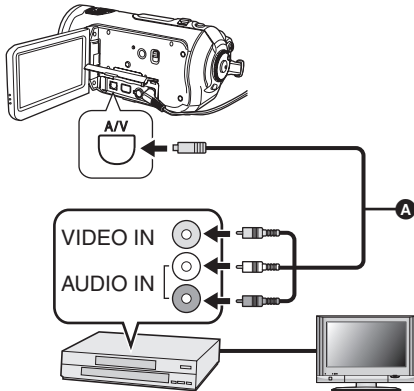

A AV cable (supplied)

- Insert the plugs as far as they will go.

2 Set the mode dial to to turn on the power.

3 Change the input channel on the video device and TV.

- The channel set will differ depending on the terminal to which the unit is connected.

4 Start playback on this unit. Then start recording on the connected device.

- See the operating instructions of the video device for details.

To stop dubbing

- 1) Stop recording on the connected device.
- 2) Then stop playback on this unit.

- If the date and time display and function indication are unnecessary, cancel them before dubbing. (→ 41, 80)

If the dubbed images are played back on a wide-screen TV, the images may be stretched vertically.

In this case, refer to the operating instruction of the device you are connecting to or read the operating instructions of the wide-screen TV and set the aspect ratio to 16:9.

With a printer (PictBridge)

To print pictures by directly connecting this unit to the printer, use a printer compatible with PictBridge. (Read the operating instructions for the printer.)

- Use the AC adaptor to free you from worrying about the battery running down.

◇ Insert an SD card with recorded images in this unit and then set the mode dial to  to turn on the power.

1 Connect this unit and a printer.

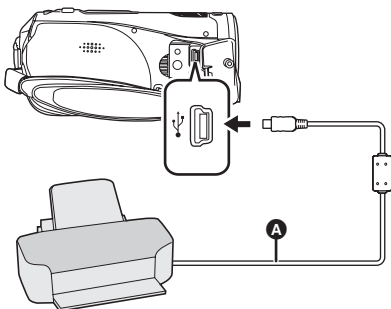

A USB cable (supplied)

- Insert the plugs as far as they will go. The [PictBridge] indication appears on this unit's screen.
- If the [PictBridge] indication does not appear or continues to flash, disconnect and then reconnect the USB cable or check the printer, SD card and settings on this unit.
- Do not use any other USB connection cables except the supplied one. (Operation is not guaranteed with any other USB cables.)

2 Select a file to be printed, then press the cursor button.



The number of pictures set is displayed.

3 Move the cursor button up or down to select the desired number of prints, then press the cursor button.

- You can set up to 9 prints.
- To cancel the setting, set the number of prints to [0].
- Up to 8 files displayed can be set in succession by repeating steps 2 and 3.

4 Press the MENU button to display the PictBridge menus.

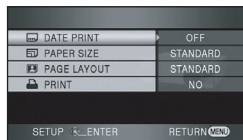

5 Select the date print setting on [DATE PRINT].

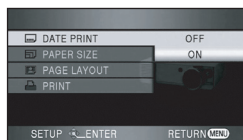

- If the printer is not capable of date printing, this setting is unavailable.

6 Select the paper size setting on [PAPER SIZE].

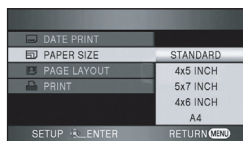

[STANDARD]: Size specific to the printer

[4×5 INCH]: L size

[5×7 INCH]: 2L size

[4×6 INCH]: Postcard size

[A4]: A4 size

- You cannot set paper sizes not supported on the printer.

7 Select the layout setting on [PAGE LAYOUT].

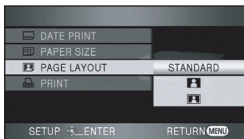

[STANDARD]: Layout specific to the printer

[]: No frame print

[]: Frame print

- You cannot set page layouts not supported on the printer.

8 Select [PRINT] → [YES] and press the cursor button to print the pictures.

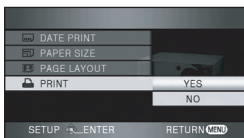

- Exit PictBridge by disconnecting the USB cable (supplied) after the pictures have been printed.

When you stop printing halfway

Move the cursor button down.

A confirmation message appears. If [YES] is selected, the number of prints set is canceled and the screen returns to step 2. If [NO] is selected, all the settings are kept and the screen returns to step 3.

- Avoid the following operations during printing. These operations disable proper printing.
 - Disconnecting the USB cable
 - Removing the SD card
 - Switching the mode dial
 - Turning off the power
- Check the settings for the paper size, print quality etc. on the printer.
- The edges of still pictures recorded on this unit with a 16:9 aspect ratio may be cut at printing. When using a printer with a trimming or borderless printing function, cancel this function before printing. (Refer to the operating instructions of the printer for details.)
- You may not be able to print still pictures recorded with other products.
- When the unit is connected directly to the printer, the DPOF settings cannot be used.
- Connect the printer directly to this unit. Do not use a USB hub.

With a computer

Before using with a computer

What you can do with a computer

Data type	Can do	Software used
Motion picture	[Copy to PC]	HD Writer Ver1.0E for SD1
	[Write data to media]*	
	[Copy between media]*	
	[Easy editing]	
Still picture	Playing back on a computer	Standard Windows picture viewer or a commercially available picture viewer
	Copying files to a computer	Windows Explorer
	Refer to P104 if using a Macintosh.	

*Compatible media are SD card and discs (DVD-RAM, DVD-RW, DVD-R and DVD-R DL).

- When you connect this unit and a computer, always insert the battery and connect the AC adaptor. If you do not insert the battery and connect the AC adaptor, operation will not be possible after connecting this unit to the computer.
- We cannot guarantee operation of this unit if you use software other than that supplied to read/write motion picture data to this unit.

Contents on provided CD-ROM

The following software applications are contained on the provided CD-ROM.

■ HD Writer Ver1.0E for SD1

You can acquire data of motion pictures and still pictures on an SD card to the hard disk of the computer, easily edit (split, merge, delete) the motion pictures, then write the data to an SD card or disc.

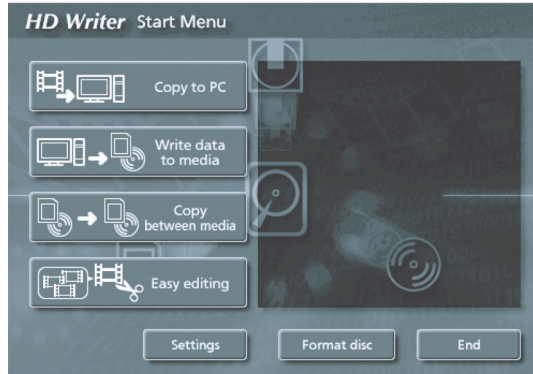

[Copy to PC]:

If there is no more available memory on the SD card, copy the data to the hard disk of the computer. You can then easily edit it (split or delete scenes etc.).

[Write data to media]:

You can copy motion picture data and still picture data from the hard disk of the computer to an SD card. You can also copy motion picture data to a disc.

[Copy between media]:

You can copy motion picture data from an SD card to a disc or from a disc to an SD card.

[Easy editing]:

You can easily edit (split, merge, delete etc.) motion picture data that was copied to the hard disk of the computer.

[Format disc]:

Depending on the type of disc that you use, formatting is necessary. Discs are formatted using the UDF 2.5 file system that supports the AVCHD.

■ DirectX

Microsoft DirectX 9.0c must be installed in order to operate the HD Writer Ver1.0E for SD1.

If DirectX is not already installed on your computer, you can install it from the CD-ROM. Click [DirectX] and follow the on-screen messages to install it. If you install the software on a computer that is not compatible with DirectX 9.0c, the computer may not work properly. If you are unsure whether or not your computer is compatible, contact the maker of your computer.

End User License Agreement

Before opening the CD-ROM package, please read the following.

You ("Licensee") are granted a license for the Software defined in this End User Software Agreement ("Agreement") on condition that you agree to the terms and conditions of this Agreement. If Licensee does not agree to the terms and conditions of this Agreement, promptly return the Software to Matsushita Electric Industrial Co., Ltd. ("Matsushita"), its distributors or dealers from which you made the purchase.

Article 1 License

Licensee is granted the right to use the software, including the information recorded or described on the CD-ROM, instruction manuals, and any other media provided to Licensee (collectively "Software"), but all applicable rights to patents, copyrights, trademarks and trade secrets in the Software are not transferred to Licensee.

Article 2 Use by a Third Party

Licensee may not use, copy, modify, transfer or allow any third party, whether free of charge or not, to use, copy or modify the Software, except as expressly provided for in this Agreement.

Article 3 Restrictions on Copying the Software

Licensee may make a single copy of the Software in whole or in part solely for back-up purposes.

Article 4 Computer

Licensee may only use the Software on a single computer at a single location.

Article 5 Reverse Engineering, Decompiling or Disassembly

Licensee may not reverse engineer, decompile, or disassemble the Software, except to the extent either of them is permitted under law or regulation of the country where Licensee resides. Matsushita, or its distributors or dealers will not be responsible for any defects in the Software or damage to Licensee caused by Licensee's reverse engineering, decompiling, or disassembly of the Software.

Article 6 Limitation of Liability

The Software is provided "AS-IS" without warranty of any kind, either expressed or implied, including, but not limited to, warranties of non-infringement, merchantability and/or fitness for a particular purpose. Further, Matsushita does not warrant that the operation of the Software will be uninterrupted or error free. Matsushita or any of its distributors or dealers will not be liable for any damage suffered by Licensee arising from or in connection with Licensee's use of the Software.

Article 7 Export Control

Licensee agrees not to export or re-export to any country the Software in any form without the appropriate export licenses under regulations of the country where Licensee resides, if necessary.

Article 8 Termination of License

The right granted to Licensee hereunder will be automatically terminated if Licensee violates any of the terms and conditions of this Agreement. Upon such automatic termination, Licensee must destroy the Software and related documentation together with all the copies thereof at Licensee's own expense.

Operating environment

- A CD-ROM drive is necessary to install the supplied software applications. (A compatible drive and media are necessary for writing to a DVD.)
- When 2 or more USB devices are connected to a computer, or when devices are connected through USB hubs or by using extension cables, proper operation is not guaranteed.
- Use the supplied USB cable when connecting to the computer. (Operation is not guaranteed with any other USB cables.)
- Even if the system requirements mentioned in these operating instructions are fulfilled, some computers cannot be used.
- This software is not compatible with Microsoft Windows 3.1, Windows 95, Windows 98/98SE, Windows Me and Windows NT.
- Operation on an upgraded OS is not guaranteed.

Operating environment for HD Writer Ver1.0E for SD1

Personal computer	IBM PC/AT compatible personal computer
OS	Microsoft Windows 2000 Professional Service Pack 4 Microsoft Windows XP Home Edition Service Pack 2 Microsoft Windows XP Professional Service Pack 2
CPU	Intel Pentium III 1.0 GHz or higher (Intel Pentium 4 HyperThread 3.0 GHz or higher when a "Preview function" is used) (including compatible CPU)
RAM	512 MB or more (1024 MB or more recommended)
Display	High Color (16 bit) or more (32 bit or more recommended) Desktop resolution of 1024×768 pixels or more (1280×1024 pixels or more recommended) Graphics card complying with DirectX 9.0c, and DirectDraw Overlay 64 MB video memory or more
Free hard disk space	Ultra DMA — 100 or more 250 MB or more ● When writing to a DVD, more than double the amount of free space as the disc being created is necessary.
Necessary software	DirectX 9.0c ● If you install the software on a computer that is not compatible with DirectX 9.0c, the computer may not work properly. If you are unsure whether or not your computer is compatible, contact the maker of your computer. Adobe Acrobat Reader 5.0 or later
Sound	DirectSound Support
Interface	USB port [Hi-Speed USB (USB 2.0)]
Other requirements	Mouse or equivalent pointing device

- Supplied CD-ROM is available for Windows only.
- Operation on an OS other than the one pre-installed is not guaranteed.
- Operation is not guaranteed on computers that are not PC/AT compatible.
- Input is not supported in languages other than English, French and Spanish.
- Operation cannot be guaranteed on all DVD drives.

- DVD discs authored with this software are not guaranteed to play in all DVD players that do not support the AVCHD.
- Operation is not guaranteed on Microsoft Windows XP Media Center Edition, Tablet PC Edition and not compatible with 64 bit operation systems.
- This software is not compatible with a multi-boot environment.
- This software is not compatible with a multi-CPU environment.
- If your computer does not satisfy the above system requirements, an error may occur when writing data to disc.
- Set the display resolution to 1024×768 (16 bits color) or higher.
Select [start] → ([Settings] →) [Control Panel] → ([Appearance and Themes] →) [Display] and select [Settings] tab, and then adjust [Screen resolution] and [Color quality].

■ Operating environment for the card reader function (mass storage)

Personal computer	IBM PC/AT compatible personal computer
OS	Microsoft Windows 2000 Professional Service Pack 4 Microsoft Windows XP Home Edition Microsoft Windows XP Professional
CPU	Intel Pentium III 450 MHz or higher/Intel Celeron 400 MHz or higher
RAM	128 MB or more (256 MB or more recommended)
Interface	USB port
Other requirements	Mouse or equivalent pointing device

- The USB equipment operates with the driver installed as standard in the OS.

Installation

When installing the software, log on to your computer as the Administrator or with a user name with equivalent authorization. (If you do not have authorization to do this, consult your manager.)

- Before starting the installation, close any other software applications which are running.
- Do not perform any other operations on your computer while the software is being installed.

Installing HD Writer Ver1.0E for SD1

1 Insert the CD-ROM into the computer.



The [Setup Menu] screen will appear.

- If the [Setup Menu] screen does not appear, double-click the CD-ROM drive icon in [My Computer].

2 Click [HD Writer Ver1.0E for SD1].



- The software application may not run properly if you cancel the installation at any point e.g. by pressing [Cancel].
- Microsoft DirectX 9.0c must be installed in order to operate the HD Writer Ver1.0E for SD1. (→ 93)

If you install the software on a computer that is not compatible with DirectX 9.0c, the computer may not work properly. If you are unsure whether or not your computer is compatible, contact the maker of your computer.

3 Click [Next].

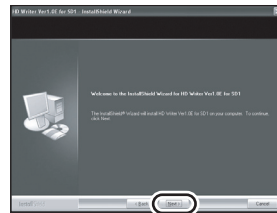

4 Read carefully through the [End User License Agreement], then place a check beside [I accept the terms of the license agreement] if you agree to them and click [Next].

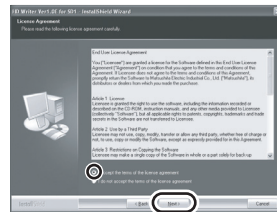

- If you do not agree to the terms and conditions of the License Agreement, installation is not possible.
- Continue to follow the on-screen messages to install it.

5 After the installation is complete, restrictions are displayed.

Check the contents, then click [X] on the top right of the window.

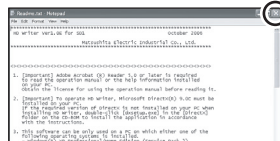

6 Click [Finish].

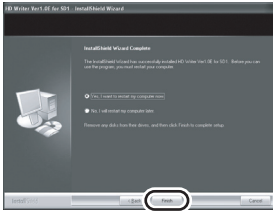

The computer must be rebooted for the application to work.

Reading the operating instructions of the software applications

For details on how to use the software applications, read the PDF operating instructions.

- You will need Adobe Acrobat Reader 5.0 or later to read the PDF operating instructions.

Select [start] → [All Programs (Programs)] → [Panasonic] → [HD Writer Ver1.0E for SD1] → [Manual (PDF Format)].

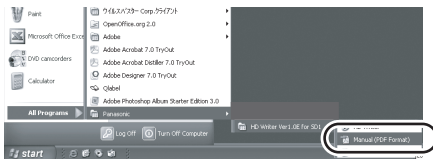

Software application uninstallation

Follow the steps below to uninstall any software applications that you no longer require.

- 1 Select [start] → ([Settings] → [Control Panel] → [Add or Remove Programs (Applications)]).

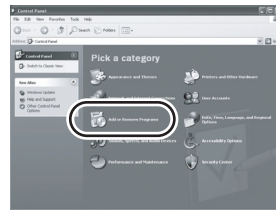

- 2 Select [HD Writer Ver1.0E for SD1], then click [Change/Remove] ([Change or Remove] or [Add/Remove]).

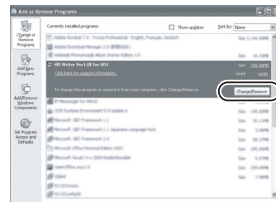

- Proceed with the uninstallation by following the on-screen instructions.
- After uninstalling the software, be sure to reboot the computer.

Connection and recognition

Connection and recognition procedures

After the software applications are installed, this unit must be connected to the computer and be correctly recognized by the computer.

- Connect after installing the software applications.
- Remove the supplied CD-ROM if it is inserted in the computer. (If the [Setup Menu] screen is displayed, wait until it finishes and then remove the CD-ROM.)
- If the recognition procedure is not accomplished properly, operation will not be possible after connecting the unit to the computer.
- If the unit fails to operate normally, it may mean that you have not conducted the installation or recognition procedure properly.

1 Insert the battery and connect the AC adaptor.

- If you do not insert the battery and connect the AC adaptor, operation will not be possible after connecting this unit to the computer.

2 Insert an SD card with recorded images in this unit and then set the mode dial to **PC** to turn on the power.

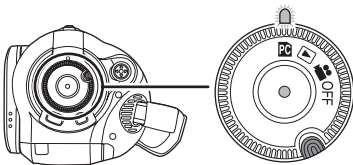

3 Connect this unit and a computer.

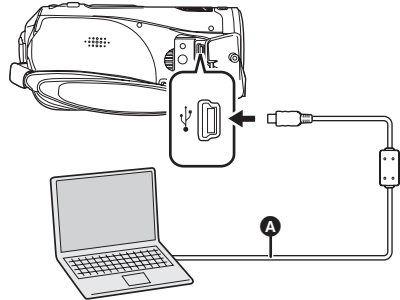

A USB cable (supplied)

This unit is automatically recognized by the computer.

- Insert the plugs as far as they will go. The unit and computer will not operate properly if the plugs are not inserted fully.
 - Do not use any other USB connection cables except the supplied one. (Operation is not guaranteed with any other USB cables.)
-
- **When the unit is connected to a computer, the operation mode cannot be changed and its power cannot be turned off.**
In this case, disconnect the USB cable (→ 101).
 - When a computer is accessing the SD card in this unit, the card access lamp lights. (When a card is being accessed,  appears on the LCD monitor.) Do not disconnect the USB cable or AC adaptor while the card is being accessed as it may damage the data.
 - It may be necessary to reboot the computer after connecting this unit to it for the first time.

About the computer display

When the unit is connected to a computer, it is recognized as an external drive.
[Removable Disk] is displayed in [My Computer].



Example folder structure of an SD card:

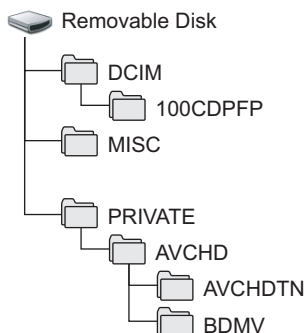

- AVCHD format motion picture files ([00000.MTS] etc.) are saved in the [BDMV] folder.
- The motion picture thumbnails are recorded in the [AVCHDTN] folder.
- JPEG format still pictures ([IMGA0001.JPG] etc.) are stored in the [100CDPFP] folder. These can be opened with picture software that supports JPEG pictures.
- Up to 999 files can be recorded in the [100CDPFP] or other such folder.
- The DPOF setting files are recorded in the [MISC] folder.

We recommend HD Writer Ver1.0E for SD1 for copying motion picture data to and from the SD card.

Using Windows Explorer or other programs on the computer to copy, move or rename files and folders recorded with this unit will result in them being unusable with HD Writer Ver1.0E for SD1.

Copying still pictures recorded on the SD card to a computer

Card reader function (mass storage)

When an SD card with recorded data on it is inserted into the unit and the unit is connected to a computer using a USB cable, the SD card can be used as an external drive so that still pictures on the card can be copied to the computer with Explorer or other programs.

1 Set the mode dial on the unit to and connect the unit to the computer.

[Removable Disk] is displayed in [My Computer].

2 Double click the folder that contains the files on the removable disk ([DCIM] → [100CDPFP]).

3 Drag and drop the files onto the destination folder (on the computer hard disk).

- Do not use the computer to delete the SD card's folders. Otherwise, it may no longer be possible for this unit to read the SD card.
- Always use this unit to format SD cards.
- When data not supported by this unit has been recorded on a computer, it will not be recognized by this unit.

To disconnect USB cable safely

1 Double click the icon in task tray displayed on the computer. Hardware disconnect dialogue appears.

- Depending on your computer's settings, this icon may not be displayed.

2 Select [USB Mass Storage Device] and click [Stop].

3 Verify [MATSHITA HDC-SD1 USB Device] is selected and click [OK]. Click [Close], and you can safely disconnect the cable.

- Do not disconnect the USB cable while the card access lamp is lit ( appears on the LCD monitor) as it may damage the data.

Verifying the unit is correctly recognized by the computer

To verify this unit is correctly recognized by the computer, rotate the mode dial on this unit to select PC connection mode, then connect the unit to the computer with a USB cable and follow the steps below.

- With some computers including those made by NEC, the Device Manager may not be displayed if a mode that places restrictions on the functions has been established. Consult the manufacturer or follow the steps in your computer's operating instructions to establish a mode in which all the functions can be used, then proceed with operation.

1 Select [start] → ([Settings] →) [Control Panel] → ([Performance and Maintenance] →) [System].

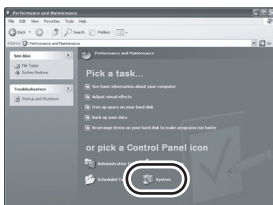

2 Click the [Hardware] tab, then click [Device Manager].

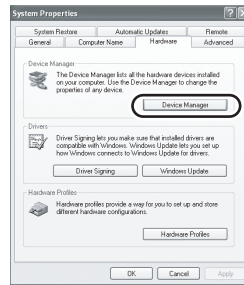

3 Verify the following items are displayed.

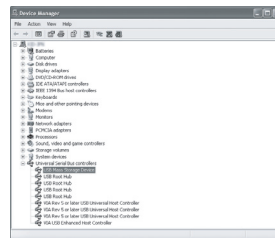

■ If the driver has been recognized properly

[USB Mass Storage Device] is displayed at [Universal Serial Bus controllers].

■ If the driver has not been recognized properly

[!] or [Unknown device] appears at [Universal Serial Bus controllers] or [Other devices] etc. (Where the display will appear depends on the type of computer you are using.)

You can use the following methods to enable it to be recognized.

Method 1: Turn off the unit and your computer once and try verifying again.

Method 2: Remove the SD card and try verifying again.

Method 3: Try connecting the unit to another USB port on your computer.

Using HD Writer Ver1.0E for SD1

Using HD Writer Ver1.0E for SD1, you can copy images recorded on this unit to the hard disk of the computer. When you want to playback images, write back the images from the hard disk of the computer to an SD card. You can then connect this unit to a TV to watch the images.

(→ 80)

- When using HD Writer Ver1.0E for SD1, log on to your computer as Administrator with a login name equally authorized. If you log on with a login name other than Administrator, you cannot use the applications.

■ Copying data on an SD card to the hard disk of the computer

1 Insert the battery and connect the AC adaptor.

- If you do not insert the battery and connect the AC adaptor, operation will not be possible after connecting this unit to the computer.

2 Insert an SD card with recorded images in this unit and then set the mode dial to **PC** to turn on the power.

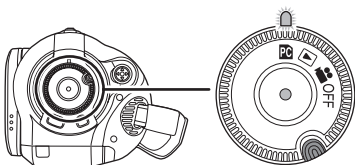

3 Connect this unit and a computer.

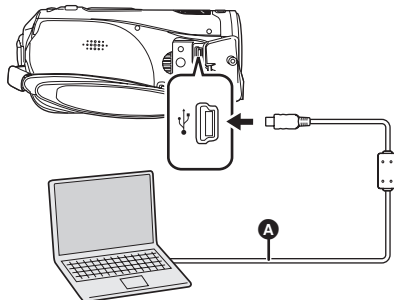

- **A** USB cable (supplied)

- Insert the plugs as far as they will go. The unit and computer will not operate properly if the plugs are not inserted fully.
- Do not use any other USB connection cables except the supplied one. (Operation is not guaranteed with any other USB cables.)

4 (On the computer)

Select **[start]** → **[All Programs (Programs)]** → **[Panasonic]** → **[HD Writer Ver1.0E for SD1]** → **[HD Writer]**.



- The HD Writer Ver1.0E for SD1 introductory screen is displayed. If [OK] is clicked, the software will start.

5 Click the **[Copy to PC]** button.



6 Click the [Start copying] button.



- A confirmation message appears. Click [Yes] and copying starts.
- After copying is complete, a message appears. If [Yes] is clicked, all the motion pictures and still pictures on the SD card will be deleted.

Writing back to an SD card

- Insert an SD card in this unit and format the card. (→ 79)

(Use an SD card that can be used for motion picture recording. (→ 26))

Please be aware that if an SD card is formatted, then all the data recorded on the card will be erased. Store important data on a computer etc.

- Insert the battery and connect the AC adaptor, then rotate the mode dial to select **PC**.
- Connect this unit to the computer and start HD Writer Ver1.0E for SD1.

1 Click the [Write data to media] button.

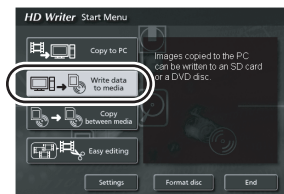

2 Click on the top right and select the folder with the image data you want to copy to the SD card.

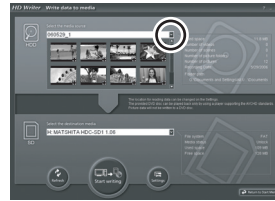

3 Select [Start writing] to copy the images from the hard disk of the computer to the SD card.

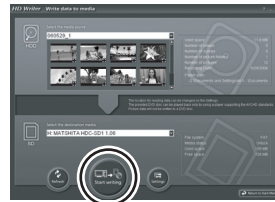

- A confirmation message appears. Click [Yes] and copying starts.

- Refer to the operating instructions of the software (PDF file) for details on how to use it.
- Do not insert a disc created with HD Writer Ver1.0E for SD1 in a device that does not support the AVCHD format. It may no longer be possible to eject it. Also, the disc cannot be played back on devices that do not support the AVCHD format.
- Some discs created with HD Writer Ver1.0E for SD1 cannot be played on other devices, even if they support the AVCHD. In such cases, rewrite the motion pictures to the SD card and play them back on this unit instead.
- The menu screen created with HD Writer Ver1.0E for SD1 does not appear on this unit. Use a device that supports the AVCHD for playback.

If using Macintosh

- Even if the system requirements mentioned in these operating instructions are fulfilled, some personal computers cannot be used.
- Apple, Mac OS is either registered trademarks or trademarks of Apple Computer, Inc. in the United States and/or other countries.
- PowerPC is a trademark of International Business Machines Corporation.
- Intel® Core™ Solo and Intel® Core™ Duo are either registered trademarks or trademarks of Intel Corporation in the United States and/or other countries.

■ Operating environment for the card reader function (mass storage)

Personal computer	Macintosh
OS	Mac OS X v10.3 to v10.4
CPU	PowerPC G3 (400 MHz or higher) PowerPC G4 PowerPC G5 Intel Core Duo Intel Core Solo
RAM	64 MB or more
Interface	USB port

- The USB equipment operates with the driver installed as standard in the OS.
- Supplied CD-ROM is available for Windows only.

■ Copying still pictures on PC

- 1 Connect this unit to the personal computer via the supplied USB cable.**
- 2 Double-click [NO_NAME] or [Untitled] displayed on the desktop.**
 - Files are stored in [100CDPFP] folder etc. in the [DCIM] folder.
- 3 Using a drag-and-drop operation, move the pictures you want to acquire or the folder storing those pictures to any different folder on the personal computer.**

■ To disconnect USB cable safely

Drag [NO_NAME] or [Untitled] disk icon to the [Trash], and then disconnect the USB cable.

Others

Menus and Indications

Menu list

Recording menus

BASIC	
SCENE MODE	OFF
D.ZOOM	30x
O.I.S.	ON
GUIDE LINES	OFF
CLOCK SET	NO
SETUP	ENTER
	EXIT

[BASIC]

- [SCENE MODE] (→ 63)
- [D.ZOOM] (→ 52)
- [O.I.S.] (→ 59)
- [GUIDE LINES] (→ 59)
- [CLOCK SET] (→ 41)

[VIDEO]

- [REC MODE] (→ 47)
- [FADE COLOR] (→ 55)
- [WIND CUT] (→ 60)
- [ZOOM MIC] (→ 53)
- [MIC LEVEL] (→ 60)
- [AGS] (→ 44)

[PICTURE]

- [PICT. QUALITY] (→ 51)
- [FLASH LEVEL] (→ 58)
- [SHTR EFFECT] (→ 50)

[ADVANCED]

- [REC LAMP] (→ 107)
- [ZEBRA] (→ 62)
- [COLOR BAR] (→ 62)
- [MF ASSIST] (→ 64)

[SETUP]

- [FORMAT CARD] (→ 79)
- [DISPLAY] (→ 107)
- [DATE/TIME] (→ 41)
- [DATE FORMAT] (→ 41)
- [POWER SAVE] (→ 107)
- [QUICK START] (→ 33)
- [BEEP SOUND] (→ 107)
- [LCD SET] (→ 42)
- [COMPONENT OUT] (→ 84)
- [HDMI RESOLUTION] (→ 82)
- [EZ Sync] (→ 87)
- [TV ASPECT] (→ 80)
- [INITIAL SET] (→ 107)
- [DEMO MODE] (→ 107)

[LANGUAGE] (→ 42)

**▶ Playback menus
(motion picture playback)**

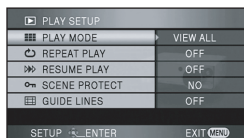

- **[PLAY SETUP]**
- [PLAY MODE] (→ 74)
- [REPEAT PLAY] (→ 71)
- [RESUME PLAY] (→ 72)
- [SCENE PROTECT] (→ 75)
- [GUIDE LINES] (→ 59)

- **[SETUP]**
- [FORMAT CARD] (→ 79)
- [DISPLAY] (→ 107)
- [DATE/TIME] (→ 41)
- [DATE FORMAT] (→ 41)
- [POWER SAVE] (→ 107)
- [BEEP SOUND] (→ 107)
- [LCD SET] (→ 42)
- [COMPONENT OUT] (→ 84)
- [HDMI RESOLUTION] (→ 82)
- [EZ Sync] (→ 87)
- [TV ASPECT] (→ 80)

- **[LANGUAGE] (→ 42)**

**▶ Playback menus
(still picture playback)**

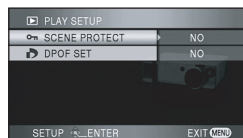

- **[PLAY SETUP]**
- [SCENE PROTECT] (→ 77)
- [DPOF SET] (→ 78)

- **[SETUP]**
- [FORMAT CARD] (→ 79)
- [DISPLAY] (→ 107)
- [DATE/TIME] (→ 41)
- [DATE FORMAT] (→ 41)
- [POWER SAVE] (→ 107)
- [BEEP SOUND] (→ 107)
- [LCD SET] (→ 42)
- [COMPONENT OUT] (→ 84)
- [HDMI RESOLUTION] (→ 82)
- [EZ Sync] (→ 87)
- [TV ASPECT] (→ 80)

- **[LANGUAGE] (→ 42)**

Menus related to [ADVANCED] and [SETUP]

■ [REC LAMP]

- [OFF] ●[ON]

The recording lamp lights during recording and flashes when the unit receives a signal from the remote control or when the self-timer is counting down. When this is set to [OFF], it does not light during recording.

■ [DISPLAY]

- [OFF] ●[ON]

The screen indications are selected as shown in the illustration below.

[OFF]

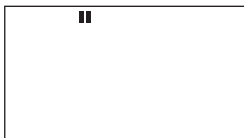

[ON]

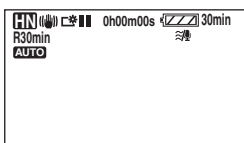

■ [POWER SAVE]

- [OFF] ●[5 MINUTES]

[OFF]:

The power saving function is not activated.

[5 MINUTES]:

When about 5 minutes have passed without any operation, this unit automatically turns off to prevent the battery from running down. When you use this unit, turn it on again.

- In the following cases, the unit may not turn off even when you set this to [5 MINUTES].
 - When using the AC adaptor
 - When connecting the unit to a computer or printer via the USB cable

■ [BEEP SOUND]

- [OFF] ●[ON]

This allows operations such as starting and ending recording to be signaled by a beep. When [OFF] is set, no beep is heard when an operation such as recording is started or ended.

1 Beep

When you start recording

When you turn on the power

When this unit is recognized by the computer or the printer etc.

2 Beeps

When you pause recording

When you turn off the power

2 Beeps/4 times

When an error occurs e.g. recording not starting.

Check the sentence displayed on the screen.

(→ 110)

■ [INITIAL SET]

- [YES] ●[NO]

When there is a menu that cannot be selected due another function or mode being activated, set to [YES] for changing the menu settings back to the initial shipping condition.

(The language setting cannot be changed back to the initial shipping condition.)

■ [DEMO MODE]

- [OFF] ●[ON]

This item is used to start the unit demonstration. (Only when the mode dial is at the  position) If you set [DEMO MODE] to [ON] without inserting an SD card, the demonstration automatically starts. If any operation takes place, the demonstration is canceled. However if no operations take place for approx. 10 minutes, the demonstration automatically starts again. To stop the demonstration, set [DEMO MODE] to [OFF] or insert an SD card. For normal use, set [DEMO MODE] to [OFF].

Indications

Recording indications

Motion picture recording

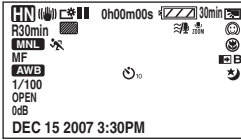

Still picture recording

(when the PHOTO SHOT button is pressed halfway)

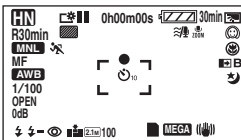

	Remaining battery power
30min	Remaining battery time
R30min	Remaining time for motion picture recording
0h00m00s	Elapsed recording time
DEC 15 2007	Date indication
3:30 PM	Time indication
●/II (Red)	Recording/writing to a card
II (Green)	Recording pause
AUTO	Auto mode
MNL	Manual mode
MF	Manual focus
10×	Zoom magnification indication
	Backlight compensation
	Image stabilizer
	Power LCD
1/100	Shutter speed
OPEN, F2.0	F number
0dB	Gain value
	Soft skin mode
	Tele macro

	Fade (White), Fade (Black)
	MagicPix function
	Zoom microphone
	Wind noise reduction
	Microphone level
	Zebra display
HF, HN, HE	Motion picture recording mode
	Sports mode
	Portrait mode
	Low light mode
	Spotlight mode
	Surf & snow mode
AWB	Auto white balance
	Indoor mode (recording under incandescent lamp)
	Outdoor mode
	Manual adjustment mode
	Flash
	Flash level
	Red eye reduction
○ (White) ● (Green)	Focus indication
	Self-Timer recording
MEGA	MEGA OIS
2.1M	Number of recording pixels for still pictures 1920 × 1080
	Card can be recorded to
	Recognizing the card
	Recording/accessing the card
	Still picture quality
100	Remaining number of still pictures

■ Playback indications

Motion picture playback



Still picture playback



	Playback
	Pause
	Cue/Review playback
	Last/first scene paused
	Skip playback
	Slow motion playback
	Frame-by-frame playback
0h00m00s	Playback time
	Play mode
	All scenes
	Scenes recorded on the selected date
No.10	Scene number
	Volume adjustment
	Repeat playback
	Resume playback
100-0001	Still picture folder/file number display
PictBridge	When a printer compatible with PictBridge is connected
	DPOF already set (to more than 1)
	Protected still pictures

	Number of recording pixels for still pictures 1920×1080
The picture size is not displayed for still pictures recorded with other products that have different picture sizes from the sizes shown above.	

■ PC connection indications

	Accessing the card (When connected to a computer)
--	---

■ Confirmatory indications

	-- (Time display) The built-in battery is low. (→ 41)
	The warning/alarm indication appears when LCD monitor is rotated towards the lens side. Return the direction of the LCD monitor to normal position and check the warning/alarm indication.
	No SD card is inserted/unusable card.

Messages

CANNOT RECORD.	Data writing to the SD card has failed.
NO DATA.	There are no motion pictures or still pictures recorded on the SD card. If this message appears although data is recorded on the SD card, the condition of the card is probably not stable. Turn off the power and then turn it on again.
CANNOT BE USED DUE TO INCOMPATIBLE DATA.	The recording format is different so it cannot be used. Save the data on the SD card to a computer, then use the SD card after formatting it.
CANNOT RECORD - INCOMPATIBLE CONTROL DATA.	
CHECK CARD.	This card is not compatible or it cannot be recognized by the unit.
THIS CARD CANNOT RECORD IN VIDEO MODE.	An 8 MB or 16 MB SD card on which motion pictures cannot be recorded is inserted.
CARD LOCKED.	The write protection switch on the SD Card is set to LOCK. (→ 27)
NOW ACCESSING. PLEASE DO NOT REMOVE CARD.	The data is being processed. Close the card slot cover and wait for a while.
CARD FULL.	The SD card is full so no further data can be recorded. Delete unnecessary scenes/files or insert a new SD card. (→ 34, 74, 76)
CANNOT RECORD. THE NUMBER OF SCENES HAS EXCEEDED THE MAXIMUM LIMIT.	The maximum number of recordable scenes on 1 SD card has been reached so recording is not possible. Delete unnecessary scenes or insert a new SD card. (→ 34, 74, 76)
CANNOT RECORD - DATE CAPACITY IS FULL.	The number of scenes grouped together on a date has reached the maximum number so recording is not possible. Delete unnecessary scenes or insert a new SD card. (→ 34, 74, 76)
CANNOT OPERATE. TEMPERATURE IS HIGH. PLEASE TURN OFF AND WAIT A WHILE.	The internal temperature of this unit is high so it cannot be operated. Turn off the power, wait until the temperature falls and then turn on the power again.
THIS BATTERY CANNOT BE USED.	Use a battery that is compatible with this unit. (→ 30) You are attempting to connect an AC adaptor not compatible with this unit. Use the supplied AC adaptor. (→ 31) If using a Panasonic battery compatible with this unit (→ 30), remove the battery and then insert it again. If the message appears even after repeating this several times, this unit needs repair. Detach the power and consult the dealer who you purchased this unit from. Do not attempt to repair it by yourself.

CANNOT PROTECT.	Scenes on SD cards for which the top menu has been created with HD Writer Ver1.0E for SD1 cannot be protected. (→ 75)
AGS MODE ON-REC PAUSED	The AGS function is activated. (→ 44)
PUSH THE RESET SWITCH.	An irregularity in the unit has been detected. Press the RESET button to restart the unit. (→ 118)
CANNOT SET.	The [GUIDE LINES], [ZEBRA], [MF ASSIST] and [MIC LEVEL] menu settings cannot be set when the color bar is set.
CHANGE MODE TO USE USB.	The USB cable is connected in recording mode.
DISCONNECT USB CABLE.	You are attempting to switch the mode dial from PC Connection mode to another mode with the USB cable connected.
PLEASE CONNECT AC ADAPTOR AND BATTERY.	You are attempting to connect to a computer in PC Connection mode when the AC adaptor is not connected or the battery is not inserted.
RECONNECT USB CABLE.	Disconnect the USB cable, then connect the AC adaptor with the battery inserted in this unit and reconnect the USB cable.
DISCONNECT USB CABLE.	The unit cannot correctly establish the connection to the computer or printer. Disconnect and then reconnect the USB cable.
DISCONNECT USB CABLE.	When the unit is connected to a computer, its power cannot be turned off.

About recovery

When the SD card is accessed, you try to playback a scene or faulty control information is read, one of the messages below may be displayed. (Depending on the error, this may take time.)

**CONTROL DATA ERROR HAS BEEN
DETECTED.**

When connecting to AC adaptor or the remaining capacity of the battery is enough:
[FINISHED.]

When the remaining capacity of the battery is low:
[PLEASE CONNECT AC ADAPTOR OR CHANGE BATTERY.]

**THUMBNAIL DATA ERROR IS
DETECTED.**

When connecting to AC adaptor or the remaining capacity of the battery is enough:
[THUMBNAIL DATA HAS BEEN REPAIRED SUCCESSFULLY.]

When the remaining capacity of the battery is low:
[PLEASE CONNECT AC ADAPTOR OR CHANGE BATTERY.]

-
- Use a sufficiently charged battery or the AC adaptor.
 - Depending on the condition of the data, it may not be possible to completely repair the data.
 - If the recovery fails, you will no longer be able to playback the scenes recorded before the power went off.
 - When data recorded on another device is recovered, it may not be possible to play back the data on this unit or the other device.
 - If the recovery fails, format the SD card on this unit.
 - If the thumbnail information is recovered, displaying the thumbnails may become slower.

Functions that cannot be used simultaneously

Some functions in this unit are disabled or cannot be selected due to the unit's specifications. The table below shows examples of functions restricted by various conditions.

Functions	Conditions which disable the functions
Backlight compensation	<ul style="list-style-type: none"> ●When the MagicPix function is used ●When the iris/gain is set
MagicPix (Set and cancel)	<ul style="list-style-type: none"> ●While recording
Soft skin mode (Set and cancel)	
Tele macro (Set and cancel)	
Help mode	
Shutter effect	<ul style="list-style-type: none"> ●While recording motion pictures
Flash	<ul style="list-style-type: none"> ●While recording motion pictures ●When the MagicPix function is used
Zoom	<ul style="list-style-type: none"> ●When the PHOTO SHOT button is pressed halfway
Zoom microphone	<ul style="list-style-type: none"> ●An external microphone is used
Wind noise reduction	
Scene mode	<ul style="list-style-type: none"> ●When setting the AUTO/MANUAL/FOCUS switch to AUTO ●When the MagicPix function is used
MF assist function	<ul style="list-style-type: none"> ●When digital zoom (12× or higher) is used
Change of white balance	<ul style="list-style-type: none"> ●When digital zoom (12× or higher) is used ●When the MagicPix function is used
Adjusting the shutter speed, iris/gain	<ul style="list-style-type: none"> ●When the MagicPix function is used ●When the scene mode is used

Troubleshooting

Unit operations

Problem	Check points
<p>This unit cannot be turned on.</p>	<ul style="list-style-type: none"> ● Is the battery fully charged? → Charge it with the AC adaptor. (→ 28) ● The battery protection circuit may have operated. Attach the battery to the AC adaptor for 5 to 10 seconds. If the unit still cannot be used, the battery is faulty. ● Is the LCD monitor open?
<p>This unit is turned off automatically.</p>	<ul style="list-style-type: none"> ● If you do not use the unit for approximately 5 minutes, the power is automatically turned off to conserve the battery charge. To resume recording, turn the power back on. The power will not turn off automatically when the power save function (→ 107) is set to [OFF]. ● Are you connecting to a TV compatible with EZ Sync with a HDMI cable? → If you connect to a TV compatible with EZ Sync with a HDMI cable and turn off the power on the TV with the remote control for the TV, the power on this unit also turns off. If you are not using EZ Sync, set [EZ Sync] to [OFF]. (→ 88)
<p>This unit does not stay on long enough.</p>	<ul style="list-style-type: none"> ● Is the battery low? → If the remaining battery power indication is flashing or the message "LOW BATTERY." is displayed, the battery has run down. Charge the battery. (→ 28)
<p>A clicking sound is heard when the unit is shaken.</p>	<ul style="list-style-type: none"> ● This is the sound of the lens moving and is not a defect. This sound will no longer be heard when the unit's power is turned on.
<p>Battery runs down quickly.</p>	<ul style="list-style-type: none"> ● Is the battery fully charged? → Charge it with the AC adaptor. (→ 28) ● Are you using the battery in an extremely cold place? → The battery is affected by ambient temperature. In cold places, the operating time of the battery becomes shorter. ● Has the battery worn out? → The battery has a limited life. If the operating time is still too short even after the battery is fully charged, the battery has worn out and can no longer be used.
<p>The minute display of the remaining battery power indication is not displayed correctly.</p>	<ul style="list-style-type: none"> ● The remaining battery capacity indication is an approximation. If you think the remaining battery capacity indication is not displayed correctly, fully charge the battery, discharge it and then charge it again. (Even if this operation is performed, it may not be possible to display the remaining battery capacity correctly if the battery was used for a long period of time where the temperature was low or high or if the battery was repeatedly charged.)

Problem	Check points
<p>This unit cannot be operated though powered up.</p> <p>This unit does not operate normally.</p>	<ul style="list-style-type: none"> ● The unit cannot be operated if the LCD monitor is not opened. ● Press the RESET button. (→ 118) If normal conditions are not restored yet, remove the battery or AC adaptor, wait about 1 minute and then reconnect the battery or AC adaptor. Then about 1 minute later, turn on the power again. (Conducting the above operation while the card is being accessed may damage the data on the SD card.)
<p>The remote control does not function.</p>	<ul style="list-style-type: none"> ● Has the button-type battery of the remote control run out? → Replace it with a new button-type battery. (→ 25)
<p>The screen has changed suddenly.</p>	<ul style="list-style-type: none"> ● Has the demonstration started? → If you set [DEMO MODE] to [ON] without inserting an SD card in recording mode, the demonstration automatically starts. Normally this should be set to [OFF]. Press the MENU button, then select [SETUP] → [DEMO MODE] → [OFF] and press the cursor button.
<p>A function indication such as the remaining time indication or the elapsed time indication is not shown.</p>	<ul style="list-style-type: none"> ● If you set [SETUP] → [DISPLAY] → [OFF], indications other than warnings and date indications disappear.
<p>Recording does not start although power is supplied to this unit and the SD card is correctly inserted.</p>	<ul style="list-style-type: none"> ● Has the SD card's write protect switch been set to LOCK? → No recording is possible while the write protect switch is set to LOCK. (→ 27) ● Is the memory of the SD card full? → If there is no more available memory, free up some memory by deleting unnecessary scenes or use a new SD card. (→ 34, 74, 76) ● Is the unit set to recording mode? → No recording is possible if the mode dial is set to other than . ● Is the card slot cover open? → If the card slot cover is open, this unit may not operate normally. Close the card slot cover.
<p>The unit arbitrarily stops recording.</p>	<ul style="list-style-type: none"> ● Can the SD card be used for motion picture recording? → Use an SD card that can be used for motion picture recording. (→ 26) ● Is the AGS function activated? → Record in the normal horizontal position or set [AGS] to [OFF]. (→ 44)

Problem	Check points
Auto focus function does not work.	<ul style="list-style-type: none"> ● Is manual focus mode selected? → Set the AUTO/MANUAL/FOCUS switch to AUTO. ● Are you trying to record a scene which is hard to bring into focus in auto focus mode? → There are some recording subjects and surroundings for which the auto focus does not operate correctly. (→ 124) If so, use the manual focus mode to adjust the focus. (→ 64)
Recorded still pictures are not clear.	<ul style="list-style-type: none"> ● Are you trying to record small or finely detailed objects with [PICT. QUALITY] set at []? → If you try to record small or finely detailed objects with [PICT. QUALITY] set at [], the images may break up into a mosaic-like pattern. Record with [PICT. QUALITY] set at [] instead. (→ 51)
Sound is not played back from the built-in speaker of this unit.	<ul style="list-style-type: none"> ● Is the volume too low? → During playback, move the volume lever to display the volume indication and adjust it. (→ 70)
Sound is played back from one side of speakers when motion pictures recorded on this unit are played back on another device.	<ul style="list-style-type: none"> ● The internal microphones of this unit record sound with Dolby Digital 5.1 Creator. When the sound is played back on another device, if stereo 2 channel speakers on TV are used, the sound may be played back from one side of the speakers. When the TV has surround sound effect function, we recommend using it. Refer to the operating instructions of the TV for how to operate the surround sound effect.
<p data-bbox="101 882 365 984">Although this unit is correctly connected to a TV, images cannot be seen.</p> <p data-bbox="101 1016 365 1067">The images are squeezed horizontally.</p>	<ul style="list-style-type: none"> ● Does the input switch on the TV match the connected terminal? → Please read the operating instructions of your TV and select the channel that matches the input used for the connection. ● Is the [TV ASPECT] setting correct? → Change the setting to match the aspect ratio of the TV. Press the MENU button, then select [SETUP] → [TV ASPECT] → [16:9] or [4:3] and press the cursor button. ● Are the HDMI and component cables connected to the unit while in recording or PC connection mode? → If both HDMI and component cables are to be connected, set the unit to playback mode.

Problem	Check points
Scenes cannot be deleted.	<ul style="list-style-type: none"> ● Is the scene on the SD card protected? → Protected scenes cannot be deleted. Release the protect setting. (→ 75) ● Scene which cannot be displayed as thumbnails (the thumbnails are displayed as ) cannot be deleted. If the scenes are unnecessary, format the card to erase the data. (→ 79) Please be aware that if a card is formatted then all the data recorded on the card will be erased. ● Is the file on the SD card protected? → Protected files cannot be deleted. Release the protect setting. (→ 77) ● If the SD card's write protect switch is set to LOCK, then deletion is disabled. (→ 27)
The images on the SD card do not look normal.	<ul style="list-style-type: none"> ● The data may be destroyed. It may have been destroyed by static or electromagnetic waves. Store important data on a computer or other products as well.
Even if an SD card is formatted, it cannot be used.	<ul style="list-style-type: none"> ● Either this unit or the SD card may be damaged. Please consult a dealer. Use an SD card from 8 MB to 4 GB with this unit.
If the SD card is inserted in this unit, it is not recognized.	<ul style="list-style-type: none"> ● Is the SD card formatted on a computer inserted? → Use this unit to format SD cards. Please be aware that if an SD card is formatted, then all the data recorded on the card will be erased. (→ 79)
If the SD card is inserted in another device, it is not recognized.	<ul style="list-style-type: none"> ● Check that the device is compatible with the capacity or type of SD card (SD Memory Card/SDHC Memory Card) that you inserted. (→ 26) → Refer to the operating instructions of the device for details.
The indication disappears. The screen is frozen. No operation can be performed.	<ul style="list-style-type: none"> ● Is this unit connected to a computer? → No operation can be performed on this unit when it is connected to a computer. ● Turn off the power to this unit. If the power cannot be turned off, press the RESET button, or remove the battery or AC adaptor and then reattach it. After that, turn on the power again. If normal operation is still not restored, detach the power connected, and consult the dealer who you purchased this unit from.

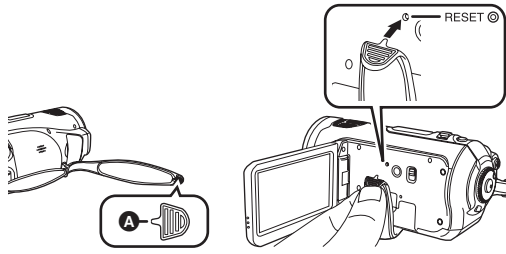
Problem	Check points
“PUSH THE RESET SWITCH.” is displayed.	<ul style="list-style-type: none">● The unit has automatically detected an error. Press the RESET button with the projecting part of the grip belt A. This will restart the unit.  <ul style="list-style-type: none">● If you do not press the RESET button, the power to this unit is turned off automatically about 1 minute later.● Even after you press the RESET button, the indication may still appear repeatedly. If so, this unit needs repair. Detach the power connected, and consult the dealer who you purchased this unit from. Do not attempt to repair the unit by yourself.

When connected to another device

Problem	Check points
EZ Sync does not work.	<ul style="list-style-type: none"> ● Are you connecting with the component cable or the AV cable? → Connect with a HDMI cable (optional). (→ 87) ● Is the [EZ Sync] setting appropriate? → Press the MENU button, then select [SETUP] → [EZ Sync] → [ON] with the cursor button. ● Depending on HDMI terminal of the TV, the input channel may not switch automatically. In this case, use the remote control for the TV to switch input. (For details on how to switch input, please read the operating instructions for the TV.) ● Check the EZ Sync setting on the connected device. ● Turn the power to the unit off and then back on again. ● Set [Ctrl with HDMI] to [Off] on the TV and then turn it back to [On]. (Refer to the operating instructions of the TV for details.)
With the EZ Sync on, the power to the unit does not turn off even if the TV is turned off.	<ul style="list-style-type: none"> ● Is the mode dial on the unit set to PC connection mode? → EZ Sync does not work with the unit in PC connection mode.

With a computer

Problem	Check points
Even if connected by the USB cable, this unit is not recognized by the computer.	<ul style="list-style-type: none"> ● Have you set this unit to the correct mode? → This unit is not recognized in recording/playback mode. Set it to PC connection mode. ● Is the battery inserted and the AC adaptor connected? → Insert the battery and connect the AC adapter when connecting this unit on the computer. ● Select another USB terminal on the computer. ● Check the operating environment. (→ 95) ● Turn the power to the unit off and then back on again and reconnect the USB cable.
When the USB cable is disconnected, an error message will appear on the computer.	<ul style="list-style-type: none"> ● To disconnect the USB cable safely, double-click the  icon in the task tray and follow the instructions on the screen.
Cannot playback a disc written to with HD Writer Ver1.0E for SD1.	<ul style="list-style-type: none"> ● There is no playback function on HD Writer Ver1.0E for SD1. To playback the disc, use commercially available playback software that supports the AVCHD.
Cannot see the PDF operating instructions for HD Writer Ver1.0E for SD1.	<ul style="list-style-type: none"> ● Is Adobe Acrobat Reader 5.0 or later installed in the computer you are using? → You will need Adobe Acrobat Reader 5.0 or later to read the PDF operating instructions for HD Writer Ver1.0E for SD1.

Cautions for use

About this unit

The unit and the SD card become warm during use. This is not a malfunction.

Keep the High Definition Video Camera as far away as possible from electromagnetic equipment (such as microwave ovens, TVs, video games etc.).

- If you use the High Definition Video Camera on top of or near a TV, the pictures and sound on the High Definition Video Camera may be disrupted by electromagnetic wave radiation.
- Do not use the High Definition Video Camera near cell phones because doing so may result in noise adversely affecting the pictures and sound.
- Recorded data may be damaged, or pictures may be distorted, by strong magnetic fields created by speakers or large motors.
- Electromagnetic wave radiation generated by microprocessors may adversely affect the High Definition Video Camera, disturbing the pictures and sound.
- If the High Definition Video Camera is adversely affected by electromagnetic equipment and stops functioning properly, turn the High Definition Video Camera off and remove the battery or disconnect AC adaptor. Then reinsert the battery or reconnect the AC adaptor and turn the High Definition Video Camera on.

Do not use the High Definition Video Camera near radio transmitters or high-voltage lines.

- If you record near radio transmitters or high-voltage lines, the recorded pictures and sound may be adversely affected.

Make sure to use the supplied cords and cables. If you use optional accessories, use the cords and the cables supplied with them. Do not extend the cords and the cables.

Do not spray insecticides or volatile chemicals onto the unit.

- If the unit is sprayed with such chemicals, its body may be marred and the surface finish may peel off.
- Do not leave rubber or plastic products in contact with the unit for a long time.

When you use the unit in a sandy or dusty place such as a beach, do not let sand or fine dust get into the body and terminals of the unit.

Also, keep the unit away from sea water.

- Sand or dust may damage the unit. (Care should be taken when inserting and removing a card.)
- If sea water splashes onto the unit, wipe off the water with a well wrung cloth. Then wipe the unit again with a dry cloth.

When carrying the unit, do not drop or bump it.

- A strong impact can break the unit's casing, causing it to malfunction.

Do not use benzene, paint thinner or alcohol for cleaning the unit.

- Before cleaning, detach the battery or pull out the AC cable from the AC outlet.
- The camera body may be discolored and the surface finish may peel off.
- Wipe the unit with a soft dry cloth to remove dust and fingerprints. To remove stubborn stains, thoroughly wring a cloth that has been soaked in a neutral detergent diluted with water and wipe the unit with it. Afterwards, wipe it with a dry cloth.
- When you use a chemical dust cloth, follow the instructions that came with the cloth.

Do not use the unit for surveillance purposes or other business uses.

- If you use the unit for a long time, heat will build up inside it and this may cause a malfunction.
- This unit is not intended for business use.

When you are not going to use the unit for an extended time

- When storing the unit in a cupboard or cabinet, it is recommended that you place a desiccant (silica gel) in with it.

About the battery

The battery used in this unit is a rechargeable lithium-ion battery. It is susceptible to humidity and temperature and the effect increases the more the temperature rises or falls. In cold areas, the full charge indication may not appear or the low battery indication may appear about 5 minutes after starting use. At high temperatures, the protection function may be triggered, making it impossible to use the unit.

Be sure to detach the battery after use.

- If the battery is left attached, a minute amount of current continues to flow even if the unit's power is off. Keeping the unit in this state may result in over discharge of the battery. This may result in you not being able to use the battery even after it is charged.
- The battery should be stored in the vinyl bag so metal does not come into contact with the terminals.
- The battery should be stored in a cool place free from humidity, with as constant temperature as possible. (Recommended temperature: 15 °C to 25 °C (59 °F to 77 °F), Recommended humidity: 40% to 60%)
- Extremely high temperatures or low temperatures will shorten the life of the battery.
- If the battery is kept in high-temperature, high-humidity, or oily-smoky places, the terminals may rust and cause malfunctions.
- To store the battery for a long period of time, we recommend you charge it once every year and store it again after you have completely used up the charged capacity.
- Dust and other matter attached to the battery terminals should be removed.

Prepare spare batteries when going out for recording.

- Prepare batteries enough to last for 3 to 4 times the period during you want to record pictures in. In cold places such as a ski resort, the period during which you can record pictures is shortened.
- When you travel, do not forget to bring an AC adaptor so that you can recharge the batteries at your destination.

If you drop the battery accidentally, check to see if the terminals are damaged.

- Attaching a battery with damaged terminals can damage the unit or AC adaptor.

Do not throw old battery into fire.

- Heating a battery or throwing it into a fire may result in an explosion.

If the operating time is very short even after the battery has been recharged, the battery has worn out. Please purchase a new battery.

About the AC adaptor



- If the temperature of the battery is extremely high or extremely low, charging may take time or the battery may not be charged.
- If the charging lamp keeps flashing, make sure that the terminals of the battery or the AC adaptor are not exposed to dirt, foreign objects or dust, then reconnect them properly. Disconnect the AC cable from the AC outlet when you remove dirt, foreign objects or dust on the terminals of the battery or the AC adaptor. If the charging lamp is still flashing, something may be wrong with the battery or AC adaptor. Contact your dealer.
- If you use the AC adaptor near a radio, radio reception may be disturbed. Keep the AC adaptor 1 m (3.3 feet) or more away from the radio.
- When using the AC adaptor, it may generate whirring sounds. However, this is normal.
- After use, be sure to disconnect the AC adaptor. (If it is left connected, a minute amount of current is consumed.)
- Always keep the electrodes of the AC adaptor and battery clean.

Put this unit near the outlet to make it easy for the interrupting device (plug) to reach it.

About the SD card

- The memory capacity indicated on the label of an SD card is the total of the capacity for copyright protection and management and the capacity which can be used on the unit, a computer etc.
- During prolonged use, the unit's surfaces and the SD card will heat up slightly. This is normal.

Always set the mode dial to OFF when inserting or removing an SD card.

While this unit accesses the SD card (while  or  is being displayed/the access lamp is lit), do not remove the SD card, operate the mode dial, turn off the power or shake or impact the unit.

About the miniSD Card

- Be sure to insert miniSD Cards in the dedicated card adaptor before use. Inserting a card in this unit without the adaptor may damage the unit or the card.
- Do not insert an empty card adaptor in this unit. Do not leave the adaptor in this unit while inserting or removing miniSD Cards. This may cause the unit to malfunction.

LCD monitor

- When the LCD monitor gets dirty, wipe it with a dry soft cloth.
- In a place with drastic temperature changes, condensation may form on the LCD monitor. Wipe it with soft dry cloth.
- When the unit has become very cold, for example due to storage in a cold area, its LCD monitor will be slightly darker than usual immediately after the power is turned on. The normal brightness will be restored when the unit's internal temperature rises.

Extremely high precision technology is employed to produce the LCD Monitor screen featuring a total of approximately 251,000 pixels. The result is more than 99.99% effective pixels with a mere 0.01% of the pixels inactive or always lit. However, this is not a malfunction and does not affect the recorded picture.

About condensation

When condensation forms on the unit, the lens will cloud up and the unit may not work properly. Make every effort to ensure that condensation does not form. If it does form, take the actions described below.

Causes of condensation

Condensation takes place when the ambient temperature or humidity is changed as follows.

- When this unit is brought inside from the cold (e.g. a ski slope) to a warm room.
- When this unit is moved from an air-conditioned car to outside.
- When a cold room has been warmed up quickly.
- When cool wind from an air conditioner is directly blown onto this unit.
- After summer afternoon showers of rain.
- When this unit is in a very humid place where the air is thick with steam. (e.g. a heated swimming pool)

When this unit is taken to a location with a significant temperature difference such as from a cold place to a hot place.

If, for example, you have used this unit for recording on a ski slope and are taking it into a heated room, place the unit inside a plastic bag, remove as much of the air from inside the bag as possible, then seal the bag. Leave the unit for about an hour in the room so the temperature of the unit is close to the ambient temperature of the room, then use it.

What to do with the lens is fogged up.

Remove the battery or AC adaptor and leave the unit for about 1 hour. When the unit becomes close to the ambient temperature, the fog disappears naturally.

Explanation of terms

Automatic white balance

White balance adjustment recognizes the color of light and adjusts so the white color will become a purer white. The unit determines the hue of light that comes through the lens and white balance sensor, thereby judging the recording condition, and selects the closest hue setting.

This is called automatic white balance adjustment.

However, since the unit only stores white color information under several light sources, automatic white balance adjustment does not function normally under other light sources.

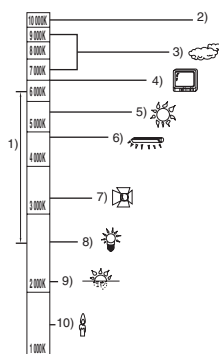

The illustration above shows the range over which the auto white balance functions.

- 1) The effective range of automatic white balance adjustment on this unit
- 2) Blue sky
- 3) Cloudy sky (rain)
- 4) TV screen
- 5) Sunlight
- 6) White fluorescent lamp
- 7) Halogen light bulb
- 8) Incandescent light bulb
- 9) Sunrise or sunset
- 10) Candlelight

Outside of the effective range of automatic white balance adjustment, the image will become reddish or bluish. Even within the effective range of automatic white balance adjustment, the automatic white balance adjustment may not function properly if there is more than one light source. For light outside the functional automatic white balance adjustment range, use the manual white balance adjustment mode.

White balance

The images recorded by the unit may become bluish or reddish under the influence of certain light sources. To avoid such phenomena, adjust the white balance.

White balance adjustment determines the white color under different light sources. By recognizing which is the white color under sunlight and which is the white color under a fluorescent light, the unit can adjust the balance among the other colors.

Since the white color is the reference for all the colors (that make up light), the unit can record pictures in a natural hue if it can recognize the reference color white.

Auto focus

The lens is moved forward or backward automatically to bring the subject into focus.

Auto focus has the following characteristics.

- Adjusts so that the vertical lines of a subject are seen more clearly.
- Attempts to bring an object with higher contrast into focus.
- Focuses on the screen center only.

Due to these characteristics, auto focus does not work correctly in the following situations. Record pictures in the manual focus mode.

Recording distant and close-up objects at the same time

Since the unit focuses on whatever is at the center of the screen, it is difficult to bring the background into focus when close-up objects are placed in focus. When recording people with distant mountains in the background, you cannot focus on both the subject which is close-up and the objects which are in the distance.

Recording a subject behind dirty or dusty window

The subject behind the window will not be focused because the focus is on the dirty window.

Similarly, when recording something on the opposite side of a road with heavy traffic, a vehicle that happens to pass by may be brought into focus.

Recording a subject that is surrounded by objects with glossy surfaces or by highly reflective objects

Since whatever is shiny or glistens is brought into focus, it is hard to focus on the subject to be recorded. The focus may become blurry when recording subjects at the beach, in night views or in scenes involving fireworks or special lights.

Recording a subject in dark surroundings

The unit cannot focus correctly because the light information that comes through the lens decreases considerably.

Recording a fast-moving subject

As the focus lens-inside moves mechanically, it cannot keep up with a fast-moving subject. When, for example, recording a sports event with fast moving subjects, the focus may lose its sharpness.

Recording a subject with little contrast

It is easy to bring subjects with a sharp contrast or vertical lines or stripes into focus. This means that a subject with little contrast, such as a white wall, may become blurry because the unit achieves focus based upon the vertical lines of an image.

Specifications

High Definition Video Camera



Information for your safety

Power source:	DC 9.3 V (When using AC adaptor) DC 7.2 V (When using battery)
Power consumption:	Recording: 8.0 W

Signal system	1080/60i
Recording format	AVCHD format compliant
Image sensor	1/4" 3CCD image sensor Total: 560 K×3 Effective pixels: Motion picture: 520 K×3 Still picture: 520 K×3
Lens	Auto Iris, F1.8 to F2.8 Focal length: 4.0 mm to 48.0 mm Macro (Full range AF)
Filter diameter	43 mm
Zoom	12× optical zoom, 30×/700× digital zoom
Monitor	3" wide LCD monitor (approx. 251 K pixels)
Microphone	5.1 channel surround microphone (with a zoom function)
Speaker	1 round speaker Ø 20 mm
White balance adjustment	Auto tracking white balance system
Standard illumination	1,400 lx
Minimum required illumination	Approx. 6 lx (1/60 in Low light mode) Approx. 2 lx with the MagicPix function
Video output level	1.0 Vp-p, 75 Ω

Component terminal output level	Y: 1.0 Vp-p, 75 Ω Pb: 0.7 Vp-p, 75 Ω Pr: 0.7 Vp-p, 75 Ω
HDMI terminal output level	HDMI Ver. 1.2a [1125i (1080i)/525p (480p)]
Audio output level (Line)	316 mV, 600 Ω
Mic input	Mic sensitivity –50 dB (0 dB=1 V/Pa, 1 kHz) (∅ 3.5 mm stereo mini jack)
USB	Card reader/writer function (No copyright protection support) Hi-Speed USB (USB 2.0), USB terminal Type mini B PictBridge-compliant
Flash	Available range: Approx. 1.0 m to 2.5 m (3.3 feet to 8.2 feet)
Dimensions	74.1 mm (W)×64.9 mm (H)×137 mm (D) [2.9 " (W)×2.6 " (H)×5.4 " (D)] (excluding projecting parts)
Mass	Approx. 430 g (Approx. 0.95 lbs.) (without supplied battery and an SD card)
Mass in operation	Approx. 490 g (Approx. 1.08 lbs.) (with supplied battery and an SD card)
Operating temperature	0 °C to 40 °C (32 °F to 104 °F) (0 °C to 30 °C (32 °F to 86 °F) when connected to the computer)
Operating humidity	10% to 80%
Battery operation time	See page 30

Motion pictures

Recording media	SD Memory Card: 256 MB, 512 MB, 1 GB, 2 GB (FAT12 and FAT16 system compliant) SDHC Memory Card: 4 GB (FAT32 system compliant)
Compression	MPEG-4 AVC/H.264
Recording mode and transfer rate	 : Approx. 13 Mbps (CBR)  : Approx. 9 Mbps (VBR)  : Approx. 6 Mbps (VBR)
Audio compression	Dolby Digital (Dolby AC3), 5.1 ch

Still pictures

Recording media	SD Memory Card: 8 MB, 16 MB, 32 MB, 64 MB, 128 MB, 256 MB, 512 MB, 1 GB, 2 GB (FAT12 and FAT16 system corresponding) SDHC Memory Card: 4 GB (FAT32 system corresponding)
Compression	JPEG (Design rule for Camera File system, based on Exif 2.2 standard), DPOF corresponding
Picture size	1920×1080

AC adaptor

Information for your safety

Power source:	AC 110 V to 240 V, 50/60 Hz
Power consumption:	19 W
DC output:	DC 9.3 V, 1.2 A (Unit operation) DC 8.4 V, 0.75 A (Battery charging)

Dimensions	92 mm (W)×33 mm (H)×61 mm (D) [3.6 " (W)×1.3 " (H)×2.4 " (D)]
Mass	Approx. 115 g (Approx. 0.25 lbs.)



Battery pack

Information for your safety

Maximum voltage:	DC 8.4 V
Nominal voltage:	DC 7.2 V
Rated capacitance:	1320 mAh

Specifications may change without prior notice.

Optional accessories

Accessory No.	Figure	Description
VW-AD21PP-K		AC adaptor with AC Cable and DC Cables
VW-VBG130*		1320 mAh/Rechargeable Lithium Ion Battery Pack
RP-SDR01GU1A RP-SDR512U1A		Class 2 1 GB SD Memory Card Class 2 512 MB SD Memory Card
RP-SDM04GU1K RP-SDM02GU1A		Class 4 4 GB SDHC Memory Card Class 4 2 GB SD Memory Card
RP-SDV04GU1K RP-SDV02GU1A RP-SDV01GU1A		Class 6 4 GB SDHC Memory Card Class 6 2 GB SD Memory Card Class 6 1 GB SD Memory Card

*Please refer to page 30, concerning the battery charging time and available recording time.

NOTE: Accessories and/or model numbers may vary by country. Please consult your local dealer.

Accessory Order Form (For USA Customers)

Please photocopy this form when placing an order.

1. Model # _____

2. Items Ordered

Accessory #	Description	Price Each	Quantity	Total Price
Subtotal				
Your State & Local Sales Tax				
Shipping & Handling				6.95
Total Enclosed				

3. Method of payment (check one)

- Check of Money Order enclosed (NO C.O.D.SHIPMENTS)
- VISA Credit Card # _____
- MasterCard Expiration Date _____
- Discover Customer Signature _____

Make Check or Money Order Payable to: PANASONIC ACCESSORIES

(Please do not send cash)

4. Shipping information (UPS delivery requires complete street address)

Ship To:

Mr.

Mrs.

Ms.

First

Last

Phone#:

Day () _____

Street Address

Night () _____

City

State

Zip

TO OBTAIN ANY OF OUR ACCESSORIES YOU CAN DO ANY OF
THE FOLLOWING:
VISIT YOUR LOCAL PANASONIC DEALER
OR
CALL PANASONIC'S ACCESSORY ORDER LINE AT 1-800-332-5368
[6 AM-6 PM M-F, PACIFIC TIME]
OR
MAIL THIS ORDER TO: PANASONIC SERVICE AND TECHNOLOGY COMPANY ACCESSORY ORDER OFFICE
20421 84th Avenue South Kent, WA. 98032

In CANADA, please contact your local Panasonic dealer for more information on Accessories.

Request for Service Notice (USA Only)

Please photocopy this form when making a request for service notice, in the unlikely event this product needs service.

Request for Service Notice:

- Please include your **proof of purchase**.
(Failure to do so will delay your repair.)
 - To further speed your repair, please provide an explanation of what is wrong with the unit and any symptom it is exhibiting.
-
-
-
-

Mail this completed form and your Proof of Purchase along with your unit to:
Panasonic Camera and Digital Service Center
1590 Touhy Ave.
Elk Grove Village, IL 60007

Limited Warranty (For USA Customers)

PANASONIC CONSUMER ELECTRONICS
 COMPANY, DIVISION OF PANASONIC
 CORPORATION OF NORTH AMERICA
 One Panasonic Way, Secaucus, New Jersey 07094

PANASONIC PUERTO RICO, INC.
 Ave. 65 de Infantería, Km. 9.5 San Gabriel Industrial Park,
 Carolina, Puerto Rico 00985

Panasonic Video Products Limited Warranty

Limited Warranty Coverage

If your product does not work properly because of a defect in materials or workmanship, Panasonic Consumer Electronics Company or Panasonic Puerto Rico, Inc. (collectively referred to as "the warrantor") will, for the length of the period indicated on the chart below, which starts with the date of original purchase ("warranty period"), at its option either (a) repair your product with new or refurbished parts, or (b) replace it with a new or a refurbished product. The decision to repair or replace will be made by the warrantor.

Product	Parts	Labor	Service	Contact Number
Camcorder	One (1) Year (except CCD Image Sensor) CCD Image Sensor - 6 (Six) Months	Ninety (90) Days Ninety (90) Days	Carry-In or Mail-In	1-800-211-PANA(7262)
DVD/VCR Deck, AV Mixer	One (1) Year	Ninety (90) Days	Carry-In or Mail-In	1-800-211-PANA(7262)
TV/VCR, TV/DVD, TV/DVD/VCR Combination	One (1) Year (except CRT) CRT - Two (2) Years	Ninety (90) Days Ninety (90) Days	Carry-In: 21" CRT and Smaller In-Home or Carry-In: 22" CRT and Larger	1-800-211-PANA(7262)
TV/HDR Combination	One (1) Year (except CRT) CRT - Two (2) Years	Ninety (90) Days Ninety (90) Days	In-Home or Carry-In	1-888-843-9788
Rechargeable Batteries (in exchange for defective item)	Ten (10) Days	Not Applicable	Carry-In or Mail-In	1-800-211-PANA(7262)
Tape (in exchange for defective item)	Five (5) Days	Not Applicable	Carry-In or Mail-In	1-800-211-PANA(7262)
Memory Cards (in exchange for defective item)	Ninety (90) Days	Not Applicable	Carry-In or Mail-In	1-800-211-PANA(7262)

During the "Labor" warranty period there will be no charge for labor. During the "Parts" warranty period, there will be no charge for parts. You must carry-in or mail-in (prepaid) your product or arrange for in-home service, as applicable, during the warranty period. If non-rechargeable batteries are included, they are not warranted. This warranty only applies to products purchased and serviced in the United States or Puerto Rico. This warranty is extended only to the original purchaser of a new product which was not sold "as is". A purchase receipt or other proof of the original purchase date is required for warranty service.

Carry-In, Mail-in (Prepaid) or In-Home Service

For Carry-In, Mail-In (prepaid) or In-Home Service (as applicable) in the United States call toll free contact number listed above or visit Panasonic Web Site: <http://www.panasonic.com>

For assistance in Puerto Rico call Panasonic Puerto Rico, Inc. (787)-750-4300 or fax (787)-768-2910.

In-Home service, if applicable, requires clear, complete and easy access to the product by the authorized servicer and does not include removal or re-installation of an installed product. It is possible that certain in-home repairs will not be completed in-home, but will require that the product, or parts of the product, be removed for shop diagnosis and/or repair and then returned.

Limited Warranty Limits And Exclusions

This warranty ONLY COVERS failures due to defects in materials or workmanship, and DOES NOT COVER normal wear and tear or cosmetic damage, nor does it cover markings or retained images on the picture tube resulting from viewing fixed images (including, among other things, letterbox pictures on standard 4:3 screen TV's, or non-expanded standard 4:3 pictures on wide screen TV's, or onscreen data in a stationary and fixed location). The warranty ALSO DOES NOT COVER damages which occurred in shipment, or failures which are caused by products not supplied by the warrantor, or failures which result from accidents, misuse, abuse, neglect, bug infestation, mishandling, misapplication, alteration, faulty installation, set-up adjustments, misadjustment of consumer controls, improper maintenance, power line surge, lightning damage, modification, or commercial use (such as in a hotel, office, restaurant, or other business), rental use of the product, service by anyone other than a Factory Service Center or other Authorized Servicer, or damage that is attributable to acts of God.

THERE ARE NO EXPRESS WARRANTIES EXCEPT AS LISTED UNDER "LIMITED WARRANTY COVERAGE". THE WARRANTOR IS NOT LIABLE FOR INCIDENTAL OR CONSEQUENTIAL DAMAGES RESULTING FROM THE USE OF THIS PRODUCT, OR ARISING OUT OF ANY BREACH OF THIS WARRANTY.

(As examples, this excludes damages for lost time, cost of having someone remove or re-install an installed unit if applicable, or travel to and from the servicer, loss of media or images, data or other memory or recorded content. The items listed are not exclusive, but are for illustration only.)

ALL EXPRESS AND IMPLIED WARRANTIES, INCLUDING THE WARRANTY OF MERCHANTABILITY, ARE LIMITED TO THE PERIOD OF THE LIMITED WARRANTY.

Some states do not allow the exclusion or limitation of incidental or consequential damages, or limitations on how long an implied warranty lasts, so the exclusions may not apply to you. This warranty gives you specific legal rights and you may also have other rights which vary from state to state. If a problem with this product develops during or after the warranty period, you may contact your dealer or Service Center. If the problem is not handled to your satisfaction, then write to the warrantor's Consumer Affairs Department at the addresses listed for the warrantor.

PARTS AND SERVICE (INCLUDING COST OF AN IN-HOME SERVICE CALL, WHERE APPLICABLE) WHICH ARE NOT COVERED BY THIS LIMITED WARRANTY ARE YOUR RESPONSIBILITY.

Customer Services Directory

Service in Canada: As per Sevicenter listed in Canadian warranty information on page 133.

Obtain Product Information and Operating Assistance; locate your nearest Dealer or Service Center; purchase Parts and Accessories; or make Customer Service and Literature requests by visiting our Web Site at:

<http://www.panasonic.com/consumersupport>

or, contact us via the web at:

<http://www.panasonic.com/contactinfo>

You may also contact us directly at:

1-800-211-PANA (7262),

Monday-Friday 9 am-9 pm; Saturday-Sunday 10 am-7 pm, EST

For hearing or speech impaired TTY users, TTY : 1-877-833-8855

Accessory Purchases

Purchase Parts, Accessories and Instruction Books online for all Panasonic Products by visiting our Web Site at:

<http://www.pstc.panasonic.com>

or, send your request by E-mail to:

npcparts@us.panasonic.com

You may also contact us directly at:

1-800-332-5368 (Phone) 1-800-237-9080 (Fax Only) (Monday – Friday 9 am to 9 pm, EST.)

Panasonic Service and Technology Company

20421 84th Avenue South,

Kent, WA 98032

(We Accept Visa, MasterCard, Discover Card, American Express, and Personal Checks)

For hearing or speech impaired TTY users, TTY : 1-866-605-1277

Product Repairs

Centralized Factory Service Center

MAIL TO:

Panasonic Camera and Digital Service Center

1590 Touhy Ave.

Elk Grove Village, IL 60007

Please carefully pack and ship, prepaid and insured, to the Elk Grove Village Centralized Factory Service Center.

Customer's in Puerto Rico, please ship or carry in to location below ("Service in Puerto Rico").

Service in Puerto Rico

Panasonic Puerto Rico, Inc.

Ave. 65 de Infantería, Km. 9.5, San Gabriel Industrial Park,

Carolina, Puerto Rico 00985

Phone (787)750-4300, Fax (787)768-2910

As of January 2007

Warranty (For Canadian Customers)

Panasonic Canada Inc.

5770 Ambler Drive, Mississauga, Ontario L4W 2T3

PANASONIC PRODUCT – LIMITED WARRANTY

Panasonic Canada Inc. warrants this product to be free from defects in material and workmanship and agrees to remedy any such defect for a period as stated below from the date of original purchase.

Camcorder Product – One (1) year, parts and labour

LIMITATIONS AND EXCLUSIONS

This warranty does not apply to products purchased outside Canada or to any product which has been improperly installed, subjected to usage for which the product was not designed, misused or abused, damaged during shipping, or which has been altered or repaired in any way that affects the reliability or detracts from the performance, nor does it cover any product which is used commercially. Dry cell batteries are also excluded from coverage under this warranty.

This warranty is extended to the original end user purchaser only. A purchase receipt or other proof of date of original purchase is required before warranty service is performed.

THIS EXPRESS, LIMITED WARRANTY IS IN LIEU OF ALL OTHER WARRANTIES, EXPRESS OR IMPLIED, INCLUDING ANY IMPLIED WARRANTIES OF MERCHANTABILITY AND FITNESS FOR A PARTICULAR PURPOSE.

IN NO EVENT WILL PANASONIC CANADA INC. BE LIABLE FOR ANY SPECIAL, INDIRECT OR CONSEQUENTIAL DAMAGES.

In certain instances, some jurisdictions do not allow the exclusion or limitation of incidental or consequential damages, or the exclusion of implied warranties, so the above limitations and exclusions may not be applicable.

WARRANTY SERVICE

FOR PRODUCT OPERATION ASSISTANCE, please contact:

Our Customer Care Centre: Telephone #: (905) 624-5505
 1-800 #: 1-800-561-5505
 Fax #: (905) 238-2360
 Email link: "Customer support" on www.panasonic.ca

FOR PRODUCT REPAIRS, please locate your nearest Authorized Servicentre at www.panasonic.ca :

Link: "Servicentres™ locator" under "Customer support"

IF YOU SHIP THE PRODUCT TO A SERVICENTRE

Carefully pack and send prepaid, adequately insured and preferably in the original carton.

Include details of the defect claimed, and proof of date of original purchase.

Index

- Numerics
 - 5.1 channel 83
- A
 - A/V terminal 21, 84, 86
 - AC adaptor 28, 31, 121
 - Aperture 66
 - Auto focus 124
 - Auto Ground-Directional Standby (AGS) 44
 - Automatic white balance 65, 123
 - AVCHD 13
- B
 - Backlight compensation 54
 - Battery 28, 29, 121
 - Battery cable cover 22
 - Beep sound 107
 - Black balance 66
- C
 - Card 26, 34, 122
 - Charging time 30
 - Color bar 62
 - Component 84
 - Cooling fan 19
 - Cursor button 35
 - Customer Services Directory 132
- D
 - Date and time display 41
 - Date and time setting 41
 - Delete
 - Scene 74
 - Still picture 76
 - Demo mode 107
 - Digital zoom 52
 - Display 107
 - DPOF setting 78
 - Dubbing 89
- E
 - EZ Sync 87
- F
 - Fade 54
 - Flash 57
 - Focus 48, 64
 - Format
 - Card 79
 - Frame-by-frame playback 70
- G
 - Gain 66
 - Grip belt 23
 - Guide line function 59
- H
 - HDMI terminal 81
 - Help mode 39
 - High definition 13
- I
 - Image stabilizer 59
 - Initial setting 107
 - Iris 66
- L
 - Language 42
 - LCD monitor 24, 42, 122
 - Lens hood 23
 - Limited Warranty (Canada) 133
 - Limited Warranty (USA) 131
- M
 - MagicPix function 55
 - Manual focus 64
 - Menu 39
 - Menu list 105
 - MF assist function 64
 - Microphone level 60
 - Microphone terminal 21
 - Mode dial 32
 - Motion picture compatibility 69
 - Motion picture playback 68
 - Motion picture recording 45
- N
 - Number of Recordable Pictures
 - on an SD Card 51
- O
 - Operation icons 37
- P
 - PictBridge 90
 - Picture quality 51
 - Playing back motion pictures by date 71
 - POWER LCD 42
 - Power save 107
 - Protecting scenes 75
 - Protecting still pictures 77
- Q
 - Quick start 33

R	
Recordable time	30, 47
Recording lamp	107
Recording modes	47
Recording time elapsed	46
Red eye reduction	58
Remaining battery capacity indication	31
Remaining number of still pictures	49
Remaining time left for recording	46
Remote control	24
Repair	112
Repeat playback	71
Request for Service Notice (USA Only)	130
Resume playback	72
S	
Scene mode	63
SD Memory Card	26
SD Speed Class	27
SDHC Memory Card	26
Self-recording	53
Self-timer recording	57
Shutter effect	50
Shutter speed	66
Simultaneous recording	50
Skip playback	69
Slide show	73
Slow-motion playback	69
Soft skin mode	56
Still picture (JPEG) playback	72
Still picture (JPEG) recording	48
Still picture compatibility	73
T	
Tele macro	56
Tripod receptacle	23
TV aspect	80
V	
Volume adjustment	70
W	
White balance	65, 124
Wind noise reduction function	60
Z	
Zebra display	62
Zoom	52
Zoom microphone	53

Spanish Quick Use Guide/Guía española para el uso rápido

■ Carga de la batería

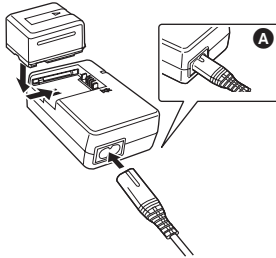

- 1) Conecte el cable de CA al adaptador de CA y a la toma de CA.
- 2) Instale la batería en el compartimento alineando la marca y, a continuación, conéctela de forma segura.
 - La clavija de salida del cable de CA no queda completamente conectada al conector del adaptador de CA. Como se muestra en **A**, queda un espacio.

■ Inserción de la batería

- 1) Abra la tapa de la batería.
 - Empuje **A** mientras lo desliza.

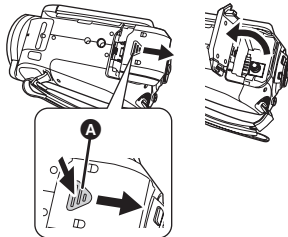

- 2) Inserte la batería hasta escuchar un clic prestando atención al sentido de la batería.
 - **B** Empuje la batería hasta que queda bloqueada.

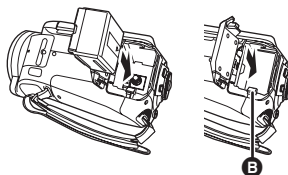

- 3) Cierre la tapa de la batería.

■ Extracción de la batería

- 1) Abra la tapa de la batería.

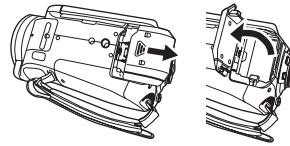

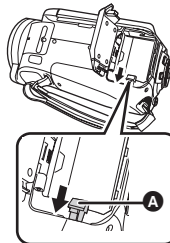

- 2) Extraiga la batería.
 - Deslice **A** en la dirección de la flecha para desbloquearlo y luego extraiga la batería.



- 3) Cierre la tapa de la batería.

■ Cómo encender la unidad

Mientras pulsa el botón de desbloqueo, ajuste el selector de modo en ,  o .

- Gire el selector de modo mientras pulsa el botón de desbloqueo **A** si cambia de OFF a otro modo.
- Alinee con el indicador de estado **B**.

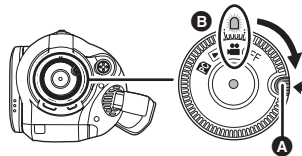

■ Cómo apagar la unidad

Coloque el selector de modo en OFF.

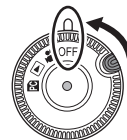

■ Insertar/extraer una tarjeta SD

- 1) Ajuste el selector de modo en la posición OFF.
- 2) Abra la pantalla LCD y luego abra la tapa de la ranura de la tarjeta.

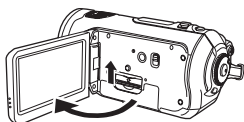

- 3) Inserte/extraiga la tarjeta SD de la ranura de la tarjeta.

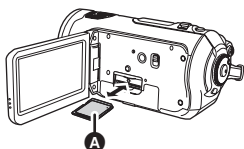

- Para insertar una tarjeta SD, colóquela con el lado de la etiqueta **A** hacia arriba e insértela derecho hacia dentro, hasta que tope.

- 4) Cierre la tapa de la ranura de la tarjeta de forma segura.

■ Grabación de películas

- 1) Gire el selector de modo para seleccionar .

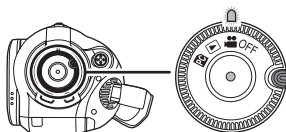

- 2) Abra la pantalla LCD.
- 3) Pulse el botón de inicio/parada de grabación para iniciar la grabación.

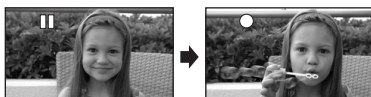

- 4) Vuelva a pulsar el botón de inicio/parada de grabación para hacer una pausa en la grabación.

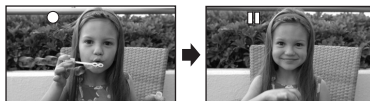

■ Grabación de fotografías (JPEG)

- 1) Gire el selector de modo para seleccionar .

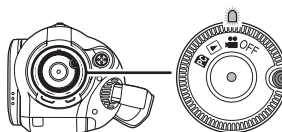

- 2) Abra la pantalla LCD.
- 3) Pulse el botón PHOTO SHOT hasta la mitad para ajustar el enfoque. (Solo para enfoque automático)

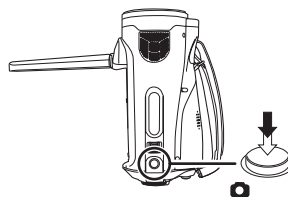

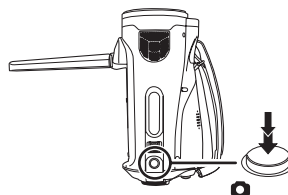

- 4) Pulse el botón PHOTO SHOT completamente para sacar la foto.

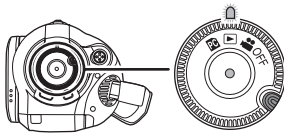

Reproducción de películas

- 1) Gire el selector de modo para seleccionar



- 2) Pulse el cursor hacia arriba y luego hacia la izquierda para seleccionar la ficha  (reproducción de películas).

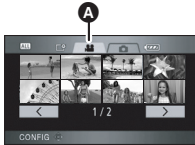

- 3) **A** Ficha reproducción de películas
 Seleccione la escena que desea reproducir.



- B** Página anterior
- C** Página siguiente
- D** Número de escena

- 4) Pulse el cursor.





- 5) Mueva el cursor para realizar una de las siguientes operaciones.

- ▶/||:** Reproducción/ Pausa
- ◀◀ (Mover y sostener):** Revisión
- ▶▶ (Mover y sostener):** Localización
- :** Detener la reproducción y visualizar las miniaturas.

Reproducción de fotografías (JPEG)

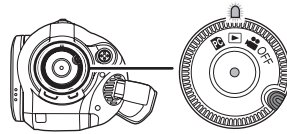
- 1) Gire el selector de modo para seleccionar



- 2) Pulse el cursor hacia arriba y luego hacia la derecha para seleccionar la ficha  (reproducción de fotografías).



- 3) **A** Ficha de reproducción de fotografías
 Select the file to be played back.



- B** Página anterior
- C** Página siguiente
- D** Indicación de número de archivo
- E** Nombre carpeta/archivo

- 4) Pulse el cursor.



- 5) Mueva el cursor para realizar una de las siguientes operaciones.

- ▶/||:** Iniciar o hacer una pausa en la presentación de diapositivas (reproducción de las fotografías contenidas en la tarjeta SD en orden numérico).
- ◀:** Reproducir la imagen anterior.
- ▶:** Reproducir la imagen siguiente.
- :** Detener la reproducción y visualizar las miniaturas.





**Panasonic Consumer Electronics Company,
Division of Panasonic Corporation of North America**

One Panasonic Way, Secaucus, NJ 07094

Panasonic Puerto Rico, Inc.

Ave. 65 de Infantería, Km. 9.5, San Gabriel Industrial Park, Carolina, Puerto Rico 00985

Panasonic Canada Inc.

5770 Ambler Drive, Mississauga, Ontario, L4W 2T3



VQT1A24
S0107Mk0



© 2007 Matsushita Electric Industrial Co., Ltd.