

Panasonic[®]

Owner's Manual Wearable Camera

Model No. **HX-A500**



Please read these instructions carefully before using this product, and save this manual for future use.



Register online at www.panasonic.com/register (U.S. customers only)

SQW0001

Contents

Preparation

(Important) About the Waterproof/ Dustproof.....	4
Read this first.....	7
What you can do with this unit.....	9
Names and Functions of Main Parts.....	10
Power supply.....	11
Charging the battery.....	11
Charging and recording time.....	12
Recording to a card.....	14
Cards that you can use with this unit.....	14
Inserting/removing a microSD card.....	15
Turning this unit on/off.....	16
About overheat detection.....	16
Setting date and time.....	17
Using the menu screen.....	18
Using the Setup Menu.....	19

Recording

Before recording.....	22
Wearing this unit.....	22
Recording.....	27
Changing the Recording Mode.....	30
Recording functions of menus.....	32

Playback

Playback using a smartphone.....	37
Using playback functions on a smartphone.....	38
Playing back on a TV.....	39
Playing back on a PC.....	39

Wi-Fi

Wi-Fi® function.....	40
Using Wi-Fi modes.....	42
Changing the Wi-Fi mode.....	42
Remote operation.....	43
Preparations before using remote operation.....	44
Using remote operation with a direct connection ([Smartphone Direct Connect]).....	44
Using remote operation with a wireless access point connection ([Wireless Network Mode]).....	46
Screen display during remote operations.....	47
Live broadcasting.....	48
Preparations before broadcasting live ...	49
Broadcasting live.....	50
Playback on a DLNA-compatible TV.....	54
Preparations before using Playback on a DLNA-compatible TV.....	54
Playing back on a DLNA-compatible TV.....	55
Install the "Image App".....	56
Setting Up a Wi-Fi Connection.....	57
Setting up a direct connection to a smartphone.....	57
Setting up with [Wi-Fi Easy Setup].....	58
Connecting to a wireless access point...	59
How to Use the [Wi-Fi SETUP] Menu.....	66

With a PC

What you can do with a PC	71
Card reader function (mass storage)	72
Operating environment	72
Copying motion/still pictures on PC	73
About the PC display	74
Using the HD Writer WE 2.0	
(Windows only)	75
The feature of HD Writer WE 2.0	75
Before Installing HD Writer WE 2.0	76
Operating environment for	
HD Writer WE 2.0	77
Installation	78
Starting HD Writer WE 2.0	79

Others

Indications	80
Messages	82
About recovery	82
Troubleshooting	83
Cautions for use	86
Approximate recordable time	89
Approximate number of recordable	
pictures	90
Optional accessories	91
Requests when disposing of this unit	92
About copyright	94

(Important) About the Waterproof/ Dustproof

Waterproof/Dustproof Performance

This unit's waterproof/dustproof rating complies with the "IP58" rating. Provided the care and maintenance guidelines described in this document are strictly followed, this unit can operate underwater, to a depth not exceeding 3.0 m (10 feet) for a time not exceeding 30 minutes. *

This does not guarantee no destruction, no malfunction, or waterproofing in all conditions.

* This means that this unit can be used underwater for specified time in specified pressure in accordance with the handling method established by Panasonic.

■ Handling of this unit

- Waterproofing is not guaranteed if the unit is subject to an impact as a result of being hit or dropped etc. If an impact to this unit occurs, it should be inspected (subject to a fee) by a Panasonic's Service Center to verify that the waterproofing is still effective.
- The waterproof performance may be degraded due to the strong water pressure when this unit is used deeper than 3.0 m (10 feet) underwater.
- When this unit is splashed with detergent, soap, hot spring, bath additive, sun oil, sun screen, chemical, etc., wipe it off immediately.
- Do not rinse with running water, such as tap water.
- Waterproof function of this unit is for sea water and fresh water only.
- Any malfunction caused by customer misuse, or mishandling will not be covered by the warranty.
- Cards are not waterproof. Do not handle with a wet hand. Also, do not insert wet card into this unit.
- Do not open or close the side cover when your hands are wet or water droplets are present on this unit. Failure to do so may lead to damage such as rusty terminals caused by water droplets.
- **Foreign objects may adhere to the inner side of the side cover (around the rubber seal or connecting terminals) when the side cover is opened or closed in places with sand or dust etc. If you close the side cover with foreign objects adhering to it, water may enter the inside. Be very careful because doing so may cause malfunctions.**
- Do not leave this unit for a long period of time in places where temperature is very low (at high altitude etc.) or very high (inside a car under strong sunlight, close to a heater, on the beach, etc.) Waterproof performance may be degraded.
- The inside of this unit is not waterproof. Water leakage will cause malfunction.
- **If any foreign object has adhered to the inner side of the side cover, remove it.**
- **If any liquid such as water droplets has adhered to this unit or inner side of the side cover, wipe off with a soft dry cloth. Do not open or close the side cover near the water, when underwater, using wet hands, or when this unit is wet. It may cause water leakage.**
- The alert sound and shutter sound may be lowered when using this unit. This is for ensuring the waterproof performance of this unit, and not a malfunction. Opening and closing the side cover will restore the original volume.

■ About Condensation (When the lens or the LCD monitor is fogged up)

Condensation occurs when there is a change in temperature or humidity, such as when the unit is taken from outside or a cold room to a warm room. Please be careful, as it may cause the lens or LCD monitor to become soiled, moldy, or damaged.

When taking the unit to a place which has a different temperature, if the unit is accustomed to the room temperature of the destination for about one hour, condensation can be prevented. (When the difference in temperature is severe, place the unit in a plastic bag or the like, remove air from the bag, and seal the bag.)

When condensation has occurred, turn the unit off, open the side cover and leave the unit like that for about 2 hours. When the unit becomes accustomed to the surrounding temperature, fogging will disappear naturally.

Check before using underwater

Do not open or close the side cover in places with sand and dust, close to water, or with wet hands. Sand or dust adhering may cause water leaks.

1 Open the side cover.

- 1 Slide the LOCK switch **A** to the left to unlock the side cover.
- B**: Unlocked when the red indicator is visible
- 2 Slide the side cover downward to open it.

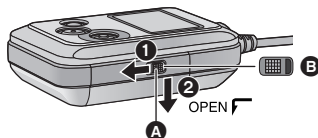

2 Check that there are no foreign objects on the inner side of the side cover.

- If there are any foreign objects, such as lint, hair, sand, etc., on the surrounding area, water will leak within a few seconds causing malfunction.

3 If there is foreign matter adhering to the unit, remove it.

- Be extremely careful to remove any sand etc. that may adhere to the sides and corners of the rubber seal.
- Wipe it off with a dry soft cloth if there is any liquid. It may cause water leaks and malfunction if you use this unit with liquid adhered.

4 Check for cracks and deformation of the rubber seal on the side cover.

- The integrity of the rubber seals may decrease after about 1 year, with use and age. To avoid permanently damaging this unit the seals should be replaced once every two years. Please contact Panasonic's Service Center for related costs and other information.

5 Close the side cover securely.

- 1 Close the side cover and slide it upward.
 - 2 Slide the LOCK switch to the right to lock the side cover.
- Lock securely to the points where the red portion of the LOCK switch is no longer visible.
 - Securely lock it until it clicks.

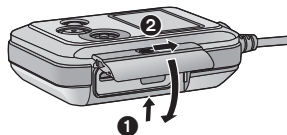

- To prevent water seeping into this unit, be careful not to trap foreign objects such as liquids, sand, hair or dust etc.

Using this unit underwater

- Use this unit underwater at a depth of down to 3.0 m (10 feet) with the water temperature between 0 °C and 35 °C (32 °F and 95 °F).
- Do not use this unit at a depth of over 3.0 m (10 feet).
- Do not use it in hot water over 35 °C (95 °F) (in a bath or hot spring).
- Do not use this unit underwater not longer than 30 minutes continuously.
- Do not open or close the side cover.
- Do not apply shock to this unit underwater. (Waterproof performance may not be maintained, and there is a chance of water leak.)
- Do not dive into the water holding this unit. Do not use this unit in a location where the water will splash strongly, such as rapid flow or waterfall. (Strong water pressure may be applied, and it may cause malfunction.)
- This unit will sink in the water. Take care not to drop this unit.

Caring for this unit after using it underwater

Do not open or close the side cover until the sand and dust is removed by rinsing the camera with water.

Make sure to clean the camera after using it.

- Thoroughly wipe off any water droplets, sand, and saline matter on your hands, body, hair, etc.
- It is recommended to clean the camera indoors, avoiding places where water spray or sand may fall.
- **Do not leave this unit uncared for longer than 60 minutes after using it underwater.**
- Leaving this unit with foreign objects or saline matter on it may cause damage, discoloration, corrosion, unusual odor, or deterioration of the waterproof performance.

1 Rinse with water with the side cover closed.

- After use at the seaside or underwater, soak the unit in fresh water pooled in a shallow container for about 10 minutes.

2 Drain water by holding this unit and shaking it lightly a few times.

- After using this unit at the seaside or underwater, or after washing it, water will remain at the speaker site or mic site of this unit for a while and it may cause lower sound or sound distortion.
- Pay careful attention to prevent this unit from dropping.

3 Wipe off water drops on this unit with a soft, dry cloth and dry this unit in a shaded area that is well ventilated.

- Dry this unit approx. 1 hour or more.
- Dry this unit on a dry cloth.
- Do not dry this unit with hot air from dryer or similar. It will deteriorate the waterproof performance or cause failure due to deformation.
- Do not use chemicals such as benzine, thinner, alcohol or cleanser, soap or detergents.

4 Confirm that there are no water droplets, open the side cover, and wipe off any water droplets or sand left inside using a soft, dry cloth.

- Water droplets may adhere to the card, etc. when the side cover is opened without thoroughly drying. Also, water may accumulate in the gap around the card slot or the terminal connector. Be sure to wipe any water off with a soft, dry cloth.
- The water droplets may seep into this unit when the side cover is closed while it is still wet, causing condensation or failure.

In case water enters this unit, stop the use and consult your dealer.

Malfunctions resulting from water leakage due to wrong handling by customers are not subject to compensation.

- If the Head Mount is exposed to seawater, rinse off the salt water with fresh water. When the Head Mount is exposed to water, wipe it off with a dry towel or something similar, and dry it thoroughly in the shade.

Read this first

■ About recording formats and compatibility of this unit

- This unit is an MP4 format (MPEG-4 AVC file standard)* Wearable Camera for recording high-definition motion pictures.
- * You can record 4K motion pictures ([3840×2160/30p]).
- AVCHD and MPEG2 motion pictures are different formats, and are not therefore supported by this unit.
- Motion pictures recorded with other devices are not supported by this unit.

■ About the portrait rights

Be sure to pay special attention to the privacy, the portrait rights, etc. of the subject when you use this unit. Use it at your own risk.

■ Indemnity about recorded content

Panasonic does not accept any responsibility for damages directly or indirectly due to any type of problems that result in loss of recording or edited content, and does not guarantee any content if recording or editing does not work properly. Likewise, the above also applies in a case where any type of repair is made to this unit.

■ About the “Image App”

Install the smartphone application “Image App” on your smartphone. You can enjoy a variety of functions by setting up a Wi-Fi connection between this unit and a smartphone. (→ 9)

- For information about the installation of the “Image App”, refer to page 56.

■ About the clock setting

Make sure to set date and time before recording. (→ 17)

■ For the purposes of this owner's manual

- Pictures may be slightly different from the original.
- Depending on the firmware version you are using, captured screens described in this owner's manual may differ from the actual screens.
- Names, icons, contents and services of applications may be changed with no prior notice. Please note that they may differ from the descriptions of this owner's manual.
- microSD Card and microSDHC Card are referred to as the "microSD card".
- Smartphone and tablet computer are referred to as the "smartphone".
- Pages for reference are indicated by an arrow, for example: → 00
- Smartphone operations are described as follows:

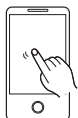

Tap

Touch the screen lightly and release your finger.

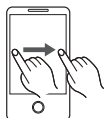

Drag

Move your finger while still touching the screen.

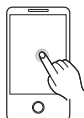

Tap and Hold

Touch and hold the screen.
(1 second or longer)



Drag and Drop

Move your finger while still touching the screen, and release the finger.

■ Cards that you can use with this unit

microSD Memory Card and microSDHC Memory Card

What you can do with this unit

You can enjoy a variety of functions by setting up a Wi-Fi connection between this unit and a smartphone or a wireless access point.

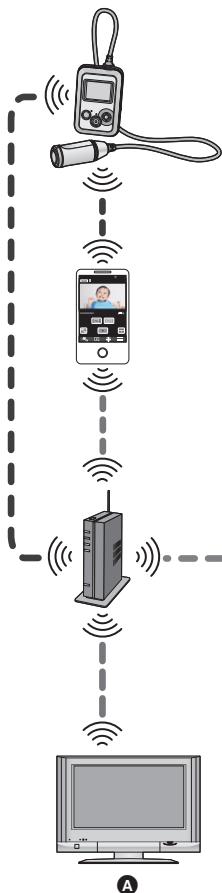

- Recording motion pictures/still pictures (→ 27)
- Menu settings (→ 18, 19, 32, 66)

Wi-Fi Connection with a smartphone

Image App

- Playback (→ 37)
- Deletion/Copy (→ 37, 38)
- Remote operation (→ 43)

Wi-Fi Connection with a wireless access point

LUMIX CLUB



USTREAM

Live broadcasting

Using the "LUMIX CLUB" and USTREAM services, you can broadcast live motion pictures. (→ 48)

Playback on DLNA-compatible devices

You can play back the contents stored in this unit on the DLNA-compatible TV. (→ 54)

A DLNA-compatible devices

Names and Functions of Main Parts

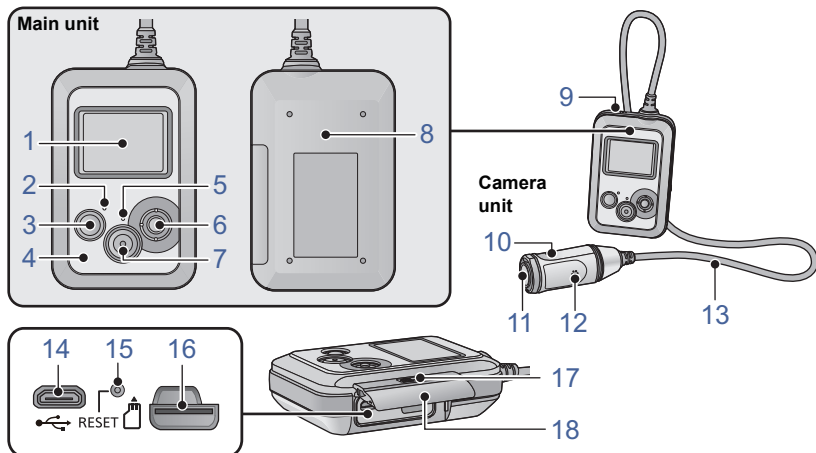

- 1 LCD monitor
- 2 Power lamp (→ 13, 16)
- 3 Power button [⏻/⏻] (→ 16)
- 4 Wi-Fi Transmitter
- 5 Access lamp (→ 15)
- 6 Joystick

Use the joystick to operate the menu screen or to use a Wi-Fi mode. Move the joystick up, down, left or right, and then press the joystick to set an item.

- Using the menu screen (→ 18)
- Using Wi-Fi modes (→ 42)
- Displaying the information screen (→ 28)
- Checking the motion picture/still picture you have recorded (Rec Review) (→ 29)
- Using the lock function (→ 29)

- 7 Recording start/stop button (→ 27)
- 8 NFC touch area [👆] (→ 44, 46)
- 9 Speaker
- 10 Camera (→ 24)
- 11 Lens (→ 5)
- 12 Mic
- 13 Camera/main unit connection cable

• This cable is not removable.

- 14 USB terminal [🔌] (→ 11)
- 15 Reset button [RESET]

• If this unit fails to operate correctly, such as when this unit cannot be turned on/off, press the reset button by using a paper clip or a similar object.

- 16 Card slot (→ 15)
- 17 LOCK switch (→ 5, 11, 15)
- 18 Side cover (→ 5, 11, 15)

Power supply

Charging the battery

When this unit is purchased, the battery is not charged. Charge the battery fully before using this unit for the first time.

- This unit has a built-in rechargeable lithium-ion battery. Do not remove except when disposing of this unit. (→ 92)
- The battery will not be charged if this unit is turned on. Connect it with the PC to charge the battery after turning it off.
- It is recommended to charge the battery in a temperature between 10 °C and 30 °C (50 °F and 86 °F).

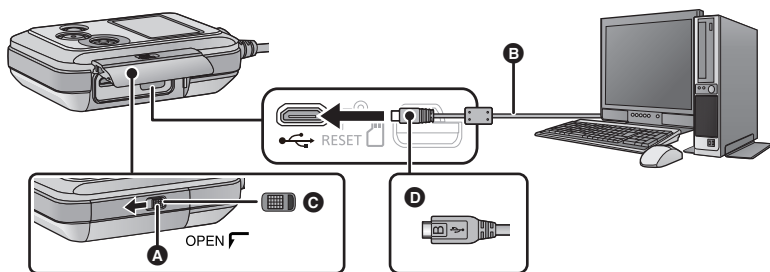

- A** LOCK switch
- B** USB cable (supplied)
- C** Unlocked when the red indicator is visible
- D** Turn the side with the symbol up to connect the micro B end of the USB Connection Cable to the USB terminal of this unit.

1 Slide the **LOCK** switch to the left to unlock the side cover and slide the side cover downward to open it.

2 Connect the **USB** terminal of this unit to a **PC** with the **USB** cable (supplied).

- Insert the USB cable securely all the way.
 - The Power lamp will flash red at an interval of 2 seconds (approximately 1 second on, 1 second off), indicating that charging has begun. It will turn off when the charging is completed.
-
- Do not use any other USB cables except the supplied one. (Operation is not guaranteed with any other USB cables.)
 - Do not heat or expose to flame.
 - Do not leave the unit (including built-in battery) in a car exposed to direct sunlight for a long period of time with doors and windows closed.
 - If operating time is short even after fully charging the battery, the battery is worn out and needs to be replaced. Please contact your dealer.
 - When the PC is in a power saving mode such as a standby state, the battery may not be charged. Cancel the power saving mode, and connect this unit again.
 - Operation is not guaranteed when devices are connected through USB hubs or by using extension cables.
 - Operation cannot be guaranteed on all devices having a USB terminal.

Charging and recording time

■ Charging/Recording time

- Temperature: 25 °C (77 °F)/humidity: 60%RH

Charging time	Pixels/Frame rate	Maximum continuous recordable time	Actual recordable time
4 h 30 min	[3840×2160/30p]	1 h 20 min	40 min
	[1920×1080/60p]	1 h 50 min	55 min
	[1920×1080/30p]	2 h 10 min	1 h 5 min
	[1280×720/60p]	1 h 45 min	55 min
	[1280×720/30p]	2 h 5 min	1 h 5 min
	[848×480/30p]	2 h 10 min	
	[1920×1080/60fps]	2 h 5 min	1 h
	[1280×720/120fps]	2 h	
[848×480/240fps]	1 h 55 min		

- “h” is an abbreviation for hour, “min” for minute and “s” for second.
- These times are approximations.
- **The indicated charging time is for when the battery has been discharged completely. Charging time and recordable time vary depending on the usage conditions such as high/low temperature.**







- The actual recordable time refers to the recordable time when repeatedly starting/stopping recording, turning this unit on/off, etc.
- The power lamp flashes (Flashing with approx. 1 second period (off for approx. 0.5 second, on for approx. 0.5 second)) when the remaining battery time becomes low.
- The main unit heats up after use or charging. This is not a malfunction.
- For information about charging with a mobile USB charger or an AC adaptor, check the support site.

http://panasonic.jp/support/global/cs/e_cam/index.html

(This site is English only.)

The power plug is the disconnecting device. Install this unit so that the power plug can be unplugged from the socket outlet immediately.

Battery capacity indication

- The display changes as the battery capacity reduces.  →  →  →  → 
If the battery discharges, then  will flash red.

When the Power lamp is flashing during charging

Flashing with approx. 0.5 second period (off for approx. 0.25 second, on for approx. 0.25 second):

- Check that the USB terminals of this unit or the connecting device, such as PC are not dirty or covered with a foreign object, and reconnect correctly. If a foreign object or dirt is present, turn off this unit before removing.
- The environment is at an extremely high or low temperature. Wait until the temperature has returned to an appropriate level and try charging again. If you are still unable to charge, there may be a fault in this unit or the connecting device.

Flashing with approx. 4 second period (off for approx. 2 seconds, on for approx. 2 seconds):

- When the battery is over discharged or the temperature of the battery is too high or low. It can be charged, but it may take a few hours to complete the charging normally.
- It will flash in approx. 2 second intervals when normal charging resumes. Even in such cases, it may start flashing in approx. 4 second intervals until charging is completed depending on the conditions of use.

Off:

- Charging has finished.

Recording to a card

This unit can record motion pictures or still pictures to a microSD card.

Cards that you can use with this unit

- The information on the cards that you can use are current as of April 2014.

Card type	Capacity
microSD Card	512 MB/1 GB/2 GB
microSDHC Card	4 GB/8 GB/16 GB/32 GB

- To record motion pictures, use a microSD card that supports one of the following SD Speed Class Ratings*.

If you use a microSD card with an SD Speed Class Rating that does not support the current recording setting, recording may stop suddenly.

Recording settings	Supported SD Speed Class Ratings
When [PIXELS / FRAME RATE] is set to [3840×2160/30p] (→ 32)	Class 10 or higher of the SD Speed Class Rating
When [RECORDING MODE] is set to [SLOW MOTION] (→ 30)	Class 6 or higher of the SD Speed Class Rating
Settings other than the above	Class 4 or higher of the SD Speed Class Rating

- * SD Speed Class Rating is the speed standard regarding continuous writing. Check via the label on the card, etc.

e.g.:



- Please check the latest information on the support website below.

http://panasonic.jp/support/global/cs/e_cam/index.html

(This website is in English only.)

- When using an microSDHC Card with other equipment, check the equipment is compatible with the microSDHC Card.
 - Operation is not guaranteed for all microSD cards.
 - 4 GB or more Memory Cards that do not have the microSDHC logo are not based on SD Memory Card Specifications.
-
- Keep the Memory Card out of reach of children to prevent swallowing.

Inserting/removing a microSD card

When using a microSD card not from Panasonic, or one previously used on other equipment, for the first time on this unit, format the microSD card. (→ 20) When the microSD card is formatted, all of the recorded data is deleted. Once the data is deleted, it cannot be restored.

Caution:

Check that the access lamp has gone off.

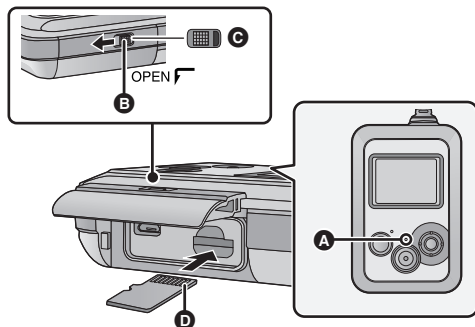

A Access lamp

- When this unit is accessing the microSD card (such as recognition, recording, playback and deletion), the access lamp lights up.

B LOCK switch

- Unlocked when the red indicator is visible

1 Slide the LOCK switch to the left to unlock the side cover and slide the side cover downward to open it and then insert (remove) the microSD card into (from) the card slot.

- Face the terminal side **D** upward and press it straight in as far as it will go.
- Press the center of the microSD card and then pull it straight out.

2 Close the side cover and slide the LOCK switch to the right to lock it.

- Close the side cover and slide it upward and then lock it.
- Securely lock it until it clicks.

- Do not touch the terminals on the back of the microSD card.
- For handling of microSD card, refer to page 87.

- **If you insert or remove the microSD card in the following situations, the Wi-Fi mode will turn off and the connection will be disconnected:**
 - When you set up a Wi-Fi connection between this unit and a smartphone and set this unit to Playback mode remotely with the smartphone (→ 37)
 - When you set up a Wi-Fi connection between this unit and a DLNA-compatible TV (→ 55)

■ About the access lamp

- When the access lamp is lit, do not:
 - Remove the microSD card
 - Turn this unit off
 - Insert and remove the USB cable
 - Expose this unit to vibrations or shock

Performing the above while the lamp is on may result in damage to data/microSD card or this unit.

Turning this unit on/off

Press the power button to turn on this unit.

The power lamp is turned on.

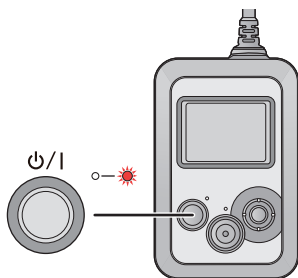

To turn off this unit

Hold down the power button until the power lamp goes off.

About overheat detection

When the internal temperature of this unit rises during use, it turns off automatically after emitting a warning sound and displaying a message. To use this unit again, wait until it cools down.

- This unit cannot be used until it cools down.

Setting date and time

The clock is not set at the time of purchase. Make sure to set the clock.

1 Press the joystick to select the menu. (→ 18)

[SETUP] → [CLOCK SET]

2 Move the joystick right or left to select the date to be set, then move the joystick up or down to select the desired value.

- Press the joystick or recording start/stop button to enter the selection.
- The year can be set between 2000 and 2039.

3 Move the joystick right or left to select the time to be set, then move the joystick up or down to select the desired value.

- Press the joystick to enter the selection.

4 Press the recording start/stop button to complete the setting.

-
- When the unit is turned on for the first time, a message asking you to set the date and time will appear. Select [YES] and perform Steps 2 to 3 to set the date and time.
 - If the time display becomes [- -], the built-in lithium battery needs to be charged. When the battery of this unit is in a charged state, the built-in clock battery is also charged automatically. If you leave the battery in this unit in a charged state for approximately 24 hours, the built-in clock battery stores the clock setting for approximately 4 months.
 - You can also set the clock by using the "Image App". Refer to [Help] in the "Image App" menu.

Using the menu screen

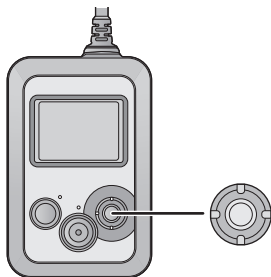

- 1 Press the joystick.
- 2 Select the top menu **A**, then press the joystick.



To get back to the previous screen

Move the joystick left.

To exit the menu screen

Press the recording start/stop button.

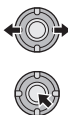
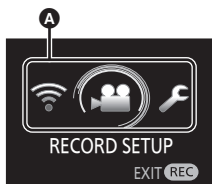

- 3 Select the submenu **B**, then press the joystick.

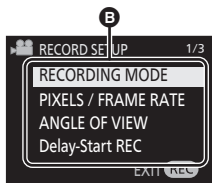

- 4 Select the desired item, then press the joystick to enter the selection.



To set menu items with a smartphone

By installing "Image App" on a smartphone, you can set menu items of this unit remotely from the smartphone.

- 1 Install the "Image App" on your smartphone. (→ 56)
- 2 Set up a Wi-Fi connection between this unit and the smartphone, and perform remote operation. (→ 43)
- 3 On the "Image App" screen, tap .

- When a Wi-Fi mode ([Smartphone Direct Connect]/[Wireless Network Mode]) is active, you cannot set menu items with this unit.

Using the Setup Menu

(When setting a menu item on this unit)

Press the joystick to select the menu.

[SETUP] → desired menu item

(When setting a menu item on the “Image App”)

- **Set up a Wi-Fi connection between this unit and a smartphone, and perform remote operation. (→ 43)**

On the “Image App” screen, tap  and set the menu item.

[Camera setup] → desired menu item

- For more information, refer to the [Help] in the “Image App” menu.

[CLOCK SET]

Please refer to page 17.

[DATE FORMAT]

It is possible to change the date format.

[Y/M/D]/[M/D/Y]/[D/M/Y]

[LCD POWER SAVE]

To save battery life, if you perform no operation during a set period of time, the LCD monitor turns off and this unit enters a standby state.

[60 SECONDS]/[30 SECONDS]/[15 SECONDS]/[OFF]

- The following operations will activate this unit:
 - Operate the joystick
 - Press the recording start/stop button (This will start/stop recording.)
- If you set this item to [OFF], this unit does not enter a standby state.
- If you start recording, the LCD monitor will turn off approximately 30 seconds later.

[AUTO POWER OFF]

When about 5 minutes have passed without any operation, this unit automatically turns off to save the battery life.

- This unit will not automatically turn off during Wi-Fi mode or when using this unit as the card reader.

[LCD BRIGHTNESS]

It adjusts brightness on the LCD monitor.

- 1 Press the joystick to select the menu.**

[SETUP] → [LCD BRIGHTNESS]

- 2 Move the joystick right or left to adjust settings, then press the joystick.**
- 3 Press the recording start/stop button to complete the setting.**

- This item cannot be set in "Image App".

[ALERT SOUND]

Starting and stopping of recording and unit on/off can be confirmed with this sound.

When [OFF] is selected, the sound is not output at the start/end of recording, etc.

[HIGH]/[LOW]/[OFF]

2 Beeps for 4 times

When an error occurs. Check the sentence displayed on the screen. (→ 82)

[INITIAL SET]

Settings of this unit return to the default condition.

- Wi-Fi network settings will not be changed.
- This item is not displayed in Playback mode. (This limitation applies to the "Image App" only)

[FORMAT MEDIA]

Please be aware that if a microSD card is formatted, then all the data recorded on the microSD card will be erased and cannot be restored. Back up important data on a PC, etc. (→ 71)

- Do not turn this unit off or remove the microSD card while formatting. Do not expose this unit to vibrations or shock.
- **Do not format a microSD card using any other equipment such as a PC. The card may not be used on this unit.**

[FIRMWARE VERSION]

The firmware version of this unit is displayed.

- This item cannot be displayed in “Image App”.

[FIRMWARE UPGRADE]

You can update the firmware version of this unit.

For the latest update information, check the support website below. (As of April 2014)

http://panasonic.jp/support/global/cs/e_cam/index.html

(This Site is English only)

- This item cannot be used in “Image App”.

[NUMBER RESET]

Set the file number of the motion picture and still picture recorded next to 0001.

- Folder number is updated and file number will start from 0001. (→ 74)
- To reset the folder number, format the microSD card, and then perform [NUMBER RESET].

[LANGUAGE]

You can select the language on the screen display and the menu screen.

- This item cannot be set in “Image App”.

Before recording

This unit is designed to record images when attached to the Armband Case and the Head Mount.

Wearing this unit

Wear the main unit and camera unit.

- If a feeling of discomfort arises after a long period of use, stop the use or adjust the size of the Head Mount/Armband Case/Headband to loosen them a little. Please note that the parts may leave marks on your face and other body parts after use.
- For the direction of the camera, check the actual image on the LCD monitor.

- A** Camera unit
- B** Main unit

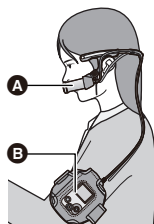

Fastening the main unit using the Armband Case

1 Insert the main unit so that you can see the buttons on it

- Make sure to insert the main unit all the way in.



2 Fasten the main unit with the hook and loop fastener.

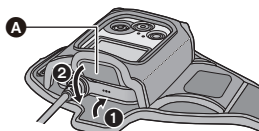

- A** Hook and loop fastener

3 Adjust the length of the band.

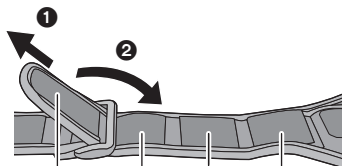

- B** Hard surface of the hook and loop fastener
- C** Hook and loop fastener

4 Pass the band through the band hole.

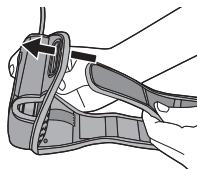

5 Attach the band to the hard surface of the hook and loop fastener to fasten the band to your arm.

- When fastening the main unit, try not to drop the camera unit to avoid a shock and try not to scratch the lens.

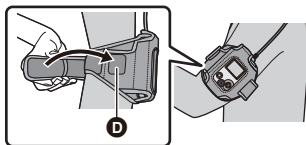

- D** Hard surface of the hook and loop fastener

■ About the Armband Case

The Armband Case can be used as a portable holder.

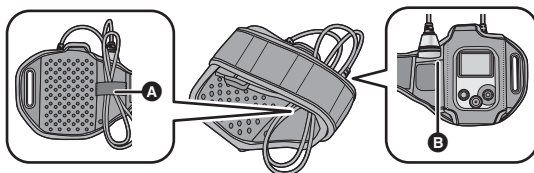

- The camera unit can be stored in the camera pocket **B**, and the camera/main unit connection cable can be bundled with the band **A**.
 - When fastening to your arm, remove the camera unit from the Armband Case.
-
- When removing the camera/main unit from the Armband Case, avoid pulling the camera/main unit connection cable.
 - Do not forcibly bend or pull the cable. Be extra careful in low temperatures, which cause the cable to become fairly inflexible.
 - Optional accessories will be handy in various scenes. (→ 91)

Assembling the Head Mount

- 1 Push down the lock lever of the Head Mount (L) to the UNLOCK side.

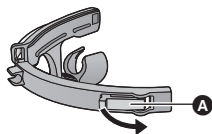

A Lock lever

- 2 Attach the Head Mount (R) to the Head Mount (L).

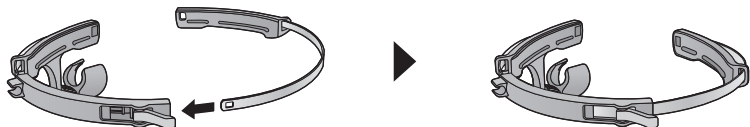

- 3 Loosen the adjustment knob, and change the direction of the camera holder.

- To loosen the adjustment knob, rotate it towards ①. To tighten the adjustment knob, rotate it towards ②.
- Adjust the direction as shown in the illustration, and tighten the adjustment knob again.

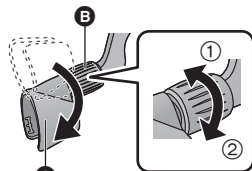

B Adjustment knob
C Camera holder

Attaching the camera unit to the Head Mount to wear

- 1 Insert the camera unit until it clicks into place.

- Insert the camera unit so that the microphone faces inward.

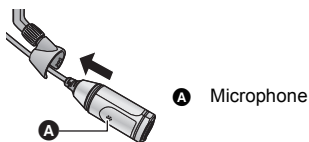

A Microphone

- 2 Fit the camera/main unit connection cable in the cable holder.

- Loosen the cable to make the shape of the Head Mount.

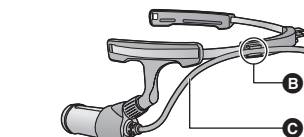

B Cable holder
C Camera/main unit connection cable

3 Hook the Head Mount to your ears firmly so that the camera unit will be positioned on the left side of your face.

4 Adjust the size of the Head Mount, and push down the lock lever to the LOCK side.

- Adjust by slowly pulling the Head Mount (R) sideways.
- If you adjust in such a way that the camera unit comes into close contact with the cheek, you can record less blurry images.

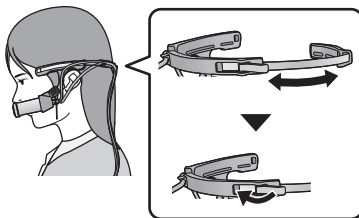

5 Hold the camera holder, and adjust the direction of the lens.

- To loosen the adjustment knob, rotate it towards ①. To tighten the adjustment knob, rotate it towards ②.
- If the direction of the lens cannot be changed, loosen the adjustment knob slightly and tighten it after adjusting the direction of the lens.
- If the camera unit is shaky, tighten the adjustment knob.

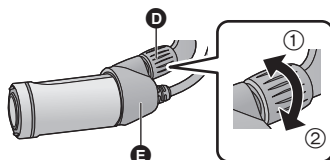

- D** Adjustment knob
- E** Camera holder

■ Attaching the Headband

When recording images full of motion such as sports, attach the Headband before putting on the Head Mount.

1 Pass the Headband through the Headband holes.

- Attach the Headband correctly so that it will not be twisted.
- You can adjust the size of the Headband by fitting the Head Mount into a different notch.

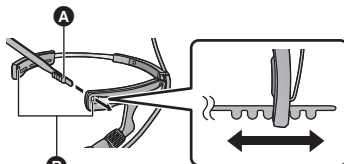

- A** Notches
- B** Headband holes

2 Put on the Head Mount.

- To change the size of the Headband, remove the Head Mount before making the adjustment.



■ How to remove the camera

Hold the camera holder as shown in the figure, and remove the camera unit in the direction of the arrow.

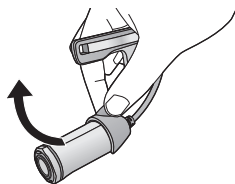

- Do not touch the lens or pull the camera/main unit connection cable while attaching or removing.
- When adjusting the size of the Head Mount and the tightness of the Headband, do so slowly without applying too much force.
- If the adjustment knob comes off, attach it as indicated in the right figure.

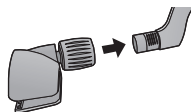

Things to check after putting on this unit

We recommend you make a test recording to check the settings such as the [ANGLE OF VIEW], [LEVEL SHOT], [IMAGE STABILIZATION] and [WHITE BALANCE] before recording.
(→ 27, 33, 34, 35)

- Put on this unit, face forward, and take the main unit out of the Armband Case to check the LCD monitor.
- You can use [Shooting guidelines] (→ 36) as a guide for checking the balance of a composition. (“Image App” only)
- The camera unit stabilizes if you wear it while placing it on your cheek.

Recording

- Set this unit to the desired Recording Mode before recording. (→ 30)

1 Press the recording start/stop button.



- If this unit is set to record a motion picture, recording starts.
- In [PICTURE RECORDING], a still picture will be recorded.
- Once recording starts, the LCD monitor will turn off approximately 30 seconds later. To turn it on again, operate the joystick.

- A** When you begin recording a motion picture, **II** changes to **●**.

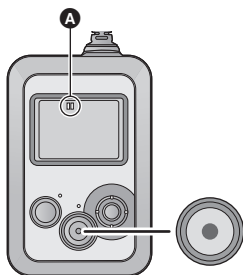

2 (When recording a motion picture) Press the recording start/stop button again to pause recording.



■ Screen indications in the Recording mode

(When recording a motion picture)

	Motion Picture Recording Mode (→ 30)
0h00m00s	Recording time elapsed <ul style="list-style-type: none"> • "h" is an abbreviation for hour, "m" for minute and "s" for second. • Each time the unit is put into recording pause, the counter display will be reset to 0h00m00s. • The elapsed recording time starts counting time as recording starts.
R 1h20m	Approximate remaining recordable time <ul style="list-style-type: none"> • When the remaining time is less than 1 minute, R 0h00m flashes red.



(When recording a still picture)

 (White)	Still Picture Recording Mode (→ 31)
 (Red)	Recording still picture <ul style="list-style-type: none"> • While still pictures are being recorded, this icon is displayed.
R3000	Remaining number of still pictures <ul style="list-style-type: none"> • Flashes in red when [0] appears.

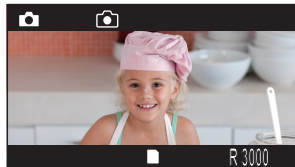

Displaying the information screen

If you move the joystick right, you can display the information screen.

- If you move the joystick right again, the information screen will disappear.
- The information screen is not displayed when a Wi-Fi mode ([Smartphone Direct Connect]/[Wireless Network Mode]) is active.
- For information on the icons to be displayed, refer to page 80.

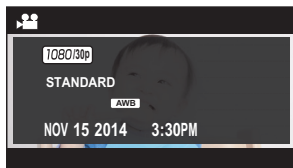

- If you set up a Wi-Fi connection between this unit and a smartphone, you can record images by operating this unit remotely from the smartphone. (→ 43)
 - The period between the start and end of recording is recorded as one file. However, motion pictures exceeding the following lengths are divided automatically. (Recording will continue.) Divided motion pictures will be displayed as separate thumbnails and cannot be played back automatically as a continuous motion picture.
The amount of data varies depending on the recording image, so use the following as approximate indications.
 - [3840×2160/30p]: approx.9 min
 - [1920×1080/60p]: approx.20 min
 - [1920×1080/30p], [1280×720/60p], [1280×720/30p] and [848×480/30p]: approx. 30 min
 - [1920×1080/60fps]: approx. 15 min
 - [1280×720/120fps]: approx. 7 min
 - [848×480/240fps]: approx. 3 min
 - Each microSD card can save up to approximately 89100 files and approximately 900 folders. When other motion pictures and still pictures have already been saved in the microSD card, the capacity becomes lower.
 - Motion pictures are saved in separate folders according to the [RECORDING MODE] (→ 30) or [PIXELS / FRAME RATE] (→ 32) settings.
Still pictures that have been taken one at a time and those taken in [INTERVAL REC MODE] (→ 34) are saved in separate folders. For details about the folders, refer to page 74.
In the following cases, motion pictures/still pictures are saved in more than one folder:
 - When the number of motion picture files exceeds 99
 - When the number of still picture files exceeds 999
 - When motion pictures are recorded with [LOOP RECORDING]
 - When still pictures are recorded with [INTERVAL REC MODE]
 - Refer to page 89, 90 for the approximate recordable time and number of recordable pictures.
 - It may take approximately 3 seconds to stop recording. Confirm if the motion picture recording stops or not by the access lamp or LCD monitor.
 - If you check an image or sound when recording motion pictures while this unit is connected wirelessly to a smartphone, etc., a squealing sound* may occur. In that case, lower the volume of the smartphone.
- * The microphone may pick up the sound from the speakers, producing an abnormal sound.

■ Checking the motion picture/still picture you have recorded (Rec Review)

If you move the joystick down during recording pause, you can play back the last recorded motion picture or still picture for approximately 5 seconds.



- During Rec Review, ► (Green) is displayed on the screen.
- Only the first 5 seconds of the motion picture will be played back. (Sound is not output)
- Moving the joystick down during the playback will return you to the recording screen.
- Except for Rec Review, playback on this unit is not possible.
You can play back the image on the smartphone by setting up a Wi-Fi connection between this unit and a smartphone. (→ 37)

-
- If you have recorded a motion picture with [LOOP RECORDING] (→ 31), the last divided part of the motion picture will be played back as a Rec Review image.
 - If you perform any of the following operations after recording a long motion picture, part other than the initial part of the motion picture may be played back as a Rec Review image.
 - Turning on/off this unit
 - Inserting and removing the microSD card
 - Deleting the file containing the initial part of the last recorded motion picture that was automatically divided into more than one file due to its long length.
 - You cannot perform Rec Review in the following cases:
 - During recording
 - When Wi-Fi mode is active
 - When you have performed [Create highlights] (→ 38)
 - When you have deleted the last recorded motion picture/still picture (→ 37)
 - When you have performed [NUMBER RESET] after recording (→ 21)
 - When you are using a microSD card containing motion pictures/still pictures recorded with another device

■ Using the lock function

You can prevent accidental operation of this unit by enabling the lock function.

Move and hold the joystick up for approximately 2 seconds.





-  will appear. The operation of this unit will be locked.
- If you move and hold the joystick up again for approximately 2 seconds, the  icon will disappear and the setting will be unlocked.
- Even when this unit is locked, you can perform operation from a smartphone. (when connected to Wi-Fi)

Changing the Recording Mode

You can record images with a variety of recording methods by changing the Recording Mode.

1 Press the joystick to select the menu.

[RECORD SETUP] → [RECORDING MODE] → desired recording mode

Recording Mode	icon	Recording method
[NORMAL SHOOTING]		Recording motion pictures.
[SLOW MOTION]		This records motion pictures in slow motion by setting a high frame rate (increasing the number of frames).
[LOOP RECORDING]		No matter how long you record, you can only record motion pictures for the last 1 hour to microSD card.
[PICTURE RECORDING]		Recording still pictures.*

* To set this unit to [PICTURE RECORDING] with the "Image App", tap the Motion Picture/Still Picture toggle button. (→ 47)

2 Start recording. (→ 27)

[SLOW MOTION]

This records motion pictures in slow motion by setting a high frame rate (increasing the number of frames).

- Sound cannot be recorded.
- [ANGLE OF VIEW], [LEVEL SHOT], [IMAGE STABILIZATION] and [COLOR NIGHT REC] are not available.
- If you record motion pictures in a dark place, recorded motion pictures may be darker than those in [NORMAL SHOOTING].

-
- When recording in [SLOW MOTION], use a microSD card with an SD Speed Class Rating of 6 or higher.

[LOOP RECORDING]

No matter how long you record, you can only record motion pictures for the last 1 hour to microSD card.

- **Fully charge the battery before using this function.**
- Once you start recording, the motion picture will be recorded and divided approximately every 2 minutes.
- When the recording time exceeds 1 hour (approximate), only the last 1 hour (approximate) part up to the end of the recording will be saved. The part before the 1 hour part will be deleted.
- During the recording,  flashes and the approximate remaining recordable time indication disappears.
- The elapsed recording time is not displayed.

-
- [PIXELS / FRAME RATE] is set to [1280×720/30p].
 - When the approximate remaining recordable time is indicated as less than 1 hour (the indication flashes in red), [LOOP RECORDING] is not possible.

[PICTURE RECORDING]

Recording still pictures.

- If you record still pictures in a dark place, recorded still pictures may be darker than motion pictures.

Recording functions of menus

(When setting a menu item on this unit)

Press the joystick to select the menu.

[RECORD SETUP] → desired menu item

(When setting a menu item on the "Image App")

- Set up a Wi-Fi connection between this unit and a smartphone, and perform remote operation. (→ 43)

On the "Image App" screen, tap  and set the menu item.

[Record Setup] → desired menu item

- For more information, refer to the [Help] in the "Image App" menu.

[RECORDING MODE]

Please refer to page 30.

[PIXELS / FRAME RATE]

You can switch the image quality of the motion pictures you record. Available [PIXELS / FRAME RATE] differs depending on the [RECORDING MODE] setting.

- When [RECORDING MODE] is set to [NORMAL SHOOTING] (→ 30):

The greater the number is, the higher the image quality is. However, the file size also becomes greater. (→ 89)

[3840×2160/30p]*	Records 4K motion pictures.
[1920×1080/60p]/ [1920×1080/30p]	Records motion pictures in full high-definition image quality.
[1280×720/60p]/ [1280×720/30p]	Records motion pictures with an image quality that enables you to upload them on the Internet in higher image quality.
[848×480/30p]	Records motion pictures with an image quality that enables you to upload them on the Internet faster.

* When recording in [3840×2160/30p], use a microSD card with an SD Speed Class Rating of 10 or higher.

- When [RECORDING MODE] is set to [SLOW MOTION] (→ 30):

[1920×1080/60fps]	Plays back at 1/2 times normal speed. (actual playback time is twice as long as the recorded time)
[1280×720/120fps]	Plays back at 1/4 times normal speed. (actual playback time is four times as long as the recorded time)
[848×480/240fps]	Plays back at 1/8 times normal speed. (actual playback time is eight times as long as the recorded time)

[PICTURE SIZE]

The higher the number of pixels, the higher the clarity of the picture when printing.

- This unit can record still pictures of the 16:9 aspect ratio.
- Set [RECORDING MODE] to [PICTURE RECORDING]. (→ 30)

[16.3M]/[8.3M]/[5.3M]

- [16.3M] is not available when the [ANGLE OF VIEW] is set to [STANDARD].
- [8.3M] is not available when the [IMAGE STABILIZATION] is set to [ON].
- If you set [ANGLE OF VIEW] to [STANDARD] when [16.3M] is set, [PICTURE SIZE] will switch to [8.3M].
- If you set [IMAGE STABILIZATION] to [ON] when [8.3M] is set, [PICTURE SIZE] will switch to [5.3M].
- The recording will become longer depending on the recording pixels.
- The edges of still pictures recorded on this unit with a 16:9 aspect ratio may be cut at printing. Check the printer or photo studio before printing.

[ANGLE OF VIEW]

You can switch the angle of view mode.

[WIDE]: Displays subjects from a wider range on the screen.

[STANDARD]: Standard screen

- This item cannot be set in the following cases:
 - During recording
 - When [RECORDING MODE] is set to [SLOW MOTION]
 - When [PIXELS / FRAME RATE] is set to [3840×2160/30p]
- If you set the [ANGLE OF VIEW] to [STANDARD] and set [IMAGE STABILIZATION] to [ON], the angle of view becomes narrower.
- The options are not displayed as menu items on the "Image App". Tap the angle of view mode on the recording screen to switch the setting. (→ 47)

[Delay-Start REC]

You can start recording a motion picture approximately 3 seconds after pressing the recording start/stop button.

- Delay appears on the screen.
- The elapsed recording time (→ 27) starts counting time as recording starts.
- This item cannot be set in [PICTURE RECORDING].

[INTERVAL REC MODE]

This is for recording still pictures at a set interval.

- Set [RECORDING MODE] to [PICTURE RECORDING]. (→ 30)

1 Press the joystick to select the menu.

[RECORD SETUP] → [INTERVAL REC MODE] → desired setting

[60 SECONDS]/[30 SECONDS]/[10 SECONDS]/[5 SECONDS]/[3 SECONDS]/[OFF]

- If you set this item to [OFF], normal still pictures will be recorded.

2 Press the recording start/stop button to start recording.

- Still pictures will be recorded at specified intervals.
- Once recording starts, the LCD monitor will turn off approximately 30 seconds later. To turn it on again, operate the joystick.

3 Press the recording start/stop button again to pause recording.

[LEVEL SHOT]

This is for automatically correcting the horizontal tilt of an image.

[STRONG]/[NORMAL]/[OFF]

- [LEVEL SHOT] operates when starting to record a motion picture or still picture or when starting to perform a live broadcast.
- [LEVEL SHOT] will not work in the following cases:
 - When the tilt of the camera is large
 - When motion is continuous
- [LEVEL SHOT] cannot be set in the following cases:
 - When [RECORDING MODE] is set to [SLOW MOTION]
 - When the [PIXELS / FRAME RATE] is set to [3840×2160/30p], [1920×1080/60p] or [1280×720/60p].
 - When [ANGLE OF VIEW] is set to [WIDE].
 - When [COLOR NIGHT REC] is set to [ON]

[IMAGE STABILIZATION]

This is for reducing camera shakes.

- [IMAGE STABILIZATION] cannot be set in the following cases:
 - When [RECORDING MODE] is set to [SLOW MOTION]
 - When the [PIXELS / FRAME RATE] is set to [3840×2160/30p], [1920×1080/60p] or [1280×720/60p].
 - When [ANGLE OF VIEW] is set to [WIDE].
 - When [LEVEL SHOT] is set to [NORMAL]
 - When [COLOR NIGHT REC] is set to [ON]
- The compensation may not be as effective in an extremely dark place or when shakes are too strong.
- This may not work correctly when this unit is at rest.

[WHITE BALANCE]







When the color tone looks unnatural due to a light source, etc., adjust the White Balance manually.

- You cannot change the setting when [COLOR NIGHT REC] is set to [ON].

1 Press the joystick to select the menu.

[RECORD SETUP] → [WHITE BALANCE] → [PRESET]

2 Move the joystick right or left to change the Preset mode.

Preset mode	Recording conditions
 (Auto White Balance)	Automatic White Balance adjustment
 (Daylight)	Outdoors under a clear sky
 (Cloudy)	Outdoors under cloudy sky
 (Indoor 1)	Incandescent light, video lights like in the studio, etc.
 (Indoor 2)	Color fluorescent lamps, sodium lamps in gymnasiums etc.
 (User)	The color tone set in [CUSTOM]

3 Press the joystick to enter the setting.

- Press the recording start/stop button to complete the setting.

■ To set the White Balance manually

- When recording under mercury vapor lamps, sodium lamps, spotlights in a theater, etc. or when recording a sunset, sunrise, etc., set the color tone in [CUSTOM]
- If you set the White Balance to [CUSTOM], the preset mode will be automatically set to  (User).
- When you change the recording condition, change the setting again.

1 Press the joystick to select the menu.

[RECORD SETUP] → [WHITE BALANCE] → [CUSTOM]

2 Fill the screen with a white subject, select [SET], then press the joystick.

- A message informing you that the White Balance has been set will be displayed, and the setting will be saved.
- Press the recording start/stop button to complete the setting.

[BACKLIGHT COMPENS.]

This makes the image brighter to prevent darkening of a backlit subject.

- It cannot be set when the [COLOR NIGHT REC] is set to [ON].

[COLOR NIGHT REC]

This function allows you to record color images in very low light situations.

- It cannot be set when [RECORDING MODE] is set to [SLOW MOTION].
- Recorded image is seen as if frames were missed.
- If set in a bright place, the screen may become washed out for a while.
- Bright dots that are usually invisible may be seen, but this is not a malfunction.
- [WHITE BALANCE] setting cannot be changed while this function is activated.

[MICROPHONE]

You can set whether or not to record sounds during recording.

[ON]: Records sounds.

[OFF]: Does not record sounds.

- This item cannot be set when the [RECORDING MODE] is set to [SLOW MOTION] or [PICTURE RECORDING].

[WIND CUT]

This reduces noise of the wind picked up by the built-in microphone.

- This function's default setting is [OFF].
- It may not reduce noise of the wind sufficiently, depending on the recording situation.
- This function is not available in [PICTURE RECORDING] or when [MICROPHONE] is set to [OFF].

[Shooting guidelines]

You can check if the image is level on the recording screen of the "Image App". The function can also be used to estimate the balance of the composition.

- Use the "Image App". This function cannot be enabled on this unit.
- The guidelines do not affect the actual images that will be recorded.
- The guidelines are not displayed on the screen of this unit.

[SHTR SOUND]

You can add a sound when recording still pictures.

- Set [RECORDING MODE] to [PICTURE RECORDING]. (→ 30)

[HIGH]/[LOW]/[OFF]

Playback using a smartphone

Motion pictures or still pictures stored in this unit are played back with the smartphone.

- For more information, refer to the [Help] in the "Image App" menu.

Preparation:

- 1 **Install the smartphone application "Image App" on your smartphone. (→ 56)**
- 2 **Set up a Wi-Fi connection between this unit and the smartphone, and perform remote operation. (→ 43)**

1 Tap .

- The thumbnails of motion pictures or still pictures recorded on this unit will be displayed.

2 Tap ().

- To play back a motion picture, tap ; to play back a still picture, tap .

3 Tap the thumbnail of motion picture or still picture you want to play back.

- The playback screen will be displayed.
- If you have tapped a still picture, you can play back the previous or next picture by dragging (swiping) the screen left or right.

4 (For playing back motion pictures)

Tap the playback icon on the screen to play back motion pictures.

- Tapping or dragging the slide bar will start playback from the desired position of a motion picture file.

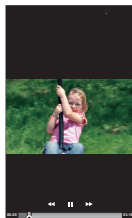

A

A Slide bar

■ To delete motion pictures/still pictures stored in this unit or to copy them to the smartphone

Delete or copy using ["Picture Share" settings].

Set [Trash (Delete)] or [Save to smartPH] to the picture share tab, tap and hold the thumbnail of the file you want to delete or copy, and drag and drop the thumbnail to the tab.

- For information on how to make the setting, refer to [Help] in the "Image App".

- Copying motion picture files stored in this unit to a smartphone may not be possible depending on the smartphone you are using.
- If motion picture files have been copied to a smartphone, the thumbnails for them will be displayed, but playing them back may not be possible depending on the smartphone you are using.
- Refer to "[Split & Delete]" and "[Delete all]" for information on deleting files. (→ 38)
- The thumbnail size of long files and the files on which you performed [Split & Delete] may differ from that of other motion pictures.

Using playback functions on a smartphone

- Set up a Wi-Fi connection between this unit and the smartphone, and perform remote operation. (→ 43)

Tap  →  → items in [CAMERA FUNCTION] on the “Image App” screen.

- For more information, refer to the [Help] in the “Image App” menu.

[Create highlights]

Part that was recognized as full of motion or clearly recorded is extracted from multiple motion pictures, and it can be stored in the microSD card in this unit and a smartphone (using Wi-Fi features) with effects and music added.

- You can also set music data (only one track) stored in the smartphone as background music.
- You can also set an image stored in the smartphone as a title image.
- You cannot save motion pictures recorded in different [PIXELS / FRAME RATE] as a single Highlight Playback file.
- You cannot use motion pictures recorded in [SLOW MOTION] as Highlight Playback files.

[SCENE PROTECT]

Motion/still pictures can be protected so that they are not deleted by mistake.

(Even if you protect some motion/still pictures, formatting the microSD card will delete them.)

[Split & Delete]

This splits a motion picture into two and deletes the unnecessary part before or after the split point.

- It may not be possible to divide and delete files with a short recording time.

[Play on TV]

Using a smartphone, you can play back files stored in this unit on a DLNA-compatible TV.

- Set up a Wi-Fi connection to this unit in [Wireless Network Mode].
- Please also refer to “Playback on a DLNA-compatible TV”. (→ 54)

[Delete all]

This deletes all files at once.

When MP4 thumbnails are displayed, only MP4 files are deleted all at once; when JPEG thumbnails are displayed, only JPEG files are deleted all at once.

Playing back on a TV

If your TV is equipped with an SD card slot that supports the playback of MP4 files, you can play back the files of motion pictures recorded with this unit by inserting the card into the slot. Please note that to play back motion pictures recorded with [PIXELS / FRAME RATE] set to [3840×2160/30p], you need a TV equipped with an SD card slot that supports 4K motion pictures.

- **When inserting a microSD card into the SD card slot of a TV, always attach the microSD card to its dedicated adaptor.**
- Please also refer to the operating instructions for the TV.

Playing back on a PC

To play back the files of motion pictures recorded with this unit on a PC, use HD Writer WE 2.0. For details on HD Writer WE 2.0, refer to page [75](#).

If you connect this unit and a PC, you can copy motion pictures/still pictures stored in this unit to the PC.

For details, refer to page [72](#).

Wi-Fi[®] function

■ Use this unit as a wireless LAN device

When using equipment or computer systems that require more reliable security than wireless LAN devices, ensure that the appropriate measures are taken for safety designs and defects for the systems used. Panasonic will not take any responsibility for any damage that arises when using this unit for any purpose other than as a wireless LAN device.

■ Use of the Wi-Fi function of this unit is presumed to be in countries where this unit is sold

There is the risk that this unit violates the radiowave regulations if used in countries other than those where this unit is sold, and Panasonic takes no responsibility for any violations.

■ There is the risk that data sent and received via radio waves may be intercepted

Please note that there is the risk that data sent and received via radio waves may be intercepted by a third party.

■ Do not use this unit in areas with magnetic fields, static electricity or interference

- Do not use this unit in areas with magnetic fields, static electricity or interference, such as near microwave ovens. Radio waves may not reach this unit.
- Using this unit near devices such as cordless telephones or any other wireless LAN device that use the 2.4 GHz radio wave band may cause a decrease in performance in both devices.

■ Do not connect to the wireless network you are not authorized to use

When this unit utilizes its Wi-Fi function, wireless networks will be searched automatically. When this happens, wireless networks that you are not authorized to use (SSID*) may be displayed, however do not attempt to connect to the network as it may be considered as unauthorized access.

* SSID refers to the name of device that is used to identify a network over a wireless LAN connection. If the SSID matches for both devices, transmission is possible.

■ Before use

To use a Wi-Fi function with this unit, you need a wireless access point or destination device equipped with a wireless LAN function.

For compatible access points, see the following support site.

http://panasonic.jp/support/global/cs/e_cam/index.html (This Site is English only.)

- For the operations and settings of your device such as the smartphone, please read the operating instructions of the device.

■ This unit is NFC-compatible

Using the NFC (Near Field Communication) function, you can easily transfer data necessary for a Wi-Fi connection between this unit and the smartphone.

This function can be used with the NFC compatible device with Android™ (OS version 2.3.3 or later). (Except for some models)

■ This unit is WPS-compatible

WPS (Wi-Fi Protected Setup™) is a function that allows you to easily set up a connection with a wireless LAN device and make security-related settings.

-
- This unit cannot be used to connect to a public wireless LAN connection.
 - Use a IEEE802.11b, IEEE802.11g or IEEE802.11n compatible device when using a wireless access point.
 - This unit uses the 2.4 GHz frequency band. You cannot establish a wireless LAN connection using the 5 GHz frequency band.
 - When using a wireless access point, we strongly recommend that you set a encryption to maintain information security.
 - Before sending motion pictures or still pictures, we recommend you charge the battery fully.
 - When sending data on a mobile network or tethering, high packet communication fees may be incurred depending on the details of your contract.
 - This unit may not connect to an access point depending on the radio wave condition.
 - When using the Wi-Fi function, do not cover the Wi-Fi transmitter with your hand. (→ 10)
 - When the battery indicator is flashing red, the connection with other equipment may not start or the connection may be disrupted.
 - The Wi-Fi transmitter may become warm when using the Wi-Fi function; however this is not a sign of a malfunction. (→ 10)

Using Wi-Fi modes

This unit offers the following Wi-Fi functions.

Change to a Wi-Fi mode that matches the Wi-Fi function you want to use.

Wi-Fi function	Available Wi-Fi modes	Description
Remote operation	[Smartphone Direct Connect]/ [Wireless Network Mode]	You can perform recording and playback operations on your smartphone.
Live broadcasting	[LIVE CAST]	You can broadcast motion pictures of this unit live by setting up a link between the "LUMIX CLUB" and USTREAM.
Playback on TV	[Wireless Network Mode]	Connecting this unit to a DLNA-compatible TV via Wi-Fi, you can play back motion pictures and still pictures on the TV.

Changing the Wi-Fi mode

1 Press the joystick to select the menu.

[Wi-Fi SETUP] → [Wi-Fi MODE]

2 Select the Wi-Fi mode, press the joystick, then start up the Wi-Fi mode.

- A Wi-Fi mode icon will be displayed on the screen. (→ 57)
-
- If you move and hold the joystick left on the recording screen, the [Wi-Fi MODE] setting screen will be displayed. The screen returns to the recording screen after you make the setting.
 - If you move the joystick left on the recording screen, you can start up the Wi-Fi mode you set in [Wi-Fi MODE].
 - [Wi-Fi MODE] cannot be set in "Image App".

Remote operation

Using a smartphone, you can perform record/playback operations from a remote location or upload motion pictures and still pictures recorded in this unit on SNS (Social Networking Service).

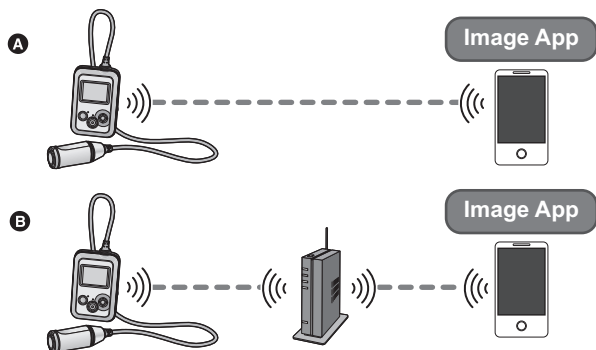

- A** When connecting directly to a smartphone
- B** When connecting to a wireless access point

- You need to turn on the Wi-Fi function of your smartphone.
- Do not remove the microSD card during remote operations.

- Refer to [Help] in the "Image App" menu about how to operate.

Caution:

Be sure to pay special attention to the privacy, the Portrait rights, etc. of the subject when you use this function. Use at your own risk.

Preparations before using remote operation

- 1 Install the smartphone application “Image App” on your smartphone. (→ 56)
 - 2 Check if the smartphone is an Android (NFC-compatible), Android (non-NFC-compatible), or iOS device.
- If your smartphone is NFC-compatible, a message asking you to touch the NFC mark on the device will be displayed when starting up the “Image App”.

Setting up a direct Wi-Fi connection between this unit and a smartphone

- This operation is not possible while this unit is recording.
- Proceed to “Using remote operation with a direct connection ([Smartphone Direct Connect])”.

Setting up a Wi-Fi connection via a wireless access point

- 1 Check if the wireless access point is compatible with IEEE802.11b/g/n.
 - 2 Set up a Wi-Fi connection between this unit and the wireless access point.*
- [WPS Connection] (→ 59)
 - Searching for wireless access points to set up a connection (→ 60)
 - Setting up a connection manually (→ 62)
- * This operation is not possible while this unit is recording.

When the Wi-Fi connection is complete, proceed to “Using remote operation with a wireless access point connection ([Wireless Network Mode])”. (→ 46)

Using remote operation with a direct connection ([Smartphone Direct Connect])

■ If the device is Android (NFC-compatible)

- Set the NFC function of the smartphone to on.

1 Start up the smartphone application “Image App”.

2 Touch the smartphone on of this unit.

- Touch the NFC mark while a message asking you to touch the NFC mark on the device is displayed on the smartphone screen.
- If this is the first time the smartphone is connecting to this unit, the message is displayed on the screen of this unit. Select [YES], press the joystick, and then touch the smartphone on  of this unit again.
- If the unit is not recognized even when touching the smartphone, change positions and try again.
- You cannot set up a connection when recording an image with this unit or the menu screen is displayed.
- When the connection is complete, images of this unit is displayed on the smartphone screen.

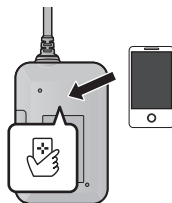

If you touch the second smartphone when this unit has already been connected to the first one

The remote operation with the first smartphone that has been connected to this unit will be cut off, and the newly touched smartphone will be connected.

- The connection cannot be established while this unit is recording or copying a file to the smartphone during remote operations.

■ If the device is Android (non-NFC-compatible) or iOS

1 Set [Wi-Fi MODE] to [Smartphone Direct Connect]. (→ 42)

- Confirm that the Wi-Fi mode has started up in [Smartphone Direct Connect].

2 On the smartphone, select the SSID displayed on this unit from the Wi-Fi setup menu.

3 (When connecting for the first time)

Enter the Password displayed on this unit's screen on the smartphone.

- You are not required to enter the Password from the second time you use the connection.

Confirming that the Wi-Fi connection is complete

–  is displayed on the screen

4 Start up the smartphone application "Image App".

- When the connection is complete, images of this unit is displayed on the smartphone screen.

To exit [Smartphone Direct Connect]:

Move the joystick left.

- The message is displayed. Select [YES], then press the joystick to exit.

■ If the connection between this unit and the smartphone has been interrupted

The connection between this unit and the smartphone may be interrupted temporarily depending on radio wave conditions.

An attempt to reconnect is made automatically when radio wave interference, etc. is eliminated.

Please note the following.

- If you have been recording a motion picture or recording in the [INTERVAL REC MODE], the recording will continue even after the connection interruption. To stop the recording, operate this unit.
- If "Image App" has been used in Playback mode, if reconnecting takes 30 seconds or more, this unit turns to Recording mode and "Image App" will run in Recording mode after the connection is restored.
- If this unit has been deleting files, performing [Split & Delete] or formatting, the operation will continue even after the connection interruption.
Do not remove the microSD card while the Access lamp of this unit lights.

-
- If you touch an NFC-compatible smartphone on this unit, you can register up to five smartphones. When the number exceeds five, registrations will be deleted, starting from the oldest touched one.
 - Please refer the instructions for the device you are using for information on how to set up and use a NFC-compatible smartphone.
 - If this unit and the smartphone are too far apart from each other when making the settings, the connection may not be established. Move the devices closer to each other before making the settings.
 - Transmission speed may decrease, or may not be usable depending on the environment it is used in.

Using remote operation with a wireless access point connection ([Wireless Network Mode])

■ If the device is Android (NFC-compatible)

- Set the NFC function of the smartphone to on.

1 Connect the smartphone to a wireless access point.

- When you connect using NFC for the first time, please make connection of this unit and a wireless access point. (→ 59)
- You need to connect this unit and a smartphone to the same wireless access point via Wi-Fi.

2 Start up the smartphone application “Image App”.

3 Touch the smartphone on of this unit.

- Touch the NFC mark while a message asking you to touch the NFC mark on the device is displayed on the smartphone screen.
- If this is the first time the smartphone is connecting to this unit, the message is displayed on the screen of this unit. Select [YES], press the joystick, and then touch the smartphone on  of this unit again.
- If the unit is not recognized even when touching the smartphone, change positions and try again.
- You cannot set up a connection when recording an image with this unit or the menu screen is displayed.
- When the connection is complete, the thumbnails of motion pictures or still pictures recorded on this unit will be displayed on the smartphone screen.

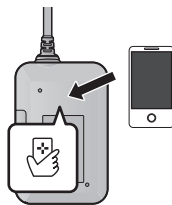

If you touch the second smartphone when this unit has already been connected to the first one

The remote operation with the first smartphone that has been connected to this unit will be cut off, and the newly touched smartphone will be connected.

- The connection cannot be established while this unit is recording or copying a file to the smartphone during remote operations.

■ If the device is Android (non-NFC-compatible) or iOS

1 Set [Wi-Fi MODE] to [Wireless Network Mode]. (→ 42)

- Confirm that the Wi-Fi mode has started up in [Wireless Network Mode].

2 Connect the smartphone to a wireless access point.

- You need to connect this unit and a smartphone to the same wireless access point via Wi-Fi.

3 Start up the smartphone application “Image App”.

- When the connection is complete, the thumbnails of motion pictures or still pictures recorded on this unit will be displayed on the smartphone screen.

To exit [Wireless Network Mode]:



Move the joystick left.

- The message is displayed. Select [YES], then press the joystick to exit.

-
- If you touch an NFC-compatible smartphone on this unit, you can register up to five smartphones. When the number exceeds five, registrations will be deleted, starting from the oldest touched one.
 - Please refer the instructions for the device you are using for information on how to set up and use a NFC-compatible smartphone.

Screen display during remote operations

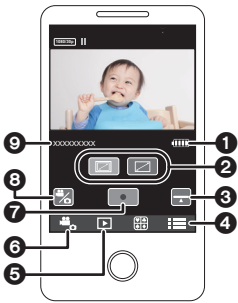
Examples of smartphone screens.

Recording screen	
	<ol style="list-style-type: none">1 Remaining battery power of this unit2 Angle of view mode3 Level Shot Function button4 Menu display5 Playback mode selector6 Recording mode selector7 Recording start/stop8 Motion Picture/Still Picture toggle button9 Name of the connected device
Playback screen	
	<ol style="list-style-type: none">1 Camera function2 Number of motion picture/still picture scenes3 Remaining battery power of this unit4 Delete5 Upload6 Copy7 Name of the connected device8 Information display for the motion picture/still picture

- Depending on your OS or the version of the smartphone application "Image App", the screens may differ from the ones above.

Live broadcasting

You can broadcast motion pictures of this unit live by setting up a link between the “LUMIX CLUB” and USTREAM.

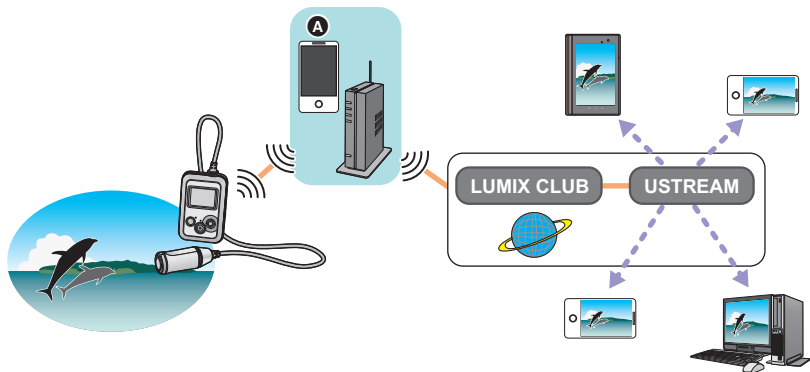

- A** You can also broadcast motion pictures live by connecting this unit and a smartphone that supports tethering.

- If [CLOCK SET] (→ 17) is not set correctly, live broadcasting is not possible.
- Check your contract details carefully, as smartphone and internet contract details may result in high communication charges being incurred, or a limit placed on communication traffic.

Caution:

Be sure to pay special attention to the privacy, the Portrait rights, etc. of the subject when you use this function. Use at your own risk.

Preparations before broadcasting live

- 1 (When connecting to a wireless access point)
Check if the wireless access point is compatible with IEEE802.11b/g/n.
(For tethering connection)
Check if your smartphone is compatible with the tethering function.
 - For information on how to set up the tethering function, refer to the operating instructions for your smartphone.
- 2 **Acquire a USTREAM ID/Password/Program.**
 - Acquire a USTREAM ID/Password/Program using a smartphone or a PC.

About the USTREAM

With this video-sharing website, you can stream and watch motion pictures this unit is broadcasting.

Refer to the USTREAM site for details.

<http://www.ustream.tv/>

- Operation cannot be guaranteed on future USTREAM services and updates. The service content and screens which can be used are subject to change without prior notice.
(This service is current as of April 2014)
- 3 **Acquire a “LUMIX CLUB” Login ID/Password.**
 - When you connect this unit to a wireless access point (→ 59), you can acquire a “LUMIX CLUB” Login ID/Password with this unit. (→ 68)
 - 4 **Use linked services with “LUMIX CLUB”.**

To use the live broadcasting, access following website.

<http://lumixclub.panasonic.net/eng/c/>

- Log in to the “LUMIX CLUB” and register/set up the USTREAM on WEB service link setup.
- 5 **Set up a Wi-Fi connection between this unit and the wireless access point.***
 - [WPS Connection] (→ 59)
 - Searching for wireless access points to set up a connection (→ 60)
 - Setting up a connection manually (→ 62)
- * This operation is not possible while this unit is recording.

When the Wi-Fi connection is complete, proceed to “Broadcasting live”.

Broadcasting live

Set [Wi-Fi MODE] to [LIVE CAST]. (→ 42)

- Confirm that the Wi-Fi mode has started up in [LIVE CAST].
- If a "LUMIX CLUB" Login ID and Password has not been registered to this unit yet, enter them according to the screen.
- By selecting [Change AP] and pressing the joystick, you can switch the wireless access point to another one that has been registered to this unit.
- When the connection is made correctly, the screen of this unit switches to [LIVE CAST].

■ To send e-mails

You can send e-mails containing such information as the USTREAM channel name or the scheduled broadcast date.

- This unit can only set the scheduled broadcast date. (→ 52)
For other settings, set them on the "LUMIX CLUB".
- On the "LUMIX CLUB", register the destination addresses of the e-mail in advance.

1 Press the joystick to display the [LIVE CAST] menu.

2 Select [Send E-mail], then press the joystick.

■ To start the live broadcast

1 Press the joystick to display the [LIVE CAST] menu.

2 Select [Start Live Cast], then press the joystick.

- The Wi-Fi mode icon will change to  (→ 51)
- If you press the recording start/stop button, you can simultaneously record the broadcast to this unit.

■ To stop the live broadcast

1 Press the joystick to display the [LIVE CAST] menu.

2 Select [Stop Live Cast], then press the joystick.



- The Wi-Fi mode icon will change to  (→ 51)

To exit [LIVE CAST]:

Move the joystick left.

- The message is displayed. Select [YES], then press the joystick to exit.

■ Screen displays during a live broadcast

	Wi-Fi mode icon
1h23m	Elapsed time of the live broadcast ● This is displayed during a live broadcast.
	Microphone setting ● The indication appears when [Microphone OFF] is set.



- In [LIVE CAST], [RECORDING MODE] will be set to [NORMAL SHOOTING] and [PIXELS / FRAME RATE] will be set to [1920×1080/30p] even when they are set to the following options:
 - When [RECORDING MODE] is set to [SLOW MOTION], [LOOP RECORDING] or [PICTURE RECORDING]
 - When [PIXELS / FRAME RATE] is set to [3840×2160/30p], [1920×1080/60p] or [1280×720/60p]
- If this unit is on the e-mail sender block list of destination devices or if their firewall setting is enabled, the Wi-Fi function may not work correctly when you send an e-mail. If this occurs, check the network settings.
- Depending on the e-mail rejection or firewall setting at the destination address, e-mails may not be delivered.
- In the following cases, live broadcasting is not available.
 - When the clock setting is out of sync
 - When two cameras simultaneously perform live broadcasts at the same account (The camera that has started the broadcast first will be disconnected from the broadcast)
- When the live broadcast cannot be watched on a USTREAM application for TVs or smartphones, cancel the Password for the Program, and restart the broadcast.
- Image content may be leaked to third parties depending on the USTREAM image publication method settings. Set the publication range and Password using USTREAM if required.
- If a live broadcast motion picture is saved on the USTREAM side, the file name will be the same as the channel name.
- The live broadcast stops as the elapsed broadcast time exceeds 8 hours 30 minutes, and then it starts again. (A separate file will be saved on the USTREAM side.)

Configuring the live broadcast settings

■ Setting the audio of live broadcasts

You can set the audio output for live broadcasts on this unit.

- 1 Press the joystick to display the [LIVE CAST] menu.
- 2 Select [Microphone OFF] or [Microphone ON], then press the joystick.

[Microphone OFF]: Sound is not output during live broadcasts.

[Microphone ON]: Sound is output during live broadcasts.

- If you broadcast and record a motion picture simultaneously when this item is set to [Microphone OFF], the sound of the broadcast will not be recorded.

■ Making detailed settings

You can make detailed settings such as the e-mail settings or the image quality setting.

- You can also make detailed settings from the "Image App" menu. (→ 66)

- 1 Press the joystick to display the [LIVE CAST] menu.
- 2 Select [Details], then press the joystick.

Items	Contents
[E-MAIL SETUP]	You can make the delivery setting of a broadcast notification e-mail and the setting for the scheduled time and date of the broadcast indicated in the e-mail.
[SAVE VIDEO IN USTREAM]	Live motion pictures are saved on USTREAM.
[IMAGE QUALITY]	This sets the image quality of motion pictures that will be broadcast. (→ 53)
[RECORD SETUP]	You can set the [PIXELS / FRAME RATE] to be used when broadcasting and recording a motion picture simultaneously. (→ 53)

To configure the e-mail delivery settings

- Select [Details] in the [LIVE CAST] menu.
- 1 Move the joystick to select [E-MAIL SETUP], then press the joystick.
 - 2 Select [ON] or [OFF], then press the joystick.

[ON]: Enables e-mailing.

[OFF]: Disables e-mailing.

- 3 (When [ON] is selected)
To set the scheduled broadcast date.

[AUTO]: Sets the broadcast date to the date you send an e-mail.

[MANUAL]: Allows you to set the desired time and date.
• The setting method is the same as [CLOCK SET]. (→ 17)

To save in USTREAM

- Select [Details] in the [LIVE CAST] menu.
- 1 Move the joystick to select [SAVE VIDEO IN USTREAM], then press the joystick.
 - 2 Select [ON] or [OFF], then press the joystick.

[ON]: Live motion pictures are saved on USTREAM.

[OFF]: Select this option not to save on USTREAM.

To set the image quality

- Select [Details] in the [LIVE CAST] menu. (→ 52)

- 1 Move the joystick to select [IMAGE QUALITY], then press the joystick.
- 2 Select the desired image quality, then press the joystick.

Image Quality	Resolution	Frame rate	Recommended optimal speed (upstream)
[AUTO]	Use this option to check the image quality and automatically set the item.		
[HIGH]	1280×720	5 to 30 fps (5 to 10 fps)	3 Mbps or higher
[MEDIUM]	640×360	5 to 30 fps (5 to 10 fps)	1 Mbps or higher
[LOW]	320×176	5 to 30 fps (5 to 15 fps)	500 kbps or higher

- Frame rate in parentheses are when recorded simultaneously.
- Depending on the line status of the broadband line, mobile router (tethering), etc. to which this unit is connected, the image and sound may be interrupted or the connection may be lost. Set the image quality on this unit by referring to the recommended optimal speeds (upstream) above.
- For information on the optimal speed, contact your service provider, etc.
- If the image being broadcast appears as if frames were dropped or stops when [AUTO] is set, change [IMAGE QUALITY] according to your environment.
- If the selected image quality has an image quality higher than the one you are using, images will appear as if the frame rate is low.
- Operation cannot be guaranteed for all devices.
- Even with a broadband line, the recommended optimal speed may not be reached depending on your environment.
- Narrowband lines such as analog modems cannot be used.
- If the line for the smartphone is switched, communication may be interrupted. In that case, connect again.

To set the image quality of a motion picture you simultaneously broadcast and record

- Select [Details] in the [LIVE CAST] menu. (→ 52)

- 1 Move the joystick to select [RECORD SETUP], then press the joystick.
- 2 Select the desired pixels/frame rate, then press the joystick.

[1920×1080/30p]/[1280×720/30p]/[848×480/30p]

- You cannot change the live broadcast settings during recording or a live broadcast.

Playback on a DLNA-compatible TV

Connecting this unit to a DLNA-compatible TV via Wi-Fi, you can play back motion pictures and still pictures on the TV.

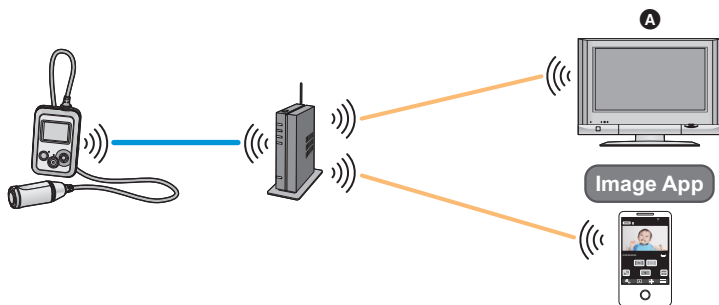

A DLNA-compatible TV

Preparations before using Playback on a DLNA-compatible TV

- 1 Check if the wireless access point is compatible with IEEE802.11b/g/n.
- 2 Check if the TV is DLNA-compatible.
- 3 Set up a Wi-Fi connection between this unit and the wireless access point.*

- [WPS Connection] (→ 59)
- Searching for wireless access points to set up a connection (→ 60)
- Setting up a connection manually (→ 62)

* This operation is not possible while this unit is recording.

When the Wi-Fi connection is complete, proceed to "Playing back on a DLNA-compatible TV".

Playing back on a DLNA-compatible TV

You can play back the motion pictures and still pictures recorded in this unit on a TV.

- The following motion pictures can be played back:

[RECORDING MODE]	[PIXELS / FRAME RATE]
[NORMAL SHOOTING]	[1280×720/30p]/[848×480/30p]
[SLOW MOTION]	[1280×720/120fps]/[848×480/240fps]
[LOOP RECORDING]	—

- **Connect a TV to a wireless access point**

You need to connect this unit and a TV to the same wireless access point via Wi-Fi.

1 Set [Wi-Fi MODE] to [Wireless Network Mode]. (→ 42)

- Confirm that the Wi-Fi mode has started up in [Wireless Network Mode].

2 Select this unit (SSID) on the TV.

3 Perform playback operations with the TV remote control.

- Playback operations may differ depending on the TV in use.
- The following operations can be performed if a color button is pushed.
Blue/Red: Skip playback
- Fast forward/Fast rewind playback cannot be performed.

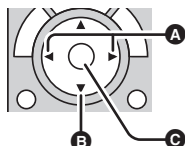

(Examples of operations during motion picture playback)

- **A** Skip playback
- **B** Stop
- **C** Playback/Pause

To exit [Wireless Network Mode]:

Move the joystick left.

- The message is displayed. Select [YES], then press the joystick to exit.

- It may take time to start playing back.
- The file in this unit cannot be saved on a DLNA-compatible device.
- Images or sound may be interrupted or the line may be disconnected.
- When playing back on a TV, the image being played back is not displayed on the “Image App” screen.
- You cannot playback motion pictures recorded with [PIXELS / FRAME RATE] set to any of the following settings:



[RECORDING MODE]	[PIXELS / FRAME RATE]
[NORMAL SHOOTING]	[3840×2160/30p]/[1920×1080/60p]/[1920×1080/30p]/ [1280×720/60p]
[SLOW MOTION]	[1920×1080/60fps]

- The files may not be played back smoothly depending on your environment, such as the network condition.
- An access point connection cannot be started during motion picture recording.
- To control this unit from a smartphone, you need to connect both the DLNA device and the smartphone to the same network.
- For compatible devices, see the following support site.
http://panasonic.jp/support/global/cs/fe_cam/index.html
(This Site is English only.)

Install the “Image App”

About the “Image App”

The “Image App” is an application provided by Panasonic.

	For Android apps	For iOS apps
OS	Android 2.3.3 or later*	iOS 5.0 or later*
Installation procedure	<ol style="list-style-type: none"> 1 Connect your Android device to a network. 2 Select “Google Play™ Store”. 3 Enter “Panasonic Image App” into the search box. 4 Select “Panasonic Image App” and install it. <ul style="list-style-type: none"> • The icon will be added to the menu. 	<ol style="list-style-type: none"> 1 Connect your iOS device to a network. 2 Select “App StoreSM”. 3 Enter “Panasonic Image App” into the search box. 4 Select “Panasonic Image App” and install it. <ul style="list-style-type: none"> • The icon will be added to the menu. 

* The supported OS versions are current as of April 2014 and subject to change.

- Use the latest version.
- The service may not be able to be used properly depending on the type of smartphone being used. For information on the “Image App”, check the support website below.
http://panasonic.jp/support/global/cs/fe_cam/index.html
 (This Site is English only.)
- When downloading the app on a mobile network, high packet communication fees may be incurred depending on the details of your contract.

Setting Up a Wi-Fi Connection

To use the Wi-Fi function, connect this unit to a wireless access point or smartphone via Wi-Fi.

■ About the connection status icon when connected to Wi-Fi



A Wi-Fi mode icon

- The displayed icon will change according to the Wi-Fi mode.

 : [Smartphone Direct Connect]

 : [LIVE CAST]

 : [Wireless Network Mode]

B The connection status icon





When directly connected:

 connected to Wi-Fi /  not connected to Wi-Fi

- The icon disappears when you turn off a Wi-Fi mode.

When connected to wireless access point:

 connected to Wi-Fi /  not connected to Wi-Fi

- The display will change as follows according to the radio wave intensity:  (Weak) →  →  →  (Strong).
- The icon disappears when you turn off a Wi-Fi mode.

Setting up a direct connection to a smartphone

Please refer to page 44.

Setting up with [Wi-Fi Easy Setup]

When you set up a Wi-Fi connection between this unit and the smartphone for the first time, [Wi-Fi Easy Setup] is started up on the "Image App".

Proceed to complete the setup by following the on-screen instructions.

- For information about the installation of the "Image App", refer to page 56.
- For information on how to set up a Wi-Fi connection between this unit and a smartphone, refer to page 43.

With [Wi-Fi Easy Setup], you can set the following information:

- Clock information (Synchronize the clock information with that of the smartphone)
- Information on wireless access points (SSIDs and Passwords)*1
- "LUMIX CLUB" Login ID, Password*2

- *1 In [LIVE CAST], you can register up to three wireless access points; in [Wireless Network Mode], you can register only one access point.
- *2 Acquire a Login ID and Password for the "LUMIX CLUB" in advance.
-

- It may take approximately 60 seconds to synchronize the time of the smartphone with that of this unit.
- If your device is Android, you can tap  to run an SSID search when setting wireless access point information.
- You can also start up [Wi-Fi Easy Setup] from the "Image App" menu.



→ [Camera Wi-Fi settings] → [Wi-Fi Easy Setup]

Connecting to a wireless access point

- The number of wireless access points you can register differs depending on the Wi-Fi mode.
In [LIVE CAST], you can register up to three wireless access points; in [Wireless Network Mode], you can register only one access point.
- In [LIVE CAST], this unit will try to connect to the first wireless access point, and if the attempt fails, it will try to connect to the second one, and so on.
- For information on how to set the items with the “Image App”, refer to [Help] in the “Image App” menu.

Check if the wireless access point you are using is compatible with WPS

- If the wireless access point is compatible with WPS:
Proceed to the following [WPS Connection]
- If the wireless access point is not compatible with WPS:
Proceed to “Searching for wireless access points to set up a connection” (→ 60)

[WPS Connection]

1 Press the joystick to select the menu.

(When setting a connection destination in [LIVE CAST])

[Wi-Fi SETUP] → [LIVE CAST SETUP] → [SET CONNECT. DEST.]

(When setting a connection destination in [Wireless Network Mode])

[Wi-Fi SETUP] → [WirelessNetworkModeSetup] → [SET CONNECT. DEST.]

2 Select [New], then press the joystick.

(Example: In [LIVE CAST] mode)

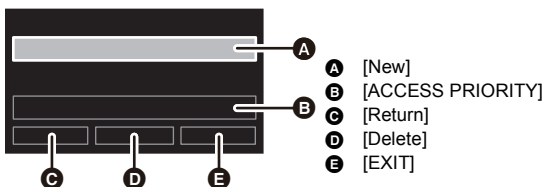

- To delete a wireless access point (→ 63)
- To change the search order of wireless access points (→ 63)

3 Select [WPS Connection], then press the joystick.

4 Set the wireless access point to waiting for WPS.

- For further details, please read the operating instructions for the wireless access point. (When using a tethering connection, please read the operating instructions for the smartphone.)
- When the connection is complete, a message will be displayed and the screen will return to the connection destination setting screen. Select [EXIT], then press the joystick to finish the setup.
- A message is displayed when the connection attempt fails. Press the joystick to exit, then set the connection again.



Enter a PIN code to set the Wi-Fi connection

- 1 Select [PIN code] and press the joystick in Step 4.
- 2 Select the wireless access point to be connected, then press the joystick.
 - To run a wireless access point search again, move the joystick left, select [PIN code], then press the joystick.
- 3 Enter the PIN code displayed on this unit screen into the wireless access point.
 - For further details, please read the operating instructions for the wireless access point. (When using a tethering connection, please read the operating instructions for the smartphone.)
- 4 Select [NEXT], then press the joystick.
 - When the connection is complete, a message will be displayed and the screen will return to the connection destination setting screen. Select [EXIT], then press the joystick to finish the setup.
 - A message is displayed when the connection attempt fails. Press the joystick to exit, then set the connection again.

Confirming that the Wi-Fi connection is complete

-  is displayed on the screen

Searching for wireless access points to set up a connection

- Confirm Encryption key (Password) of the selected wireless access point if the network authentication is encrypted.

1 Press the joystick to select the menu.

(When setting a connection destination in [LIVE CAST])

[Wi-Fi SETUP] → [LIVE CAST SETUP] → [SET CONNECT. DEST.]

(When setting a connection destination in [Wireless Network Mode])

[Wi-Fi SETUP] → [WirelessNetworkModeSetup] → [SET CONNECT. DEST.]

2 Select [New], then press the joystick.

(Example: In [LIVE CAST] mode)

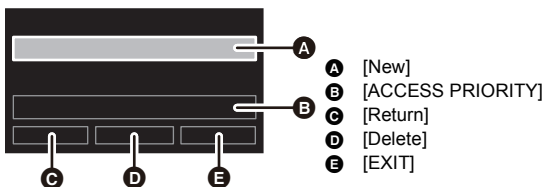

- To delete a wireless access point (→ 63)
- To change the search order of wireless access points (→ 63)

3 Select [Manual Connection], then press the joystick.

4 Select [Search for wireless network], then press the joystick.

5 Select the wireless access point to be connected, then press the joystick.

- To run a wireless access point search again, move the joystick left, select [Search for wireless network], then press the joystick.

- When no wireless access points are displayed, refer to "Setting up a connection manually". (→ 62)
- If an Encryption key (Password) is not set, the connection is complete and a message is displayed. To finish the setup, select [EXIT] and press the joystick.

6 (When there is an Encryption key (Password))
Select the entry field, press the joystick, then enter the Password.

- Confirm that "Input password and select ENTER." is displayed in the area **F**.
- For information on how to enter characters, refer to "Entering text" below.

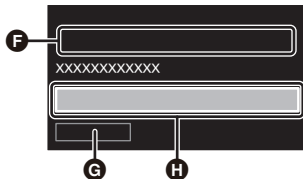

- G** [RETURN]
- H** Entry field

7 **Select [NEXT], then press the joystick.**

- When the connection is complete, a message will be displayed and the screen will return to the connection destination setting screen. Select [EXIT], then press the joystick to finish the setup.

Confirming that the Wi-Fi connection is complete



-  is displayed on the screen

Entering text

You can enter text by operating entry icons with the joystick.

1 **Move the joystick to select the text entry area, then press the joystick.**

- The text entry mode will be activated, allowing you to select an icon.

Icon	Description
[A]	Allows you to enter uppercase alphabetic characters.
[a]	Allows you to enter lowercase alphabetic characters.
[1]	Allows you to enter numbers.
[/.]	Allows you to enter symbols.
	Deletes a character. Deletes the previous character if the cursor is in an empty space.
	Deactivates the text entry mode.

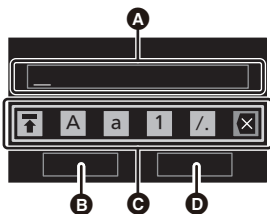

- A** Cursor movement area
- B** [RETURN]
- C** Text entry area
- D** [ENTER]

2 **Move the joystick left or right to select the icon of the desired entry method ([A]/[a]/[1]/[/.]), then move the joystick up or down to change the character.**

3 **Press the joystick to enter the character.**

- Repeat Steps 2 and 3 to enter characters.
- To delete a character, select , and then press the joystick.
- To change the cursor position, perform the operation in Step 4, select the cursor movement area with the joystick, and then move it left or right.

4 **Select , then press the joystick to deactivate the text entry mode.**

- Selecting [ENTER] and then pressing the joystick will end the text entry.

Setting up a connection manually

- When connecting by [Manual Setting], confirm the SSID (Identification name) and Encryption key (Password) of the wireless access point you are using.

1 Press the joystick to select the menu.

(When setting a connection destination in [LIVE CAST])

[Wi-Fi SETUP] → [LIVE CAST SETUP] → [SET CONNECT. DEST.]

(When setting a connection destination in [Wireless Network Mode])

[Wi-Fi SETUP] → [WirelessNetworkModeSetup] → [SET CONNECT. DEST.]

2 Select [New], then press the joystick.

(Example: In [LIVE CAST] mode)

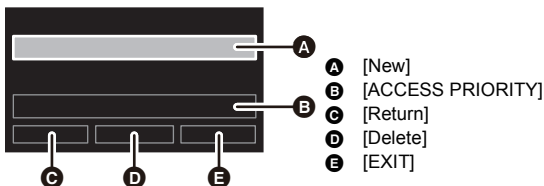

- To delete a wireless access point (→ 63)
- To change the search order of wireless access points (→ 63)

3 Select [Manual Connection], then press the joystick.

4 Select [Manual Setting], then press the joystick.

5 Select the entry field, press the joystick, then enter the SSID of the wireless access point to connect.

- Confirm that "Input SSID and select ENTER." is displayed in the area **F**.
- For details on how to enter characters, refer to page 61.

6 Select [NEXT], then press the joystick.

- If an Encryption key (Password) is not set, proceed to Step 8.

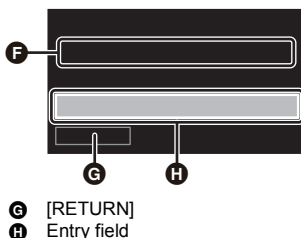

7 (When there is an Encryption key (Password))
Select the entry field, press the joystick, then enter the Password.

- Confirm that "Input password and select ENTER." is displayed in the area **I**.
- For details on how to enter characters, refer to page 61.

8 **Select [NEXT], then press the joystick.**

- When the connection is complete, a message will be displayed and the screen will return to the connection destination setting screen. Select [EXIT], then press the joystick to finish the setup.

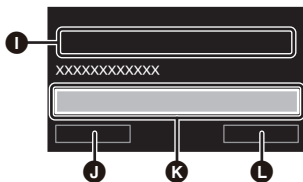

- J** [RETURN]
- K** Entry field
- L** [NEXT]

Confirming that the Wi-Fi connection is complete

-  is displayed on the screen

- Check the wireless access points instruction manual and settings when a saving wireless access point.
- When the signal of the wireless access point is weak, a connection may not be established. Refer to "Messages" (→ 82) and "Troubleshooting" (→ 83) for details.
- Transmission speed may decrease, or may not be usable depending on the environment it is used in.

To delete a wireless access point

- Select [SET CONNECT. DEST.] in [LIVE CAST SETUP] or [WirelessNetworkModeSetup]. (→ 59, 60, 62)

1 Move the joystick to select [Delete], then press the joystick.

- (When [WirelessNetworkModeSetup] is selected)
The message is displayed. Select [YES], then press the joystick.

2 (When [LIVE CAST SETUP] is selected)

Select the wireless access point to be deleted, then press the joystick.

- The message is displayed. Select [YES], then press the joystick.

- To change the wireless access point, delete one of the registered wireless access points, and then add one.

To change the search order of wireless access points

In [LIVE CAST], you can change the search order of wireless access points.

- Select [SET CONNECT. DEST.] in [LIVE CAST SETUP]. (→ 59, 60, 62)

1 Move the joystick to select [ACCESS PRIORITY], then press the joystick.

- You need to register two or more wireless access points in advance.

2 Select the wireless access point you want to give priority to, then press the joystick.

- The selected wireless access point will disappear.

If the Wi-Fi connection cannot be established

- Please refer to the operating instruction of the device in use for details about the setting of the wireless access point or smartphone.

Problem	Check points
<p>It cannot connect to the wireless access point.</p> <p>The wireless access point is not detected.</p>	<p>(General)</p> <ul style="list-style-type: none"> • Turn on the wireless access point. • Approach the wireless access point and reconnect. • If it takes time to complete the connection, the Wi-Fi connection will be aborted. Reset the connection settings. • Check how to connect to the wireless access point and how to set the security settings. • If the wireless access point supports both the 2.4 GHz band and the 5 GHz band, check if the setting for the 2.4 GHz band is enabled. • Make sure the wireless access point is registered in this unit. (→ 59) • The device may be unable to locate the wireless access point due to problems with the signal. Refer to "Setting up a connection manually". (→ 62) <p>([WPS Connection])</p> <ul style="list-style-type: none"> • Make sure the wireless access point is in the correct WPS standby mode. • Make sure the PIN code has been correctly input. <p>([Search for wireless network] or [Manual Setting])</p> <ul style="list-style-type: none"> • Make sure the SSID and Password have been correctly input. • Check the Encryption key (Password).
<p>Radio waves of the wireless access point get disconnected.</p>	<ul style="list-style-type: none"> • The condition may improved by moving the location or changing the angle of the wireless access point. • If you use another 2.4 GHz band device such as a microwave oven or cordless telephone nearby, you may interrupt the signal. Keep a sufficient distance from these types of devices.

Problem	Check points
<p>The Wi-Fi connection is not possible between this unit and a smartphone.</p>	<p>(Wireless Access Point Connection)</p> <ul style="list-style-type: none"> ● Make sure the smartphone is properly connected to the wireless access point by checking the Wi-Fi settings of the smartphone. ● Make sure this unit and the smartphone are connected to the same wireless access point. ● Make sure the wireless access point is registered in this unit. (→ 59) <p>(Direct Connection)</p> <ul style="list-style-type: none"> ● Make sure the smartphone is properly connected to this unit by checking the Wi-Fi settings of the smartphone. ● Make sure the SSID and Password have been correctly input. ● Make sure the smartphone is not connected to the wireless access point. If it is connected to the wireless access point, change the Wi-Fi access point using the smartphone's Wi-Fi set up.
<p>It takes long time every time to connect to a smartphone.</p>	<ul style="list-style-type: none"> ● It may take longer time to connect depending on the Wi-Fi connection setting of the smartphone, but it is not a malfunction.
<p>This unit is not displayed in the Wi-Fi setting screen of the smartphone.</p>	<ul style="list-style-type: none"> ● Try turning on/off the Wi-Fi function in the Wi-Fi settings on the smartphone.
<p>The Wi-Fi connection is disconnected immediately.</p>	<ul style="list-style-type: none"> ● If there is a setting for avoiding poor connections in the Wi-Fi setting menu of the Android device 4.0 or later version, turn it off.
<p>While this unit is connecting in [Wireless Network Mode], the "Image App" fails to find this unit.</p>	<ul style="list-style-type: none"> ● Shut down the "Image App", then turn off the Wi-Fi mode of this unit. After that, set the [Wi-Fi MODE] to the [Wireless Network Mode] again, connect this unit and the smartphone, then start up the "Image App".
<p>Cannot be connected using NFC.</p>	<ul style="list-style-type: none"> ● Make sure your smartphone is compatible with NFC. This unit can be used with NFC-compatible terminals via Android (OS version 2.3.3 or later). ● Make sure the NFC function of your smartphone is on. ● Make sure this unit is turned on. ● Some smartphones cannot be easily checked simply by touching. If this unit is not recognized even after touching, change positions and try again by touching slowly. ● Touch again if it does not connect after touch. If a connection still cannot be established, shut down the "Image App", turn off this unit and try to establish a connection again. ● If the amount of time this unit is in contact with the smartphone is too short, this unit may not recognize the smartphone. Touch and hold the smartphone.

How to Use the [Wi-Fi SETUP] Menu

Configure various settings necessary to use the Wi-Fi function.

When a Wi-Fi mode is active, the settings cannot be changed on this unit.

(When setting a menu item on this unit)

Press the joystick to select the menu.

[Wi-Fi SETUP] → desired menu item

(When setting a menu item on the “Image App”)

- **Set up a Wi-Fi connection between this unit and a smartphone, and perform remote operation. (→ 43)**

On the “Image App” screen, tap  and set the menu item.

[Camera Wi-Fi settings] → desired menu item

- For more information, refer to the [Help] in the “Image App” menu.

[Wi-Fi MODE]

Please refer to page 42.

[LIVE CAST SETUP]

You can make the following settings of the [LIVE CAST]:

- [SET CONNECT. DEST.] (→ 59, 60, 62)
- [E-MAIL SETUP] (→ 52)
- [SAVE VIDEO IN USTREAM] (→ 52)
- [IMAGE QUALITY] (→ 53)

[WirelessNetworkModeSetup]

Please refer to page 59.

[Wi-Fi Easy Setup]

Please refer to page 58.

[LUMIX CLUB]

Please refer to page 68.

[START UP USING NFC]

You can enable/disable the NFC function.

[RESET Wi-Fi SETTINGS]

You can change the Wi-Fi setting back to the default condition. The "LUMIX CLUB" Login ID can also be deleted.

1 Press the joystick to select the menu.

[Wi-Fi SETUP] → [RESET Wi-Fi SETTINGS] → [YES]

2 (To delete the Login ID of the "LUMIX CLUB")
Select [YES], then press the joystick.

- [RESET Wi-Fi SETTINGS] cannot be used in "Image App".

[CONNECTION TEST]

You can test the connection between this unit and the wireless access point.

1 Press the joystick to select the menu.

[Wi-Fi SETUP] → [CONNECTION TEST]

2 Select [LIVE CAST] or [Wireless Network Mode], then press the joystick.

3 Select [START], then press the joystick.

- The connection test starts.

4 Check the connection test result, select [EXIT] and press the joystick.

- To perform a connection test for [LIVE CAST], you need to make other settings in advance.
(→ 49, 68)

- [CONNECTION TEST] cannot be used in "Image App".

[MAC Address]

You can display the MAC address for this unit.

- This item cannot be displayed in "Image App".

Using the “LUMIX CLUB”

Acquire a “LUMIX CLUB” Login ID (free).

If you register to “LUMIX CLUB”, you can upload motion pictures and still pictures recorded with this unit on a WEB service remotely or use the live broadcast function.

- You can set the same “LUMIX CLUB” Login ID for this unit and a smartphone.

When Login ID is acquired over the smartphone (“Image App”) only, it is possible to register the same Login ID to this unit using the “Image App”. (→ 69)

When different Login IDs are acquired for this unit and the smartphone, change one of the Login ID and Password to the one you like to keep.

■ About the [LUMIX CLUB] settings

This unit and the “Image App” differ in the items that can be set.

- For information on how to set the items with the “Image App”, refer to [Help] in the “Image App” menu.

Refer to the “LUMIX CLUB” site for details.

<http://lumixclub.panasonic.net/eng/c/>

■ Acquire a Login ID on this unit

- Select [SET CONNECT. DEST.] in [LIVE CAST SETUP]. (→ 59, 60, 62)

1 Press the joystick to select the menu.

[Wi-Fi SETUP] → [LUMIX CLUB] → [Add/Change Account] → [New]

- Connect to the network. Select [NEXT], then press the joystick.

2 Read through the “LUMIX CLUB” terms, then press the joystick.

3 Select [Agree], then press the joystick.

- Select [EXIT] and press the joystick to cancel the process without acquiring a Login ID.

4 Select [NEXT] and press the joystick, then enter a Password.

- Enter any combination of 8 to 16 characters and numbers for the Password.

- For details on how to enter characters, refer to page 61.

5 Check the Login ID and press the joystick to exit.

- The Login ID (12-digit number) will be displayed automatically. When logging in to the “LUMIX CLUB” with a computer, you only need to enter the numbers.
- Be sure to make a note of the Login ID and Password.

■ Check or change the Login ID/Password acquired with this unit

- To change the “LUMIX CLUB” Password on this unit, access the “LUMIX CLUB” website from your smartphone or PC and change the “LUMIX CLUB” Password in advance.

1 Press the joystick to select the menu.

[Wi-Fi SETUP] → [LUMIX CLUB] → [Add/Change Account] → [Change Account]

- The Login ID and Password are displayed.
- The Password is displayed as “*”.

2 Select [Login ID] or [Password], then press the joystick.

3 Enter the Login ID or Password.

- For details on how to enter characters, refer to page 61.
- Input the Password that was changed with the smartphone or the PC.

4 Select [EXIT], press the joystick to exit.

■ Register the Login ID of the smartphone (“Image App”) into this unit

It is convenient to match the Login IDs for this unit and the smartphone (“Image App”) when using the Wi-Fi function utilizing the “LUMIX CLUB”.

1 Connect this unit to the smartphone.

2 From the “Image App” menu, set the common Login ID.

■ Check the terms of use for the “LUMIX CLUB” on this unit

Check the details if the terms of use have been updated.

Press the joystick to select the menu.

[Wi-Fi SETUP] → [LUMIX CLUB] → [Terms of use]

- This unit will connect to the network and the terms of use will be displayed. Press the joystick to close the menu after checking the terms of use.

■ Delete your Login ID and account from the “LUMIX CLUB” on this unit

Delete the Login ID from this unit when transferring it to another party or disposing of it. You can also delete your “LUMIX CLUB” account.

1 Press the joystick to select the menu.

[Wi-Fi SETUP] → [LUMIX CLUB] → [Delete account]

- The message is displayed. Select [NEXT], then press the joystick.
- 2 Select [YES] and press the joystick in the Login ID delete confirmation screen.**
- A message will be displayed for a while. After that, the Login ID delete confirmation screen will be displayed again. Select [NEXT], then press the joystick.
- 3 Select [YES] and press the joystick on the confirmation screen for deleting the “LUMIX CLUB” account.**
- If you are not deleting the “LUMIX CLUB” account, select [NO] and press the joystick. Only the Login ID will be deleted.
- If you select [YES], the confirmation screen for deleting the “LUMIX CLUB” account will be displayed again. Select [NEXT] and press the joystick.
- 4 Press the joystick to exit.**

-
- Changes and other actions to Login IDs can only be made to the Login ID acquired with this unit.

Using WEB services

When sending images to WEB services, the WEB service being used must be registered with the “LUMIX CLUB”. Registering multiple WEB services will send images to all services simultaneously.

- Check the “FAQ/Contact us” on the following site for compatible WEB services.

<http://lumixclub.panasonic.net/eng/c/>

Preparation:

Make sure that you have created an account on the WEB service you want to use, and have the login information available.

- 1 Connect to the “LUMIX CLUB” site using a smartphone or computer.**
 - 2 Enter your “LUMIX CLUB” Login ID and Password and log in to the service.**
 - 3 Save your e-mail address.**
 - 4 Select the WEB service to be used and save it.**
- Follow the instructions on the screen to save the service.

What you can do with a PC

If you connect this unit to a PC while this unit is turned off, charging of this unit starts. (→ 11)

If you connect this unit to a PC while this unit is turned on, this unit is recognized as a card reader, so you can access the microSD card in this unit from the PC. (→ 72)

- If the battery has worn out with this unit, recharge sufficiently and turn on this unit.
- Even if you connect this unit to a PC, it does not recognize this unit as a card reader while a Wi-Fi mode is running.
- You can use HD Writer WE 2.0 when using with Windows. (→ 75)
Use iMovie or Final Cut Pro X when using with Mac. (For details about iMovie or Final Cut Pro X, please contact Apple Inc.)

■ To connect this unit to a PC

Refer to “Charging the battery” (→ 11) for how to connect this unit to a PC.

- **Turn on this unit before connecting.**
- **When the power lamp and access lamp lights up, the connection is complete.**
- When using HD Writer WE 2.0, connect after installing the software.
- When performing reading/writing between a PC and a microSD card, be aware that some SD card slots built into PCs and some SD card readers are not compatible with the microSDHC Card.

About the screen indication of the unit

- Do not disconnect the USB cable while the access lamp is on or card access icon () appears on the unit screen.

Card reader function (mass storage)

Operating environment

When using this unit as a card reader, the following PC environment is required.

- Even if the system requirements mentioned in this owner's manual are fulfilled, some PCs cannot be used.
- Incorporation of data on the Microsoft Windows XP is guaranteed. but, other functions is not guaranteed.
- Operation on an upgraded OS is not guaranteed.
- Operation on an OS other than the one pre-installed is not guaranteed.
- The USB equipment operates with the driver installed as standard in the OS.

■ For use with Windows

OS	Windows 8/Windows 8.1 (32 bit/64 bit) Windows 7 (32 bit/64 bit) or SP1 Windows Vista (32 bit) SP2
CPU	1 GHz or higher 32-bit (×86) or 64-bit (×64) processor (including compatible CPU)
RAM	Windows 7/Windows 8/Windows 8.1: 1 GB or more (32 bit)/2 GB or more (64 bit) Windows Vista Home Basic: 512 MB or more Windows Vista Home Premium/Business/Ultimate/Enterprise: 1 GB or more
Interface	USB port
Other requirements	Mouse or equivalent pointing device

■ For use with Mac

OS	OS X v10.9.2
CPU	Intel Core 2 Duo or better
RAM	2 GB or more
Interface	USB port
Other requirements	Mouse or equivalent pointing device

Copying motion/still pictures on PC

Using with Windows

When using this unit as a card reader, removable disk (Example:  CAM_SD (F:)) is displayed in [Computer].

We recommend using HD Writer WE 2.0 (→ 75) to copy motion picture files.
Using Windows Explorer or other programs on the PC to copy, move or rename files and folders recorded with this unit will result in them being unusable with HD Writer WE 2.0.
It is impossible to write files to microSD card on this unit from a PC.

- 1 **Double-click the folder that contains the still pictures. ([DCIM] → [100CDPFQ] etc.)**
- 2 **Drag and drop the still pictures onto the destination folder (on the PC's HDD).**

■ To disconnect USB cable safely

Select the  icon in task tray displayed on the PC, and then click [Eject HX-A500].

- Depending on your PC's settings, this icon may not be displayed.

Using with Mac

When using this unit as a card reader, [CAM_SD] is displayed on the desktop.

- 1 **Double-click [CAM_SD] displayed on the desktop.**
- 2 **Using a drag-and-drop operation, move the pictures you want to acquire or the folder storing those pictures to any different folder on the PC.**

■ To disconnect USB cable safely

Drag [CAM_SD] disk icon to the [Trash], and then disconnect the USB cable.

- Do not delete the microSD card's folders. Doing so may make the microSD card unusable in this unit.
- When a file not supported by this unit has been recorded on a PC, it will not be recognized by this unit.
- Always use this unit to format microSD cards.
- It is possible to play back still pictures on a PC using an image viewer standard to Windows or commercially available image browsing software, and copy still pictures to a PC using Windows Explorer.

About the PC display

The folder structure of a microSD card on which this unit has performed recording is as follows.

Example folder structure of a microSD card:

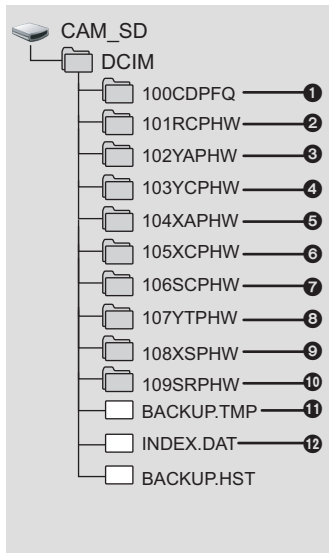

- Folder numbers range from 100 to 999.
Four or five alphabetic characters after a three-digit number indicate the file type.
 - A new folder is created each time the date changes.
- 1** Still pictures in JPEG format (Each folder stores a maximum of 999 still pictures)
Intermittent recording (A new folder is created for each recording)
([S1000001.JPG] etc.)
- 2 - 7** Motion picture files in MP4 format (Each folder stores a maximum of 99 files)
([S1000001.MP4] etc.)
- 2** [3840×2160/30p]
 - 3** [1920×1080/60p]
 - 4** [1920×1080/30p]
 - 5** [1280×720/60p]
 - 6** [1280×720/30p]
 - 7** [848×480/30p]
- 8 - 10** Slow-motion pictures (MP4 format)
([S1000001.MP4] etc.)
- 8** 1/2 times normal speed ([1920×1080/60fps])
 - 9** 1/4 times normal speed ([1280×720/120fps])
 - 10** 1/8 times normal speed ([848×480/240fps])
- 11 - 12** Administrative files

- Do not delete management files in the folders **2** to **7**, such as [S100MP4.PL].

Using the HD Writer WE 2.0 (Windows only)

The feature of HD Writer WE 2.0

You can copy the motion/still picture files to the HDD of PCs or microSD cards using HD Writer WE 2.0.

What can be done with the HD Writer WE 2.0	Data type
Copying data to a PC	Motion picture and still picture
Editing: <ul style="list-style-type: none"> ● Editing motion picture data copied on an HDD of a PC ● Dividing, Trimming, Title, Effect, Transition, BGM, Delete partially ● Converting part of motion picture into still picture 	Motion picture
Online sharing: You can upload motion pictures or still pictures on the Internet and share them with your family and friends.	Motion picture and still picture
Playing back on a PC: Play back the motion picture data in high-definition picture quality on a PC.	Motion picture and still picture

- Refer to the operating instructions of HD Writer WE 2.0 (PDF file) for details on how to use it.

- **It is impossible to write files to this unit from a PC.**
- **Motion pictures recorded with another device cannot be written to HD Writer WE 2.0.**
- **When motion picture data is written to or read from the microSD card with software other than HD Writer WE 2.0, this unit is not guaranteed to operate correctly.**
- Do not start up HD Writer WE 2.0 and other software at the same time.

Before Installing HD Writer WE 2.0

Your installation or use of the Software defined below shall be conclusively deemed to constitute your acceptance of the terms of this Agreement. If you do not accept the terms of this Agreement, do not install, nor use the Software.

End User License Agreement

You ("Licensee") are granted a license for the Software defined in this End User License Agreement ("Agreement") on condition that you agree to the terms and conditions of this Agreement.

The following terms contain material representations regarding the disclaimers of Panasonic Corporation. Be sure to read through, understand and confirm the following terms.

Article 1 License

Licensee is granted the right to use the Software (the "Software" means the software and other information such as manuals downloaded by Licensee through Panasonic website), but all applicable rights to patents, copyrights, trademarks and trade secrets in the Software are not transferred to Licensee.

Article 2 Use by a Third Party

Licensee may not use, copy, modify, transfer, rent, lease, lend or allow any third party, whether free of charge or not, to use, copy or modify the Software, except as expressly provided for in this Agreement.

Article 3 Restrictions on Copying the Software

Licensee may make a single copy of the Software in whole or a part solely for back-up purpose.

Article 4 Computer

Licensee may use the Software only on one computer, and may not use it on more than one computer. Further, Licensee may not use the Software for commercial software hosting services.

Article 5 Reverse Engineering, Decompiling or Disassembly

Licensee may not reverse engineer, decompile, or disassemble the Software, except to the extent either of them is permitted under law or regulation of the country where Licensee resides. Panasonic, or its distributors will not be responsible for any defects in the Software or damage to Licensee caused by Licensee's reverse engineering, decompiling, or disassembly of the Software.

Article 6 Indemnification

The Software is provided "AS-IS" without warranty of any kind, either expressed or implied, including, but not limited to, warranties of non-infringement, merchantability and/or

fitness for a particular purpose. Further, Panasonic does not warrant that the operation of the Software will be uninterrupted or error free. Panasonic or any of its distributors will not be liable for any damage suffered by Licensee arising from or in connection with Licensee's use of the Software.

Article 7 Export Control

Licensee agrees not to export or re-export to any country the Software in any form without the appropriate export licenses under regulations of the country where Licensee resides, if necessary.

Article 8 Termination of License

The right granted to Licensee hereunder will be automatically terminated if Licensee contravenes any of the terms and conditions of this Agreement. In this event, Licensee must destroy the Software and related documentation together with all the copies thereof at Licensee's own expense.

Article 9 With regard to MICROSOFT SQL SERVER COMPACT 3.5 produced by Microsoft Corporation

(1) Licensee shall use the MICROSOFT SQL SERVER COMPACT 3.5 only when included in the Software, and shall not use the MICROSOFT SQL SERVER COMPACT 3.5 in any other configuration or method. Licensee shall not publish the MICROSOFT SQL SERVER COMPACT 3.5 or work around any technical limitations in the MICROSOFT SQL SERVER COMPACT 3.5.

(2) Licensee shall not use, copy, distribute, regrant for use or otherwise handle the Software in any way beyond the range of use granted under Article 9 (1), and shall not conduct operations such as reverse engineering, decompilation, disassembling, etc. of the MICROSOFT SQL SERVER COMPACT 3.5.

(3) All rights, including copyright, patent rights etc. relating to the MICROSOFT SQL SERVER COMPACT 3.5 shall belong to Microsoft Corporation. Licensee shall not claim any rights related to the MICROSOFT SQL SERVER COMPACT 3.5 whatsoever.

Operating environment for HD Writer WE 2.0

When using HD Writer WE 2.0, the following PC environment is required.

- Even if the system requirements mentioned in this owner's manual are fulfilled, some PCs cannot be used.
- For 4K motion pictures, editing may take a long time or smooth playback may not be possible, even if the recommended system requirements are fulfilled.
- A compatible DVD writer drive and media are necessary for writing to a DVD.
- Operation is not guaranteed in the following cases.
 - When 2 or more USB devices are connected to a PC, or when devices are connected through USB hubs or by using extension cables.
 - Operation on an upgraded OS.
 - Operation on an OS other than the one pre-installed.
- This software is not compatible with Microsoft Windows 3.1, Windows 95, Windows 98, Windows 98 SE, Windows Me, Windows NT, Windows 2000 and Windows XP.

OS	Windows 8/Windows 8.1 (32 bit/64 bit) Windows 7 (32 bit/64 bit) SP1 Windows Vista (32 bit) SP2 <ul style="list-style-type: none">• When using 4K motion pictures, a 64 bit version of a Windows 7/Windows 8/Windows 8.1 is required.
CPU	Intel Pentium 4 2.8 GHz or higher (including compatible CPU) <ul style="list-style-type: none">• Intel Core 2 Duo 2.16 GHz or higher or AMD Athlon 64 X2 Dual-Core 5200+ or higher is recommended when using playback function.• Intel Core 2 Quad 2.6 GHz or higher is recommended when using editing function.• When using playback or editing function for 1080/60p, Intel Core i7 2.8 GHz or higher is recommended.• When using playback or editing function for 4K motion pictures, Intel Core i7 3.5 GHz or higher is recommended.
RAM	Windows 7/Windows 8/Windows 8.1: 1 GB or more (32 bit)/2 GB or more (64 bit) Windows Vista: 1 GB or more <ul style="list-style-type: none">• When using playback or editing function for 4K motion pictures: 8 GB or more is recommended.
Display	High Color (16 bit) or more (32 bit or more recommended) Desktop resolution of 1024×768 pixels or more (1920×1080 pixels or more recommended) DirectX 9.0c compatible video card (DirectX 10 recommended) Compatible with DirectDraw overlay PCI Express™ × 16 compatible recommended Video memory of 256 MB or more recommended <ul style="list-style-type: none">• In order to play back 4K motion pictures, a video card that supports hardware decoding of 4K motion pictures is required. (For example) Intel HD Graphics 4000 or higher NVIDIA GeForce 600 series or higher• In order to play back or edit 4K motion pictures, at least 2 GB of video memory is required.• In order to play back motion pictures with a resolution of 4K, a monitor and a video card that support 4K are required.

Free hard disk drive space	Ultra DMA — 100 or more 450 MB or more (for installing the software)
Sound	DirectSound Support
Interface	USB port [Hi-Speed USB (USB 2.0)]
Other requirements	Mouse or equivalent pointing device Internet connection

- This software is only for Windows.
- Input is not supported in languages other than English, German, French and Russian.
- Operation cannot be guaranteed on all DVD drives.
- Operation is not guaranteed on Microsoft Windows Vista Enterprise, Windows 7 Enterprise, Windows 8 Enterprise, Windows 8.1 Enterprise or Windows RT.
- For Windows 8/Windows 8.1, this software is available only as a desktop application.
- This software is not compatible with a multi-boot environment.
- This software is not compatible with a multi-monitor environment.
- If using Windows Vista/Windows 7/Windows 8/Windows 8.1, administrative account and standard account users only can use this software. (An administrative account user should install and uninstall this software.)

-
- You will need a high performance PC depending on the functions to be used. It may not properly play back or properly operate depending on the environment of the PC used. Refer to the operating environment and notes.
 - Operation during the playback may become slow if the CPU or memory is not fulfilling the requirements of the operating environment.
 - Always use the most current driver for the video card.
 - Always make sure there is enough capacity on the HDD in the PC. It may become inoperable or the operation may stop suddenly if the capacity gets low.

Installation

When installing the software, log on to your computer as the Administrator or with a user name with equivalent authorization. (If you do not have authorization to do this, consult your manager.)

- Before starting the installation, close all applications that are running.
- Do not perform any other operations on your PC while the software is being installed.
- Explanation of operations is based on Windows 7.

■ Installing HD Writer WE 2.0

<p>Check the website below to download/install the software. http://panasonic.jp/support/global/cs/soft/download/f_we20.html</p>

■ Uninstalling HD Writer WE 2.0

Follow the steps below to uninstall any software applications that you no longer require.

- 1** Select [Start] → [Control Panel] → [Uninstall a Program].
- 2** Select [HD Writer WE 2.0], then click [Uninstall].

- Proceed with the uninstallation by following the on-screen instructions.
- After uninstalling the software, be sure to reboot the PC.

Starting HD Writer WE 2.0

- To use the software, log on as an Administrator or as user name for standard user account.
The software cannot be used with the user name for a guest account.

(On the PC)

Select [Start] → [All Programs] → [Panasonic] → [HD Writer WE 2.0] → [HD Writer WE 2.0].

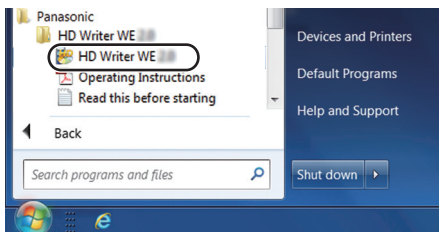

- For details on how to use the software applications, read the PDF operating instructions of the software.

Reading the operating instructions of the software applications

- You will need Adobe Acrobat Reader 5.0 or later or Adobe Reader 7.0 or later to read the PDF operating instructions.

Select [Start] → [All Programs] → [Panasonic] → [HD Writer WE 2.0] → [Operating Instructions].

Indications

(Recording screen)

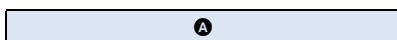
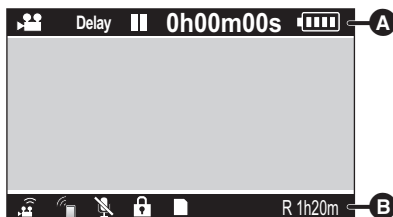

Recording mode (→ 30)

Delay Delay-Start REC (→ 33)

60sec /
 30sec /
 10sec /
 5sec /
 3sec

Interval recording (→ 34)

●/II (Red) Recording

II (Green) Recording pause

(Red) Recording still picture

0h00m00s Elapsed recording time (→ 27)

("h" is an abbreviation for hour, "m" for minute and "s" for second.)

 Remaining battery power
(→ 12)

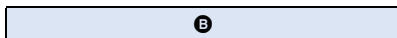

 Microphone (disabled) (→ 36)

 Locked (→ 29)

(White) Card recording possible status

(Green) Recognizing the card

R 1h20m Remaining time for motion picture recording (→ 27)

R3000 Remaining number of still pictures (→ 27)

(Information screen)

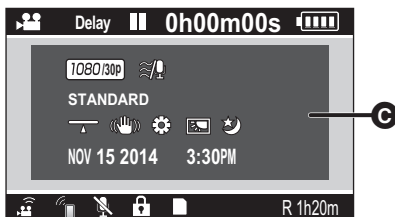

2160/30p / 1080/60p / 1080/30p / 720/60p / 720/30p /
 480/30p / 1080/60fps / 720/120fps / 480/240fps

Pixels/Frame rate (→ 32)

16.3M / 8.3M / 5.3M

Picture size (→ 33)

 Wind noise reduction (→ 36)

WIDE/STANDARD Angle of view (→ 33)

 Level Shot Function (→ 34)

 Image Stabilizer (→ 34)

/ / / / / /

White Balance (→ 35)

 Backlight Compensation
(→ 36)

 Color Night Rec function
(→ 36)

NOV 15 2014 Date indication (→ 17)

3:30PM Time indication (→ 17)

■ Indication of connection to Wi-Fi



Wi-Fi connection status
(Wireless access point
connection) (→ 57)



Wi-Fi connection status (Direct
connection) (→ 57)



Wi-Fi mode icon (→ 57)

■ Indication of connection to other devices



Accessing the card (→ 71)

■ Confirmatory indications



microSD card is not inserted or
is incompatible.

Messages

Major confirmation/error messages to be indicated on the screen in text.

CHECK CARD.

This card is not compatible or it cannot be recognized by the unit.

If this message appears even though motion pictures and still pictures are recorded on a microSD card, the card may be unstable. Reinsert the microSD card, then turn the unit off and then on again.

No wireless access point found

- Check the Wi-Fi set up of your wireless access point and smartphone.
- [WPS Connection] can establish a connection only between two devices: this unit and a device that will connect to this unit. Check if multiple devices are trying to establish a connection in the WPS waiting state simultaneously.
- Read page 64 if the Wi-Fi connection cannot be established.

Connection failed. Please check network settings of connected device.

- It may be impossible to connect from some Web services such as "LUMIX CLUB" and USTREAM. Try to reconnect after waiting a short while.
- Read page 64 if the Wi-Fi connection cannot be established.

Network disconnected.

- When using [Wireless Network Mode], if you do not operate the DLNA-compatible device you are connected to for a while, it will be displayed. Check the status of the DLNA device you are connected to.

About recovery

If faulty management information is found, the messages may appear and a repair is performed. (Repairing may take time depending on the error.)

- Use a sufficiently charged battery.
- Depending on the condition of the data, it may not be possible to completely repair the data.
- If recovery fails, it will not be possible to play back files recorded before the unit turned off.
- When data recorded on another device is recovered, it may not be possible to play back the data on this unit or the other device.
- If recovery fails, turn the unit off and on again after waiting a while. If recovery fails repeatedly, format a media on the unit. Please be aware that if a media is formatted, then all the data recorded on the media will be erased.

Troubleshooting



■ It is not a malfunction in following cases

The lens or LCD monitor fog up.	<ul style="list-style-type: none"> This is due to condensation. It is not a malfunction. Please refer to page 5.
The alert sound and shutter sound are low.	<ul style="list-style-type: none"> This is for ensuring the waterproof performance of this unit, and not a malfunction. Opening and closing the side cover will restore the original volume.

Power

Problem	Check points
This unit cannot be turned on.	<ul style="list-style-type: none"> Charge the battery again to ensure it is sufficiently charged. (→ 11)
This unit does not stay on long enough.	<ul style="list-style-type: none"> In cold places, the battery using time becomes shorter.
Battery runs down quickly.	<ul style="list-style-type: none"> If the operating time is very short even after the battery has been recharged sufficiently, the battery has worn out. Consult with your dealer.

Recording

Problem	Check points
This unit arbitrarily stops recording.	<ul style="list-style-type: none"> Use a microSD card that can be used for motion picture recording. (→ 14) The recordable time may have shortened due to the deterioration of the data writing speed or repeated recording and deletion. Using this unit, format the microSD card. (→ 20) If you use a microSD card with a SD Speed Class Rating lower than Class 6 in [SLOW MOTION] (→ 31), recording may stop suddenly. (→ 14) If you use a microSD card with a SD Speed Class Rating lower than Class 10 when [PIXELS / FRAME RATE] (→ 32) is set to [3840×2160/30p], recording may stop suddenly. (→ 14)
Color balance of images is strange when recording in a place such as a gymnasium.	<ul style="list-style-type: none"> In a place with multiple light sources, such as a gymnasium or a hall, set the White Balance setting to  (Indoor 2). If you cannot record clearly with the  (Indoor 2), set it with [CUSTOM]. (→ 35)
Recorded motion pictures flicker. Horizontal lines appear in recorded images.	<ul style="list-style-type: none"> If you record an image with [1280×720/120fps] or [848×480/240fps] in [SLOW MOTION], flickering or horizontal lines may appear under fluorescent lighting. (→ 32)

With a PC

Problem	Check points
<p>When connected by the USB cable, this unit is not detected by the PC.</p>	<ul style="list-style-type: none"> ● If this unit is turned off, this unit starts charging when it is connected to a PC. ● After re-inserting the microSD card into this unit, reconnect the supplied USB cable. ● Select another USB terminal on the PC. ● Check the operating environment. (→ 72, 77) ● Connect the supplied USB cable again after restarting the PC and turning on this unit again. ● Even if you connect this unit to a PC, it does not recognize this unit as a card reader while a Wi-Fi mode is running. Move the joystick left to end the Wi-Fi mode, and re-connect the supplied USB cable.
<p>When the USB cable is disconnected, an error message will appear on the PC.</p>	<ul style="list-style-type: none"> ● To disconnect the USB cable safely, double-click the  icon in the task tray and follow the instructions on the screen. (Windows)
<p>Cannot see the PDF operating instructions for HD Writer WE 2.0.</p>	<ul style="list-style-type: none"> ● You will need Adobe Acrobat Reader 5.0 or later or Adobe Reader 7.0 or later to read the PDF operating instructions for HD Writer WE 2.0.

About the Wi-Fi function

Problem	Check points
Cannot connect to wireless access point or smartphone.	<ul style="list-style-type: none"> Read page 64 if the Wi-Fi connection cannot be established.
When looking at the recording screen or playing back an image on the smartphone, mosaic-like noise appears and the motion is not smooth.	<ul style="list-style-type: none"> Depending on the smartphone or radio wave conditions, when you play back a motion picture, mosaic-like noise may appear on the screen and the motion may not be smooth. (The images to be recorded are not affected.)
A motion picture file is created that is longer than the recording time.	<ul style="list-style-type: none"> Recording in [SLOW MOTION] (→ 31) will create a motion picture file that is longer than the recording time. For example, the playback time of a motion picture recorded in [848×480/240fps] (1/8 slow-motion) will be 8-times longer than the actual recording time. (→ 32)
This unit does not change to Playback mode.	<ul style="list-style-type: none"> When this unit is recording a motion picture, "Image App" cannot change to Playback mode.
Files cannot be played back.	<ul style="list-style-type: none"> If a high-quality motion picture is copied to a smartphone, it may not be able to be played back on the smartphone. (→ 32)
This unit does not turn off, even after closing "Image App".	<ul style="list-style-type: none"> This unit can be turned off by tapping  → [CAMERA FUNCTION] → [Camera power off] on the "Image App" screen.
I have forgotten the Login ID or Password for the "LUMIX CLUB".	<ul style="list-style-type: none"> Check the information in the login screen of "LUMIX CLUB". http://lumixclub.panasonic.net/eng/c/
Live broadcasting does not work even if live broadcasting is set.	<ul style="list-style-type: none"> Live broadcasting does not work when the clock setting is ahead of or behind the actual time. Set the clock correctly. (→ 17)

Others

Problem	Check points
If the microSD card is inserted in this unit, it is not recognized.	<ul style="list-style-type: none"> If the microSD card is formatted on a PC, it may not be recognized by this unit. Use this unit to format microSD cards. (→ 20)

Cautions for use

About this unit

This unit and the microSD card become warm during use. This is not a malfunction.

Keep this unit as far away as possible from electromagnetic equipment (such as microwave ovens, TVs, video games etc.).

- If you use this unit on top of or near a TV, the pictures and/or sound on this unit may be disrupted by electromagnetic wave radiation.
- Recorded data may be damaged, or pictures may be distorted, by strong magnetic fields created by speakers or large motors.
- Electromagnetic wave radiation generated by microprocessors may adversely affect this unit, disturbing the pictures and/or sound.

Do not use this unit near radio transmitters or high-voltage lines.

- If you record near radio transmitters or high-voltage lines, the recorded pictures and/or sound may be adversely affected.

Make sure to use the supplied cable. Do not extend the cable.

Do not spray insecticides or volatile chemicals onto this unit.

- If this unit is sprayed with such chemicals, its body may be marred and the surface finish may peel off.
- Do not leave rubber or plastic products in contact with this unit for a long time.

When you use this unit in a sandy or dusty place such as a beach, do not let sand or fine dust get into the body and terminals of this unit.

- Sand or dust may damage this unit. (Care should be taken when inserting and removing a card.)

Do not use this unit in strenuous sports involving impacts and collisions.

When carrying this unit, do not drop or bump it.

- A strong impact can break this unit's casing, causing it to malfunction.

Cleaning

- Before cleaning, pull the USB cable from the PC, and then wipe this unit with a soft, dry cloth.
- If this unit is very dirty, dip a cloth in water and squeeze firmly, and then wipe this unit with the damp cloth. Next, dry this unit with a dry cloth.
- Use of benzine, paint thinner, alcohol, or dishwashing liquid may alter the camera body or peel the surface finish. Do not use these solvents.
- When using a chemical dust cloth, follow the instructions that came with the cloth.

Do not use this unit for surveillance purposes or other business uses.

- This unit was designed for consumer intermittent use. It was not intended for continuous use, or for any industrial or commercial application resulting in prolonged use.
- In certain situations, continuous use could cause this unit to overheat and cause a malfunction. Such use is strongly discouraged.

When you are not going to use this unit for an extended time

- Store this unit in a cool place with minimal humidity, and with a constant temperature where possible (recommended temperature: 15 °C to 25 °C (59 °F to 77 °F), recommended humidity: 40%RH to 60%RH).
- Always remove the card from this unit.
- When storing this unit for an extended time, it is recommended that you charge it once every year.
- The battery discharges slowly even if this unit is not used. The remaining battery level will decrease when this unit is not used for an extended time.
- When storing this unit in a cupboard or cabinet, it is recommended that you place a desiccant (silica gel) in with it.

Terminate usage of Armband Case/Head mount/Headband if a feeling of discomfort arises, including any skin reactions.

About personal information

When the Wi-Fi function is used, the SSID, Password, and other personal information will be included in this unit.

Disclaimer

- Information including personal information may be altered or vanish due to erroneous operation, effect of static electricity, accident, malfunction, repair, or other handlings. Please note in advance that Panasonic is not liable in any way for any direct or indirect damage from the alteration or vanishing of information or personal information.

When requesting a repair, transferring to another party, or disposing.

- After making a copy of personal information, always delete information such as personal information and wireless LAN connection settings that you have saved within this unit with [RESET Wi-Fi SETTINGS]/[Delete account]. (→ 67, 70)
- Remove the Memory Card from this unit when requesting a repair.
- Settings may return to factory default when this unit is repaired.
- Please contact the dealer where you purchased this unit or Panasonic if above operations are not possible due to malfunction.

When transferring to another party, or disposing of the Memory Card, please refer to “When disposing of or giving away the microSD card, note that:”.

When uploading images on web services

- Images may contain information that can be used for identifying individuals such as titles and recording dates. When uploading images on web services, check carefully, and then upload.

About the microSD card

- The memory capacity listed on the microSD card label is the total of the capacity that is used for protection and management of copyright, and capacity that can be used normally with this unit and computer.
- Do not subject the microSD card to strong shocks, bend it or drop it.
- Data on the microSD card may be damaged or deleted due to electrical noise, static

electricity or malfunctions with this unit or the microSD card.

When the microSD card is being accessed (when is displayed or the access lamp is lit), do not perform the following:

- Remove the microSD card
- Turn the unit off
- Insert and remove the USB cable
- Expose the unit to vibrations or shock

When disposing of or giving away the microSD card, note that:

- Formatting and deletion of data on this unit or computer only changes the file management information and does not completely delete the data in the microSD card.
- It is recommended that the microSD card is physically destroyed or the microSD card is physically formatted using this unit when disposing of or giving away the microSD card.
To physically format the microSD card, select [SETUP] → [FORMAT MEDIA] → [YES] from the menu, and then press and hold the recording start/stop button for about 3 seconds. When the microSD card data deletion screen appears, select [YES], and then follow the on-screen instructions.
- The customer is responsible for the management of the data in the microSD card.

Cautions for using a microSD card

- Do not expose the terminals of the microSD card to water, dirt or dust.
- Do not place microSD cards in the following areas:
 - In direct sunlight
 - In very dusty or humid areas
 - Near a heater
 - Locations susceptible to significant difference in temperature (condensation can occur.)
 - Where static electricity or electromagnetic waves occur
- To protect microSD cards, return them to their cases when you are not using them.

LCD monitor

- When the LCD screen is dirty or condensation has occurred, please wipe it using a soft cloth such as eyeglass cleaner.
- When the unit has become very cold, for example due to storage in a cold area, its LCD monitor will be slightly darker than usual immediately after the unit is turned on. The normal brightness will be restored when the unit's internal temperature rises.

Extremely high precision technology is employed to produce the LCD Monitor screen. The result is more than 99.99% effective dots with a mere 0.01% of the dots inactive or always lit. However, this is not a malfunction and does not affect the recorded picture.

About firmware updates

To update the firmware of this unit, copy the firmware update file to the microSD card, insert it into this unit, and perform [FIRMWARE UPGRADE] in the [SETUP] menu. (→ 21)

For the latest update information, check the support website below. (As of April 2014)

http://panasonic.jp/support/global/cs/e_cam/index.html

(This site is English only.)

About the battery

The battery used in this unit is a rechargeable lithium-ion battery. It is susceptible to humidity and temperature and the effect increases the more the temperature rises or falls.

If the operating time is very short even after the battery has been recharged, the battery has worn out.

Consult with your dealer.

Approximate recordable time

microSD cards are only mentioned with their main memory size.

The stated times are the approximate recordable times for continuous recording.

[NORMAL SHOOTING]

	Pixels/ Frame rate	Transfer rate (VBR)	microSD card			
			4 GB	8 GB	16 GB	32 GB
	[3840×2160/ 30p]	Max. 72 Mbps	7 min	14 min	28 min	55 min
	[1920×1080/ 60p]	Max. 28 Mbps	19 min	40 min	1 h 20 min	2 h 40 min
	[1920×1080/ 30p]	Average 15 Mbps	35 min	1 h 10 min	2 h 20 min	4 h 40 min
	[1280×720/ 60p]					
	[1280×720/ 30p]	Average 9 Mbps	1 h	2 h	4 h 10 min	8 h 20 min
[848×480/ 30p]	Average 4.5 Mbps	1 h 50 min	3 h 40 min	7 h 30 min	15 h	

[SLOW MOTION]

	Pixels/ Frame rate	Transfer rate (VBR)	microSD card			
			4 GB	8 GB	16 GB	32 GB
	[1920×1080/ 60fps]	Average 15 Mbps	15 min	30 min	1 h	2 h
	[1280×720/ 120fps]	Average 9 Mbps	13 min	27 min	55 min	1 h 50 min
	[848×480/ 240fps]	Average 4.5 Mbps				

- A** Favors image quality
- B** Favors Recording time

- "h" is an abbreviation for hour, "min" for minute and "s" for second.
- The default setting is [1920×1080/30p].
- The recordable time may be reduced when lot of action scenes and recorded or recording of short motion picture is repeated.

Approximate number of recordable pictures

microSD cards are only mentioned with their main memory size.
The stated number is the approximate number of recordable pictures.

Picture size	Aspect ratio	microSD card			
		4 GB	8 GB	16 GB	32 GB
[16.3M] (5376×3024)	16:9	400	800	1600	3300
[8.3M] (3840×2160)		750	1500	3000	6000
[5.3M] (3072×1728)		1100	2200	4500	8500

- The number of recordable pictures depends on the subject being recorded.

Optional accessories

Some optional accessories may not be available in some countries.

About the Video Camera Mount (For Handlebar)

You can attach the Video Camera Mount (For Handlebar)/RP-CMC10 as follows.

- To use the Video Camera Mount (For Handlebar)/RP-CMC10, the Tripod Mount/VW-CTA100 is required.
- Please also refer to the operating instructions of the Video Camera Mount (For Handlebar) and the Tripod Mount.

■ When attaching the Video Camera Mount (For Handlebar) and Tripod Mount

- 1 Remove the Quick Shoe of the Video Camera Mount (For Handlebar) from the camera platform.
- 2 Align the camera screw of the Quick shoe with the tripod mounting hole of the Tripod Mount, and insert the camera screw.

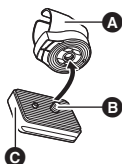

- A Tripod Mount
- B Camera screw
- C Quick shoe

- 3 Turn the hinge at the back side of the Quick Shoe to tighten the camera screw (clockwise).

- Hold the Tripod Mount with your hand so that it will not rotate with the camera screw.
- After tightening the camera screw, fix the hinge.

- 4 Attach the Quick Shoe to the camera platform.

- Align ▲ on the Quick Shoe with ▲ on the camera platform, and push the Quick Shoe diagonally until it clicks into place.

- 5 Attach the camera unit to the Tripod Mount.

■ When removing the Video Camera Mount (For Handlebar) and Tripod Mount

To remove the Video Camera Mount (For Handlebar) and Tripod Mount, perform the steps for mounting them in reverse order.

- It is convenient that you store this unit (main unit) in the Multi Case (VW-HLA500) and attach the case to the handlebar of your bicycle.

Requests when disposing of this unit

When disposing of your used products, remove the battery built into this unit after performing [RESET Wi-Fi SETTINGS] (→ 67), and please cooperate in recycling of the battery. Please refer to page 93 about how to remove the battery.

- Please make sure that the battery is disposed of at an officially assigned location, if there is one in your country.

Do not disassemble this unit other than when disposing of this unit.

This is the rechargeable battery for this unit.

Do not use other than with this unit.

Do not charge the rechargeable battery when it has been removed.

- Do not place in fire or heat it.
- Do not puncture with nails, subject it to impact, disassemble or modify it.
- Do not touch metal to the + and – terminals.
- Do not store or carry together with necklaces or hairpins, etc.
- Do not heat in microwaves or ovens, etc.
- Do not charge, use or leave in hot places such as next to fires or in extremely hot weather.
- Do not put into water.

This may cause leaking, overheating, fire or rupture.

- If a leak should occur, by no means touch the liquid with bare hands.

If the liquid gets on the body or clothes, wash well with water. If the liquid gets into your eyes, there is a danger of blindness. Do not rub the eyes; after washing immediately with clean water, consult your physician.

Keep removed screws etc. out of the reach of small children.

If accidentally ingested there will be adverse physical effects.

- Should you suspect that such an object has been ingested, consult your physician immediately.

Battery used for this unit

Name: Lithium ion (Li-ion)
rechargeable battery

Nominal voltage: DC 3.7 V

How to remove the battery

When disposing of your used products, perform [RESET Wi-Fi SETTINGS] to delete personal information from this unit.

This figure describes the disposal of this unit, it is not instruction for repair. If disassembled, repair is not possible.

- Disassemble after the battery runs out.
- If it cannot be removed smoothly, contact Panasonic's Service Center.
- Keep disassembled parts out of reach of children.

1 Open the side cover, and remove all of the 6 screws indicated in the figure below.

- Use a cross-slot screwdriver (commercially available).

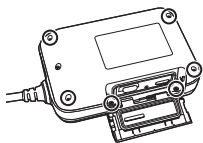

2 Remove the connector **A** of the flexible circuit board, and remove the circuit board on the front side (button side) of this unit.

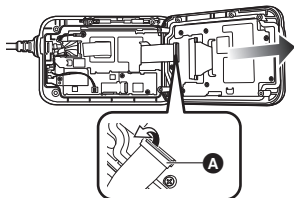

3 Pull out the flexible circuit board **B**, and pull out the speaker connector **C** upwards.

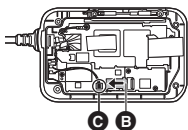

4 Remove the 4 screws indicated in the figure below, and remove the heatsink **D**.

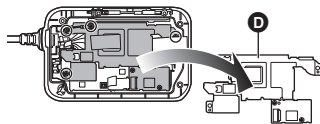

5 Remove the connector **E** of the camera unit, the built-in battery connector **F**, and the NFC flexible circuit board **G**, and lift up the circuit board.

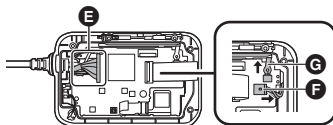

6 Remove the battery by using a screwdriver.

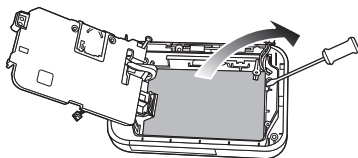

Regarding the handling of used batteries

- Insulate the terminals with cellophane tape or similar.
- Do not disassemble.

About copyright

■ Carefully observe copyright laws

Whatever you have recorded and created can be used for your personal entertainment only. Under copyright laws, other materials cannot be used without obtaining permission from the holders of the copyrights.

■ Licenses

- microSDHC Logo is a trademark of SD-3C, LLC.
- Microsoft®, Windows® and Windows Vista® are either registered trademarks or trademarks of Microsoft Corporation in the United States and/or other countries.
- Microsoft product screen shot(s) reprinted with permission from Microsoft Corporation.
- Intel®, Pentium® and Intel® Core™ are trademarks of Intel Corporation in the U.S. and/or other countries.
- AMD Athlon™ is a trademark of Advanced Micro Devices, Inc.
- iMovie, Final Cut Pro, Mac and OS X are trademarks of Apple Inc. registered in the U.S. and other countries.
- App Store is a service mark of Apple Inc.
- Android and Google Play are trademarks or registered trademarks of Google Inc.
- The Wi-Fi CERTIFIED Logo is a certification mark of the Wi-Fi Alliance.
- The Wi-Fi Protected Setup Mark is a mark of the Wi-Fi Alliance.
- "Wi-Fi", "Wi-Fi Protected Setup", "WPA" and "WPA2" are marks or registered marks of the Wi-Fi Alliance.
- The N-Mark is a trademark or registered trademark of NFC Forum, Inc. in the United States and in other countries.
- DLNA, the DLNA Logo and DLNA CERTIFIED are trademarks, service marks, or certification marks of the Digital Living Network Alliance.
- Other names of systems and products mentioned in these instructions are usually the registered trademarks or trademarks of the manufacturers who developed the system or product concerned.

This product is licensed under the AVC patent portfolio license for the personal and non-commercial use of a consumer to (i) encode video in compliance with the AVC Standard ("AVC Video") and/or (ii) decode AVC Video that was encoded by a consumer engaged in a personal and non-commercial activity and/or was obtained from a video provider licensed to provide AVC Video. No license is granted or shall be implied for any other use. Additional information may be obtained from MPEG LA, LLC. See <http://www.mpegla.com>.

Panasonic Corporation
Web site: <http://panasonic.net>