

Panasonic®

Installation Guide

Home Monitoring Camera HomeHawk Front Door

Model No. **KX-HN7001**

HomeHawk Front Door/Outdoor

Model No. **KX-HN7002**

KX-HN7003



Model shown is KX-HN7001.

Thank you for purchasing a Panasonic product.

This document explains how to configure the access point, front door camera and optional outdoor camera using a mobile device. These steps must be followed before you can use the system.
For details about how to use the system, refer to the User's Guide (page 32).

Charge the cameras for about 7 hours before camera installation (page 22).

Please read this document before using the unit and save it for future reference.

For assistance, please contact us at 1-800-272-7033 or visit our Web site:

<http://shop.panasonic.com/support> for customers in the U.S.A.

Please register your product: <http://shop.panasonic.com/support>

Printed in China

Table of Contents

Introduction	
Model composition	3
Accessory information	3
Expanding your camera	4
Important Information	
Graphical symbols for use on equipment and their descriptions	5
About this system	5
For your safety	5
Important safety instructions	7
Security cautions	7
For best performance	8
Privacy and rights of portrait	8
Other information	8
Installation Location	
Wireless communication range	12
Information about sensor features	12
Information about night vision mode	13
Installation location examples	14
Do not install in these locations	17
Setup	
Part names and functions	18
Setup overview	22
Charging the cameras	22
Turning the power on for the cameras	23
Downloading the [HomeHawk] app	23
Connections for access point	24
Initial setup	24
Registering the cameras	25
Confirming the camera installation area	26
Camera installation	26
Testing the motion detection range	30
Registering another mobile device	31
Appendix	
Features available when using the [HomeHawk] app	32
Accessing the User's Guide	32
Specifications	32
Open source software notice for access point	33
Software information for access point	33
FCC and other information	34
Customer services	35
Limited Warranty (ONLY FOR U.S.A.)	36

Model composition

Model No.	Access point	Front door camera		Outdoor camera	
	Part No.	Part No.	Qty.	Part No.	Qty.
KX-HN7001	KX-HNB700	KX-HNC700	1	–	–
KX-HN7002	KX-HNB700	KX-HNC700	1	KX-HNC710	1
KX-HN7003	KX-HNB700	KX-HNC700	1	KX-HNC710	2

Accessory information

Supplied accessories

No.	Accessory item/Part number	Qty.		
		KX-HN7001	KX-HN7002	KX-HN7003
①	AC adaptor for access point/ PNWYAB700W00	1	1	1
②	Ethernet cable/PNWYAB700W01	1	1	1
③	USB cable/PNWYAC700W00	1	1	1
④	Wall mounting adaptor for front door camera/PNWYAC700W01	1	1	1
⑤	Spacer for front door camera/ PNWYAC700W01	1	1	1
⑥	Wall mounting adaptor for outdoor camera/PNWYAC710W00	-	1	2
⑦	Wall mounting screws 25 mm (1 inch)/ PNWYAC700W02*1	3	6	9
⑧	Suspension wire tool for outdoor camera – Safety wire/PNWYAC710W01 – Washer/PNWYAC710W02 The washer for attaching safety wire to wall \varnothing 16 mm ($5/8$ inches) – Safety wire ring/PNWYAC710W03 The safety wire ring for attaching the safety wire to the camera	-	1	2

- *1 The supplied screws can be used as follows.
- 3 screws for the front door camera
 - 2 screws for each wall mounting adaptor for outdoor camera
 - 1 screw for suspension wire tool

Introduction

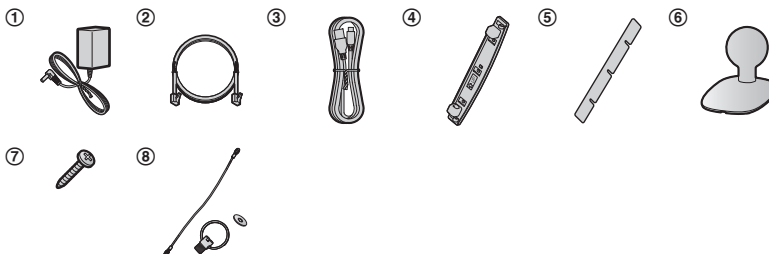

Additional accessories

microSD card (not supplied)

A commercially-available microSD card must be inserted into the access point in order to record images from cameras. The following types of microSD cards are supported.

- microSD / SDHC / SDXC card: Up to 128 GB

Other information

- Design and specifications are subject to change without notice.
- The illustrations in these instructions may vary slightly from the actual product.

Trademarks

- microSDHC, microSDXC Logos are trademarks of SD-3C, LLC.
- iPhone and iPad are registered trademarks of Apple Inc.
- Android and Google Play are registered trademarks or trademarks of Google Inc.
- Microsoft, Windows, and Internet Explorer are either registered trademarks or trademarks of Microsoft Corporation in the United States and/or other countries.
- All other trademarks identified herein are the property of their respective owners.

Notice





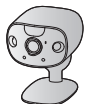







- The access point supports microSDHC and microSDXC memory cards. In this document, the term "microSD card" is used as a generic term for any of the supported cards.
- HomeHawk Front Door is referred to as front door camera or camera in this document.
- HomeHawk Outdoor is referred to as outdoor camera or camera in this document.

Expanding your camera

Outdoor camera (optional): KX-HNC710	
You can expand your camera system by registering optional camera units (16 max.) to the access point.	

Important Information

Graphical symbols for use on equipment and their descriptions

Symbol	Explanation	Symbol	Explanation
	Alternating current (A.C.)		Class II equipment (equipment in which protection against electric shock relies on Double Insulation or Reinforced Insulation)
	Direct current (D.C.)		"ON" (power)
	Protective earth		"OFF" (power)
	Protective bonding earth		Stand-by (power)
	Functional earth		"ON"/"OFF" (power; push-push)
	For indoor use only		Caution, risk of electric shock

About this system

- This system is an auxiliary system; it is not designed to provide complete protection from property loss. Panasonic will not be held responsible in the event that property loss occurs while this system is in operation.
- The system's wireless features are subject to interference, therefore functionality in all situations cannot be guaranteed. Panasonic will not be held responsible for injury or damage to property that occurs in the event of wireless communication error or failure.

For your safety

To prevent severe injury and loss of life/property, read this section carefully before

using the product to ensure proper and safe operation of your product.

WARNING

Power connection

- For the access point, use only the power source marked on the product. For the cameras, 5.0 V, 1.0 A or higher power source.
- Do not overload power outlets and extension cords. This can result in the risk of fire or electric shock.
- Completely insert the AC adaptor/power plug into the power outlet or micro-USB connector into the power supply device's micro-USB jack. Failure to do so may cause electric shock and/or excessive heat resulting in a fire.

For assistance, please visit <http://shop.panasonic.com/support>

5

Important Information

- Regularly remove any dust, etc. from the AC adaptor/power plug by pulling it from the power outlet, then wiping with a dry cloth. Accumulated dust may cause an insulation defect from moisture, etc. resulting in a fire.
- Unplug the product from power outlets if it emits smoke, an abnormal smell, or makes an unusual noise. These conditions can cause fire or electric shock. Confirm that smoke has stopped emitting and contact us at <http://shop.panasonic.com/support>
- Unplug from power outlets and never touch the inside of the product if its casing has been broken open. Danger of electric shock exists.
- Never touch the plug with wet hands. Danger of electric shock exists.
- Do not connect non-specified devices.

Installation

- To prevent the risk of fire or electrical shock, do not expose the access point to rain or any type of moisture.
- Do not place or use this product near automatically controlled devices such as automatic doors and fire alarms. Radio waves emitted from this product may cause such devices to malfunction resulting in an accident.
- Do not allow the power cord to be excessively pulled, bent or placed under heavy objects.
- Do not mount the bracket in a location higher than 2.2 m (7 feet 3 inches), in an unstable location, in a location subject to frequent vibration, or on a weak wall. (Do not mount on gypsum board, concrete blocks, wooden materials exposed to the outdoors, walls with very rough surfaces, or surfaces that are narrower than the width of the wall mount bracket.) There is a risk of injury if the product falls, or of fire or electric shock if water enters the product.
- Keep small parts (microSD cards, screws, etc.) out of the reach of children. There is a risk of swallowing. In the event they are swallowed, seek medical advice immediately.

Operating safeguards

- Unplug the product from power outlets before cleaning. Do not use liquid or aerosol cleaners.
- Do not disassemble the product.
- Never put metal objects inside the product. If metal objects enter the product, turn off the circuit breaker and contact an authorized service center.

Medical

- Consult the manufacturer of any personal medical devices, such as pacemakers or hearing aids, to determine if they are adequately shielded from external RF (radio frequency) energy. Wireless LAN features operate between 2.412 GHz and 2.462 GHz with a peak transmission power as following:
 - Access point: 200 mW
 - Front door camera/Outdoor camera: 100 mW
- Do not use the product in health care facilities if any regulations posted in the area instruct you not to do so. Hospitals or health care facilities may be using equipment that could be sensitive to external RF energy.

CAUTION

Installation and location

- Never install wiring during a lightning storm.
- Although this camera conforms to the IPX5* code, do not intentionally expose it to water.
*IPX5 indicates that the product is protected against water jets: water projected at all angles through a 6.3 mm (1/4 inches) nozzle flow rate of 12.5 liters/minute at a pressure of 30 kN/m² for 3 minutes from a distance of 3 meters (9 feet 10 inches).
- Although this camera conforms to the IP6X* code, do not intentionally expose it to grit and dust.
*IP6X indicates that the product is protected against grit and dust: this product has shown the capabilities of preventing

Important Information

dust from entering inside the product after the product was in a device that contained dust with a diameter of 75 µm or less for 7 hours and was shaken and removed from that device.

- The AC adaptor and the USB cable are used as the main disconnect device. Ensure that the AC outlet is installed near the product and is easily accessible.
- Do not place magnetic cards or similar objects near the outdoor camera. Magnetic data on the cards, etc. may be deleted.

Preventing accidents and injuries

- The safety wire must be used when mounting the product. There is a risk of injury if the product falls. (KX-HN7002/ KX-HN7003)
- Do not put your ear(s) near the speaker, as loud sounds emitted from the speaker may cause hearing impairment.

Lithium Ion (Li-Ion) battery (built-in battery)

- **CAUTION:**
Risk of explosion if battery is replaced by an incorrect type. Dispose of used battery according to local regulations.

Important safety instructions

When using your product, basic safety precautions should always be followed to reduce the risk of fire, electric shock, and injury to persons, including the following:

1. Use only the power cord indicated in this document.

SAVE THESE INSTRUCTIONS

Security cautions

Take appropriate measures to avoid the following security breaches when using this product.

- Leaks of private information

- Unauthorized use of this product
- Unauthorized interference or suspension of the use of this product

Take the following measures to avoid security breaches:

- Configure the access point that connects your mobile device to this product to use encryption for all wireless communication.
- You may be vulnerable to security breaches if the unit is used with the login password at its default value. Configure your own value for this settings.
- Do not use passwords that could be easily guessed by a third party. If you keep a record of your passwords, protect that record. Change passwords regularly.
- If you lose your mobile device, change the password used to access this product.
- If you enable the product's auto login feature, enable the screen lock or similar security feature on your mobile device.
- Take care when performing important security related operations such as initializing settings, etc.
- To prevent disclosure of personal information, enable the screen lock or similar security feature on your mobile device.
- When submitting the product for repair, make a note of any important information stored in the product, as this information may be erased or changed as part of the repair process.
- Before handing the product over to a third party for repair or other purposes, perform a factory data reset to erase any data stored in the product and remove the microSD card. Use only trusted repair services authorized by Panasonic.
- Before disposing of the product, perform a factory data reset to erase any data stored in the product. Remove and erase the microSD card.
- If your mobile device will no longer be used with the product, delete your mobile device's registration from the product and delete the corresponding app from your mobile device.
- If this product experiences a power outage, its date and time setting may become incorrect. In this case, the date and time

Important Information

setting will be automatically corrected when your mobile device and this product are connected to the same wireless network.

Additionally, note the following.

- Communications may be interrupted depending on network conditions and wireless signal quality.
- This product may be used in ways that violate the privacy or publicity rights of others. You are responsible for the ways in which this product is used.

For best performance

Product location/avoiding noise

The access point and cameras use radio waves to communicate with each other.

- For maximum coverage and noise-free communications, place your access point:
 - at a convenient, high, and central location with no obstructions.
 - away from electronic appliances such as TVs, radios, personal computers, wireless devices, or other phones.
 - facing away from radio frequency transmitters, such as external antennas of mobile phone cell stations (Avoid putting the access point on a bay window or near a window.)
- If the reception for the access point is not satisfactory, move this to another location.

Environment

- Keep the product away from electrical noise generating devices, such as fluorescent lamps and motors.
- The product should be kept free from excessive smoke, dust, high temperature, and vibration.
- Do not expose this product to direct sunlight or other forms of powerful light such as halogen lights for long periods of time. (This may damage the image sensor.)
- Do not place heavy objects on top of the product.
- When you leave the product unused for a long period of time, do as follows:

- Access point: Unplug the product from the power outlet.
- Front door camera/Outdoor camera:

Turn off the power slide switch.

- The product should be kept away from heat sources such as heaters, kitchen stoves, etc. It should not be placed in rooms where the temperature is less than -20 °C (-4 °F) or greater than 50 °C (122 °F). Damp basements should also be avoided.
- The maximum communication range may be shortened when the product is used in the following places: Near obstacles such as hills, tunnels, underground, near metal objects such as wire fences, etc.
- Operating the product near electrical appliances may cause interference. Move away from the electrical appliances.

Privacy and rights of portrait

When installing or using the camera, please take into consideration the rights of others with regard to privacy.

It is generally said that "privacy" means the ability of an individual or group to stop information about themselves from becoming known to people other than those whom they choose to give the information. "Rights of portrait" means the right to be safe from having your own image taken and used indiscriminately without consent.

Other information

This product has a rechargeable lithium ion battery. Do not throw into fire, apply heat, or charge, use, or leave in a high temperature environment.

- Doing so may cause fluid leak, overheating, or explosion.

Routine care

- Wipe the outer surface of the product with a soft moist cloth.

Important Information

- Do not use benzine, thinner, or any abrasive powder.

Camera image quality

- Camera images may have the following characteristics.
 - Colors in images may differ from the actual colors.
 - When there is light behind the subject (i.e., backlighting), faces may appear dark.
 - Image quality may be reduced in dark locations.
 - Images may appear hazy when there are outdoor lights in use.

Protecting your recordings

- Do not remove the microSD card or disconnect the product's AC adaptor while reading or writing data to the microSD card. Data on the card could become corrupted.
- If a microSD card malfunctions or is exposed to electromagnetic waves or static electricity, data on the card could become corrupted or erased. Therefore we recommend backing up important data to a computer or other device.

Notice for product disposal, transfer, or return

- This product can store your private/confidential information. To protect your privacy/confidentiality, we recommend that you erase information from the memory before you dispose of, transfer, or return the product.

Notice for built-in battery

ATTENTION:

A lithium ion battery that is recyclable powers the product you have purchased. Please call

1-800-8-BATTERY (1-800-822-8837) for information on how to recycle this battery.



WARNING for Lithium Ion (Li-ion) Battery:
Risk of fire and burns. Do not open, crush, heat above 50 °C (122 °F) or incinerate. Follow the instructions in the operating instructions.

Remove the built-in rechargeable battery before disposing of the cameras. Do not dismantle or replace the battery so that you can use the camera again. This could cause fire or an electric shock. Replace it at an authorized service center.

Important Information

Battery removal procedure

■ Front door camera

- Disconnect the power cord from the camera when removing the battery.
- Remove the stickers (1) before removing the screws (2).

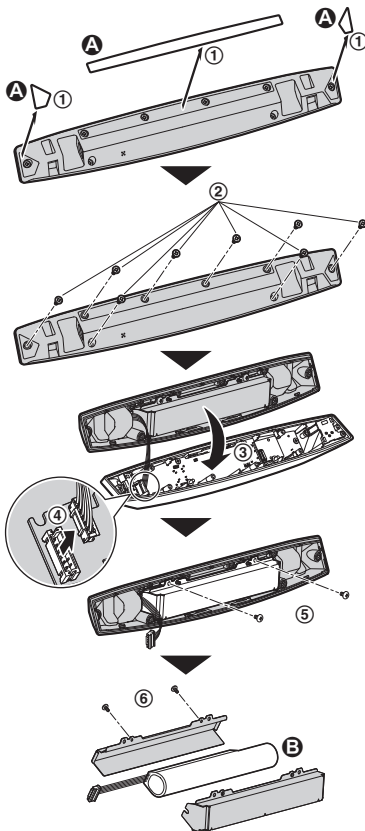

A Stickers

B Battery

- Perform steps 1 to 6, lift the battery (B), and then remove it.

■ Outdoor camera

- Disconnect the power cord from the camera when removing the battery.

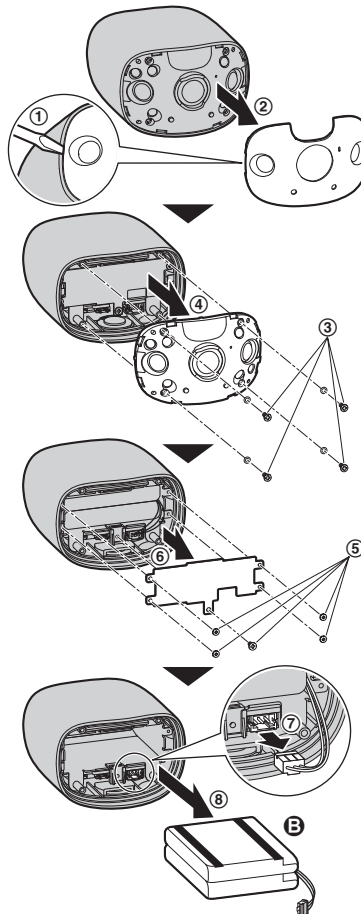

B Battery

- Perform steps 1 to 8, lift the battery (B), and then remove it.

Important Information

Notice

- This product is designed for use in the United States of America. Sale or use of this product in other countries may violate local laws.
- Cet appareil est conçu pour être utilisé aux États-Unis d'Amérique. La vente ou l'emploi de cet appareil dans certains autres pays peut constituer une infraction à la législation locale.
- Este producto está diseñado para usarse en los Estados Unidos de América. La venta o el empleo de este producto en ciertos países puede constituir violación de la legislación local.
- 本產品專為美國使用而設。若在其他國家銷售或使用，可能會違反當地法例。
- この製品は、日本国外での使用を目的として設計されており、日本国内での使用は法律違反となります。従って、当社では日本国内においては原則として修理などのサービスは致しかねます。

Installation Location

Wireless communication range

The wireless communication range of each device in the system from the access point is approximately 100 m (up to 328 feet). Wireless communication may be unreliable when the following obstacles are located between the access point and other devices.

- Metal doors or screens
- Walls containing aluminum-sheet insulation
- Walls made of concrete or corrugated iron
- Double-pane glass windows
- Multiple walls
- When using each device on separate floors or in different buildings

Note:

- The access point cannot connect wirelessly to devices other than the front door camera or outdoor camera.
- The camera's LED indicator blinks slowly in red if it is out of range of the access point. In this case, confirm all connections, including those of the access point.
- The signal strength can be checked with the **[HomeHawk]** app. For more information, refer to the User's Guide (page 32).

Information about sensor features

The cameras have 2 sensor features that are used for motion detection: a visual sensor and an infrared sensor (i.e., heat sensor).

Please read the following information before deciding where to install the camera.

Note:

- The camera's sensor features are not designed to be used in situations that require high reliability. We do not recommend use of the sensor features in these situations.
- Panasonic takes no responsibility for any injury or damage caused by the use of the camera's sensor features.

Detection method

Visual sensor	Infrared sensor
The camera detects changes in the images being displayed. <ul style="list-style-type: none">● The camera detects changes in the brightness levels of moving objects.	The camera detects temperature differences of objects in the images being displayed. <ul style="list-style-type: none">● The infrared sensor uses infrared rays to detect temperature differences within its range that are emitted naturally by people, animals, etc.

Installation Location

Detection range

Visual sensor

Can detect motion anywhere in the visible image.

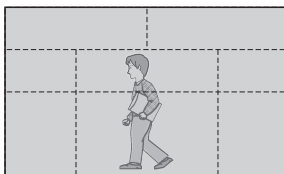

- You can adjust the area detectable by the visual sensor. For more information, refer to the User's Guide (page 32).

Main characteristics

Visual sensor	Infrared sensor
<p>Easily detects movement in the daytime or when it is bright. Through the use of white LEDs or IR-LEDs, movement can also be detected when it is dark.</p> <ul style="list-style-type: none">• Movement may be incorrectly detected when the moving object and the background have a similar color.• Movement may be incorrectly detected when there are sudden changes to the overall brightness levels such as when external lights are used.	<p>Easily detects when there is a big difference between the temperatures of objects and the surrounding environment, such as in winter or late at night.</p> <ul style="list-style-type: none">• The sensor cannot easily detect when there is no difference between the temperatures of objects and the surrounding environment.• If the camera is mounted facing a road, the sensor may detect incorrectly due to interference caused by the heat from passing cars.

Information about night vision mode

The cameras feature color night vision mode, which allows camera images to be viewable even when the surrounding area is dark.

Note:

- When **[Color]** is selected for the night vision mode, the white LEDs are lit enabling images to be displayed in color.
- When **[Monochrome]** is selected for the night vision mode, the array of infrared LEDs that surround the camera's lens light up in a faint red color that can be seen in the dark. The visibility range for **[Monochrome]** in dark conditions is longer than for **[Color]**.
- If the camera is installed in front of a window and points directly at the window, images may be poor when night vision mode is active.

Installation Location

Installation location examples



Important:

- Install the front door camera with a height of up to 2.2 m (7 feet 3 inches) from the ground.
- When possible, install the front door camera more than 2.5 m (8 feet 2 inches) away from streets.

I want to detect visitors approaching the house

Refer to the table below for detecting visitors at an entrance or gate without detecting cars in the street.

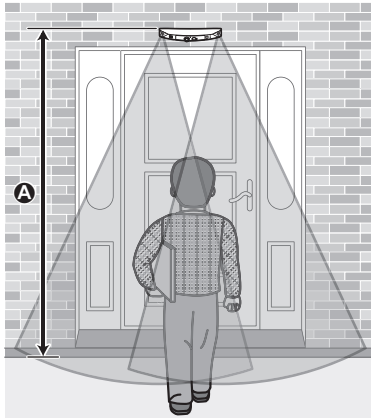
■ Front door camera

Ideal example	Poor example
	
<p>A Approx. 2.2 m (7 feet 3 inches) Only visitors pass in front of the camera and there are no objects to cause false detections.</p>	<p>Hanging plants on the side of the door are more likely to cause false detections.</p>

Note:

- The visual detection range is as follows.
 - Horizontal: 150°
 - Vertical: 85°

Installation Location

■ Outdoor camera

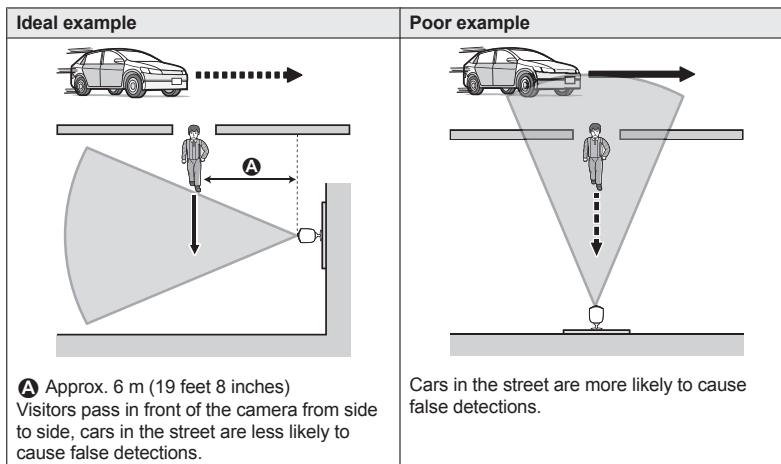

Note:

- The visual detection range is as follows.
 - Horizontal: 150°
 - Vertical: 85°

Installation Location

I want to detect people entering the garage

Refer to the table below for detecting people entering a garage without detecting cars in the street.

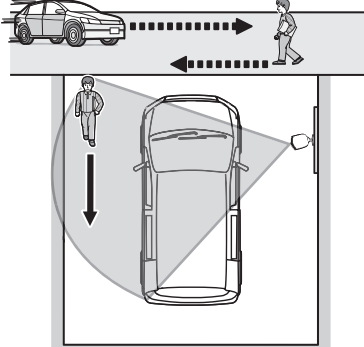
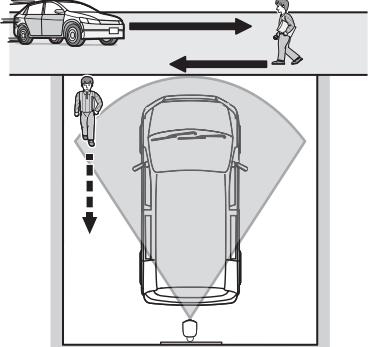
Ideal example	Poor example
 <p>Visitors pass in front of the camera from side to side, cars in the street are less likely to cause false detections.</p> <ul style="list-style-type: none">● To prevent faces from being obscured by tall vehicles, adjust the installation position and angle of the camera.	 <p>Cars in the street are more likely to cause false detections.</p>

Note:

- The visual detection range is as follows.
 - Horizontal: 150°
 - Vertical: 85°

Do not install in these locations

Installing in the following areas may cause deformation, discoloration, malfunction, or operational failure

- In direct sunlight or directly under an outdoor light (even if the surroundings are within operational temperature range, parts of the product may become hot)
- Areas subject to frequent vibration, shock, or impact
- Near fire, heating devices, or air conditioners (including outdoor equipment such as unit compressors)
- Areas exposed to grease or steam
- Near devices that emit strong radio waves, such as mobile phones
- Areas subject to extreme temperature changes (which can lead to condensation). If condensation occurs, wipe the outer surface of the product with a soft dry cloth.
- Near coasts directly subjected to sea breezes, or near sulfuric hot springs (exposure to salt can shorten the life of the product)
- Near TVs, radios, automated office equipment such as computers, air conditioners, water heater panels (with intercom), or home security equipment (these may cause noise)
- Near satellite broadcasting receivers such as tuners, TVs with built-in satellite tuners, and recorders (broadcasted images may be distorted)
- Areas where hydrogen sulfide, ammonia, dust, or toxic gases are present

Installing in the following areas may cause false detections

- Areas where people approach directly from the front of the camera, such as narrow walkways (outdoor camera)
- Areas where objects such as trees or hanging laundry move due to wind

(temperature variation and motion may cause false detections)

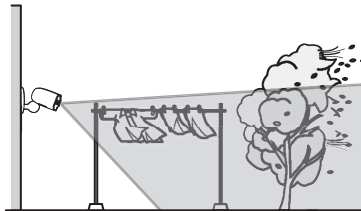

- Areas affected by breezes from fans, air conditioning unit compressors, water heaters, or car exhaust (severe temperature variations may cause false detections)

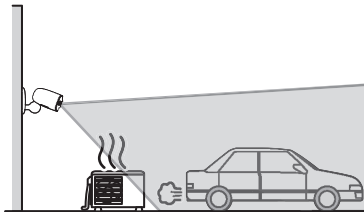

- Areas subject to severe weather, such as strong wind (camera shake can cause false detections) or rain (strong rain may be detected as an object moving in front of the camera)
- Areas with reflective objects, such as glass, that can interfere with detection of temperature variation
- Areas where brightness changes easily
- Areas where backlight occurs (faces appear dark and are difficult to identify), such as the following
 - Areas where most of the background is the sky
 - Areas where direct sunlight reflects off a white wall or background
 - Bright areas such as those exposed to direct sunlight

Setup

Part names and functions

Access Point

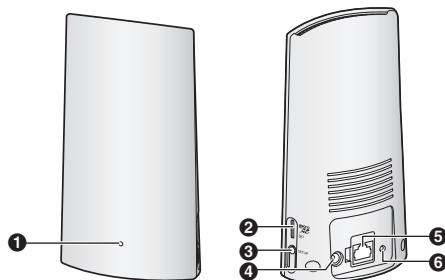

- 1 LED indicator
- 2 microSD card slot
- 3 [SETUP]

- 4 DC jack
- 5 LAN jack
- 6 Reset button

Access point LED indicator

You can use the LED indicator to confirm the access point's status.

Access point LED indicator	Status
Off	No power, or LED indicator is turned off*1
Amber, lit	Power on until start up completed
Amber, blinking quickly	IP address is not obtained, or Ethernet cable is not connected to the router
Green, lit	Power is on (normal operations)*1, or registration completed for the camera or smartphone
Green, blinking slowly	Registration mode, updating
Green, blinking quickly	Obtaining an IP address, or accessing a microSD card*1
Green, lit ↔ Amber, lit (alternating)	Starting up*2
Red, lit	Registration failed

*1 You can configure the access point so that its LED indicator does not light during normal operation. For more information, refer to the User's Guide (page 32).

*2 It may take some time for the access point to finish starting up.

Camera

■ **Front door camera**

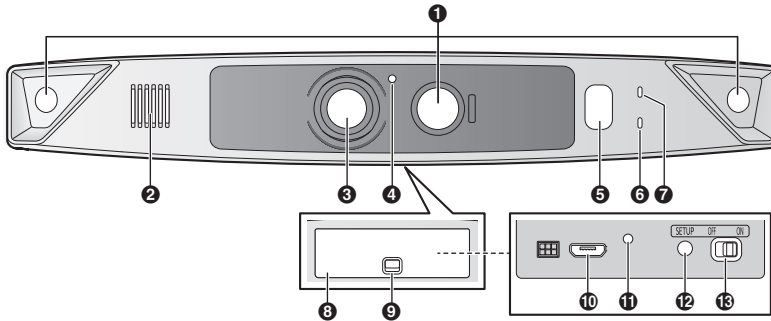

- ① Infrared sensor
- ② Speaker
- ③ Lens
- ④ Light sensor
- ⑤ White LED lens
- ⑥ LED indicator
- ⑦ Microphone

- ⑧ Interface cover
- ⑨ Lock key
- ⑩ micro-USB connector
- ⑪ Charging LED indicator
- ⑫ [SETUP]
- ⑬ Power slide switch

Setup

■ Outdoor camera (KX-HN7002/KX-HN7003)

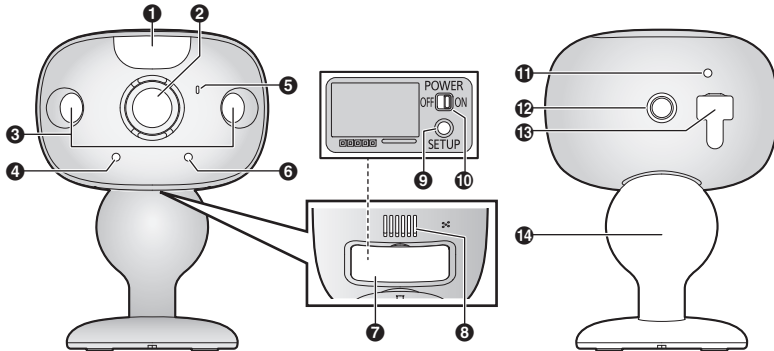

- ❶ White LED lens
- ❷ Lens
- ❸ Infrared sensors
- ❹ LED indicator
- ❺ Microphone
- ❻ Light sensor
- ❼ Interface cover

- ❽ Speaker
- ❾ [SETUP]
- ❿ Power slide switch
- ⓫ Charging LED indicator
- ⓬ Camera nut
- ⓭ USB cover/micro-USB connector
- ⓮ Wall mounting adaptor

Camera LED indicators

You can use the LED indicators to confirm the camera's status.

Camera LED indicator	Status
Off	<ul style="list-style-type: none"> ● No power ● More than 5 seconds have passed since turning on the power when the camera is not registered to the access point ● LED indicator is turned off*1
Green or amber, blinking quickly - off for 1 second	Camera is on*1
Amber, lit	Not registered to the access point*2, or signal level is good*3
Green, lit	Registration successfully completed or signal level is strong*3
Green, blinking quickly	Camera is searching for an access point*1
Red, lit	Registration failed, signal level is weak*3, or detecting motion*1
Red, blinking quickly	Streaming data*1
Amber, blinking slowly	Battery is running low*1
Green, blinking slowly	Registration mode, updating
Red, blinking slowly	Camera is out of range of the access point*1,*3

*1 You can configure the camera so that its LED indicator does not light during normal operation. For more information, refer to the User's Guide (page 32).

*2 The LED indicator lights in amber for 5 seconds after the power is turned on for the camera.

*3 The signal level (strong, good, weak, out of range) is shown after pressing **[SETUP]** for 3 seconds.

Setup

Setup overview

- 1 Charging the cameras**
Make sure the battery is fully charged before you setup the cameras.
- 2 Turning the power on for the cameras**
Turn the power on.
- 3 Downloading the application**
Download the [HomeHawk] app to your mobile device.
- 4 Connection for access point**
Connect the AC adaptor and Ethernet cable to the access point.
- 5 Initial setup**
Make sure you can access the system using your mobile device.
- 6 Registration**
Required only if the camera was purchased separately (i.e., not as part of a bundle).
- 7 Confirm the installation area**
Read the information in this document to confirm that the desired installation area is suitable to proper operation.
- 8 Installation**
Install the camera in the desired location.

Charging the cameras

- This camera has an internal rechargeable battery.
- Remove the camera from the wall before charging (page 28).
- Make sure to charge the camera indoors and in a dry location.
- Charge the camera in a location with a temperature between 5 °C and 40 °C (41 °F and 104 °F). The camera cannot charge in locations outside of these temperatures.

Charging the front door camera

Charge for about 7 hours.

- Turn the camera off before charging the battery. If the camera is turned on while charging, it may take longer to charge.
- 1** Slide the lock key (①).
 - 2** Open the interface cover (②).
 - 3** Insert the USB cable into the micro-USB connector (③).

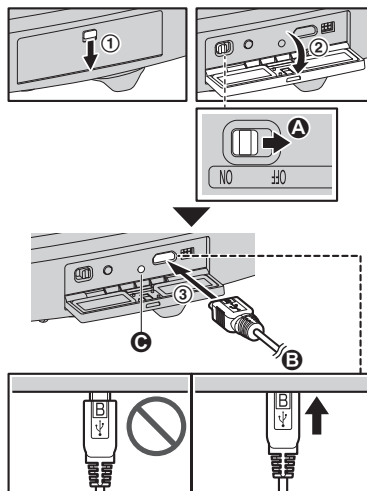

- A** Power off
B 5.0 V, 1.0 A or higher power source
We recommend using the supplied USB cable.
C Charging LED indicator

Note:

- Check the charging LED indicator continues to blink in red for more than 10 seconds after connecting the USB cable. If the indicator stops blinking and turns off within 10 seconds, perform the following.
 - If you are not using the supplied USB cable, use it.
 - If the indicator still turns off within 10 seconds, try connecting the USB cable

to a different power source (5.0 V, 1.0 A or higher).

Charging the outdoor camera

Charge for about 7 hours.

- Turn the camera off before charging the battery. If the camera is turned on while charging, it may take longer to charge.

- 1 Open the USB cover (1).
- 2 Insert the USB cable into the micro-USB connector (2).

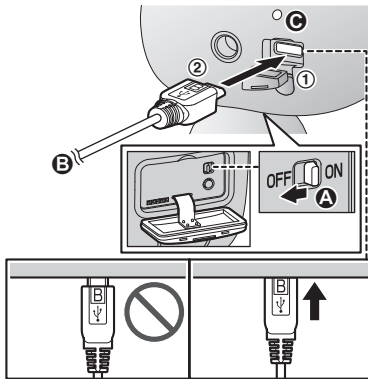

- A** Power off
- B** 5.0 V, 1.0 A or higher power source
We recommend using the supplied USB cable.
- C** Charging LED indicator

Note:

- Check the charging LED indicator continues to blink in red for more than 10 seconds after connecting the USB cable. If the indicator stops blinking and turns off within 10 seconds, perform the following.
 - If you are not using the supplied USB cable, use it.
 - If the indicator still turns off within 10 seconds, try connecting the USB cable to a different power source (5.0 V, 1.0 A or higher).

Camera charging LED indicators

You can use the charging LED indicators to confirm the charging status of the cameras.

Camera indicator	Status
Red, lit	Charging is completed
Red, blinking slowly	Charging
Red, blinking quickly	Charging failure

Turning the power on for the cameras

Open the cover of the cameras, and then slide the power slide switch to ON. (page 19, ■ Front door camera 18, page 20, ■ Outdoor camera 10)

Downloading the [HomeHawk] app

Download information is available at the web page listed below.



<https://panasonic.net/cns/pcc/support/homehawk>

Using your device's app store

iPhone, iPad users

Search for "Panasonic HomeHawk". iPad users should search in the "iPhone only" category.

Android™ device users

Search for "Panasonic HomeHawk".

Compatible mobile devices

Please check the latest information at the following supported page.

Setup

<https://panasonic.net/cns/pcc/support/homehawk>

- iPhone® and iPad® (iOS 10.0 and later) or Android™ devices (Android 4.1 and later) (As of October 2017)

Note:

- The [**HomeHawk**] app may not function properly depending on the system environment, such as the model of your mobile device, peripherals connected to your mobile device, and the apps installed on your mobile device.
- The following Android devices are not compatible with the [**HomeHawk**] app.
 - Android devices that are not supported by Google Play™
 - Android devices with limited hardware features (Bluetooth, wireless LAN, and microphone support are required.)

Connections for access point

Note:

- Use only the supplied AC adaptor.
- 1 Insert the AC adaptor DC plug into the DC jack (①), then connect the AC adaptor to the power outlet (Ⓐ).
 - 2 Insert the Ethernet cable into the LAN jack (②), then connect the Ethernet cable to your router (Ⓑ).

- 3 Insert a microSD card (not supplied) into the unit's microSD card slot (③).

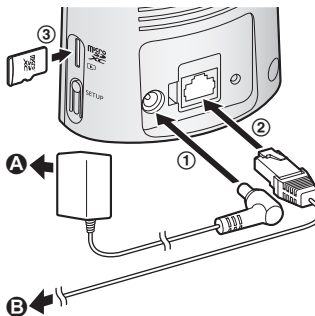

Note about power connections

AC adaptor connection

- The AC adaptor must remain connected at all times. (It is normal for the adaptor to feel warm during use.)
- The AC adaptor should be connected to a vertically oriented or floor-mounted AC outlet. Do not connect the AC adaptor to a ceiling-mounted AC outlet, as the weight of the adaptor may cause it to become disconnected.

Power failure

- The access point will not work during a power failure.

Initial setup

Confirm the following before you begin.

- Make sure you have installed the [**HomeHawk**] app on your mobile device
- Make sure the access point and your wireless router are turned on and the access point's LED indicator is blinking quickly in amber or lit in green
- Make sure your access point and mobile device are connected to your wireless router
- Make sure your mobile device can connect to the Internet

- 1 Start the **[HomeHawk]** app.
 - The end-user license agreement is displayed the first time you start the app.
- 2 Follow the on-screen instructions.
- 3 Tap **[Access Point]**, wait for a while, and then follow the on-screen instructions.
 - Perform the following according to the status of the access point's LED indicator.
 - Lights in green: Tap the green lit button, and then go to step 4.
 - Blinks in amber quickly: Tap the amber blinking button, and then connect the Ethernet cable to the access point and router. Next, follow the on-screen instructions. After waiting for a while, check the color of the LED indicator again.
 - Blinks in green quickly: Tap the green blinking button, check if DHCP (Dynamic Host Configuration Protocol) is operating for the router, and then tap **[OK]**.
- 4 When prompted, press **[SETUP]** on the access point.
- 5 When prompted, set the password that will be used to log in to the access point while away from home and then tap **[OK]**.
- 6 When prompted, enter a name for the access point (if necessary) and for your mobile device and then tap **[OK]**.
 - The app's home screen is displayed when initial setup is completed.

Registering the cameras

The access point and cameras are pre-registered. If for some reason the cameras are not registered to the access point, the camera's LED indicator lights in amber for 5 seconds after turning the power on for the camera.

You can register each camera by using the registration buttons or the **[HomeHawk]** app.

Note:

- If you purchased cameras separately (i.e., not as part of a bundle), you must register each camera to the access point.
- Before registering the camera, make sure the camera is turned on, and that the AC adaptor of the access point is connected and the access point is powered.

Using registration buttons

- 1 **Access point:**
Press and hold **[SETUP]** until the LED indicator (page 18, Access Point **1**) blinks slowly in green.

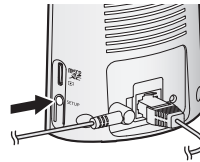

- 2 **Front door camera/outdoor camera*1:**
Press and hold **[SETUP]** until the LED indicator (page 19, ■ Front door camera **6**, page 20, ■ Outdoor camera **4**) blinks slowly in green.

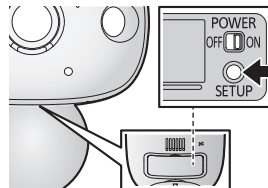
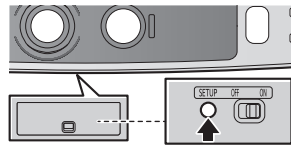

- When registration is completed, the camera sounds one long beep.

*1 KX-HN7002/KX-HN7003 (page 3)

Setup

Note:

- If registration fails, the camera sounds several short beeps.

Using the app

You can change the name of the camera using the [HomeHawk] app. For more information, refer to the User's Guide (page 32).

Confirming the camera installation area

Before deciding where to install the camera, carefully read the chapter "Installation Location", beginning on page 12, to confirm the installation location and direction.

Camera installation

Installation precautions

- Do not use an impact driver. (This may lead to damaged screws or over-tightening.)
- Mount the camera on the stable location with a height of 2.2 m (7 feet 3 inches) where the unit can be adequately supported when installing.
- Do not mount the camera on a soft material. It may fall down, break or cause injury.

Wall material information

Siding

- Use the included screws $\varnothing 4 \text{ mm} \times 25 \text{ mm}$ ($\varnothing 5/32 \text{ inches} \times 1 \text{ inch}$). Make sure the pull-out capacity of each screw is at least 294 N (30 kgf).
- If the weight of the camera is supported by the siding only, the siding could become damaged. Make sure you mount the camera in a location where the structure behind the siding can be used to support the weight of the camera. If this is not possible due to the thickness of the siding,

use commercially-available screws $\varnothing 4 \text{ mm} \times$ longer than 25 mm ($\varnothing 5/32 \text{ inches} \times$ longer than 1 inch).

- Drill a pilot hole using a drill bit that is appropriate for the type of siding. Remove any debris after drilling the pilot hole. Do not drill the pilot hole into the structure behind the siding.

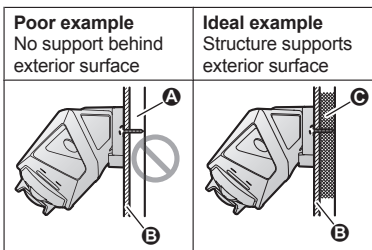

- A** Open space, no support
- B** Siding
- C** Structure behind siding

Concrete

- Do not use the included screws. Use screw anchors (screw $\varnothing 4 \text{ mm}$ ($5/32 \text{ inches}$)) designed for concrete walls.
- Carefully read the instructions supplied with the anchors. Follow instructions regarding drill bit diameter, hole depth, etc.
- Drill a pilot hole. Remove any debris after drilling the pilot hole.

- 1 Mark the hole depth on the drill bit (**A**) and then drill a pilot hole.

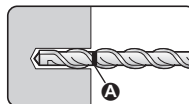

- 2 Remove debris.

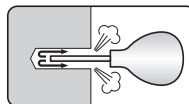

- 3** Insert an anchor, tighten the screw, then remove the screw to secure the anchor.

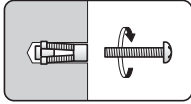

- 4** Insert the screw and tighten it.

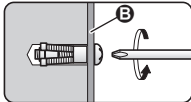

B Wall mounting adaptor

ALC (autoclaved lightweight cellular concrete)

- Depending on the type of ALC panel, you may not be able to attach the camera. Consult the ALC panel manufacturer.
- Do not use the included screws. After consulting the manufacturer of the ALC panel, use only commercially-available metal screw anchors (screw $\varnothing 4$ mm ($5/32$ inches)) designed for ALC panels.
- Carefully read the instructions supplied with the anchors. Follow instructions regarding drill bit diameter, hole depth, etc.
- Drill a pilot hole. Remove any debris after drilling the pilot hole.
- Seal the pilot hole with a commercially-available waterproof sealant.

Other materials (mortar, tile, etc.)

- Do not use the included screws.
- Consult the builder or licensed professional regarding the type of anchor appropriate for the installation location and materials.
- Do not install on gypsum board or concrete blocks.

Installing the front door camera

- 1** Attach the wall mounting adaptor to a porch wall.
- Secure the wall mounting adaptor to the wall by tightening the 3 supplied screws (①).
 - The spacer can be used to adjust the installation angle of the camera as necessary ("Using the spacer", page 28).
 - Do not attach the wall mounting adaptor at an angle or vertically. (This will result in the sensors being unable to correctly make detections.)



- 2** Slide the lock key of the interface cover on the bottom of the camera (②).
- 3** Open the interface cover (③).
- 4** Slide the power slide switch to ON (④).

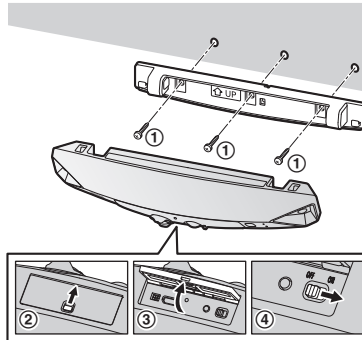

Setup

- 5 Close the interface cover (5) and the lock key (6).
- 6 Match the positions of the hooks of the camera and wall mounting adaptor (7).
- 7 Rotate the camera until you hear a click and the camera is securely mounted.

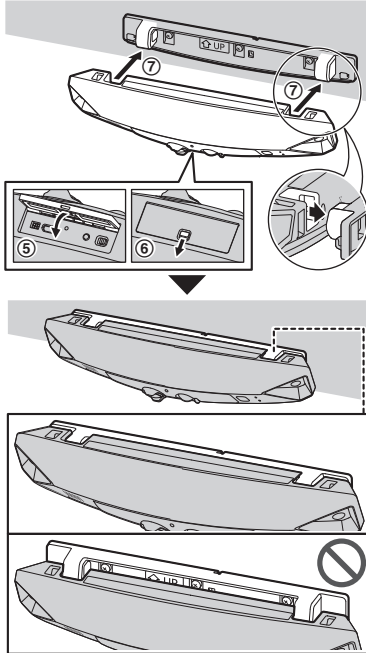

Important:

- Make sure to close the interface cover securely. Water resistance cannot be assured if the interface cover is open.

Using the spacer

Use the supplied spacer to adjust the installation angle of the camera. Insert the spacer between the wall mounting adaptor and the wall.

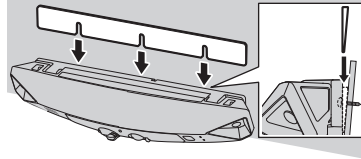

Removing the front door camera

Rotate the camera towards the wall (1), and then pull it away from the wall mounting adaptor (2).

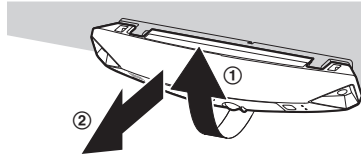

Installing the outdoor camera

- 1 Open the interface cover (①), and then slide the power slide switch to ON (②).
- 2 Close the interface cover (③).
- 3 Secure the safety wire ring to the camera nut of the camera using a driver (④), and then pass the safety wire through the ring of the safety wire ring (⑤).

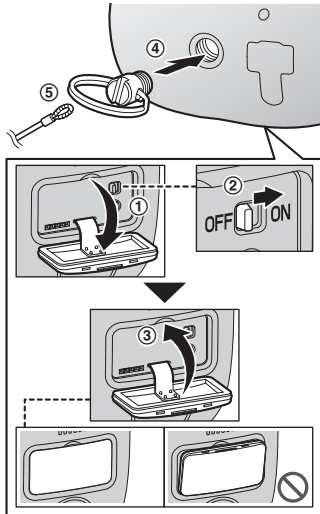

Important:

- Make sure to close the interface cover securely. Water resistance cannot be assured if the interface cover is open.

- 4 Drive the wall mounting screws into the wall.

- Ⓐ Longer than 25 mm (1 inch)
- Ⓑ Space 2.8 mm (1/8 inches)

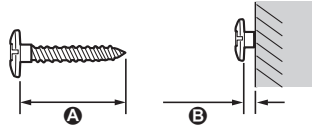

Note:

- Use the following template when determining the location of the screw holes.

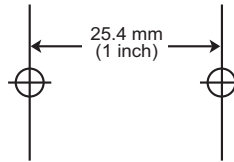

Setup

- 5** Mount the wall mounting adaptor to the wall. Next, attach the safety wire to the wall, and then attach the camera to the wall mounting adaptor.

A Wall mounting screws

B 25.4 mm (1 inch)

C Hole

You can prevent the camera from falling by passing a string through the hole in the wall mounting adaptor.

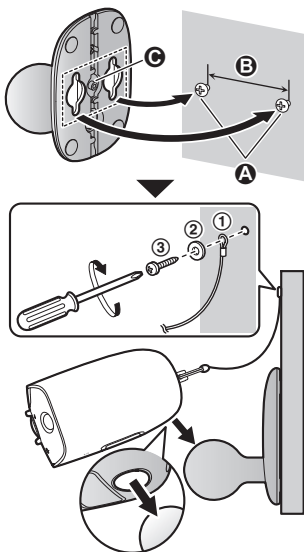

- 6** Adjust the camera angle.

Note:

- Attach the safety wire while it is bent.
- Attach the safety wire high on the wall so that the camera does not strike anyone in the event the camera detaches from the wall.
- Do not hang from the camera or wall mounting adaptor.

Testing the motion detection range

After you have installed the **[HomeHawk]** app on your mobile device, you can use your mobile device to test the performance of the camera's motion detection features.

For details about these operations, refer to the User's Guide (page 32).

- 1** Start the **[HomeHawk]** app and then tap .
- 2** Tap **[Settings]**.
- 3** Tap **[Camera settings]** and select the camera to be tested.
- 4** Tap **[Detection]** → **[Detection Test]**.
- 5** Move to an area within the camera's viewable area.
- 6** While moving near the camera, use your mobile device to observe where you are in the viewable area when the camera's motion detection features are triggered.
- 7** Note the areas of the viewable area where movement is detected, and make adjustments as necessary.

Note:

- You can adjust the area detectable by the visual sensor. For more information, refer to the User's Guide (page 32).

Testing the microphone

To test the microphone, speak loudly and clearly into the microphone while a mobile device user is viewing live images from the camera.

Registering another mobile device

In order to access the system from a mobile device, you must first register the mobile device to the access point. You can register up to 8 mobile devices to an access point. Confirm the following before you begin.

- Make sure you have completed the initial setup procedure
- Make sure your mobile device can connect to the Internet
- Make sure your wireless router and the access point are turned on
- Make sure your mobile device and the access point are connected to the same wireless router

- 1** Using the mobile device that you want to register, download the **[HomeHawk]** app and then start the app.
- 2** Follow the on-screen instructions.
- 3** When prompted, press **[SETUP]** on the access point.
 - Your mobile device will be registered to the access point.
- 4** When prompted, enter the password that will be used to log in to the access point, then tap **[OK]**.
- 5** When prompted, enter a name for your mobile device and then tap **[OK]**.
 - The app's home screen is displayed when initial setup is completed.

Appendix

Features available when using the [HomeHawk] app

Some of the camera's features that are available when using the [HomeHawk] app are listed below. For more information, refer to the User's Guide (page 32).

- **Live camera monitoring**
You can view live images from the camera, even while away from home.
- **Listen and talk**
You can use your mobile device to talk and listen to anyone within range of the camera's microphone and speaker.
- **Sensor adjustment**
You can adjust the camera's motion detection features, such as detection sensitivity and detection area.
- **Notification**
You can configure the camera to send a notification to the [HomeHawk] app when the camera detects motion.

Accessing the User's Guide

The User's Guide is a collection of online documentation that helps you get the most out of the [HomeHawk] app.

- 1 Tap  in the app's home screen.
- 2 Tap **[User's Guide]**.

Note:

- Android 4.1 or later versions are recommended.
- You can also access the User's Guide at the web page listed below.



<https://panasonic.net/cns/pcc/support/homehawk/manual/>

- Microsoft® Windows® Internet Explorer® 8 and earlier versions are not supported.

Specifications

- **Frequency range**
Wireless LAN:
2.412 GHz – 2.462 GHz (channels 1 – 11)
- **RF transmission power**
Wireless LAN:
Access point:
200 mW (peak transmission power)
Front door camera/Outdoor camera:
100 mW (peak transmission power)
- **Power source**
Access point:
120 V AC, 60 Hz
Front door camera/Outdoor camera:
5.0 V, 1.0 A*1
- **Power consumption**
Access point:
Standby: 1.2 W
Maximum: 6 W
- **Battery performance**
Front door camera/Outdoor camera:
Operating time: 7 hours
Approx. 3 months (when used 5 minutes a day)*2
- **Operating conditions**
Access point:
0 °C – 40 °C (32 °F – 104 °F)
20 % – 80 % relative air humidity (dry)
Front door camera/Outdoor camera:
-20 °C – 50 °C (-4 °F – 122 °F)
up to 90 % relative air humidity (non-condensing)
- **Image sensor**
Front door camera/Outdoor camera:
1.0 megapixel CMOS
- **Minimum illuminance required**
Front door camera/Outdoor camera:
IR-LED: 0 lx*3
White LED: 1 lx
- **Focal length**
Front door camera/Outdoor camera:
Fixed 0.2 m (0.7 feet) – infinity
- **Angular field of view (camera angle)**
Front door camera/Outdoor camera:
172°
- **Motion detection method**
Pyroelectric infrared sensor (PIR sensor) and visual sensor

- **PIR sensor detection range (when the surrounding temperature is approx. 25 °C (77 °F))**
Front door camera:
 Horizontal: 170°
 Vertical: 36°
 Detection range: 2.5 m (8 feet 2 inches)
Outdoor camera:
 Horizontal: 170°
 Vertical: 19.1°
 Detection range: 6 m (19 feet 8 inches)
 - **Visual sensor detection range**
Front door camera/Outdoor camera:
 Horizontal: 150°
 Vertical: 85°
 - **IP rating**
Front door camera/Outdoor camera:
 IP65*4
 - **Dimensions (height × width × depth)**
Access point:
 Approx. 179 mm × 94 mm × 52 mm (7 1/16 inches × 3 11/16 inches × 2 1/16 inches)
Front door camera:
 Approx. 58 mm × 271 mm × 61 mm (2 5/16 inches × 10 11/16 inches × 2 3/8 inches)*5
Outdoor camera:
 Approx. 98 mm × 71 mm × 94 mm (3 7/8 inches × 2 13/16 inches × 3 11/16 inches)*5
 - **Mass (weight)**
Access point:
 Approx. 200 g (0.44 lb)
Front door camera:
 Approx. 390 g (0.86 lb)*5
Outdoor camera:
 Approx. 490 g (1.08 lb)*5
- *1 Only when charging.
 *2 Battery performance changes depending on the surrounding temperature, frequency of use, and the actual usage environment. For more information, refer to the User's Guide (page 32).
 *3 The infrared LEDs that surround the camera lens will illuminate in low-light conditions.
 *4 Water resistance is only assured if the camera is installed correctly according to the instructions in the Installation Guide, and appropriate water protection measures are taken.

*5 Including the wall mounting adaptor.

Open source software notice for access point

- Parts of this product use open source software supplied based on the relevant conditions of the Free Software Foundation's GPL and/or LGPL and other conditions. Please read all licence information and copyright notices related to the open source software used by this product. This information is available at the following web page:

<https://panasonic.net/cns/pcc/support/homehawk>

At least three (3) years from delivery of this product, Panasonic Corporation will give to any third party who contacts us at the contact information provided below, for a charge of no more than the cost of physically distributing source code, a complete machine-readable copy of the corresponding source code and the copyright notices covered under the GPL and the LGPL. Please note that software licensed under the GPL and the LGPL is not under warranty.

<https://panasonic.net/cns/pcc/support/homehawk>

Software information for access point

- The End User License Agreement (EULA) for the HomeHawk app is available at the following web page:
<https://panasonic.net/cns/pcc/support/homehawk>

Appendix

FCC and other information

This device complies with Part 15 of the FCC Rules. Operation is subject to the following two conditions:

(1) This device may not cause harmful interference, and (2) this device must accept any interference received, including interference that may cause undesired operation.

Privacy of communications may not be ensured when using this device.

CAUTION:

Any changes or modifications not expressly approved by the party responsible for compliance could void the user's authority to operate this device.

NOTE:

This equipment has been tested and found to comply with the limits for a Class B digital device, pursuant to Part 15 of the FCC Rules. These limits are designed to provide reasonable protection against harmful interference in a residential installation. This equipment generates, uses, and can radiate radio frequency energy and, if not installed and used in accordance with the instructions, may cause harmful interference to radio communications. However, there is no guarantee that interference will not occur in a particular installation. If this equipment does cause harmful interference to radio or television reception, which can be determined by turning the equipment off and on, the user is encouraged to try to correct the interference by one or more of the following measures:

- Reorient or relocate the receiving antenna.
- Increase the separation between the equipment and receiver.
- Connect the equipment into an outlet on a circuit different from that to which the receiver is connected.
- Consult the dealer or an experienced radio/TV technician for help.

Some devices operate at frequencies that may cause interference to nearby TVs and VCRs. To minimize or prevent such interference, this device should not be placed near or on top of

a TV or VCR. If interference is experienced, move this device further away from the TV or VCR. This will often reduce or eliminate interference.

FCC RF Exposure Warning:

- This product complies with FCC radiation exposure limits set forth for an uncontrolled environment.
- To comply with FCC RF exposure requirements, the device must be installed and operated 20 cm (8 inches) or more between the product and all person's body.
- This product may not be collocated or operated in conjunction with any other antenna or transmitter.

FCC Declaration of Conformity

Trade Name: Panasonic

Model Number: KX-HNB700

Responsible Party:

Panasonic Corporation of North America
Two Riverfront Plaza,
Newark, NJ 07102-5490
<http://www.panasonic.com/contactinfo>

FCC Warning:

To ensure compliance with FCC emissions limits, use only the provided USB cable with ferrite core when connecting the unit to a computer.

Notice:

- FCC ID can be found on the following locations.
Access point: bottom of the unit
Outdoor camera: inside the interface cover on the bottom of the unit

Customer services

Shop
Accessories!

for all your Panasonic gear

Go to

<http://shop.panasonic.com/support>

Get everything you need to get the most out of
your Panasonic products

Accessories & Parts for your Camera, Phone, A/V
products, TV, Computers & Networking, Personal
Care, Home Appliances, Headphones, Batteries,
Backup Chargers & more...

Customer Services Directory

For Product Information, Operating Assistance,
Parts, Owner's Manuals, Dealer and Service info
go to <http://shop.panasonic.com/support>

You may also contact us directly at: 1-800-272-7033,

Monday - Friday 9 am to 9 pm;

Saturday - Sunday 10 am to 7 pm, EST.

For the hearing or speech impaired TTY: 1- 877-833-8855

As of June 2015

Appendix

Limited Warranty (ONLY FOR U.S.A.)

Panasonic Products Limited Warranty

Limited Warranty Coverage (For USA Only)

If your product does not work properly because of a defect in materials or workmanship, Panasonic Corporation of North America (referred to as "the warrantor") will, for the length of the period indicated on the chart below, which starts with the date of original purchase ("warranty period"), at its option either (a) repair your product with new or refurbished parts, (b) replace it with a new or a refurbished equivalent value product, or (c) refund your purchase price. The decision to repair, replace or refund will be made by the warrantor.

Product or Part Name	Parts	Labor
Home Network System Products	One (1) Year	One (1) Year
microSD card (Included model only)	90 days	N/A

During the "Labor" warranty period there will be no charge for labor. During the "Parts" warranty period, there will be no charge for parts. This Limited Warranty excludes both parts and labor for non-rechargeable batteries, antennas, and cosmetic parts (cabinet). This warranty only applies to products purchased and serviced in the United States. This warranty is extended only to the original purchaser of a new product which was not sold "as is".

Mail-In Service--Online Repair Request

Online Repair Request

To submit a new repair request and for quick repair status visit our Web Site at <http://shop.panasonic.com/support>

When shipping the unit, carefully pack, include all supplied accessories listed in the Owner's Manual, and send it prepaid, adequately insured and packed well in a carton box. When shipping Lithium Ion batteries please visit our Web Site at <http://shop.panasonic.com/support> as Panasonic is committed to providing the most up to date information. Include a letter detailing the complaint, a return address and provide a daytime phone number where you can be reached. A valid registered receipt is required under the Limited Warranty.

IF REPAIR IS NEEDED DURING THE WARRANTY PERIOD, THE PURCHASER WILL BE REQUIRED TO FURNISH A SALES RECEIPT/PROOF OF PURCHASE INDICATING DATE OF PURCHASE, AMOUNT PAID AND PLACE OF PURCHASE. CUSTOMER WILL BE CHARGED FOR THE REPAIR OF ANY UNIT RECEIVED WITHOUT SUCH PROOF OF PURCHASE.

Limited Warranty Limits and Exclusions

This warranty ONLY COVERS failures due to defects in materials or workmanship, and DOES NOT COVER normal wear and tear or cosmetic damage. The warranty ALSO DOES NOT COVER damages which occurred in shipment, or failures which are caused by products not supplied by the warrantor, or failures which result from accidents, misuse, abuse, neglect, mishandling, misapplication, alteration, faulty installation, set-up adjustments, misadjustment of consumer controls, improper maintenance, power line surge, lightning damage, modification, introduction of sand, humidity or liquids, commercial use such as hotel, office, restaurant, or other business or rental use of the product, or service by anyone other than a Factory Service Center or other Authorized Servicer, or damage that is attributable to acts of God.

THERE ARE NO EXPRESS WARRANTIES EXCEPT AS LISTED UNDER “LIMITED WARRANTY COVERAGE”.

THE WARRANTOR IS NOT LIABLE FOR INCIDENTAL OR CONSEQUENTIAL DAMAGES RESULTING FROM THE USE OF THIS PRODUCT, OR ARISING OUT OF ANY BREACH OF THIS WARRANTY.

(As examples, this excludes damages for lost time, travel to and from the servicer, loss of or damage to media or images, data or other memory or recorded content. The items listed are not exclusive, but for illustration only.)

ALL EXPRESS AND IMPLIED WARRANTIES, INCLUDING THE WARRANTY OF MERCHANTABILITY, ARE LIMITED TO THE PERIOD OF THE LIMITED WARRANTY.

Some states do not allow the exclusion or limitation of incidental or consequential damages, or limitations on how long an implied warranty lasts, so the exclusions may not apply to you. This warranty gives you specific legal rights and you may also have other rights which vary from state to state. If a problem with this product develops during or after the warranty period, you may contact your dealer or Service Center. If the problem is not handled to your satisfaction, then write to:

Consumer Affairs Department
Panasonic Corporation of North America
661 Independence Pkwy
Chesapeake, VA 23320

PARTS AND SERVICE, WHICH ARE NOT COVERED BY THIS LIMITED WARRANTY, ARE YOUR RESPONSIBILITY.

As of June 2015

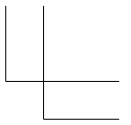
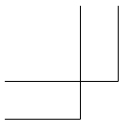

Notes

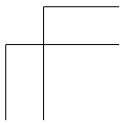
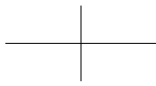
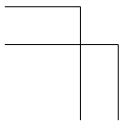
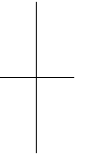
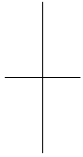

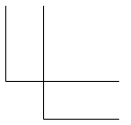
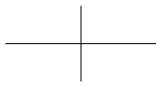
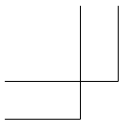

Notes

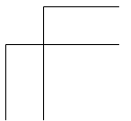
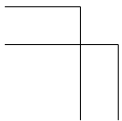
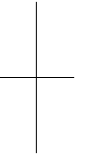
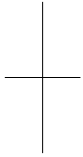

IMPORTANT!

If your product is not working properly. . .

- ① **Reconnect the AC adaptor to the access point.**
- ② **Turn the power slide switch of the camera ON/OFF.**
- ③ Use the **HomeHawk app** to access the **User's Guide**.
and refer to the **Troubleshooting** section.



Visit our Web site: <http://shop.panasonic.com/support>
• **FAQ and troubleshooting hints are available.**

For your future reference

We recommend keeping a record of the following information to assist with any repair under warranty.

Serial No.	Date of purchase
Found on the following locations. Access point: bottom of the unit Front door camera: rear of the unit Outdoor camera: inside the interface cover on the bottom of the unit Name and address of dealer	
Attach your purchase receipt here.	

Panasonic Corporation of North America

Two Riverfront Plaza, Newark, NJ 07102-5490

© Panasonic Corporation 2018



Guía de instalación

Cámara de vigilancia para el hogar Puerta delantera HomeHawk

Modelo N° **KX-HN7001**

Puerta delantera/exterior HomeHawk

Modelo N° **KX-HN7002**

KX-HN7003



El modelo que se muestra es el KX-HN7001.

Gracias por adquirir un producto Panasonic.

Este documento explica cómo configurar el punto de acceso, la cámara para puerta principal y la cámara exterior opcional desde un dispositivo móvil. Se deben seguir estos pasos para poder usar el sistema. Para obtener detalles sobre cómo usar el sistema, consulte la Guía del usuario (página 22).

Cargue las cámaras aproximadamente durante 7 horas antes de instalar la cámara (página 13).

Lea este documento antes de usar la unidad, y guárdelo para consultarlo en el futuro.

Para obtener ayuda, comuníquese con nosotros llamando al 1-800-272-7033 o visite nuestro sitio web: <http://shop.panasonic.com/support> para clientes en los EE. UU. (solo en inglés)

Por favor, registre su producto: <http://shop.panasonic.com/support>



PNQX8681YA

PNQX8681YA CC0118YK1028 (E)

Tabla de Contenido

Ubicación de la instalación

Alcance de la comunicación inalámbrica	3
Información acerca de las características del sensor	3
Información acerca del modo de visión nocturna	4
Ejemplos de ubicaciones para instalación	5
No instale en las ubicaciones siguientes	8

Configuración

Nombres de los componentes y funciones	9
Resumen de configuración	13
Cómo cargar las cámaras	13
Cómo encender la alimentación para las cámaras	14
Cómo descargar la aplicación [HomeHawk]	14
Conexiones para el punto de acceso	15
Configuración inicial	15
Cómo registrar las cámaras	16
Confirmación del área de instalación de la cámara	17
Instalación de la cámara	17
Cómo probar el alcance de detección de movimiento	21
Registro de otro dispositivo móvil	21

Apéndice

Acceso a la Guía del usuario	22
------------------------------------	----

Alcance de la comunicación inalámbrica

El alcance de la comunicación inalámbrica de cada dispositivo en el sistema desde el punto de acceso es de aproximadamente 100 m (hasta 328 pies). Es posible que la comunicación inalámbrica no sea tan confiable cuando se encuentran los siguientes obstáculos entre el punto de acceso y otros dispositivos.

- Puertas o pantallas metálicas
- Paredes que contengan aislamiento de aluminio
- Paredes de hormigón o hierro corrugado
- Ventanas de vidrio doble
- Varias paredes
- Cuando los dispositivos están en pisos o edificios diferentes

Nota:

- El punto de acceso no se puede conectar de manera inalámbrica a otros dispositivos que no sean la cámara para puerta principal o la cámara exterior.
- Si el led indicador de la cámara parpadea lentamente en rojo, se encuentra fuera de alcance del punto de acceso. En este caso, confirme todas las conexiones, incluso las del punto de acceso.
- La intensidad de la señal se puede comprobar con la aplicación **[HomeHawk]**. Para obtener más información, consulte la Guía del usuario (página 22).

Información acerca de las características del sensor

Las cámaras tienen 2 características de sensor que se usan para la detección de movimiento: un sensor visual y un sensor infrarrojo (es decir, sensor de calor).

Lea la información siguiente antes de decidir dónde instalar la cámara.

Nota:

- Las funciones del sensor de la cámara no están preparadas para que se las use en situaciones que requieran alta confiabilidad. No recomendamos el uso de las características del sensor en esas situaciones.
- Panasonic no asume ninguna responsabilidad por lesiones o daños provocados por el uso de las características del sensor de la cámara.

Método de detección

Sensor visual	Sensor infrarrojo
La cámara detecta cambios en las imágenes que aparecen. <ul style="list-style-type: none">● La cámara detecta los cambios en los niveles de brillo de los objetos en movimiento.	La cámara detecta las diferencias de temperatura de los objetos en las imágenes que aparecen. <ul style="list-style-type: none">● El sensor infrarrojo usa rayos infrarrojos para detectar las diferencias de temperatura dentro su alcance que emiten de forma natural las personas, animales, etc.

Ubicación de la instalación

Alcance de detección

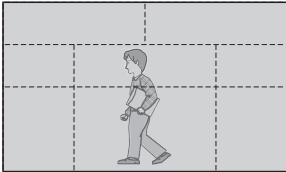
Sensor visual
<p>Puede detectar el movimiento en cualquier parte de la imagen visible.</p> 
<ul style="list-style-type: none">● Puede ajustar el área detectable mediante el sensor visual. Para obtener más información, consulte la Guía del usuario (página 22).

Características principales

Sensor visual	Sensor infrarrojo
<p>Detecta el movimiento de manera fácil durante el día o cuando está alumbrado. El uso de LED blancos o IR LED permite detectar el movimiento cuando está oscuro.</p> <ul style="list-style-type: none">● Es posible que no se detecte correctamente el movimiento cuando el objeto en movimiento y el fondo tengan un color similar.● Es posible que no se detecte correctamente el movimiento cuando haya cambios bruscos en los niveles generales de brillo, como cuando se encienden las luces exteriores.	<p>La detección se facilita cuando hay una gran diferencia entre las temperaturas de los objetos y el entorno, como en invierno o de noche.</p> <ul style="list-style-type: none">● El sensor no puede detectar fácilmente cuando no hay diferencias entre las temperaturas de los objetos y el entorno.● Si la cámara está montada cara a una carretera, es posible que el sensor no detecte de forma correcta debido a la interferencia generada por el calor de los vehículos que pasan.

Información acerca del modo de visión nocturna

Las cámaras tienen la función modo visión nocturna, la cual permite que las imágenes de la cámara puedan verse incluso si los alrededores están oscuros.

Nota:

- Cuando se selecciona [**Color (Rango angosto)**] para el modo visión nocturna, los LED blancos se encienden y permiten que las imágenes aparezcan en color.
- Cuando se selecciona [**Monocromo (Rango amplio)**] para el modo de visión nocturna, la selección de indicadores LED que rodean el lente de la cámara están encendidos en un color rojo tenue que puede verse en la oscuridad.
El rango de visibilidad para [**Monocromo (Rango amplio)**] en la oscuridad no es mayor que para [**Color (Rango angosto)**].
- Si la cámara está instalada frente a una ventana y apunta directamente a la ventana, es posible que la calidad de las imágenes sea baja cuando el modo de visión nocturna esté activo.

Ubicación de la instalación

Ejemplos de ubicaciones para instalación



Importante:

- Instale la cámara para puerta principal a una altura de hasta 2.2 m (7 pies 3 pulgadas) del suelo.
- Cuando sea posible, instale la cámara para puertas principales a más de 2.5 m (8 pies 2 pulgadas) de la calle.

Quiero detectar a los visitantes que se acerquen a la casa

Consulte la tabla siguiente para detectar a los visitantes en la entrada o puerta sin detectar los vehículos de la calle.

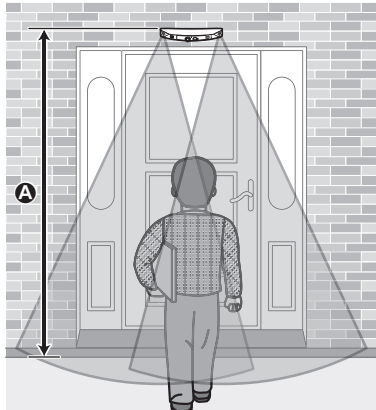
■ Cámara para puerta principal

Ejemplo ideal	Ejemplo incorrecto
	
<p>A Aprox. 2.2 m (7 pies 3 pulgadas) Solo los visitantes pasan en frente de la cámara y no hay objetos que causen detecciones falsas.</p>	<p>Puede que las plantas colgantes al lado de la puerta causen detecciones falsas.</p>

Nota:

- El rango de detección visual es el siguiente.
 - Horizontal: 150°
 - Vertical: 85°

Ubicación de la instalación

■ Cámara exterior

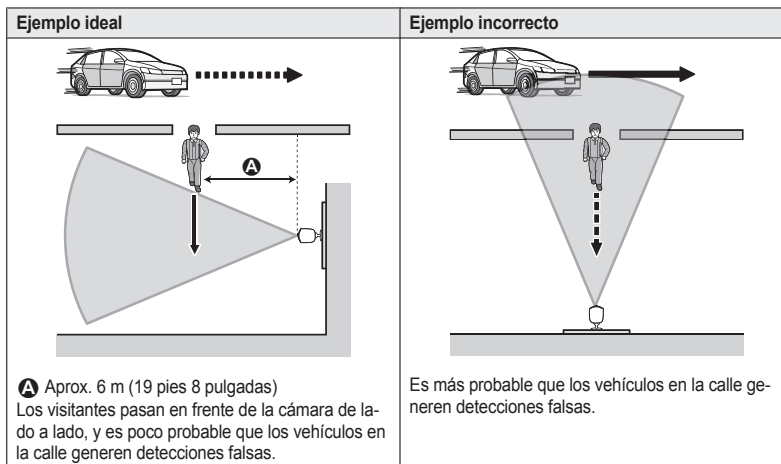

Nota:

- El rango de detección visual es el siguiente.
 - Horizontal: 150°
 - Vertical: 85°

Ubicación de la instalación

Quiero detectar a las personas que ingresen al garaje

Consulte la tabla siguiente para detectar a las personas que ingresen al garaje sin detectar los vehículos de la calle.

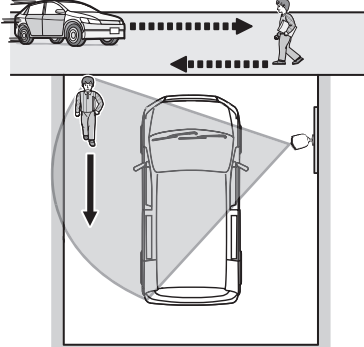
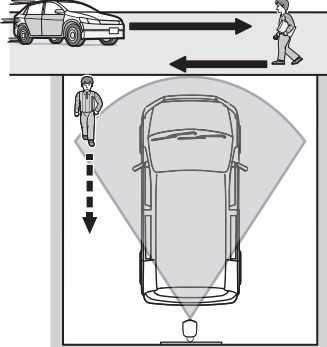
Ejemplo ideal	Ejemplo incorrecto
	
<p>Los visitantes pasan en frente de la cámara de lado a lado, y es poco probable que los vehículos en la calle generen detecciones falsas.</p> <ul style="list-style-type: none">● Para evitar que los vehículos altos oscurezcan los rostros, ajuste la posición de instalación y el ángulo de la cámara.	<p>Es más probable que los vehículos en la calle generen detecciones falsas.</p>

Nota:

- El rango de detección visual es el siguiente.
 - Horizontal: 150°
 - Vertical: 85°

Ubicación de la instalación

No instale en las ubicaciones siguientes

Si se instala en las áreas siguientes puede provocar deformación, falta de color, errores o fallas de operación

- A la luz del sol o bajo una luz exterior (incluso si el entorno está dentro del rango de temperatura funcional, es posible que algunas partes del producto se calienten)
- Áreas sujetas a vibraciones, golpes o impactos frecuentemente
- Cerca del fuego, calefactores o aires acondicionados (incluyendo equipos para exteriores como unidades compresoras)
- Áreas expuestas a grasa o vapor
- Cerca de dispositivos que emiten ondas de radio potentes, como teléfonos móviles
- Áreas sujetas a cambios extremos de temperatura (lo que puede generar condensación).

Si hay condensación, limpie la superficie externa del producto con un paño suave y seco.

- Cerca de costas, donde hay brisa marítima, o cerca de termas de azufre (la exposición a la sal puede reducir la vida útil del producto)
- Cerca de televisores, radios, equipos de oficina automáticos, como ordenadores, aires acondicionados, paneles para calentar agua (con intercomunicador) o equipos de seguridad para el hogar (pueden generar ruido)
- Cerca de receptores de transmisión satelital como sintonizadores, televisores con sintonizadores satelitales incluidos, y grabadoras (es posible que las imágenes transmitidas se distorsionen)
- Áreas donde haya ácido sulfúrico, amoníaco, polvo o gases tóxicos

Si se instala en las áreas siguientes es posible que existan detecciones falsas

- Áreas donde las personas se acercan de forma directa y frontal a la cámara, como en pasillos angostos (cámara exterior)
- Áreas donde objetos como árboles o ropa colgada se mueven por efecto del viento (es

posible que la variación de temperatura y el movimiento causen detecciones falsas)

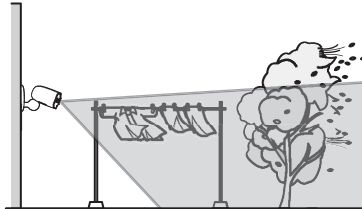

- Áreas afectadas por brisas de ventiladores, unidades compresoras de aires acondicionados, calentadores de agua o caños de escape de vehículos (es posible que las variaciones fuertes de temperatura generen detecciones falsas)

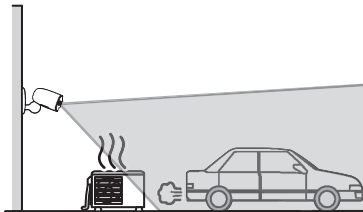

- Las áreas sujetas a malas condiciones climáticas, como vientos fuertes (la cámara puede provocar detecciones falsas al sacudirse) o lluvias (las lluvias fuertes pueden detectarse como objetos en movimiento frente a la cámara)
- Áreas con objetos reflectivos, como vidrios, que pueden interferir con la detección de la variación de temperatura
- Áreas donde el brillo cambia con facilidad
- Áreas donde haya luces de fondo (los rostros se oscurecen y son difíciles de identificar), como las siguientes
 - Áreas donde la mayor parte del fondo es el cielo
 - Áreas donde la luz del sol se refleje en una pared blanca o fondo
 - Áreas brillantes como aquellas expuestas a la luz del sol

Nombres de los componentes y funciones

Punto de acceso

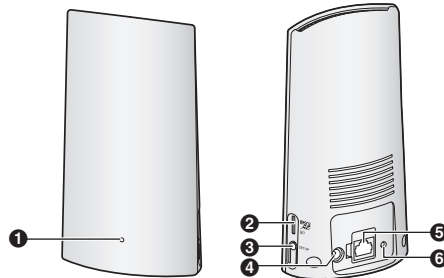

- 1** Led indicador
- 2** Ranura para tarjeta microSD
- 3** **[SETUP]** (Configuración)
- 4** Clavija de corriente continua
- 5** Toma LAN
- 6** Botón de reinicio

Led indicador del punto de acceso

Puede usar el Led indicador para confirmar el estado del punto de acceso.

Led indicador del punto de acceso	Estado
Apagado	Sin energía, o el Led indicador está apagado*1
Ámbar, encendido	Encendido hasta que se complete el inicio
Ámbar, parpadeo rápido	No se obtuvo la dirección IP o el cable Ethernet no está conectado al enrutador
Verde, encendido	El dispositivo está encendido (funcionamiento normal)*1, o se completó el registro de la cámara o el smartphone
Verde, parpadeando lentamente	El modo de registro se está actualizando
Verde, parpadeo rápido	Se está obteniendo una dirección IP o accediendo a una tarjeta microSD*1
Rojo, encendido ↔ Ámbar, encendido (alternando)	Iniciando*2
Rojo, encendido	Falló el registro

*1 Puede configurar el punto de acceso de forma tal que el Led indicador no se encienda durante el funcionamiento normal. Para obtener más información, consulte la Guía del usuario (página 22).

*2 Es posible que el punto de acceso tarde un tiempo en terminar de iniciar.

Configuración

Cámara

■ Cámara para puerta principal

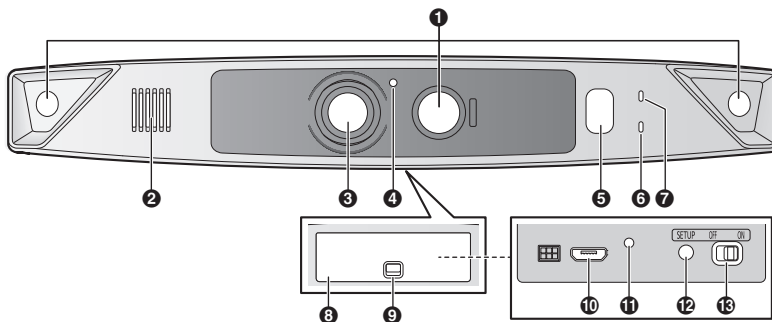

- 1 Sensor infrarrojo
- 2 Altavoz
- 3 Lente
- 4 Sensor de luz
- 5 Lente LED blanco
- 6 Led indicador
- 7 Micrófono

- 8 Tapa de interfaz
- 9 Tecla de bloqueo
- 10 Conector micro-USB
- 11 Carga de Led indicador
- 12 [SETUP] (Configuración)
- 13 Interruptor de encendido

Configuración

■ Cámara exterior (KX-HN7002/KX-HN7003)

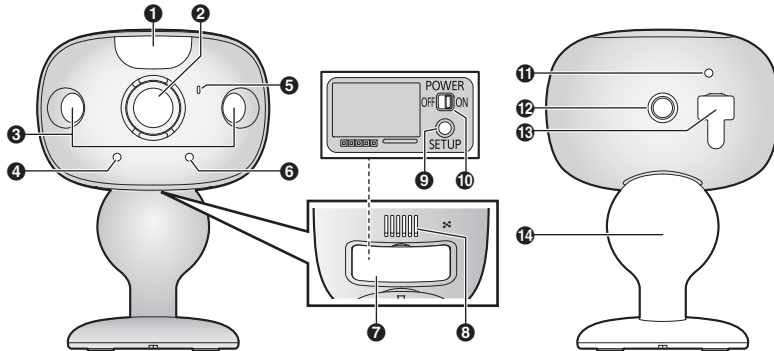

- ❶ Lente LED blanco
- ❷ Lente
- ❸ Sensores infrarrojos
- ❹ Led indicador
- ❺ Micrófono
- ❻ Sensor de luz
- ❼ Tapa de interfaz

- ❸ Altavoz
- ❹ [SETUP] (Configuración)
- ❺ Interruptor de encendido
- ❻ Carga de Led indicador
- ❼ Tuerca de cámara
- ❽ Tapa USB/conector micro-USB
- ❾ Adaptador de instalación en pared

Configuración

Led indicadores de cámara

Puede usar los Led indicadores para confirmar el estado de la cámara.

Led indicador de cámara	Estado
Apagado	<ul style="list-style-type: none">• Sin energía• Han transcurrido más de 5 segundos desde que se encendió la alimentación cuando la cámara no está registrada en el punto de acceso• El indicador LED está apagado*1
Verde o ámbar, parpadeo rápido: apagado por 1 segundos	La cámara está encendida*1
Ámbar, encendido	No registrado en el punto de acceso*2 o el nivel de la señal es bueno*3
Verde, encendido	El registro se completó correctamente o el nivel de la señal es fuerte*3
Verde, parpadeo rápido	La cámara está buscando un punto de acceso*1
Rojo, encendido	Falló el registro, el nivel de la señal es débil*3 o se detecta movimiento*1
Rojo, parpadeo rápido	Datos de transmisión*1
Ámbar, parpadeo lento	La batería se está agotando*1
Verde, parpadeando lentamente	El modo de registro se está actualizando
Rojo, parpadeando lentamente	La cámara está fuera de alcance del punto de acceso*1,*3

*1 Puede configurar la cámara de forma tal que el Led indicador no se encienda durante el funcionamiento normal. Para obtener más información, consulte la Guía del usuario (página 22).

*2 El indicador LED se ilumina en ámbar durante 5 segundos después de que se encienda la alimentación para la cámara.

*3 El nivel de la señal (fuerte, bueno, débil, fuera del alcance) se muestra después de presionar **[SETUP]** (Configuración) durante 3 segundos.

Resumen de configuración

- 1 Cómo cargar las cámaras**
Asegúrese de que la batería esté completamente cargada antes de configurar las cámaras.
- 2 Cómo encender la alimentación para las cámaras**
Enciéndala.
- 3 Descarga de la aplicación**
Descargue la aplicación [HomeHawk] a su dispositivo móvil.
- 4 Conexión para el punto de acceso**
Conecte el adaptador de corriente y el cable Ethernet al punto de acceso.
- 5 Configuración inicial**
Asegúrese de poder acceder al sistema mediante su dispositivo móvil.
- 6 Registro**
Solo se requiere si se compró la cámara por separado (es decir, no como parte de un paquete).
- 7 Confirme el área de instalación**
Lea la información de este documento para confirmar que el área de instalación deseada sea la adecuada para el correcto funcionamiento.
- 8 Instalación**
Instale la cámara en la ubicación deseada.

Cómo cargar las cámaras

- Esta cámara tiene una batería recargable interna.
- Quite la cámara de la pared antes de cargar la batería (página 19).
- Asegúrese de cargar la cámara en interiores y en ubicaciones secas.
- Cargue la cámara en una ubicación con una temperatura de entre 5 °C y 40 °C (41 °F y 104 °F). La cámara no puede cargarse en ubicaciones con temperaturas fuera de ese rango.

Cómo cargar la cámara para puerta principal

Cargue aproximadamente durante 7 horas.

- Apague la cámara antes de cargar la batería. Si la cámara está encendida mientras se carga, podría demorar más tiempo en cargarse.

- 1** Deslice la tecla de bloqueo (①).
- 2** Abra la tapa de la interfaz (②).
- 3** Inserte el cable USB en el conector micro-USB (③).

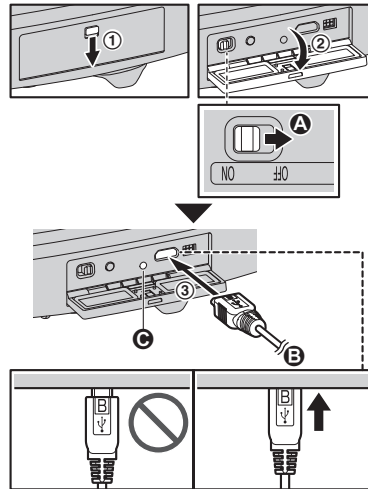

- (A)** Apagado
- (B)** Alimentación eléctrica de 5.0 V, 1.0 A o más
Recomendamos usar el cable USB proporcionado.
- (C)** Cargar el Led indicador

Nota:

- Verifique que el LED indicador de carga siga parpadeando en rojo durante más de 10 segundos después de conectar el cable USB a la cámara.
Si el indicador deja de parpadear y se apaga dentro de los siguientes 10 segundos, realice lo siguiente.
 - Si no está usando el cable USB suministrado, úselo.

Configuración

- Si el indicador se sigue apagando dentro de los siguientes 10 segundos, intente conectar el cable USB en una fuente de alimentación eléctrica diferente (5.0 V, 1.0 A o superior).

Cómo cargar la cámara exterior

Cargue aproximadamente durante 7 horas.

- Apague la cámara antes de cargar la batería. Si la cámara está encendida mientras se carga, podría demorar más tiempo en cargarse.

- 1 Abra la tapa USB (1).
- 2 Inserte el cable USB en el conector micro-USB (2).

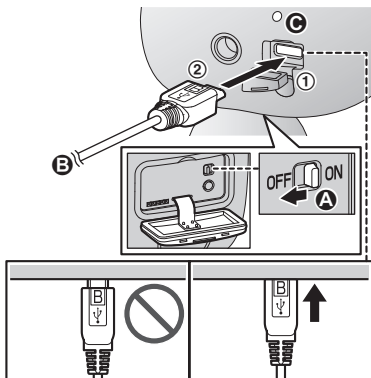

- A** Apagado
- B** Alimentación eléctrica de 5.0 V, 1.0 A o más. Recomendamos usar el cable USB proporcionado.
- C** Cargar el Led indicador

Nota:

- Verifique que el LED indicador de carga siga parpadeando en rojo durante más de 10 segundos después de conectar el cable USB a la cámara. Si el indicador deja de parpadear y se apaga dentro de los siguientes 10 segundos, realice lo siguiente.
 - Si no está usando el cable USB suministrado, úselo.
 - Si el indicador se sigue apagando dentro de los siguientes 10 segundos, intente conectar

el cable USB en una fuente de alimentación eléctrica diferente (5.0 V, 1.0 A o superior).

Led indicadores de carga de cámara

Puede usar los LED indicadores de carga para confirmar el estado de la carga de las cámaras.

Indicador de cámara	Estado
Rojo, encendido	Carga completa
Rojo, parpadeando lentamente	Cargando
Rojo, parpadeo rápido	Falló la carga

Cómo encender la alimentación para las cámaras

Abra la tapa de las cámaras y, a continuación, deslice el interruptor de alimentación a ON. (página 10, ■ Cámara para puerta principal 18, página 11, ■ Cámara exterior 10)

Cómo descargar la aplicación [HomeHawk]

La información de descarga está disponible en la siguiente página web.



<https://panasonic.net/cns/pcc/support/homehawk>

Cómo utilizar la App Store de su dispositivo

Usuarios de iPhone y iPad

Busque "Panasonic HomeHawk". Los usuarios de iPad deberán buscar en la categoría "solo para iPhone".

Usuarios de Android™

Busque "Panasonic HomeHawk".

Dispositivos móviles compatibles

Por favor, revise la última información en la siguiente página de soporte.

<https://panasonic.net/cns/pcc/support/homehawk>

- iPhone® y iPad® (iOS 10.0 y posterior) o dispositivos Android™ (Android 4.1 y posterior) (desde octubre de 2017)

Nota:

- Es posible que la aplicación [HomeHawk] no funcione correctamente dependiendo del entorno del sistema, como el modelo de su dispositivo móvil, los periféricos conectados al mismo y las aplicaciones instaladas en él.
- Los siguientes dispositivos Android no son compatibles con la aplicación [HomeHawk].
 - Dispositivos Android que no son compatibles con Google Play™
 - Dispositivos con Android, con características de hardware limitadas (se requiere compatibilidad con Bluetooth, LAN inalámbrica y micrófono).

Conexiones para el punto de acceso

Nota:

- Use solo el adaptador de corriente alterna que se suministra.
- 1 Inserte el enchufe CC del adaptador de corriente alterna en el conector de CC (1) y, a continuación, conecte el adaptador de corriente (A) a la toma de corriente.
 - 2 Inserte el cable Ethernet en la toma LAN (2) y, a continuación, conecte el punto de acceso al enrutador (B).

- 3 Inserte una tarjeta microSD (no proporcionada) en la ranura para tarjetas microSD (3).

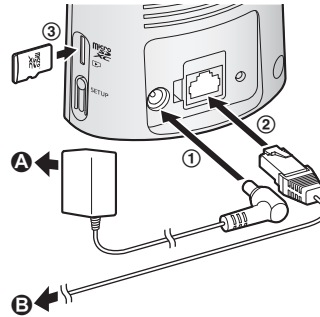

Nota acerca de las conexiones de alimentación

Adaptador de corriente alterna

- El adaptador de corriente debe permanecer conectado en todo momento (es normal que el adaptador se caliente durante su uso).
- El adaptador de corriente debe estar conectado a un enchufe de corriente orientado verticalmente o en una toma de corriente alterna colocada en el piso. No conecte el adaptador de corriente alterna a una toma de corriente montada en el techo, ya que el peso del adaptador puede hacer que se desconecte.

Falla en el suministro eléctrico

- El punto de acceso no funciona durante las fallas del suministro eléctrico.

Configuración inicial

Confirme lo siguiente antes de comenzar.

- Asegúrese de haber instalado la aplicación [HomeHawk] en su dispositivo móvil
- Asegúrese de que el punto de acceso y su enrutador inalámbrico estén encendidos y que el Led indicador del punto de acceso esté encendido en ámbar o verde

Configuración

- Asegúrese de que el punto de acceso y el dispositivo móvil estén conectados al enrutador inalámbrico
- Asegúrese de que su dispositivo móvil pueda conectarse a Internet

- 1 Inicie la aplicación **[HomeHawk]**.
 - El contrato de licencia para el usuario final aparece al iniciar la aplicación por primera vez.
- 2 Siga las instrucciones en pantalla.
- 3 Toque **[Punto de acceso]**, espere un momento, y siga las instrucciones en pantalla.
 - Realice las siguientes acciones según el estado del Led indicador del punto de acceso.
 - Luces en verde: Toque el botón verde encendido y, a continuación, vaya al paso 4.
 - Parpadea en color ámbar rápidamente: Toque el botón ámbar parpadeante y, luego, conecte el cable Ethernet con el punto de acceso y el enrutador. A continuación, siga las instrucciones en pantalla. Después de esperar un momento, vuelva a comprobar el color del Led indicador.
 - Parpadea en verde (rápido): Toque el botón verde parpadeante, compruebe si el DHCP (Protocolo Dinámico de Configuración de Host) funciona en el enrutador y, luego, toque **[Aceptar]**.
- 4 Cuando se le solicite, oprima el botón **[SETUP]** (Configuración) en el punto de acceso.
- 5 Cuando se le solicite, establezca la clave que se utilizará para iniciar sesión en el punto de acceso mientras está fuera de casa y luego toque **[Aceptar]**.
- 6 Cuando se le solicite, si es necesario, introduzca un nombre para el punto de acceso y para el dispositivo móvil y toque **[Aceptar]**.
 - Aparecerá la pantalla de inicio de la aplicación una vez completada la configuración inicial.

Cómo registrar las cámaras

Los puntos de acceso y las cámaras ya están registrados. Si por algún motivo las cámaras no se han registrado en el punto de acceso, el indicador LED de la cámara se ilumina en ámbar durante 5 segundos después de encender la alimentación para la cámara.

Puede registrar cada cámara mediante los botones de registro o la aplicación **[HomeHawk]**.

Nota:

- Si compró cámaras por separado (es decir, no como parte de un paquete), debe registrar cada cámara en el punto de acceso.
- Antes de registrar la cámara, asegúrese de que esté encendida y de que el adaptador de corriente alterna del punto de acceso esté conectado y el punto de acceso esté encendido.

Uso de los botones de registro

- 1 **Punto de acceso:**
Mantenga oprimido **[SETUP]** (Configuración) hasta que el Led indicador (página 9, Punto de acceso 1) parpadee lentamente en verde.

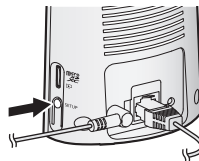

- 2 **Cámara para puerta principal/cámara exterior*1:**
Mantenga oprimido **[SETUP]** (Configuración) hasta que el Led indicador (página 10, ■ Cámara para puerta principal 6, página 11, ■ Cámara exterior 4) parpadee lentamente en verde.

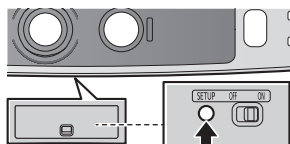

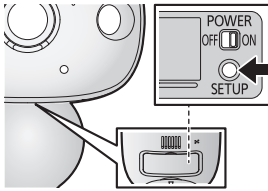

- Cuando se ha completado el registro, la cámara emitirá un pitido largo.

*1 KX-HN7002/KX-HN7003

Nota:

- Si el registro falla, la cámara emitirá varios pitidos cortos.

Uso de la aplicación

Puede cambiar el nombre de la cámara usando la aplicación **[HomeHawk]**. Para obtener más información, consulte la Guía del usuario (página 22).

Confirmación del área de instalación de la cámara

Antes de decidir dónde instalará la cámara, lea con cuidado la "Ubicación de la instalación" en la página 3 para confirmar la dirección y la ubicación de la instalación.

Instalación de la cámara

Precauciones de instalación

- No use un destornillador neumático (esto puede dañar los tornillos o ajustarlos de más).
- Monte la cámara en una ubicación estable con una altura de 2.2 m (7 pies 3 pulgadas) donde la unidad se pueda colocar con seguridad.
- No coloque la cámara sobre un material blando. Podría caerse, romperse o provocar lesiones.

Información sobre el material de instalación

Revestimiento

- Use los tornillos incluidos de $\varnothing 4 \text{ mm} \times 25 \text{ mm}$ ($\varnothing 5/32$ pulgadas \times 1 pulgada). Asegúrese de que la fuerza nominal de cada tornillo sea como mínimo de 294 N (30 kgf).
- El revestimiento podría dañarse, si el peso de la cámara se sostiene solo con el revestimiento. Asegúrese de montar la cámara en un sitio donde la estructura detrás del revestimiento pueda usarse para sostener el peso de la cámara. Si no es posible debido al grosor del revestimiento, use tornillos disponibles de forma comercial de $\varnothing 4 \text{ mm} \times$ más largos de 25 mm ($\varnothing 5/32$ pulgadas \times más largos de 1 pulgada).
- Taladre un orificio con una broca que sea apropiada para el tipo de revestimiento. Retire todos los restos después de taladrar el orificio guía. No taladre el orificio guía en la estructura detrás del revestimiento.

Ejemplo incorrecto
No hay soporte detrás de la superficie exterior

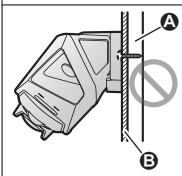

Ejemplo ideal
La estructura sustenta la superficie exterior

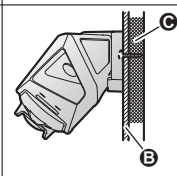

- A** Espacio abierto, no hay soporte
- B** Revestimiento
- C** Estructura detrás del revestimiento

Concreto

- No use los tornillos incluidos. Use los taquetes (tornillos de $\varnothing 4 \text{ mm}$ ($5/32$ pulgadas)) diseñados para paredes de concreto.
- Lea con atención las instrucciones suministradas con los taquetes. Siga las instrucciones sobre el diámetro de la broca, profundidad del orificio, etc.
- Taladre un orificio guía. Retire todos los restos después de taladrar el orificio guía.

Configuración

- 5 Cierre la tapa de la interfaz (5) y la tecla de bloqueo (6).
- 6 Haga coincidir las posiciones de los ganchos de la cámara con el adaptador de instalación en pared (7).
- 7 Gire la cámara hasta que escuche un clic y la cámara quedará instalada de forma segura.

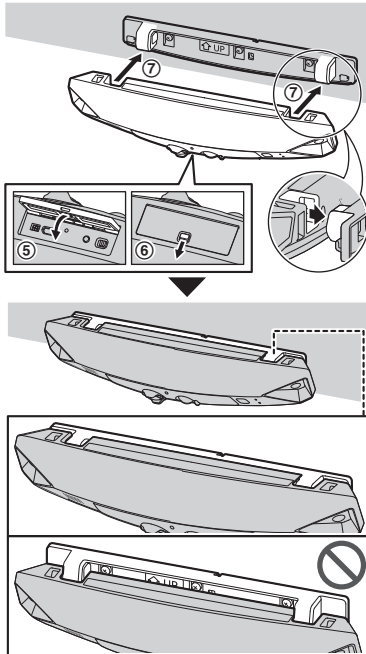

Importante:

- Asegúrese de cerrar la tapa de la interfaz de forma segura. No se puede asegurar la resistencia al agua si la tapa de la interfaz está abierta.

Uso del separador

Use el separador suministrado para ajustar el ángulo de instalación de la cámara.

Inserte el separador entre el adaptador de instalación en pared y la pared.

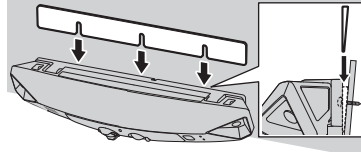

Cómo quitar la cámara para puerta principal

Gire la cámara hacia la pared (1); luego, retírela del adaptador de instalación en pared (2).

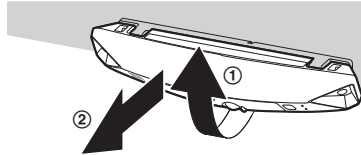

Cómo instalar la cámara exterior

- 1 Abra la tapa de la interfaz (1) y, a continuación, deslice el interruptor de encendido a ON (2).
- 2 Cierre la tapa de la interfaz (3).

Configuración

- 3** Asegure el anillo del cable de seguridad en la tuerca de la cámara usando un destornillador (4) y, a continuación, pase el cable de seguridad a través del anillo del cable de seguridad (5).

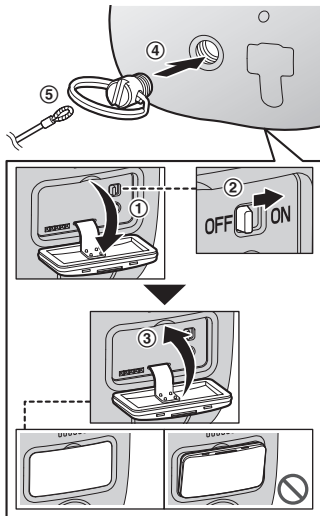

Importante:

- Asegúrese de cerrar la tapa de la interfaz de forma segura. No se puede asegurar la resistencia al agua si la tapa de la interfaz está abierta.
- 4** Coloque en la pared los tornillos de instalación en pared.
- A** Más largo que 25 mm (1 pulgada)
 - B** Espacio de 2.8 mm (1/8 pulgadas)

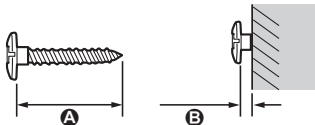

Nota:

- Use la siguiente plantilla cuando determine la ubicación de los orificios de los tornillos.

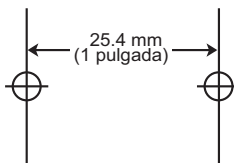

- 5** Monte el adaptador de instalación en pared. Luego, coloque el cable de seguridad en la pared y la cámara en el adaptador de instalación en pared.

A Tornillos para la instalación en pared

B 25.4 mm (1 pulgada)

C Orificio

Puede evitar que la cámara se caiga pasando una cuerda a través del orificio en el adaptador de instalación en pared.

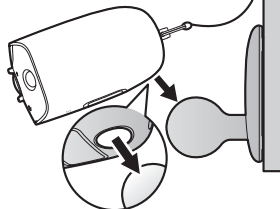
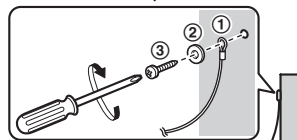
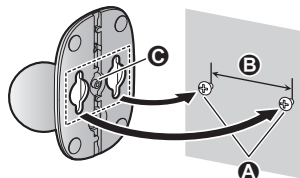

- 6** Ajuste el ángulo de la cámara.

Nota:

- Coloque el cable de seguridad mientras está doblado.
- Coloque el cable de seguridad bien alto para que la cámara no golpee a nadie en caso de que la cámara se desprenda de la pared.
- No se cuelgue de la cámara o del adaptador de instalación en pared .

Cómo probar el alcance de detección de movimiento

Después de instalar la aplicación de **[HomeHawk]** en su dispositivo móvil, puede usarlo para probar el funcionamiento de las características de detección de movimiento de la cámara.

Para obtener más detalles sobre estas operaciones, consulte la Guía del usuario (página 22).

- 1 Inicie la aplicación **[HomeHawk]** y, luego, toque .
- 2 Toque **[Configuración]**.
- 3 Toque **[Ajustes de cámara]** y seleccione la cámara que desea probar.
- 4 Toque **[Detección]** → **[Prueba de detección]**.
- 5 Muévase a un área dentro de la zona visible de la cámara.
- 6 Mientras se mueva cerca de la cámara, use su dispositivo móvil para observar dónde se encuentra en el área visible cuando se activan las características de detección de movimiento de la cámara.
- 7 Observe las zonas del área visible de la cámara cuando se detecta movimiento y haga los ajustes necesarios.

Nota:

- Puede ajustar el área detectable mediante el sensor visual. Para obtener más información, consulte la Guía del usuario (página 22).

Cómo probar el micrófono

Para probar el micrófono, hable fuerte y claro en el micrófono mientras un usuario de dispositivo móvil observa las imágenes en vivo desde la cámara.

Registro de otro dispositivo móvil

Para acceder al sistema desde un dispositivo móvil, primero debe registrarlo en el punto de acceso. Puede registrar hasta 8 dispositivos móviles en un punto de acceso.

Confirme lo siguiente antes de comenzar.

- Asegúrese de haber completado el procedimiento de configuración inicial
- Asegúrese de que su dispositivo móvil pueda conectarse a Internet
- Asegúrese de que el enrutador inalámbrico y el punto de acceso estén encendidos
- Asegúrese de que el dispositivo móvil y el punto de acceso estén conectados al mismo enrutador

- 1 Desde el dispositivo móvil que desea registrar, descargue la aplicación **[HomeHawk]** y luego iníciela.
- 2 Siga las instrucciones en pantalla.
- 3 Cuando se le solicite, oprima el botón **[SETUP]** (Configuración) en el punto de acceso.
 - Se registrará el dispositivo móvil en el punto de acceso.
- 4 Cuando se le solicite, introduzca la clave que se utilizará para iniciar sesión en el punto de acceso y, luego, toque **[Aceptar]**.
- 5 Cuando se le solicite, introduzca un nombre para el dispositivo móvil y toque **[Aceptar]**.
 - Aparecerá la pantalla de inicio de la aplicación una vez completada la configuración inicial.

Apéndice

Acceso a la Guía del usuario

La Guía del usuario es una colección de documentación en línea que lo ayuda a aprovechar al máximo la aplicación **[HomeHawk]**.

- 1 Toque  en la pantalla de inicio de la aplicación.
- 2 Toque **[Guía del Usuario]**.

Nota:

- Se recomienda Android 4.1 y versiones posteriores.
- También puede acceder a la Guía del usuario mediante la página web a continuación.



<https://panasonic.net/cns/pcc/support/homehawk/manual/>

- No se admite Microsoft® Windows® Internet Explorer® 8 y versiones anteriores.

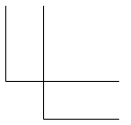
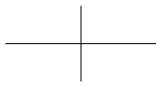
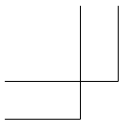

Notas

