

Panasonic®

2.4 GHz Digital Cordless Answering System

Operating Instructions

Model No. **KX-TG2356C**

Pulse-or-tone dialing capability

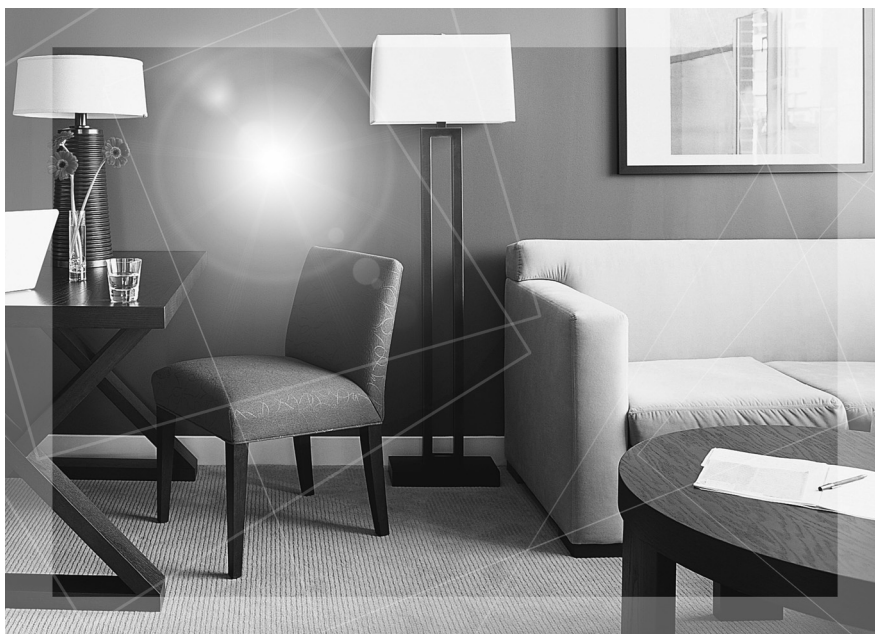

The unit is Call Display compatible. To display the caller's name and phone number, you must subscribe to Call Display service.

PLEASE READ BEFORE USE AND SAVE.

Charge the battery for 6 hours before initial use.

For assistance, please call 1-800-561-5505 or visit us at www.panasonic.ca

Thank you for purchasing your new Panasonic cordless telephone.

Call Display and Call Waiting service, where available, are telephone company services. After subscribing to Call Display this phone will display a caller's name and phone number. Visual Call Waiting/Call Waiting Deluxe, which displays a second caller's name and phone number while the user is on another call, requires a subscription to both Call Display and Visual Call Waiting services.

Accessories (included)

AC Adaptor (p. 9)

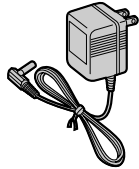

one

Telephone Line Cord (p. 9)



one

Battery (p. 10)



one

Handset Cover (p. 10)

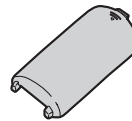

one

Belt Clip (p. 70)



one

Shoulder Rest Attachment (p. 70)



one

For Best Performance

Battery Charge

The handset is powered by a rechargeable Nickel-Metal Hydride (Ni-MH) battery. Charge the battery for **6 hours** before initial use (p. 10).

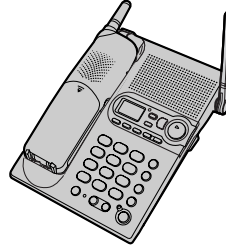

Base Unit Location/Noise

Calls are transmitted between the base unit and handset using wireless radio waves. **For maximum distance and noise-free operation**, the recommended base unit location is:

Away from electrical appliances such as a TV, personal computer or another cordless phone.

In a **HIGH** and **CENTRAL** location with no obstructions such as walls.

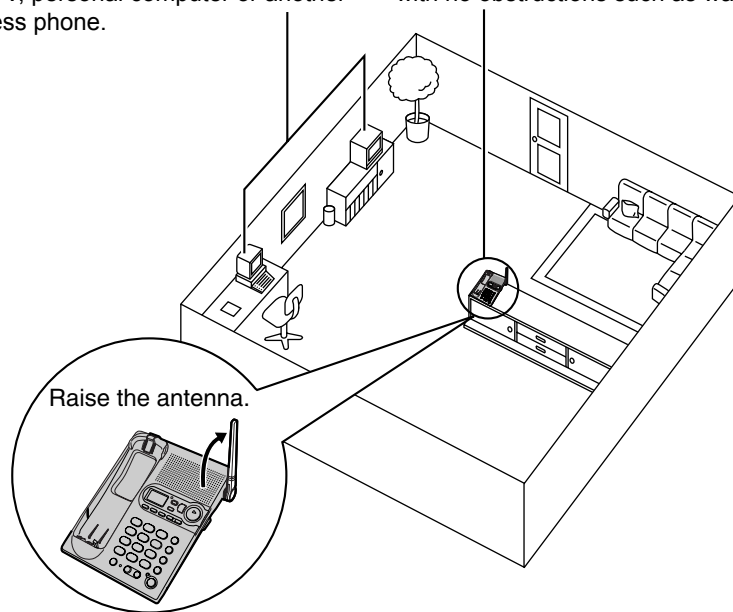

Note:

- If you use the handset near a microwave oven which is being used, noise may be heard from the receiver or the speaker. Move away from the microwave oven and closer to the base unit.
- If you use the handset near another cordless phone's base unit, noise may be heard. Move away from the other cordless phone's base unit and closer to your base unit.

Contents

Preparation

Location of Controls	6
Installation	9
Connections	9
Installing the Battery in the Handset	10
Battery Charge	10
Programmable Settings	12
Programming Guidelines ..	12
Function Menu Table	13
Date and Time	14
Display Language	15
Voice Guidance Language ..	16
Dialing Mode	16
Line Mode	17
Auto Talk	17
Ringer Volume	18
Ringer Tone	20
LCD Contrast	22

Preparing the Answering

System	23
Greeting Message	23
Caller's Recording Time ..	25
Number of Rings	26
Recording Mode	26
Message Alert	27

Telephone System

Making Calls	28
Using the Handset	28
Using the Base Unit	31
Answering Calls	32
Call Display Service	33
Talking Call Display	34
Using the Caller List	35
Viewing the Caller List ...	36
Calling Back from the Caller List	36
Editing the Caller's Phone Number	37

Storing Caller Information in the Phone Book	38
Erasing Caller Information ..	39

Phone Book

40	
Storing Names and Numbers	40
Dialing from the Phone Book	42
Chain Dial	43
Editing an Item in the Phone Book	44
Erasing an Item in the Phone Book	44

Intercom

45	
Making Intercom Calls	45
Answering Intercom Calls ..	46

Transferring a Call

47

Conference Calls

49	
Call Share	49

Special Features

50	
Temporary Tone Dialing (For Rotary or Pulse Service Users)	50
Muting Your Conversation For Call Waiting Service Users	51
Call Waiting Deluxe Service	52
Using the PAUSE Key (For PBX Line/Long Distance Calls)	55
FLASH Button	55
Incoming Call Tone	56
Key Tone	57
Re-registering the Handset	57

Contents

Answering System	Useful Information
Automatic Answering	Wall Mounting 69
Operation 58	Belt Clip 70
Setting the Unit to Answer	Shoulder Rest Attachment .. 70
Calls 58	Optional Headset 71
Monitoring Incoming Calls . 59	Direct Commands 72
Listening to Messages 60	If the Following Appears on
Using the Base Unit 60	Your Display... 74
Using the Handset (Remote	Troubleshooting 75
Operation) 61	Important Information 79
Erasing Messages 63	Safety Instructions 80
Recording a Memo	Specifications 82
Message 64	Warranty 83
Remote Operation from a Touch	
Tone Phone 65	
Remote Code 66	
Voice Menu 67	
Direct Remote Operation .. 68	

Preparation

Telephone System

Answering System

Useful Information

Important:

Throughout these Operating Instructions, **Handset** and **Base Unit** are used to indicate with which unit an operation can be performed.

Handset : Perform with the handset.

Base Unit : Perform with the base unit.

Handset Base Unit : Perform with the handset and base unit separately.

Handset & Base Unit : Perform with the handset and base unit together.

Location of Controls

Base unit

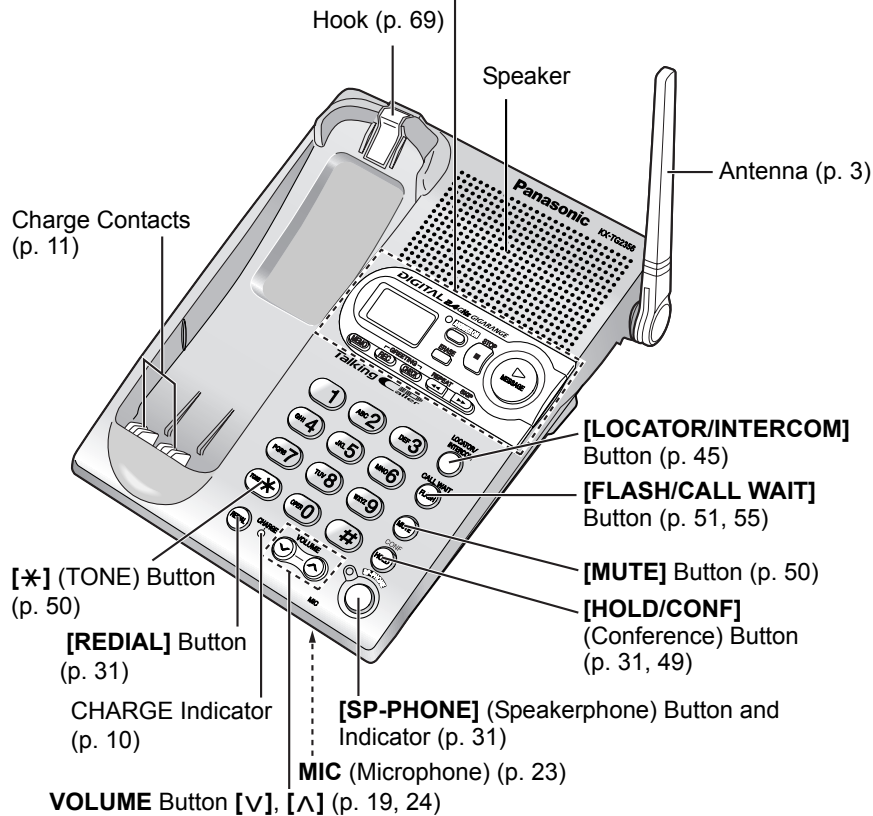
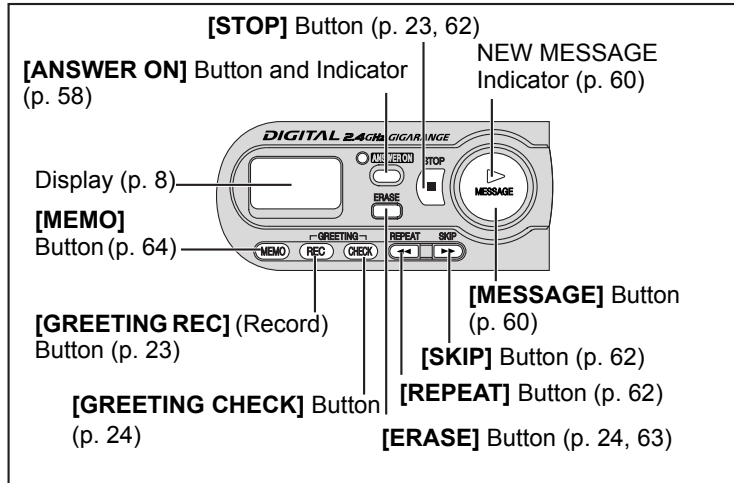

Location of Controls

Handset

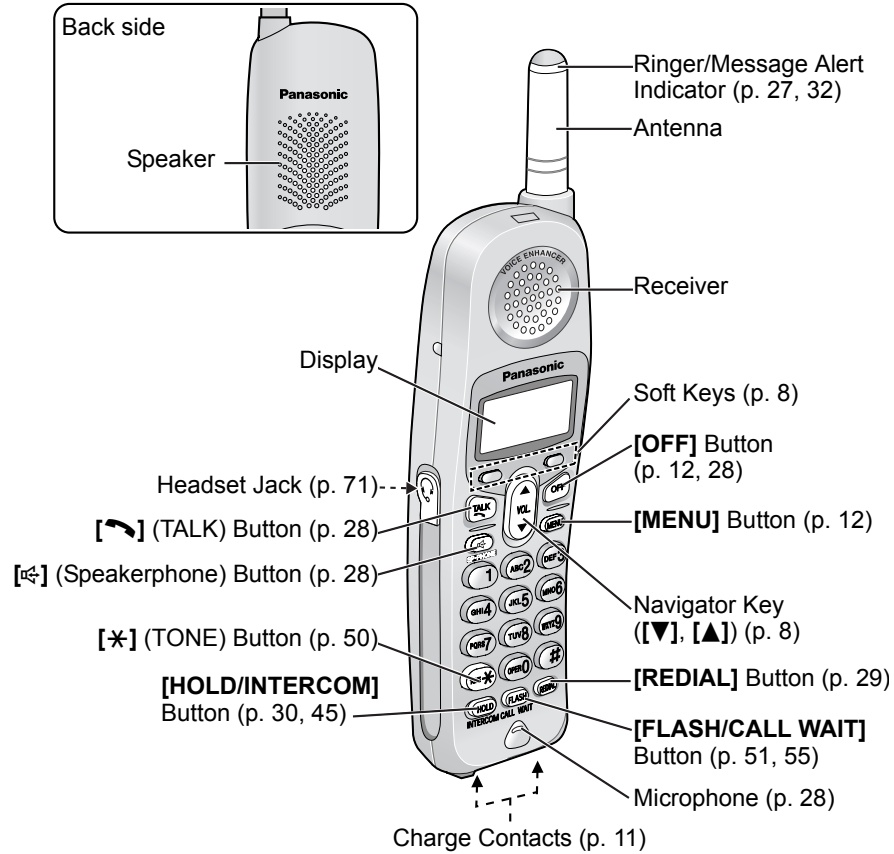

Preparation

Location of Controls

Handset soft keys

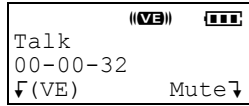

Two soft keys are used to select functions displayed directly above each key. Functions displayed above the keys will change depending on the state of use.

On this sample display, "↓ (VE)" and "Mute↓" are displayed above the soft keys.



Pressing the right soft key selects mute "Mute↓".

Pressing the left soft key selects Voice Enhancer "↓ (VE)".

- When a function name does not appear above a soft key, the soft key has no function.

Handset navigator key



Scrolls up [▲] and down [▼] the function menu, the Caller List and the phone book.

Increases [▲] or decreases [▼] the handset ringer and receiver/speaker volumes.

Throughout these Operating Instructions:

- The soft keys are indicated by what is displayed above the keys. e.g. "Press **Mute**." indicates "Press the soft key below **Mute↓**".
- The navigator key is indicated by the arrows [▼] or [▲].

Base unit display

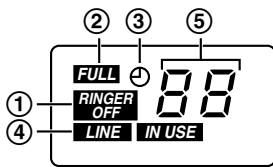

- ① "**RINGER OFF**" indicates that the base unit ringer is off (p. 19).
- ② "**FULL**" flashes when no new messages can be recorded. Erase unnecessary messages (p. 63).
- ③ "⊕" flashes until you set the date and time, and flashes after a power failure. If it is flashing, set the date and time (p. 14).

- ④ "**LINE IN USE**" functions as follows.

Off (invisible)	The line is free.
On	The line is being used.
Flashing	A call is on hold on the handset or base unit or the Answering System is answering a call (p. 58).
Flashing rapidly	A call is being received.

- "**IN USE**" displays when a handset is operating the Answering System.
- ⑤ Message counter shows:
 - the total number of recorded messages. If the recording time is set to "Greeting only", "00" will be displayed (p. 25).
 - the selected volume level while you are adjusting the volume (p. 24, 31).
 - "E" when your greeting message or memo message was not recorded correctly (p. 23, 64).

Installation

Connections

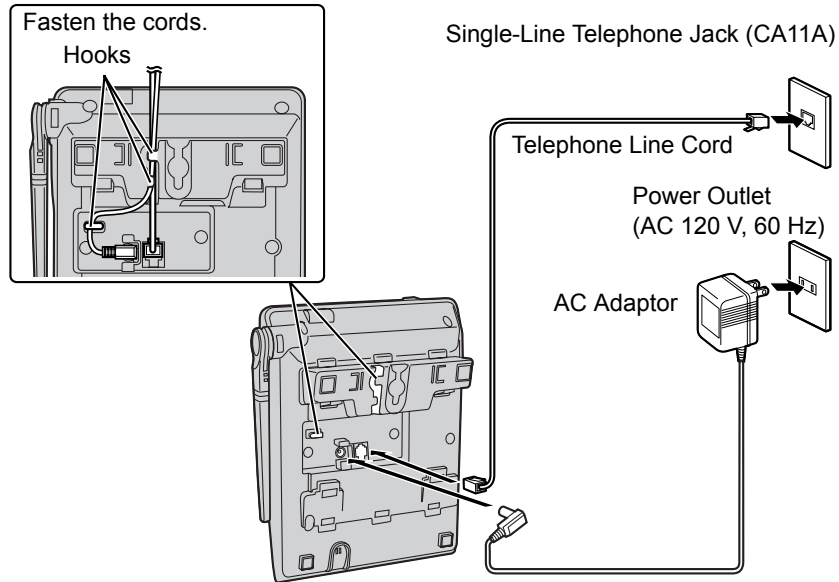

- USE ONLY WITH Panasonic AC ADAPTOR PQLV1.
- The AC adaptor must remain connected at all times. (It is normal for the adaptor to feel warm during use.)
- If your unit is connected to a PBX which does not support Call Display services, you cannot access those services.
- The unit will not work during a power failure. We recommend connecting a standard telephone to the same telephone line or to the same telephone jack using a T-adaptor.

Installation

Installing the Battery in the Handset

Insert the battery (①), and press it down until it snaps into the compartment (②). Close the cover.

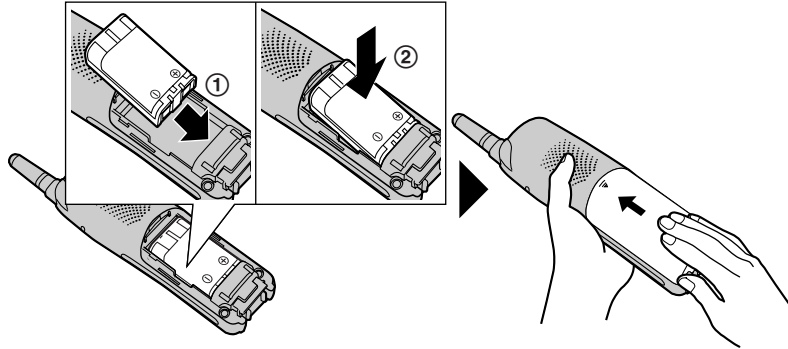

To replace the battery:

Press the notch on the cover firmly and slide it as indicated by the arrow. Replace the old battery with a new one (p. 11). Close the cover and charge the battery for 6 hours.

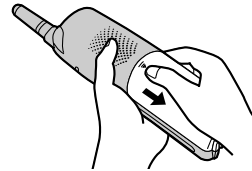

Battery Charge

Place the handset on the base unit. Charge for **6 hours** before initial use. Repeat charging will require approximately the same amount of charging time (6 hours) if the battery is depleted completely.

- The unit beeps once, the CHARGE indicator lights, and "Charging" is displayed.
- When the battery is fully charged, "Charge completed" is displayed.

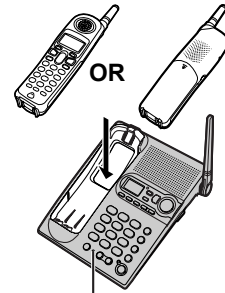

CHARGE Indicator

Battery strength

You can confirm battery strength on the handset display. Battery strength is indicated by the icons shown in the chart to the right.

Display prompt	Battery strength
	Fully charged
	Medium
	Low
	Needs to be recharged.
	Discharged



Installation

Recharge

Recharge the battery when:

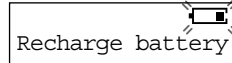

- “Recharge battery” is displayed on the handset,
- “” flashes, or
- the handset beeps intermittently while it is in use.



- The display will continually indicate that “Recharge battery” and/or “” will flash when the handset battery is charged for less than 15 minutes and the handset is lifted off the base unit.
- If the battery has been discharged, the handset will display “Charge for 6h” and “” when you place the handset on the base unit. The handset will not work unless the battery is charged. Continue charging.

Preparation

Battery replacement:

If you cleaned the charge contacts and fully charged the battery, but after a few telephone calls, “Recharge battery” is displayed and/or “” continues to flash, or “Charge for 6h” and “” are displayed, the battery may need to be replaced. Please replace with a new Panasonic HHR-P104 battery. To replace the battery, see page 10.

A nickel metal hydride battery that is recyclable powers the product you have purchased. Please call 1-800-8-BATTERY for information on how to recycle this battery.



Battery information

After your Panasonic battery is fully charged, you can expect the following performance:

Operation	Operating time
While in use (TALK)	Up to 5 hours
While not in use (Standby)	Up to 11 days

- A fully charged battery will give you up to 5 hours of continuous talk time, or keep your handset in Standby mode to receive incoming calls for up to 11 days (if no phone calls are made). Battery power is consumed whenever the handset is off of the base unit, even when the handset is not in use. The longer you leave the handset off of the base unit, the time you can actually talk on the handset will be shortened. Actual battery performance depends on a combination of how often the handset is in TALK mode and how often it is in Standby mode.
- **Clean the charge contacts of the handset and the base unit with a soft, dry cloth once a month. Clean more often if the unit is subject to grease, dust or high humidity,** otherwise, the battery may not charge properly.
- If the battery is fully charged, you do not have to place the handset on the base unit until “Recharge battery” is displayed and/or “” flashes. This will maximize the battery life.
- If you want to keep the battery fully charged at all times, place the handset on the base unit when the handset is not used. The battery cannot be overcharged.

Programmable Settings

Programming Guidelines **Handset**

This unit has several programmable functions which can be selected from the function menu on the display (p. 13).

The **soft keys** selects the functions displayed above each soft key.

When “▼” or “▲” is displayed, navigator key scrolls through the menu.

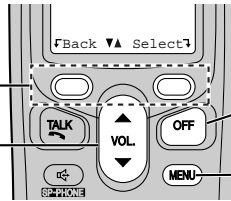

[OFF] exits programming.

[MENU] enters the function menu.

How to select a function item from the menu

Make sure the handset and base unit are not being used. The handset must be operated near the base unit and while off the base unit.

1 Press **[MENU]**.

- The main menu is displayed (p. 13).

2 Scroll to the desired item by pressing **[▼]** or **[▲]**.

3 Press **select** to select the desired item.

4 If the item has a sub-menu, select the menu item (p. 13). Repeat steps 2 and 3 until the desired item is displayed. If the item has no sub-menu, go to step 5.

5 Select the desired setting by pressing **[▼]** or **[▲]**, then press **save** to save your setting.

- A confirmation tone will be heard and the setting will be saved.

6 Press **[OFF]** to exit programming mode.

- To go back to the previous menu, press **Back**, or press **Select** while “--- (Go back) ---” is displayed. If you press this key in the main menu, the unit will exit programming mode.
- After programming is complete, the display will return to the main menu or the sub-menu depending on which menu the selected item is located. (See the menu table on page 13.)
- You can exit programming mode at any time by pressing **[OFF]**.
- If you do not press any buttons for 60 seconds, the handset will exit programming mode.
- If the unit detects a problem, an error message will be displayed (p. 74) and/or error beeps will sound.

Programmable Settings

Function Menu Table **Handset**

You can use the following functions to customize your unit. See the corresponding pages for function details.

- After pressing **[MENU]**, you can also program menu items directly by pressing (**[0]** to **[9]**, **[*]** and **[#]**) instead of using the soft keys (p. 72–73).

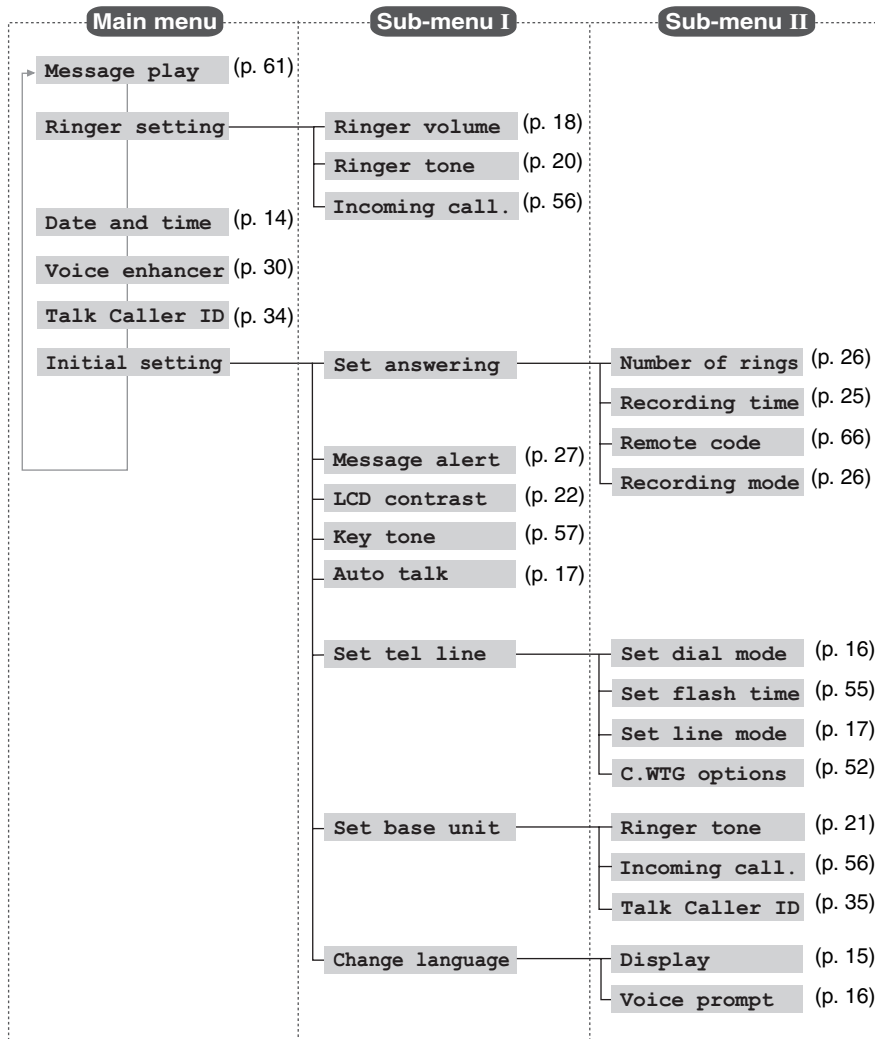

Preparation

Programmable Settings

Date and Time **Handset**

We recommend that you set the date and time so that the unit will announce the day and time each message was recorded when you play back messages.

1 Press **[MENU]**.

2 Scroll to "Date and time" by pressing **[▼]** or **[▲]**, then press **Select**.

```
Date and time
└Back ▼▲ Select┘
```

3 ① Enter 2 digits each for the month, day, and year. (e.g. To set May 15, 2004, enter "05 15 04".)

```
Date:12.31.2004
Time:12:00 AM
└AM/PM Save┘
```

② Enter 4 digits for the time (hour and minute). (e.g. To set 9:30, enter "0930".)

```
Example
Date:05.15.2004
Time:09:30 AM
└AM/PM Save┘
```

• If you enter a wrong number, press **[▼]** or **[▲]** to move the cursor to the incorrect number. Enter the correct number.

4 Select "AM" or "PM" by pressing **AM/PM**.

```
Date:05.15.2004
Time:09:30 AM
└AM/PM Save┘
```

5 Press **save**.

- The date and time are set and "⓪" disappears from the base unit display.
- If the handset beeps 3 times, the date and time were not set correctly. Try again from step 3.

6 Press **[OFF]**.

- When entering the time in step 3, you cannot enter numbers greater than 12. **Do not use military time.** (To set 13:00 hours, enter "0100", then select "PM" in step 4.)
- When the display language is set to French, you can use military time (see page 14 of the French Operating Instructions).

The date and time may be incorrect after a power failure. When "⓪" flashes on the base unit display, set the date and time again.

To confirm the date and time, repeat steps 1 and 2 above.

- The current date and time are displayed. When finished, press **[OFF]**.

Programmable Settings

For Call Display service users (p. 33)

- When a call is received, the unit automatically adjusts the date and time if the time is incorrect.
- The unit will automatically adjust the date and time for daylight saving time.
- If the date and time have not previously been set, the unit will not automatically adjust the date and time.

Preparation

Display Language **Handset**

You can select either “English” or “Français” (French) as the display language. The factory preset is “English”.

1 Press **[MENU]**.

2 Scroll to “Initial setting” by pressing **[▼]** or **[▲]**, then press **Select**.

```
Initial setting
└Back ▼▲ Select┘
```

3 Scroll to “Change language” by pressing **[▼]** or **[▲]**, then press **Select**.

```
Change language
└Back ▼▲ Select┘
```

4 Press **Select** at “Display”.

```
Display
└Back ▼▲ Select┘
```

5 To change from English to French, press **Franç.**

To change from French to English, press **English**.

- The display changes to the selected language.
- You can also select a language by pressing **[▼]** or **[▲]**.

```
Display
:English
└Franç. Save┘
```

6 When French is selected, press **Sauv.**, then press **[OFF]**.
When English is selected, press **Save**, then press **[OFF]**.

- If you select a language you cannot read, change the display language again using direct commands (p. 73).

Programmable Settings

Voice Guidance Language **Handset**

You can select either “English” or “Français” (French) as the voice guidance language. The factory preset is “English”.

1 Press **[MENU]**.

2 Scroll to “Initial setting” by pressing **[▼]** or **[▲]**, then press **Select**.

```
Initial setting
└Back ▼▲ Select┘
```

3 Scroll to “Change language” by pressing **[▼]** or **[▲]**, then press **Select**.

```
Change language
└Back ▼▲ Select┘
```

4 Scroll to “Voice prompt” by pressing **[▼]** or **[▲]**, then press **Select**.

```
Voice prompt
└Back ▼▲ Select┘
```

5 Select “Français” or “English” by pressing **[▼]** or **[▲]**.

- The voice guidance language changes to the selected language.

```
Voice prompt
:English
└Back ▼▲ Save┘
```

6 Press **Save**, then press **[OFF]**.

Dialing Mode **Handset**

If you have touch tone service, set the dialing mode to “Tone”. For rotary or pulse service, set to “Pulse”. The factory preset is “Tone”.

1 Press **[MENU]**.

2 Scroll to “Initial setting” by pressing **[▼]** or **[▲]**, then press **Select**.

```
Initial setting
└Back ▼▲ Select┘
```

3 Scroll to “Set tel line” by pressing **[▼]** or **[▲]**, then press **Select**.

```
Set tel line
└Back ▼▲ Select┘
```

4 Press **Select** at “Set dial mode”.

```
Set dial mode
└Back ▼▲ Select┘
```

5 Select “Pulse” or “Tone” by pressing **[▼]** or **[▲]**.

```
Set dial mode
:Tone
└Back ▼▲ Save┘
```

6 Press **Save**, then press **[OFF]**.

Programmable Settings

Line Mode **Handset**

The line mode is preset to “B” and generally should not be adjusted. If “Line in use” on the handset and “**LINE IN USE**” on the base unit are not displayed properly, the line mode selection is incorrect. Set line mode to “A”.

1 Press **[MENU]**.

2 Scroll to “Initial setting” by pressing **[▼]** or **[▲]**, then press **Select**.

```
Initial setting
└Back ▼▲ Select┘
```

3 Scroll to “Set tel line” by pressing **[▼]** or **[▲]**, then press **Select**.

```
Set tel line
└Back ▼▲ Select┘
```

4 Scroll to “Set line mode” by pressing **[▼]** or **[▲]**, then press **Select**.

```
Set line mode
└Back ▼▲ Select┘
```

5 Select “A” or “B” by pressing **[▼]** or **[▲]**.

```
Set line mode
: B
└Back ▼▲ Save┘
```

6 Press **save**, then press **[OFF]**.

Preparation

Auto Talk **Handset**

The Auto Talk feature allows you to answer calls by simply lifting the handset off the base unit. You do not need to press **[📞]** or **[📞]**. The factory preset is OFF.

1 Press **[MENU]**.

2 Scroll to “Initial setting” by pressing **[▼]** or **[▲]**, then press **Select**.

```
Initial setting
└Back ▼▲ Select┘
```

3 Scroll to “Auto talk” by pressing **[▼]** or **[▲]**, then press **Select**.

```
Auto talk
└Back ▼▲ Select┘
```

4 Select “On” or “Off” by pressing **[▼]** or **[▲]**.

```
Auto talk
: Off
└Back ▼▲ Save┘
```

5 Press **save**, then press **[OFF]**.

- In order to view caller information after you lift the handset to answer a call, leave the Auto Talk feature turned off.

Programmable Settings

Ringer Volume

You can select the handset or base unit ringer volumes to high, medium, low, or off. The factory preset is HIGH. If the handset and base unit ringer is turned off, the handset or base unit will ring at the low level for intercom calls, and will not ring for outside calls. Caller names will not be announced even if the Talking Call Display feature is turned on (p. 34, 35).

Handset ringer volume **Handset**

1 Press **[MENU]**.

2 Scroll to "Ringer setting" by pressing **[▼]** or **[▲]**, then press **Select**.

```
Ringer setting
└Back ▼▲ Select┘
```

3 Press **Select** at "Ringer volume".

```
Ringer volume
└Back ▼▲ Select┘
```

4 Select the desired volume level by pressing **[▼]** or **[▲]**.

- The volume will change and ring.
- The number of steps indicates the volume level.
- **To turn the ringer off**, press **[▼]** repeatedly until "Off ?" is displayed.

```
e.g. High
Ringer volume
Low ■■■■■ High
└Back ▼▲ Save┘
```

5 Press **Save**.

- If the handset ringer is turned off, "Ringer off" will be displayed while not in use. If the handset is off the base unit when there are missed calls (p. 35) or new messages (p. 61), "Ringer off" is not displayed.
- You can adjust the ringer volume while an outside call is ringing. Press **[▼]** or **[▲]** while the handset is ringing.

Temporary ringer off

While the handset is ringing for an outside call, you can turn the ringer off temporarily by pressing **[OFF]**. The handset will ring again as usual the next time a call is received.

Programmable Settings

Base unit ringer volume **Base Unit**

Make sure the base unit is not being used.

To set the ringer volume to high (preset), medium, or low, press **VOLUME [V]** or **[^]**.

- To increase volume, press **VOLUME [^]**.
To decrease volume, press **VOLUME [V]**.
- To stop ringing, press **[STOP]**.

To turn the ringer off, press and hold **VOLUME [V]** until 2 beeps sound.

- “**RINGER OFF**” is displayed.

To turn the ringer on, press **VOLUME [V]** or **[^]**.

- The base unit will ring at the low level.
- You can adjust the ringer volume while an outside call is ringing.
Press **VOLUME [V]** or **[^]** while the base unit is ringing.
To turn the ringer off, press and hold **VOLUME [V]** until 2 beeps sound.
“**RINGER OFF**” is displayed.

Preparation

Programmable Settings

Ringer Tone

You can set the handset and base unit ringers to use one of 7 ringer patterns for outside calls. “Tone 1” to “Tone 3” are bell ringer patterns. “Melody 1” to “Melody 4” are melody patterns. The factory preset is “Tone 1”.

- You cannot change the ringer tone for intercom calls.
- If you subscribe to a Distinctive Ring Service from your telephone company with 2 or 3 consecutive rings, select a bell ringer pattern (Tone 1 to 3). If you select a melody pattern, you will not be able to distinguish lines by their ringers.
- If you select one of the melody ringer patterns, the ringer will continue to sound for several seconds if:
 - the caller hangs up before you answer the call, or
 - another person answers the call using another phone connected on the same line.

Handset ringer tone **Handset**

1 Press **[MENU]**.

2 Scroll to “Ringer setting” by pressing **[▼]** or **[▲]**, then press **Select**.

```
Ringer setting
└Back ▼▲ Select┘
```

3 Scroll to “Ringer tone” by pressing **[▼]** or **[▲]**, then press **Select**.

```
Ringer tone
└Back ▼▲ Select┘
```

4 Select the desired ringer tone by pressing **[▼]** or **[▲]**.

- The handset will ring and the ringer tone will change. If the ringer volume has been turned off, the handset will not ring (p. 18).
- You can also select the ringer tone by pressing **[1]** to **[7]**.

```
Ringer tone
1:Tone 1
└Back ▼▲ Save┘
```

5 Press **Save**, then press **[OFF]**.

Programmable Settings

Base unit ringer tone (use either the handset or the base unit)

Base Unit

Make sure the base unit is not being used.

Press **VOLUME** [V] or [^], then select the desired ringer tone by pressing [1] to [7].

[1] to [3] : Bell ringer patterns [4] to [7] : Melody patterns

- After pressing **VOLUME** [V] or [^], the base unit will ring using the current ringer tone.
- The base unit will ring and the ringer tone will change.
- To stop ringing, press [STOP].

Preparation

Setting the base unit ringer tone by using the Handset

- 1 Press [MENU].
- 2 Scroll to "Initial setting" by pressing [▼] or [▲], then press **Select**.
- 3 Scroll to "Set base unit" by pressing [▼] or [▲], then press **Select**.
- 4 Press **Select** at "Ringer tone".
- 5 Select the desired ringer tone by pressing [▼] or [▲].
 - The base unit will ring and the ringer tone will change. If the base unit ringer volume has been turned off, the base unit will not ring (p. 19).
 - You can also select the ringer tone by pressing [1] to [7].
- 6 Press **Save**, then press [OFF].

Programmable Settings

LCD Contrast **Handset**

There are 6 levels of LCD contrast. The factory preset is "level 3".

1 Press **[MENU]**.

2 Scroll to "Initial setting" by pressing **[▼]** or **[▲]**, then press **Select**.

```
Initial setting
┆Back ▼▲ Select┆
```

3 Scroll to "LCD contrast" by pressing **[▼]** or **[▲]**, then press **Select**.

```
LCD contrast
┆Back ▼▲ Select┆
```

4 Select the desired contrast by pressing **[▼]** or **[▲]**.

- The contrast will change.

```
e.g. Level 3
LCD contrast
Low ■■■ High
┆Back ▼▲ Save┆
```

5 Press **save**, then press **[OFF]**.

Preparing the Answering System

Greeting Message **Base Unit**

You can record a personal greeting message of **up to 2 minutes**. If you do not record your own message, one of two pre-recorded greetings will be played for callers (p. 24).

The total recording time of all messages (greeting, incoming and memo) is **about 16 minutes**.

We recommend that you record **a brief greeting message** in order to leave more time for recording new messages.

- You can use the enhanced recording mode for clearer sound, if necessary (p. 26).

Preparation

To record a greeting message

Sample greeting message

"Hello, this is (your name and/or number). Sorry, I cannot take your call. Please leave a message after the beep. Thank you."

- 1 Press **[GREETING REC]**.
 - "To record greeting, press RECORD again" is heard.
- 2 Within 10 seconds, press **[GREETING REC]** again to record your greeting.
- 3 After the long beep, speak clearly, about 20 cm (8 inches) away from the **MIC** (microphone).
 - The elapsed recording time is displayed.
 - If you record for over 2 minutes, the unit will stop recording.
- 4 When finished, press **[GREETING REC]** or **[STOP]**.
 - To change the greeting, try again from step 1.

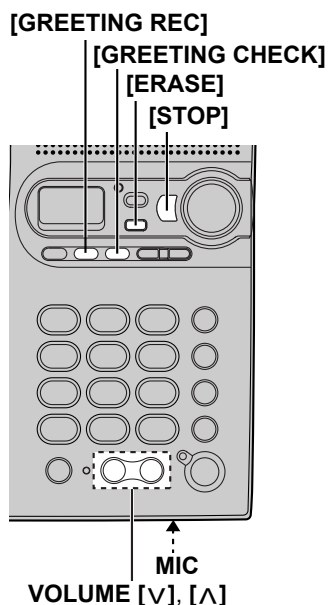

- If "E" is displayed, 6 beeps sound and "Your greeting was not recorded. Record your greeting again." is announced, try again from step 1.

Preparing the Answering System

To adjust the speaker volume, press VOLUME [V] or [Λ] during playback.

- 9 levels (0–8) are available while using the Answering System. The level is displayed on the base unit.

To review the greeting

Press [GREETING CHECK].

To erase the greeting

Press [GREETING CHECK], then press [ERASE] while the recorded message is being played.

- The unit will answer calls with a pre-recorded greeting (see below).

Pre-recorded greeting

If you do not record a greeting (p. 23), one of two greetings will be played when a call is received, depending on the caller's recording time (p. 25).

To review the pre-recorded greeting, press [GREETING CHECK].

- A pre-recorded greeting will be played as follows:

- When the recording time is set to "1 minute", "2 minutes" or "3 minutes":
"Hello, we are not available now. Please leave your name and phone number after the beep. We will return your call."
- If recording time runs out, the unit will automatically switch to the "Greeting only" mode (see below), and no new messages will be recorded.
- When the recording time is set to "Greeting only":
"Hello, we are not available now. Please call again. Thank you for your call."

Flash Memory Message Backup (Message storage)

Messages stored in memory will not be affected by power failures. All messages are saved until you erase them.

Preparing the Answering System

Caller's Recording Time **Handset**

You can select "1 minute", "2 minutes", "3 minutes" or "Greeting only" for the caller's recording time. The factory preset is "3 minutes".

1 Press **[MENU]**.

2 Scroll to "Initial setting" by pressing **[▼]** or **[▲]**, then press **Select**.

```
Initial setting
└Back ▼▲ Select┘
```

3 Press **Select** at "Set answering".

```
Set answering
└Back ▼▲ Select┘
```

4 Scroll to "Recording time" by pressing **[▼]** or **[▲]**, then press **Select**.

```
Recording time
└Back ▼▲ Select┘
```

5 Select the recording time by pressing **[▼]** or **[▲]**.
 • You can also select the recording time by pressing **[1]**, **[2]**, **[3]** or **[0]** (Greeting only).

```
Recording time
:3min
└Back ▼▲ Save┘
```

6 Press **Save**, then press **[OFF]**.

If you select "Greeting only", the unit will answer calls with the greeting message, and then hang up. The unit will not record any incoming messages. The base unit will display "gō" instead of the number of messages.

Preparation

Preparing the Answering System

Number of Rings **Handset**

You can select the number of times the unit rings before the Answering System answers a call, from “2” to “7” or “Toll saver”*. The factory preset is “4”.

1 Press **[MENU]**.

2 Scroll to “Initial setting” by pressing **[▼]** or **[▲]**, then press **Select**.

Initial setting
 ↵Back ▼▲ Select↵

3 Press **Select** at “Set answering”.

Set answering
 ↵Back ▼▲ Select↵

4 Press **Select** at “Number of rings”.

Number of rings
 ↵Back ▼▲ Select↵

5 Select the number of rings by pressing **[▼]** or **[▲]**.

- You can also select the number of rings by pressing **[0]** (Toll saver*), or **[2]** to **[7]**.

Number of rings
 :4
 ↵Back ▼▲ Save↵

6 Press **Save**, then press **[OFF]**.

*Toll saver

When you call the unit from a remote operation, the number of rings will tell you if there are any new messages. If the unit answers on the 2nd ring, there is at least one new message. If the unit answers on the 4th ring, there are no new messages. To save the toll charges for the call, hang up immediately when you hear the 3rd ring. The 3rd ring indicates that there are no new messages.

Recording Mode **Handset**



Two recording modes are available. The factory preset is “Standard recording (16 min)”, which provides more recording time (16 min) and standard sound quality. “Enhanced recording (8 min)” provides less recording time (8 min) but clearer sound quality.

1 Press **[MENU]**.

2 Scroll to “Initial setting” by pressing **[▼]** or **[▲]**, then press **Select**.

Initial setting
 ↵Back ▼▲ Select↵

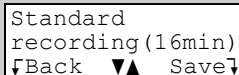

Preparing the Answering System

3 Press Select at “Set answering”.	
4 Scroll to “Recording mode” by pressing [▼] or [▲], then press Select .	
5 Select the recording mode by pressing [▼] or [▲]. <ul style="list-style-type: none"> You can also select the recording mode by pressing [1] (Standard) or [2] (Enhanced). 	
6 Press Save , then press [OFF].	

Preparation

Message Alert **Handset**

You can select whether or not the Ringer/Message Alert indicator on the handset will flash slowly when new messages have been recorded (p. 61). The factory preset is OFF.

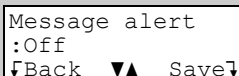
1 Press [MENU].	
2 Scroll to “Initial setting” by pressing [▼] or [▲], then press Select .	
3 Scroll to “Message alert” by pressing [▼] or [▲], then press Select .	
4 Select “On” or “Off” by pressing [▼] or [▲].	
5 Press Save , then press [OFF].	

- The Ringer/Message Alert indicator will not flash for new messages while the handset is in use.
- The Ringer/Message Alert indicator acts both as a ringer indicator and as a message alert indicator. This indicator will flash rapidly when a call is received whether this feature is on or off.
- Battery operating time may be shortened when using this feature (p. 11).

Making Calls

Using the Handset **Handset**

- 1 Press [**📞**].
 - “Talk” is displayed.
- 2 Dial a phone number.
 - The dialed number is displayed.
 - After a few seconds, the display will show the length of the call.
- 3 To hang up, press [**OFF**] or place the handset on the base unit.

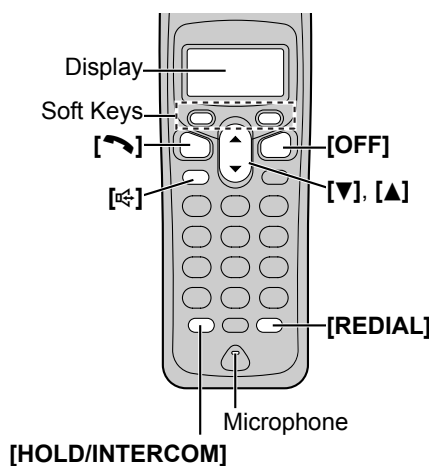

To have a hands-free phone conversation

- 1 Press [**📞**].
 - “SP-phone” is displayed.
- 2 Dial a phone number.
 - The dialed number is displayed.
 - After a few seconds, the display will show the length of the call.
- 3 When the other party answers, speak into the microphone.
- 4 To hang up, press [**OFF**] or place the handset on the base unit.

Hands-free Digital Duplex Speakerphone

For best performance, please note the following:

- Speak alternately with the other party in a quiet room.
- If you or the other party has difficulty hearing, press [**▼**] to decrease the speaker volume.
- While talking using [**📞**], you can switch to a hands-free phone conversation by pressing [**📞**]. To switch back to the receiver, press [**📞**].

Making Calls

To dial after confirming the entered number

- 1 Enter a phone number.

3334444
 ↓Clear Pause↓

- If you misdial, press **Clear**. Enter the correct number.
- If a pause is required when dialing, press **Pause** where needed (p. 55).
- To cancel, press **[OFF]**.

- 2 Press [**↶**] or [**↷**].

- 3 To hang up, press **[OFF]** or place the handset on the base unit.

To adjust the receiver/speaker volume during a conversation

There are 3 volume levels for the receiver and 6 volume levels for the speaker.

To increase volume, press [**▲**].

To decrease volume, press [**▼**].

e.g. Receiver volume: High
 Speaker volume: Level 6

Volume
 Low ■■■■■ High
 ↓(VE) Mute↓

- The display shows the current volume setting.
- If you try to increase/decrease volume when it is at the maximum/minimum level, the handset will beep 3 times.

To redial the last number dialed

Press [**↶**] or [**↷**], then press **[REDIAL]**.

To redial using the redial list (Memory Redial)

The last 5 phone numbers dialed are stored in the redial list.

- 1 Press **[REDIAL]**.

333-4444
 ↓Erase ▼▲

- The last number dialed is displayed.

- 2 Scroll to the desired number by pressing [**▼**] or [**▲**].

- You can also scroll down through the list by pressing **[REDIAL]**.
- To exit the list, press **[OFF]**.

- 3 Press [**↶**] or [**↷**].

- **To erase an item**, scroll to the item then press **Erase**.
- If "No items stored" is displayed, the list is empty.

Making Calls

To put a call on hold

1 Press **[HOLD/INTERCOM]** during a conversation.

- “Line on hold.” is displayed.
- To transfer the call to the base unit, see page 47.

2 Press **[HOLD/INTERCOM]** again.

- “Hold” is displayed.
- You can search the Caller List or phone book while a call is on hold. To exit the list, press **[OFF]**. The call will remain on hold.

To return to the call, press **[↶]** or **[⇨]**.

- The base unit user can also take the call by pressing **[SP-PHONE]**.
- If another phone is connected on the same line (p. 9), you can also take the call by lifting its handset.
- If a call is kept on hold for 6 minutes, an alarm tone will start to sound and the Ringer/Message Alert indicator will start to flash rapidly. After 4 additional minutes on hold, the call will be disconnected.

Voice Enhancer Technology

Panasonic's Voice Enhancer Technology clarifies the voice of the person you are talking to, reproducing a more natural-sounding voice that is easier to hear and understand.

Voice Enhancer Technology can be turned on or off. The factory preset is OFF.

- Depending on the condition and quality of your telephone line, this feature may emphasize existing line noise. If it becomes difficult to hear, turn this feature off.

To turn this feature on, press **(VE)** during a conversation.

- “**(VE)**” is displayed.
- To turn this feature off, press **(VE)** again.
- “**(VE)**” disappears from the display.
- After hanging up a call, the on/off setting will be retained.

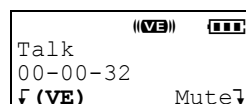

When the handset is not in use, you can also turn this feature on or off by programming as follows:

1. Press **[MENU]**.
2. Scroll to “Voice enhancer” by pressing **[▼]** or **[▲]**, then press **select**.
3. Select “On” or “Off” by pressing **[▼]** or **[▲]**.
4. Press **save**, then press **[OFF]**.

Backlit LCD display/Lighted handset keypad

The handset display and dialing buttons will light for a few seconds after pressing a button or lifting the handset off the base unit. They will also light when an intercom/ outside call is being received.

Making Calls

Using the Base Unit **Base Unit**

- 1 Press **[SP-PHONE]**.
 - The SP-PHONE indicator lights.
- 2 Dial a phone number.
- 3 When the other party answers, speak into the **MIC** (microphone).
- 4 To hang up, press **[SP-PHONE]**.
 - The indicator light goes out.

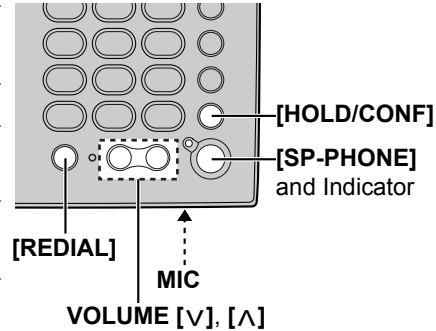

- To switch to the handset while using the base unit speakerphone:
 - If the handset is off the base unit, press **[]** or **[]** on the handset, then press **[SP-PHONE]** on the base unit.
 - If the handset is on the base unit, just lift up.

Hands-free Digital Duplex Speakerphone

For best performance, please note the following:

- Speak alternately with the other party in a quiet room.
- If you or the other party has difficulty hearing, press **VOLUME [V]** to decrease the speaker volume.

Telephone System

To adjust the speaker volume during a conversation

To increase volume, press **VOLUME [^]**.

To decrease volume, press **VOLUME [V]**.

- There are 8 volume levels. If you try to increase/decrease volume when it is at the maximum/minimum level, the base unit will beep 3 times.

To redial the last number dialed

Press **[SP-PHONE]**, then press **[REDIAL]**.

To put a call on hold

Press **[HOLD/CONF]** during a conversation.

- The SP-PHONE indicator flashes.

To return to the call, press **[SP-PHONE]**.

- The handset user can also take the call by pressing **[]** or **[]**.
- If another phone is connected on the same line (p. 9), you can also take the call by lifting its handset.
- If a call is kept on hold for 6 minutes, an alarm tone will start to sound. After 4 additional minutes on hold, the call will be disconnected.

Answering Calls

When a call is received, the unit rings, "Incoming call" is displayed, and the Ringer/Message Alert indicator on the handset and "**LINE IN USE**" on the base unit flash rapidly. If you subscribe to a Call Display service, see page 33.

Handset

- 1 Press [] or [].
 - You can also answer a call by pressing any buttons except [, [] or [**OFF**].
- 2 To hang up, press [**OFF**] or place the handset on the base unit.

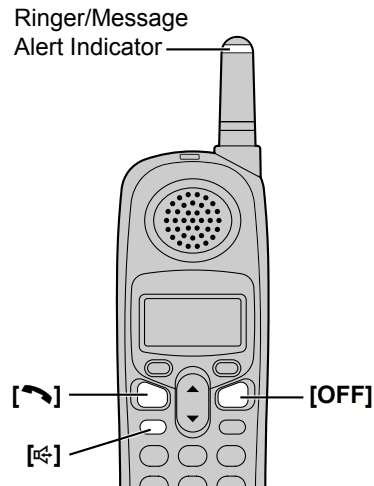

Auto Talk

If the Auto Talk feature is turned on (p. 17), you can answer a call by simply lifting the handset off the base unit.

Temporary ringer off

You can turn the ringer off temporarily by pressing [**OFF**], while the handset is ringing for an outside call. The handset will ring again as usual the next time a call is received.

Base Unit

- 1 Press [**SP-PHONE**].
- 2 Speak into the **MIC**.
- 3 To hang up, press [**SP-PHONE**].

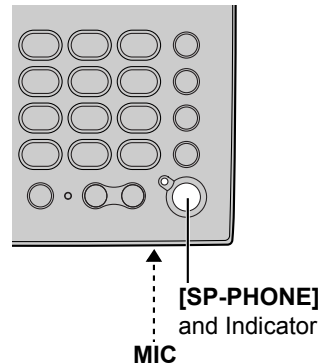

- To transfer the call to another person, see page 47.
- If the ringer volume is turned off, the unit will not ring (p. 18, 19).

Call Display Service

This unit is compatible with Call Display services offered by your telephone company. If you subscribe to Call Display service, caller names and phone numbers will be displayed and recorded in the Caller List.

How caller information is displayed and announced

When a call comes in, the unit will ring and the caller information will be received. The handset display will show the caller's information*¹, then the handset and base unit will announce the displayed name (e.g. "Call from ROBINSON, TINA") following every ring (**Talking Call Display feature**, p. 34).

Example

ROBINSON, TINA 555-222-3333

- After you answer the call, the display will show the length of the call.
- The handset and base unit announce the caller's name repeatedly until the call is answered.

*¹Personalized Name Display

If you receive a call from one of the phone numbers stored in the phone book, the handset will show the caller's name stored in the phone book instead of incoming caller's name.

- If the unit does not receive caller information, one of the following will be displayed:

Display	Meaning
Unavailable Name & No. OR Unavailable* ²	The caller dialed from an area which does not provide Call Display service.
Private caller	The caller requested not to send his/her information.
Long distance	The caller made a long distance call.

*²This display is shown while viewing the caller list (p. 36).

- Depending on the radio communications with the base unit, the handset may not display caller information immediately after the first ring.
- If your unit is connected to a PBX which does not support Call Display services, you cannot access Call Display service.
- Name display service may not be available in some areas. For further information, please contact your telephone company.
- If you subscribe to both Call Display and Visual Call Waiting services, when a second call is received while talking, a call waiting tone will be heard and the second caller's information will be displayed on the handset in use (p. 51). Contact your telephone company for details about availability in your area, and to verify that Visual Call Waiting is activated on your telephone line.

Call Display Service

Talking Call Display

To use this feature, you need to subscribe to a Call Display service. For further information, please contact your telephone company.

- The unit will announce the caller's name as received from the telephone company. If the caller's phone number is stored in the phone book with a name that is different from the name received from the telephone company, the name announced and the name displayed may be different.
- If the unit does not receive caller information, the unit will announce "Call from private caller", or "Call from long distance". If a call is received from an area where name display service is not available, "Number available" will be announced.
- If the ringer volume of the handset and base unit is off, caller names will not be announced. The announcement is heard at the handset or base unit ringer volume (p. 18, 19).
- If this feature is not turned on, caller names will not be announced (see below, p. 35).
- If you have Call Waiting service, the second caller's information will be displayed but not announced (For Call Waiting Service Users, page 51).
- Name pronunciation may vary.
- The unit will announce each letter of abbreviations, such as "Co." and "Inc."
- Call Display service supports names of up to 15 letters. If the caller's name has more than 15 letters, the name will not be displayed or announced correctly.
- If you subscribe to a Distinctive Ring Service from your telephone company with 2 or 3 consecutive rings, your unit may mute one or more of the rings in order to announce the name of the caller.

To turn Talking Call Display on or off

You can turn Talking Call Display on or off for the handset and base unit separately. If this feature is off, the unit will not announce caller names. The factory preset is ON.

Handset Talking Call Display feature **Handset**

1 Press **[MENU]**.

2 Scroll to "Talk Caller ID" by pressing **[▼]** or **[▲]**, then press **Select**.



Talk Caller ID
 ↵Back ▼▲ Select↵

3 Select "Off" or "On" by pressing **[▼]** or **[▲]**.

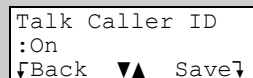

Talk Caller ID
 :On
 ↵Back ▼▲ Save↵

4 Press **save**, then press **[OFF]**.

Call Display Service

Base unit Talking Call Display feature **Handset**

This feature must be turned on or off for the base unit by using the handset.

1 Press **[MENU]**.

2 Scroll to "Initial setting" by pressing **[▼]** or **[▲]**, then press **Select**.

```
Initial setting
└Back ▼▲ Select┘
```

3 Scroll to "Set base unit" by pressing **[▼]** or **[▲]**, then press **Select**.

```
Set base unit
└Back ▼▲ Select┘
```

4 Scroll to "Talk Caller ID" by pressing **[▼]** or **[▲]**, then press **Select**.

```
Talk Caller ID
└Back ▼▲ Select┘
```

5 Select "Off" or "On" by pressing **[▼]** or **[▲]**.

```
Talk Caller ID
:On
└Back ▼▲ Save┘
```

6 Press **Save**, then press **[OFF]**.

Telephone System

Using the Caller List

The unit can record information for up to 50 different callers and store this information in the Caller List. Caller information is sorted by the most recent call to the oldest. When the 51st call is received, the information from the 1st call is deleted.

The unit will also tell you how many calls you missed while you were out or unavailable to answer the phone.

Handset on the base unit

```
2 missed calls ①
Charging
```

① The display will show the number of calls you missed.

② Press **Rcvd calls** to review other calls logged in the Caller List.

Handset off the base unit

```
2 missed calls ①
Rcvd Phone
└calls book┘ ②
```

- If there are no items in the Caller List, "Rcvd calls" will not be displayed.
- After viewing the missed call entries, "missed calls" will disappear from the display.

- When new messages have been recorded (p. 61), "New message" will be displayed in place of missed calls display.

Using the Caller List

Viewing the Caller List **Handset**

- 1** Press **Rcvd calls**, [**▼**], or [**▲**] to enter the Caller List.

e.g. 2 calls missed.

```
2 missed calls
Rcvd      Phone
└calls   book┘
```

```
2 missed calls
▼▲=Scroll list
└All erase
```

- 2** To search from the most recent call, press [**▼**].
To search from the oldest call, press [**▲**].

- The caller's name, number and the time and date of the call are displayed. Name and phone number are alternately displayed as shown on the right.

Example

```
SMITH, JACK
3:10P JUN.29
└Erase Select┘
```

```
555-333-4444
3:10P JUN.29
└Erase Select┘
```

- 3** Press [**OFF**] to exit the list.

- If there is no name information for a caller and you do not store the name and phone number in the phone book, the display will only show the phone number.
- If you do not press any buttons for 60 seconds, the unit will exit the Caller List.

What “√” means

“√” indicates that you have already viewed this calling information or answered the call. If the same caller calls again, the call entry with the “√” will be replaced with the new call entry.

```
SMITH, JACK
3:10P JUN.29 √
```

If a caller calls more than once

The number of times the same caller called is displayed (“x2” to “x9”). The date and time of the most recent call will be recorded. After viewing a caller's information, “x2” to “x9” will be replaced with “√”.

e.g. Called 2 times.

```
TURNER, CINDY
11:20A JUN.12 x2
```

Calling Back from the Caller List **Handset**

- 1** Press **Rcvd calls**, [**▼**], or [**▲**] to enter the Caller List.

- 2** Scroll to the desired caller by pressing [**▼**] or [**▲**].

- 3** Press [**↶**] or [**☎**].

- The phone number is dialed.

- In some cases, you may have to edit the number before dialing (p. 37). (e.g. You may have to add “1” for long distance calls.)
- If a phone number is not displayed in the caller information, you cannot call that caller back from the Caller List.

Using the Caller List

Editing the Caller's Phone Number **Handset**

You can edit a phone number in the Caller List by adding the long distance code "1" or removing its area code.

1 Press **Rcvd calls**, [**▼**], or [**▲**] to enter the Caller List.

2 Scroll to the desired caller by pressing [**▼**] or [**▲**].

PARKER, FRED
11:20A JAN.12
↓Erase Select↓

555-321-5555
11:20A JAN.12
↓Erase Select↓

3 Press **Select**.

4 Press **Edit** repeatedly until the number is shown in the desired format.

- Each time you press **Edit**, the number is rearranged into one of 3 patterns.

(a) 1-Area code-Phone no.

(b) Phone no.

(c) Area code-Phone no.

- The order in which patterns **(a)**–**(c)** are displayed depends on how the telephone number is displayed in step 2.

(a) 1-555-321-5555
↓Edit Save↓

(b) 321-5555
↓Edit Save↓

(c) 555-321-5555
↓Edit Save↓

5 To call the edited number, press [**↶**] or [**↷**].

To save the edited number into the phone book, press **Save**.

- If there is no name information, see "Storing Caller Information in the Phone Book" on page 38, from step 4.

- The number edited in step 4 will not be maintained in the Caller List.
- If you receive a call from a 7-digit phone number stored in the phone book, "Edit" will not be displayed in step 4.

Using the Caller List

Storing Caller Information in the Phone Book

Handset

Caller names and phone numbers that are in the Caller List can be stored in the phone book.

- 1** Press **Rcvd calls**, [**▼**], or [**▲**] to enter the Caller List.

```
2 missed calls
Rcvd      Phone
↓calls   book ↓
```

```
2 missed calls
▼▲=Scroll list
↓All erase
```

- 2** Scroll to the desired caller by pressing [**▼**] or [**▲**].

```
TURNER, CINDY
11:00A JUN.12 x3
↓Erase  Select↓
```

```
555-456-7890
11:00A JUN.12 x3
↓Erase  Select↓
```

- 3** Press **Select**.

- If the number requires editing, see page 37.

- 4** Press **Save**.

```
TURNER, CINDY
555-456-7890
↓Edit      Save↓
```

```
Enter name
  █
      ▼=Next  ▶↓
```

```
CINDY TURNER
  █
  ◀  ▼=Next  ▶↓
```

- If there is no name information for the caller, "Enter name" will be displayed.
 - You can enter a name by performing the following steps:
 - (1) enter the name (p. 41),
 - (2) press [**▼**], and
 - (3) press **Save**.
 - If a name is not required, press [**▼**], then press **Save**.
- To continue storing other items, repeat from step 2.
- To exit programming mode, press [**OFF**].

- You cannot store Caller List item in the phone book if a phone number is not displayed.

Using the Caller List

Erasing Caller Information **Handset**

To erase a specific caller

<p>1 Press Rcvd calls, [▼], or [▲] to enter the Caller List.</p>	<div style="border: 1px solid black; padding: 2px;"> 2 missed calls Rcvd Phone ↙calls book ↘ </div> <div style="border: 1px solid black; padding: 2px; margin-top: 2px;"> 2 missed calls ▼▲=Scroll list ↙All erase </div>
<p>2 Scroll to the desired caller by pressing [▼] or [▲], then press Erase.</p> <ul style="list-style-type: none"> • To erase other items, repeat step 2. • To exit the Caller List, press [OFF]. 	<div style="border: 1px solid black; padding: 2px;"> REAGAN, TOM 12:20A JUN.12 ↙Erase Select↘ </div> <div style="border: 1px solid black; padding: 2px; margin-top: 2px; text-align: center;"> Erased </div>

Telephone System

To erase all entries

Before erasing all entries, make sure that you have viewed all missed calls.

<p>1 Press Rcvd calls, [▼], or [▲] to enter the Caller List.</p>	<div style="border: 1px solid black; padding: 2px;"> Rcvd Phone ↙calls book ↘ </div>
<p>2 Press All erase.</p>	<div style="border: 1px solid black; padding: 2px;"> 0 missed call ▼▲=Scroll list ↙All erase </div>
<p>3 Press Yes.</p> <ul style="list-style-type: none"> • All entries in your Caller List are erased. 	<div style="border: 1px solid black; padding: 2px;"> All erase? ↙No Yes↘ </div> <div style="border: 1px solid black; padding: 2px; margin-top: 2px; text-align: center;"> All erased </div>

• To cancel erasing, press **No** after step 2.

Phone Book

The handset can store up to 50 names and phone numbers in its phone book. You can make a call by selecting a name or number from the phone book.

Storing Names and Numbers Handset

1 Press **Phone book**.

Rcvd calls Phone book
↵calls book ↵

2 Press **Add**.

- The display will show the number of stored items.

Phone book
7 items
↵Add Search↵

3 Enter a name of up to 16 characters with the dialing buttons ([0] to [9]) (p. 41), then press [▼].

- If a name is not required, press [▼] then go to step 4.

Enter name
█
▼=Next ▶↵

Example

Tom
↵◀ ▼=Next ▶↵

4 Enter a phone number of up to 32 digits.

- Each time you press ◀, a digit is erased. To erase all of the digits, press and hold ◀.
- If a pause is required when dialing, press P.
- A pause is stored in a phone number as one digit (p. 55).

Enter phone no.
P↵

Example

5557654321 █
↵◀ ▼=Next P↵

5 Press [▼].

- If you want to change the name, press **Edit**. The display returns to step 3. Change the name.
- If you want to change the number, press [▲]. The display returns to step 4. Change the number.

Tom
555-765-4321
↵Edit Save↵

6 Press **Save**.

- To continue storing other items, repeat from step 2.

7 Press **[OFF]**.

- To store numbers for calling card access (see "Chain Dial" on page 43), we recommend that you add pauses after each item. Storing pauses with numbers will prevent misdialing (p. 55). The delay time necessary will depend on your telephone company.

Phone Book

Selecting characters to enter names

Enter names using the dialing buttons. Press each button until the desired character is displayed.

- Pressing each button selects a character in the order shown below.

Keys	Characters	Keys	Characters
[1]	# & ' () * , - . / 1	[6]	m n o M N O 6
[2]	a b c A B C 2	[7]	p q r s P Q R S 7
[3]	d e f D E F 3	[8]	t u v T U V 8
[4]	g h i G H I 4	[9]	w x y z W X Y Z 9
[5]	j k l J K L 5	[0]	0 Space
◀	Erases the character to the left.		
▶	Moves the cursor to the right. (To enter another character using the same number key, move the cursor to the next space.)		

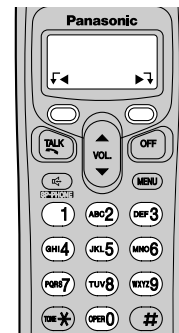

Telephone System

For example, to enter "Tom":

1 Press [8] four times.	T
2 Press [6] three times, then press ▶ to move the cursor.	To
3 Press [6] once.	Tom

If you make a mistake when entering a name or number

Use ◀ to erase the incorrect character. Each time you press ◀, a character is erased. Re-enter the correct character. To erase all characters, press and hold ◀.

Phone Book

Dialing from the Phone Book **Handset**

1 Press **Phone book**.

2 Press **Search**.

```
Phone book
  7 items
↓Add      Search↓
```

3 Scroll to the desired item. To scroll down, press [▼]. To scroll up, press [▲].

```
0-9=Name search
▼▲=Scroll list
```

Phone book items are sorted in the following order:

1	Alphabet letters (Alphabetical)
2	Space & ' () , - . /
3	Numbers 0 to 9
4	☐ *
5	Telephone numbers (If no name is stored)

4 Press [↶] or [☎].

- The displayed phone number is dialed.

```
Frank
444-5555
↓Erase      Edit↓
```

- If "No items stored" is displayed in step 1, the phone book is empty.
- To exit the phone book, press **[OFF]**.
- To view a phone number over 16 digits long, repeat steps 1 to 3, then press **Edit** and then [▼]. When finished, press **[OFF]**.
- To quickly search the desired item, press [▼] or [▲] after step 1.

To search for a name by initial

1. Press **Phone book**.

2. Press **Search**.

3. Press the dialing button for the first letter of the desired name until any name with the same initial is displayed (see the Index on page 43).
e.g. To find "Frank", press **[3]** repeatedly until the first item under "F" is displayed.

- If there are no items beginning with the character you selected, the first item in the next alphabetical index will be displayed.

4. Press [▼] repeatedly until the desired name is displayed.

Phone Book

Index table

Keys	Index	Keys	Index
[1]	Symbols, 1	[6]	M, N, O, 6
[2]	A, B, C, 2	[7]	P, Q, R, S, 7
[3]	D, E, F, 3	[8]	T, U, V, 8
[4]	G, H, I, 4	[9]	W, X, Y, Z, 9
[5]	J, K, L, 5	[0]	0, Space

Chain Dial **Handset**

You can dial a combination of phone book or manual key pad entries while making a call. This feature can be used, for example, to first automatically dial a calling card access number that you have stored in the phone book, then manually or automatically dial your PIN and then automatically dial the destination number from the phone book.

e.g. Using a long distance calling card

- To prevent misdialing, we recommend that you add pauses where needed when storing numbers. For example, add pauses after a calling card access number and your PIN when storing in the phone book (p. 40).
- Search and dial from phone book: 1-800-012-3456 (Calling card access number)
 - The voice guidance may be announced.
 - Search and dial from phone book: 1234 (Calling card PIN)
 - Search and dial from phone book: 1-555-012-3456 (Destination number)

1 While you are on a call;

Press **[MENU]**.

2 Search for the desired item by pressing **[▼]** or **[▲]**.

- To search for an item by initial, see page 42.

```
Phone book
▼▲=Scroll list
└Back Search┘
```

3 Press **Call**.

- The phone number is dialed.
- If required, repeat steps 1 to 3 for any remaining numbers.

```
Alan
1-555-012-3456
└Back Call┘
```

- If you have rotary or pulse service, you need to press **[*]** before pressing **[MENU]** in step 1 to change the dialing mode temporarily to tone.

Phone Book

Editing an Item in the Phone Book **Handset**

1 Press **Phone book**.

2 Press **Search**.

3 Scroll to the desired item by pressing [**▼**] or [**▲**], then press **Edit**.

- To search for the item by initial, see page 42.

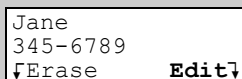

Jane
345-6789
Erase Edit

4 Edit the name (p. 41), then press [**▼**].

- If you do not need to change the name, press [**▼**] then go to step 5.

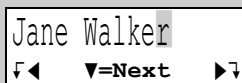

Jane Walker
Next

5 Edit the phone number, then press [**▼**].

- If you do not need to change the number, press [**▼**] then go to step 6.
- Each time you press **◀**, a digit is erased. To erase all of the digits, press and hold **◀**.

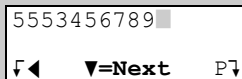

5553456789
Next

6 Press **Save**.

- To continue editing other items, repeat from step 3.

7 Press [**OFF**].

Erasing an Item in the Phone Book **Handset**

1 Press **Phone book**.

2 Press **Search**.

3 Scroll to the desired item by pressing [**▼**] or [**▲**], then press **Erase**.

- To search for the item by initial, see page 42.

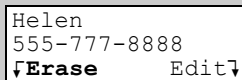

Helen
555-777-8888
Erase Edit

4 Press **Yes**.

- To erase other items, repeat from step 3.

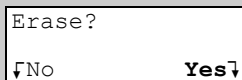

Erase?
No Yes

5 Press [**OFF**].

- To cancel erasing, press **No** after step 3.

Intercom

Intercom calls can be made between the handset.

Making Intercom Calls

From **Handset**

1 Press **[HOLD/INTERCOM]**.

- The paged unit will ring for 1 minute.
- To stop paging, press **[OFF]**.

Calling Base

2 When the paged party answers, begin speaking.

- You can switch to the speaker by pressing **[⇄]**. To switch back to the receiver, press **[↶]**.

Intercom
00-00-05
Mute ▾

3 To disconnect the intercom, press **[OFF]**.

From **Base Unit**

Using this feature, you can also locate a misplaced handset.

1 Press **[LOCATOR/INTERCOM]**.

- The SP-PHONE indicator lights.
- The handset will ring for 1 minute.
- To stop paging, press **[SP-PHONE]** or **[LOCATOR/INTERCOM]**.

2 When the paged party answers, speak into the **MIC**.

3 To disconnect the intercom, press **[SP-PHONE]** or **[LOCATOR/INTERCOM]**.

- The indicator light goes out.

During an intercom call:



- If you have difficulty hearing while using the handset speakerphone and base unit speaker, decrease the speaker volume by pressing **VOLUME [v]** on the base unit or **[v]** on the handset.
- If an incoming call is being received, you will hear two tones (incoming call tone, page 56) and "**LINE IN USE**" will flash rapidly on the base unit.
To answer the call;
 - if using the handset, press **[OFF]**, then **[↶]** or **[⇄]**.
 - if using the base unit, press **[SP-PHONE]** twice.

Intercom

Answering Intercom Calls

Handset

When a handset is paged, it rings and the Ringer/Message Alert indicator flashes rapidly.

1 Press [, [, or [**HOLD/INTERCOM**].

- You can also answer a call by pressing any buttons except [**▼**], [**▲**] or [**OFF**].

Call from Base

2 To disconnect the intercom, press [**OFF**].

Base Unit

When the base unit is being paged, it rings.

1 Press [**SP-PHONE**] or [**LOCATOR/INTERCOM**].

2 To disconnect the intercom, press [**SP-PHONE**] or [**LOCATOR/INTERCOM**].

- When the ringer volume is turned off (p. 18, 19), the handset and the base unit will ring at the low level for intercom calls.
- You cannot change the ringer tone for intercom calls.

Transferring a Call

You can transfer an outside call to the base unit or the handset.

From the **Handset** to the **Base Unit**

1 Handset:

(1) During a call, press **[HOLD/INTERCOM]**.

- The call is put on hold.

(2) Press **Base**.

(3) Wait for the paged party to answer, then you can announce the transfer.

- After the paged party answers, "Intercom hold" is displayed.
- If the paged party does not answer, press **[↶]** or **[↷]** to return to the outside call.

Line on hold.
Transfer to
↓**Base**

Hold
Calling Base

2 Base unit:

Press **[SP-PHONE]** or **[LOCATOR/INTERCOM]** to answer the page.

3 Handset: To complete the transfer, press **[OFF]**.

From the **Base Unit** to the **Handset**

1 Base unit: During a call, press **[LOCATOR/INTERCOM]**.

- The call is put on hold.
- If the paged party does not answer, press **[LOCATOR/INTERCOM]** to return to the outside call.

2 Handset:

Press **[↶]**, **[↷]** or **[HOLD/INTERCOM]** to answer the page.

- You can also answer a call by pressing any buttons except **[▼]**, **[▲]** or **[OFF]**.

3 Base unit: To complete the transfer, press **[SP-PHONE]**.

Transferring a Call

Quick call transfer

You can transfer a call without waiting for the paged party to answer.

Handset

- 1 During a call, press [**HOLD/INTERCOM**], then press **Base**.
- 2 Press [**OFF**] to hang up.

Base Unit

- 1 During a call, press [**LOCATOR/INTERCOM**].
- 2 Press [**SP-PHONE**] to hang up.

- The call will be transferred directly.
- The paged party can answer the transferred call by pressing [**↶**], [**↷**] or [**SP-PHONE**].
- After the paged party answers, the transfer is complete.
- If the paged party does not answer:
 - for the handset, press [**↶**] or [**↷**] to return to the outside call.
 - for the base unit, press [**SP-PHONE**] to return to the outside call.
- If the paged party does not answer within 60 seconds after you hang up, your phone will ring and the call will be returned to your phone. You may speak to the caller again by pressing [**↶**], [**↷**] or [**SP-PHONE**].
If you do not answer the call within 4 minutes, the call will be disconnected.

Conference Calls

While you are talking with an outside caller, the base unit user or a handset user can join the conversation and establish a conference call.

Handset

- 1 During a call, press [**HOLD/INTERCOM**].
 - The call is put on hold.
- 2 Press **Base**.
- 3 When the paged party answers, press **CONF** on your unit to make a conference call.
 - “Conference” is displayed during a conference call.

Base Unit

- 1 During a call, press [**LOCATOR/INTERCOM**].
 - The call is put on hold.
- 2 When the paged party answers, press [**HOLD/CONF**] on your unit to make a conference call.

- To leave the conference, press [**OFF**] on the handset or press [**SP-PHONE**] on the base unit. The two other parties can continue the conversation.
- During a conference, the outside call can be placed on hold by pressing [**HOLD/INTERCOM**] on the handset or [**HOLD/CONF**] on the base unit. Internal communications are not suspended. Only the person who placed the call on hold can resume the full conference by pressing **CONF** on the handset or [**HOLD/CONF**] on the base unit.



Telephone System

Call Share

This feature allows the base unit or the handset to join an existing outside call.

To join a conversation (Call Share)

Handset

- Press [] or [.
- “Conference” is displayed.

Base Unit

- Press [**SP-PHONE**].

Special Features

Temporary Tone Dialing (For Rotary or Pulse Service Users)

Handset Base Unit

Press [*****] (TONE) before entering access numbers which require tone dialing.

- The dialing mode changes to tone. You can enter numbers to access an answering service, electronic banking service, etc. When you hang up, the dialing mode will return to pulse.

Muting Your Conversation

During a call, you can mute your phone so the other party cannot listen to you. When muting your conversation, you can hear the other party.

Handset

Press **Mute**.

- "Mute" will flash.
- **To release the mute**, press **Mute** again.
- If you press [**↶**] or [**↷**] to switch between the receiver and speaker, the mute will be released.

Talk
00-00-30
↓ (VE) Mute ↓

Base Unit

Press [**MUTE**].

- The SP-PHONE indicator flashes.
- **To release the mute**, press [**MUTE**] again.

Special Features

For Call Waiting Service Users

Handset Base Unit

Press **[FLASH/CALL WAIT]** if you hear a call waiting tone during a conversation.

- The first call is put on hold and you can answer the second call.
- To return to the first caller, press **[FLASH/CALL WAIT]** again.
- Call Waiting service cannot be used when the first call is put on hold, or the Answering System is handling a call.
- If this function does not operate properly, consult your telephone company for details.

Visual Call Waiting Service Handset

If you subscribe to both Call Display and Visual Call Waiting services, when a second call is received while talking, the second caller's information will be displayed. After you hear a call waiting tone while talking, the display shows the caller's name with the phone number and "----Waiting----".

```
BROWN, NANCY  
555-666-7777  
----Waiting----
```

Telephone System

- The second caller's information will not be displayed when a parallel connected telephone is in use.
- Contact your telephone company for details about availability in your area, and to verify that Visual Call Waiting is activated on your telephone line.
- The caller's information will only be shown on the display of the handset which is on the outside call.
- The second caller's name will not be announced even if the Talking Call Display feature is on (p. 34).

Special Features

Call Waiting Deluxe Service **Handset**

This unit is compatible with the Call Waiting Deluxe Service offered by your telephone company.

- Availability varies by telephone provider. Contact your telephone company for availability in your area.

After subscribing, Call Waiting Deluxe Service not only allows your handset to display the second caller's information, but also offers you a variety of ways to deal with a second call (p. 53).

Before using Call Waiting Deluxe, turn the "C.WTG (Call Waiting) options" mode on by programming.

- Please contact your telephone company for details and availability in your area.

To turn the "C.WTG (Call Waiting) options" mode on

1 Press **[MENU]**.

2 Scroll to "Initial setting" by pressing **[▼]** or **[▲]**, then press **Select**.

```
Initial setting
└Back ▼▲ Select┘
```

3 Scroll to "Set tel line" by pressing **[▼]** or **[▲]**, then press **Select**.

```
Set tel line
└Back ▼▲ Select┘
```

4 Scroll to "C.WTG options" by pressing **[▼]** or **[▲]**, then press **Select**.

```
C.WTG options
└Back ▼▲ Select┘
```

5 Select "On" by pressing **[▼]** or **[▲]**.

```
C.WTG options
:Off
└Back ▼▲ Save┘
```

6 Press **save**, then press **[OFF]**.

To turn the "C.WTG (Call Waiting) options" mode off, select "Off" by pressing **[▼]** or **[▲]** in step 5.

Special Features

To use Call Waiting Deluxe Service

You can choose from the options on the display as shown below.

Display	Signification
Ans (Answer)	Answers the second call, while keeping the first call on hold.
Hold	The second call is put on hold. The caller will hear the pre-recorded hold message played by the telephone company.
Annc (Announcement)	Plays the pre-recorded busy message from the telephone company for the second caller (e.g. "We are not available now.") and hangs up the second call.
Fwd (Forward)	Forwards the second call to a voice mail service provided by your telephone company, if applicable. Consult your telephone company about voice mail services.
Drop	Hangs up the current call and answers the waiting call.
Conf (Conference)	Answers the second call and combines it with the first call to make a conference call. During a conference call , you can choose either "Drop caller1" or "Drop caller2" to hang up the first or second call.
Return	Returns to the waiting caller while keeping the current call on hold.

Telephone System

- Your telephone company may not offer all of the above options. Contact your telephone company for details.

1 When you hear a call waiting tone while talking, the second caller's information is displayed.

Press **[FLASH/CALL WAIT]**.

- The option menu is displayed.

```
BROWN, NANCY
555-666-7777
----Waiting----
```

2 Enter a displayed option number (1 to 6) to select the desired option.

- The length of the call is displayed.
- You can also select the desired option by pressing **[▼]** or **[▲]** until the option flashes, then pressing **[FLASH/CALL WAIT]**.

```
1=Ans  4=Fwd
2=Hold 5=Drop
3=Annc 6=Conf
```

Special Features

After selecting “Ans” (Answer) or “Hold”:

You can choose one of the following options:

“Return”—to return to the waiting call.

“Drop”—to hang up the current call and answer the waiting call.

“Conference”—to make a conference call.

1. Press **[FLASH/CALL WAIT]** to display the option menu.
2. Enter a displayed option number (1 to 3) to select the desired option.

```
1=Return
2=Drop
3=Conference
```

- If “Return” is selected, you will return to the waiting call. Repeat steps 1 and 2 on page 53 to select another option.

After selecting “Conf” (Conference):

You can choose one of the following options:

“Drop caller1”—to hang up the first call.

“Drop caller2”—to hang up the second call.

1. Press **[FLASH/CALL WAIT]** to display the option menu.
2. Enter a displayed option number (1 or 2) to select the desired option.

```
1=Drop caller1
2=Drop caller2
```

- In step 2, you can also select the desired option by pressing **[▼]** or **[▲]** until the option flashes, then pressing **[FLASH/CALL WAIT]**.
- To cancel the option menu, wait for 20 seconds. The handset display will return to the length of the call.
- Call Waiting cannot be used when a parallel connected telephone is in use.
- If this function does not operate properly, consult your telephone company for details.

Special Features

Using the PAUSE Key (For PBX Line/Long Distance Calls) **Handset**

We recommend that you press **Pause** or **P** if a pause is required for dial with a PBX or to make a long distance call.

e.g. Line access number **[9]** (PBX)

[9] ➔ **Pause** or **P** ➔ **Phone number**

- Pressing **Pause** or **P** once creates a 3.5 second pause. This prevents misdialing when you dial after confirming the entered number (p. 29) or dial a stored number (p. 42, 43).

- Pressing **Pause** or **P** more than once increases the length of the pause between numbers.

Example

9P5556667777
fClear **Pause**f

OR

9P5551234567
f◀ **▼=Next** P▶

FLASH Button **Handset** **Base Unit**

Pressing **[FLASH/CALL WAIT]** allows you to use special features of your host PBX such as transferring an extension call, or accessing optional telephone services such as Call Waiting.

- Pressing **[FLASH/CALL WAIT]** cancels Temporary Tone Dialing mode or mute (p. 50).

Selecting the flash time **Handset**

The flash time required depends on your telephone exchange or host PBX. You can select the following flash times: “700, 600, 400, 300, 250, 110, 100 or 90 ms (milliseconds)”. The factory preset is “700 ms”.

- If PBX functions do not work correctly, consult your PBX supplier for the correct settings.

1 Press **[MENU]**.

2 Scroll to “Initial setting” by pressing **[▼]** or **[▲]**, then press **Select**.

Initial setting
fBack **▼▲ Select**f

3 Scroll to “Set tel line” by pressing **[▼]** or **[▲]**, then press **Select**.

Set tel line
fBack **▼▲ Select**f

4 Scroll to “Set flash time” by pressing **[▼]** or **[▲]**, then press **Select**.

Set flash time
fBack **▼▲ Select**f

5 Select the desired time by pressing **[▼]** or **[▲]**.

Set flash time
:700ms
fBack **▼▲ Save**f

6 Press **Save**, then press **[OFF]**.

Special Features

Incoming Call Tone **Handset** **Base Unit**

During an intercom call (p. 45), you can be informed of incoming calls by two tones. If this feature is turned on, incoming call tones will be heard for as long as the line is ringing. If this feature is set to "2", incoming call tones will be heard only 2 times. If this feature is turned off, no tones will be heard. The factory preset is "2". Using the handset, this feature can be set separately for the handset and base unit.

Handset incoming call tone **Handset**

1 Press **[MENU]**.

2 Scroll to "Ringer setting" by pressing **[▼]** or **[▲]**, then press **Select**.

```
Ringer setting
┆Back ▼▲ Select┆
```

3 Scroll to "Incoming call." by pressing **[▼]** or **[▲]**, then press **Select**.

```
Incoming call.
┆Back ▼▲ Select┆
```

4 Select "On", "Off" or "2" by pressing **[▼]** or **[▲]**.

```
Incoming call
tone :2
┆Back ▼▲ Save┆
```

5 Press **save**, then press **[OFF]**.

Base unit incoming call tone **Handset**

1 Press **[MENU]**.

2 Scroll to "Initial setting" by pressing **[▼]** or **[▲]**, then press **Select**.

```
Initial setting
┆Back ▼▲ Select┆
```

3 Scroll to "Set base unit" by pressing **[▼]** or **[▲]**, then press **Select**.

```
Set base unit
┆Back ▼▲ Select┆
```

4 Scroll to "Incoming call." by pressing **[▼]** or **[▲]**, then press **Select**.

```
Incoming call.
┆Back ▼▲ Select┆
```

5 Select "On", "Off" or "2" by pressing **[▼]** or **[▲]**.

```
Incoming call
tone :2
┆Back ▼▲ Save┆
```

6 Press **save**, then press **[OFF]**.

Special Features

Key Tone **Handset**

You can select whether or not the handset keys will sound tones (key tone, confirmation tone, error tone). The factory preset is ON.

1 Press **[MENU]**.

2 Scroll to “Initial setting” by pressing **[▼]** or **[▲]**, then press **Select**.

Initial setting
 ⌵Back ▼▲ Select⌵

3 Scroll to “Key tone” by pressing **[▼]** or **[▲]**, then press **Select**.

Key tone
 ⌵Back ▼▲ Select⌵

4 Select “Off” or “On” by pressing **[▼]** or **[▲]**.

Key tone
 :On
 ⌵Back ▼▲ Save⌵

5 Press **Save**, then press **[OFF]**.

Re-registering the Handset **Handset & Base Unit**

If “No link to base. Move closer to base, try again.” is displayed even when using the handset near the base unit, the handset may have lost communication with the base unit. You need to re-register the handset to the base unit.

- Make sure the base unit is not being used.
- Have both handset and base unit nearby during registration.
- Follow steps 1 and 2 listed below. You have about 1 minute to complete them.

1 *Base unit:*

Press and hold **[LOCATOR/INTERCOM]** until a beep sounds.

- The CHARGE indicator flashes.

2 *Handset:*

Press and hold **[FLASH/CALL WAIT]** until “Handset Registering” is displayed.

- When registration is complete, a beep sounds from the handset.
- **Wait for 20 seconds after registration is complete while the handset establishes communication with the base unit.**

Handset Registering
 ↓
 Handset [1] Registered

- If the handset beeps 3 times and “Error!!” is displayed, an error occurred. Try again from step 1.
- You can stop registration by pressing **[OFF]** on the handset, and pressing **[LOCATOR/INTERCOM]** on the base unit.

Automatic Answering Operation

When the unit answers a call, a greeting message is played and the caller's message is recorded.

- The total recording time of all messages (greeting, incoming and memo) is **about 16 minutes** (about 8 minutes in "Enhanced recording" mode, p. 26). If messages are recorded in noisy rooms, the time may be shortened by up to 3 minutes.
- To select the caller's recording time, see page 25.
- A maximum of 64 messages (including greeting and memo message) can be recorded.

Setting the Unit to Answer Calls **Base Unit**

Press **[ANSWER ON]** to turn on the Answering System.

- The indicator lights and the unit announces "Answer set" and current day and time. If "Answer set. Set time" is heard, set the date and time (p. 14).
- The unit will announce the remaining recording time if it is less than 3 minutes.
- When no recording time is available, you will need to erase any unnecessary messages before new messages can be recorded (p. 63). The unit can indicate that memory is full in the following ways:
 - "**FULL**" will flash on the base unit and the ANSWER ON indicator will flash rapidly until you erase a message.
 - The unit will announce "Memory full" when you press **[ANSWER ON]**, **[GREETING REC]**, or **[MEMO]**, and after playing back messages or recording a message.
- If you do not want the unit to answer calls, press **[ANSWER ON]** again to turn off the Answering System. The indicator light goes out and "Answer off" is heard.
- You can also turn on the Answering System remotely from an outside phone (p. 68).
- If you subscribe to Call Display service (p. 33), caller information automatically adjusts the date and time when a call is received, provided you have already set the date and time manually (p. 14).

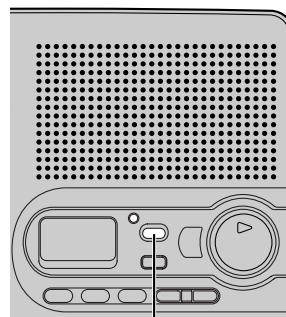

[ANSWER ON] and Indicator

Handset

- 1 Press **[MENU]**.
- 2 Press **select** at "Message play".
- 3 Press **[8]** to turn on the Answering System.
 - "Answer set" is heard.
- 4 Press **[OFF]**.
 - To turn the Answering System off, press **[0]** in step 3. "Answer off" is heard.

Automatic Answering Operation

Monitoring Incoming Calls **Base Unit**

While a caller is leaving a message, you can monitor the call through the base unit speaker.

- To increase the speaker volume while monitoring, press **VOLUME [^]**. To decrease the volume, press **VOLUME [v]**.

To answer a call while monitoring, press **[SP-PHONE]** on the base unit or press **[↶]** or **[↷]** on the handset.

To turn the incoming call monitoring feature off

When the base unit is not in use, press **[GREETING CHECK]**, then press **VOLUME [v]** repeatedly until "0" is displayed. (Make sure the Answering System is turned on.)

OR

While monitoring, press **VOLUME [v]** repeatedly until "0" is displayed.

- If the incoming call monitoring feature is turned off, it will remain off when the next call is monitored.
- If you adjust the speaker volume while playing back messages or using the speakerphone, the speaker volume for monitoring will be turned on again. To turn the speaker volume off, see "To turn the incoming call monitoring feature off" in the step above.

Answering System

Listening to Messages

Voice Day/Time Stamp: During playback, the unit will announce the day and time when each message was recorded (p. 14).

Using the Base Unit **Base Unit**

You can see the total number of recorded messages on the base unit display. If the NEW MESSAGE indicator flashes on the base unit, new messages have been recorded.

- If the Message Alert is turned on (p. 27), the Ringer/Message Alert indicator on the handset will flash slowly when new messages have been recorded and the handset is not in use.

To play back messages

Press **[MESSAGE]**.

- The unit announces the number of new messages and only new messages are played back.
 - When you have no new messages, the unit announces "No new messages. All message playback" and plays back all messages.
 - When you have no messages, the unit announces "No messages".
- The diagram shows a close-up of the base unit's control panel. A circular indicator with a right-pointing arrow is labeled 'NEW MESSAGE Indicator'. Below it is a rectangular button labeled '[MESSAGE]'. A vertical line connects the indicator to the button label.
- During playback, the display shows the message number.
 - At the end of the last message, "End of final message" is heard. The unit will announce the remaining recording time if it is less than 3 minutes.
 - If a call is received during playback, the unit rings and playback stops. To answer the call, press **[SP-PHONE]**. For playback, try again from the beginning after hanging up.

Listening to Messages

Using the Handset (Remote Operation) **Handset**

If "New message" is displayed on the handset, new messages have been recorded.

- If the Message Alert is turned on (p. 27), the Ringer/Message Alert indicator on the handset will flash slowly when new messages have been recorded and the handset is not in use.

To play back messages

1 Press [MENU].

2 Press **select** at "Message play".

- The unit announces the number of new messages and only new messages are played back from the speaker. To switch to the receiver, press [↶]. To switch back to the speaker, press [↷].
- When you have no new messages, the unit announces "No new messages. All message playback" and plays back all messages.
- When you have no messages, the unit announces "No messages".
- To play all messages, press [5].
- If you do not press any buttons, the voice menu will start (see below).

Message play
 ↓Back ▼▲ Select↓

MENU=Call back
 *4 =Erase msg
 ↓Repeat Skip↓

3 To end remote operation, press [OFF].

- If a call is received during playback, the unit rings and playback stops. To answer the call, press [↶] or [↷]. For playback, try again from the beginning after hanging up.
- At the end of the last message, "End of final message" is heard. The unit will announce the remaining recording time if it is less than 3 minutes.
- If you hear "Memory full" after playback, erase unnecessary messages (p. 63).
- When memo messages are played (p. 64), "MEMO" is displayed.

Answering System

Voice menu

If you do not press any buttons at the end of the last message, the unit will announce "End of final message" and the voice menu will begin.

The unit announces, "Press 4 to play back new messages. Press 5 to play back all messages."

- You can press buttons for other playback options (p. 62) even if the voice menu has started.
- If you do not press any buttons within 10 seconds after the voice menu, the handset will exit remote operation.

Listening to Messages

For Call Display service users (p. 33)

During playback using the handset, the handset display will show the name and/or number of the caller whose message is being played.

To call back the displayed number:

1. During playback, press **[MENU]**.

```
Helen
555-777-8888
↓Repeat      Skip↓
```

2. Press **Call**, **[↶]** or **[☎]**.

```
Helen
555-777-8888
↓Edit      Call↓
```

- The unit stops playback and dials the phone number.
- If you need to edit the phone number to call back, see page 37.

During playback **Base Unit** **Handset**

To adjust the speaker volume	<p><i>Base unit:</i> To increase volume, press VOLUME [^]. To decrease volume, press VOLUME [v].</p> <p><i>Handset:</i> To increase volume, press [▲]. To decrease volume, press [▼].</p> <ul style="list-style-type: none"> • You can also adjust the receiver volume on the handset.
To repeat a message	<p><i>Base unit:</i> Press [REPEAT].</p> <p><i>Handset:</i> Press Repeat or [1].</p> <ul style="list-style-type: none"> • If pressed within the first 5 seconds of playback, the previous message will be played.
To skip a message	<p><i>Base unit:</i> Press [SKIP].</p> <p><i>Handset:</i> Press skip or [2].</p>
To stop playback	<p><i>Base unit:</i> Press [STOP].</p> <ul style="list-style-type: none"> • To resume playback, press [MESSAGE]. • If you do not press any buttons for 60 seconds or if you press [STOP] again, playback mode will be cancelled. <p><i>Handset:</i> Press [9].</p> <ul style="list-style-type: none"> • If you do not press any buttons within 15 seconds after stopping playback, the voice menu will start (p. 61).

Erasing Messages

The unit will announce the remaining recording time after playback if it is less than 3 minutes. New messages cannot be recorded when:

- “Memory full” is heard.
 - “**FULL**” flashes on the base unit.
 - the ANSWER ON indicator flashes rapidly (when the Answering System is on).
- We recommend that you erase unnecessary messages after each playback.

Erasing a specific message

Base Unit

Press **[ERASE]** while the message you want to erase is being played.

- The unit beeps, then plays back the next message.
- To exit playback mode, press **[STOP]** twice.

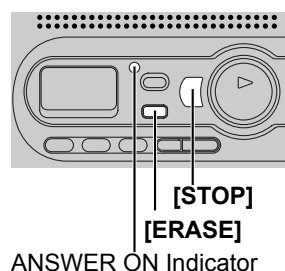

Handset

Press **[*] [4]** while the message you want to erase is being played.

- The unit beeps, then plays back the next message.
- To exit remote operation mode, press **[OFF]**.

Erasing all messages

All recorded messages, except the greeting message, can be erased at one time.

Base Unit

1 Press **[ERASE]** while the base unit is not being used.

- “To erase all messages, press ERASE again” is heard.

2 Within 10 seconds, press **[ERASE]** again.

- The unit beeps, then announces “No messages”.
- The base unit display shows “0”.

Handset

1 Press **[MENU]**.

2 Press **select** at “Message play”.

3 Press **[*] [5]**.

- The unit beeps, then announces “No messages”.
- To end remote operation, press **[OFF]**.

• Information in the Caller List will not be erased. To erase caller information, see page 39.

Recording a Memo Message

Base Unit

You can record a voice memo message of up to 3 minutes in memory.

- 1 Press **[MEMO]**.
- 2 After the long beep, speak clearly about 20 cm (8 inches) away from the **MIC**.
 - The base unit display shows the elapsed recording time.
 - If the elapsed recording time exceeds 99 seconds, the counter continues from 00 to indicate 100 seconds.
- 3 When finished, press **[MEMO]** or **[STOP]**.
 - The NEW MESSAGE indicator flashes.

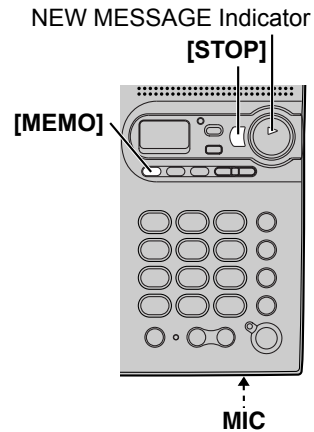

- If you record for over 3 minutes in step 2, the unit will stop recording.
- If "E" is displayed, 6 beeps sound and "Your message was not recorded. Record your message again." is announced, try again from step 1.

Remote Operation from a Touch Tone Phone

While outside, you can operate the Answering System from any touch tone phone. A synthesized voice menu will guide you through the Answering System (p. 67).

- To skip the voice menu and operate the unit directly, see page 68.

Summary of remote operation

Call your unit from a touch tone phone.



Enter your remote code (p. 66) during or after the greeting message.

- The number of new messages is heard, and the new messages will be played.*



After 3 seconds, the voice menu will start (p. 67). Follow the menu or enter direct commands (p. 68).



To end remote operation, hang up.

- The unit will announce the remaining recording time after playback if it is less than 3 minutes.

- The messages are saved.

* If "No new messages" is announced, the unit has only old messages.

If "No messages" is announced, the unit has no messages.

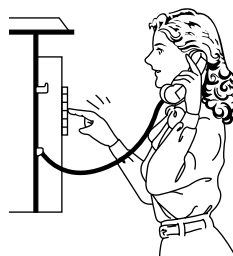

Answering System

Remote Operation from a Touch Tone Phone

Remote Code **Handset**

The remote code prevents unauthorized people from accessing your unit and listening to your messages. Choose any **2-digit number (00–99)** for your remote code. The factory preset remote code is “11”. If you do not program your own remote code, you can use “11”.

1 Press **[MENU]**.

2 Scroll to “Initial setting” by pressing **[▼]** or **[▲]**, then press **Select**.

Initial setting
 ↵Back ▼▲ Select↵

3 Press **select** at “Set answering”.

Set answering
 ↵Back ▼▲ Select↵

4 Scroll to “Remote code” by pressing **[▼]** or **[▲]**, then press **Select**.

Remote code
 ↵Back ▼▲ Select↵

5 Enter a **2-digit remote code (00–99)**.

Remote code
 :11
 ↵Back Save↵

6 Press **save**, then press **[OFF]**.

To confirm the remote code, repeat steps 1 to 4.

- The remote code is displayed. When finished, press **[OFF]**.

Remote Operation from a Touch Tone Phone

Voice Menu

The shaded parts are voice prompts.

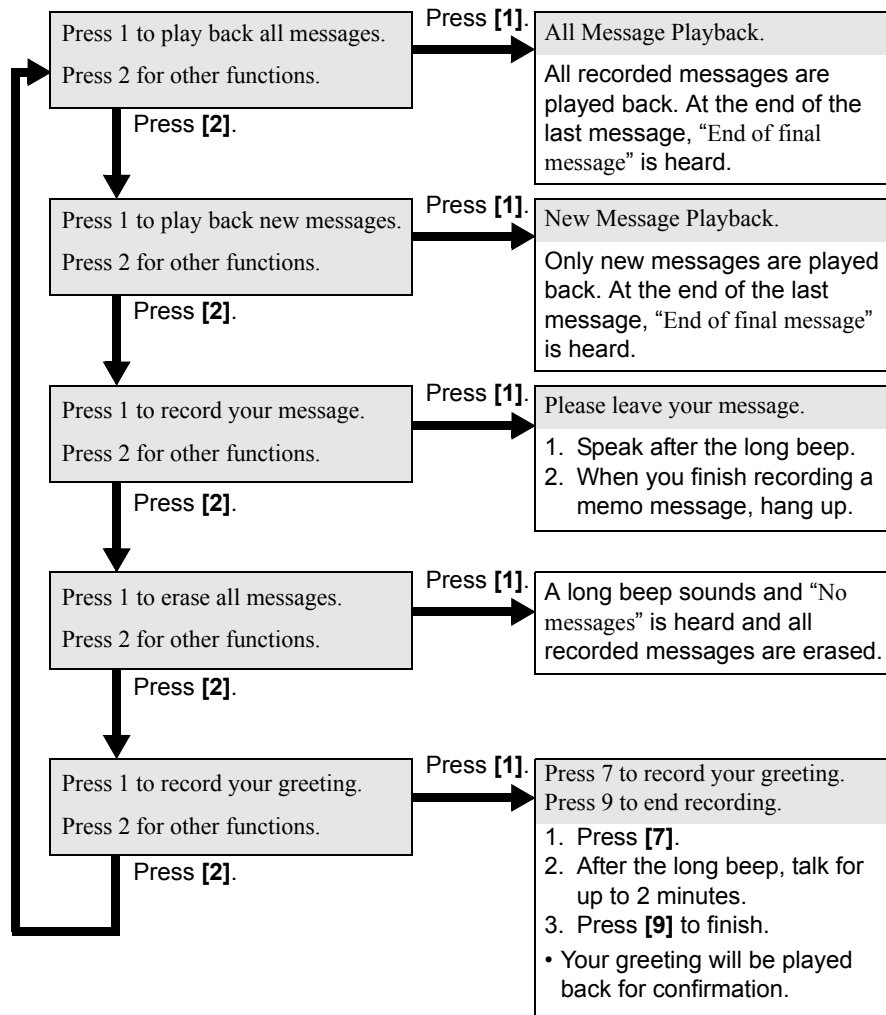

- 3 seconds after playback, the voice menu will try again from the beginning.
- The unit will announce the remaining recording time after playback if it is less than 3 minutes.
- If you hear "Memory full" after playback, erase unnecessary messages (p. 68).
- If you do not press any buttons within 10 seconds after a voice prompt, "Thank you for your call." will be heard and the call will be disconnected.

Remote Operation from a Touch Tone Phone

Direct Remote Operation

Once you have entered the remote code, you can also control your unit by direct commands instead of using the voice menu. To end remote operation, hang up at any time.

Direct commands

[4] :	Plays back new messages.	[7] :	Records a greeting message. After the long beep, talk for up to 2 minutes.
[5] :	Plays back all messages.	[9]	Recording is stopped. • The greeting is played.
[1] :	Repeats the current message. • If pressed within the first 5 seconds of playback, the previous message will be played.	[*] [4] :	Erases the current message. • A short beep will sound and the next message will be played.
[2] :	Skips the current message.	[*] [5] :	Erases all messages. • A long beep will sound and "No messages" will be heard.
[9] :	Stops the current operation. • To resume, enter a direct command within 15 seconds, or the voice menu will start (p. 67).	[0] :	Turns off the Answering System. • The unit hangs up.

To turn on the Answering System

Call your unit and wait for 15 rings.

- The unit will answer and the greeting will be played.
- The Answering System will be turned on. Hang up or enter the remote code for other options.
- When turning on the Answering System using a rotary or pulse service telephone, you cannot enter the remote code for other options.

Skipping the greeting

After calling your unit, press **[*]** during the greeting.

- The unit skips the rest of the greeting and you can start recording your message after the long beep.

Wall Mounting

This unit can be mounted on a wall phone plate.

- 1 Push the hook and turn it upward. Turn the hook until a click is heard.

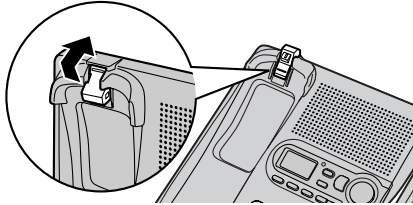

- 2 Press the tabs in the direction of the arrows (1), then remove the wall mounting adaptor (2).

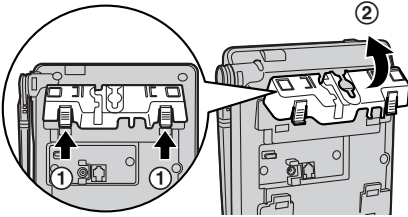

- 3 Connect the AC adaptor. Tuck the telephone line cord inside the wall mounting adaptor, then push the adaptor in the direction of the arrows (1 and 2).

- The word "UP WALL" should face upward.
- Fasten the AC adaptor cord to prevent it from being disconnected.

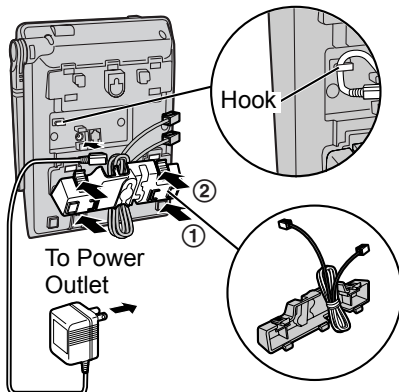

- 4 Connect the telephone line cord. Mount the unit, then slide it down.

- Raise the antenna.

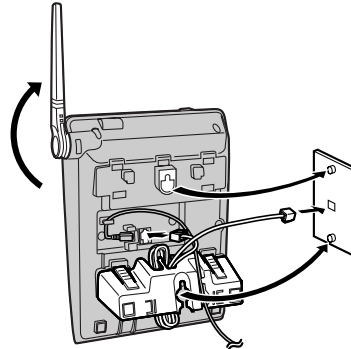

- 5 To charge the handset battery:

Rest the handset on the charge contacts (1), then push the top of the handset so the hook snaps into the slot at the top of the handset (2).

- The unit beeps once and the CHARGE indicator lights.

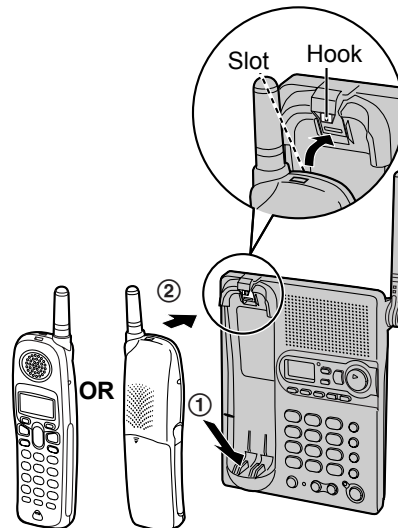

Useful Information

Belt Clip

You can hang the handset on your belt or pocket using the included belt clip.

To attach the belt clip

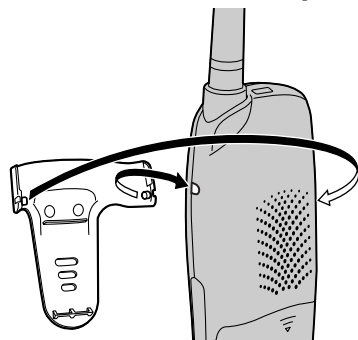

To remove the belt clip

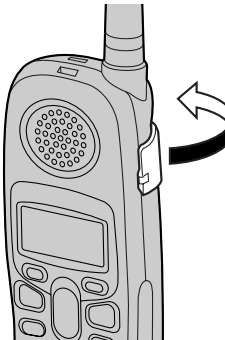

Shoulder Rest Attachment

Use the shoulder rest attachment if you need to keep your hands free during a phone conversation.

To attach the shoulder rest attachment

Attach the included belt clip to the handset (see above), then attach the shoulder rest attachment to the belt clip as shown below. You will hear a click when the shoulder rest attachment is in place.

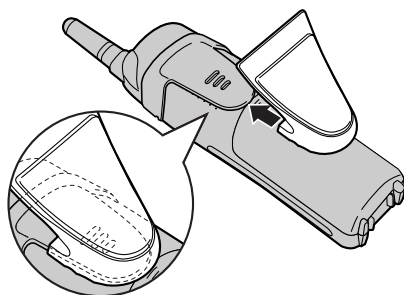

To remove the shoulder rest attachment

Slide the base of the attachment in the direction of the arrow as shown below.

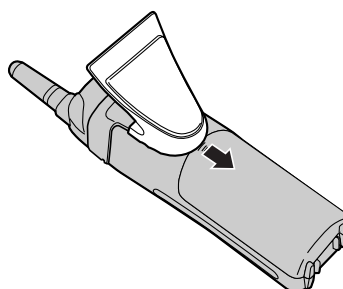

Optional Headset

Connecting an optional headset to the handset allows hands-free phone conversation. Please use only a Panasonic KX-TCA86, KX-TCA91, or KX-TCA92 headset.

Connecting an optional headset

Open the headset jack cover, and insert the headset plug into the headset jack as shown below.

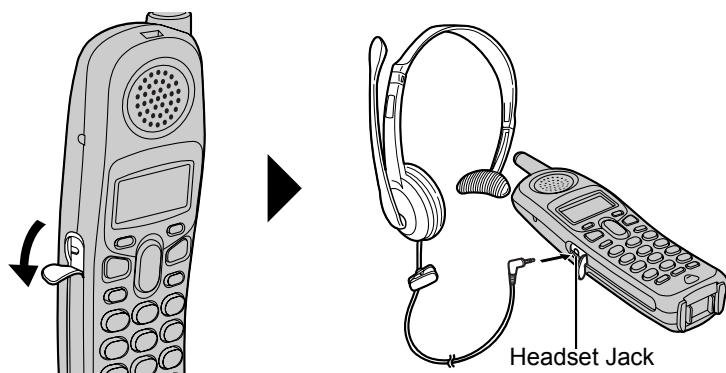

- Headset sold separately. Model shown here is KX-TCA86.

To switch to the speakerphone while using the headset:

Press [**4**]. To return to the headset, press [**↶**].

Direct Commands

Handset

After pressing **[MENU]**, you can also program menu items directly by pressing (**[0]** to **[9]**, **[*]** and **[#]**) instead of using the soft keys.

Menu item	Command	Selection items	Page
Ringer volume	[1] [1]	[0] : Off [1] : Low [2] : Medium [3] : High	p. 18
Ringer tone (for handset)	[1] [2]	[1]–[3] : Tone pattern 1–3 [4]–[7] : Melody pattern 1–4	p. 20
Incoming call tone (for handset)	[1] [3]	[1] : On [2] : Twice [0] : Off	p. 56
Message play	[2]		p. 61
Date and time	[4]	Go to Step 3 on page 14.	—
Voice enhancer	[5]	[1] : On [0] : Off	p. 30
Talking Call Display (for handset)	[9]	[1] : On [0] : Off	p. 34
LCD contrast	[0] [1]	[1]–[6] : Level 1–6	p. 22
Key tone	[0] [2]	[1] : On [0] : Off	p. 57
Auto talk	[0] [3]	[1] : On [0] : Off	p. 17
Set dial mode	[0] [5] [1]	[1] : Pulse [2] : Tone	p. 16
Set flash time	[0] [5] [2]	[1] : 700 ms [2] : 600 ms [3] : 400 ms [4] : 300 ms [5] : 250 ms [6] : 110 ms [7] : 100 ms [8] : 90 ms	p. 55
Set line mode	[0] [5] [3]	[1] : A [2] : B	p. 17
Call Waiting options	[0] [5] [4]	[1] : On [0] : Off	p. 52
Number of rings	[0] [6] [1]	[2]–[7] : 2–7 rings [0] : Toll saver	p. 26
Recording time	[0] [6] [2]	[1] : 1 minute [2] : 2 minutes [3] : 3 minutes [0] : Greeting only	p. 25
Remote code	[0] [6] [3]	Go to Step 5 on page 66.	—
Recording mode	[0] [6] [4]	[1] : Standard recording [2] : Enhanced recording	p. 26

Direct Commands

Menu item	Command	Selection items	Page
Display language	[0] [8] [1]	[1] : English [2] : French	p. 15
Voice guidance language	[0] [8] [2]	[1] : English [2] : French	p. 16
Message alert	[0] [≠]	[1] : On [0] : Off	p. 27
Ringer tone (for base unit)	[0] [*] [1]	[1]–[3] : Tone pattern 1-3 [4]–[7] : Melody pattern 1-4	p. 21
Incoming call tone (for base unit)	[0] [*] [2]	[1] : On [2] : Twice [0] : Off	p. 56
Talking Call Display (for base unit)	[0] [*] [4]	[1] : On [0] : Off	p. 35

During programming:

When “Save” or “Sauv.” is displayed, press the right soft key to **save the new settings**.

To exit programming, press [OFF].

- If you press the direct command incorrectly, press [OFF], then re-enter programming mode by pressing [MENU].
- For function details, see the corresponding pages.

If the Following Appears on Your Display...

The following will be displayed when the unit needs your attention.

Display message	Cause & Remedy
Recharge battery	<ul style="list-style-type: none"> The battery needs to be charged. Recharge the battery (p. 10).
Charge for 6h	<ul style="list-style-type: none"> The battery has been discharged. The handset will not work. Fully charge the battery (p. 10).
No link to base. Move closer to base, try again.	<ul style="list-style-type: none"> The handset has lost communication with the base unit. Walk closer to the base unit and try again or re-register the handset (p. 57). Confirm the base unit's AC adaptor is plugged in. Raise the base unit antenna.
Please lift up and try again.	<ul style="list-style-type: none"> A handset button was pressed while the handset was on the base unit. Lift the handset and press the button again.
Busy	<ul style="list-style-type: none"> The base unit is in use. Try again later.
Error!!	<ul style="list-style-type: none"> When you tried to re-register the handset, the handset and base unit could not link for some reason, such as interference from electrical appliances. Move the handset and base unit away from any electrical appliances and try again.
Phone book full	<ul style="list-style-type: none"> When you tried to store an item in the phone book, the phone book memory was full. Press [OFF] to exit the programming mode. To erase other items from the phone book, see page 44.
System is busy. Please try again later.	<ul style="list-style-type: none"> The handset has lost communication with the base unit. Walk closer to the base unit and try again. The Answering System is in use, such as answering a call or playing back messages. Try again later.
Line in use	<ul style="list-style-type: none"> The base unit is conducting an outside call or a parallel connected telephone is in use.
Line on hold	<ul style="list-style-type: none"> The base unit is on hold for an outside call.

Troubleshooting

If the handset display shows error messages, see "If the Following Appears on Your Display..." (p. 74) for the Cause & Remedy.

Telephone System

Problem	Cause & Remedy
"No link to base. Move closer to base, try again." is displayed and an alarm tone sounds.	<ul style="list-style-type: none"> You are too far from the base unit. Walk closer to the base unit. Confirm the base unit's AC adaptor is plugged in. Raise the base unit antenna. If the above remedies do not solve the problem, the handset may have lost communication with the base unit. Register the handset again (p. 57).
Static, sound cuts in/out, fades. Interference from other electrical units.	<ul style="list-style-type: none"> Move the handset and base unit away from other electrical appliances (p. 3). Walk closer to the base unit. Raise the base unit antenna.
The handset and/or base unit does not ring.	<ul style="list-style-type: none"> The ringer volume is turned off. Set to high, medium or, low (p. 18, 19).
The handset display is blank.	<ul style="list-style-type: none"> If the only handset display is blank, fully charge the battery (p. 10).
You cannot program any function items.	<ul style="list-style-type: none"> Programming is not possible while the handset and/or base unit is being used. Do not pause for over 60 seconds while programming. Walk closer to the base unit. While another user is listening to messages or the Answering System is handling a call, you cannot program. Try again later.
While programming or searching, the handset starts to ring and the program/search stops.	<ul style="list-style-type: none"> A call is coming in. To answer the call, press [↶], [☎] or [SP-PHONE]. Try again from the beginning after hanging up.
You cannot make an intercom/outside call.	<ul style="list-style-type: none"> Your handset is in remote operation mode (p. 61). Exit by pressing [OFF]. The handset you called is too far from the base unit. If the handset or base unit is in use, you may not be able to make a call. Try again later.
You cannot redial.	<ul style="list-style-type: none"> If the last number dialed was more than 48 digits long, the number will not be redialed correctly.

Troubleshooting

Problem	Cause & Remedy
You cannot make long distance calls.	<ul style="list-style-type: none"> • Please make sure you have long distance service.
The handset does not display the caller's name and/or phone number.	<ul style="list-style-type: none"> • You need to subscribe to a Call Display service. • Other telephone equipment may be interfering with your phone. Disconnect it and try again. • Other electrical appliances connected to the same outlet may be interfering with Call Display. • Telephone line noise may be affecting Call Display. • The caller requested not to send his/her caller information (p. 33). • If a call is being transferred to you, the caller information will not be displayed. • If a (separate) Call Display box is connected between the unit and the telephone wall jack, disconnect the Call Display box or plug the unit directly into the wall jack.
The handset and/or base unit does not announce the displayed caller's name.	<ul style="list-style-type: none"> • The handset and/or base unit ringer volumes are turned off. Set to high, medium, or low (p. 18, 19). • The Talking Call Display feature is turned off. Turn it on (p. 34, 35).
The handset and/or base unit does not announce the displayed caller's name properly.	<ul style="list-style-type: none"> • Name pronunciation may vary. • The handset and/or base unit will announce each letter of abbreviations, such as "Co." and "Inc." • Call Display service supports names of up to 15 letters. If the caller's name has more than 15 letters, the name will not be announced correctly.
The handset display exits the Caller List or phone book.	<ul style="list-style-type: none"> • Do not pause for over 60 seconds while searching.
The Ringer/Message Alert indicator flashes slowly when the handset is not ringing and in use.	<ul style="list-style-type: none"> • The Message Alert is turned on and new messages have been recorded. Turn the Message Alert off (p. 27) or listen to the new messages (p. 60, 61, 65).
You cannot have a conversation using the headset.	<ul style="list-style-type: none"> • Make sure the optional headset is connected properly (p. 71). • If "SP-phone" is displayed on the handset, press [] to switch to the headset.

Troubleshooting

Answering System

Problem	Cause & Remedy
The Answering System is on, but incoming messages are not recorded.	<ul style="list-style-type: none"> The recording time is set to "Greeting only". Select "1 minute", "2 minutes" or "3 minutes" (p. 25). Memory is full. Erase unnecessary messages (p. 63).
" FULL " flashes and the ANSWER ON indicator flashes rapidly. No new messages are recorded.	<ul style="list-style-type: none"> Memory is full. Erase unnecessary messages (p. 63).
You cannot operate the Answering System from the base unit or the handset.	<ul style="list-style-type: none"> If the handset or base unit is in use, you may not be able to operate the Answering System. Try again later. If another user is listening to messages or the Answering System is handling a call, you cannot operate the Answering System. Try again later.
You cannot operate the Answering System from a touch tone phone.	<ul style="list-style-type: none"> Make sure you entered the correct remote code (p. 66). The Answering System may not respond if the tones are too short to activate the unit. Press each button firmly. The Answering System is off. Turn it on (p. 68).
You cannot erase messages.	<ul style="list-style-type: none"> While another user is operating the Answering System or a caller is leaving a message, you cannot erase messages.
When you play back messages or turn on the Answering System, the handset and/or base unit announces the wrong day and time.	<ul style="list-style-type: none"> The date and time may be set incorrectly. Set the date and time again (p. 14).

Troubleshooting

General

Problem	Cause & Remedy
The handset and/or base unit does not work.	<ul style="list-style-type: none"> • Check the settings (p. 9–11). • Check whether the dialing mode setting is correct (p. 16). • Fully charge the battery (p. 10). • Clean the charge contacts and charge again (p. 11). • Check battery installation (p. 10). • Unplug the base unit's AC adaptor to reset it. Plug in, and try again. • Re-install the battery (p. 10) and fully charge it.
"Recharge battery" is displayed, "▢" flashes, or the handset beeps intermittently.	<ul style="list-style-type: none"> • Fully charge the battery (p. 10).
"Charge for 6h" and "▢" are displayed and the handset does not work.	<ul style="list-style-type: none"> • The battery has been discharged. Fully charge the battery (p. 10). • Check battery installation (p. 10).
You charged the battery fully, but "Recharge battery" is still displayed and/or "▢" continues to flash, or "Charge for 6h" and "▢" are displayed.	<ul style="list-style-type: none"> • Clean the charge contacts and charge again (p. 11). • The battery may need to be replaced. If you install a new battery, fully charge it (p. 10).
The CHARGE indicator does not go out after the battery has been charged.	<ul style="list-style-type: none"> • This is normal.

Important Information

NOTICE:

This equipment meets the applicable Industry Canada Terminal Equipment Technical Specifications. This is confirmed by the registration number. The abbreviation, "IC:", before the registration number signifies that registration was performed based on a Declaration of Conformity indicating that Industry Canada technical specifications were met. It does not imply that Industry Canada approved the equipment.

And, the term "IC:" signifies that Industry Canada radio technical specifications were met.

Before installing this equipment, users should ensure that it is permissible to be connected to the facilities of the local telecommunications company. The equipment must also be installed using an acceptable method of connection. The customer should be aware that compliance with the above conditions may not prevent degradation of service in some situations.

Repairs to certified equipment should be coordinated by a representative designated by the supplier. Any repairs or alterations made by the user to this equipment, or equipment malfunctions, may give the telecommunications company cause to request the user to disconnect the equipment.

Users should ensure, for their own protection, that the electrical ground connections of the power utility, telephone lines and internal metallic water pipe system, if present, are connected together. This precaution may be particularly important in rural areas.

Caution:

Users should not attempt to make such connections themselves, but should contact the appropriate electric inspection authority, or electrician, as appropriate.

NOTICE:

The **Ringer Equivalence Number** (REN) assigned to each terminal device provides an indication of the maximum number of terminals allowed to be connected to a telephone interface. The termination on an interface may consist of any combination of devices subject only to the requirement that the sum of the Ringer Equivalence Numbers of all the devices does not exceed 5.

The Ringer Equivalence Number (REN) of This Unit:
(found on the bottom of the unit).

NOTICE:

Operation is subject to the following two conditions: (1) this device may not cause interference, and (2) this device must accept any interference, including interference that may cause undesired operation of the device.

Privacy of communications may not be ensured when using this telephone.

Some cordless telephones operate at frequencies that may cause interference to nearby TVs and VCRs. To minimize or prevent such interference, the base of the cordless telephone should not be placed near, or on top of, a TV or VCR. If interference is experienced, move the cordless telephone further away from the TV or VCR. This will often reduce, or eliminate, interference.

Operating near 2.4 GHz electrical appliances may cause interference. Move away from the electrical appliances.

Safety Instructions

Take special care to follow the safety suggestions listed below.

Safety

- 1) The unit should be connected to a power supply only of the type described in the operating instructions or as marked on the unit.
- 2) When left unused for a long period of time, the base unit should be unplugged from the household AC outlet.

Installations

Environment

- 1) Do not use this unit near water— for example, near a bathtub, washbowl, sink, etc. Damp basements should also be avoided.
- 2) The unit should be kept away from heat sources such as radiators, kitchen ranges, etc. It also should not be placed in rooms where the temperature is less than 5°C (41°F) or greater than 40°C (104°F).
- 3) The AC adaptor is used as the main power source. Ensure that the AC outlet is located/installed near the unit and is easily accessible.

Placement

- 1) Do not place heavy objects on top of this unit.
- 2) Care should be taken so that objects do not fall onto, and liquids are not spilled into, the unit. Do not subject this unit to excessive smoke, dust, mechanical vibration or shock.
- 3) Place the unit on a flat surface.

For best performance

- 1) If noise prevents the conversation from being understood on the handset, approach the base unit to lessen the noise.
- 2) The handset should be used at the HIGH volume setting when the reception tone is difficult to hear.
- 3) The handset should be fully recharged on the base unit when “Recharge battery” is displayed and/or “” flashes on the display.
- 4) The handset antenna should not be touched during use because of its high sensitivity.
- 5) The maximum calling distance may be shortened when the unit is used in the following places: Near obstacles such as hills, tunnels, undergrounds, near metal objects such as wire fences, etc.

Medical

Consult the manufacturer of any personal medical devices, such as pacemakers or hearing aids, to determine if they are adequately shielded from external RF (radio frequency) energy. (The unit operates in the frequency range of 2400 MHz to 2481 MHz, and the power output level can range from 0.04 to 0.1 watts.) Do not use the unit in health care facilities if any regulations posted in the area instruct you not to do so. Hospitals or health care facilities may be using equipment that could be sensitive to external RF (radio frequency) energy.

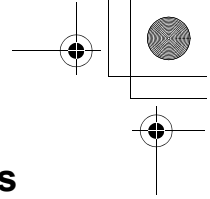
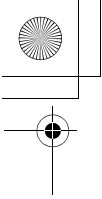

Safety Instructions

WARNING:

TO PREVENT FIRE OR SHOCK HAZARD, DO NOT EXPOSE THIS PRODUCT TO RAIN OR ANY TYPE OF MOISTURE.

If there is any trouble, disconnect the unit from the telephone line and connect a known working phone. If the known working phone operates properly, have your unit repaired by one of the specified authorized Panasonic Factory Servicentres. If the known working phone does not operate properly, consult your telephone company.

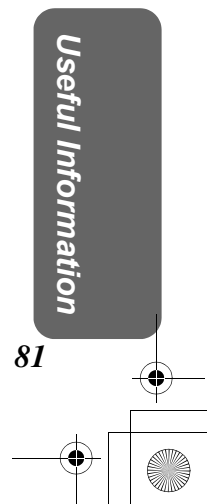
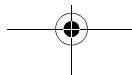
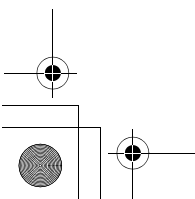
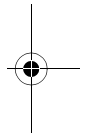
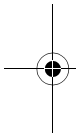

Specifications

■ Base Unit

Power Supply:	AC Adaptor (120 V AC, 60 Hz)
Power Consumption:	Standby: Approx. 2.0 W Maximum: Approx. 5.4 W
Frequency:	2.4 GHz – 2.48 GHz
Dimensions (H x W x D):	Approx. 85 mm x 175 mm x 200 mm (3 ¹¹ / ₃₂ " x 6 ⁷ / ₈ " x 7 ⁷ / ₈ ")
Mass (Weight):	Approx. 470 g (1.04 lb.)

■ Handset

Power Supply:	Ni-MH battery (3.6 V, 830 mAh)
Frequency:	2.4 GHz – 2.48 GHz
Dimensions (H x W x D):	Approx. 208 mm x 52 mm x 39 mm (8 ³ / ₁₆ " x 2 ¹ / ₁₆ " x 1 ¹⁷ / ₃₂ ")
Mass (Weight):	Approx. 190 g (0.42 lb.)
Security Codes:	1,000,000

■ **Dialing Mode:** Tone (DTMF)/Pulse

■ **Operating Environment:** 5 °C – 40 °C (41 °F – 104 °F)

Specifications are subject to change without notice.

Panasonic Canada Inc.

5770 Ambler Drive, Mississauga, Ontario L4W 2T3
PANASONIC PRODUCT—LIMITED WARRANTY

Panasonic Canada Inc. warrants this product to be free from defects in material and workmanship and agrees to remedy any such defect for a period as stated below from the date of original purchase.

Telephone Accessory/Product	—One (1) year, parts and labour
FRS (Family Radio Service) Product	—One (1) year, parts and labour

LIMITATIONS AND EXCLUSIONS

This warranty does not apply to products purchased outside Canada or to any product which has been improperly installed, subjected to usage for which the product was not designed, misused or abused, damaged during shipping, or which has been altered or repaired in any way that affects the reliability or detracts from the performance, nor does it cover any product which is used commercially. Dry cell batteries are also excluded from coverage under this warranty. Rechargeable batteries are warranted for ninety (90) days from date of original purchase.

This warranty is extended to the original end user purchaser only. A purchase receipt or other proof of date of original purchase is required before warranty service is performed.

THIS EXPRESS, LIMITED WARRANTY IS IN LIEU OF ALL OTHER WARRANTIES, EXPRESS OR IMPLIED, EXCLUDING ANY IMPLIED WARRANTIES OF MERCHANTABILITY OR FITNESS FOR A PARTICULAR PURPOSE. IN NO EVENT WILL PANASONIC CANADA INC. BE LIABLE FOR ANY SPECIAL, INDIRECT OR CONSEQUENTIAL DAMAGES.

In certain instances, some jurisdictions do not allow the exclusion or limitation of incidental or consequential damages, or the exclusion of implied warranties, so the above limitations and exclusions may not be applicable.

WARRANTY SERVICE

For product operation and information assistance, please contact your Dealer or our Customer Care Centre at:

Telephone #: (905) 624-5505 Fax #: (905) 238-2360 Web: www.panasonic.ca

For product repairs, please contact one of the following:

- Your Dealer who will inform you of an authorized Servicentre nearest you.
- Our Customer Care Centre at (905) 624-5505 or www.panasonic.ca
- A Panasonic Factory Servicentre listed below:

Richmond, British Columbia

Panasonic Canada Inc.
12111 Riverside Way
Richmond, BC V6W 1K8
Tel: (604) 278-4211
Fax: (604) 278-5627

Calgary, Alberta

Panasonic Canada Inc.
6835-8th St. N. E.
Calgary, AB T2E 7H7
Tel: (403) 295-3955
Fax: (403) 274-5493

Mississauga, Ontario

Panasonic Canada Inc.
5770 Ambler Dr.
Mississauga, ON L4W 2T3
Tel: (905) 624-8447
Fax: (905) 238-2418

Lachine, Québec

Panasonic Canada Inc.
3075, rue Louis A. Amos
Lachine, QC H8T 1C4
Tel: (514) 633-8684
Fax: (514) 633-8020

IF YOU SHIP THE PRODUCT TO A SERVICENTRE

Carefully pack and send prepaid, adequately insured and preferably in the original carton. Include details of the defect claimed, and proof of date of original purchase.

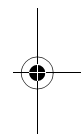
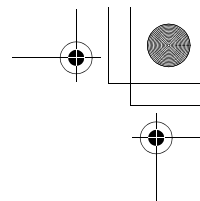
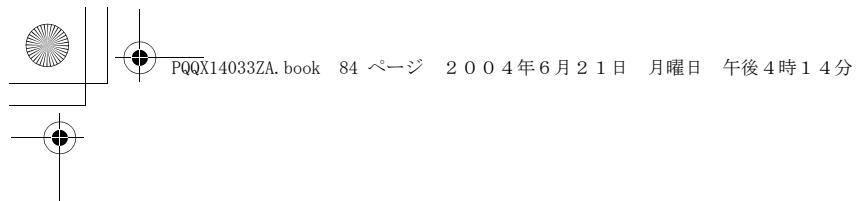

Panasonic Canada Inc.
5770 Ambler Drive, Mississauga, Ontario L4W 2T3

© 2004 Panasonic Communications Co., Ltd. All Rights Reserved.

PQQX14033ZA F0304-0 ①

