

Panasonic®

Operating Instructions

5.8 GHz Expandable Digital Cordless Answering System

Model No. **KX-TG4321**

with 2 Handsets

Model No. **KX-TG4322**

with 3 Handsets

Model No. **KX-TG4323**

5.8 GHz Digital Cordless Answering System with 4 Handsets

Model No. **KX-TG4324**



Model shown is KX-TG4321.

This unit is compatible with Caller ID. You must subscribe to the appropriate service offered by your service provider/telephone company.

Charge the batteries for about 7 hours before initial use.

Please read these operating instructions before using the unit and save them for future reference.

For assistance, visit our website:

<http://www.panasonic.com/help> for customers in the U.S.A. or Puerto Rico.

Table of Contents

| | | | |
|--|----|--|----|
| Introduction | | Intercom/Locator | |
| Product information | 3 | Intercom | 38 |
| Accessory information | 4 | Transferring calls, conference calls | 38 |
| For your safety | 6 | Handset locator | 39 |
| Important safety instructions | 7 | Useful Information | |
| For best performance | 7 | Wall mounting | 40 |
| Preparation | | Error messages | 42 |
| Controls | 9 | Troubleshooting | 43 |
| Display | 10 | FCC and other information | 48 |
| Connections | 10 | Specifications | 51 |
| Battery installation and replacement | 11 | Customer services | 52 |
| Battery charge | 12 | Warranty | 53 |
| Symbols used in these operating instructions | 13 | Index | |
| Setting up the unit before use | 14 | Index | 55 |
| Making/Answering Calls | | | |
| Making calls | 15 | | |
| Answering calls | 15 | | |
| Useful features during a call | 16 | | |
| Shared Phonebook | | | |
| Shared phonebook | 18 | | |
| Programming | | | |
| Programmable settings | 20 | | |
| Special instructions for programmable settings | 25 | | |
| Registering a unit | 26 | | |
| Caller ID Service | | | |
| Using Caller ID service | 27 | | |
| Caller list | 27 | | |
| Answering System | | | |
| Answering system | 30 | | |
| Turning the answering system on/off | 30 | | |
| Greeting message | 30 | | |
| Listening to messages using the base unit | 31 | | |
| Listening to messages using the handset | 32 | | |
| Remote operation | 33 | | |
| Answering system settings | 34 | | |
| Voice Mail Service | | | |
| Voice mail service | 36 | | |

Introduction

Product information

Thank you for purchasing a new Panasonic digital cordless phone.

Notable differences between the models

KX-TG4321 series



● Model shown is KX-TG4324.

| Model No. | Base unit | Handset | |
|-------------|-----------|-----------|----------|
| | Part No. | Part No. | Quantity |
| KX-TG4321*1 | KX-TG4321 | KX-TGA430 | 1 |
| KX-TG4322 | KX-TG4321 | KX-TGA430 | 2 |
| KX-TG4323 | KX-TG4321 | KX-TGA430 | 3 |
| KX-TG4324 | KX-TG4321 | KX-TGA430 | 4 |

*1 Feature differences:

Intercom calls can be made between the handsets by purchasing and registering one or more optional handsets (page 5).

Introduction

Accessory information

Supplied accessories

| No. | Accessory item/ Order number | Quantity | | | |
|-----|---|---------------|---------------|---------------|---------------|
| | | KX-TG 4321 | KX-TG 4322 | KX-TG 4323 | KX-TG 4324 |
| ① | AC adaptor for base unit/ PQLV207T | 1 | 1 | 1 | 1 |
| ② | Telephone line cord/ PQJA10075Z | 1 | 1 | 1 | 1 |
| ③ | Wall mounting adaptor/ PNKL1001Z1 | 1 | 1 | 1 | 1 |
| ④ | Rechargeable batteries* ¹ | 2 | 4 | 6 | 8 |
| ⑤ | Handset cover* ² / PNYNTGA430BR | 1 | 2 | 3 | 4 |
| ⑥ | Charger/ PNLC1001ZB | – | 1 | 2 | 3 |
| ⑦ | AC adaptor for charger/ PQLV209T | – | 1 | 2 | 3 |

*1 See page 5 for replacement battery information.

*2 The handset cover comes attached to the handset.

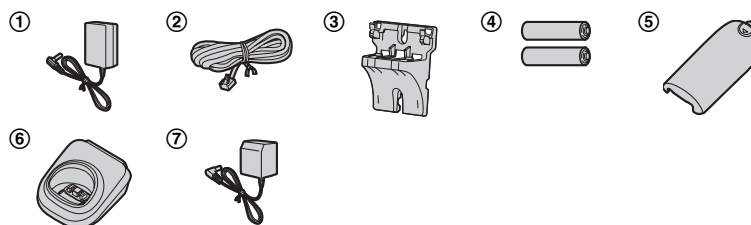

Introduction

Additional/replacement accessories

Please contact your nearest Panasonic dealer for sales information.

| No. | Accessory item | Order number |
|-----|------------------------------|--------------|
| ① | T-adaptor | KX-J66 |
| ② | Battery back-up power supply | KX-TCA230 |

①



②

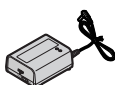

Replacement battery information:

- Replace batteries only with a nickel metal hydride (Ni-MH) type of battery. This model requires 2 AAA (R03) batteries for every handset. For best performance, we recommend using Panasonic rechargeable batteries (Order No. HHR-4DPA). To order, please call 1-800-332-5368 or visit <http://www.panasonic.com/batterystore>

Expanding your phone system

You can expand your phone system by registering optional handsets (max. 4) to a single base unit.



Sales and support information

- To order additional/replacement accessories, call 1-800-332-5368.
- TTY users (hearing or speech impaired users) can call 1-866-605-1277.

Introduction

For your safety

To prevent severe injury and loss of life/property, read this section carefully before using the product to ensure proper and safe operation of your product.

WARNING

Power connection

- Use only the power source marked on the product.
- Do not overload power outlets and extension cords. This can result in the risk of fire or electric shock.
- Completely insert the AC adaptor/power plug into the power outlet. Failure to do so may cause electric shock and/or excessive heat resulting in a fire.
- Regularly remove any dust, etc. from the AC adaptor/power plug by pulling it from the power outlet, then wiping with a dry cloth. Accumulated dust may cause an insulation defect from moisture, etc. resulting in a fire.
- Unplug the product from power outlets if it emits smoke, an abnormal smell, or makes an unusual noise. These conditions can cause fire or electric shock. Confirm that smoke has stopped emitting and contact the Panasonic Call Center at 1-800-211-PANA (1-800-211-7262).
- Never touch the plug with wet hands. Danger of electric shock exists.

Installation

- To prevent the risk of fire or electrical shock, do not expose the product to rain or any type of moisture.
- Do not place or use this product near automatically controlled devices such

as automatic doors and fire alarms. Radio waves emitted from this product may cause such devices to malfunction resulting in an accident.

Operating safeguards

- Unplug the product from power outlets before cleaning. Do not use liquid or aerosol cleaners.
- Do not disassemble the product.
- Do not spill liquids (detergents, cleansers, etc.) onto the telephone line cord plug, or allow it to become wet at all. This may cause a fire. If the telephone line cord plug becomes wet, immediately pull it from the telephone wall jack, and do not use.

Medical

- Consult the manufacturer of any personal medical devices, such as pacemakers or hearing aids, to determine if they are adequately shielded from external RF (radio frequency) energy. (The product operates in the frequency range of 5.76 GHz to 5.84 GHz, and the RF transmission power is 200 mW (max.).)
- Do not use the product in health care facilities if any regulations posted in the area instruct you not to do so. Hospitals or health care facilities may be using equipment that could be sensitive to external RF energy.

CAUTION

Installation and relocation

- Never install telephone wiring during an electrical storm.
- Never install telephone line jacks in wet locations unless the jack is specifically designed for wet locations.

Introduction

- Never touch uninsulated telephone wires or terminals unless the telephone line has been disconnected at the network interface.
- Use caution when installing or modifying telephone lines.
- The AC adaptor is used as the main disconnect device. Ensure that the AC outlet is installed near the product and is easily accessible.
- This product is unable to make calls when:
 - the handset batteries need recharging or have failed.
 - there is a power failure.

Battery

- We recommend using the batteries noted on page 5. **USE ONLY rechargeable Ni-MH batteries AAA (R03) size.**
- Do not mix old and new batteries.
- Do not open or mutilate the batteries. Released electrolyte from the batteries is corrosive and may cause burns or injury to the eyes or skin. The electrolyte may be toxic if swallowed.
- Exercise care when handling the batteries. Do not allow conductive materials such as rings, bracelets or keys to touch the batteries, otherwise a short circuit may cause the batteries and/or the conductive material to overheat and cause burns.
- Charge the batteries provided with or identified for use with this product only, in accordance with the instructions and limitations specified in this manual.
- Only use a compatible base unit (or charger) to charge the batteries. Do not tamper with the base unit (or charger). Failure to follow these instructions may cause the batteries to swell or explode.

Important safety instructions

When using your product, basic safety precautions should always be followed to reduce the risk of fire, electric shock and injury to persons, including the following:

1. Do not use this product near water for example, near a bathtub, washbowl, kitchen sink or laundry tub, in a wet basement or near a swimming pool.
2. Avoid using a telephone (other than a cordless type) during an electrical storm. There may be a remote risk of electric shock from lightning.
3. Do not use the telephone to report a gas leak in the vicinity of the leak.
4. Use only the power cord and batteries indicated in this manual. Do not dispose of batteries in a fire. They may explode. Check with local codes for possible special disposal instructions.

SAVE THESE INSTRUCTIONS

For best performance

Base unit location/avoiding noise

The base unit and other compatible Panasonic units use radio waves to communicate with each other.

- For maximum coverage and noise-free communications, place your base unit:
 - at a convenient, high, and central location with no obstructions between the handset and base unit in an indoor environment.
 - away from electronic appliances such as TVs, radios, personal

Introduction

computers, wireless devices or other phones.

- avoid facing radio frequency transmitters, such as external antennas of mobile phone cell stations (avoid putting the base unit on a bay window or near a window).

- Coverage and voice quality depends on the local environmental conditions.
- If the reception for a base unit location is not satisfactory, move the base unit to another location for better reception.

Environment

- Keep the product away from electrical noise generating devices, such as fluorescent lamps and motors.
- The product should be kept free from excessive smoke, dust, high temperature, and vibration.
- The product should not be exposed to direct sunlight.
- Do not place heavy objects on the power cord or top of the product.
- When you leave the product unused for a long period of time, unplug the product from the power outlet.
- The product should be kept away from heat sources such as heaters, kitchen stoves, etc. It should not be placed in rooms where the temperature is less than 5 °C (41 °F) or greater than 40 °C (104 °F). Damp basements should also be avoided.
- The maximum calling distance may be shortened when the product is used in the following places: Near obstacles such as hills, tunnels, underground, near metal objects such as wire fences, etc.
- Operating the product near electrical appliances may cause interference. Move away from the electrical appliances.

Routine care

- **Wipe the outer surface of the product with a soft moist cloth.**
- Do not use benzine, thinner, or any abrasive powder.

Notice for product disposal, transfer, or return

- This product can store your private/confidential information. To protect your privacy/confidentiality, we recommend that you erase the information such as phonebook or caller list entries from the memory before you dispose of, transfer, or return the product.

Preparation

Controls

Base unit

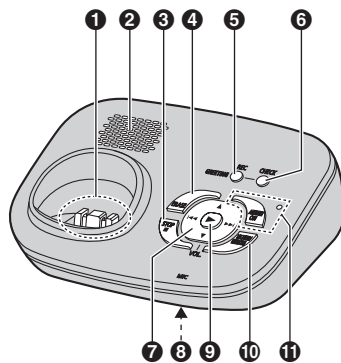

- 1 Charge contacts
- 2 Speaker
- 3 [■] (STOP)
- 4 [ERASE]
- 5 [GREETING REC] (Recording)
- 6 [GREETING CHECK]
- 7 [▲] (VOL.: Volume up)
[▼] (VOL.: Volume down)
[↶] (Repeat)
[↷] (Skip)
- 8 MIC (Microphone)
- 9 [▶] (Play)
Message indicator
- 10 [LOCATOR] [INTERCOM]
- 11 [ANSWER ON]
ANSWER ON indicator

Handset

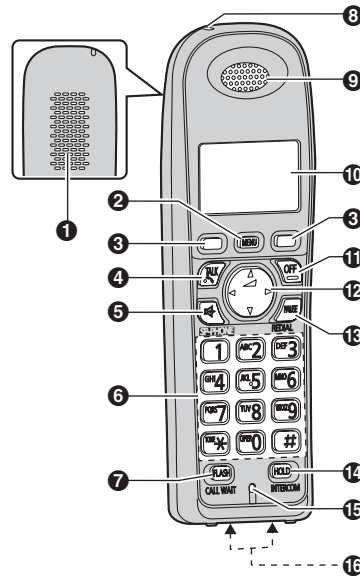

- 1 Speaker
- 2 [MENU]
- 3 Soft keys
- 4 [TALK]
- 5 [SP-PHONE: Speakerphone]
- 6 Dial keypad
([*]: TONE)
- 7 [FLASH] [CALL WAIT]
- 8 Charge indicator
Ringer indicator
Message indicator
- 9 Receiver
- 10 Display
- 11 [OFF]
- 12 Navigator key ([▲]/[▼]/[◀]/[▶])
◁ (Volume: [▲]/[▼])
- 13 [PAUSE] [REDIAL]
- 14 [HOLD] [INTERCOM]
- 15 Microphone
- 16 Charge contacts

Preparation

Using the navigator key

The handset navigator key can be used to navigate through menus and to select items shown on the display by pressing [▲], [▼], [←], or [→].

To adjust the receiver or speaker volume, press [▲] to increase the volume, or press [▼] to decrease the volume repeatedly while talking.

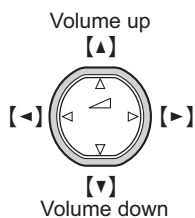

Soft keys

The handset features 2 soft keys. By pressing a soft key, you can select the feature shown directly above it on the display.

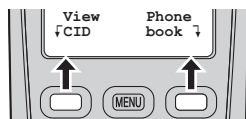

Display

Handset display items

| Item | Meaning |
|-------------|----------------------------|
| | Battery level |
| [1] | Handset number |
| Line in use | Someone is using the line. |

Connections

Connect the AC adaptor cord (1) by pressing the plug firmly (2). Connect the telephone line cord until it clicks into the base unit and telephone line jack (3).

Base unit

- Use only the supplied Panasonic AC adaptor PQLV207.
- Use only the supplied telephone line cord. Using another telephone line cord may not allow the unit to work properly.

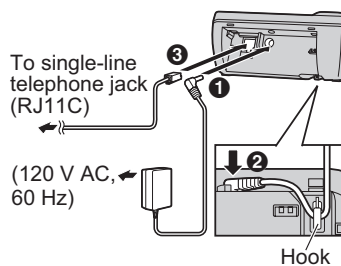

Charger

Available for:
KX-TG4322/KX-TG4323/
KX-TG4324

- Use only the supplied Panasonic AC adaptor PQLV209.

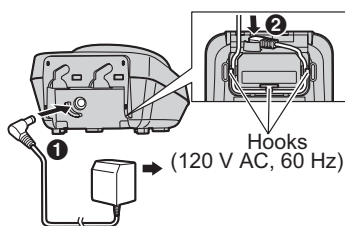

Preparation

Note:

- The AC adaptor must remain connected at all times. (It is normal for the adaptor to feel warm during use.)
- The AC adaptor should be connected to a vertically oriented or floor-mounted AC outlet. Do not connect the AC adaptor to a ceiling-mounted AC outlet, as the weight of the adaptor may cause it to become disconnected.

During a power failure

The unit will not work during a power failure. We recommend connecting a corded-type telephone (without AC adaptor) to the same telephone line or to the same telephone line jack using a Panasonic T-adaptor (page 5). Emergency power can be supplied to the unit by connecting a Panasonic battery back-up power supply noted on page 5.

If you subscribe to a DSL/ADSL service

Please attach a DSL/ADSL filter (contact your DSL/ADSL provider) to the telephone line between the base unit and the telephone line jack in the event of the following:

- noise is heard during conversations.
- Caller ID features do not function properly.

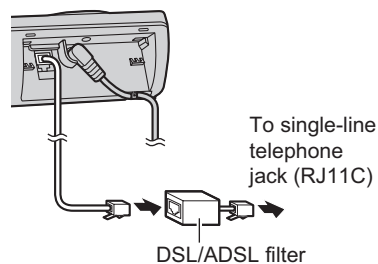

Battery installation and replacement

Important:

- Use the supplied rechargeable batteries (Part No. HHR-65AAABU).
- When installing the batteries:
 - Wipe the battery ends (\oplus , \ominus) with a dry cloth.
 - Avoid touching the battery ends (\oplus , \ominus) or the unit contacts.
 - Ensure correct polarities (\oplus , \ominus).
- When replacing the batteries:
 - USE ONLY rechargeable Ni-MH batteries AAA (R03) size.
 - Do NOT use Alkaline/Manganese/Ni-Cd batteries.
 - We recommend using the Panasonic rechargeable batteries noted on page 5, 7.

- 1 Press the notch on the handset cover firmly, and slide it in the direction of the arrow.

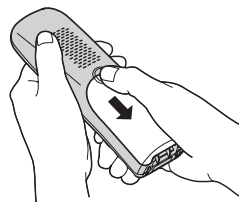

- 2 Insert the batteries negative (\ominus) end first. Close the handset cover.

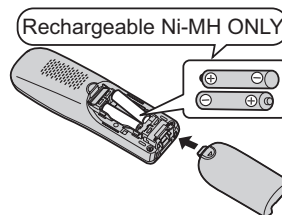

Preparation

Note:

- When replacing batteries, remove the old batteries.

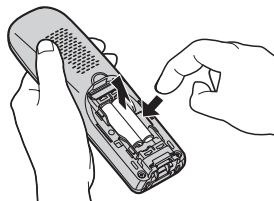

Attention:



A nickel metal hydride battery that is recyclable powers the product you have purchased. Please call 1-800-8-BATTERY (1-800-822-8837) for information on how to recycle this battery.

Battery charge

Place the handset on the base unit or charger for about 7 hours before initial use.

- While charging, "Charging" is displayed and the charge indicator on the handset lights up. When the batteries are fully charged, "Charge completed" is displayed.

Base unit:



Charger*1:



*1 KX-TG4322/KX-TG4323/
KX-TG4324

Note:

- It is normal for the handset to feel warm during charging.
- If you want to use the handset immediately, charge the batteries for at least 15 minutes.
- Clean the charge contacts of the handset, base unit, and charger with a soft and dry cloth once a month. Clean more often if the unit is exposed to grease, dust, or high humidity.

Battery level

| Battery icon | Battery level |
|--------------|---|
| | High |
| | Medium |
| | Low • When flashing: Needs to be charged. |
| | Empty |

Note:

- The batteries need to be charged if the handset beeps while you are engaged in a call or operating the answering system remotely.

Preparation

Panasonic Ni-MH battery performance (supplied batteries)

| Operation | Operating time |
|---|----------------|
| In continuous use | 5 hours max. |
| Not in use (standby) | 11 days max. |
| While using the clarity booster feature (page 17) | 3 hours max. |

Note:

- Actual battery performance depends on a combination of how often the handset is in use and how often it is not in use (standby).
- Even after the handset is fully charged, the handset can be left on the base unit or charger without any ill effect on the batteries.
- The battery level may not be displayed correctly after you replace the batteries. In this case, place the handset on the base unit or charger and let it charge for at least 7 hours.

Symbols used in these operating instructions

| Symbol | Meaning |
|-----------------|--|
| [] | The words in the brackets indicate button names/soft key names on the handset and base unit. Example: Unit keys: [↶], [OFF] Soft keys: [View CID], [Phonebook] |
| → | Proceed to the next operation. |
| “ ” | The words in quotations indicate the menu on the display. Example: “Alarm” |
| [▼]/[▲]: “ ” | Press [▼] or [▲] to select the words in quotations. Example: [▼]/[▲]: “Off” |

Preparation

Setting up the unit before use

Display language

You can select either "English" or "Español" as the display language. The default setting is "English".

- 1 **[MENU]** → **[#][1][1][0]**
- 2 **[v]/[▲]**: Select the desired setting.
- 3 Press the right soft key to save. → **[OFF]**

Voice guidance language

You can select either "English" or "Español" as the voice guidance language of the answering system. The default setting is "English".

- 1 **[MENU]** → **[#][1][1][2]**
- 2 **[v]/[▲]**: Select the desired setting.
- 3 **[Save]** → **[OFF]**

Dialing mode

If you cannot make calls, change this setting according to your telephone line service. The default setting is "Tone".
 "Tone": For tone dial service.
 "Pulse": For rotary/pulse dial service.

- 1 **[MENU]** → **[#][1][2][0]**
- 2 **[v]/[▲]**: Select the desired setting.
- 3 **[Save]** → **[OFF]**

Date and time

- 1 **[MENU]** → **[#][1][0][1]**
- 2 Enter the current month, date, and year by selecting 2 digits for each.
Example: July 15, 2008
[0][7] [1][5] [0][8]
- 3 Enter the current hour and minute (12-hour clock format) by selecting 2 digits for each.
Example: 9:30
[0][9] [3][0]
- 4 **[AM/PM]**: Select "AM" or "PM".
- 5 **[Save]** → **[OFF]**

Note:

- When English is selected as the display language, 12-hour clock format is used. When Spanish is selected, 24-hour clock format is used.
- To correct a digit, press **[▲]**, **[v]**, **[◀]**, or **[▶]** to move the cursor to the digit, then make the correction.
- The date and time may be incorrect after a power failure. In this case, set the date and time again.

Making/Answering Calls

Making calls

- 1 Lift the handset and dial the phone number.
 - To correct a digit, press **[Clear]**.
- 2 Press **[↶]** or **[Call]**.
- 3 When you finish talking, press **[OFF]** or place the handset on the base unit or charger.

Using the speakerphone

- 1 Dial the phone number, and press **[☎]**.
 - Speak alternately with the other party.
- 2 When you finish talking, press **[OFF]**.

Note:

- For best performance, use the speakerphone in a quiet environment.
- To switch back to the receiver, press **[↶]**.

Adjusting the receiver or speaker volume

Press **[▲]** or **[▼]** repeatedly while talking.

Making a call using the redial list

The last 5 phone numbers dialed are stored in the redial list (each 48 digits max.).

- 1 **[REDIAL]**
- 2 **[▼]/[▲]**: Select the desired phone number.
- 3 **[↶]**

Erasing a number in the redial list

- 1 **[REDIAL]**
- 2 **[▼]/[▲]**: Select the desired phone number.

3 **[Erase]** → **[Yes]** → **[OFF]**

Pause (for PBX/long distance service users)

A pause is sometimes required when making calls using a PBX or long distance service. When storing a calling card access number and/or PIN in the phonebook, a pause is also needed (page 19).

Example: If you need to dial the line access number "9" when making outside calls with a PBX:

- 1 **[9]** → **[PAUSE]**
- 2 Dial the phone number. → **[↶]**

Note:

- A 3.5 second pause is inserted each time **[PAUSE]** is pressed. Repeat as needed to create longer pauses.

Answering calls

When a call is being received, the ringer indicator flashes rapidly.

- 1 Lift the handset and press **[↶]** or **[☎]** when the unit rings.
 - You can also answer the call by pressing any dial key from **[0]** to **[9]**, **[*]**, or **[#]**. (**Any key answer feature**)
- 2 When you finish talking, press **[OFF]** or place the handset on the base unit or charger.

Auto talk

You can answer calls simply by lifting the handset off the base unit or charger. You do not need to press **[↶]**. To turn this feature on, see page 22.

Making/Answering Calls

Adjusting the handset ringer volume

Press **[▲]** or **[▼]** repeatedly to select the desired volume while the handset is ringing for an incoming call.

Note:

- You can also program the handset ringer volume beforehand (page 23).

Temporary handset ringer off

While the handset is ringing for a call, you can turn the ringer off temporarily by pressing **[OFF]**.

Adjusting the base unit ringer volume

Press **[▲]** or **[▼]** repeatedly to select the desired volume.

- To turn the ringer off, press and hold **[▼]** until the unit beeps 2 times.

Useful features during a call

Hold

This feature allows you to put an outside call on hold.

- Press **[HOLD]** 2 times during an outside call.
- To release hold, press **[↶]**.
 - Another handset user can take the call by pressing **[↶]**.

Note:

- If a call is kept on hold for more than 9 minutes, an alarm tone starts to sound and the ringer indicator flashes rapidly. After 1 additional minute on hold, the call is disconnected.
- If another phone is connected to the same line (page 11), you can also take the call by lifting its handset.

Mute

While mute is turned on, you can hear the other party, but the other party cannot hear you.

- Press **[Mute]** during an outside call.
 - [Mute]** flashes.
- To return to the conversation, press **[Mute]** again.

Note:

- [Mute]** is a soft key visible on the handset display during a call.

Flash

[FLASH] allows you to use the special features of your host PBX such as transferring an extension call, or accessing optional telephone services.

Note:

- To change the flash time, see page 23.

For call waiting or Call Waiting Caller ID service users

To use call waiting, you must first subscribe to the call waiting service of your service provider/telephone company.

This feature allows you to receive calls while you are already talking on the phone. If you receive a call while on the phone, you will hear a call waiting tone.

If you subscribe to both Caller ID and Call Waiting with Caller ID services, the 2nd caller's information is displayed after you hear the call waiting tone on the handset.

- Press **[CALL WAIT]** to answer the 2nd call.
- To switch between calls, press **[CALL WAIT]**.

Making/Answering Calls

Note:

- Please contact your service provider/telephone company for details and availability of this service in your area.

Temporary tone dialing (for rotary/pulse service users)

You can temporarily switch the dialing mode to tone when you need to access touch-tone services (for example, answering services, telephone banking services, etc.).

Press **[*]** (TONE) before entering access numbers which require tone dialing.

Handset clarity booster

This feature can improve sound clarity when the handset is used in an area where there may be interference. During an outside call, this feature is turned on automatically when necessary.

- When this feature is turned on, "BOOST" flashes.
- While this feature is turned on:
 - the battery operating time is shortened (page 13).
 - the maximum number of extensions that can be used at a time may decrease.

Call share

This feature allows you to join an existing outside call.

To join the conversation, press **[↶]** when the other handset is on an outside call.

Note:

- A maximum of 4 parties (including 1 outside party) can join a conversation using 3 extensions.

- While handset clarity booster is turned on, the maximum number of participating parties may decrease.

Shared Phonebook

Shared phonebook

The shared phonebook allows you to make calls without having to dial manually. Any handset registered to the base unit can use the shared phonebook. You can add 50 names and phone numbers to the shared phonebook.

Important:

- Only 1 person can access the shared phonebook at a time.

Adding entries

- 1 **[Phonebook]**
- 2 **[Add]**
- 3 Enter the party's name (16 characters max.). → **[Next]**
- 4 Enter the party's phone number (32 digits max.). → **[Next]** → **[Save]**
 - To add other entries, repeat from step 2.
- 5 **[OFF]**

Note:

- Caller ID subscribers can use ringer ID feature (page 27).

Character table for entering names

| Key | Character |
|-----|-------------------|
| [1] | & ' () , - . / 1 |
| [2] | a b c A B C 2 |
| [3] | d e f D E F 3 |
| [4] | g h i G H I 4 |
| [5] | j k l J K L 5 |
| [6] | m n o M N O 6 |
| [7] | p q r s P Q R S 7 |
| [8] | t u v T U V 8 |
| [9] | w x y z W X Y Z 9 |
| [0] | 0 Space |

| Key | Character |
|-----|-----------|
| [*] | * |
| [#] | # |

- To enter another character that is located on the same dial key, first press **[▶]** to move the cursor to the next space.

Correcting a mistake

Press **[◀]** or **[▶]** to move the cursor to the character or number you want to erase, then press **[Clear]**. Enter the appropriate character or number.

- Press and hold **[Clear]** to erase all characters or numbers.

Finding and calling a phonebook entry

Scrolling through all entries

- 1 **[Phonebook]** → **[Search]**
- 2 **[▼]/[▲]**: Select the desired entry.
- 3 **[↶]**

Searching by first character (alphabetically)

- 1 **[Phonebook]** → **[Search]**
- 2 Press the dial key (**[0] – [9]**, **[*]**, or **[#]**) which contains the character you are searching for (page 18).
 - Press the same dial key repeatedly to display the first entry corresponding to each character located on that dial key.
 - If there is no entry corresponding to the character you selected, the next entry is displayed.
- 3 **[▼]/[▲]**: Scroll through the phonebook if necessary.
- 4 **[↶]**

Shared Phonebook

Editing entries

- 1 Find the desired entry (page 18).
→ **[Option]**
- 2 **[v]/[▲]**: “Edit” → **[Select]**
- 3 Edit the name if necessary (16 characters max.; page 18). →
[Next]
- 4 Edit the phone number if necessary (32 digits max.). → **[Next]** →
[Save] → **[OFF]**

Erasing entries

- 1 Find the desired entry (page 18).
- 2 **[Erase]** → **[Yes]** → **[OFF]**

Chain dial

This feature allows you to dial phone numbers in the phonebook while you are on a call. This feature can be used, for example, to dial a calling card access number or bank account PIN that you have stored in the phonebook, without having to dial manually.

- 1 During an outside call, press **[MENU]**.
 - Instead of pressing **[MENU]**, you can also press **[Ph.book]** if it is shown on the display.
- 2 **[v]/[▲]**: Select the desired entry.
- 3 Press **[Call]** to dial the number.

Note:

- When storing a calling card access number and your PIN in the phonebook as one phonebook entry, press **[PAUSE]** to add pauses after the number and PIN as necessary (page 15).
- If you have rotary/pulse service, you need to press **[✳]** before pressing **[MENU]** in step 1 to change the dialing mode temporarily to tone.

Programming

Programmable settings

You can customize the unit by programming the following features using the handset.

To access the features, there are 2 methods:

- scrolling through the display menus (page 20)
- using the direct commands (page 22)
- Mainly the direct command method is used in these operating instructions.

Programming by scrolling through the display menus

- 1 **[MENU]**
- 2 Press **[▼]** or **[▲]** to select the desired main menu. → **[Select]**
- 3 Press **[▼]** or **[▲]** to select the desired item in sub-menu 1. → **[Select]**
 - In some cases, you may need to select from sub-menu 2. → **[Select]**
- 4 Press **[▼]** or **[▲]** to select the desired setting. → **[Save]**
 - This step may vary depending on the feature being programmed.
 - To exit the operation, press **[OFF]**.

Note:

- See page 22 for the default settings.

| Main menu | Sub-menu 1 | Sub-menu 2 | Page |
|------------------|-------------------------------|------------|------|
| Message play | – | – | 32 |
| V.M. access | – | – | 37 |
| Night mode | On/Off | – | 25 |
| | Start/End | – | 25 |
| Ringer setting | Ringer volume | – | – |
| | Ringer tone | – | – |
| Set date & time | Date and time ^{*1} | – | 14 |
| | Alarm | – | 25 |
| | Time adjustment ^{*1} | – | – |
| Customer support | – | – | 26 |

Programming

| Main menu | Sub-menu 1 | Sub-menu 2 | Page |
|-----------------|------------------------------|--------------------------------|------|
| Initial setting | Set answering | Ring count ^{*1} | 34 |
| | | Recording time ^{*1} | 35 |
| | | Remote code ^{*1} | 33 |
| | Voice Mail | Store VM access# ^{*1} | 36 |
| | | VM tone detect ^{*1} | 36 |
| | Message alert | — | 35 |
| | LCD contrast | — | — |
| | Key tone | — | — |
| | Auto talk | — | 15 |
| | Caller ID edit ^{*1} | — | 28 |
| | Set tel line | Set dial mode ^{*1} | 14 |
| | | Set flash time ^{*1} | 16 |
| | | Set line mode ^{*1} | — |
| | Registration | HS registration | 26 |
| | | Deregistration | 26 |
| Change language | Display | 14 | |
| | Voice prompt ^{*1} | 14 | |

*1 If you program these settings using one of the handsets, you do not need to program the same item using another handset.

Programming

Programming using the direct commands

- 1 **[MENU]** → **[⇐]**
- 2 Enter the desired feature code.
- 3 Enter the desired setting code. → **[Save]**
 - This step may vary depending on the feature being programmed.
 - To exit the operation, press **[OFF]**.

Note:

- In the following table, < > indicates the default settings.

| Feature | Feature code | Setting code | System setting ^{*1} | Page |
|--|--------------|--|------------------------------|------|
| Alarm | [7][2][0] | [1]: Once [2]: Daily [0]: <Off> | – | 25 |
| Auto talk ^{*2} | [2][0][0] | [1]: On [0]: <Off> | – | 15 |
| Caller ID edit (Caller ID number auto edit) | [2][1][4] | [1]: <On> [0]: Off | ● | 28 |
| Customer support | [6][8][0] | – | – | 26 |
| Date and time | [1][0][1] | – | ● | 14 |
| Deregistration | [1][3][1] | – | – | 26 |
| Display (Change language) | [1][1][0] | [1]: <English> [2]: Español | – | 14 |
| HS registration (Handset registration) | [1][3][0] | – | – | 26 |
| Key tone ^{*3} | [1][6][5] | [1]: <On> [0]: Off | – | – |
| LCD contrast (Display contrast) | [1][4][5] | [1]–[6]: Level 1–6 <3> | – | – |
| Message alert | [3][4][0] | [1]: <On> [0]: Off | – | 35 |
| Message play | [3][0][0] | – | – | 32 |
| Night mode (On/Off) | [2][3][8] | [1]: On [0]: <Off> | – | 25 |
| Night mode (Start/End) | [2][3][7] | <11:00 PM/06:00 AM> | – | 25 |
| Recording time | [3][0][5] | [1]: 1min [2]: 2min [3]: <3min> [0]: Greeting only | ● | 35 |
| Remote code | [3][0][6] | <111> | ● | 33 |

Programming

| Feature | Feature code | Setting code | System setting ^{*1} | Page |
|---|--------------|---|------------------------------|------|
| Ring count | [2][1][1] | [2]–[7]: 2–7 rings <4> [0]: Toll saver | ● | 34 |
| Ringer tone ^{*4, *5} (Handset) | [1][6][1] | [1]–[3]: Tone <1>–3 [4]–[7]: Melody 1–4 | – | – |
| Ringer volume (Handset) | [1][6][0] | [1]: Low [2]: Medium [3]: <High> [0]: Off | – | – |
| Set dial mode | [1][2][0] | [1]: Pulse [2]: <Tone> | ● | 14 |
| Set flash time ^{*6} | [1][2][1] | [1]: <700ms> [2]: 600ms [3]: 400ms [4]: 300ms [5]: 250ms [6]: 110ms [7]: 100ms [8]: 90ms | ● | 16 |
| Set line mode ^{*7} | [1][2][2] | [1]: A [2]: | ● | – |
| Store VM access# | [3][3][1] | – | ● | 36 |
| Time adjustment ^{*8} (Caller ID subscribers only) | [2][2][6] | [1]: <Caller ID [auto]> [0]: Manual | ● | – |
| V.M. access | [3][3][0] | – | – | 37 |
| VM tone detect | [3][3][2] | [1]: <On> [0]: Off | ● | 36 |
| Voice prompt (Change language) | [1][1][2] | [1]: <English> [2]: Español | ● | 14 |

*1 If "System setting" column is checked, you do not need to program the same item using another handset.

*2 If you subscribe to Caller ID service and want to view the caller's information after lifting up the handset to answer a call, turn off this feature.

*3 Turn this feature off if you prefer not to hear key tones while you are dialing or pressing any keys, including confirmation tones and error tones.

*4 If you subscribe to a distinctive ring service (such as IDENT-A-RING), select a tone (tone 1 to 3). If you select a melody, you cannot distinguish lines by their ringers.

*5 If you select one of the melody ringer tones, the ringer tone will continue to play for several seconds even if the caller has already hung up. You may either hear a dial tone or no one on the line when you answer the call.

*6 The flash time depends on your telephone exchange or host PBX. Contact your PBX supplier if necessary. The setting should stay at "700ms" unless pressing **[FLASH]** fails to pick up the waiting call.

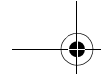

Programming



*7 Generally, the line mode setting should not be adjusted. If “**Line in use**” is not displayed when another phone connected to the same line is in use, you need to change the line mode to “**A**”.

*8 This feature allows the unit to automatically adjust the date and time setting when caller information is received. To use this feature, set the date and time first.

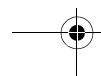
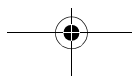
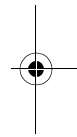
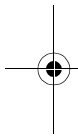

Programming**Special instructions
for programmable
settings****Night mode**

Night mode allows you to select a span of time during which the handset will not ring for outside calls. This feature is useful for instances when you do not want to be disturbed, for example, while sleeping. Night mode can be set for each handset.

Important:

- Set the date and time beforehand (page 14).
- We recommend turning the base unit ringer off (page 16) and call screening off (page 30) in addition to turning the night mode on.
- If you have set the alarm, the alarm sounds even if the night mode is turned on.

Setting the start and end time

- 1 **[MENU]** → **[⇐][2][3][7]**
- 2 Enter the desired hour and minute you wish to start this feature.
- 3 **[AM/PM]**: Select “**AM**” or “**PM**”. → **[▼]**
- 4 Enter the desired hour and minute you wish to end this feature.
- 5 **[AM/PM]**: Select “**AM**” or “**PM**”.
- 6 **[Save]** → **[OFF]**

Note:

- To correct a digit, press **[▲]**, **[▼]**, **[←]**, or **[→]** to move the cursor to the digit, then make the correction.

Turning night mode on/off

- 1 **[MENU]** → **[⇐][2][3][8]**

- 2 **[▼]/[▲]**: Select “**On**” or “**Off**”. → **[Save]** → **[OFF]**

Note:

- When the night mode is turned on, “**Night mode**” is displayed during the selected period.

Alarm

You can set one of 2 different alarm options (once or daily) at a time for each handset. An alarm sounds at the set time for 1 minute.

You can choose an alarm sound from 3 tones and 4 melodies.

Important:

- Set the date and time beforehand (page 14).

- 1 **[MENU]** → **[⇐][7][2][0]**
- 2 **[▼]/[▲]**: Select the desired alarm option. → **[Select]**

| | |
|--------------|--|
| Off | Turns alarm off. Go to step 5. |
| Once | An alarm sounds once at the set time. Enter the desired month, date, and year. |
| Daily | An alarm sounds daily at the set time. |

- 3 Set the desired time. → **[OK]**
- 4 **[▼]/[▲]**: Select the desired ringer tone. → **[Save]**
 - If you set a tone or melody, we recommend selecting a different one for outside calls.

5 [OFF]**Note:**

- To stop the alarm, press any dial key or place the handset on the base unit or charger.

Programming

- When the handset is in use, the alarm will not sound until the handset is in standby mode.
- If you select "Once", the setting changes to "OFF" after the alarm sounds.
- When the ringer volume for outside calls is set to off (page 23), the alarm sound is heard at a low level.

Customer support

The handset can display the Internet address where you can download the operating instructions or get further information for this product by using your computer.

- 1 **[MENU]** → **[#][6][8][0]**
- 2 **[OFF]**

Registering a unit

Operating additional handsets

Additional handsets

Up to 4 handsets can be registered to the base unit.

Important:

- See page 5 for information on the available model.

Registering a handset to a base unit

The supplied handset and base unit are pre-registered. If for some reason the handset is not registered to the base unit, register the handset.

- 1 **Handset:**
[MENU] → **[#][1][3][0]**
- 2 **Base unit:**
Press and hold **[LOCATOR]** for 4 seconds until the registration tone sounds.
 - If all registered handsets start ringing, press the same button to stop. Then repeat this step.
 - The next step should be completed within 90 seconds.
- 3 **Handset:**
Press **[OK]**, then wait until a long beep sounds.
- 4 **[OFF]**

Note:

- While registering, "Base registering" is displayed on all registered handsets.
- When you purchase an additional handset, refer to the additional handset's installation manual for registration.

Deregistering a handset

A handset can cancel its own registration (or the registration of another handset) that is stored in the base unit. This allows the handset to end its wireless connection with the system.

- 1 **[MENU]** → **[#][1][3][1]**
- 2 **[3][3][5]** → **[OK]**
- 3 Select the handset you want to cancel by pressing the desired handset number.

Caller ID Service

Using Caller ID service

Important:

- This unit is Caller ID compatible. To use Caller ID features, you must subscribe to Caller ID service. Contact your service provider/telephone company for details.

Caller ID features

When an outside call is being received, the name and phone number are displayed.

Caller information for the last 50 callers is logged in the caller list from the most recent call to the oldest.

- If the unit cannot receive caller information, the following is displayed:
 - “**Out of area**”: The caller dialed from an area which does not provide Caller ID service.
 - “**Private caller**”: The caller requested not to send caller information.
 - “**Long distance**”: The caller made a long distance call.
- If the unit is connected to a PBX system, caller information may not be received properly. Contact your PBX supplier.

Missed calls

If a call is not answered, the unit treats the call as a missed call. The display shows “**Missed call**”. This lets you know if you should view the caller list to see who called while you were away.

Phonebook name display

When caller information is received and it matches a phone number stored in the phonebook, the stored name in the phonebook is displayed and logged in the caller list.

Ringer ID

This feature can help you identify who is calling by using different ringers for different callers stored in the phonebook. You can assign a different ringer to each phonebook entry. When a call is received from a caller stored in the phonebook, the assigned ringer rings after the caller information is displayed. If you select “**No Ringer ID**” (default), the handset uses the ringer tone you selected on page 23 when a call is received from that caller.

- 1 Find the desired item (page 18). → **[Option]**
- 2 **[▼]/[▲]**: “**Ringer ID**” → **[Select]**
- 3 **[▼]/[▲]**: Select the desired setting.
- 4 **[Save]** → **[OFF]**

Note:

- When you assign the ringer ID to an entry in the shared phonebook using one handset, it is applied for all handsets.

Caller list

Important:

- Only 1 person can access the caller list at a time.

Viewing the caller list and calling back

- 1 **[View CID]**
- 2 Press **[▼]** to search from the most recent call, or **[▲]** to search from the oldest call.
- 3 To call back, press **[↶]**. To exit, press **[OFF]**.

Caller ID Service

Note:

- If the item has already been viewed or answered, "✓" is displayed, even if it was viewed or answered using another handset.

Editing a caller's phone number before calling back

You can edit a phone number in the caller list by removing its area code and/or the long distance code "1".

- 1 **[View CID]**
- 2 **[▼]/[▲]**: Select the desired entry.
→ **[Select]**
- 3 Press **[Edit]** repeatedly until the phone number is shown in the desired format.

- ① Local phone number

Example:

321-5555

- ② Area code – Local phone number

Example:

555-321-5555

- ③ 1 – Area code – Local phone number

Example:

1-555-321-5555

- 4 **[↶]**

Caller ID number auto edit feature

Once you call back an edited number, the unit remembers the Area Code and Format of the Edited Number. Next time when someone calls from the same Area Code, caller information is customized by the unit as follows:

- When the call is being received, the Caller ID number is displayed in the same Format as the Edited Number.

- After the call is ended, the phone number of the caller, when reviewed from the Caller list, is displayed in the same Format as the Edited Number.

For example, you can use this feature to set the unit to ignore the area code of callers in your area code, so that you can call these local numbers using caller information without dialing the area code.

To activate this feature, you must edit an item in the caller list, then call that number. After that, phone numbers from that caller's area code are edited automatically.

This feature can be turned on or off (page 22).

Note:

- Phone numbers from the 4 most recently edited area codes are automatically edited.
- If you move to another area, you can turn this feature off to erase previously edited area codes. To use this feature again, turn it on and reprogram the area codes you want to edit once again.

Erasing selected caller information

- 1 **[View CID]**
- 2 **[▼]/[▲]**: Select the desired entry.
- 3 **[Erase]** → **[Yes]** → **[OFF]**

Erasing all caller information

- 1 **[View CID]**
- 2 **[All erase]** → **[Yes]**

Storing caller information into the phonebook

- 1 [View CID]**
- 2 [▼]/[▲]:** Select the desired entry.
→ **[Select]**
 - To edit the number, press **[Edit]** repeatedly until the phone number is shown in the desired format.
- 3 [Save]**
 - If there is name information for the caller, go to step 5.
- 4** Enter the name (16 characters max.; page 18). → **[Next]** → **[Save]**
- 5 [OFF]**

Answering System

Answering system

The answering system can answer and record calls for you when you are unavailable to answer the phone. You can also set the unit to play a greeting message but not to record caller messages. Select “**Greeting only**” as the recording time setting (page 35).

Important:

- Only 1 person can access the answering system (listen to messages, record a greeting message, etc.) at a time.
- When callers leave messages, the unit records the day and time of each message. Make sure the date and time have been correctly set (page 14).

Memory capacity

The total recording capacity (including your greeting message) is about 12 minutes. A maximum of 64 messages can be recorded.

Note:

- If message memory becomes full, the ANSWER ON indicator on the base unit flashes rapidly.
- When the message memory becomes full:
 - If you use the pre-recorded greeting message, the unit automatically switches to another pre-recorded greeting message asking callers to call again later.
 - If you recorded your own greeting message, the same message is still announced to callers even though their messages are not recorded.

Turning the answering system on/off

Press [**ANSWER ON**] to turn on/off the answering system.

- When the answering system is turned on, the ANSWER ON indicator lights up.

Call screening

While a caller is leaving a message, you can listen to the call through the base unit's speaker. To adjust the speaker volume, press [**▲**] or [**▼**] repeatedly. You can answer the call by pressing [**↶**] on the handset.

Turning off the call screening feature

When the base unit is not in use, press [**GREETING CHECK**], then press and hold [**▼**] until the base unit beeps.

OR

While screening a call, press and hold [**▼**] until the sound goes off.

Note:

- If you adjust the speaker volume while listening to messages or talking on the intercom, the speaker volume for call screening is turned on again.

Greeting message

When the unit answers a call, callers are greeted by a greeting message. You can record your own greeting message or use a pre-recorded greeting message.

Recording your greeting message

You can record your own greeting message (2 minutes max.).

Answering System

- 1 **[GREETING REC]**
- 2 Within 10 seconds, press **[GREETING REC]** again.
- 3 After the base unit beeps, speak clearly about 20 cm (8 inches) away from the MIC.
- 4 Press **[■]** (STOP) to stop recording.

Using a pre-recorded greeting message

If you erase or do not record your own greeting message, the unit plays a pre-recorded greeting message for callers and asks them to leave messages. If the message recording time (page 35) is set to "Greeting only", caller messages are not recorded and the unit plays a different pre-recorded greeting message asking callers to call again.

Playing back the greeting message

Press **[GREETING CHECK]**.

Erasing your greeting message

If you erase your own greeting message, the unit plays a pre-recorded greeting message for callers. Press **[GREETING CHECK]**, and then press **[ERASE]** while your greeting message is playing.

Listening to messages using the base unit

When new messages have been recorded, the message indicator on the base unit flashes.

Press **[▶]**.

- If new messages have been recorded, the base unit plays back new messages.
- If there are no new messages, the base unit plays back all messages.

Operating the answering system

| Key | Operation |
|--------------------------|--|
| [▲] or [▼] | Adjust the speaker volume |
| [◀◀] | Repeat message (during playback)*1 |
| [▶▶] | Skip message (during playback) |
| [■] (STOP) | Pause message <ul style="list-style-type: none"> – To resume playback, press [▶]. – To stop playback completely, press [■] (STOP) again. |
| [ERASE] | Erase currently playing message |

*1 If pressed within the first 5 seconds of a message, the previous message is played.

Erasing all messages

Press **[ERASE]** 2 times while the unit is not being used.

Answering System

Listening to messages using the handset

When new messages have been recorded:

- "New message" is displayed.
- The message indicator on the handset flashes slowly if the message alert feature is turned on (page 35).

- 1 **[MENU]**
- 2 **[▼]/[▲]: "Message play" → [Select]**
 - If new messages have been recorded, the handset plays back new messages.
 - If there are no new messages, the handset plays back all messages.

- 3 When finished, press **[OFF]**.

Note:

- To switch to the receiver, press **[↶]**.

Operating the answering system

You can also operate the answering system by pressing dial keys on the handset.

| Key | Operation |
|--------------------------|--|
| [▲] or [▼] | Adjust the receiver/speaker volume |
| [1] or [◀] | Repeat message (during playback) ^{*1} |
| [2] or [▶] | Skip message (during playback) |
| [4] | Play new messages |
| [5] | Play all messages |
| [8] | Turn answering system on |
| [9] | Stop playback ^{*2} |

| Key | Operation |
|---------------------------------|---------------------------------|
| [0] | Turn answering system off |
| [*][4] or [Erase] | Erase currently playing message |
| [*][5] | Erase all messages |

*1 If pressed within the first 5 seconds of a message, the previous message is played.

*2 To resume operation, press a command key within 15 seconds, or the voice guidance will start.

Voice guidance

If you do not press any dial keys after the last message is played back, the handset's voice guidance starts. Operate the answering system by following the guidance as necessary.

Calling back (Caller ID subscribers only)

If caller information was received for the call, you can call the caller back while listening to a message.

- 1 Press **[Select]** during playback.
 - To edit the number before calling back, press **[Edit]** repeatedly until the phone number is shown in the desired format (page 28).
- 2 **[Call]**

Answering System

Remote operation

Using a touch-tone phone, you can call your phone number from outside and access the unit to listen to messages or change answering system settings. The unit's voice guidance prompts you to press certain dial keys to perform different operations.

Remote access code

A 3-digit remote access code must be entered when operating the answering system remotely. This code prevents unauthorized parties from listening to your messages remotely. The default setting is "111".

- 1 **[MENU]** → **[#][3][0][6]**
- 2 Enter the desired 3-digit remote access code. → **[Save]** → **[OFF]**

Using the answering system remotely

- 1 Dial your phone number from a touch-tone phone.
- 2 After the greeting message starts, enter your remote access code.
 - The unit plays back new messages.
 - The voice guidance announcements are different depending on the voice guidance language setting (page 14).
- 3 Follow the voice guidance prompts as necessary or control the unit using remote commands (page 33).
- 4 When finished, hang up.

Voice guidance

When the English voice guidance is selected

During remote operation, the unit's voice guidance starts and prompts you to press **[1]** to perform a specific operation, or press **[2]** to listen to more available operations. Operations are presented by voice guidance in the following order:

- Play back all messages
- Play back new messages
- Record a message
- Erase all messages

Note:

- If you do not press any dial keys within 10 seconds after a voice guidance prompt, the unit disconnects your call.

When the Spanish voice guidance is selected

To start the voice guidance, press **[9]**. The voice guidance announces the available remote commands (page 33). See the Spanish quick guide for details.

Note:

- If you do not press any dial keys within 15 seconds after a voice guidance prompt, the unit disconnects your call.

Remote commands

You can press dial keys to access certain answering system functions without waiting for the voice guidance to prompt you.

| Key | Operation |
|------------|--|
| [1] | Repeat message (during playback) ^{*1} |
| [2] | Skip message (during playback) |
| [4] | Play new messages |

Answering System

| Key | Operation |
|--------|---|
| [5] | Play all messages |
| [9] | Stop playback ^{*2} Start voice guidance ^{*3} |
| [0] | Turn answering system off |
| [*][4] | Erase currently playing message |
| [*][5] | Erase all messages |

*1 If pressed within the first 5 seconds of a message, the previous message is played.

*2 For English voice guidance only:
To resume operation, enter a remote command within 15 seconds, or the voice guidance starts.

*3 For Spanish voice guidance only

Turning on the answering system remotely

If the answering system is off, you can turn it on remotely.

- 1 Dial your phone number.
- 2 Let the phone ring 15 times.
 - The greeting message is played back.
 - You can either hang up, or from a touch-tone phone you can enter your remote access code and begin remote operation (page 33).

Skipping the greeting message to leave a message

You can leave a message just as any outside caller can. Call your phone number from a touch-tone phone. When the answering system picks up, press [*] to skip the greeting message and record your message after the beep.

Answering system settings

Number of rings before the unit answers calls

You can change the number of times the phone rings "Ring count" before the unit answers calls. You can select 2 to 7 rings, or "Toll saver".

The default setting is "4".

"Toll saver": The unit's answering system answers at the end of the 2nd ring when new messages have been recorded, or at the end of the 4th ring when there are no new messages. If you call your phone from outside to listen to new messages (page 33), you will know that there are no new messages when the phone rings for the 3rd time. You can then hang up without being charged for the call.

- 1 [MENU] → [⊕][2][1][1]
- 2 [▼]/[▲]: Select the desired setting.
→ [Save] → [OFF]

For voice mail service subscribers

If you subscribe to a flat-rate service package that includes Caller ID, call waiting, voice mail, and unlimited local/regional/long distance calls, please note the following:

- To use the voice mail service provided by your service provider/telephone company rather than the unit's answering system, turn off the answering system (page 30).
- To use this unit's answering system rather than the voice mail service provided by your service provider/telephone company, please contact your service provider/telephone

Answering System

company to deactivate your voice mail service.

If your service provider/telephone company cannot do this:

- Set this unit's "**Ring count**" setting so that this unit's answering system answers calls before the voice mail service of your service provider/telephone company does. It is necessary to check the number of rings required to activate the voice mail service provided by your service provider/telephone company before changing this setting.
- Change the number of rings of the voice mail service so that the answering system can answer the call first. To do so, contact your service provider/telephone company.

Caller's recording time

You can change the maximum message recording time allotted to each caller. You can also select "**Greeting only**" which sets the unit to greet callers but not record messages. The default setting is "3min".

- 1 **[MENU]** → **[#][3][0][5]**
- 2 **[▼]/[▲]**: Select the desired setting.
→ **[Save]** → **[OFF]**

Note:

- If you want to select "**Greeting only**", follow the steps above and press **[0]** in step 2.
You may create your own greeting-only message by following the steps on page 30.
The unit plays the pre-recorded greeting-only message asking callers to call again if your own greeting-only message is not recorded.

Message alert

You can select whether or not the message indicator on the handset flashes slowly when new messages are recorded. The default setting is "On".

Important:

- The message indicator will also flash slowly if there are new-recorded voice mail messages (page 37).

- 1 **[MENU]** → **[#][3][4][0]**
- 2 **[▼]/[▲]**: Select the desired setting.
→ **[Save]** → **[OFF]**

Note:

- While message alert is on, battery operating time is shortened (page 13).

Voice Mail Service

Voice mail service

Voice mail is an automatic answering service offered by your service provider/telephone company. After you subscribe to this service, your service provider/telephone company's voice mail system answers calls for you when you are unavailable to answer the phone or when your line is busy. Messages are recorded by your service provider/telephone company, not your telephone. Please contact your service provider/telephone company for details of this service.

Important:

- To use the voice mail service provided by your service provider/telephone company rather than the unit's answering system, turn off the answering system (page 30). For details, see page 34.

Storing the voice mail (VM) access number

In order to listen to your voice mail messages, you must dial your service provider/telephone company's voice mail access number. Once you have stored your voice mail access number, you can dial it automatically (page 37).

- 1 **[MENU]** → **[#][3][3][1]**
- 2 Enter your access number (32 digits max.). → **[Save]** → **[OFF]**

Note:

- When storing your voice mail access number and your mailbox password, press **[PAUSE]** to add pauses (page 15) between the access number and the password as necessary. Contact your service provider/telephone company for the required pause time.

Example:

| | | |
|------------------|--------|----------|
| 1-222-333-4444 | PPPP | 8888 |
| VM access number | Pauses | Password |

To erase the voice mail access number

- 1 **[MENU]** → **[#][3][3][1]**
- 2 Press and hold **[Clear]** until all digits are erased. → **[Save]** → **[OFF]**

Voice mail (VM) tone detection

Your service provider/telephone company sends special signals (sometimes called "voice mail tones" or "stutter tones") to the unit to let you know you have new voice mail messages. If you hear a series of dial tones followed by a continuous dial tone after you press **[↶]**, you have new voice mail messages. Minutes after you hang up a call or after the phone stops ringing, your unit checks the phone line to see if new voice mail messages have been recorded.

Turn this feature off when:

- You do not subscribe to voice mail service.
- Your service provider/telephone company does not send voice mail tones.
- Your phone is connected to a PBX.

If you are not sure which setting is required, contact your service provider/telephone company.

Turning VM tone detection on/off

The default setting is "On".

- 1 **[MENU]** → **[#][3][3][2]**
- 2 **[v]/[▲]**: Select the desired setting. → **[Save]** → **[OFF]**

Voice Mail Service

Listening to voice mail messages

The unit lets you know that you have new voice mail messages in the following ways:

- “**New Voice Mail**” is displayed on the handset.
 - The message indicator on the handset flashes slowly if message alert feature is turned on (“Message alert”; page 35).
- 1** Press [**⏏**], then press [**VM**] within 15 seconds.
OR
[**MENU**] → [**#**][**3**][**3**][**0**]
 - The speakerphone turns on.
 - 2** Follow the pre-recorded instructions.
 - 3** When finished, press [**OFF**].

Note:

- If [**VM**] is not displayed, the voice mail access number has not been stored. Store the number (page 36).
- If the handset still indicates there are new messages even after you have listened to all new messages, turn it off by pressing and holding [**OFF**] until the handset beeps.
- If your voice mail service uses voice mail tones and a message is over 3 minutes long, the handset may not indicate new messages.
- If your voice mail service uses voice mail tones, the tones are heard from any phone connected to the same line. If you want to use another phone to listen to voice mail messages, you have to dial your access number manually.

Intercom/Locator

Intercom

Intercom calls can be made:

- between handsets.
- between the handset and base unit.

Note:

- If you receive an outside call while talking on the intercom, you hear 2 tones.
To answer the call with the handset, press **[OFF]**, then press **[↶]**.
- When paging unit(s) for an intercom call, the paged unit(s) beeps for 1 minute.

Making an intercom call

Handset

- 1 **[INTERCOM]**
- 2 **[▼]/[▲]**: Select the desired unit. → **[Select]**
 - To stop paging, press **[OFF]**.
- 3 When you finish talking, press **[OFF]**.

Base unit

- 1 **[INTERCOM]**
 - All registered handsets beep.
 - To stop paging, press **[INTERCOM]**.
- 2 When you finish talking, press **[INTERCOM]**.

Answering an intercom call

Handset

- 1 Press **[↶]** to answer the page.
- 2 When you finish talking, press **[OFF]**.

Base unit

- 1 Press **[INTERCOM]** to answer the page.
- 2 When you finish talking, press **[INTERCOM]**.

Note:

- When the ringer volume for outside calls is set to off (page 16, 23), the handset and/or base unit rings at a low level for intercom calls.

Transferring calls, conference calls

Outside calls can be transferred between 2 handsets. 2 handsets can have a conference call with an outside party.

- 1 During an outside call, press **[INTERCOM]** to put the call on hold.
- 2 **[▼]/[▲]**: Select the desired unit. → **[Transfer]**
- 3 Wait for the paged party to answer.
 - If the paged party does not answer, press **[↶]** to return to the outside call.
- 4 **To complete the transfer:**
Press **[OFF]**.
 - The outside call is being routed to the destination unit.

To establish a conference call:
Press **[Conf]**.

Intercom/Locator

- To leave the conference, press **[OFF]**. The other parties can continue the conversation.
- To put the outside call on hold, press **[HOLD]**. To resume the conference, press **[Conf]**.

Answering a transferred call

Press **[↶]** to answer the page.

Note:

- After the paging party disconnects, you can talk to the outside caller.

Handset locator

You can locate a misplaced handset by paging it.

- 1 Base unit:**
[LOCATOR]
 - All registered handsets beep for 1 minute.
- 2 To stop paging:**
Base unit:
Press **[LOCATOR]**.
Handset:
Press **[INTERCOM]**, then press **[OFF]**.

Note:

- When the ringer volume for outside calls is set to off (page 23), the handset rings at a low level for paging.

Useful Information

Wall mounting

Base unit

- 1 Lead the telephone line cord through the hole in the wall mounting adaptor in the direction of the arrow.

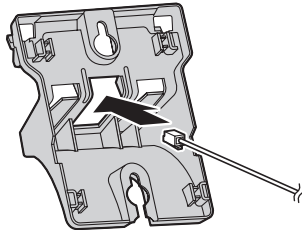

- 2 Tuck the telephone line cord inside the wall mounting adaptor (1). Connect the AC adaptor cord and telephone line cord (2).

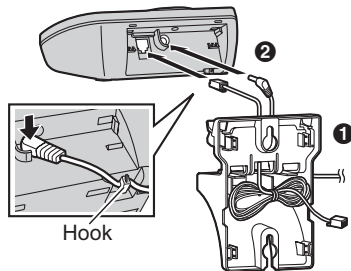

- 3 Insert the hooks on the wall mounting adaptor into the holes A and B on the base unit.

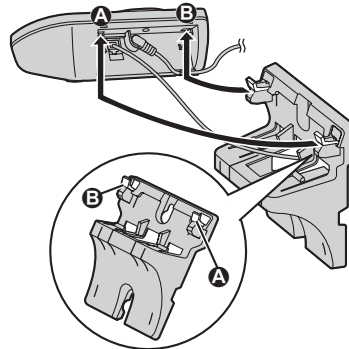

- 4 Adjust the adaptor to hold the base unit, then push it in the direction of the arrow until it clicks into place.

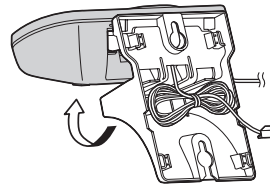
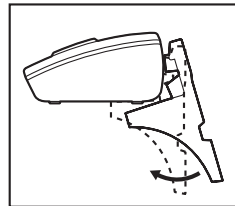

Useful Information

- 5** Connect the telephone line cord. Mount the unit by inserting the mounting pins into the round openings on the adaptor (for pin **B**, use the round cut out at the bottom of the adaptor if you are using the 4 inch phone plate), then slide the unit down to secure it. Connect the AC adaptor to power outlet (page 10).
- There are 2 common types of wall phone plates. The distance between **A** and **B** may vary depending on the size of the wall phone plate installed.

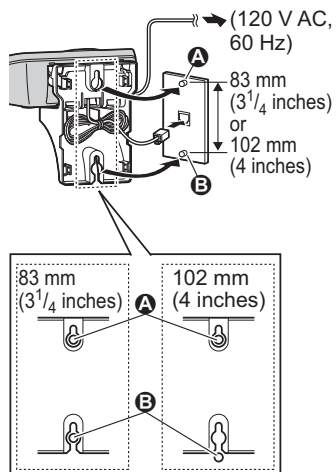

To remove the wall mounting adaptor
While pushing down the release levers **(1)**, remove the adaptor **(2)**.

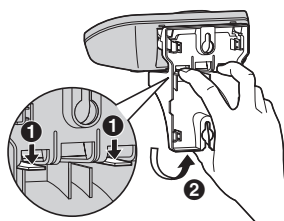

Charger

Available for:
KX-TG4322/KX-TG4323/
KX-TG4324

- 1** Drive the screws (not included) into the wall.

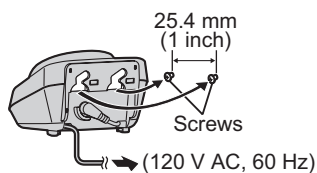

- 2** Mount the charger **(1)**, then slide it down **(2)** and to the right **(3)** until it is secure.

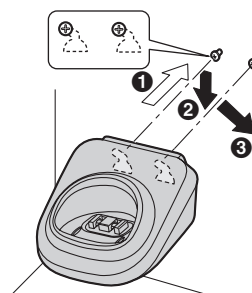

Useful Information

Error messages

If the unit detects a problem, one of the following messages is shown on the display.

| Display message | Cause/solution |
|---|---|
| Busy or System is busy. Please try again later. | <ul style="list-style-type: none"> • The called handset or base unit is in use. • Other units are in use and the system is busy. Try again later. • The handset you are using is too far from the base unit. Move closer and try again. • The handset's registration may have been canceled. Re-register the handset (page 26). |
| Check tel line | <ul style="list-style-type: none"> • The supplied telephone line cord has not been connected yet or not connected properly. Check the connections (page 10). |
| Don't use this battery. | <ul style="list-style-type: none"> • A wrong type of batteries such as Alkaline or Manganese was inserted. Use only the rechargeable Ni-MH batteries noted on page 5, 11. |
| Error!! | <ul style="list-style-type: none"> • The handset's registration has failed. Move the handset and base unit away from all electrical appliances and try again. |
| Insert battery | <ul style="list-style-type: none"> • The handset was placed on the base unit or charger without batteries. Insert the batteries properly (page 11). |
| Invalid | <ul style="list-style-type: none"> • There is no handset registered to the base unit matching the handset number you entered. • The handset is not registered to the base unit. Register the handset (page 26). |
| No link to base. Reconnect AC adaptor. | <ul style="list-style-type: none"> • The handset has lost communication with the base unit. Move closer to the base unit and try again. • Unplug the base unit's AC adaptor to reset the unit. Reconnect the adaptor and try again. • The handset's registration may have been canceled. Re-register the handset (page 26). |
| Phonebook full | <ul style="list-style-type: none"> • The phonebook memory is full. Erase unnecessary entries (page 19). |
| Store VM access# | <ul style="list-style-type: none"> • You have not stored the voice mail access number. Store the number (page 36). |

Useful Information**Troubleshooting**

If you still have difficulties after following the instructions in this section, disconnect the base unit's AC adaptor, then reconnect the base unit's AC adaptor. Remove the batteries from the handset, and then insert the batteries into the handset again.

General use

| Problem | Cause/solution |
|--|--|
| The unit does not work. | <ul style="list-style-type: none"> • Make sure the batteries are installed correctly (page 11). • Fully charge the batteries (page 12). • Check the connections (page 10). • Unplug the base unit's AC adaptor to reset the unit. Reconnect the adaptor and try again. • The handset has not been registered to the base unit. Register the handset (page 26). |
| I cannot hear a dial tone. | <ul style="list-style-type: none"> • The base unit's AC adaptor or telephone line cord is not connected. Check the connections. • If you are using a splitter to connect the unit, remove the splitter and connect the unit to the wall jack directly. If the unit operates properly, check the splitter. • Disconnect the base unit from the telephone line and connect the line to a known working telephone. If the working telephone operates properly, contact our service personnel to have the unit repaired. If the working telephone does not operate properly, contact your service provider/telephone company. |
| The indicator on the handset flashes slowly. | <ul style="list-style-type: none"> • New messages have been recorded. Listen to the new messages (page 32). • New voice mail messages have been recorded. Listen to the new voice mail messages (page 37). |



Programmable settings

| Problem | Cause/solution |
|--|--|
| I have changed the display language to a language I cannot read. | <ul style="list-style-type: none"> • Change the display language (page 14). |

Useful Information

| Problem | Cause/solution |
|--|--|
| While programming, the handset starts to ring. | <ul style="list-style-type: none"> • A call is being received. Answer the call and start again after hanging up. |
| I cannot register a handset to a base unit. | <ul style="list-style-type: none"> • The maximum number of handsets (4) is already registered to the base unit. Cancel unused handset registrations from the base unit (page 26). • Place the handset and the base unit away from other electrical appliances. |

Battery recharge

| Problem | Cause/solution |
|---|---|
| The handset beeps and/or  flashes. | <ul style="list-style-type: none"> • Battery charge is low. Fully charge the batteries (page 12). |
| I fully charged the batteries, but  still flashes or  is displayed. | <ul style="list-style-type: none"> • Clean the charge contacts and charge again (page 12). • It is time to replace the batteries (page 11). |
| I fully charged the batteries, but the operating time seems to be shorter. | <ul style="list-style-type: none"> • Clean the battery ends (+, -) and the charge contacts with a dry cloth, and charge again. |

Making/answering calls, intercom

| Problem | Cause/solution |
|---|---|
| Noise is heard, sound cuts in and out. | <ul style="list-style-type: none"> • You are using the handset or base unit in an area with high electrical interference. Place the base unit and use the handset away from sources of interference. • Move closer to the base unit. • If you use a DSL/ADSL service, we recommend connecting a DSL/ADSL filter between the base unit and the telephone line jack. Contact your DSL/ADSL provider for details. |
| The handset and/or base unit does not ring. | <ul style="list-style-type: none"> • The ringer volume is turned off. Adjust the ringer volume (page 16, 23). • Night mode is turned on. Turn it off (page 25). |
| I cannot make a call. | <ul style="list-style-type: none"> • The dialing mode may be set incorrectly. Change the setting (page 14). • The handset is too far from the base unit. Move closer and try again. |
| I cannot make long distance calls. | <ul style="list-style-type: none"> • Make sure that you have long distance service. |

Useful Information**Caller ID**

| Problem | Cause/solution |
|--|---|
| Caller information is not displayed. | <ul style="list-style-type: none"> ● You need to subscribe to Caller ID service. Contact your service provider/telephone company for details. ● If your unit is connected to any additional telephone equipment such as a Caller ID box or cordless telephone line jack, plug the unit directly into the wall jack. ● If you use a DSL/ADSL service, we recommend connecting a DSL/ADSL filter between the base unit and the telephone line jack. Contact your DSL/ADSL provider for details. ● The name display service may not be available in some areas. Contact your service provider/telephone company for details. ● Other telephone equipment may be interfering with this unit. Disconnect the other equipment and try again. |
| Caller information is displayed late. | <ul style="list-style-type: none"> ● Depending on your service provider/telephone company, the unit may display the caller's information at 2nd ring or later. ● Move closer to the base unit. |
| The caller list/incoming phone numbers are not edited automatically. | <ul style="list-style-type: none"> ● The Caller ID number auto edit feature is turned off. Turn it on and try again (page 22). ● You need to call back the edited number to activate Caller ID number auto edit. |
| I cannot dial the phone number edited in the caller list. | <ul style="list-style-type: none"> ● The phone number you dialed might have been edited incorrectly (for example, the long distance "1" or the area code is missing). Edit the phone number with another pattern (page 28). |
| Time on the unit is shifted. | <ul style="list-style-type: none"> ● Incorrect time information from incoming Caller ID changes the time. Set the time adjustment to off (page 23). |

Useful Information

| Problem | Cause/solution |
|---|--|
| The 2nd caller's information is not displayed during an outside call. | <ul style="list-style-type: none"> ● In order to use Caller ID, call waiting, or Call Waiting Caller ID (CWID), you must first contact your service provider/telephone company and subscribe to the desired service. After subscribing, you may need to contact your service provider/telephone company again to activate this specific service, even if you already subscribed to both Caller ID and Call Waiting with Caller ID services (CWID). |

Answering system

| Problem | Cause/solution |
|---|---|
| The unit does not record new messages. | <ul style="list-style-type: none"> ● The answering system is turned off. Turn it on (page 30). ● The message memory is full. Erase unnecessary messages (page 31). ● The recording time is set to "Greeting only". Change the setting (page 35). ● If you subscribe to the voice mail service, messages are recorded by your service provider/telephone company not your telephone. Change the unit's number of rings setting or contact your service provider/telephone company (page 34). |
| I cannot operate the answering system. | <ul style="list-style-type: none"> ● Someone is using the unit. Wait for the other user to finish. ● A caller is leaving a message. Wait for the caller to finish. ● The handset is too far from the base unit. Move closer. |
| I cannot operate the answering system remotely. | <ul style="list-style-type: none"> ● You are entering the wrong remote access code. If you forgot the remote access code, store a new remote access code (page 33). ● Press each key firmly. ● The answering system is turned off. Turn it on (page 34). ● You are using a rotary/pulse telephone. Try again using a touch-tone phone. |

Useful Information

| Problem | Cause/solution |
|--|--|
| While recording a greeting message or listening to messages, the unit rings and recording stops. | <ul style="list-style-type: none"> • A call is being received. Answer the call and try again later. |

Liquid damage

| Problem | Cause/solution |
|---|---|
| Liquid or other form of moisture has entered the handset/base unit. | <ul style="list-style-type: none"> • Disconnect the AC adaptor and telephone line cord from the base unit. Remove the batteries from the handset and leave to dry for at least 3 days. After the handset/base unit are completely dry, reconnect the AC adaptor and telephone line cord. Insert the batteries and charge fully before use. |

Caution:

- To avoid permanent damage, do not use a microwave oven to speed up the drying process.

If you need assistance with setup or operation

- 1 Visit our website: <http://www.panasonic.com/help>
- 2 Contact us via the web at: <http://www.panasonic.com/contactinfo>
- 3 Call us at: 1-800-211-PANA (1-800-211-7262)
TTY users (hearing or speech impaired users) can call 1-877-833-8855.

When you ship the product

- Carefully pack your unit, preferably in the original carton.
- Attach a letter, detailing the symptom.
- Send the unit to PSTC (Panasonic) Exchange Center, prepaid and adequately insured.
- Do not send your unit to Panasonic Consumer Electronics Company listed on the back cover or to executive or regional sales offices. These locations do not repair consumer products.

Useful Information

FCC and other information

This equipment complies with Part 68 of the FCC rules and the requirements adopted by the ACTA. On the bottom of this equipment is a label that contains, among other information, a product identifier in the format US:ACJ-----.

If requested, this number must be provided to the telephone company.

- Registration No.(found on the bottom of the unit)
- Ringer Equivalence No. (REN)..... 0.1B

A plug and jack used to connect this equipment to the premises wiring and telephone network must comply with the applicable FCC Part 68 rules and requirements adopted by the ACTA. A compliant telephone cord and modular plug is provided with the product. It is designed to be connected to a compatible modular jack that is also compliant.

The REN is used to determine the number of devices that may be connected to a telephone line. Excessive RENs on a telephone line may result in the devices not ringing in response to an incoming call. In most but not all areas, the sum of RENs should not exceed five (5.0). To be certain of the number of devices that may be connected to a line, as determined by the total RENs, contact the local telephone company. For products approved after July 23, 2001, the REN for the product is part of the product identifier that has the format US:AAAEQ##TXXXX. The digits represented by ## are the REN without a decimal point (e.g., 03 is a

REN of 0.3).

If this equipment causes harm to the telephone network, the telephone company will notify you in advance that temporary discontinuance of service may be required. But if advance notice isn't practical, the telephone company will notify the customer as soon as possible. Also, you will be advised of your right to file a complaint with the FCC if you believe it is necessary.

The telephone company may make changes in its facilities, equipment, operations or procedures that could affect the operation of the equipment. If this happens the telephone company will provide advance notice in order for you to make necessary modifications to maintain uninterrupted service.

If trouble is experienced with this equipment, for repair or warranty information, please contact a Factory Service Center or other Authorized Servicer. If the equipment is causing harm to the telephone network, the telephone company may request that you disconnect the equipment until the problem is resolved.

Connection to party line service is subject to state tariffs. Contact the state public utility commission, public service commission or corporation commission for information.

If your home has specially wired alarm equipment connected to the telephone line, ensure the installation of this equipment does not disable your alarm equipment. If you have questions

Useful Information

about what will disable alarm equipment, consult your telephone company or a qualified installer.

This equipment is hearing aid compatible as defined by the FCC in 47 CFR Section 68.316.

When you hold the phone to your ear, noise might be heard in your Hearing Aid. Some Hearing Aids are not adequately shielded from external RF (radio frequency) energy. If noise occurs, use the speakerphone option (if applicable) when using this phone. Consult with your audiologist or Hearing Aid manufacturer about the availability of Hearing Aids which provide adequate shielding to RF energy commonly emitted by digital devices.

WHEN PROGRAMMING EMERGENCY NUMBERS AND(OR) MAKING TEST CALLS TO EMERGENCY NUMBERS:

- 1) Remain on the line and briefly explain to the dispatcher the reason for the call.
- 2) Perform such activities in the off-peak hours, such as early morning or late evenings.

This device complies with Part 15 of the FCC Rules. Operation is subject to the following two conditions:

(1) This device may not cause harmful interference, and (2) this device must accept any interference received, including interference that may cause undesired operation.

Privacy of communications may not be ensured when using this phone.

CAUTION:

Any changes or modifications not expressly approved by the party responsible for compliance could void the user's authority to operate this device.

NOTE:

This equipment has been tested and found to comply with the limits for a Class B digital device, pursuant to Part 15 of the FCC Rules. These limits are designed to provide reasonable protection against harmful interference in a residential installation. This equipment generates, uses, and can radiate radio frequency energy and, if not installed and used in accordance with the instructions, may cause harmful interference to radio communications. However, there is no guarantee that interference will not occur in a particular installation. If this equipment does cause harmful interference to radio or television reception, which can be determined by turning the equipment off and on, the user is encouraged to try to correct the interference by one or more of the following measures:

- Reorient or relocate the receiving antenna.
- Increase the separation between the equipment and receiver.
- Connect the equipment into an outlet on a circuit different from that to which the receiver is connected.
- Consult the dealer or an experienced radio/TV technician for help.

Some cordless telephones operate at frequencies that may cause interference to nearby TVs and VCRs. To minimize or prevent such interference, the base of the cordless telephone should not be placed near or on top of a TV or VCR. If

Useful Information

interference is experienced, move the cordless telephone further away from the TV or VCR. This will often reduce, or eliminate, interference.

FCC RF Exposure Warning:

- This product complies with FCC radiation exposure limits set forth for an uncontrolled environment.
- To comply with FCC RF exposure requirements, the base unit must be installed and operated 20 cm (8 inches) or more between the product and all person's body (excluding extremities of hands, wrist and feet).
- This product may not be collocated or operated in conjunction with any other antenna or transmitter.
- For body-worn operation, the handset must be used only with a non-metallic accessory. Use of other accessories may not ensure compliance with FCC RF exposure requirements.

Notice

- FCC ID can be found inside the battery compartment or on the bottom of the units.

Notice

- This product is designed for use in the United States of America. Sale or use of this product in other countries may violate local laws.
- Cet appareil est conçu pour être utilisé aux États-Unis d'Amérique. La vente ou l'emploi de cet appareil dans certains autres pays peut constituer une infraction à la législation locale.
- Este producto está diseñado para usarse en los Estados Unidos de América. La venta o el empleo de este producto en ciertos países puede constituir violación de la legislación local.
- 本產品專為美國使用而設。若在其他國家銷售或使用，可能會違反當地法例。
- この製品は、日本国外での使用を目的として設計されており、日本国内での使用は法律違反となります。従って、当社では日本国内においては原則として修理などのサービスは致しかねます。

ENERGY STAR

As an ENERGY STAR® Participant, Panasonic has determined that this product meets the ENERGY STAR guidelines for energy efficiency.

ENERGY STAR is a U.S. registered mark.



Useful Information**Specifications****General**

| | |
|------------------------------|-------------------------------|
| Operating environment | 5 °C – 40 °C (41 °F – 104 °F) |
| Frequency | 5.76 GHz – 5.84 GHz |

Base unit

| | |
|------------------------------|--|
| Dimensions | Approx. height 53 mm × width 144 mm × depth 107 mm (2 ³ / ₃₂ inches × 5 ²¹ / ₃₂ inches × 4 ⁷ / ₃₂ inches) |
| Mass (Weight) | Approx. 190 g (0.42 lb.) |
| Power consumption | Standby: Approx. 1.1 W Maximum: Approx. 3.7 W |
| RF Transmission power | 200 mW (max.) |
| Power supply | AC adaptor (120 V AC, 60 Hz) |

Handset

| | |
|------------------------------|---|
| Dimensions | Approx. height 156 mm × width 48 mm × depth 32 mm (6 ¹ / ₈ inches × 1 ⁷ / ₈ inches × 1 ¹ / ₄ inches) |
| Mass (Weight) | Approx. 130 g (0.29 lb.) |
| RF Transmission power | 200 mW (max.) |
| Power supply | AAA (R03) Ni-MH battery (2 × 1.2 V, 630 mAh) |

Charger (KX-TG4322/KX-TG4323/KX-TG4324)

| | |
|--------------------------|--|
| Dimensions | Approx. height 51 mm × width 75 mm × depth 88 mm (2 inches × 2 ¹⁵ / ₁₆ inches × 3 ¹⁵ / ₃₂ inches) |
| Mass (Weight) | Approx. 60 g (0.13 lb.) |
| Power consumption | Standby: Approx. 0.4 W Maximum: Approx. 3.4 W |
| Power supply | AC adaptor (120 V AC, 60 Hz) |

Note:

- Design and specifications are subject to change without notice.
- The illustrations in these instructions may vary slightly from the actual product.

Useful Information

Customer services

Customer Services Directory

Obtain Product Information and Operating Assistance; locate your nearest Dealer or Service Center; purchase Parts and Accessories; or make Customer Service and Literature requests by visiting our Web Site at:

<http://www.panasonic.com/help>

or, contact us via the web at:

<http://www.panasonic.com/contactinfo>

You may also contact us directly at: 1-800-211-PANA (1-800-211-7262),
Monday - Friday 9 am to 9 pm; Saturday - Sunday 10 am to 7 pm, EST.

TTY users (hearing or speech impaired users) can call 1-877-833-8855.

Accessory Purchases

Purchase Parts, Accessories and Instruction Books online for all Panasonic Products by visiting our Web Site at:

<http://www.pstc.panasonic.com>

or, send your request by E-mail to:

npcparts@us.panasonic.com

You may also contact us directly at:

1-800-332-5368 (Phone) 1-800-237-9080 (Fax Only)

(Monday - Friday 9 am to 9 pm, EST.)

Panasonic Service and Technology Company

20421 84th Avenue South, Kent, WA 98032

(We Accept Visa, MasterCard, Discover Card, American Express, and
Personal Checks.)

TTY users (hearing or speech impaired users) can call 1-866-605-1277.

Service in Puerto Rico

Panasonic Puerto Rico, Inc.

San Gabriel Industrial Park, Ave. 65 de Infantería, Km. 9.5,

Carolina, Puerto Rico 00985

Phone (787)750-4300, Fax (787)768-2910

Useful Information

Warranty

**PANASONIC CONSUMER
ELECTRONICS COMPANY, DIVISION
OF PANASONIC CORPORATION OF
NORTH AMERICA**
One Panasonic Way,
Secaucus, New Jersey 07094

PANASONIC PUERTO RICO, INC.
San Gabriel Industrial Park,
Ave. 65 de Infantería, Km. 9.5,
Carolina, Puerto Rico 00985

**Panasonic Telephone Products
Limited Warranty**

Limited Warranty Coverage

If your product does not work properly because of a defect in materials or workmanship, Panasonic Consumer Electronics Company or Panasonic Puerto Rico, Inc. (collectively referred to as "the warrantor") will, for the length of the period indicated on the chart below, which starts with the date of original purchase ("Limited Warranty period"), at its option either (a) repair your product with new or refurbished parts, or (b) replace it with a new or a refurbished product. The decision to repair or replace will be made by the warrantor.

| Parts | Labor |
|---------------------|---------------------|
| One (1) Year | One (1) Year |

During the "Labor" Limited Warranty period there will be no charge for labor. During the "Parts" Limited Warranty period, there will be no charge for parts. You must mail-in your product prepaid during the Limited Warranty period. This Limited Warranty excludes both parts and labor for batteries, antennas, and cosmetic parts (cabinet). This Limited Warranty only applies to products purchased and serviced in the United States or Puerto Rico. This Limited Warranty is extended only to the original purchaser and only covers products purchased as new.

Ship-In Service

For assistance in the continental U.S.A. in obtaining repairs please ship the product prepaid to:

**PSTC (Panasonic) Exchange Center,
4900 George McVay Drive, Suite B Door #12, McAllen, TX 78503**
panacare@us.panasonic.com

When shipping the unit carefully pack in a padded shipping carton, include all accessories, and send it prepaid. Include a letter detailing the complaint, a return address and provide a day time phone number where you can be reached. P.O. Boxes are not acceptable. Keep the tracking number for your records. A copy of valid registered receipt is required under the 1 year parts and labor Limited Warranty.

For Limited Warranty service for headsets if a headset is included with this product please follow instructions above.

For assistance in Puerto Rico call Panasonic Puerto Rico, Inc. (787)-750-4300 or fax (787)-768-2910.

For assistance, please visit <http://www.panasonic.com/help>

Useful Information

IF REPAIR IS NEEDED DURING THE LIMITED WARRANTY PERIOD THE PURCHASER WILL BE REQUIRED TO FURNISH A SALES RECEIPT/PROOF OF PURCHASE INDICATING DATE OF PURCHASE, AMOUNT PAID AND PLACE OF PURCHASE. CUSTOMER WILL BE CHARGED FOR THE REPAIR OF ANY UNIT RECEIVED WITHOUT SUCH PROOF OF PURCHASE.

Limited Warranty Limits And Exclusions

This Limited Warranty ONLY COVERS failures due to defects in materials or workmanship, and DOES NOT COVER normal wear and tear or cosmetic damage. The Limited Warranty ALSO DOES NOT COVER damages which occurred in shipment, or failures which are caused by products not supplied by the warrantor, or failures which result from accidents, misuse, abuse, neglect, bug infestation, mishandling, misapplication, alteration, faulty installation, set-up adjustments, misadjustment of consumer controls, improper maintenance, power line surge, lightning damage, modification, introduction of sand, humidity or liquids, commercial use such as hotel, office, restaurant, or other business or rental use of the product, or service by anyone other than a Factory Service Center or other Authorized Servicer, or damage that is attributable to acts of God.

THERE ARE NO EXPRESS WARRANTIES EXCEPT AS LISTED UNDER "LIMITED WARRANTY COVERAGE". THE WARRANTOR IS NOT LIABLE FOR INCIDENTAL OR CONSEQUENTIAL DAMAGES RESULTING FROM THE USE OF THIS PRODUCT, OR ARISING OUT OF ANY BREACH OF THIS LIMITED WARRANTY. (As examples, this excludes damages for lost time, lost calls or messages, cost of having someone remove or re-install an installed unit if applicable, travel to and from the servicer. The items listed are not exclusive, but are for illustration only.) **ALL EXPRESS AND IMPLIED WARRANTIES, INCLUDING THE WARRANTY OF MERCHANTABILITY, ARE LIMITED TO THE PERIOD OF THE LIMITED WARRANTY.**

Some states do not allow the exclusion or limitation of incidental or consequential damages, or limitations on how long an implied warranty lasts, so the exclusions may not apply to you.

This Limited Warranty gives you specific legal rights and you may also have other rights which vary from state to state. If a problem with this product develops during or after the Limited Warranty period, you may contact your dealer or Service Center. If the problem is not handled to your satisfaction, then write to the warrantor's Consumer Affairs Department at the addresses listed for the warrantor.

PARTS AND SERVICE, WHICH ARE NOT COVERED BY THIS LIMITED WARRANTY, ARE YOUR RESPONSIBILITY.

Index

- A** Additional handset: 26
 Alarm: 25
 Answering calls: 15
 Answering system
 Call screening: 30
 Erasing messages: 31, 32, 34
 Greeting only: 35
 Listening to messages: 31, 32, 33
 Number of rings: 34
 Recording time: 35
 Remote access code: 33
 Remote operation: 33
 Ring count: 34
 Toll saver: 34
 Turning on/off: 30, 32, 34
 Auto talk: 15
- B** Battery: 11, 12
 Booster (Clarity booster): 17
- C** Caller ID number auto edit: 28
 Caller ID service: 27
 Caller list: 27
 Caller list edit: 28
 Call share: 17
 Call waiting: 16
 Call Waiting Caller ID: 16
 Chain dial: 19
 CID (Caller ID): 27
 Conference calls: 38
 Customer support: 26
- D** Date and time: 14
 Dialing mode: 14
 Direct commands: 22
 Display
 Contrast: 22
 Language: 14
- E** Error messages: 42
- F** Flash: 16, 23
- G** Greeting message: 30
- H** Handset
 Deregistration: 26
 Locator: 39
 Registration: 26
- Hold: 16
- I** Intercom: 38
- K** Key tone: 22
- L** Line mode: 23
- M** Making calls: 15
 Missed calls: 27
 Mute: 16
- N** Night mode: 25
- P** Pause: 15
 Phonebook: 18
 Power failure: 11
- R** Redialing: 15
 Ringer tone: 23
 Rotary/pulse service: 17
- S** SP-PHONE (Speakerphone): 15
- T** Time adjustment: 23
 Transferring calls: 38
 Troubleshooting: 43
 TTY: 5, 52
- V** VM (Voice mail): 36
 Voice guidance language: 14
 Voice mail: 34, 36
 Volume
 Receiver: 10, 15
 Ringer (Base unit): 16
 Ringer (Handset): 16, 23
 Speaker: 10, 15
- W** Wall mounting: 40

IMPORTANT!

If your product is not working properly. . .

- 1 Read this **Operating Instructions**
- 2 Visit our website: <http://www.panasonic.com/help>
 - FAQs and troubleshooting hints are available.
- 3 Contact us via the web at:
<http://www.panasonic.com/contactinfo>
- 4 Call us at: **1-800-211-PANA (1-800-211-7262)**
 - Monday - Friday 9:00am - 9:00pm (EST),
Saturday/Sunday 10:00am - 7:00pm (EST)

To order a replacement batteries, call **1-800-332-5368** or visit <http://www.panasonic.com/batterystore>

For your future reference

We recommend keeping a record of the following information to assist with any repair under warranty.

Serial No. _____ Date of purchase _____

(found on the bottom of the base unit)

Name and address of dealer _____

Attach your purchase receipt here.

Panasonic Consumer Electronics Company,
Division of Panasonic Corporation of North America
One Panasonic Way, Secaucus, New Jersey 07094

Panasonic Puerto Rico, Inc.
San Gabriel Industrial Park, Ave. 65 de Infantería, Km. 9.5, Carolina,
Puerto Rico 00985

Copyright:

This material is copyrighted by Panasonic Communications Co., Ltd., and may be reproduced for internal use only. All other reproduction, in whole or in part, is prohibited without the written consent of Panasonic Communications Co., Ltd.

© 2007 Panasonic Communications Co., Ltd. All Rights Reserved.



TG4321

PNQX1001YA CC1107PW1127