

# Panasonic<sup>®</sup>

## Operating Instructions

---

### Link-to-Cell Bluetooth Convergence Solution

Model No.     **KX-TGE262C**  
                  **KX-TGE263C**  
                  **KX-TG465CSK**

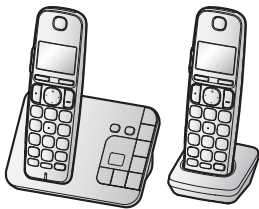

Model shown is KX-TGE262.

***Before initial use, see “Getting Started”  
on page 10.***

**Thank you for purchasing a Panasonic product.**

Please read these operating instructions before using the unit and save them for future reference.

For assistance, please visit our Support page:

**<http://panasonic.ca/english/support>**

## Table of Contents

<b>Introduction</b>		<b>Programming</b>	
Model composition .....	3	Menu list .....	36
Accessory information .....	3	Alarm .....	43
<b>Important Information</b>		Night mode .....	44
For your safety .....	6	Call block .....	45
Important safety instructions .....	7	Other programming .....	46
For best performance .....	7	Registering a unit .....	47
Other information .....	8	<b>Call Display Service</b>	
Specifications .....	9	Using Call Display service .....	48
<b>Getting Started</b>		Caller list .....	49
Setting up .....	10	<b>Using Bluetooth Devices</b>	
Controls .....	12	Copying phonebook from a cellular phone (phonebook transfer) .....	51
Display icons/Indicators .....	13	Text message (SMS) alert .....	52
Language settings .....	15	Using a Bluetooth wireless headset (optional) for landline calls .....	53
Date and time .....	15	<b>Answering System for Landline</b>	
Recording your greeting message .....	15	Answering system for landline .....	55
Other settings .....	15	Turning the answering system on/off .....	55
<b>Link to Cell</b>		Greeting message .....	55
Link to cell feature .....	17	Listening to messages .....	56
Pairing a cellular phone .....	17	Advanced new message alerting features .....	57
Link to cell settings .....	18	Remote operation .....	59
<b>Making/Answering Calls Using the Handset</b>		Answering system settings .....	60
Making cellular calls .....	21	<b>Useful Information</b>	
Making landline calls .....	21	Voice Mail service for landline .....	62
Answering calls .....	22	Wall mounting .....	63
Useful features during a call .....	22	Error messages .....	66
Power back-up operation for landline .....	25	Troubleshooting .....	67
<b>Making/Answering Calls Using the Base Unit</b>		Industry Canada Notices and other information .....	75
Making cellular calls .....	27	Warranty .....	76
Making landline calls .....	27	<b>Index</b>	
Answering calls .....	27	Index.....	77
Useful features during a call .....	28		
<b>Locator/Intercom</b>			
Handset locator .....	30		
Cell locator .....	30		
Intercom .....	30		
<b>Phonebook</b>			
Phonebook .....	32		
Speed dial .....	35		

## Model composition

### ■ KX-TGE260 series

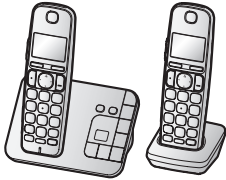

- Model shown is KX-TGE262.

### ■ KX-TG465SK series

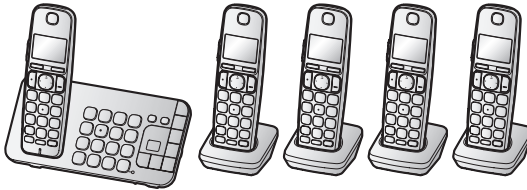

- Model shown is KX-TG465SK.

Series	Model No.	Base unit	Handset	Quantity
		Part No.	Part No.	
KX-TGE260 series	KX-TGE262	KX-TGE260	KX-TGEA20	2
	KX-TGE263	KX-TGE260	KX-TGEA20	3
KX-TG465SK series	KX-TG465SK	KX-TGE270	KX-TGEA20	5

## Accessory information

### Supplied accessories

No.	Accessory item/Part number	Quantity		
		KX-TGE262	KX-TGE263	KX-TG465SK
①	AC adaptor/PNLV226	1	1	1
②	Telephone line cord	1	1	1

## Introduction

No.	Accessory item/Part number	Quantity		
		KX-TGE262	KX-TGE263	KX-TG465SK
③	Wall mounting adaptor	1	1	1
④	Rechargeable batteries*1	4	6	10
⑤	Handset cover*2	2	3	5
⑥	Belt clip	2	3	5
⑦	Charger	1	2	4

\*1 See page 4 for replacement battery information.

\*2 The handset cover comes attached to the handset.

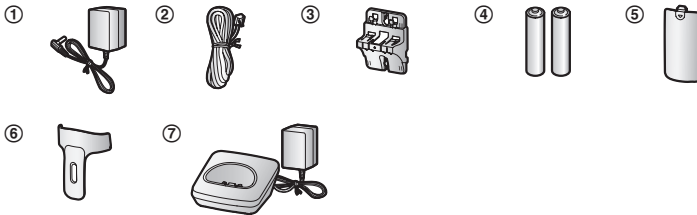

## Additional/replacement accessories

Please contact your nearest Panasonic dealer for sales information.

Accessory item	Order number
Rechargeable batteries	HHR-4DPA or HHR-4MYA*1 Battery type: – Nickel metal hydride (Ni-MH) – 2 x AAA (R03) size for each handset
Headset	KX-TCA400, KX-TCA430
Key detector	KX-TGA20*2

\*1 Replacement batteries may have a different capacity from that of the supplied batteries.

\*2 By registering the key detector (4 max.) to a Panasonic Digital Cordless Phone and attaching it to an easy-to-lose item in advance, you can locate and find the mislaid item to which the key detector is attached. Please visit our Web site:  
<http://panasonic.net/pcc/products/telephone/p/tga20/>

## Other information



- Design and specifications are subject to change without notice.
- The illustrations in these instructions may vary slightly from the actual product.

## Expanding your phone system

<b>Handset (optional): KX-TGEA20C</b>	
<p>You can expand your phone system by registering optional handsets (6 max.) to a single base unit.</p> <ul style="list-style-type: none"><li>• Optional handsets may be a different colour from that of the supplied handsets.</li></ul>	

## Bluetooth® devices

You can expand your phone system by pairing the following units to a single base unit.

<p><b>Your Bluetooth cellular phone</b>*1: 2 max. (for cellular calls: page 17)</p>	
<p><b>Your Bluetooth headset</b>*1: 1 max. (for a wireless hands-free conversation: page 53)</p>	

\*1 Your cellular phone and headset must be Bluetooth wireless technology compatible. For more details and the list of compatible cellular phones, please visit our Web site: <http://www.panasonic.ca/link2cell>

## Trademarks

- The Bluetooth® word mark and logos are registered trademarks owned by Bluetooth SIG, Inc., and any use of such marks by Panasonic Corporation is under licence.
- All other trademarks identified herein are the property of their respective owners.

## Important Information

### For your safety

To prevent severe injury and loss of life/property, read this section carefully before using the product to ensure proper and safe operation of your product.

#### **WARNING**

##### Power connection

- Use only the power source marked on the product.
- Do not overload power outlets and extension cords. This can result in the risk of fire or electric shock.
- Completely insert the AC adaptor/power plug into the power outlet. Failure to do so may cause electric shock and/or excessive heat resulting in a fire.
- Regularly remove any dust, etc. from the AC adaptor/power plug by pulling it from the power outlet, then wiping with a dry cloth. Accumulated dust may cause an insulation defect from moisture, etc. resulting in a fire.
- Unplug the product from power outlets if it emits smoke, an abnormal smell, or makes an unusual noise. These conditions can cause fire or electric shock. Confirm that smoke has stopped emitting and contact us by visiting our Support page: <http://panasonic.ca/english/support>
- Unplug from power outlets and never touch the inside of the product if its casing has been broken open.
- Never touch the plug with wet hands. Danger of electric shock exists.

##### Installation

- To prevent the risk of fire or electrical shock, do not expose the product to rain or any type of moisture.
- Do not place or use this product near automatically controlled devices such as automatic doors and fire alarms. Radio waves emitted from this product may cause such devices to malfunction resulting in an accident.

- Do not allow the AC adaptor or telephone line cord to be excessively pulled, bent or placed under heavy objects.

##### Operating safeguards

- Unplug the product from power outlets before cleaning. Do not use liquid or aerosol cleaners.
- Do not disassemble the product.
- Do not spill liquids (detergents, cleansers, etc.) onto the telephone line cord plug, or allow it to become wet at all. This may cause a fire. If the telephone line cord plug becomes wet, immediately pull it from the telephone wall jack, and do not use.

##### Medical

- Consult the manufacturer of any personal medical devices, such as pacemakers or hearing aids, to determine if they are adequately shielded from external RF (radio frequency) energy. (The product operates in the frequency range of 1.92 GHz to 1.93 GHz, and the RF transmission power is 115 mW (max.).)
- Do not use the product in health care facilities if any regulations posted in the area instruct you not to do so. Hospitals or health care facilities may be using equipment that could be sensitive to external RF energy.

#### **CAUTION**

##### Installation and location

- Never install telephone wiring during an electrical storm.
- Never install telephone line jacks in wet locations unless the jack is specifically designed for wet locations.
- Never touch uninsulated telephone wires or terminals unless the telephone line has been disconnected at the network interface.
- Use caution when installing or modifying telephone lines.
- The AC adaptor is used as the main disconnect device. Ensure that the AC outlet is installed near the product and is easily accessible.

## Important Information

- This product is unable to make calls when:
  - the handset batteries need recharging or have failed.
  - there is a power failure.

### Battery

- We recommend using the batteries noted on page 4. **USE ONLY rechargeable Ni-MH batteries AAA (R03) size.**
- Do not mix old and new batteries.
- Do not open or mutilate the batteries. Released electrolyte from the batteries is corrosive and may cause burns or injury to the eyes or skin. The electrolyte is toxic and may be harmful if swallowed.
- Exercise care when handling the batteries. Do not allow conductive materials such as rings, bracelets, or keys to touch the batteries, otherwise a short circuit may cause the batteries and/or the conductive material to overheat and cause burns.
- Charge the batteries provided with or identified for use with this product only, in accordance with the instructions and limitations specified in this manual.
- Only use a compatible base unit (or charger) to charge the batteries. Do not tamper with the base unit (or charger). Failure to follow these instructions may cause the batteries to swell or explode.

### Attention:



A nickel metal hydride battery that is recyclable powers the product you have purchased. Please call 1-800-8-BATTERY (1-800-822-8837) for information on how to recycle this battery.

## Important safety instructions

When using your product, basic safety precautions should always be followed to reduce the risk of fire, electric shock, and injury to persons, including the following:

1. Do not use this product near water for example, near a bathtub, washbowl, kitchen sink, or laundry tub, in a wet basement or near a swimming pool.
2. Avoid using a telephone (other than a cordless type) during an electrical storm. There may be a remote risk of electric shock from lightning.
3. Do not use the telephone to report a gas leak in the vicinity of the leak.
4. Use only the power cord and batteries indicated in this manual. Do not dispose of batteries in a fire. They may explode. Check with local codes for possible special disposal instructions.

### SAVE THESE INSTRUCTIONS

## For best performance

### Base unit location/avoiding noise

The base unit and other compatible Panasonic units use radio waves to communicate with each other.

- For maximum coverage and noise-free communications, place your base unit:
  - at a convenient, high, and central location with no obstructions between the handset and base unit in an indoor environment.
  - away from electronic appliances such as TVs, radios, personal computers, wireless devices, or other phones.
  - facing away from radio frequency transmitters, such as external antennas of mobile phone cell stations. (Avoid putting the base unit on a bay window or near a window.)
- Coverage and voice quality depends on the local environmental conditions.

## Important Information

- If the reception for a base unit location is not satisfactory, move the base unit to another location for better reception.

### Environment

- Keep the product away from electrical noise generating devices, such as fluorescent lamps and motors.
- The product should be kept free from excessive smoke, dust, high temperature, and vibration.
- The product should not be exposed to direct sunlight.
- Do not place heavy objects on top of the product.
- When you leave the product unused for a long period of time, unplug the product from the power outlet.
- The product should be kept away from heat sources such as heaters, kitchen stoves, etc. It should not be placed in rooms where the temperature is less than 0 °C (32 °F) or greater than 40 °C (104 °F). Damp basements should also be avoided.
- The maximum calling distance may be shortened when the product is used in the following places: Near obstacles such as hills, tunnels, underground, near metal objects such as wire fences, etc.
- Operating the product near electrical appliances may cause interference. Move away from the electrical appliances.

### Routine care

- **Wipe the outer surface of the product with a soft moist cloth.**
- Do not use benzine, thinner, or any abrasive powder.

### Other information

**CAUTION:** Risk of explosion if battery is replaced by an incorrect type. Dispose of used batteries according to the instructions.

### Notice for product disposal, transfer, or return

- This product can store your private/confidential information. To protect your privacy/confidentiality, we recommend that you erase information such as phonebook or caller list entries from the memory before you dispose of, transfer, or return the product.

### ENERGY STAR

As an ENERGY STAR® Partner, Panasonic has determined that this product meets the ENERGY STAR guidelines for energy efficiency. ENERGY STAR is a U.S. registered mark.



### Compliance with TIA-1083 standard

Telephone handsets identified with this logo have reduced noise and interference when used with T-Coil equipped hearing aids and cochlear implants.





## Specifications

- **Standard:**  
DECT 6.0 (Digital Enhanced Cordless  
Telecommunications 6.0)  
Bluetooth wireless technology 2.1
- **Frequency range:**  
1.92 GHz to 1.93 GHz (DECT)  
2.402 GHz to 2.48 GHz (Bluetooth)
- **RF transmission power:**  
115 mW (max.)
- **Power source:**  
120 V AC, 60 Hz
- **Power consumption:**  
**Base unit:**  
Standby: Approx. 1.2 W  
Maximum: Approx. 4.5 W  
**Charger:**  
Standby: Approx. 0.1 W  
Maximum: Approx. 1.8 W
- **Operating conditions:**  
0 °C – 40 °C (32 °F – 104 °F), 20 % – 80 %  
relative air humidity (dry)

## Getting Started

### Setting up

#### Connections

- If you do not connect the telephone line cord and use only cellular lines, set the cellular line only mode to use this unit more conveniently (page 19).

#### ■ Base unit

- ① Connect the AC adaptor to the unit by pressing the plug firmly.
- ② Fasten the cord by hooking it.
- ③ Connect the AC adaptor to the power outlet.
- ④ Connect the telephone line cord to the unit, then to the single-line telephone jack (RJ11C) until you hear a click.
- ⑤ A DSL/ADSL filter (not supplied) is required if you have a DSL/ADSL service.

#### Note:

- Use only the supplied Panasonic AC adaptor PNLV226.

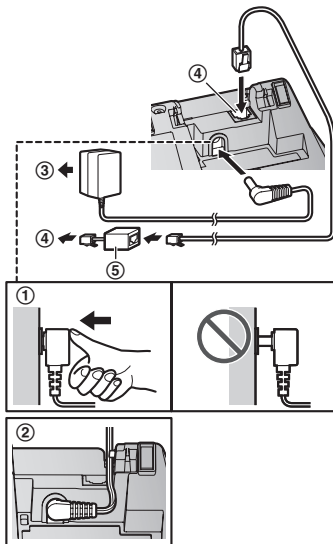

#### ■ Charger

- ① Connect the AC adaptor to the power outlet.

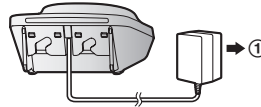

#### Battery installation

- USE ONLY rechargeable Ni-MH batteries AAA (R03) size (A).
- Do NOT use Alkaline/Manganese/Ni-Cd batteries.
- Confirm correct polarities (+, -).

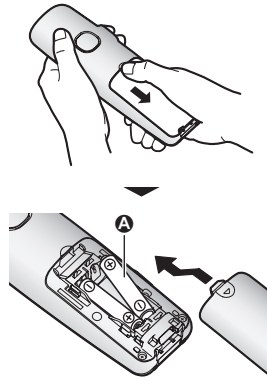

- Follow the directions on the display to set up the unit.

## Battery charging

Charge for about 7 hours.

- Confirm “Charging” is displayed (A).
- When the batteries are fully charged, “Fully charged” is displayed.

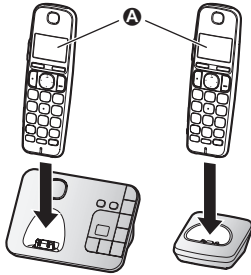

## Note when setting up

### Note for connections

- The AC adaptor must remain connected at all times. (It is normal for the adaptor to feel warm during use.)
- The AC adaptor should be connected to a vertically oriented or floor-mounted AC outlet. Do not connect the AC adaptor to a ceiling-mounted AC outlet, as the weight of the adaptor may cause it to become disconnected.

### Note for battery installation

- Use the supplied rechargeable batteries. For replacement, we recommend using the Panasonic rechargeable batteries noted on page 4, 7.

### Note for battery charging

- It is normal for the handset to feel warm during charging.
- Clean the charge contacts of the handset, base unit, and charger with a soft and dry cloth once a month. Before cleaning the unit, disconnect from power outlets and any telephone line cords. Clean more often if the unit is exposed to grease, dust, or high humidity.

## Battery level

Icon	Battery level
	High
	Medium
	Low
	Needs charging.
	Empty

## Panasonic Ni-MH battery performance (supplied batteries)

Operation	Operating time
In continuous use	10 hours max.*1
Not in use (standby)	8 days max.*1

\*1 If eco mode is on.

### Note:

- Actual battery performance depends on usage and ambient environment.

## Intelligent eco mode

This feature automatically reduces handset power consumption by suppressing handset transmission power when the handset is close to the base unit.

- When this feature is activated, **ECO** is displayed. However, during a cellular call, **ECO** is not displayed even though this feature is activated.
- Eco mode is turned off when the clarity booster is activated (page 23).

## Getting Started

### Controls

#### Handset

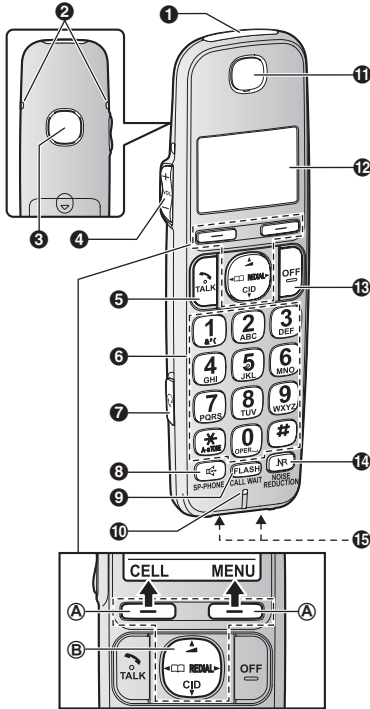

- 1 Ringer indicator
- 2 Belt clip hole
- 3 Speaker
- 4 [ + ]/[ - ] (VOL.: Volume up/down)
- 5 [ TALK ]
- 6 Dial keypad (TONE)
- 7 Headset jack
- 8 [ SP-PHONE: Speakerphone ]
- 9 [ FLASH ][ CALL WAIT ]
- 10 Microphone
- 11 Receiver
- 12 Display

- 13 [ OFF ]
- 14 [ NR ] (NOISE REDUCTION/Smart function key)
- NR indicator
- 15 Charge contacts

#### Control type

##### A Soft keys

By pressing a soft key, you can select the feature shown directly above it on the display. After a cellular phone is paired, [CELL] is displayed.

##### B Navigator key

- [▲], [▼], [◀], or [▶]: Scroll through various lists and items.
- [◀] (Volume: [▲] or [▼]): Adjust the receiver or speaker volume while talking.
- [◀] □: View the phonebook entry.
- [▶] REDIAL: View the redial list.
- [▼] CID (Call Display): View the caller list.

### Base unit

#### ■ KX-TGE260 series: page 3

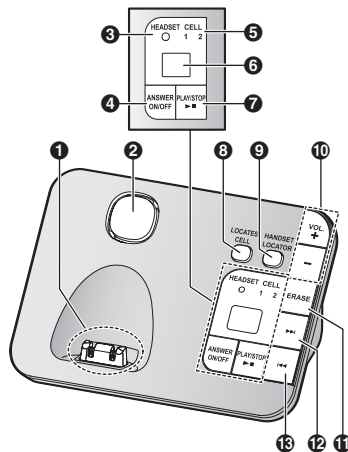

- 1 Charge contacts
- 2 Speaker
- 3 HEADSET indicator
- 4 [ ANSWER ON/OFF ]
- 5 CELL 1 indicator

- 6 CELL 2 indicator
- 6 Message counter
- 7 [▶■] (PLAY/STOP)
- 7 Message indicator
- 8 [LOCATES CELL]
- 9 [HANDSET LOCATOR]
- 10 [⊕]/[⊖] (VOL.: Volume up/down)
- 11 [ERASE]
- 12 [▶▶] (Skip)
- 13 [◀◀] (Repeat)

### ■ KX-TG465SK series: page 3

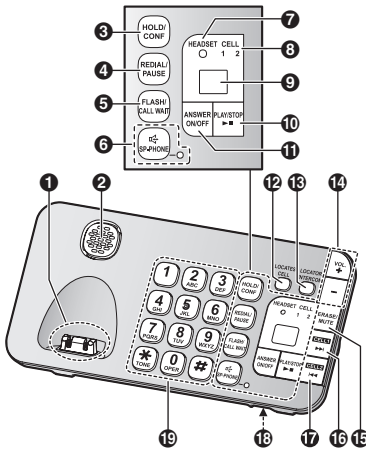

- 1 Charge contacts
- 2 Speaker
- 3 [HOLD] [CONF]
- 4 [REDIAL] [PAUSE]
- 5 [FLASH] [CALL WAIT]
- 6 [☎] (SP-PHONE: Speakerphone)
- 6 SP-PHONE indicator
- 7 HEADSET indicator
- 8 CELL 1 indicator
- 8 CELL 2 indicator
- 9 Message counter
- 10 [▶■] (PLAY/STOP)
- 9 Message indicator
- 11 [ANSWER ON/OFF]
- 12 [LOCATES CELL]
- 13 [LOCATOR] [INTERCOM]
- 14 [⊕]/[⊖] (VOL.: Volume up/down)
- 15 [ERASE] [MUTE]







- 16 [CELL 1] [▶▶] (Skip)
- 17 [CELL 2] [◀◀] (Repeat)
- 18 Microphone
- 19 Dial keypad [TONE: TONE]

## Display icons/Indicators

### Handset display items

Item	Meaning
	Within base unit range
	Out of base unit range
	The landline is in use. <ul style="list-style-type: none"> <li>• When flashing: The call is put on hold.</li> <li>• When flashing rapidly: An incoming call is now being received.</li> </ul>
	A cellular line is in use.*1 <ul style="list-style-type: none"> <li>• When flashing: The cellular call is put on hold.</li> <li>• When flashing rapidly: A cellular call is being received.</li> </ul>
	A cellular phone is connected.*1 Ready to make/receive cellular calls. <ul style="list-style-type: none"> <li>• When turned off: A cellular phone is not connected to the base unit. (page 19)</li> </ul>
	– A cellular call is being done on that line. – The cellular line is selected for the setting.
	Eco mode is on.*2 (page 11)
	Noise reduction is set. (page 23)
	Equalizer is set. (page 23)
	Speakerphone is on. (page 21)
	Ringer volume is off.*3 (page 38, 40)

## Getting Started

Item	Meaning
	Night mode is on. (page 44)
	Privacy mode is on. (page 42)
	Alarm is on. (page 43)
	Handset number
	Battery level
	Blocked call (page 45)
	Clarity booster is on.*2 (page 23)
In use	Answering system is being used by another handset or the base unit.
Cell1 in use	Someone is using the corresponding line.
Cell2 in use	
Cl&C2 in use	
Line in use	

- \*1 Corresponding cellular line(s) is(are) indicated next to the item.
- \*2 During a cellular call, the item is not displayed even though the feature is activated.
- \*3 Corresponding lines (1, 2: cellular line, L: landline) are indicated next to the item. If all lines are turned off, no line is indicated.

### Base unit display item

Item	Meaning
	"Greeting only" is selected. Caller messages are not recorded. (page 60)

### CELL indicators on the base unit

The CELL indicators show each cellular line status.

Status	Meaning
On	A cellular phone is connected. Ready to make/receive cellular calls.
Flashing	<ul style="list-style-type: none"> <li>– The cellular line is in use.</li> <li>– Phonebook entries are being copied from a cellular phone (page 51).</li> <li>– The base unit is searching for the paired cellular phone.</li> <li>– The base unit is pairing a cellular phone.</li> <li>– A cellular call is put on hold.</li> </ul>
Flashing rapidly	A cellular call is being received.
Light off	<ul style="list-style-type: none"> <li>– A cellular phone is not paired to the base unit.</li> <li>– A cellular phone is not connected to the base unit (page 19).</li> </ul>

### Bluetooth HEADSET indicator on the base unit

The HEADSET indicator shows the Bluetooth headset status.

Status	Meaning
On	A Bluetooth headset is connected to the base unit. Ready to use it.
Flashing	<ul style="list-style-type: none"> <li>– A Bluetooth headset is in use.</li> <li>– The base unit is searching for the paired Bluetooth headset.</li> <li>– The base unit is pairing a headset.</li> <li>– Mute is turned on.</li> </ul>
Flashing rapidly	A landline call is being received.
Light off	<ul style="list-style-type: none"> <li>– The Bluetooth headset is not connected to the base unit.</li> <li>– A Bluetooth headset is not paired to the base unit.</li> </ul>

## Language settings

### Display language

You can select either “English” or “Français” as the display language. The default setting is “English”.

- 1 **[MENU]#110**
- 2 **[↕]**: Select the desired setting. → **[SAVE]**
- 3 **[OFF]**

### Voice guidance language

You can select either “English” or “Français” as the voice guidance language of the Talking Call Display and answering system. The default setting is “English”.

- 1 **[MENU]#112**
- 2 **[↕]**: Select the desired setting.
- 3 **[SAVE] → [OFF]**

## Date and time

- 1 **[MENU]#101**
- 2 Enter the current month, date, and year by selecting 2 digits for each.  
**Example:** July 15, 2014  
**07 15 14**
- 3 **[OK]**
- 4 Enter the current hour and minute (12-hour clock format) by selecting 2 digits for each.  
**Example:** 9:30  
**09 30**
- 5 **[X]**: Select “AM” or “PM”.
- 6 **[SAVE] → [OFF]**

#### Note:

- When English is selected as the display language, 12-hour clock format is used. When French is selected, 24-hour clock format is used.

## Recording your greeting message

You can record your own greeting message instead of using a pre-recorded greeting message. See page 55 for details.

- 1 **[MENU]#302**
- 2 **[↕]**: “Yes” → **[SELECT]**
- 3 Record a greeting message. → **[STOP] → [OFF]**

## Other settings

### Smart function key (NR key)

The Smart function key (NR key) is located on the bottom of the handset and informs you with its flashing to allow you to activate the following features by simply pressing this key.

- **When the NR indicator flashes rapidly, you can:**
    - Answer the call (outside call, intercom). (page 22, 31)
    - Stop paging. (page 30)
    - Stop the alarm sound. (page 44)
  - **When the NR indicator flashes slowly in standby mode, you can:**
    - Listen to new messages. (page 56)
    - Listen to new Voice Mail messages. (page 63)
    - View the caller list when there are missed calls. (page 50)
- To activate these features, their Smart function key must be “On”. (page 16)

### Using the Smart function key (NR key)

When the NR indicator flashes rapidly/slowly, press **[NR]**.

- The above features can be activated depending the situation.
- If you answer a call using the Smart function key, the speakerphone is activated.
- Even if the handset is placed on the base unit or charger, the feature can be

## Getting Started

activated. You can talk or listen to new messages without lifting up the handset. If you want to perform further operations, lift up the handset.

- When the unit has new messages, new Voice Mail messages, and missed calls, the unit can be operated to play the new messages first, play the new Voice Mail messages next, and then show the missed calls.

### Setting the Smart function key

The Smart function key for the following features must be "On".

- "New message" (Default: On)
- "New VM" (Default: On)
- "Missed Call" (Default: Off)

The settings can be set for each handset.

- 1 **[MENU]#|2|7|8**
- 2 **[↕]**: Select the desired setting and press **[SELECT]**.
  - "✓" is displayed next to the selected features.
  - To cancel a selected feature, press **[SELECT]** again. "✓" disappears.
- 3 **[SAVE] → [OFF]**

#### Note:

- If the **NR** indicator flashes when the handset is not placed on the base unit or charger, battery consumption is faster than usual.

### Dialing mode

If you cannot make calls, change this setting according to your telephone line service. The default setting is "Tone".

"Tone": For tone dial service.

"Pulse": For rotary/pulse dial service.

- 1 **[MENU]#|1|2|0**
- 2 **[↕]**: Select the desired setting.
- 3 **[SAVE] → [OFF]**



## Link to cell feature

You can connect your base unit and cellular phone using Bluetooth wireless technology, so that you can make or answer cellular calls using your phone system. This allows you to:

- use the unit to talk on cellular calls even if some areas of your home have poor cellular reception, simply by placing your cellular phone in an area with good reception.
- talk on cellular calls even if your cellular phone is in your pocket or bag.
- enjoy cordless cellular calls even if your cellular phone plugged in and charging.

### Important:

- Your cellular phone must support the Hands Free Profile (HFP) specification.
- You may pair 2 cellular phones and 1 headset.
- The unit can be used to talk on 2 lines at the same time (for example, 2 cellular lines, or the landline and 1 cellular line).
- Only 2 Bluetooth devices can be used with the unit at the same time (for example, 2 cellular lines, or the headset and 1 cellular line).
- Locate your cellular phone near the base unit. If the cellular phone is too close to the base unit during a cellular call, you may hear noise. For best performance, we recommend placing the cellular phone between 0.6 m to 3 m (2 feet to 10 feet) away from the base unit.

## Pairing a cellular phone

### Important:

- For more details and the list of compatible cellular phones, please visit our Web site: <http://www.panasonic.ca/link2cell>
- Before pairing a Bluetooth enabled cellular phone to the base unit, make sure that no other Bluetooth device such as a Bluetooth headset is connected to your cellular phone.

### 1 Handset:

For CELL 1: **[MENU]#6241**  
 For CELL 2: **[MENU]#6242**

- After the corresponding CELL indicator on the base unit starts flashing, the rest of the procedure must be completed within 5 minutes.

### 2 Your cellular phone:

While the corresponding CELL indicator is flashing, follow the instructions of your cellular phone to enter the pairing mode.

- Depending on your cellular phone, it may ask you to enter the Bluetooth PIN (default: "0000"). If your cellular phone shows PassKey confirmation on its display, follow the directions to proceed.

### 3 Handset:

Wait until a long beep sounds.

- It may take more than 10 seconds to complete pairing.
- When the corresponding CELL indicator lights up, the cellular phone is connected to the base unit. You are ready to make cellular calls.

### 4 [OFF]

#### Note:

- Make sure that your cellular phone is set to connect to this product automatically. Refer to your cellular phone's operating instructions.
- Make sure you cancel your cellular phone's current pairing if you want to pair it to the other line (page 17).
- The default setting for the text message alert feature is "On (no announce)", so when you pair your cellular phone to the base unit, this feature may be activated (page 52). (This depends on the version and type of cellular phone you are using.)

## Unpairing a cellular phone

You can cancel the pairing of a cellular phone that is stored in the base unit.

1 For CELL 1: **[MENU]#61111**  
 For CELL 2: **[MENU]#61112**

### 2 [↕]: "Yes" → [SELECT]

- When the cellular phone is unpaired, the CELL indicator is turned off.

### 3 [OFF]

## Link to Cell

### Link to cell settings

#### Selecting which unit receives cellular calls

You can select which unit rings and receives calls for a cellular line. When “**all**” is selected, all handsets and the base unit ring.

- 1 For CELL 1: **[MENU]#6271**  
For CELL 2: **[MENU]#6272**
- 2 **[↕]**: Select the desired handset or “**all**”.  
→ **[SAVE]**
- 3 **[OFF]**

#### Note:

- When you select a specific handset to receive calls for a cellular line:
  - other handsets cannot answer the calls.
  - the base unit can answer the calls even though it does not ring. However, you can make the base unit ring by adjusting the base unit ringer volume (page 38). (KX-TG465SK series: page 3)
- When you change the setting to “**all**”, the base unit ringer volume also returns to the lowest level even if the ringer volume has been changed.
- The units selected with this setting have the text message alert feature (page 52) applied to them.

#### Ring as cell mode

Once this feature is turned on, the handset and base unit ring using the same ringer tone as your cellular phone.

The following settings are available:

- “**off**”: Turn this feature off to use the ringer tones of the handset and base unit. Caller information is announced depending on the Talking Call Display setting (page 40).
- “**On (with Talking CID)**” (default): The handset and base unit use your cellular phone’s ringer tone. Caller information is announced even if the Talking Call Display is turned off.
- “**On (without Talking CID)**”: The handset and base unit use your cellular

phone’s ringer tone. Caller information is not announced even if the Talking Call Display is turned on.

#### Important:

- To use this feature, your cellular phone must support Bluetooth in-band ringtone. Refer to your cellular phone’s operating instructions.

- 1 For CELL 1: **[MENU]#6141**  
For CELL 2: **[MENU]#6142**
- 2 **[↕]**: Select the desired setting.
- 3 **[SAVE]** → **[OFF]**

#### Note:

- The units use the preset ringer tones (page 40) instead of your cellular phone’s ringer tone when a cellular call is being received if:
  - your cellular phone is in night mode (depending on your cellular phone).
  - the base unit is in use.
  - 2 handsets are sharing a landline call.
- If your cellular phone is in night mode with “**On (with Talking CID)**” set, the unit announces caller information even when Talking Call Display is turned off (page 40).

#### To use the handset ringer tone instead of your cellular phone’s ringer tone

Select “**off**” in step 2, “Ring as cell mode”, page 18.

To change the handset ringer tone for a cellular line, see page 38.

#### Auto connection to the Bluetooth devices (cellular phones or headset)

After pairing, your Bluetooth devices are connected to the base unit. If you move the Bluetooth devices out of base unit range, the Bluetooth devices are disconnected from the base unit. This feature allows the base unit to try to reconnect the Bluetooth devices at regular intervals when it returns within base

unit range. You can set the interval. The default setting is "1 min".

**Important:**

- When 3 Bluetooth devices (2 cellular phones and 1 headset) are paired to the base unit, only 2 Bluetooth devices can be used with the unit at the same time, and the base unit loses its connection from other Bluetooth devices. To automatically resume the connection to Bluetooth devices, leave the auto connection on.
- Some cellular phones lose connection after usage, please check the specifications of your cellular phone for more details.

1 [MENU]#632

2 [↕]: Select the desired setting.

3 [SAVE] → [OFF]

**Note:**

- Some cellular phones may ask you if you accept the connection requirement from the base unit. In that case, select "OFF" in step 2. Check the specifications of your cellular phone.

**Connecting/disconnecting the cellular phone manually**

If you will not be using the paired cellular phone's link to cell feature temporarily (for example, you do not want the unit to ring when your cellular line receives a call), you can disconnect your cellular phone from the base unit. If you want to use it again, reconnect the cellular phone to the base unit.

**Note:**

- Even if a paired cellular phone was disconnected from the base unit, if it is brought within the base unit's range during the auto connection interval, it may automatically connect to the base unit (page 18).
- A disconnected cellular phone is not unpaired from the base unit, so pairing it to the base unit again is unnecessary.

1 **To connect/disconnect:**

For CELL 1: [MENU]#6251

For CELL 2: [MENU]#6252

- A long beep sounds.

2 [OFF]

**Cellular line only mode (If you do not use the landline)**

If you do not use the landline, we recommend setting the unit to the cellular line only mode.

**Important:**

- If you turn on the "Cell line only mode", disconnect the telephone line cord from the base unit. Otherwise the "Cell line only mode" cannot be activated.

1 [MENU]#157

2 **To turn on:**

[↕]: "On" → [SELECT] →

[↕]: "Yes" → [SELECT]

**To turn off:**

[↕]: "Off" → [SELECT]

**Note:**

- Once you set this mode, you can use the following buttons to make cellular calls:
  - for the handset, press [📞] or [📞]
  - instead of [CELL] (page 21).
  - for the base unit, press [📞] instead of the line button ([CELL 1] or [CELL 2]) set for the cellular line selection (page 20, 27). (KX-TG465SK series: page 3)
- Once you set this mode, the following features cannot be used:
  - Landline features (page 43)
  - Answering system (page 55)  
Messages cannot be received.
  - Voice Mail features (page 62)
- After this mode is turned on or off, the base unit reboots.
  - Bluetooth connections from cellular phones or headset are disconnected. If the auto connection is turned on (page 18), the cellular phones are reconnected.
  - 📞 will be displayed on the handset momentarily. The handset can be used once 📞 is displayed.

## Link to Cell

### When you use the landline again

Before connecting the telephone line to the base unit, select "OFF" in step 2, "Cellular line only mode (If you do not use the landline)", page 19.

### Cellular line selection

This feature determines which cellular line is selected to make cellular calls when:

- you press **[CELL]** on the handset.
- you press **[↶]** or **[↷]** on the handset while the cellular line only mode is turned on.
- you press **[↷]** on the base unit while the cellular line only mode is turned on. (KX-TG465SK series: page 3)

The following settings are available:

- "Manual" (handset only: default): You can select the desired cellular line when making a call.
- "Cellphone 1"<sup>\*1</sup>: (base unit default): CELL 1 is selected.
- "Cellphone 2"<sup>\*1</sup>: CELL 2 is selected.

**1** For handset: **[MENU]#634**  
For base unit<sup>2</sup>: **[MENU]#\*634**

**2** **[↕]**: Select the desired setting.

**3** **[SAVE] → [OFF]**

<sup>\*1</sup> After the Bluetooth device is paired, the device name is displayed.

<sup>\*2</sup> KX-TG465SK series: page 3

### Storing your area code (for dialing only a 7-digit phone number to make a local call)

You need to add your area code when making cellular calls to a phone number in your area. Once you store your area code, it is automatically added to the beginning of the 7-digit phone number when making cellular calls.

**1** **[MENU]#633**

**2** Enter the 3-digit area code.  
• To correct a digit, press **[CLEAR]**.

**3** **[SAVE] → [OFF]**

### Changing the Bluetooth PIN (Personal Identification Number)

The PIN is used to pair cellular phones to the base unit. The default PIN is "0000". To prevent unauthorized access to this product, we recommend that you change the PIN, and keep it confidential.

#### Important:

- Please make note of your new PIN. The unit does not reveal the PIN to you. If you forget your PIN, see page 73.

**1** **[MENU]#619**

- If the unit prompts you to enter the old PIN (when the default has been changed), enter the current 4-digit PIN.

**2** Enter the new 4-digit PIN. → **[OK]**

**3** Enter the new 4-digit PIN again. → **[SAVE]**

**4** **[OFF]**

## Making/Answering Calls Using the Handset

### Making cellular calls

#### Important:

- The unit can be used to talk on 2 lines at the same time (for example, 2 cellular lines, or the landline and 1 cellular line).
- Only 2 Bluetooth devices can be used with the unit at the same time (for example, 2 cellular lines, or the headset and 1 cellular line).
- Before making calls, confirm that the corresponding CELL indicator on the base unit lights up (page 14).

- 1 Lift the handset and dial the phone number.
  - To correct a digit, press [CLEAR].
- 2 [CELL]
  - The unit starts dialing when:
    - only 1 cellular phone is paired.
    - a specific line is set to make cellular calls (page 20).
  - Go to step 4.
- 3 [↕]: Select the desired cellular phone. → [SELECT]
- 4 When you finish talking, press [OFF] or place the handset on the base unit or charger.

#### Note:

- To switch to the speaker, press [📞].  
To switch back to the receiver, press [📞]/ [📞].

### Adjusting the receiver or speaker volume

Press [+] or [-] repeatedly while talking.

### Making a cellular call using the redial list

The last 5 phone numbers dialed are stored in the redial list (each 48 digits max.).

- 1 [▶] REDIAL
- 2 [↕]: Select the desired phone number.
- 3 [CELL]
  - The unit starts dialing when:
    - only 1 cellular phone is paired.

- a specific line is set to make cellular calls (page 20).

- 4 [↕]: Select the desired cellular phone. → [SELECT]

### Erasing a number in the redial list

#### ■ When a cellular phone is paired:

- 1 [▶] REDIAL
- 2 [↕]: Select the desired phone number. → [MENU]
- 3 [↕]: "Erase" → [SELECT]
- 4 [↕]: "Yes" → [SELECT]
- 5 [OFF]

#### ■ When a cellular phone is not paired:

- 1 [▶] REDIAL
- 2 [↕]: Select the desired phone number. → [ERASE]
- 3 [↕]: "Yes" → [SELECT]
- 4 [OFF]

### Making landline calls

- 1 Lift the handset and dial the phone number.
  - To correct a digit, press [CLEAR].
- 2 [📞]
- 3 When you finish talking, press [OFF] or place the handset on the base unit or charger.

### Using the speakerphone

- 1 Dial the phone number and press [📞].
- 2 When you finish talking, press [OFF].

#### Note:

- To switch back to the receiver, press [📞]/ [📞].

### Making a call using the redial list

The last 5 phone numbers dialed are stored in the redial list (each 48 digits max.).

- 1 [▶] REDIAL

## Making/Answering Calls Using the Handset

- 2 **[↕]**: Select the desired phone number.
- 3 **[↶]**

### Pause (for PBX/long distance service users)

A pause is sometimes required when making calls using a PBX or long distance service. When storing a calling card access number and/or PIN in the phonebook, a pause is also needed (page 34).

**Example:** If you need to dial the line access number "9" when making outside calls with a PBX:

- 1 **[9]** → **[▲]** (Pause)
- 2 Dial the phone number. → **[↶]**

#### Note:

- A 3.5 second pause is inserted each time **[▲]** (Pause) is pressed.

## Answering calls

When a call is being received, the ringer indicator and **NR** indicator flash rapidly.

- 1 Lift the handset and press **[↶]** or **[↷]** when the unit rings.
  - To answer a cellular call, you can also press **[CELL]**.
- 2 When you finish talking, press **[OFF]** or place the handset on the base unit or charger.

**Any key answer:** You can answer the call by pressing any dial key.

**Auto talk:** You can answer calls simply by lifting the handset (page 41).

**Temporary handset ringer off:** You can turn the ringer off temporarily by pressing **[⌘]**.

### Using the Smart function key

When the **NR** indicator flashes rapidly, press **[NR]**.

- You can answer the call even if the handset is placed on the base unit or charger (page 15).

You can finish talking by pressing **[OFF]** without lifting up the handset.

### Adjusting the handset ringer volume

Press **[+]** or **[-]** repeatedly to select the desired volume while ringing.

## Useful features during a call

### Hold

- 1 Press **[MENU]** during an outside call.
- 2 **[↕]**: "Hold" → **[SELECT]**
- 3 **To release hold on the cellular line:**  
Press **[CELL]**.<sup>\*1</sup>
  - Another handset user can take the call by pressing **[CELL]**.<sup>\*1</sup>
    - \*1 If you press **[CELL]** and the selection list is displayed, select the desired cellular line and press **[SELECT]**.
  - The base unit user can take the call by pressing **[CELL 1]** or **[CELL 2]**. (KX-TG465SK series: page 3)

#### To release hold on the landline:

Press **[↶]**.

- Another handset user can take the call by pressing **[↶]**.
- The base unit user can take the call by pressing **[↷]**. (KX-TG465SK series: page 3)

#### Note:

- After holding for 10 minutes, the call is disconnected.

### Mute

- 1 Press **[MUTE]** during a call.
- 2 To return to the call, press **[MUTE]**.

#### Note:

- **[MUTE]** is a soft key visible on the display during a call.

## Making/Answering Calls Using the Handset

### Flash for landline calls

**[FLASH]** allows you to use the special features of your host PBX such as transferring an extension call, or accessing optional telephone services.

**Note:**

- To change the flash time, see page 42.

### For Call Waiting or Visual Call Waiting service users

To use Call Waiting or Visual Call Waiting, you must first subscribe with your service provider/telephone company.

This feature allows you to receive calls while you are already talking on the phone. If you receive a call while on the phone, you will hear a Call Waiting tone.

**If you subscribe to both Call Display and Visual Call Waiting services**, the 2nd caller's information is displayed after you hear the Call Waiting tone on the handset.

- 1 Press **[CALL WAIT]** to answer the 2nd call.
- 2 To switch between calls, press **[CALL WAIT]**.

**Note:**

- Please contact your service provider/telephone company for details and availability of this service in your area.

### Temporary tone dialing for landline calls (for rotary/pulse service users)

Press **[\*]** (TONE) before entering access numbers which require tone dialing.

### Handset clarity booster

This feature can improve sound clarity when the handset is used in an area where there may be interference. During an outside call, this feature is turned on automatically when necessary.

- When this feature is turned on, **[BOOST]** is displayed. However, during a cellular call,

**[BOOST]** is not displayed even though the feature is activated.

### Handset noise reduction

This feature allows you to hear the voice of the person you are talking to clearly, by reducing the surrounding noise coming from the other party's telephone.

Press **[NR]** to turn on/off while talking.

**Note:**

- Depending on the environment where this handset is being used, this feature may not be effective.
- This feature is not available using the speakerphone.

### Handset equalizer

This feature clarifies the voice of the person you are talking to, producing a more natural-sounding voice that is easier to hear and understand.

- 1 Press **[MENU]** while talking.
- 2 **[↕]**: "Equalizer" → **[SELECT]**
- 3 **[↕]**: Select the desired setting.
- 4 Press **[OK]** to exit.

**Note:**

- Depending on the condition and quality of your telephone line, this feature may emphasize existing line noise. If it becomes difficult to hear, turn this feature off.
- This feature is not available while using the speakerphone.
- When both the "Equalizer" setting and noise reduction are activated, **[NR]** is shown on the display.

### Call share

You can join an existing outside call.

■ **While another unit is on a cellular call:**

- 1 To join the conversation, press **[CELL]**.
  - You can join the conversation when:
    - only 1 cellular phone is paired.

## Making/Answering Calls Using the Handset

- a specific line is set to make cellular calls (page 20).

- 2 **[↕]**: Select the desired cellular phone.  
→ **[SELECT]**

### ■ While another unit is on a landline call:

To join the conversation, press **[↩]**.

#### Note:

- A maximum of 3 parties (including 1 outside party) can join a conversation using 2 extensions. (**3-way conference**)
- To prevent other users from joining your conversations with outside callers, turn privacy mode on (page 42).

## Transferring calls, conference calls

Outside calls can be transferred or a conference call with an outside party can be made between 2 handsets.

- 1 During an outside call, press **[MENU]**.
- 2 **[↕]**: “Intercom” → **[SELECT]**
- 3 **[↕]**: Select the desired unit. → **[SELECT]**
- 4 Wait for the paged party to answer.
  - If the paged party does not answer, press **[↩]** to return to the outside call.
- 5 **To complete the transfer:**  
Press **[OFF]**.  
**To establish a conference call:**  
**[MENU]** → **[↕]**: “Conference” → **[SELECT]**
  - To leave the conference, press **[OFF]**.  
The other 2 parties can continue the conversation.
  - To put the outside call on hold:  
**[MENU]** → **[↕]**: “Hold” → **[SELECT]**  
To resume the conference: **[MENU]**  
→ **[↕]**: “Conference” → **[SELECT]**
  - To cancel the conference: **[MENU]** → **[↕]**: “Stop conference” → **[SELECT]**  
You can continue the conversation with the outside caller.

## Transferring a cellular call between the handset and a cellular phone

### Transferring a cellular call from the handset to a cellular phone

- 1 Press **[MENU]** during a cellular call.
- 2 **[↕]**: “Transfer to cell” → **[SELECT]**
  - The cellular call is transferred to the cellular phone.

#### Note:

- Depending on your cellular phone type, you may need to set the cellular phone to be ready to talk before transferring. For example, if your cellular phone has a top cover, open it beforehand.

### Transferring a cellular call from a cellular phone to the handset

During a conversation using a cellular phone, the call cannot be transferred to the handset by the cellular phone. Perform the following with the handset.

- 1 During a conversation using a cellular phone, press **[CELL]**.
  - The call is transferred to the handset when:
    - only 1 cellular phone is paired.
    - a specific line is set to make cellular calls (page 20).
- 2 **[↕]**: Select the desired cellular phone. → **[SELECT]**
  - The call is transferred to the handset.

## Answering a 2nd call

If you receive a call while talking on the phone, the interrupt tone sounds (page 40) and the 2nd caller's information is displayed if you subscribe to Call Display (page 48).

### Answering a 2nd call during a landline call

- 1 Press **[MENU]** during a landline call.



## Making/Answering Calls Using the Handset

- 2 **[↕]: “Hold” → [SELECT]**
- 3 **To answer the 2nd call:**  
Press **[CELL]** while the 2nd call is being received.
- 4 To hang up the 2nd call and return to the 1st call (landline call), press **[OFF]**, then press **[↶]**.

### Answering a 2nd call during a cellular call



- 1 Press **[MENU]** during a cellular call.
  - 2 **[↕]: “Hold” → [SELECT]**
  - 3 **To answer the 2nd call:**  
Press **[↶]** or **[CELL]** while the 2nd call is being received.
  - 4 To hang up the 2nd call and return to the 1st call (cellular call), press **[OFF]**, then press **[CELL]**\*1.
- \*1 If you press **[CELL]** and the selection list is displayed, select the desired cellular line and press **[SELECT]**.

### Power back-up operation for landline

When a power failure occurs, the charged handset temporarily supplies power to the base unit (power back-up mode). This allows you to make and receive landline calls using a handset during a power failure. The base unit will not perform any other functions. However, some functions such as Call Display and phonebook are available only when using a handset other than the handset supplying power to the base unit. You can program “Power failure” and the default setting is “Auto” (page 42).

#### Important:

- If a handset is not placed on the base unit when a power failure occurs, “**Base no power Press OFF**” is displayed. After pressing **[OFF]** on the handset, place it on the base unit to start power back-up mode.

- Power back-up mode will not work if the battery level of the power supplying handset is  or .
- Do not lift the power supplying handset from the base unit during power back-up mode.

### Panasonic Ni-MH battery performance (supplied batteries) during power back-up mode

When the batteries are fully charged, operating time of the handset in power back-up mode varies depending on usage.

- Continuous use of the handset in power back-up mode: 1.5 hours max.
- Continuous use of the handset other than a handset in power back-up mode: 2 hours max.
- Not in use in power back-up mode: 2 hours max.

### Making calls during a power failure

#### ■ When only 1 handset is registered:

- 1 Lift the handset and dial the phone number.
- 2 Within 1 minute, place the handset on the base unit.
  - Wait until speakerphone is turned on automatically and the call is made.
- 3 When the other party answers the call, keep the handset on the base unit and talk using the speakerphone.
- 4 When you finish talking, press **[OFF]**.

■ **When 2 or more handsets are registered:**  
You should leave one handset on the base unit for supplying the power, and use another handset for making calls.

#### Note:

- The range of the base unit is limited during a power failure. Please use the handset close to the base unit.

## Making/Answering Calls Using the Handset

---

### Making a call using the redial list

■ **When only 1 handset is registered:**

- 1 Lift the handset.
- 2 [**▶**] REDIAL
- 3 [**↕**]: Select the desired phone number.
- 4 Within 1 minute, place the handset on the base unit.
  - Wait until speakerphone is turned on automatically and the call is made.

■ **When 2 or more handsets are registered:**

You should leave one handset on the base unit for supplying the power, and use another handset for making calls.

### Making a call using the phonebook

**There must be at least 2 handsets registered to the base unit in order for the phonebook feature to be used during a power failure.**

You should leave one handset on the base unit for supplying the power, and use another handset for making calls.

### Answering calls during a power failure

■ **When only 1 handset is registered:**

- 1 When the unit rings, keep the handset on the base unit and press [**☎**] or [**📞**].
  - Speakerphone is turned on.
- 2 When you finish talking, press [**OFF**].

■ **When 2 or more handsets are registered:**

When the unit rings, use a handset which is not supplying power to the base unit.

- Do not use or lift the handset which is placed on the base unit during power back-up mode.

**Note:**

- The range of the base unit is limited during a power failure. Please use the handset close to the base unit.

## Making/Answering Calls Using the Base Unit

### Making cellular calls

#### Available for:

KX-TG465SK series (page 3)

- 1 Press **[CELL 1]** or **[CELL 2]**.
- 2 Dial the phone number.
- 3 When the other party answers, speak into the microphone.
- 4 When you finish talking, press **[END]**.

#### Note:

- For best performance, use the speakerphone in a quiet environment.
  - While on a call, you can switch from the base unit to the handset:
    - With the privacy mode off (page 42), press **[CELL]**\*1 on the handset. → **[↓]**: Select the desired cellular phone. → **[SELECT]** → Press **[END]** on the base unit.
    - If the handset is on the base unit, simply lift it.
- \*1 The call is taken when:
  - only 1 cellular phone is paired.
  - a specific line is set to make cellular calls (page 20).

### Adjusting the speaker volume

Press **[+]** or **[-]** repeatedly while talking.

### Redialing the last number dialed

- 1 Press **[CELL 1]** or **[CELL 2]**.
- 2 **[REDIAL]**

### Making landline calls

- 1 **[END]**
- 2 Dial the phone number.
- 3 When the other party answers, speak into the microphone.
- 4 When you finish talking, press **[END]**.

#### Note:

- While on a call, you can switch from the base unit to the handset:
  - Press **[END]** on the handset, then press **[END]** on the base unit with the privacy mode off (page 42).
  - If the handset is on the base unit, simply lift it.

### Redialing the last number dialed

**[END]** → **[REDIAL]**

### Pause (for PBX/long distance service users)

A pause is sometimes required when making calls using a PBX or long distance service. When storing a calling card access number and/or PIN in the phonebook, a pause is also needed (page 34).

**Example:** If you need to dial the line access number "9" when making outside calls with a PBX:

- 1 **[END]**
- 2 **[9]** → **[PAUSE]**
- 3 Dial the phone number.

#### Note:

- A 3.5 second pause is inserted each time **[PAUSE]** is pressed.

### Answering calls

When a landline call is being received, the SP-PHONE indicator flashes rapidly. When a cellular call is being received, the CELL indicator and SP-PHONE indicator flash rapidly.

- 1 Press **[END]** when the unit rings.
  - You can also answer the cellular call by pressing **[CELL 1]** or **[CELL 2]**.
- 2 Speak into the microphone.
- 3 When you finish talking, press **[END]**.

## Making/Answering Calls Using the Base Unit

### Adjusting the base unit ringer volume

Press **[+]** or **[-]** repeatedly to select the desired volume while ringing.

- To turn the ringer off, press and hold **[-]** until the unit beeps.

### Useful features during a call

#### Hold

- 1 Press **[HOLD]** during an outside call.
- 2 **To release hold on the cellular line:**  
Press **[CELL 1]** or **[CELL 2]**.
  - A handset user can take the call:  
**[CELL]\*1 → [SELECT]**  
\*1 The call is taken when:
    - only 1 cellular phone is paired.
    - a specific line is set to make cellular calls (page 20).

**To release hold on the landline:**  
Press **[↩]**.

- A handset user can take the call by pressing **[↩]**.

#### Note:

- While a landline call is on hold, the SP-PHONE indicator flashes.
- After holding for 10 minutes, the call is disconnected.

#### Mute

- 1 Press **[MUTE]** during a call.
  - The SP-PHONE indicator flashes.
- 2 To return to the call, press **[MUTE]**.

### Flash for landline calls

**[FLASH]** allows you to use the special features of your host PBX such as transferring an extension call, or accessing optional telephone services.

#### Note:

- To change the flash time, see page 42.

### For Call Waiting service users

To use Call Waiting, you must first subscribe with your service provider/telephone company. This feature allows you to receive calls while you are already talking on the phone. If you receive a call while on the phone, you will hear a Call Waiting tone.

- 1 Press **[CALL WAIT]** to answer the 2nd call.
- 2 To switch between calls, press **[CALL WAIT]**.

#### Note:

- Please contact your service provider/telephone company for details and availability of this service in your area.

### Temporary tone dialing for landline calls (for rotary/pulse service users)

Press **[TONE]** (TONE) before entering access numbers which require tone dialing.

### Call share

You can join an existing outside call.

- To select the line that is being used for the call:
- for a cellular line press **[CELL 1]** or **[CELL 2]**.
  - for the landline press **[↩]**.

#### Note:

- A maximum of 3 parties (including 1 outside party) can join a conversation using 2 extensions. **(3-way conference)**
- To prevent other users from joining your conversations with outside callers, turn privacy mode on (page 42).

### Transferring calls, conference calls

Outside calls can be transferred or a conference call with an outside party can be made between a handset and the base unit.

## Making/Answering Calls Using the Base Unit

- 1 During an outside call, press **[INTERCOM]**.  
**When 2 or more handsets are registered:**
  - To page a specific handset, enter the handset number.
  - To page all handsets, press **[0]** or wait for a few seconds.
- 2 Wait for the paged party to answer.
  - If paged party does not answer, press **[INTERCOM]** to return to the outside call.
- 3 **To complete the transfer:**  
Press **[⇨]**.
  - The outside call is being routed to the handset.**To establish a conference call:**  
Press **[CONF]**.
  - To leave the conference, press **[⇨]**. The other 2 parties can continue the conversation.
  - To put the outside call on hold, press **[HOLD]**. To resume the conference, press **[CONF]**.

---

### Transferring a cellular call between the base unit and a cellular phone

---

#### Transferring a cellular call from the base unit to a cellular phone

During a cellular call, press and hold **[CELL 1]** or **[CELL 2]** until the SP-PHONE indicator goes out.

- The cellular call is transferred to the cellular phone.

---

#### Transferring a cellular call from a cellular phone to the base unit

During a conversation using a cellular phone, press **[CELL 1]** or **[CELL 2]**.

- The cellular call is transferred to the base unit.

---

### Answering a 2nd call

If you receive a call while talking on the phone, the interrupt tone sounds (page 40).

---

### Answering a 2nd call during a landline call

- 1 Press **[HOLD]** during a landline call.
- 2 **To answer the 2nd call:**  
Press **[CELL 1]** or **[CELL 2]**.
- 3 To hang up the 2nd call and return to the 1st call (landline call), press **[⇨]** 2 times.

---

### Answering a 2nd call during a cellular call

- 1 Press **[HOLD]** during a cellular call.
- 2 **To answer the 2nd call:**  
**[⇨]**, **[CELL 1]**, or **[CELL 2]**
- 3 To hang up the 2nd call and return to the 1st call (cellular call), press **[⇨]**, then press **[CELL 1]** or **[CELL 2]**.

## Locator/Intercom

### Handset locator

You can locate a misplaced handset by paging it.

- 1 Base unit:** Press **[LOCATOR]** or **[HANDSET LOCATOR]**.
  - All registered handsets beep for 1 minute.
- 2 To stop paging:**  
**Base unit:**  
Press **[LOCATOR]** or **[HANDSET LOCATOR]**.  
**Handset:**
  - **KX-TGE260 series: page 3**  
Press **[OFF]**.
  - **KX-TG465SK series: page 3**  
Press **[↶]**, then press **[OFF]**.

### Using the Smart function key

You can also stop paging:

- KX-TGE260 series: press **[NR]**.
- KX-TG465SK series: press **[NR]**, then press **[OFF]**.

### Cell locator

This feature allows you to locate a misplaced cellular phone by pressing the **[LOCATES CELL]** button on the base unit and calling your cellular phone. You must assign your cellular phone's phone number to the button beforehand. Only 1 cellular phone number (24 digits max.) can be assigned.

### Adding a phone number

- 1 [MENU]#248**
  - If you have already stored a cellular phone number, the current number is displayed.
- 2 Enter your cellular phone number. → [SAVE] → [OFF]**

### Erasing the number

- 1 [MENU]#248**
- 2 Press and hold [CLEAR] until all digits are erased. → [SAVE] → [OFF]**

### Calling the misplaced cellular phone

**Base unit: [LOCATES CELL]**

- To stop calling:
  - KX-TGE260 series: press **[LOCATES CELL]** again.
  - KX-TG465SK series: press **[↶]**.

**Important:**

- While the base unit is calling the cellular phone, the outside line is used.
    - KX-TGE260 series: Even if the cellular phone answers, you cannot talk with the cellular phone and the base unit beeps for 1 minute. To end the call, press **[LOCATES CELL]** on the base unit.
    - KX-TG465SK series: When the cellular phone answers, you can talk with the cellular phone. To end the call, press **[↶]** on the base unit.
- Charges may be incurred if the cellular phone answers the call.

### Intercom

Intercom calls can be made:

- between handsets
  - between a handset and the base unit\*1
- \*1 KX-TG465SK series: page 3

**Note:**

- When paging unit(s), the paged unit(s) beeps for 1 minute.
  - If you receive an outside call while talking on the intercom, the interrupt tone sounds (page 40).
    - To answer the call with the handset, press **[OFF]**, then press the corresponding line key.
    - To answer the call with the base unit, press **[↶]**, then press the corresponding line key.\*1
- \*1 KX-TG465SK series: page 3

## Making an intercom call

### Handset

- 1 **[MENU]** → **[↕]**: “Intercom” → **[SELECT]**
- 2 **[↕]**: Select the desired unit. → **[SELECT]**
- 3 When you finish talking, press **[OFF]**.

### Note:

- You can also use the **[INT]** soft key, if displayed, to make intercom calls.

### Base unit\*1

\*1 KX-TG465SK series: page 3

- 1 Press **[INTERCOM]**.  
**When 2 or more handsets are registered:**
  - To page a specific handset, enter the handset number.
  - To page all handsets, press **[0]** or wait for a few seconds.
    - To stop paging, press **[INTERCOM]**.
- 2 When you finish talking, press **[INTERCOM]**.

## Answering an intercom call

### Handset

- 1 Press **[↶]** to answer the page.
- 2 When you finish talking, press **[OFF]**.

### Base unit\*1

\*1 KX-TG465SK series: page 3

- 1 Press **[INTERCOM]** to answer the page.
- 2 When you finish talking, press **[INTERCOM]**.

## Using the Smart function key

Press **[NR]** to answer the page.

## Phonebook

### Phonebook

You can add 3,000 names (16 characters max.) and phone numbers (24 digits max.) to the phonebook, and assign each phonebook entry to the desired group (page 33). The following groups are available:

- Group 1: "Home"<sup>\*1</sup> (default)
- Group 2: "Cell 1"<sup>\*1</sup>
- Group 3: "Cell 2"<sup>\*1</sup>
- Group 4-9: You can change the group name for each group.

\*1 For groups 1-3, the group names cannot be changed.

#### Important:

- All entries can be shared by any registered handset.
- You can copy phonebook entries from a Bluetooth cellular phone to the unit's phonebook (page 51).

### Adding phonebook entries

- 1 [◀] □ □ → [MENU]
- 2 [↕]: "Add new entry" → [SELECT]
- 3 Enter the party's name. → [OK]
- 4 Enter the party's phone number. → [OK]
- 5 [↕]: Select the desired group. → [SELECT] 2 times
- 6 [OFF]

### Storing a redial list number to the phonebook

Phone numbers of up to 24 digits can be stored in the phonebook.

#### ■ When a cellular phone is paired:

- 1 [▶] REDIAL
- 2 [↕]: Select the desired phone number. → [MENU]
- 3 [↕]: "Save" → [SELECT]
- 4 To store the name, continue from step 3, "Editing entries", page 34.

#### ■ When a cellular phone is not paired:

- 1 [▶] REDIAL
- 2 [↕]: Select the desired phone number. → [SAVE]
- 3 To store the name, continue from step 3, "Editing entries", page 34.

### Storing caller information to the phonebook

#### ■ When a cellular phone is paired:

- 1 [▼] CID
- 2 [↕]: Select the desired entry. → [SELECT]
  - To edit the number, press [✕] (Edit) repeatedly until the phone number is shown in the desired format.
- 3 [SAVE]
- 4 [↕]: "Phonebook" → [SELECT]
- 5 Continue from step 3, "Editing entries", page 34.

#### ■ When a cellular phone is not paired:

- 1 [▼] CID
- 2 [↕]: Select the desired entry. → [MENU]
  - To edit the number: [↕]: "Edit" → [SELECT]  
Press [EDIT] repeatedly until the phone number is shown in the desired format. And then, press [SAVE]. Go to step 4.
- 3 [↕]: "Save CID" → [SELECT]
- 4 [↕]: "Phonebook" → [SELECT]
- 5 Continue from step 3, "Editing entries", page 34.

### Character table for entering names

While entering characters, you can switch between uppercase and lowercase by pressing [✕] (A→a).

Key	Character
[1]	& ' ( ) * .
	- . / 1



Key	Character
[2]	A B C 2
	a b c 2
[3]	D E F 3
	d e f 3
[4]	G H I 4
	g h i 4
[5]	J K L 5
	j k l 5
[6]	M N O 6
	m n o 6
[7]	P Q R S 7
	p q r s 7
[8]	T U V 8
	t u v 8
[9]	W X Y Z 9
	w x y z 9
[0]	_ 0
[#]	#

- To enter another character that is located on the same dial key, first press [►] to move the cursor to the next space.
- If you do not press any dial key within 5 seconds after entering a character, the character is fixed and the cursor moves to the next space.
- \_ in the above table represents a single space.

### Erasing the character or number

Press [◀] or [▶]. → [CLEAR]

- Press and hold [CLEAR] to erase all characters or numbers.

### Groups

Groups can help you find entries in the phonebook quickly and easily. You can change the group name for groups 4-9 ("Friends", "Family", etc.). By assigning different ringer tones for different groups of callers, you can identify who is calling (ringer

ID), if you have subscribed to Call Display service.

### Changing group names/setting ringer ID

- 1 [◀] □□ → [MENU]
- 2 [↕]: "Group" → [SELECT]
- 3 [↕]: Select the desired group. → [SELECT]
  - If you selected "Home", "Cell 1", or "Cell 2", go to step 5.
- 4 **To change group names**  
 [↕]: "Group name" → [SELECT] → Edit the name (10 characters max.). → [SAVE]
- 5 **To set group ringer tone**  
 [↕]: Select the current setting of the group ringer tone. → [SELECT] → [↕]: Select the desired ringer tone. → [SAVE]
- 6 [OFF]

### Finding and calling from a phonebook entry

■ Using a cellular line:

- 1 [◀] □□
- 2 **To scroll through all entries**  
 [↕]: Select the desired entry.  
**To search by first character**
  - ① Press the dial key ([0] to [9], or [#]) which contains the character you are searching for (page 32).
  - ② [↕]: Scroll through the phonebook if necessary.**To search by query**  
 You can narrow down the search to enter the first characters of a name.
  - ① [X]
  - ② To search for the name, enter the first characters (up to 4) in uppercase (page 32).
  - ③ [OK]
  - ④ [↕]: Scroll through the phonebook if necessary.**To search by group**
  - ① [GROUP]

## Phonebook

- ② [**↕**]: Select the desired group. → **[SELECT]**
- ③ [**↕**]: Scroll through the phonebook if necessary.
- 3 **[CELL]**
  - The unit starts dialing when:
    - only 1 cellular phone is paired.
    - a specific line is set to make cellular calls (page 20).
- 4 [**↕**]: Select the desired cellular phone. → **[SELECT]**
- **Using the landline:**
- 1 [**←**] **□□**
- 2 **To scroll through all entries**  
[**↕**]: Select the desired entry.  
**To search by first character**
  - ① Press the dial key ([**0**] to [**9**], or [**#**]) which contains the character you are searching for (page 32).
  - ② [**↕**]: Scroll through the phonebook if necessary.**To search by query**

You can narrow down the search to enter the first characters of a name.

  - ① **☒**
  - ② To search for the name, enter the first characters (up to 4) in uppercase (page 32).
  - ③ **[OK]**
  - ④ [**↕**]: Scroll through the phonebook if necessary.**To search by group**
  - ① **[GROUP]**
  - ② [**↕**]: Select the desired group. → **[SELECT]**
  - ③ [**↕**]: Scroll through the phonebook if necessary.
- 3 [**↶**]

### Editing entries

- 1 Find the desired entry (page 33). → **[MENU]**
- 2 [**↕**]: “Edit” → **[SELECT]**
- 3 Edit the name if necessary. → **[OK]**
- 4 Edit the phone number if necessary. → **[OK]**

- 5 [**↕**]: Select the desired group (page 33). → **[SELECT]** 2 times
- 6 **[OFF]**

### Erasing entries

#### Erasing an entry

- 1 Find the desired entry (page 33). → **[MENU]**
- 2 [**↕**]: “Erase” → **[SELECT]**
- 3 [**↕**]: “Yes” → **[SELECT]**
- 4 **[OFF]**

#### Erasing all entries

- 1 [**←**] **□□** → **[MENU]**
- 2 [**↕**]: “Erase all” → **[SELECT]**
- 3 [**↕**]: Select the desired group. → **[SELECT]**
- 4 [**↕**]: “Yes” → **[SELECT]**
- 5 [**↕**]: “Yes” → **[SELECT]**
- 6 **[OFF]**

### Chain dial

This feature allows you to dial phone numbers in the phonebook while you are on a call. This feature can be used, for example, to dial a calling card access number or bank account PIN that you have stored in the phonebook, without having to dial manually.

- 1 During an outside call, press **[MENU]**.
- 2 [**↕**]: “Phonebook” → **[SELECT]**
- 3 [**↕**]: Select the desired entry.
- 4 Press **[CALL]** to dial the number.

#### Note:

- When storing a calling card access number and your PIN in the phonebook as one phonebook entry, press **[▲]** (Pause) to add pauses after the number and PIN as necessary (page 22).
- If you have rotary/pulse service, you need to press **☒** (TONE) before pressing **[MENU]** in step 1 to change the dialing

mode temporarily to tone. When adding entries to the phonebook, we recommend adding ☒ (TONE) to the beginning of phone numbers you wish to chain dial (page 32).

## Speed dial

You can assign 1 phone number to each of the dial keys (1 to 9) on the handset.

### Adding phone numbers to speed dial keys

#### ■ By entering phone numbers:

- 1 Press and hold the desired speed dial key (1 to 9). → **[ADD]**
- 2 [↕]: “Manual” → **[SELECT]**
- 3 Enter the party's name (16 characters max.). → **[OK]**
- 4 Enter the party's phone number (24 digits max.). → **[OK]**
- 5 **[SELECT]** → **[OFF]**

#### ■ From the phonebook:

- 1 Press and hold the desired speed dial key (1 to 9). → **[ADD]**
- 2 [↕]: “Phonebook” → **[SELECT]**
- 3 [↕]: Select the desired entry.
- 4 **[SAVE]** → **[OFF]**

#### Note:

- If you edit a phonebook entry which is assigned to a speed dial key, the edited entry does not transfer to the speed dial key.

### Editing an entry

- 1 Press and hold the desired speed dial key (1 to 9). → **[MENU]**
- 2 [↕]: “Edit” → **[SELECT]**
- 3 Edit the name if necessary. → **[OK]**
- 4 Edit the phone number if necessary. → **[OK]**

### 5 [SELECT] → [OFF]

### Erasing an entry

- 1 Press and hold the desired speed dial key (1 to 9). → **[MENU]**
- 2 [↕]: “Erase” → **[SELECT]**
- 3 [↕]: “Yes” → **[SELECT]** → **[OFF]**

### Viewing an entry/Making a call

#### ■ Using a cellular line:

- 1 Press and hold the desired speed dial key (1 to 9).
- 2 **[CELL]**
  - The unit starts dialing when:
    - only 1 cellular phone is paired.
    - a specific line is set to make cellular calls (page 20).
- 3 [↕]: Select the desired cellular phone. → **[SELECT]**

#### ■ Using the landline:

- 1 Press and hold the desired speed dial key (1 to 9).
- 2 [↩]

## Programming

### Menu list

To access the features, there are 2 methods.

#### ■ Scrolling through the display menus

- 1 **[MENU]**
- 2 Press **[▼]** or **[▲]** to select the desired main menu. → **[SELECT]**
- 3 Press **[▼]** or **[▲]** to select the desired item from the next sub-menus. → **[SELECT]**
- 4 Press **[▼]** or **[▲]** to select the desired setting. → **[SAVE]**

#### ■ Using the direct command code

- 1 **[MENU]** → Enter the desired code.  
Example: Press **[MENU][#][1][0][1]**.
- 2 Select the desired setting. → **[SAVE]**

#### Note:

- To exit the operation, press **[OFF]**.
- In the following table, < > indicates the default settings.
- In the following table,  indicates the reference page number.
- Display menu order and sub-menu may vary depending on your model.

### Display menu tree and direct command code table

Main menu:  "Phonebook"

Operation	Code	
Viewing the phonebook entry.	#280	33

Main menu: →) "Caller list"

Operation	Code	
Viewing the caller list.	#213	49

Main menu:  "Answering device"

Sub-menu 1	Sub-menu 2	Settings	Code	
Play new message	–	–	#323	56
Play all message	–	–	#324	56
Erase all message*1	–	–	#325	57
Greeting	Record greeting*1	–	#302	55
	Check greeting	–	#303	56
	Pre-recorded*1 (Reset to pre-recorded greeting)	–	#304	56

## Programming

Sub-menu 1	Sub-menu 2	Settings	Code	
New message alert <sup>*1</sup>	Outgoing call – On/Off	On <Off>	#338	57
	Outgoing call – Notification to	–		
	Outgoing call – Remote code	Activate <Inactivate>		
	Base unit beep	On <Off>	#339	57
Settings	Ring count <sup>*1</sup>	2-7 rings <4 rings> Toll saver	#211	60
	Recording time <sup>*1</sup>	1 min <3 min> Greeting only <sup>*2</sup>	#305	60
	Remote code <sup>*1</sup>	<111>	#306	59
	Screen call – Handset	<On> Off	#310	60
	Screen call – Base unit <sup>*1, *3</sup>	<On> Off	#*310	60
Answer on <sup>*1</sup>	–	–	#327	55
Answer off <sup>*1</sup>	–	–	#328	55

Main menu:  "Voice Mail access"<sup>\*4</sup>

Operation	Code	
Listening to Voice Mail messages.	#330	63

Main menu:  "Intercom"<sup>\*</sup>

Operation	Code	
Paging the desired unit.	#274	31

## Programming

Main menu:  "Bluetooth"

Sub-menu 1	Sub-menu 2	Settings	Code	
Link to cell - 1: Add new device <sup>5</sup> (for CELL 1) - 2: Add new device <sup>5</sup> (for CELL 2)	Connect <sup>1</sup> / Disconnect <sup>1</sup>	-	#6251 <sup>6</sup>	19
			#6252 <sup>7</sup>	
	Ringer volume - Handset	Off-6 <6>	#6281 <sup>6</sup>	22
			#6282 <sup>7</sup>	
	Ringer volume - Base unit <sup>1</sup>	Off-6 <1>	#*6281 <sup>6</sup>	28
			#*6282 <sup>7</sup>	
	Ringer tone <sup>8</sup>	<Tone 2> <sup>6</sup> <Tone 4> <sup>7</sup>	#6291 <sup>6</sup>	-
			#6292 <sup>7</sup>	
	Select unit to ring <sup>1</sup>	Handset 1-6 <All>	#6271 <sup>6</sup>	18
			#6272 <sup>7</sup>	
	Ring as cell (limited) <sup>1</sup>	<On (with Talking CID)> On (without Talking CID) Off	#6141 <sup>6</sup>	18
			#6142 <sup>7</sup>	
Text message alert - On/Off <sup>1</sup>	<On (no announce)> On (with name) Off	#6101 <sup>6</sup>	52	
		#6102 <sup>7</sup>		
Text message alert - Alert tone <sup>9</sup>	<Tone 1> <sup>6</sup> <Tone 2> <sup>7</sup>	#6101 <sup>6</sup>	52	
		#6102 <sup>7</sup>		
Pair	-	#6241 <sup>6</sup>	17	
		#6242 <sup>7</sup>		
Unpair	-	#6111 <sup>6</sup>	17	
		#6112 <sup>7</sup>		
Phonebook transfer	-	-	#618	51
Headset	Add new device <sup>5</sup>	-	#621	53
	Connect <sup>1</sup> / Disconnect <sup>1</sup>	-	#622	53
	Pair	-	#621	53
	Unpair	-	#612	53

## Programming

Sub-menu 1	Sub-menu 2	Settings	Code	
Settings	Auto connect* <sup>1</sup>	<1 min> 3 min 5 min 10 min Off	#632	18
	Cell area code* <sup>1</sup>	-	#633	20
	Cell line only mode* <sup>1</sup>	On <Off>	#157	19
	Cell line select - Handset	Cellphone 1* <sup>5</sup> Cellphone 2* <sup>5</sup> <Manual>	#634	20
	Cell line select - Base unit* <sup>1, *3</sup>	<Cellphone 1>* <sup>5</sup> Cellphone 2* <sup>5</sup>	#*634	
	Set PIN* <sup>1</sup>	<0000>	#619	20
	International Code* <sup>1</sup>	-	#117	51
	Country Code* <sup>1</sup>	-	#118	
Trunk prefix* <sup>1</sup>	-	#119		

Main menu:  "Set date & time"

Sub-menu 1	Sub-menu 2	Settings	Code	
Date and time* <sup>1</sup>	-	-	#101	15
Memo alarm	Alarm1-3	Once Daily Weekly <Off>	#720	43
Time adjustment* <sup>1, *10</sup>	-	<Caller ID auto> Manual	#226	-

Main menu:  "Speed dial"

Operation	Code	
Viewing the speed dial entry.	#261	35

## Programming

Main menu:  "Settings"

Sub-menu 1	Sub-menu 2	Settings	Code	
Ring adjustments	Ringer volume – Handset <sup>*4</sup>	Off-6 <6>	#160	–
	Ringer volume – Base unit <sup>*1, *4</sup>	Off-6 <1>	#*160	–
	Ringer tone <sup>*4, *8, *11</sup> (Handset)	<Tone 1>	#161	–
	Interrupt tone – Handset <sup>*12</sup>	<On> Off	#201	24
	Interrupt tone – Base unit <sup>*1, *3, *12</sup>	<On> Off	#*201	29
	Night mode – Handset	On/Off – On – <Off>	#238	44
		Start/End – <11:00 PM/ 06:00 AM>	#237	44
		Select group	#241	44
	Night mode – Base unit <sup>*1, *3</sup>	On/Off – On – <Off>	#*238	44
		Start/End – <11:00 PM/ 06:00 AM>	#*237	44
		Select group	#*241	44
	Set date & time	Date and time <sup>*1</sup>	–	#101
Memo alarm – Alarm1-3		Once Daily Weekly <Off>	#720	43
Time adjustment <sup>*1, *10</sup>		<Caller ID auto> Manual	#226	–
Talking Caller ID (Talking Call Display)	Handset	<On> Off	#162	48
	Base unit <sup>*1</sup>	On <Off>	#*162	



## Programming

Sub-menu 1	Sub-menu 2	Settings	Code		
Key detector setting* <sup>13</sup> - 1: Add new device (for Detector1)* <sup>14</sup> - 2: Add new device (for Detector2) - 3: Add new device (for Detector3) - 4: Add new device (for Detector4)	Change name* <sup>1</sup>	Detector1	#6561	-	
		Detector2* <sup>15</sup>	#6562* <sup>16</sup>		
		Detector3* <sup>15</sup>	#6563* <sup>16</sup>		
		Detector4* <sup>15</sup>	#6564* <sup>16</sup>		
	Registration	-		#6571	-
				#6572* <sup>16</sup>	
				#6573* <sup>16</sup>	
				#6574* <sup>16</sup>	
	Deregistration	-		#6581	-
				#6582* <sup>16</sup>	
				#6583* <sup>16</sup>	
				#6584* <sup>16</sup>	
Call block* <sup>1</sup>	Block a single number	-	#217	45	
	Block range of numbers	-			
	Block unknown CID (CID: Call Display)	On <Off>	#240	46	
	First ring	<On> Off	#173	46	
Speed dial	-	-	#261	35	
Cell locator	-	-	#248	30	
Record greeting* <sup>1</sup>	-	-	#302	55	
Voice mail* <sup>4</sup>	Save VM access#* <sup>1</sup> (VM: Voice Mail)	-	#331	62	
	VM tone detect* <sup>1</sup>	<On> Off	#332	62	
LCD contrast (Display contrast)	-	Level 1-4 <2>	#145	-	
Handset name	-	-	#104	46	
Display name	-	On <Off>	#105	46	
Smart function key	-	-	#278	16	
Key tone	-	<On> Off	#165	-	
Auto talk* <sup>17</sup>	-	On <Off>	#200	22	

## Programming

Sub-menu 1	Sub-menu 2	Settings	Code	
Set tel line*4	Set dial mode*1	Pulse <Tone>	#120	16
	Set flash time*1,*18	900 ms <700 ms> 600 ms 400 ms 300 ms 250 ms 200 ms 160 ms 110 ms 100 ms 90 ms 80 ms	#121	23
	Set line mode*1,*19	A <B>	#122	–
	C. WTG options*1 (Call Waiting Deluxe options)	On <Off>	#215	48
Privacy mode*1	–	On <Off>	#194	23, 28
Registration	Register handset	–	#130	47
	Deregistration*2	–	#131	47
Power failure	–	<Auto> Off	#152	25
Change language	Display	<English> Français	#110	15
	Voice prompt*1	<English> Français	#112	15

Main menu:  “Customer support”

Operation	Code	
Displaying customer support Web address.	#680	–

Main menu:  “Key detector”\*13

Sub-menu 1	Sub-menu 2	Settings	Code	
Search	–	–	#655	–
Battery check	–	–		

\*1 If you program these settings using one of the units, you do not need to program the same item using another unit.

\*2 This menu is not displayed when scrolling through the display menus. It is only available in direct command code.

\*3 KX-TG465SK series: page 3

## Programming

- \*4 When the cellular line only mode is turned on, these menus are not displayed (page 19).
- \*5 After the Bluetooth device is paired, the device name is displayed.
- \*6 For CELL 1
- \*7 For CELL 2
- \*8 The preset melodies in this product are used with permission of © 2012 Copyrights Vision Inc.
- \*9 The preset melodies in this product are used with the following permission:
  - “Tone 1” and “Tone 2”: © 2013 Copyrights Vision Inc.
  - “Tone 3” - “Melody 10”: © 2012 Copyrights Vision Inc.
- \*10 This feature allows the unit to automatically adjust the date and time each time caller information including date and time is received.  
To turn this feature on, select “Caller ID auto”. To turn this feature off, select “Manual”. (Call Display subscribers only)  
To use this feature, set the date and time first (page 15).
- \*11 If you subscribe to a distinctive ring service, select a tone (tone 1 or 2). If you select a melody, you cannot distinguish lines by their ringers.
- \*12 This tone lets you know when you receive an outside call while you are on another line or an intercom call. If you select “On”, the tone sounds 2 times.
- \*13 This setting is available when you have the key detector (KX-TGA20). Read the installation manual for more information on the key detector.
- \*14 For models with supplied key detectors, the display shows “1: Detector1”.
- \*15 If you register 2 or more key detectors.
- \*16 If you have 2 or more key detectors.
- \*17 If you subscribe to a Call Display service and want to view the caller’s information after lifting up the handset to answer a call, turn off this feature.
- \*18 The flash time depends on your telephone exchange or host PBX. Contact your PBX supplier if necessary.
- \*19 Generally, the line mode setting should not be changed. This setting automatically maintains receiver volume at the proper level depending on the current telephone line condition. Set the line mode to “A” if telephone line condition is not good.

## Alarm

An alarm sounds at the set time for 1 minute and is repeated 5 times at 5 minute intervals (snooze function). A text memo can also be displayed for the alarm. A total of 3 separate alarm times can be programmed for each handset. You can set one of 3 different alarm options (once, daily, or weekly) for each alarm time.

### Important:

- Make sure the unit’s date and time setting is correct (page 15).

1 [MENU] [7] [2] [0]

2 Select an alarm by pressing [1] to [3]. →  
[SELECT]

3 [↕]: Select the desired alarm option. →  
[SELECT]

“Off”
Turns alarm off. Go to step 10.
“Once”
An alarm sounds once at the set time.
“Daily”
An alarm sounds daily at the set time. Go to step 5.
“Weekly”
Alarm sounds weekly at the set time(s).

## Programming

- 4 Proceed with the operation according to your selection in step 3.
  - **Once:**  
Enter the desired month and date. → [OK]
  - **Weekly:**  
[↕]: Select the desired day of the week and press [SELECT]. → [OK]
- 5 Set the desired time.
- 6 [X]: Select "AM" or "PM". → [OK]
- 7 Enter a text memo (10 characters max.). → [OK]
- 8 [↕]: Select the desired alarm tone. → [SELECT]
  - We recommend selecting a different ringer tone from the one used for outside calls.
- 9 [↕]: Select the desired snooze setting. → [SAVE]
- 10 [SELECT] → [OFF]

### Note:

- Press [STOP] to stop the alarm completely.
- When the handset is in use, the alarm will not sound until the handset is in standby mode.
- Press any dial key, [NR], or [SNOOZE] to stop the sound but keep the snooze function activated.
- If you want to make an outside call when the snooze function is activated, please stop the snooze function before making the call.

## Night mode

Night mode allows you to select a period of time during which the handset and/or base unit will not ring for outside calls. This feature is useful for time periods when you do not want to be disturbed, for example, while sleeping. Night mode can be set for each unit. Using the phonebook's group feature (page 33), you can also select groups of callers whose calls override night mode and ring the handset (Call Display subscribers only).

### Important:

- Make sure the unit's date and time setting is correct (page 15).
- We recommend turning the base unit ringer off (page 38, 40) in addition to turning the night mode on. (KX-TGE260 series: page 3)
- If you have set the alarm, the alarm sounds even if the night mode is turned on.

### Turning night mode on/off

- 1 **For handset setting:** [MENU]#238  
**For base unit setting (using a handset)\*1:** [MENU]#X238
  - 2 [↕]: Select the desired setting. → [SAVE]
    - If you select "OFF", press [OFF] to exit.
  - 3 Enter the desired hour and minute you wish to start this feature.
  - 4 [X]: Select "AM" or "PM". → [OK]
  - 5 Enter the desired hour and minute you wish to end this feature.
  - 6 [X]: Select "AM" or "PM".
  - 7 [SAVE] → [OFF]
- \*1 KX-TG465SK series: page 3

### Changing the start and end time

- 1 **For handset setting:** [MENU]#237  
**For base unit setting (using a handset)\*1:** [MENU]#X237
  - 2 Continue from step 3, "Turning night mode on/off", 3.
- \*1 KX-TG465SK series: page 3

### Selecting groups to bypass night mode

- 1 **For handset setting:** [MENU]#241  
**For base unit setting (using a handset)\*1:** [MENU]#X241
- 2 Select your desired groups by pressing [1] to [9].
  - "✓" is displayed next to the selected group numbers.
  - To cancel a selected group, press the same dial key again. "✓" disappears.

**3 [SAVE] → [OFF]**

\*1 KX-TG465SK series: page 3

## Call block

This feature rejects calls from unwanted callers (Call Display subscribers only). The following items are available when storing phone numbers in the call block list (250 max.).

- "Block a single number": The unit can reject calls from specific phone numbers.
- "Block range of numbers": The unit can reject calls that begin with a number stored in the call block list, such as a toll-free phone number prefix or certain area codes.

You can also set the unit to reject calls that do not have a phone number.

When a call is received, the unit rings briefly\*1 while caller information is being received. If the caller's phone number matches an entry in the call block list, the unit emits no sound to the caller, and disconnects the call.

\*1 This is called first ring. If you do not want the first ring to sound, turn this setting to "off" (page 46).

**Important:**

- Rejected calls are logged in the caller list.

## Storing unwanted callers

### Storing a single phone number

**Important:**

- We recommend storing 10 digits (including the area code). If only 7 digits are stored, all numbers that have the same last 7 digits will be blocked.

■ **From the caller list:**

**When a cellular phone is paired:**

- 1 [v] CID
- 2 [↕]: Select the entry to be blocked. → [SELECT]
  - To edit the number, press [x] (Edit) repeatedly until the phone number is shown in the 10-digit format.

**3 [SAVE]**

**4 [↕]: "Call block" → [SELECT]**

**5 [↕]: "Yes" → [SELECT]**

**6** Edit the phone number if necessary (24 digits max.).

**7 [SAVE] → [OFF]**

**When a cellular phone is not paired:**

- 1 [v] CID
- 2 [↕]: Select the entry to be blocked. → [MENU]
  - To edit the number: [↕]: "Edit" → [SELECT]
 

Press [EDIT] repeatedly until the phone number is shown in the 10-digit format. And then, press [SAVE]. Go to step 4.

**3 [↕]: "Save CID" → [SELECT]**

**4 [↕]: "Call block" → [SELECT]**

**5 [↕]: "Yes" → [SELECT]**

**6** Edit the phone number if necessary (24 digits max.).

**7 [SAVE] → [OFF]**

■ **By entering phone numbers:**

- 1 [MENU][#][2][1][7]
- 2 [↕]: "Block a single number" → [SELECT]
- 3 [MENU] → [↕]: "Add" → [SELECT]
- 4 Enter the phone number (24 digits max.).
  - To erase a digit, press [CLEAR].
- 5 [SAVE] → [OFF]

### Storing a range of numbers

- 1 [MENU][#][2][1][7]
- 2 [↕]: "Block range of numbers" → [SELECT]
- 3 [MENU] → [↕]: "Add" → [SELECT]
- 4 Enter the desired number (2-8 digits).
  - To erase a digit, press [CLEAR].
- 5 [SAVE] → [OFF]

## Programming

### Blocking incoming calls that have no phone number

You can reject calls when no phone number is provided, such as private callers or out of area calls.

- 1 [MENU]#240
- 2 [↕]: Select the desired setting. → [SAVE] → [OFF]

#### Note:

- When the unit receives a cellular call without a phone number, the call may not be rejected.

### Setting the first ring for the call block list

If you do not want the first ring from a number on the call block list to sound, turn the first ring setting to "Off". The default setting is "On".

- 1 [MENU]#173
- 2 [↕]: Select the desired setting. → [SAVE] → [OFF]

### Viewing/editing/erasing call block numbers

- 1 [MENU]#217
- 2 [↕]: "Block a single number" or "Block range of numbers" → [SELECT]
- 3 [↕]: Select the desired entry.
  - To exit, press [OFF].
- 4 **To edit a number:**  
[EDIT] → Edit the number. → [SAVE] → [OFF]  
**To erase a number:**  
[ERASE] → [↕]: "Yes" → [SELECT] → [OFF]

#### Note:

- When editing, press the desired dial key to add, [CLEAR] to erase.

### Erasing all call block numbers

- 1 [MENU]#217
- 2 [↕]: "Block a single number" or "Block range of numbers" → [SELECT]
- 3 [MENU] → [↕]: "Erase all" → [SELECT]
- 4 [↕]: "Yes" → [SELECT]
- 5 [↕]: "Yes" → [SELECT] → [OFF]

## Other programming

### Changing the handset name

The default handset name is "Handset 1" to "Handset 6". You can customize the name of each handset ("Bob", "Kitchen", etc.). This is useful when you make intercom calls between handsets. To display the handset name in standby mode, turn on the handset name display feature (page 46).

- 1 [MENU]#104
- 2 Enter the desired name (10 characters max.).
- 3 [SAVE] → [OFF]

### Displaying the handset name

You can select whether or not the handset name is displayed in standby mode. The default setting is "Off".

- 1 [MENU]#105
- 2 [↕]: Select the desired setting. → [SAVE] → [OFF]

---

## Registering a unit

---

### Operating additional units

---

#### Additional handsets

Up to 6 handsets can be registered to the base unit.

**Important:**

- See page 5 for information on the available model.

---

### Registering a handset to the base unit

The supplied handset and base unit are pre-registered. If for some reason the handset is not registered to the base unit, re-register the handset.

- 1 Handset:**  
[MENU] [#] 1 3 0
- 2 Base unit:**  
Press and hold [LOCATOR] or [HANDSET LOCATOR] for about 5 seconds.
  - If all registered handsets start ringing, press [LOCATOR] or [HANDSET LOCATOR] again to stop, then repeat this step.
- 3 Handset:**  
Press [OK], then wait until a long beep sounds.

---

### Deregistering a handset

A handset can cancel its own registration to the base unit, or other handsets registered to the same base unit. This allows the handset to end its wireless connection with the system.

- 1 [MENU] [#] 1 3 1**
  - All handsets registered to the base unit are displayed.
- 2 [↕]:** Select the handset you want to cancel. → [SELECT]
- 3 [↕]:** "Yes" → [SELECT] → [OFF]

## Call Display Service

### Using Call Display service

#### Important:

- This unit is Call Display compatible. To use Call Display features, you must subscribe to a Call Display service. Contact your service provider/telephone company for details.

### Call Display features

When an outside call is being received, the caller information is displayed. Caller information for the last 50 callers is logged in the caller list from the most recent call to the oldest.

- If the unit cannot receive caller information, the following is displayed:
  - “**Unavailable**”: The caller dials from an area which does not provide a Call Display service.
  - “**Private caller**”: The caller requests not to send caller information.
  - “**Long distance**”: The caller makes a long distance call.
- If the unit is connected to a PBX system, caller information may not be properly received. Contact your PBX supplier.

### Missed calls

If a call is not answered, the unit treats it as a missed call. The display shows “**Missed call**”.

#### Note:

- Even when there are unviewed missed calls, “**Missed call**” disappears from the standby display if the following operation is performed by one of the units:
  - A handset is replaced on the base unit or charger.
  - Pressing [**OFF**] on a handset.

### Phonebook name display

When caller information is received and it matches a phone number stored in the phonebook, the stored name in the phonebook is displayed and logged in the caller list.

### Talking Call Display

#### Handset / Base unit

This feature lets you know who is calling without looking at the display.

To use this feature, you must:

- subscribe to a Call Display service of your service provider/telephone company.
- turn this feature on (page 40).

When caller information is received, the handsets and/or base unit announce the caller's name or phone number received from your service provider/telephone company following every ring.

- Name pronunciation may vary. This feature may not pronounce all names correctly.
- Call Display service has a limit of how many characters can be displayed. If the caller's name is too long, the unit may not be able to display or announce the entire name.

### Phonebook name announcement

When caller information is received and it matches a phone number stored in the phonebook, the stored name in the phonebook is announced.

### For Call Waiting Deluxe service users

To use Call Waiting Deluxe, you must subscribe to Call Waiting Deluxe from your service provider/telephone company. This feature not only allows the unit currently in use to display the 2nd caller's information, but also offers you a variety of ways to deal with the 2nd call.

#### Important:

- Please contact your service provider/telephone company for details and availability of this service in your area.
- This feature must be turned on before it can be used.

### To turn Call Waiting Deluxe on/off

To use Call Waiting Deluxe, you must turn this feature on. The default setting is “**OFF**”.



## Call Display Service

- 1 **[MENU]#215**
- 2 **[↕]**: Select the desired setting.
- 3 **[SAVE] → [OFF]**

### Call Waiting Deluxe service options

When a 2nd call is received, you can choose how to handle the call by selecting an option shown on the unit display.

#### Note:

- Your service provider/telephone company may not offer all of the options (page 49).

Displayed option	Function
<b>Answer</b>	Answers the waiting call, while keeping the 1st call on hold.
<b>Hold</b>	Holds the waiting call. The caller will hear the pre-recorded hold message played by your service provider/ telephone company.
<b>Announce</b>	The caller will hear the pre-recorded busy message played by your service provider/ telephone company (for example, "We are not available now.") and will then be disconnected.
<b>Forward</b>	Forwards the waiting call to the Voice Mail service provided by your service provider/telephone company. You must subscribe to Voice Mail service to use this function.
<b>Drop</b>	Disconnects (drops) the current call and answers the waiting call.
<b>Conference</b>	Answers the waiting call and combines it with the current call to make a conference call (3-party call).

Displayed option	Function
<b>Return</b>	Returns to the waiting caller while keeping the current call on hold.
<b>Drop caller1</b>	Disconnects (drops) the 1st call during a conference call.
<b>Drop caller2</b>	Disconnects (drops) the 2nd call during a conference call.

### To use Call Waiting Deluxe service

- 1 When you hear a Call Waiting tone during an outside call, press **[FLASH]**.
  - The option menu is displayed.
- 2 **[↕]**: Select the desired option. → **[SELECT]**
  - After selecting "Answer", "Hold", or "Conference", you can select another option. → **[FLASH] → [↕]**: Select the desired option. → **[SELECT]**

#### Note:

- To exit from the option menu, wait for 20 seconds.

## Caller list

#### Important:

- Make sure the unit's date and time setting is correct (page 15).

### Viewing the caller list and calling back

#### ■ Using a cellular line

- 1 **[▼]** CID
- 2 Press **[▼]** to search from the most recent call, or **[▲]** to search from the oldest call.
- 3 To call back, press **[SELECT]**. To exit, press **[OFF]**.
- 4 **[CELL]**
  - The unit starts dialing when:
    - only 1 cellular phone is paired.

## Call Display Service

- a specific line is set to make cellular calls (page 20).

**5** [ $\blacktriangle$ ]: Select the desired cellular phone. →  
[SELECT]

### ■ Using the landline

- 1** [ $\blacktriangledown$ ] CID
- 2** Press [ $\blacktriangledown$ ] to search from the most recent call, or [ $\blacktriangle$ ] to search from the oldest call.
- 3** To call back, press [ $\curvearrowright$ ].  
To exit, press [OFF].

### Note:

- If the entry has already been viewed or answered, “✓” is displayed.
- $\square$  or  $\square$  indicates the caller information was received from the cellular line.

## Using the Smart function key

When “Missed call” is displayed and the  $\mathcal{NR}$  indicator flashes slowly, there are missed calls.

Press [ $\mathcal{NR}$ ] in step 1 on “Viewing the caller list and calling back”, page 49.

- “Missed Call” must be set to “On” in “Setting the Smart function key”, page 16.
- If the handset is placed on the base unit or charger, you need to lift up the handset to view the caller list after pressing [ $\mathcal{NR}$ ].
- When the unit has new messages, new Voice Mail messages, and missed calls, the unit can be operated to play the new messages first, play the new Voice Mail messages next, and then show the missed calls.

## Editing a caller's phone number

You can edit a phone number in the caller list by adding the long distance code “1” or removing its area code.

### ■ When a cellular phone is paired:

- 1** [ $\blacktriangledown$ ] CID
- 2** [ $\blacktriangle$ ]: Select the desired entry. →  
[SELECT]
- 3** Press  $\square$  (Edit) repeatedly until the phone number is shown in the desired format.

### 4 Using a cellular line:

To make a cellular call, continue from step 4, “Viewing the caller list and calling back”, page 49.

### Using the landline:

[ $\curvearrowright$ ]

### ■ When a cellular phone is not paired:

- 1** [ $\blacktriangledown$ ] CID
- 2** [ $\blacktriangle$ ]: Select the desired entry. →  
[MENU]
- 3** [ $\blacktriangle$ ]: “Edit” → [SELECT]
- 4** Press [EDIT] repeatedly until the phone number is shown in the desired format.
- 5** [ $\curvearrowright$ ]

### Note:

- The number edited will not be saved in the caller list.

## Erasing selected caller information

- 1** [ $\blacktriangledown$ ] CID
- 2** [ $\blacktriangle$ ]: Select the desired entry.
- 3** [ERASE] → [ $\blacktriangle$ ]: “Yes” → [SELECT]
- 4** [OFF]

## Erasing all caller information

- 1** [ $\blacktriangledown$ ] CID
- 2** [ERASE] → [ $\blacktriangle$ ]: “Yes” → [SELECT]
- 3** [OFF]

## Copying phonebook from a cellular phone (phonebook transfer)

You can copy phonebook entries from the paired cellular phones or other cellular phones (not paired) to the unit's phonebook. A cellular phone must be compatible with Bluetooth wireless technology.

### Important:

- Your cellular phone must support Phone Book Access Profile (PBAP) or Object Push Profile (OPP) specification.
- If a copied entry has 2 or more phone numbers, each phone number (6 max.) is stored as a separate entry with the same name.
- If a phonebook entry includes additional data such as a picture, that entry may fail to copy to the base unit.
- If your cellular phone includes international call entries, set the conversion codes before copying (page 51).

### 1 Handset:

[MENU] # 6 1 8

### 2 Handset:

**To copy from paired cellular phones:**

[↑]: Select the desired cellular phone. → [SELECT]

- Copied items are stored to the group ("Cell 1" or "Cell 2") which the cellular phone is paired to.

**To copy from other cellular phones (not paired):**

[↑]: "Other cell" → [SELECT] → [↓]: Select the group you want to copy to. → [SELECT]

### 3 When "Use the cell to transfer phone book" is displayed: Go to step 4.

**When "Select mode" menu is displayed:**

[↑]: Select "Auto" or "Manual". → [SELECT]

"Auto": Download all entries from the cellular phone automatically. Go to step 5.  
"Manual": Copy entries you selected.

- "Select mode" menu is displayed only when the cellular phone supports PBAP (Phone Book Access Profile) for Bluetooth connection.
- Some cellular phones may require you to perform an operation on the cellular phone even if you select "Auto".

### 4 Cellular phone:

Follow the instructions of your cellular phone to copy phonebook entries.

- For other cellular phones (not paired), you need to search for and select the base unit. The Bluetooth PIN (default: "0000") may be required. If your cellular phone shows PassKey confirmation on its display, follow the directions to proceed.
- The entries being copied are displayed on the handset.

### 5 Handset:

Wait until "Completed" is displayed.

- You can continue copying other entries if necessary.

### 6 Handset: [OFF]

#### Note:

- Some copied entries may have characters which do not exist in the character table (page 32). These characters can be displayed but cannot be entered when editing an entry.
- The unit does not support some characters. If a copied entry includes those characters, they are replaced with other available characters or "\*".
- If you receive a call while copying phonebook entries, the copying procedure stops. Try again after finishing the call.

## Setting conversion codes

You must first set the following 3 dialing codes before transferring the phonebook from your cellular phone (each 4 digits max.).

- "International Code": An international prefix used when you make an international call.
- "Country Code": Your country code for international calls.

## Using Bluetooth Devices

- “**Trunk prefix**”: A trunk prefix; the initial digit(s) to be dialed in a domestic call, prior to the area code.

- 1 **[MENU]**
- 2 To store “**International Code**”:  
**#117**  
To store “**Country Code**”: **#118**  
To store “**Trunk prefix**”: **#119**
- 3 Enter the desired number. → **[SAVE]**
- 4 **[OFF]**

### Note:

- After you copy the entries, confirm that the numbers were transferred correctly.

## Text message (SMS) alert

The handset can notify you when a cellular phone that is paired to the base unit receives a text message. The handset can notify you by briefly displaying a message, by sounding a ringer tone or melody, and by announcement.

### Important:

- To use the text message alert feature, you need to pair your cellular phone to the base unit (page 17).
- Your cellular phone must support Message Access Profile (MAP) specification. We recommend that you confirm if your cellular phone supports MAP in advance.
- For more details and the list of compatible cellular phones, please visit our Web site: <http://www.panasonic.ca/link2cell>

### For those whose devices do not support the Message Access Profile (MAP):

By installing the app “Text Message Alert”, you can use the text message alert feature. Please visit our Web site: <http://www.panasonic.net/pcc/support/tel/sms/>



- Refer to your cellular phone operating instructions for information on how to install applications.

## Setting text message (SMS) alert

The following settings are available. The default is “**On (no announce)**”.

- “**On (no announce)**”: The handset notifies you but does not make an announcement.
- “**On (with name)**”: The handset notifies you and announces the name of the message sender.
- “**Off**”: The handset does not notify you.

### Your cellular phone

In order to use the text message alert feature, you may need to enable your cellular phone's Bluetooth notification feature.

### Handset

#### ■ Turning text message (SMS) alert on/off

- 1 For CELL 1: **[MENU]** **#6101**  
For CELL 2: **[MENU]** **#6102**
- 2 **[↕]**: “**On/Off**” → **[SELECT]**
- 3 **[↕]**: Select the desired setting.

- 4 **[SAVE]** → **[OFF]**

#### ■ Selecting the alerting tone

- 1 For CELL 1: **[MENU]** **#6101**  
For CELL 2: **[MENU]** **#6102**
- 2 **[↕]**: “**Alert tone**” → **[SELECT]**
- 3 **[↕]**: Select the desired setting.

- 4 **[SAVE]** → **[OFF]**

### Note:

- If the text message alert feature does not work, you must turn on notifications in the Bluetooth settings of your cellular phone. Then, unplug the base unit's AC adaptor and reconnect it to activate the text message alert feature. For instructions on how to do this, visit our Web site: <http://www.panasonic.net/pcc/support/tel/sms/>
- The unit announces the name or phone number depending on your cellular phone.
- This feature may not pronounce all names correctly.

- Text message alerts are not logged in the caller list of your unit.

### Using a Bluetooth wireless headset (optional) for landline calls

By pairing a Bluetooth headset to the base unit, you can have a hands-free conversation wirelessly for landline calls.

#### Important:

- Your Bluetooth wireless headset must support the HeadSet Profile (HSP) specification.
- 1 headset can be paired to the base unit.
- Only 2 Bluetooth devices can be used with the unit at the same time (for example, 2 cellular lines, or the headset and 1 cellular line).
- For best performance, we recommend using a Bluetooth headset within 1 m (3.3 feet) of the base unit. A headset can communicate with the base unit within a range of approximately 10 m (33 feet).

### Pairing a headset to the base unit

#### Important:

- Make sure that the Bluetooth headset is not connected to any other Bluetooth device.
- 1 Your headset:**  
Set your headset to pairing mode.
    - Refer to the headset operating instructions.
  - 2 Handset:**  
[MENU][#][6][2][1]
  - 3 If your headset PIN is "0000",** go to step 4.  
**If your headset PIN is other than "0000",** press [CLEAR], then enter your headset PIN.
    - Typically, default PIN is "0000". Refer to the headset operating instructions.
  - 4 Press [OK],** then wait until a long beep sounds.

### 5 [OFF]

- When the HEADSET indicator on the base unit lights up, you are ready to use the headset.

### Connecting/disconnecting a headset

If you cannot connect the headset and base unit using the headset, you can connect using the handset.

To use your headset with another Bluetooth device such as a cellular phone, you may need to disconnect it from the base unit.

#### Important:

- Make sure that the headset is turned on.

### 1 To connect/disconnect:

- [MENU][#][6][2][2]
- A long beep sounds.

### 2 [OFF]

### Unpairing a headset

You can cancel a pairing of the headset that is stored to the base unit.

### 1 [MENU][#][6][1][2]

### 2 [↕]: "Yes" → [SELECT]

- When the headset is unpaired, the HEADSET indicator is turned off.

### 3 [OFF]

### Operating a Bluetooth wireless headset using a landline

#### Important:

- Refer to your headset operating instructions for headset operations.

### Answering landline calls with your headset

To answer a landline call, turn on your headset referring to your headset operating instructions.

When you finish talking, turn off your headset referring to your headset operating instructions.

## Using Bluetooth Devices

---

### Note:

- If you cannot hang up the call using your headset:
  - press [▶■] (STOP) on the base unit.  
(KX-TGE260 series: page 3)
  - press [⏏] on the base unit 2 times.  
(KX-TG465SK series: page 3)

---

### Switching between the base unit and your headset

You can switch between the base unit and your headset:

- during a landline call with the base unit speakerphone. (KX-TG465SK series: page 3)
- during an intercom call between the base unit and headset. (KX-TG465SK series: page 3)
- while listening to messages recorded on the base unit answering system.

#### ■ To switch to your headset:

Turn on the headset referring to your headset operating instructions.

#### ■ To switch to the base unit (KX-TG465SK series: page 3):

Press [⏏] on the base unit.

---

### Call sharing between your headset and the handset

#### Important:

- To activate this feature, you should set privacy mode to off beforehand (page 42).
- **While the handset is on a landline call:**  
To join the conversation with your headset, turn on the headset referring to your headset operating instructions.
- **While your headset is on a landline call:**  
To join the conversation with the handset, press [📞].

---

### Adjusting your headset receiver volume

#### Base unit

Press [+] or [-] repeatedly while using your headset.

## Answering System for Landline

### Answering system for landline

The answering system can answer and record calls for you when you are unavailable to answer the phone.

You can also set the unit to play a greeting message but not to record caller messages by selecting “**Greeting only**” as the recording time setting (page 60).

#### Important:

- Make sure the unit’s date and time setting is correct (page 15).

### Memory capacity (including your greeting message)

The total recording capacity is about 16 minutes. A maximum of 64 messages can be recorded.

#### Note:

- When message memory becomes full:
  - “**Messages full**” is shown on the handset display.
  - The message counter on the base unit flashes if the answering system is turned on.
  - If you use the pre-recorded greeting message, the unit automatically switches to another pre-recorded greeting message asking callers to call again later.
  - If you recorded your own greeting message, the same message is still announced to callers even though their messages are not recorded.

### Turning the answering system on/off

#### Base unit

Press **[ANSWER ON/OFF]** to turn on/off the answering system.

#### Handset

- 1 **To turn on:**  
**[MENU]#[3][2][7]**  
**To turn off:**  
**[MENU]#[3][2][8]**
- 2 **[OFF]**

#### Note for base unit and handset:

- When the answering system is turned on, the message counter on the base unit displays the total number of messages (old and new).

### Greeting message

When the unit answers a call, a greeting message is played to callers.

You can use either:

- your own greeting message
- a pre-recorded greeting message

### Recording your greeting message

- 1 **[MENU]#[3][0][2]**
- 2 **[↕]: “yes” → [SELECT]**
- 3 After a beep sounds, hold the handset about 20 cm (8 inches) away and speak clearly into the microphone (2 minutes max.).
- 4 Press **[STOP]** to stop recording. → **[OFF]**

### Using a pre-recorded greeting message

The unit provides 2 pre-recorded greeting messages:

- If you erase or do not record your own greeting message, the unit plays a pre-recorded greeting asking callers to leave a message.
- If the message recording time (page 60) is set to “**Greeting only**”, callers’ messages are not recorded and the unit plays a different pre-recorded greeting message asking callers to call again.

## Answering System for Landline

### Resetting to a pre-recorded greeting message

If you want to use a pre-recorded greeting message once you record your own greeting message, you need to erase your own greeting message.

- 1 **[MENU]** **#** **3** **0** **4**
- 2 **[YES]** → **[OFF]**

### Playing back the greeting message

- 1 **[MENU]** **#** **3** **0** **3**
- 2 To exit, press **[OFF]**.

## Listening to messages

### Using the base unit

When new messages have been recorded, **[▶■]** on the base unit flashes. Press **[▶■]** (PLAY).

- During playback, **[▶■]** on the base unit lights.
- If new messages have been recorded, the base unit plays back new messages.
- If there are no new messages, the base unit plays back all messages.

### Operating the answering system during playback

Key	Operation
<b>[+]</b> or <b>[-]</b>	Adjust the speaker volume
<b>[◀◀]</b>	Repeat message*1
<b>[▶▶]</b>	Skip message
<b>[▶■]</b> (STOP)	Stop playback
<b>[ERASE]</b>	Erase currently playing message

\*1 If pressed within the first 5 seconds of a message, the previous message is played.

### Erasing all messages

Press **[ERASE]** 2 times while the unit is not in use.

### Using the handset

When new messages have been recorded, “New message” is displayed.

- 1 To listen to new messages:  
**[MENU]** **#** **3** **2** **3**  
To listen to all messages:  
**[MENU]** **#** **3** **2** **4**
- 2 When finished, press **[OFF]**.

#### Note:

- To switch to the receiver, press **[↶]**.
- You can also use the **[PLAY]** soft key, if displayed, to play new messages.

### Using the Smart function key

When “New message” is displayed and the **NR** indicator flashes slowly, there are new messages.

Press **[NR]** in step 1 on “Using the handset”, page 56.

- “New message” must be set to “On” in “Setting the Smart function key”, page 16.

### Operating the answering system

**[MENU]** → **[↕]**: “Answering device” → **[SELECT]**

Key	Operation
<b>[+]</b> or <b>[-]</b>	Adjust the receiver/speaker volume (during playback)
<b>1</b> or <b>[◀]</b>	Repeat message (during playback)*1
<b>2</b> or <b>[▶]</b>	Skip message (during playback)
<b>3</b>	Enter the “Settings” menu
<b>4</b>	Play new messages
<b>5</b>	Play all messages
<b>6</b>	Play greeting message
<b>7</b> <b>6</b>	Record greeting message



## Answering System for Landline

Key	Operation
[8]	Turn answering system on
[PAUSE]	Pause message*2
[9] or [STOP]	Stop recording Stop playback
[0]	Turn answering system off
[*]4*3	Erase currently playing message
[*]5	Erase all messages
[*]6	Reset to a pre-recorded greeting message

- \*1 If pressed within the first 5 seconds of a message, the previous message is played.
- \*2 To resume playback:  
[↕]: "Playback" → [SELECT]
- \*3 You can also erase as follows:  
[PAUSE] → [↕]: "Erase" → [SELECT] → [↕]: "Yes" → [SELECT]

### Calling back (Call Display subscribers only)

- Using a cellular line:
- 1 Press [PAUSE] during playback.
  - 2 [↕]: "Call back (Cell)" → [SELECT]
    - The unit starts dialing when:
      - only 1 cellular phone is paired.
      - a specific line is set to make cellular calls (page 20).
  - 3 [↕]: Select the desired cellular phone. → [SELECT]
- Using the landline:
- 1 Press [PAUSE] during playback.
  - 2 [↕]: "Call back" → [SELECT]

### Editing the number before calling back

- 1 Press [PAUSE] during playback.
- 2 [↕]: "Edit & Call" → [SELECT]

- 3 Press [EDIT] repeatedly until the phone number is shown in the desired format (page 50). → [↩]
  - To call back using a cellular line, continue from step 2, "Making cellular calls", page 21.

### Erasing all messages

- 1 [MENU]# [3] [2] [5]
- 2 [↕]: "Yes" → [SELECT] → [OFF]

## Advanced new message alerting features

### Audible message alert

This feature allows the base unit to beep to inform you of a new message arrival when new messages are recorded. The base unit beeps 2 times every minute until you listen to the messages, if the "Base unit beep" setting is turned on. The default setting is "Off".

- 1 [MENU]# [3] [3] [9]
- 2 [↕]: Select the desired setting. → [SAVE] → [OFF]

### New message alert by a call

This feature allows you to receive a notification by phone when new messages are recorded. The base unit calls a phone number you specify. You can then operate the answering system remotely to listen to the new message.

To use this feature, you must:

- store a phone number to which the unit makes the call to.
- turn on the new message alert setting.

After you answer the new message alert call, you can listen to messages from that call (page 58).

#### Important:

- A new message alert is stopped 1 minute after the unit starts to call. The unit will not retry the call even if the call is not answered.

## Answering System for Landline

### Storing a phone number to which the unit makes an alert call

#### ■ From the phonebook:

- 1 [MENU]#338
- 2 [↕]: "Notification to" → [SELECT] → [ADD]
- 3 [↕]: "Phonebook" → [SELECT]
- 4 [↕]: Select the desired phonebook entry. → [SAVE] → [OFF]

#### ■ By entering a phone number:

- 1 [MENU]#338
- 2 [↕]: "Notification to" → [SELECT] → [ADD]
- 3 [↕]: "Manual" → [SELECT]
- 4 Enter the desired name (16 characters max.). → [OK]
- 5 Enter the desired number (24 digits max.). → [OK] → [SELECT] → [OFF]

### Turning on/off the new message alert setting

- 1 [MENU]#338
- 2 [↕]: "On/Off" → [SELECT]
- 3 [↕]: Select the desired setting. → [SAVE] → [OFF]

### Editing the set phone number

- 1 [MENU]#338
- 2 [↕]: "Notification to" → [SELECT]
- 3 [MENU] → [↕]: "Edit" → [SELECT]
- 4 Edit the name if necessary (16 characters max.). → [OK]
- 5 Edit the phone number if necessary (24 digits max.). → [OK] → [SELECT] → [OFF]

### Erasing the set phone number

- 1 [MENU]#338
- 2 [↕]: "Notification to" → [SELECT]

- 3 [MENU] → [↕]: "Erase" → [SELECT]

- 4 [↕]: "Yes" → [SELECT] → [OFF]
  - The new message alert setting is turned off.

### Activating/inactivating the remote access code to play messages

If you activate this feature, you must enter the remote access code (page 59) to play the new message from the new message alert call. This is so that unauthorized parties cannot listen to your messages. The default setting is "Inactivate".

- "Inactivate": You can listen to the message by pressing [4] to play new messages (without entering the remote access code).
- "Activate": You must enter your remote access code and then press [4] to play new message.

- 1 [MENU]#338

- 2 [↕]: "Remote code" → [SELECT]

- 3 [↕]: Select the desired setting. → [SAVE] → [OFF]

### Listening to messages

After you answer the new message alert, you can listen to the messages as follows.

- When the remote access code is set to "Inactivate":  
Press [4] to play the new message during the announcement.

- When the remote access code is set to "Activate":

- 1 Enter the remote access code (page 59) during the announcement.
- 2 Press [4] to play the new message.

#### Note:

- Within 10 seconds after listening to new messages, you can press [#]9 during the call to turn off the new message alert by a call feature.
- Even if the unit makes a new message alert call, the handset redial list does not show the record.

## Answering System for Landline

### Remote operation

Using a touch-tone phone, you can call your phone number from outside and access the unit to listen to messages or change answering system settings. The unit's voice guidance prompts you to press certain dial keys to perform different operations.

### Remote access code

A 3-digit remote access code must be entered when operating the answering system remotely. This code prevents unauthorized parties from listening to your messages remotely. The default setting is "111".

#### Important:

- To prevent unauthorized access to this product, we recommend that you regularly change the remote code.

- 1 **[MENU]** **#** **3** **0** **6**
- 2 Enter the desired 3-digit remote access code.
- 3 **[SAVE]** → **[OFF]**

### Deactivating remote operation

Press **[X]** in step 2 on "Remote access code", page 59.

- The entered remote access code is deleted.

### Using the answering system remotely

- 1 Dial your landline phone number from a touch-tone phone.
- 2 After the greeting message starts, enter your remote access code.
- 3 Follow the voice guidance prompts as necessary or control the unit using remote commands (page 59).
- 4 When finished, hang up.

### Voice guidance

During remote operation, the unit's voice guidance starts and prompts you to press **[1]** to perform a specific operation, or press **[2]** to listen to more available operations.

#### Note:

- If you do not press any dial keys within 10 seconds after a voice guidance prompt, the unit disconnects your call.

### Remote commands

You can press dial keys to access certain answering system functions without waiting for the voice guidance to prompt you.

Key	Operation
<b>[1]</b>	Repeat message (during playback)*1
<b>[2]</b>	Skip message (during playback)
<b>[4]</b>	Play new messages
<b>[5]</b>	Play all messages
<b>[9]</b>	Stop playback
<b>[0]</b>	Turn answering system off
<b>[X] [4]</b>	Erase currently playing message
<b>[X] [5]</b>	Erase all messages
<b>[X] [#]</b>	End remote operation (or hang up)

\*1 If pressed within the first 5 seconds of a message, the previous message is played.

### Turning on the answering system remotely

- 1 Dial your phone number from a touch-tone phone.
- 2 Let the phone ring 15 times.
  - A long beep is heard.
- 3 Enter your remote access code within 10 seconds after the long beep.
  - The greeting message is played back.

## Answering System for Landline

- You can either hang up, or enter your remote access code again and begin remote operation (page 59).

## Answering system settings

### Call screening

#### Handset / Base unit\*1

While a caller is leaving a message, you can listen to the call through the unit's speaker. To adjust the speaker volume, press **[+]** or **[-]** repeatedly.

You can answer the call by pressing **[📞]** on the handset or **[📞]** on the base unit\*1.

Call screening can be set for each unit. The default setting is "On".

**1** For handset setting: **[MENU]#310**  
For base unit setting (using a handset)\*1: **[MENU]#\*310**

**2** **[↕]**: Select the desired setting. →  
**[SAVE] → [OFF]**

\*1 KX-TG465SK series: page 3

### Number of rings before the unit answers a call

You can change the number of times the phone rings "Ring count" before the unit answers calls. You can select 2 to 7 rings, or "Toll saver".

The default setting is "4 rings".

"Toll saver": The unit's answering system answers at the end of the 2nd ring when new messages have been recorded, or at the end of the 5th ring when there are no new messages. If you call your phone from outside to listen to new messages (page 59), you know that there are no new messages when the phone rings for the 3rd time. You can then hang up without being charged for the call.

**1** **[MENU]#211**

**2** **[↕]**: Select the desired setting. →  
**[SAVE] → [OFF]**

### For Voice Mail service subscribers

If you subscribe to a flat-rate service package that includes Call Display, Call Waiting, Voice Mail, and unlimited local/regional/long distance calls, please note the following:

- To use the Voice Mail service provided by your service provider/telephone company rather than the unit's answering system, turn off the answering system (page 55).
- To use this unit's answering system rather than the Voice Mail service provided by your service provider/telephone company, please contact your service provider/telephone company to deactivate your Voice Mail service.

If your service provider/telephone company cannot do this:

- Set this unit's "Ring count" setting so that this unit's answering system answers calls before the Voice Mail service of your service provider/telephone company does. It is necessary to check the number of rings required to activate the Voice Mail service provided by your service provider/telephone company before changing this setting.
- Change the number of rings of the Voice Mail service so that the answering system can answer the call first. To do so, contact your service provider/telephone company.

### Caller's recording time

You can change the maximum message recording time allowed for each caller. The default setting is "3 min".

**1** **[MENU]#305**

**2** **[↕]**: Select the desired setting. →  
**[SAVE] → [OFF]**

### Selecting "Greeting only"

You can select "Greeting only" which sets the unit to announce a greeting message to callers but not record messages.

Select "Greeting only" in step 2 on "Caller's recording time", page 60.



---

## Answering System for Landline

**Note:**

- When you select “**Greeting only**”:
  - If you do not record your own message, the unit will play the pre-recorded greeting-only message asking callers to call again later.
  - If you use your own message, record the greeting-only message asking callers to call again later (page 55).

## Useful Information

### Voice Mail service for landline

Voice Mail is an automatic answering service offered by your service provider/telephone company. After you subscribe to this service, your service provider/telephone company's Voice Mail system answers calls for you when you are unavailable to answer the phone or when your line is busy. Messages are recorded by your service provider/telephone company, not your telephone. Please contact your service provider/telephone company for details of this service.

#### Important:

- To use the Voice Mail service provided by your service provider/telephone company rather than the unit's answering system, turn off the answering system (page 55). For details, see page 60.

### Storing the Voice Mail (VM) access number

In order to listen to your Voice Mail messages, you must dial your service provider/telephone company's Voice Mail access number. Once you have stored your Voice Mail access number, you can dial it automatically (page 63).

- 1 **[MENU]#331**
- 2 Enter your access number (24 digits max.). → **[SAVE]** → **[OFF]**

#### Note:

- When storing your Voice Mail access number and your mailbox password, press **[▲]** (Pause) to add pauses (page 22) between the access number and the password as necessary. Contact your service provider/telephone company for the required pause time.

#### Example:

1-222-333-4444	PPPP	8888
VM access number	Pauses	Password

### To erase the Voice Mail access number

- 1 **[MENU]#331**
- 2 Press and hold **[CLEAR]** until all digits are erased. → **[SAVE]** → **[OFF]**

### Voice Mail (VM) tone detection

#### Handset / Base unit\*1

\*1 KX-TG465SK series: page 3

Your service provider/telephone company sends special signals (sometimes called "Voice Mail tones" or "stutter tones") to the unit to let you know you have new Voice Mail messages. If you hear a series of dial tones followed by a continuous dial tone after you press **[↶]** on the handset or press **[⏸]** on the base unit, you have new Voice Mail messages. Soon after you hang up a call or after the phone stops ringing, your unit checks the phone line to see if new Voice Mail messages have been recorded.

Turn this feature off when:

- You do not subscribe to Voice Mail service.
- Your service provider/telephone company does not send Voice Mail tones.
- Your phone is connected to a PBX.

If you are not sure which setting is required, contact your service provider/telephone company.

### Turning VM tone detection on/off

The default setting is "On".

- 1 **[MENU]#332**
- 2 **[↕]**: Select the desired setting. → **[SAVE]** → **[OFF]**

## Listening to Voice Mail messages

The unit lets you know that you have new Voice Mail messages in the following way:

- "Voice mail msg. via phone co." is displayed if message indication service is available.

### Handset

- 1 **[MENU]** **#** **3** **3** **0**
  - The speakerphone turns on.
- 2 Follow the pre-recorded instructions.
- 3 When finished, press **[OFF]**.

### Note:

- You can also use the **[ACCESS]** soft key, if displayed, to play new Voice Mail messages.
- If the handset still indicates there are new messages even after you have listened to all new messages, turn it off by pressing and holding **#** until the handset beeps.

### Base unit\*1

\*1 KX-TG465SK series: page 3

To listen to Voice Mail messages, you have to dial your Voice Mail access number manually.

## Using the Smart function key

When "Voice mail msg. via phone co." is displayed and the **NR** indicator flashes slowly, there are new Voice Mail messages.

Press **[NR]** in step 1 on "Listening to Voice Mail messages", page 63.

- "New VM" must be set to "On" in "Setting the Smart function key", page 16.
- If the Voice Mail (VM) access number is not stored, the **NR** indicator does not flash.
- When the unit has new messages, new Voice Mail messages, and missed calls, the unit can be operated to play the new Voice Mail messages first, play the new Voice Mail messages next, and then show the missed calls.

## Wall mounting

### Note:

- Make sure that the wall and the fixing method are strong enough to support the weight of the unit.

## Base unit

- 1 Lead the AC adaptor cord and telephone line cord through the hole in the wall mounting adaptor in the direction of the arrow.

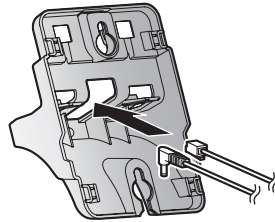

- 2 Tuck the telephone line cord inside the wall mounting adaptor (1). Connect the AC adaptor cord and telephone line cord (2).

1 AC adaptor cord

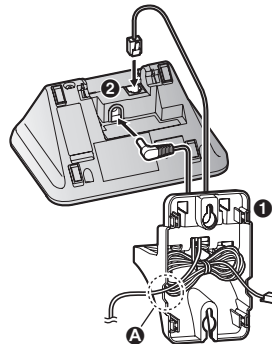

## Useful Information

- 3** Insert the hooks on the wall mounting adaptor into holes **(A)** and **(B)** on the base unit.

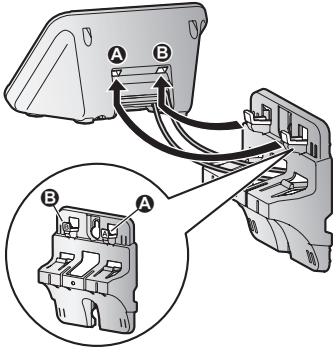

- 4** Adjust the adaptor to hold the base unit, then push it in the direction of the arrow until it clicks into place.

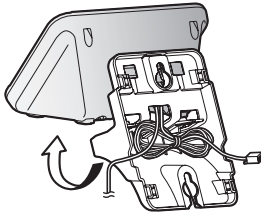
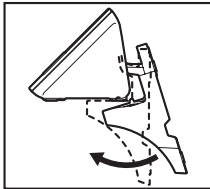

- 5** Mount the unit on a wall then slide down to secure in place.

- (A)** AC adaptor cord
  - This product is compliant with the following wall phone plate sizes (2 types).
- (B)** 83 mm (3 1/4 inches)

- (C)** 102 mm (4 inches)  
Fit the slots of the unit onto the corresponding wall phone plate tabs for **(D)** and **(E)** respectively.

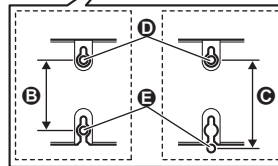
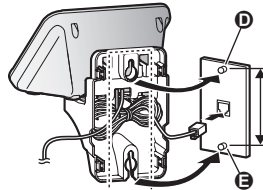
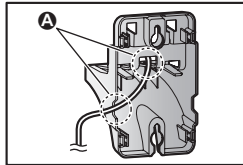

### To remove the wall mounting adaptor

While pushing down the release levers **(1)**, remove the adaptor **(2)**.

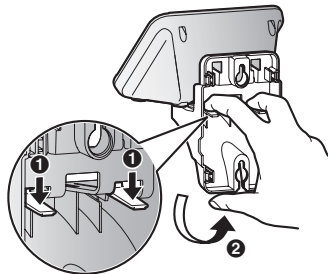



## Useful Information

### Charger

Drive the screws (A) (not supplied) into the wall.

B 27.2 mm (1 1/16 inches)

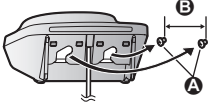

## Useful Information

### Error messages

Display message	Cause/solution
Ask phone company for VM access #	<ul style="list-style-type: none"><li>You have not stored the Voice Mail access number. Store the number (page 62).</li></ul>
Base no power or No link. Re-connect base AC adaptor. or No link.	<ul style="list-style-type: none"><li>The handset has lost communication with the base unit. Move closer to the base unit and try again.</li><li>Unplug the base unit's AC adaptor to reset the unit. Reconnect the adaptor and try again.</li><li>The handset's registration may have been cancelled. Re-register the handset (page 47).</li><li>When "No link." is displayed during a power failure, place a handset on the base unit to supply power to the base unit.</li></ul>
Busy	<ul style="list-style-type: none"><li>No cellular phone is paired to the base unit. Pair a cellular phone (page 17).</li><li>The called unit is in use.</li><li>Other units are in use and the system is busy. Try again later.</li><li>The handset you are using is too far from the base unit. Move closer and try again.</li></ul>
Check tel line	<ul style="list-style-type: none"><li>The supplied telephone line cord has not been connected yet or not connected properly. Check the connections (page 10).</li><li>If you do not connect the telephone line cord and use only cellular lines, set the cellular line only mode (page 19).</li></ul>
Error!!	<ul style="list-style-type: none"><li>Recording was too short. Try again.</li><li>Someone is using a cellular line or headset. Try again later.</li><li>The phonebook copy is incomplete (page 51). The cellular phone is disconnected from the base unit. Make sure that other Bluetooth devices are not connected to the cellular phone, and try again.</li></ul>
Failed	<ul style="list-style-type: none"><li>Although the unit tried to connect to the cellular phone or headset, the connection has been failed.<ul style="list-style-type: none"><li>Someone is using a cellular line or headset. Try again later.</li><li>Make sure that the cellular phone or headset is not connected to other Bluetooth devices.</li></ul></li></ul>
Invalid	<ul style="list-style-type: none"><li>There is no handset registered to the base unit matching the handset number you entered.</li><li>The handset is not registered to the base unit. Register the handset (page 47).</li></ul>

## Useful Information

Display message	Cause/solution
Requires subscription to Caller ID.	<ul style="list-style-type: none"><li>You must subscribe to a Call Display service. Once you receive caller information after subscribing to a Call Display service, this message will not be displayed.</li></ul>
Use rechargeable battery.	<ul style="list-style-type: none"><li>A wrong type of battery such as Alkaline or Manganese was inserted. Use only the rechargeable Ni-MH batteries noted on page 4, 7.</li></ul>

## Troubleshooting

If you still have difficulties after following the instructions in this section, disconnect the base unit's AC adaptor, then reconnect the base unit's AC adaptor. Remove the batteries from the handset, and then insert the batteries into the handset again.

### General use

Problem	Cause/solution
The handset does not turn on even after installing charged batteries.	<ul style="list-style-type: none"><li>Place the handset on the base unit or charger to turn on the handset.</li></ul>
The unit does not work.	<ul style="list-style-type: none"><li>Make sure the batteries are installed correctly (page 10).</li><li>Fully charge the batteries (page 11).</li><li>Check the connections (page 10).</li><li>Unplug the base unit's AC adaptor to reset the unit. Reconnect the adaptor and try again.</li><li>The handset has not been registered to the base unit. Register the handset (page 47).</li></ul>
I cannot pair a cellular phone to the base unit.	<ul style="list-style-type: none"><li>Depending on the compatibility of the cellular phone, you may not be able to pair it to the base unit. Confirm that your cellular phone supports the hands-free profile (HFP) specification.</li><li>Confirm that the Bluetooth feature of your cellular phone is turned on. You may need to turn this feature on depending on your cellular phone.</li><li>The Bluetooth technology on your cellular phone may not be functioning normally. Turn off and on your cellular phone.</li><li>If your cellular phone is already connected to another Bluetooth device such as a Bluetooth headset, turn it off or disconnect it from your cellular phone.</li><li>Some cellular phones may require you to enter the Bluetooth PIN to pairing. Confirm that you entered the correct PIN.</li></ul>



## Useful Information

Problem	Cause/solution
I cannot connect a cellular phone to the base unit.	<ul style="list-style-type: none"> <li>• Confirm that your cellular phone is turned on.</li> <li>• Confirm that your cellular phone is within base unit range (page 13).</li> <li>• Your cellular phone's Bluetooth feature is turned off. Turn it on.</li> <li>• Depending on the state of the wireless environment, such as the presence of any electrical interference, there may be a delay even if the auto connection feature is turned on. You can connect to the base unit manually (page 19).</li> <li>• The cellular phone has not been paired to the base unit. Pair the cellular phone (page 17).</li> </ul>
I cannot hear a dial tone.	<ul style="list-style-type: none"> <li>• The base unit's AC adaptor or telephone line cord is not connected. Check the connections.</li> <li>• Disconnect the base unit from the telephone line and connect the line to a known working telephone. If the working telephone operates properly, contact our service personnel to have the unit repaired. If the working telephone does not operate properly, contact your service provider/telephone company.</li> </ul>
I cannot use the Smart function key even if the  indicator is flashing slowly.	<ul style="list-style-type: none"> <li>• Another unit is in use. Wait and try again later.</li> </ul>
The base unit beeps.	<ul style="list-style-type: none"> <li>• New messages have been recorded. Listen to the new messages (page 56).</li> </ul>

## Menu list

Problem	Cause/solution
The display is in a language I cannot read.	<ul style="list-style-type: none"> <li>• Change the display language (page 15).</li> </ul>
I cannot register a handset to a base unit.	<ul style="list-style-type: none"> <li>• The maximum number of handsets (6) is already registered to the base unit. Cancel unused handset registrations from the base unit (page 47).</li> </ul>

## Battery recharge

Problem	Cause/solution
The handset beeps and/or  flashes.	<ul style="list-style-type: none"> <li>• Battery charge is low. Fully charge the batteries (page 11).</li> </ul>
I fully charged the batteries, but <ul style="list-style-type: none"> <li>–  still flashes,</li> <li>–  is displayed, or</li> <li>– the operating time seems to be shorter.</li> </ul>	<ul style="list-style-type: none"> <li>• Clean the battery ends (<math>\oplus</math>, <math>\ominus</math>) and the charge contacts with a dry cloth and charge again.</li> <li>• It is time to replace the batteries (page 10).</li> </ul>

**Making/answering calls, intercom**

Problem	Cause/solution
⚡ is displayed.	<ul style="list-style-type: none"> <li>• The handset is too far from the base unit. Move closer.</li> <li>• The base unit's AC adaptor is not properly connected. Reconnect AC adaptor to the base unit.</li> <li>• The handset is not registered to the base unit. Register it (page 47).</li> </ul>
Noise is heard, sound cuts in and out.	<ul style="list-style-type: none"> <li>• You are using the handset or base unit in an area with high electrical interference. Re-position the base unit and use the handset away from sources of interference.</li> <li>• Move closer to the base unit.</li> <li>• If you use a DSL/ADSL service, we recommend connecting a DSL/ADSL filter between the base unit and the telephone line jack. Contact your DSL/ADSL provider for details.</li> </ul>
The handset or base unit does not ring.	<ul style="list-style-type: none"> <li>• The ringer volume for landline is turned off. Adjust the ringer volume (page 40).</li> <li>• The ringer volume for cellular line is turned off. Adjust the ringer volume (page 38).</li> <li>• When one handset is selected to ring for cellular calls, other units do not ring. To change the selection, see page 18.</li> <li>• Night mode is turned on. Turn it off (page 44).</li> </ul>
I cannot make local calls with the handset or base unit using a cellular line.	<ul style="list-style-type: none"> <li>• You need to add your area code when making cellular calls. Store your area code in order to automatically add it to the beginning of the 7-digit phone number when making cellular calls (page 20).</li> </ul>
I cannot make or answer cellular calls with the handset or base unit.	<ul style="list-style-type: none"> <li>• Depending on the cellular phone's compatibility (page 5), you may not be able to make or answer cellular calls even if the cellular phone is connected to the base unit.</li> <li>• Make sure that the CELL indicator lights up and the cellular phone is connected to the base unit (page 19).</li> <li>• Only 2 Bluetooth devices can be used with the unit at the same time (for example, 2 cellular lines, or the headset and 1 cellular line).</li> <li>• The cellular phone is being used separately from your system.</li> </ul>
I can make and answer cellular calls but cannot hear a sound.	<ul style="list-style-type: none"> <li>• The Bluetooth technology on your cellular phone may not be functioning normally. Turn off and on your cellular phone.</li> <li>• Disconnect and reconnect the base unit AC adaptor and try again.</li> </ul>
I cannot switch cellular calls from the unit to the cellular phone.	<ul style="list-style-type: none"> <li>• Your cellular phone may not support this feature. Refer to the operating instructions of your cellular phone.</li> </ul>
I cannot make a call using the landline.	<ul style="list-style-type: none"> <li>• The dialing mode may be set incorrectly. Change the setting (page 16).</li> </ul>

## Useful Information

Problem	Cause/solution
I cannot make or answer a call.	<ul style="list-style-type: none"><li>● An outside line is being used after a cell locator feature is used.<ul style="list-style-type: none"><li>– KX-TGE260 series: To end the call, press <b>[LOCATES CELL]</b> on the base unit.</li><li>– KX-TG465SK series: To end the call if someone answers using the cellular phone, press <b>[MUTE]</b> on the base unit.</li></ul></li></ul>
I cannot use a cellular line or a landline.	<ul style="list-style-type: none"><li>● The unit can be used to talk on 2 lines at the same time (for example, 2 cellular lines, or the landline and 1 cellular line).</li></ul>
I cannot make long distance calls.	<ul style="list-style-type: none"><li>● Make sure that you have long distance service.</li></ul>

## Call Display/Talking Call Display

Problem	Cause/solution
Caller information is not displayed.	<ul style="list-style-type: none"><li>● You must subscribe to Call Display service. Contact your service provider/telephone company for details.</li><li>● If your unit is connected to any additional telephone equipment such as a Call Display box or cordless telephone line jack, plug the unit directly into the wall jack.</li><li>● If you use a DSL/ADSL service, we recommend connecting a DSL/ADSL filter between the base unit and the telephone line jack. Contact your DSL/ADSL provider for details.</li><li>● The name display service for landline calls may not be available in some areas. Contact your service provider/telephone company for details.</li><li>● Other telephone equipment may be interfering with this unit. Disconnect the other equipment and try again.</li></ul>
Caller information is displayed or announced late.	<ul style="list-style-type: none"><li>● Depending on your service provider/telephone company, the unit may display or announce the caller's information at the 2nd ring or later.</li><li>● Move closer to the base unit.</li></ul>

## Useful Information

Problem	Cause/solution
Caller information is not announced.	<ul style="list-style-type: none"> <li>• The ringer volume for landline is turned off. Adjust the ringer volume (page 40).</li> <li>• The ringer volume for cellular line is turned off. Adjust the ringer volume (page 38).</li> <li>• When one handset is selected to ring for cellular calls, other units do not announce caller information. To change the selection, see page 18.</li> <li>• The Talking Call Display feature is turned off. Turn it on (page 40).</li> <li>• The ring as cell mode is set to “On (without Talking CID)”. To change the mode, see page 18.</li> <li>• The number of rings for the answering system is set to “2 rings” or “Toll saver”. Select a different setting (page 60).</li> <li>• Your unit does not announce caller information while the other devices such as headset or handsets are engaged in a call.</li> </ul>
I cannot dial the phone number edited in the caller list.	<ul style="list-style-type: none"> <li>• The phone number you dialed might have been edited incorrectly (for example, the long distance “1” or the area code is missing). Edit the phone number with another pattern (page 50).</li> </ul>
Time on the unit has shifted.	<ul style="list-style-type: none"> <li>• Incorrect time information from incoming Call Display changes the time. Set the time adjustment to “Manual” (off) (page 40).</li> </ul>
The 2nd caller’s information is not displayed during an outside call. (Visual Call Waiting feature does not function.)	<ul style="list-style-type: none"> <li>• In order to use Call Display, Call Waiting, or Visual Call Waiting, you must first contact your service provider/ telephone company and subscribe to the desired service. After subscribing, you may need to contact your service provider/telephone company again to activate this specific service, even if you already subscribed to both Call Display and Visual Call Waiting services.</li> </ul>

## Using Bluetooth devices

Problem	Cause/solution
I cannot copy phonebook entries from a cellular phone.	<ul style="list-style-type: none"> <li>• Confirm that the cellular phone supports Bluetooth wireless technology.</li> <li>• Confirm that the cellular phone supports the Phone Book Access Profile (PBAP) or Object Push Profile (OPP) specification.</li> <li>• If the cellular phone is already connected to another Bluetooth device such as a Bluetooth headset, turn it off or disconnect it from the cellular phone.</li> <li>• Someone is using a cellular line or headset. Try again later.</li> <li>• Turn the cellular phone off, then turn it on and try again.</li> <li>• If an entry is already stored in the unit’s phonebook, the entry cannot be copied even by selecting another group.</li> </ul>

## Useful Information

Problem	Cause/solution
I cannot have a conversation using the headset.	<ul style="list-style-type: none"><li>● Confirm that the Bluetooth wireless headset supports the HeadSet Profile (HSP) specification.</li><li>● Your Bluetooth headset is not paired. Pair it (page 53).</li><li>● Turn your headset off, then turn it on and try again.</li></ul>
Noise is heard during a call on the headset.	<ul style="list-style-type: none"><li>● A Bluetooth headset can communicate with the base unit within a range of approximately 10 m (33 feet). The connection may be subject to interference from obstructions such as walls or electronic devices. Move closer to the base unit.</li></ul>
I cannot connect my headset to the base unit.	<ul style="list-style-type: none"><li>● Confirm that your headset is turned on.</li><li>● If your headset is already connected to another Bluetooth device such as your cellular phone, disconnect the headset from your cellular phone, then perform the connecting procedure from the base unit.</li><li>● Only 2 Bluetooth devices can be used with the unit at the same time (for example, 2 cellular lines, or the headset and 1 cellular line).</li><li>● The headset has not been paired to the base unit. Pair the headset (page 53).</li></ul>
Some headset enhanced features are not available.	<ul style="list-style-type: none"><li>● The base unit does not support enhanced features such as Last number redial or Call reject.</li></ul>
An error tone is heard when I try to program the Bluetooth feature.	<ul style="list-style-type: none"><li>● The Bluetooth feature cannot be accessed immediately after connecting the AC adaptor to the base unit. Wait a few seconds and try again.</li><li>● The headset has not connected to the base unit yet, even though you performed the connecting procedure setting. Wait a few seconds and try again.</li></ul>
Text message alerts are not displayed or announced.	<ul style="list-style-type: none"><li>● Confirm that the cellular phone supports the Message Access Profile (MAP) specification.</li><li>● If your smartphone does not support Message Access Profile (MAP), download the "Text Message Alert" app (page 52).</li><li>● Text message (SMS) alert is set to "On (no announce)" or "Off". Set it to "On (with name)".</li><li>● The Bluetooth device's Bluetooth notifications setting is turned off.</li><li>● The handset selected to display and/or announce alerts is in use.</li><li>● The Bluetooth device or its corresponding cellular line is in use.</li></ul>



## Useful Information

### Answering system

Problem	Cause/solution
The unit does not record new messages.	<ul style="list-style-type: none"><li>• The answering system is turned off. Turn it on (page 55).</li><li>• The answering system does not answer or record calls from cellular lines.</li><li>• The message memory is full. Erase unnecessary messages (page 56).</li><li>• The recording time is set to “<b>Greeting only</b>”. Change the setting (page 60).</li><li>• Your service provider/telephone company’s Voice Mail service may be answering your calls before the unit’s answering system can answer your calls. Change the unit’s number of rings setting (page 60) to a lower value, or contact your service provider/telephone company.</li><li>• The answering system will not answer incoming calls while the other devices such as headset or handsets are engaged in a call.</li></ul>
I cannot operate the answering system remotely.	<ul style="list-style-type: none"><li>• The remote access code is not set. Set the remote access code (page 59).</li><li>• You are entering the wrong remote access code. If you have forgotten your remote access code, enter the remote access code setting to check your current code (page 59).</li><li>• The answering system is turned off. Turn it on (page 59).</li><li>• You cannot operate the answering system when calling a cellular phone paired to the base unit.</li></ul>
The unit does not emit the specified number of rings.	<ul style="list-style-type: none"><li>• If the first ring is turned off, the number of rings decreases by 1 from the specified number of rings.</li></ul>

### Bluetooth PIN

Problem	Cause/solution
I cannot remember the PIN.	<ul style="list-style-type: none"><li>• Change the PIN using the following method.<ol style="list-style-type: none"><li><b>1</b> [MENU]#619</li><li><b>2</b> *7000</li><li><b>3</b> Enter the new 4-digit PIN. → [OK]</li><li><b>4</b> Enter the new 4-digit PIN again. → [SAVE] → [OFF]</li></ol></li></ul>

## Useful Information

---

### Voice Mail

Problem	Cause/solution
"Voice mail msg. via phone co." is shown on the handset display. How do I remove this message from the display?	<ul style="list-style-type: none"><li>• This notification is displayed when your service provider/telephone company's Voice Mail service (not the unit's answering system) has recorded a message for you. Typically you can remove this notification from the display by listening to the message. To listen to the message, dial the Voice Mail number provided by your service provider/telephone company (for most cases, this will be your own phone number), and follow the voice instructions. Depending on your service provider/telephone company, you may need to remove all messages from your voice mailbox to remove the notification. You can also remove this notification by pressing and holding <b>#</b> until the unit beeps.</li></ul>

### Liquid damage

Problem	Cause/solution
Liquid or other form of moisture has entered the handset/base unit.	<ul style="list-style-type: none"><li>• Disconnect the AC adaptor and telephone line cord from the base unit. Remove the batteries from the handset and leave to dry for at least 3 days. After the handset/base unit are completely dry, reconnect the AC adaptor and telephone line cord. Insert the batteries and charge fully before use. If the unit does not work properly, contact an authorized service centre.</li></ul>

#### Caution:

- To avoid permanent damage, do not use a microwave oven to speed up the drying process.

## Industry Canada Notices and other information

**NOTICE:**

This equipment meets the applicable Industry Canada Terminal Equipment Technical Specifications. This is confirmed by the registration number. The abbreviation, "IC:", before the registration number signifies that registration was performed based on a Declaration of Conformity indicating that Industry Canada technical specifications were met. It does not imply that Industry Canada approved the equipment.

Users should ensure, for their own protection, that the electrical ground connections of the power utility, telephone lines and internal metallic water pipe system, if present, are connected together. This precaution may be particularly important in rural areas.

**NOTICE:**

The **Ringer Equivalence Number (REN)** assigned to each terminal device provides an indication of the maximum number of terminals allowed to be connected to a telephone interface. The termination on an interface may consist of any combination of devices subject only to the requirement that the sum of the Ringer Equivalence Numbers of all the devices does not exceed 5. The Ringer Equivalence Number (REN) of this unit:  
(found on the bottom of the unit).

**NOTICE:**

Operation is subject to the following two conditions: (1) this device may not cause interference, and (2) this device must accept any interference, including interference that may cause undesired operation of the device.

Privacy of communications may not be ensured when using this telephone.

Some cordless telephones operate at frequencies that may cause interference to nearby TVs and VCRs. To minimize or prevent such interference, the base of the cordless telephone should not be placed

near, or on top of, a TV or VCR. If interference is experienced, move the cordless telephone further away from the TV or VCR. This will often reduce, or eliminate, interference.

**RF Exposure Warning:**

- This product complies with IC radiation exposure limits set forth for an uncontrolled environment.
- To comply with IC RF exposure requirements, the base unit must be installed and operated 20 cm (8 inches) or more between product and all person's body.
- This product may not be collocated or operated in conjunction with any other antenna or transmitter.
- The handset may be carried and operated with only the specific provided belt clip. Other non-tested belt clips or similar body-worn accessories may not comply and must be avoided.

## Useful Information

---

## Warranty

Panasonic Canada Inc.  
5770 Ambler Drive, Mississauga, Ontario L4W 2T3  
**PANASONIC PRODUCT - LIMITED WARRANTY**

### EXCHANGE PROGRAM

Panasonic Canada Inc. warrants this product to be free from defects in material and workmanship under normal use and for a period as stated below from the date of original purchase agrees to, at its option either (a) repair your product with new or refurbished parts, (b) replace it with a new or a refurbished equivalent value product, or (c) refund your purchase price. The decision to repair, replace or refund will be made by Panasonic Canada Inc.

#### Telephone Accessory / Product

One (1) year

This warranty is given only to the original purchaser, or the person for whom it was purchased as a gift, of a Panasonic brand product mentioned above sold by an authorized Panasonic dealer in Canada and purchased and used in Canada, which product was not sold "as is", and which product was delivered to you in new condition in the original packaging.

**IN ORDER TO BE ELIGIBLE TO RECEIVE WARRANTY SERVICE HEREUNDER, A PURCHASE RECEIPT OR OTHER PROOF OF DATE OF ORIGINAL PURCHASE, SHOWING AMOUNT PAID AND PLACE OF PURCHASE IS REQUIRED**

#### LIMITATIONS AND EXCLUSIONS

This warranty ONLY COVERS failures due to defects in materials or workmanship, and DOES NOT COVER normal wear and tear or cosmetic damage. The warranty ALSO DOES NOT COVER damages which occurred in shipment, or failures which are caused by products not supplied by Panasonic Canada Inc., or failures which result from accidents, misuse, abuse, neglect, mishandling, misapplication, alteration, faulty installation, set-up adjustments, misadjustment of consumer controls, improper maintenance, improper batteries, power line surge, lightning damage, modification, introduction of sand, humidity or liquids, commercial use such as hotel, office, restaurant, or other business or rental use of the product, or service by anyone other than a Authorized Servicer, or damage that is attributable to acts of God.

Rechargeable batteries are warranted for ninety (90) days from date of original purchase.

THIS EXPRESS, LIMITED WARRANTY IS IN LIEU OF ALL OTHER WARRANTIES, EXPRESS OR IMPLIED, INCLUDING ANY IMPLIED WARRANTIES OF MERCHANTABILITY AND FITNESS FOR A PARTICULAR PURPOSE. IN NO EVENT WILL PANASONIC CANADA INC. BE LIABLE FOR ANY SPECIAL, INDIRECT OR CONSEQUENTIAL DAMAGES RESULTING FROM THE USE OF THIS PRODUCT OR ARISING OUT OF ANY BREACH OF ANY EXPRESS OR IMPLIED WARRANTY. (As examples, this warranty excludes damages for lost time, travel to and from the Authorized Servicer, loss of or damage to media or images, data or other memory or recorded content. This list of items is not exhaustive, but for illustration only.)

In certain instances, some jurisdictions do not allow the exclusion or limitation of incidental or consequential damages, or the exclusion of implied warranties, so the above limitations and exclusions may not be applicable. This warranty gives you specific legal rights and you may have other rights which vary depending on your province or territory.

#### CONTACT INFORMATION

For product information and operation assistance, please visit our Support page:

<http://panasonic.ca/english/support>

For defective product exchange within the warranty period, please contact the original dealer.

## Index

- # 3-way conference: 24, 28
- A** Additional handset: 47
  - Alarm: 43
  - Answering calls: 22, 27
  - Answering system
    - Call screening: 60
    - Erasing messages: 56, 57, 59
    - Greeting message: 55
    - Greeting only: 60
    - Listening to messages: 56, 59
    - New message alerting: 57
    - Number of rings: 60
    - Recording time: 60
    - Remote access code: 59
    - Remote operation: 59
    - Ring count: 60
    - Toll saver: 60
    - Turning on/off: 55
  - Auto talk: 22, 41
- B** Battery: 10, 11
  - Bluetooth wireless technology
    - Cellular phone (Link to cell): 17
    - Headset: 53
    - Phonebook transfer: 51
  - Booster (Clarity booster): 23
- C** C.WTG (Call Waiting Deluxe): 48
  - Call block: 45
    - First ring: 46
  - Call Display service: 48
  - Call share: 23, 28
  - Call Waiting: 23, 28
  - Caller list: 49
  - Caller list edit: 50
  - Cell locator: 30
  - Cellular calls: 21, 27
  - Cellular phone
    - Pairing: 17
    - Unpairing: 17
  - Chain dial: 34
  - CID (Call Display): 49, 50
  - Conference calls: 24, 28
  - Control type: 12
  - Customer support: 42
- D** Date and time: 15
  - Dialing mode: 16
  - Direct command code: 36
  - Display
    - Contrast: 41
    - Language: 15
- E** Eco mode: 11
  - Equalizer: 23
  - Error messages: 66
- F** Flash: 23, 28, 42
- G** Groups: 33
- H** Handset
  - Deregistration: 47
  - Locator: 30
  - Name: 46
  - Registration: 47
  - Hold: 22, 28
- I** Intercom: 30
- K** Key detector: 41, 42
  - Key tone: 41
- L** Landline calls: 21, 27
  - Line mode: 42
  - Link to cell
    - Area code: 20
    - Auto connection: 18
    - Cellular line only mode: 19
    - Cellular line selection: 20
    - Connection: 19
    - Ring as cell mode: 18
    - Select unit to ring: 18
    - Text message (SMS: Short Message Service) alert: 52
- M** Making calls: 21, 27
  - Missed calls: 48
  - Mute: 22, 28
- N** Night mode: 44
  - Noise reduction: 23
- P** Pause: 22, 27
  - Phonebook: 32
  - PIN: 20
  - Power failure (power back-up operation): 25
  - Privacy mode: 42
- R** Redialing: 21, 27
  - Ringer ID: 33
  - Ringer tone: 38, 40
  - Rotary/pulse service: 23
- S** Smart function key (NR key): 15
  - Speed dial: 35
  - SP-PHONE (Speakerphone): 21
- T** Talking Call Display: 48
  - Temporary tone dialing: 23, 28
  - Time adjustment: 40
  - Transferring calls: 24, 28
  - Troubleshooting: 67

## ***Index***

---

- V** Visual Call Waiting: 23
- VM (Voice Mail): 62
- Voice guidance language: 15
- Voice Mail: 60, 62
- Volume
  - Receiver: 21
  - Ringer (Base unit): 28, 38, 40
  - Ringer (Handset): 22, 38, 40
  - Speaker: 21, 27
- W** Wall mounting: 63

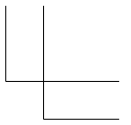
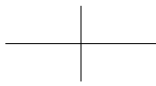
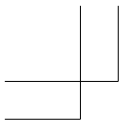

**Notes**

---

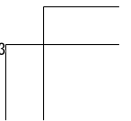
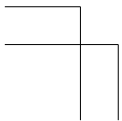
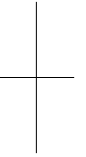
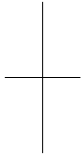

**For your future reference**

We recommend keeping a record of the following information to assist with any repair under warranty.

Serial No.	Date of purchase
(found on the bottom of the base unit)	
Name and address of dealer	
Attach your purchase receipt here.	

Panasonic Canada Inc.  
5770 Ambler Drive, Mississauga, Ontario L4W 2T3

© Panasonic System Networks Co., Ltd. 2013

Printed in Malaysia



\*PNQX6367YA\*

**PNQX6367YA** TT1213WK1034