

Panasonic[®]

Operating Instructions

Digital Cordless Answering System

Model No. **KX-TG6642C**
KX-TG6643C
KX-TG6655C

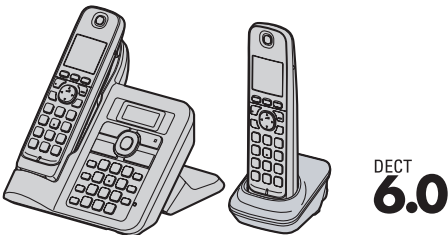

Model shown is KX-TG6642.

Before initial use, see “Getting Started” on page 9.

Thank you for purchasing a Panasonic product.

Please read these operating instructions before using the unit and save them for future reference.

This unit is compatible with Call Display. You must subscribe to the appropriate service offered by your service provider/telephone company. For assistance, please call **1-800-561-5505** or visit us at **www.panasonic.ca**

Table of Contents

Introduction	
Model composition	3
Accessory information	4
Important Information	
For your safety	6
Important safety instructions	7
For best performance	7
Other information	8
Specifications	8
Getting Started	
Setting up	9
Note when setting up	10
Intelligent eco mode	10
Controls	11
Belt clip	13
Display	13
Initial settings	13
Making/Answering Calls	
Making calls	15
Answering calls	16
Useful features during a call	17
Power back-up operation	19
Shared Phonebook	
Shared phonebook	22
Programming	
Programmable settings	25
Special programming	30
Registering a unit	32
Call Display Service	
Using Call Display service	33
Caller list	35
Answering System	
Answering system	38
Turning the answering system on/ off	38
Greeting message	39
Listening to messages using the base unit	39
Listening to messages using the handset	40
Voice memo	41
Remote operation	41
Answering system settings	42
Voice Mail Service	
Voice Mail service	44
Intercom/Locator	
Intercom	46
Handset locator	46
Transferring calls, conference calls	46
Useful Information	
Wall mounting	48
Error messages	50
Troubleshooting	51
Industry Canada Notices and other information	56
Warranty	57
Index	
Index	58

Model composition

■ KX-TG6641 series



■ KX-TG6651 series



- Model shown is KX-TG6642.
- Model shown is KX-TG6655.

Series	Model No.	Base unit	Handset	
		Part No.	Part No.	Quantity
KX-TG6641 series	KX-TG6642	KX-TG6641	KX-TGA660	2
	KX-TG6643	KX-TG6641	KX-TGA660	3
KX-TG6651 series	KX-TG6655*1	KX-TG6641	KX-TGA660	5

- *1 A range extender (KX-TGA405C) is supplied in this model. By installing this unit, you can extend the range of your phone system to include areas where reception was previously not available. Read the installation guide for the range extender.
- The suffix (C) in the following model numbers will be omitted in these instructions:
KX-TG6642C/KX-TG6643C/KX-TG6655C

Introduction

Accessory information

Supplied accessories

No.	Accessory item/Part number	Quantity		
		KX-TG6642	KX-TG6643	KX-TG6655
①	AC adaptor/PNLV226	2	3	5
②	Telephone line cord	1	1	1
③	Rechargeable batteries*1	4	6	10
④	Handset cover*2	2	3	5
⑤	Belt clip	2	3	5
⑥	Charger	1	2	4

*1 See page 4 for replacement battery information.

*2 The handset cover comes attached to the handset.

■ For KX-TG6651 series*1

No.	Accessory item/Part number	Quantity
⑦	Range extender/KX-TGA405C	1
⑧	AC adaptor for range extender/PQLV219	1

*1 KX-TG6655



Additional/replacement accessories

Please contact your nearest Panasonic dealer for sales information.

Accessory item	Order number
Rechargeable batteries	HHR-4DPA or HHR-4MRA*1
	Battery type: – Nickel metal hydride (Ni-MH) – 2 x AAA (R03) size for each handset
Headset	RP-TCA94, RP-TCA95, KX-TCA400, KX-TCA430



*1 Replacement batteries may have a different capacity from that of the supplied batteries.

Expanding your phone system

Optional handset feature overview

You can expand your phone system by registering optional handsets (6 max.) to a single base unit.

- Optional handsets may be a different colour from that of the supplied handsets.

Feature	KX-TGA660C	KX-TGA410C	KX-TGA659C
Handset			
Display size	1.8 inches	1.8 inches	1.9 inches
Button size	Large	Large	Extra large
Power back-up mode during power failure*1	●	—	—

*1 During a power failure, this feature allows you to make or receive calls by temporarily powering the unit with a charged handset placed on the base unit if both the base unit and handset have the power back-up mode.

Important Information

For your safety

To prevent severe injury and loss of life/property, read this section carefully before using the product to ensure proper and safe operation of your product.

WARNING

Power connection

- Use only the power source marked on the product.
- Do not overload power outlets and extension cords. This can result in the risk of fire or electric shock.
- Completely insert the AC adaptor/power plug into the power outlet. Failure to do so may cause electric shock and/or excessive heat resulting in a fire.
- Regularly remove any dust, etc. from the AC adaptor/power plug by pulling it from the power outlet, then wiping with a dry cloth. Accumulated dust may cause an insulation defect from moisture, etc. resulting in a fire.
- Unplug the product from power outlets if it emits smoke, an abnormal smell, or makes an unusual noise. These conditions can cause fire or electric shock. Confirm that smoke has stopped emitting and contact an authorized service centre.
- Unplug from power outlets and never touch the inside of the product if its casing has been broken open.
- Never touch the plug with wet hands. Danger of electric shock exists.

Installation

- To prevent the risk of fire or electrical shock, do not expose the product to rain or any type of moisture.
- Do not place or use this product near automatically controlled devices such as automatic doors and fire alarms. Radio waves emitted from this product may cause such devices to malfunction resulting in an accident.
- Do not allow the AC adaptor or telephone line cord to be excessively pulled, bent or placed under heavy objects.

Operating safeguards

- Unplug the product from power outlets before cleaning. Do not use liquid or aerosol cleaners.

- Do not disassemble the product.
- Do not spill liquids (detergents, cleansers, etc.) onto the telephone line cord plug, or allow it to become wet at all. This may cause a fire. If the telephone line cord plug becomes wet, immediately pull it from the telephone wall jack, and do not use.

Medical

- Consult the manufacturer of any personal medical devices, such as pacemakers or hearing aids, to determine if they are adequately shielded from external RF (radio frequency) energy. (The product operates in the frequency range of 1.92 GHz to 1.93 GHz, and the RF transmission power is 115 mW (max.))
- Do not use the product in health care facilities if any regulations posted in the area instruct you not to do so. Hospitals or health care facilities may be using equipment that could be sensitive to external RF energy.

CAUTION

Installation and location

- Never install telephone wiring during an electrical storm.
- Never install telephone line jacks in wet locations unless the jack is specifically designed for wet locations.
- Never touch uninsulated telephone wires or terminals unless the telephone line has been disconnected at the network interface.
- Use caution when installing or modifying telephone lines.
- The AC adaptor is used as the main disconnect device. Ensure that the AC outlet is installed near the product and is easily accessible.
- This product is unable to make calls when:
 - the handset batteries need recharging or have failed.
 - there is a power failure.

Battery

- We recommend using the batteries noted on page 4. **USE ONLY rechargeable Ni-MH batteries AAA (R03) size.**
- Do not mix old and new batteries.
- Do not open or mutilate the batteries. Released electrolyte from the batteries is corrosive and may cause burns or injury to the eyes or skin. The electrolyte is toxic and may be harmful if swallowed.

Important Information

- Exercise care when handling the batteries. Do not allow conductive materials such as rings, bracelets, or keys to touch the batteries, otherwise a short circuit may cause the batteries and/or the conductive material to overheat and cause burns.
- Charge the batteries provided with or identified for use with this product only, in accordance with the instructions and limitations specified in this manual.
- Only use a compatible base unit (or charger) to charge the batteries. Do not tamper with the base unit (or charger). Failure to follow these instructions may cause the batteries to swell or explode.

Attention:



A nickel metal hydride battery that is recyclable powers the product you have purchased.

Please call 1-800-8-BATTERY (1-800-822-8837) for information on how to recycle this battery.

Important safety instructions

When using your product, basic safety precautions should always be followed to reduce the risk of fire, electric shock, and injury to persons, including the following:

1. Do not use this product near water for example, near a bathtub, washbowl, kitchen sink, or laundry tub, in a wet basement or near a swimming pool.
2. Avoid using a telephone (other than a cordless type) during an electrical storm. There may be a remote risk of electric shock from lightning.
3. Do not use the telephone to report a gas leak in the vicinity of the leak.
4. Use only the power cord and batteries indicated in this manual. Do not dispose of batteries in a fire. They may explode. Check with local codes for possible special disposal instructions.

SAVE THESE INSTRUCTIONS

For best performance

Base unit location/avoiding noise

The base unit and other compatible Panasonic units use radio waves to communicate with each other.

- For maximum coverage and noise-free communications, place your base unit:
 - at a convenient, high, and central location with no obstructions between the handset and base unit in an indoor environment.
 - away from electronic appliances such as TVs, radios, personal computers, wireless devices, or other phones.
 - facing away from radio frequency transmitters, such as external antennas of mobile phone cell stations. (Avoid putting the base unit on a bay window or near a window.)
- Coverage and voice quality depends on the local environmental conditions.
- If the reception for a base unit location is not satisfactory, move the base unit to another location for better reception.

Environment

- Keep the product away from electrical noise generating devices, such as fluorescent lamps and motors.
- The product should be kept free from excessive smoke, dust, high temperature, and vibration.
- The product should not be exposed to direct sunlight.
- Do not place heavy objects on top of the product.
- When you leave the product unused for a long period of time, unplug the product from the power outlet.
- The product should be kept away from heat sources such as heaters, kitchen stoves, etc. It should not be placed in rooms where the temperature is less than 0 °C (32 °F) or greater than 40 °C (104 °F). Damp basements should also be avoided.
- The maximum calling distance may be shortened when the product is used in the following places: Near obstacles such as hills, tunnels, underground, near metal objects such as wire fences, etc.
- Operating the product near electrical appliances may cause interference. Move away from the electrical appliances.

Important Information

Routine care

- Wipe the outer surface of the product with a soft moist cloth.
- Do not use benzene, thinner, or any abrasive powder.

Other information

CAUTION: Risk of explosion if battery is replaced by an incorrect type. Dispose of used batteries according to the instructions.

Notice for product disposal, transfer, or return

- This product can store your private/confidential information. To protect your privacy/confidentiality, we recommend that you erase information such as phonebook or caller list entries from the memory before you dispose of, transfer, or return the product.

ENERGY STAR

As an ENERGY STAR® Partner, Panasonic has determined that this product meets the ENERGY STAR guidelines for energy efficiency. ENERGY STAR is a U.S. registered mark.



Compliance with TIA-1083 standard

Telephone handsets identified with this logo have reduced noise and interference when used with T-Coil equipped hearing aids and cochlear implants.



Specifications

- **Standard:**
DECT 6.0 (Digital Enhanced Cordless Telecommunications 6.0)
 - **Frequency range:**
1.92 GHz to 1.93 GHz
 - **RF transmission power:**
115 mW (max.)
 - **Power source:**
120 V AC, 60 Hz
 - **Power consumption:**
Base unit:
Standby: Approx. 0.9 W
Maximum: Approx. 3.8 W
Charger:
Standby: Approx. 0.1 W
Maximum: Approx. 2.0 W
 - **Operating conditions:**
0 °C – 40 °C (32 °F – 104 °F), 20 % – 80 % relative air humidity (dry)
- Note:**
- Design and specifications are subject to change without notice.
 - The illustrations in these instructions may vary slightly from the actual product.

Setting up

Connections

- Use only the supplied Panasonic AC adaptor PNLV226.

■ Base unit

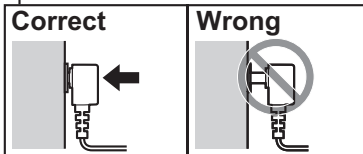
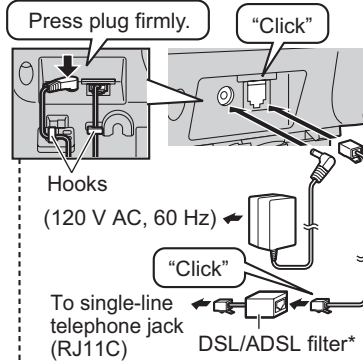

*DSL/ADSL filter (not supplied) is required if you have DSL/ADSL service.

■ Charger

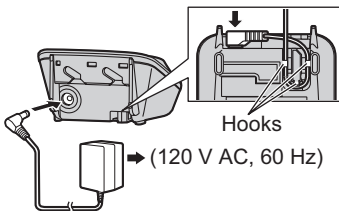

Battery installation

- USE ONLY Ni-MH batteries AAA (R03) size.
- Do NOT use Alkaline/Manganese/Ni-Cd batteries.
- Confirm correct polarities (\oplus , \ominus).

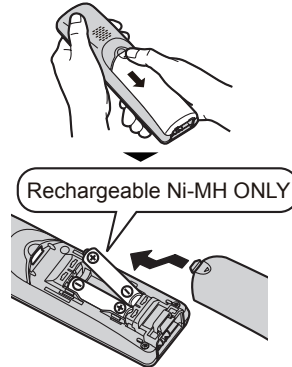

- When the language selection is displayed, see page 14.

Battery charging

Charge for about 7 hours.

- When the batteries are fully charged, the charge indicator goes off and "Fully charged" is displayed.

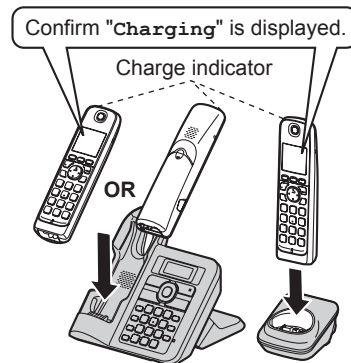

Getting Started

Note when setting up

Note for connections

- The AC adaptor must remain connected at all times. (It is normal for the adaptor to feel warm during use.)
- The AC adaptor should be connected to a vertically oriented or floor-mounted AC outlet. Do not connect the AC adaptor to a ceiling-mounted AC outlet, as the weight of the adaptor may cause it to become disconnected.





Note for battery installation

- Use the supplied rechargeable batteries. For replacement, we recommend using the Panasonic rechargeable batteries noted on page 4, 6.
- Wipe the battery ends (⊕, ⊖) with a dry cloth.
- Avoid touching the battery ends (⊕, ⊖) or the unit contacts.

Note for battery charging

- It is normal for the handset to feel warm during charging.
- Clean the charge contacts of the handset, base unit, and charger with a soft and dry cloth once a month. Clean more often if the unit is exposed to grease, dust, or high humidity.

Battery level

Icon	Battery level
	High
	Medium
	Low
	Needs charging.
	Empty

Panasonic Ni-MH battery performance (supplied batteries)

Operation	Operating time
In continuous use	13 hours max.*1
Not in use (standby)	11 days max.*1

*1 If Eco mode is on.

Note:

- Actual battery performance depends on usage and ambient environment.
- Even after the batteries are fully charged, the handset can be left on the base unit or charger without any ill effect on the batteries.
- The battery level may not be displayed correctly after you replace the batteries. In this case, place the handset on the base unit or charger and let it charge for at least 7 hours.

Intelligent eco mode

This feature automatically reduces handset power consumption by suppressing handset transmission power when the handset is close to the base unit.

- When this feature is activated, **ECO** is displayed.
- Eco mode is turned off when the clarity booster is activated (page 18).

Controls

Handset

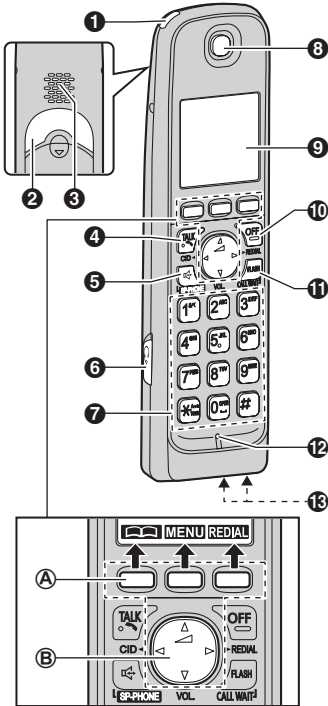

- 1** Charge indicator
Ringer indicator
Message indicator
- 2** Nonslip pad
 - Nonslip pad offers support when you cradle the handset between your shoulder and ear.
- 3** Speaker
- 4** [TALK]
- 5** [SP-PHONE: Speakerphone]
- 6** Headset jack
- 7** Dial keypad (TONE)

- 8** Receiver
- 9** Display
- 10** [OFF]
- 11** [FLASH] [CALL WAIT]
- 12** Microphone
- 13** Charge contacts

Control type

Ⓐ Soft keys

The handset features 3 soft keys. By pressing a soft key, you can select the feature shown directly above it on the display.

Ⓑ Navigator key

- [▲], [▼], [◀], or [▶]: Scroll through various lists and items.
- VOL. (Volume: [▲] or [▼]): Adjust the receiver or speaker volume while talking.
- [◀] CID (Call Display): View the caller list.
- [▶] REDIAL: View the redial list.

Getting Started

Base unit

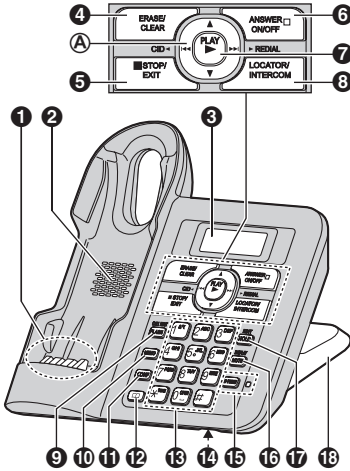

- ❶ Charge contacts
- ❷ Speaker
- ❸ Display
- ❹ [ERASE] [CLEAR]
- ❺ [■] (STOP) (EXIT)
- ❻ [ANSWER ON/OFF]
ANSWER ON/OFF indicator
- ❼ [▶] (PLAY)
Message indicator
- ❽ [LOCATOR] [INTERCOM]
- ❾ [FLASH] [CALL WAIT]
- ❿ [MEMO]
- ⓫ [CONF] (Conference)
- ⓬ [📖] (Phonebook)
- ⓭ Dial keypad (☒): TONE
- ⓮ Microphone
- ⓯ [SP-PHONE] (Speakerphone)
SP-PHONE indicator
- ⓰ [MUTE] [DISPLAY]
- ⓱ [HOLD] [EDIT]
- ⓲ Bracket*1

*1 The base unit has an unremovable bracket for desk or wall mounting. To mount on a wall, see page 48.

■ Control type

Ⓐ Navigator key

- [▲], [▼], [◀], or [▶]: Scroll through various lists and items.
- [▲] or [▼] (Volume): Adjust the speaker volume while talking.
- [◀◀] CID (Call Display): View the caller list.
- [▶▶] REDIAL: View the redial list.
- [◀◀]/[▶▶]: Repeat/skip messages during playback.

Belt clip

■ To attach

■ To remove



Display

Handset display items

Item	Meaning
	Within base unit range
	Out of base unit range
	The line is in use. <ul style="list-style-type: none"> • When flashing: The call is put on hold. • When flashing rapidly: An incoming call is now being received.
	Eco mode is on. (page 10)
	Equalizer is set. (page 18)
	Speakerphone is on. (page 15)
	Ringer volume is off. (page 27)
	Night mode is on. (page 30)
	Privacy mode is on. (page 19)
	Alarm is on. (page 30)
	Handset number
	Battery level
	Blocked call (page 31)

Item	Meaning
	Clarity booster is on. (page 18)
In use	Answering system is being used by another handset or the base unit.
Line in use	Someone is using the line.

Base unit display items

Item	Meaning
	Ringer volume is off. (page 17)
	Privacy mode is on. (page 19)
In use	Answering system is being used by a handset.
Line in use	Someone is using the line.
	Answering system answers calls with a greeting message and caller messages are not recorded. ("Selecting Greeting only ", page 43)

Initial settings

■ Direct command code:

Programmable settings can be accessed by pressing **[MENU]**, **#** and then the corresponding code on the dial keypad (page 25).

Example: Press **[MENU]** **#** **1** **0** **1**.

■ Symbol meaning:

Symbol	Meaning
	Perform with the handset.
	Perform with the base unit.

Getting Started

Symbol	Meaning
Example: [↕]: "off"	Press [▼] or [▲] to select the words in quotations.

Important:

- When you install the batteries for the first time, the handset may prompt you to set display language and date and time.
 - ① Perform step 2 in "Display language", page 14, and then press [SELECT].
 - ② Continue from step 2 in "Date and time", page 14.

Display language

You can select either "English" or "Français" as the display language. The default setting is "English".

Handset

- 1 [MENU]#1110
- 2 [↕]: Select the desired setting. → [SAVE]
- 3 [OFF]

Base unit

- 1 [DISPLAY]
- 2 [↕]: "Change language" → [▶]
- 3 [↕]: Select the desired setting. → [▶]

Date and time

- 1 [MENU]#1011
- 2 Enter the current month, date, and year by selecting 2 digits for each.
Example: July 15, 2011
07 15 11
- 3 [OK]

- 4 Enter the current hour and minute (12-hour clock format) by selecting 2 digits for each.

Example: 9:30

09 30

- 5 [AM/PM]: Select "AM" or "PM".
- 6 [SAVE] → [OFF]

Note:

- When English is selected as the display language, 12-hour clock format is used. When French is selected, 24-hour clock format is used.
- The date and time may be incorrect after a power failure. In this case, set the date and time again.

Voice guidance language

You can select either "English" or "Français" as the voice guidance language of the answering system. The default setting is "English".

- 1 [MENU]#1112
- 2 [↕]: Select the desired setting.
- 3 [SAVE] → [OFF]

Dialing mode

If you cannot make calls, change this setting according to your telephone line service. The default setting is "Tone".
"Tone": For tone dial service.
"Pulse": For rotary/pulse dial service.

- 1 [MENU]#120
- 2 [↕]: Select the desired setting.
- 3 [SAVE] → [OFF]

Making calls

Using the handset

- 1 Lift the handset and dial the phone number.
 - To correct a digit, press **[CLEAR]**.
- 2 Press **[↶]** or **[CALL]**.
- 3 When you finish talking, press **[OFF]** or place the handset on the base unit or charger.

Using the speakerphone

- 1 Dial the phone number and press **[☎]**.
 - Speak alternately with the other party.
- 2 When you finish talking, press **[OFF]**.

Note:

- For best performance, use the speakerphone in a quiet environment.
- To switch back to the receiver, press **[☎]/[↶]**.

Adjusting the receiver or speaker volume

Press **[▲]** or **[▼]** repeatedly while talking.

Making a call using the redial list

The last 5 phone numbers dialed are stored in the redial list (each 48 digits max.).

- 1 **[REDIAL]** or **[▶]** REDIAL
 - If there is a new message in the Voice Mail or answering system, **[REDIAL]** is not displayed.
- 2 **[↕]**: Select the desired phone number.
- 3 **[↶]**

Erasing a number in the redial list

- 1 **[REDIAL]** or **[▶]** REDIAL
- 2 **[↕]**: Select the desired phone number. → **[ERASE]**
- 3 **[↕]**: "Yes" → **[SELECT]**
- 4 **[OFF]**

Using the base unit

- 1 Dial the phone number.
- 2 **[SP-PHONE]**
- 3 When the other party answers, speak into the microphone.
 - Speak alternately with the other party.
- 4 When you finish talking, press **[SP-PHONE]**.

Note:

- For best performance, use the speakerphone in a quiet environment.
- While on a call, you can switch from the base unit to the handset:
 - Press **[↶]** on the handset, then press **[SP-PHONE]** on the base unit with the privacy mode off (page 28).
 - If the handset is on the base unit, simply lift it.

Adjusting the speaker volume

Press **[▲]** or **[▼]** repeatedly while talking.

Making a call using the redial list

The last 10 phone numbers dialed are stored in the redial list (each 48 digits max.).

- 1 **[▶▶]** REDIAL
- 2 **[↕]**: Select the desired phone number.
- 3 **[SP-PHONE]**

Making/Answering Calls

Erasing a number in the redial list

- 1 [▶▶] REDIAL
- 2 [↕]: Select the desired phone number. → [ERASE]
- 3 [↕]: "Yes" → [▶]
- 4 [■] (EXIT)

Pause (for PBX/long distance service users)

A pause is sometimes required when making calls using a PBX or long distance service. When storing a calling card access number and/or PIN in the phonebook, a pause is also needed (page 24).

Example: If you need to dial the line access number "9" when making outside calls with a PBX:

Handset

- 1 [9] → [PAUSE]
- 2 Dial the phone number. → [↶]

Base unit

- 1 [9] → [CONF]
- 2 Dial the phone number. → [SP-PHONE]

Note for handset and base unit:

- A 3.5 second pause is inserted each time [PAUSE] on the handset or [CONF] on the base unit is pressed. Repeat as needed to create longer pauses.

Answering calls

Using the handset

When a call is being received, the ringer indicator flashes rapidly.

- 1 Lift the handset and press [↶] or [↷] when the unit rings.
 - You can also answer the call by pressing any dial key from [0] to [9], [✖], or [#]. (**Any key answer feature**)
- 2 When you finish talking, press [OFF] or place the handset on the base unit or charger.

Auto talk

You can answer calls simply by lifting the handset off the base unit or charger. You do not need to press [↶]. To turn this feature on, see page 27.

Adjusting the handset ringer volume

■ While the handset is ringing for an incoming call:

Press [▲] or [▼] repeatedly to select the desired volume.

■ Programming the volume beforehand:

- 1 [MENU]#160
- 2 [↕]: Select the desired volume.
- 3 [SAVE] → [OFF]

Temporary handset ringer off

While the handset is ringing for a call, you can turn the ringer off temporarily by pressing [✖].

Using the base unit

When a call is being received, the SP-PHONE indicator flashes rapidly.

- 1 Press [SP-PHONE] when the unit rings.
- 2 Speak into the microphone.
- 3 When you finish talking, press [SP-PHONE].

Adjusting the base unit ringer volume

Press **[▲]** or **[▼]** repeatedly to select the desired volume.

- To turn the ringer off, press and hold **[▼]** until the unit beeps.

Note:

- Even when the ringer volume is set to off, the base unit still rings for intercom calls (page 46).

Useful features during a call

Hold

This feature allows you to put an outside call on hold.

Handset

- 1 Press **[MENU]** during an outside call.
- 2 **[↕]**: “Hold” → **[SELECT]**
- 3 To release hold, press **[↶]**.
 - Another handset user can take the call by pressing **[↶]**.
 - The base unit user can take the call by pressing **[SP-PHONE]**.

Base unit

- 1 Press **[HOLD]** during an outside call.
- 2 To release hold, press **[SP-PHONE]**.
 - A handset user can take the call by pressing **[↶]**.

Note for handset and base unit:

- If a call is kept on hold for more than 9 minutes, an alarm tone starts to sound and the ringer indicator on the handset flashes rapidly. After 1 additional minute on hold, the call is disconnected.

- If another phone is connected to the same line, you can also take the call by lifting its handset.
- While an outside call is on hold, the SP-PHONE indicator on the base unit flashes.

Mute

While mute is turned on, you can hear the other party, but the other party cannot hear you.

Handset

- 1 Press **[MUTE]** during conversation.
 - **[MUTE]** flashes.
- 2 To return to the conversation, press **[MUTE]** again.

Note:

- **[MUTE]** is a soft key visible on the handset display during a call.

Base unit

- 1 Press **[MUTE]** during conversation.
 - The SP-PHONE indicator flashes.
- 2 To return to the conversation, press **[MUTE]** again.

Flash

Handset / Base unit

[FLASH] allows you to use the special features of your host PBX such as transferring an extension call, or accessing optional telephone services.

Note:

- To change the flash time, see page 28.

For Call Waiting or Visual Call Waiting service users

To use Call Waiting or Visual Call Waiting, you must first subscribe with

Making/Answering Calls

your service provider/telephone company.

This feature allows you to receive calls while you are already talking on the phone. If you receive a call while on the phone, you will hear a Call Waiting tone. **If you subscribe to both Call Display and Visual Call Waiting services**, the 2nd caller's information is displayed on the handset or base unit that is in use after you hear the Call Waiting tone.

Handset / Base unit

- 1 Press **[CALL WAIT]** to answer the 2nd call.
- 2 To switch between calls, press **[CALL WAIT]**.

Note:

- Please contact your service provider/telephone company for details and availability of this service in your area.

Temporary tone dialing (for rotary/pulse service users)

You can temporarily switch the dialing mode to tone when you need to access touch-tone services (for example, answering services, telephone banking services, etc.).

Handset / Base unit

Press **[TONE]** before entering access numbers which require tone dialing.

Handset clarity booster

This feature can improve sound clarity when the handset is used in an area where there may be interference. During an outside call, this feature is turned on automatically when necessary.

- When this feature is turned on, **[BOOST]** is displayed.

Handset equalizer

This feature clarifies the voice of the person you are talking to, producing a more natural-sounding voice that is easier to hear and understand.

- 1 Press **[MENU]** while talking.
- 2 **[↕]**: "Equalizer" → **[SELECT]**
- 3 **[↕]**: Select the desired setting.
- 4 Press **[OK]** to exit.

Note:

- When this feature is activated, **[EQ]** is displayed while talking.
- Depending on the condition and quality of your telephone line, this feature may emphasize existing line noise. If it becomes difficult to hear, turn this feature off.
- This feature is not available while using the speakerphone.

Call share

You can join an existing outside call.

Important:

- When the privacy mode is on, you cannot join the conversation. Turn it off.

Handset

To join the conversation, press **[↶]** when the other unit is on an outside call.

Base unit

To join the conversation, press **[SP-PHONE]** when the handset is on an outside call.

Note for handset and base unit:

- A maximum of 4 parties (including 1 outside party) can join a conversation using 3 extensions. **(4-way conference)**

Privacy mode

When the privacy mode is “on”, the unit prevents other users from joining your conversations with outside callers. To allow other users to join your conversations (call share), leave this feature off. The default setting is “off”.

1 [MENU]#194

2 [↕]: Select “on” or “off”.



3 [SAVE] → [OFF]

- When the privacy mode is turned on, **PRIV** is displayed during an outside call.

Power back-up operation

When a power failure occurs, the charged handset temporarily supplies power to the base unit (power back-up mode). This allows you to make and receive calls using a handset during a power failure. The base unit will not perform any other functions. However, some functions such as Call Display and shared phonebook are available only when using a handset other than the handset supplying power to the base unit. You can program “Power failure” and the default setting is “Auto” (page 28).

Important:

- If a handset is not placed on the base unit when a power failure occurs, “Base no power Press OFF” is displayed. After pressing [OFF] on the handset, place it on the base unit to start power back-up mode.
- Power back-up mode will not work if the battery level of the power supplying handset is  or .

- Do not lift the power supplying handset from the base unit during power back-up mode.
- Do not touch the handset's charge contacts during power back-up mode.
- If the battery level is low, the unit will not work sufficiently during power back-up mode. In addition, in case handset battery power runs out, we recommend connecting a corded-type telephone (without AC adaptor) to the same telephone line or to the same telephone line jack using a T-adaptor.

Panasonic Ni-MH battery performance (supplied batteries) during power back-up mode

When the batteries are fully charged, operating time of the handset in power back-up mode varies depending on usage.

- Continuous use of the handset in power back-up mode: 2 hours max.
- Continuous use of the handset other than a handset in power back-up mode: 3 hours max.
- Not in use in power back-up mode: 3 hours max.

Note:

- Actual battery performance depends on usage and ambient environment.

Making calls during a power failure

■ When only 1 handset is registered:

- 1** Lift the handset and dial the phone number.
- 2** Within 1 minute, place the handset on the base unit.
 - Wait until speakerphone is turned on automatically and the call is made.
- 3** When the other party answers the call, keep the handset on the

Making/Answering Calls

base unit and talk using the speakerphone.

- 4 When you finish talking, press **[OFF]**.

Note:

- In step 2, if you do not place the handset on the base unit within 1 minute, the power back-up mode turns off. In this case, press **[OFF]** on the handset and dial the phone number. Then try again from step 2.

■ When 2 or more handsets are registered:

You should leave one handset on the base unit for supplying the power, and use another handset for making calls. For the operation, please see "Making calls", page 15.

Note:

- During a call with the handset placed on the base unit (power back-up mode), the call may be disconnected if you touch the handset. In such case, try to call back.
- The range of the base unit is limited during a power failure. Please use the handset close to the base unit.

Making a call using the redial list

■ When only 1 handset is registered:

- 1 Lift the handset.
- 2 **[REDIAL]** or **[▶] REDIAL**
- 3 **[↕]**: Select the desired phone number.
- 4 Within 1 minute, place the handset on the base unit.
 - Wait until speakerphone is turned on automatically and the call is made.

■ When 2 or more handsets are registered:

You should leave one handset on the base unit for supplying the power, and use another handset for making calls.

For the operation, please see "Making a call using the redial list", page 15.

Making a call using the shared phonebook

Only when 2 or more handsets are registered to the base unit, you can use the shared phonebook feature during a power failure.

You should leave one handset on the base unit for supplying the power, and use another handset for making calls. For the operation, please see "Finding and calling from a phonebook entry", page 23.

Answering calls during a power failure

■ When only 1 handset is registered:

- 1 When the unit rings, keep the handset on the base unit and press **[📞]** or **[📞]**.
 - Speakerphone is turned on.
- 2 When you finish talking, press **[OFF]**.

■ When 2 or more handsets are registered:

When the unit rings, use a handset which is not supplying power to the base unit. For the operation, please see "Answering calls", page 16.

- Do not use or lift the handset which is placed on the base unit during power back-up mode.

Note:

- During a call with the handset placed on the base unit (power back-up

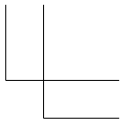
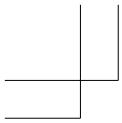

Making/Answering Calls

mode), the call may be disconnected if you touch the handset. In such case, try to call back.

- The range of the base unit is limited during a power failure. Please use the handset close to the base unit.

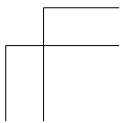
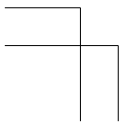
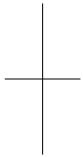

Shared Phonebook

Shared phonebook

The shared phonebook allows you to make calls without having to dial manually. The base unit and any handset registered to the base unit can use the shared phonebook. You can add 50 names and phone numbers to the shared phonebook, and assign each phonebook entry to the desired group.

Important:

- Only 1 person can access the shared phonebook at a time.
- Call Display subscribers can use group ringer tone features (page 34).

Adding entries

Handset

- 1 **[📞]** → **[ADD]**
- 2 Enter the party's name (16 characters max.). → **[OK]**
- 3 Enter the party's phone number (24 digits max.). → **[OK]**
- 4 **[↕]**: Select the desired group. → **[SELECT]** 2 times
 - To add other entries, repeat from step 2.
- 5 **[OFF]**

Character table for entering names

While entering characters, you can switch between uppercase and lowercase by pressing **[↔]** (A→a).

Key	Character
[1]	& ' () * , - . / 1
[2]	A B C 2
	a b c 2
[3]	D E F 3
	d e f 3

Key	Character
[4]	G H I 4
	g h i 4
[5]	J K L 5
	j k l 5
[6]	M N O 6
	m n o 6
[7]	P Q R S 7
	p q r s 7
[8]	T U V 8
	t u v 8
[9]	W X Y Z 9
	w x y z 9
[0]	_ 0
[#]	#

- To enter another character that is located on the same dial key, first press **[▶]** to move the cursor to the next space.
- If you do not press any dial key within 5 seconds after entering a character, the character is fixed and the cursor moves to the next space.
- _ in the above table represents a single space.

Erasing the character or number

Press **[◀]** or **[▶]**. → **[CLEAR]**

- Press and hold **[CLEAR]** to erase all characters or numbers.

Groups





Groups can help you find entries in the phonebook quickly and easily. When adding an entry to the phonebook, you can assign it to one of 9 groups. You can change the names of groups assigned for phonebook entries ("Friends", "Family", etc.) and then search for phonebook entries by group. The group ringer tone feature is

available for Call Display subscribers (page 34).

Changing group names

The default group name is "Group 1" to "Group 9".



Handset

- 1  → [MENU]
- 2 : "Group" → [SELECT]
- 3 : Select the desired group. → [SELECT]
- 4 : "Group name" → [SELECT]
- 5 Edit the name (10 characters max.; page 22). → [SAVE]
- 6 [OFF]

Finding and calling from a phonebook entry

Scrolling through all entries



Handset / Base unit

- 1 ]
- 2 : Select the desired entry.
- 3 Proceed with the operation for your unit.
Handset: 
Base unit: [SP-PHONE]

Searching by first character





Handset / Base unit

- 1 ]
- 2 Press the dial key ([0] – [9] or [#]) which contains the character you are searching for (page 22).
 - Press the same dial key repeatedly to display the first entry corresponding to each character located on that dial key.
 - If there is no entry corresponding to the character you selected, the next entry is displayed.



- 3 : Scroll through the phonebook if necessary.
- 4 Proceed with the operation for your unit.
Handset: 
Base unit: [SP-PHONE]

Searching by group

Handset

- 1 ] → [GROUP]
- 2 : Select the group you want to search. → [SELECT]
 - If you select "All groups", the unit ends the group search.
- 3 : Select the desired entry.
- 4 

Base unit

- 1 ] 2 times
- 2 : Select the group you want to search. → [▶]
 - If you select "All groups", the unit ends the group search.
- 3 : Select the desired entry.
- 4 [SP-PHONE]

Editing entries

Handset

- 1 Find the desired entry (page 23). → [EDIT]
- 2 Edit the name if necessary (16 characters max.; page 22). → [OK]
- 3 Edit the phone number if necessary (24 digits max.). → [OK]
- 4 : Select the desired group (page 22). → [SELECT] 2 times
- 5 [OFF]

Shared Phonebook

Erasing entries

Erasing an entry

Handset

- 1 Find the desired entry (page 23).
- 2 **[ERASE]** → **[↕]**: “Yes”
- 3 **[SELECT]** → **[OFF]**

Base unit

- 1 Find the desired entry (page 23).
- 2 **[ERASE]** → **[↕]**: “Yes”
- 3 **[▶]** → **[■]** (EXIT)

Erasing all entries

Handset

- 1 **[📖]** → **[MENU]**
- 2 **[↕]**: “Erase all” → **[SELECT]**
- 3 **[↕]**: “Yes” → **[SELECT]**
- 4 **[↕]**: “Yes” → **[SELECT]**
- 5 **[OFF]**

Base unit

- 1 **[📖]** → **[ERASE]**
- 2 **[↕]**: “Yes” → **[▶]**
- 3 **[↕]**: “Yes” → **[▶]**

Chain dial

This feature allows you to dial phone numbers in the phonebook while you are on a call. This feature can be used, for example, to dial a calling card access number or bank account PIN that you have stored in the phonebook, without having to dial manually.

Handset / Base unit

- 1 Proceed with the operation for your unit.
During an outside call:
Handset: **[MENU]** → **[↕]**: “Phonebook” → **[SELECT]**
Base unit: **[📖]**
- 2 **[↕]**: Select the desired entry.
- 3 Proceed with the operation for your unit.
Handset: Press **[CALL]** to dial the number.
Base unit: Press **[▶]** to dial the number.

Note:

- When storing a calling card access number and your PIN in the phonebook as one phonebook entry, press **[PAUSE]** to add pauses after the number and PIN as necessary (page 16).
- If you have rotary/pulse service, you need to press **[☒]** (TONE) before pressing **[MENU]** on the handset or **[📖]** on the base unit in step 1 to change the dialing mode temporarily to tone. When adding entries to the phonebook, we recommend adding **[☒]** (TONE) to the beginning of phone numbers you wish to chain dial (page 22).

Programmable settings

You can customize the unit by programming the following features using the handset. To access the features, there are 2 methods:

■ Scrolling through the display menus

- 1 **[MENU]**
- 2 Press **[▼]** or **[▲]** to select the desired main menu. → **[SELECT]**
- 3 Press **[▼]** or **[▲]** to select the desired item from the next sub-menus. → **[SELECT]**
- 4 Press **[▼]** or **[▲]** to select the desired setting. → **[SAVE]**
 - This step may vary depending on the feature being programmed.
 - To exit the operation, press **[OFF]**.

■ Using the direct command code

- 1 **[MENU]** → Enter the desired code.
Example: Press **[MENU][#][1][0][1]**.
- 2 Select the desired setting. → **[SAVE]**
 - This step may vary depending on the feature being programmed.
 - To exit the operation, press **[OFF]**.

Note:

- In the following table, < > indicates the default settings.
- In the following table,  indicates the reference page number.
- Display menu order and sub-menu may vary depending on your model.

Display the menu tree and direct command code table

Main menu:  "Caller list"

Operation	Code	
Viewing the caller list.	#213	36

Main menu:  "Answering device"

Sub-menu 1	Sub-menu 2	Settings	Code	
Play new msg. (msg.: message)	–	–	#323	40
Play all msg.	–	–	#324	40
Erase all msg.*1	–	–	#325	41

Programming

Sub-menu 1	Sub-menu 2	Settings	Code	
Greeting	Record greeting* ¹	–	#302	39
	Check greeting	–	#303	39
	Pre-recorded* ¹ (Reset to pre-recorded greeting)	–	#304	39
Settings	Ring count* ¹	2-7: 2-7 rings <4 rings> 0: Toll saver	#211	42
	Recording time* ¹	1: 1 min 3: <3 min> 0: Greeting only* ²	#305	43
	Remote code* ¹	<111>	#306	41
	Screen call	1: <On> 0: Off	#310	38
Answer on* ¹	–	–	#327	38
Answer off* ¹	–	–	#328	38

Main menu:  “V.M. access” (V.M.: Voice Mail)

Operation	Code	
Listening to Voice Mail messages.	#330	45

Main menu:  “Intercom”

Operation	Code	
Paging the desired unit.	#274	46

Main menu:  “Set date & time”

Sub-menu 1	Sub-menu 2	Settings	Code	
Date and time* ¹	–	–	#101	14
Alarm	–	1: Once 2: Daily 0: <Off>	#720	30
Time adjustment* ^{1, *3}	–	1: <Caller ID auto> 0: Manual	#226	–

Programming

Main menu:  "Initial setting"

Sub-menu 1	Sub-menu 2	Settings	Code	
Ringer setting	Ringer volume* ⁴ (Handset)	0-6: Off-6 <6>	#160	16
	Ringer tone* ^{5, *6, *7} (Handset)	1-5: Tone 1-5 <Tone 1> 6-0: Melody 1-5	#161	-
	Night mode - On/Off	1: On 0: <Off>	#238	30
	Night mode - Start/End	<11:00 PM/06: 00 AM>	#237	30
Set date & time	Date and time* ¹	-	#101	14
	Alarm	1: Once 2: Daily 0: <Off>	#720	30
	Time adjustment* ^{1, *3}	1: <Caller ID auto> 0: Manual	#226	-
Talking Caller ID (Talking Call Display)	Handset	1: <On> 0: Off	#162	33
	Base unit* ¹	1: On 0: <Off>	#*162	
Handset name	-	-	#104	31
Call block* ¹	-	-	#217	31
	Block w/o num* ^{1, *2} (Block calls without phone number)	1: On 0: <Off>	#240	31
Voice mail	Store VM access#* ¹ (VM: Voice Mail)	-	#331	44
	VM tone detect* ¹	1: <On> 0: Off	#332	45
Message alert	-	1: <On> 0: Off	#340	43
LCD contrast* ⁸ (Display contrast)	-	1-6: Level 1-6 <3>	#145	-
Key tone* ⁹	-	1: <On> 0: Off	#165	-
Auto talk* ¹⁰	-	1: On 0: <Off>	#200	16

Programming

Sub-menu 1	Sub-menu 2	Settings	Code	
Set tel line	Set dial mode*1	1: Pulse 2: <Tone>	#120	14
	Set flash time*1,*11	0: 900 ms 1: <700 ms> 2: 600 ms 3: 400 ms 4: 300 ms 5: 250 ms *: 200 ms #: 160 ms 6: 110 ms 7: 100 ms 8: 90 ms 9: 80 ms	#121	17
	Set line mode*1,*12	1: A 2: 	#122	–
	C. WTG options*1 (Call Waiting Deluxe options)	1: On 0: <Off>	#215	34
Privacy mode*1	–	1: On 0: <Off>	#194	19
Registration	Register handset	–	#130	32
	Deregistration*2	–	#131	32
Power failure	–	1: <Auto> 0: Off	#152	19
Change language	Display (Handset)	1: <English> 2: Français	#110	14
	Voice prompt*1	1: <English> 2: Français	#112	14

Main menu:  "Customer support"*13

Operation	Code	
Displaying customer support Web address.	#680	–

- *1 If you program these settings using one of the handsets, you do not need to program the same item using another handset.
- *2 This menu is not displayed when scrolling through the display menus. It is only available in direct command code.
- *3 This feature allows the unit to automatically adjust the date and time each time caller information including date and time is received.
To turn this feature on, select "Caller ID auto". To turn this feature off, select "Manual". (Call Display subscribers only)
To use this feature, set the date and time first (page 14).
- *4 Ringer volume cannot be turned off for alarm, intercom calls, and paging.

Programming

- *5 If you subscribe to a distinctive ring service, select a tone (tone 1 to 5). If you select a melody, you cannot distinguish lines by their ringers.
- *6 If you select one of the melody ringer tones, the ringer tone continues to play for several seconds even if the caller has already hung up. You may either hear a dial tone or no one on the line when you answer the call.
- *7 The preset melodies in this product are used with permission of © 2009 Copyrights Vision Inc.
- *8 Base unit
You can adjust the contrast of the base unit display by performing the following operation.
[DISPLAY] → **[↕]**: "Contrast" → **[▶]** → **[↕]**: Select the desired setting.
→ **[▶]**
- *9 Turn this feature off if you prefer not to hear key tones while you are dialing or pressing any keys, including confirmation tones and error tones.
- *10 If you subscribe to a Call Display service and want to view the caller's information after lifting up the handset to answer a call, turn off this feature.
- *11 The flash time depends on your telephone exchange or host PBX. Contact your PBX supplier if necessary.
- *12 Generally, the line mode setting should not be changed. This setting automatically maintains receiver volume at the proper level depending on the current telephone line condition. Set the line mode to "A" if telephone line condition is not good.
- *13 The handset can display the Internet address where you can download the operating instructions or get further information for this product, using your computer.

Programming

Special programming

Alarm

An alarm sounds at the set time for 3 minutes once or daily. Alarm can be set for each handset.

Important:

- Set the date and time beforehand (page 14).

- 1 **[MENU]** **#** **7** **2** **0**
- 2 **[↕]**: Select the desired alarm option.
→ **[SELECT]**

Off	Turns alarm off. Go to step 7.
Once	An alarm sounds once at the set time.
Daily	An alarm sounds daily at the set time. Go to step 4.

- 3 Enter the desired month and date.
→ **[OK]**
- 4 Set the desired time.
- 5 **[AM/PM]**: Select “**AM**” or “**PM**”. → **[OK]**
- 6 **[↕]**: Select the desired alarm tone.
→ **[SELECT]**
 - We recommend selecting a different ringer tone from the one used for outside calls.
- 7 **[SELECT]** → **[OFF]**
 - When the alarm is set, ☎ is displayed.

Note:

- To stop the alarm, press **[OFF]** or place the handset on the base unit or charger.
- When the handset is in use, the alarm will not sound until the handset is in standby mode.

Night mode

Night mode allows you to select a period of time during which the handset will not ring for outside calls. This feature is useful for time periods when you do not want to be disturbed, for example, while sleeping. Night mode can be set for each handset.

Important:

- Set the date and time beforehand (page 14).
- We recommend turning the base unit ringer off (page 17) in addition to turning the night mode on.
- If you have set the alarm, the alarm sounds even if the night mode is turned on.

Turning night mode on/off

- 1 **[MENU]** **#** **2** **3** **8**
- 2 **[↕]**: Select the desired setting. → **[SAVE]**
 - If you select “**Off**”, press **[OFF]** to exit.
- 3 Enter the desired hour and minute you wish to start this feature.
- 4 **[AM/PM]**: Select “**AM**” or “**PM**”. → **[OK]**
- 5 Enter the desired hour and minute you wish to end this feature.
- 6 **[AM/PM]**: Select “**AM**” or “**PM**”.
- 7 **[SAVE]** → **[OFF]**
 - When the night mode is set, 🌙 is displayed.

Changing the start and end time

- 1 **[MENU]** **#** **2** **3** **7**
- 2 Continue from step 3, “Turning night mode on/off”, page 30.

Changing the handset name

Each handset can be given a customized name ("Bob", "Kitchen", etc.). This is useful when you make intercom calls between handsets. You can also select whether or not the handset name is displayed in standby mode. The default setting is "No". If you select "Yes" without entering any handset name, "Handset 1" to "Handset 6" is displayed.

- 1 **[MENU]** **#** **1** **0** **4**
- 2 Enter the desired name (max. 10 characters; see the character table, page 22).
 - If not required, go to step 3.
- 3 **[SAVE]**
- 4 **[↕]**: Select the desired setting. → **[SELECT]** 2 times
- 5 **[OFF]**

Call block (Call Display subscribers only)

This feature allows the unit to reject calls when:

- the unit receives a call from a phone number stored in the call block list as unwanted ("Storing unwanted callers", page 31).
- the unit receives a call without phone number ("Blocking incoming calls without phone number", page 31).

When a call is received, the unit rings for a short time while the caller is being identified. If the phone number matches an entry in the call block list, the unit sends out a busy tone to the caller, and then disconnects the call.

Important:

- When the unit receives a call from a number that is stored in the call block list or a call without a recognized phone number, the call is logged in

the caller list (page 35) with **↵** after the call is disconnected.

Storing unwanted callers

You can store up to 30 phone numbers in the call block list.

Important:

- We recommend storing 10 digits (including an area code). If only 7 digits are stored, all numbers that have the same last 7 digits will be blocked.

■ From the caller list:

- 1 **[←]** CID
- 2 **[↕]**: Select the entry to be blocked.
 - To edit the number, press **[EDIT]** repeatedly until the phone number is shown in the 10-digit format.

- 3 **[SAVE]**

- 4 **[↕]**: "Call block" → **[SELECT]**

- 5 **[↕]**: "Yes" → **[SELECT]**

- 6 Edit the phone number if necessary (24 digits max.).

- 7 **[SAVE]** → **[OFF]**

■ By entering phone numbers:

- 1 **[MENU]** **#** **2** **1** **7** → **[ADD]**
- 2 Enter the phone number (24 digits max.).
 - To erase a digit, press **[CLEAR]**.
- 3 **[SAVE]** → **[OFF]**

Blocking incoming calls without phone number

You can reject a call when no phone number is provided, such as a call just showing "Unavailable".

- 1 **[MENU]** **#** **2** **4** **0**

Programming

- 2 [↕]: Select the desired setting. → [SAVE] → [OFF]

Viewing/editing/erasing call block numbers

- 1 [MENU]#217
- 2 [↕]: Select the desired entry.
 - To exit, press [OFF].
- 3 **To edit a number:**
[EDIT] → Edit the phone number.
→ [SAVE] → [OFF]
To erase a number:
[ERASE] → [↕]: “Yes” → [SELECT] → [OFF]

Note:

- When editing, press the desired dial key to add, [CLEAR] to erase.
- When viewing, “Block w/o num” is displayed if the blocking incoming calls without phone number feature is turned on. To turn the feature off: [ERASE] → [v] → [SAVE] → [OFF]

Registering a unit

Operating additional units

Additional handsets

Up to 6 handsets can be registered to the base unit.

Important:

- See page 5 for information on the available model.

Registering a handset to the base unit

The supplied handset and base unit are pre-registered. If for some reason the handset is not registered to the base unit, re-register the handset.

- 1 **Handset:**
[MENU]#130

- 2 **Base unit:**
Press and hold [LOCATOR] for about 5 seconds until the registration tone sounds.
 - If all registered handsets start ringing, press [LOCATOR] again to stop, then repeat this step.
 - The next step must be completed within 90 seconds.

- 3 **Handset:**
Press [OK], then wait until a long beep sounds.

Note:

- While registering, “Base in registering” is displayed on all registered handsets.
- When you purchase an additional handset, refer to the additional handset’s installation manual for registration.

Deregistering a handset

A handset can cancel its own registration to the base unit, or other handsets registered to the same base unit. This allows the handset to end its wireless connection with the system.

- 1 [MENU]#131
 - All handsets registered to the base unit are displayed.
- 2 [↕]: Select the handset you want to cancel. → [SELECT]
- 3 [↕]: “Yes” → [SELECT]
- 4 [OFF]

Using Call Display service

Important:

- This unit is Call Display compatible. To use Call Display features, you must subscribe to a Call Display service. Contact your service provider/telephone company for details.

Call Display features

Handset / Base unit

When an outside call is being received, the caller's name and phone number are displayed.

Caller information for the last 50 callers is logged in the caller list from the most recent call to the oldest.

- If the unit cannot receive caller information, the following is displayed:
 - “Unavailable”^{*1}/
“Unavailable Name & No.”^{*2}:
The caller dials from an area which does not provide a Call Display service.
 - “Private caller”: The caller requests not to send caller information.
 - “Long distance”: The caller makes a long distance call.
- If the unit is connected to a PBX system, caller information may not be properly received. Contact your PBX supplier.

*1 Handset

*2 Base unit

Missed calls

Handset / Base unit

If a call is not answered, the unit treats it as a missed call. The display shows “Missed call”. This lets you know if

you should view the caller list to see who called while you were away.

Note:

- Even when there are unviewed missed calls, “Missed call” disappears from the standby display if the following operation is performed by one of the units:
 - A handset is replaced on the base unit or charger.
 - Pressing [OFF] on a handset.
 - Pressing [■] (EXIT) on the base unit.

Phonebook name display

When caller information is received and it matches a phone number stored in the phonebook, the stored name in the phonebook is displayed and logged in the caller list.

Talking Call Display

Handset / Base unit

This feature lets you know who is calling without looking at the display.

To use this feature, you must:

- subscribe to a Call Display service of your service provider/telephone company.
 - turn this feature on (page 27).
- When caller information is received, the handsets and base unit announce the caller's name or phone number received from your service provider/telephone company following every ring.
- Name pronunciation may vary. This feature may not pronounce all names correctly.
 - Call Display service has a limit of how many characters can be displayed. If the caller's name is too long:
 - the handset may not be able to display or announce the entire name.

Call Display Service

- the base unit may not be able to display or announce the entire name.
- The announcement is heard at the same level as the ringer volume (page 16, 27).
- If you turn on the answering system and set the number of rings “2 rings” (page 42), the unit does not announce the caller information. If “**Toll saver**” is selected and there is a new message, the unit does not announce the caller information.
- When you receive a call while on the phone, the 2nd caller’s name is not announced even if you subscribe to both Call Display and Visual Call Waiting services.

Phonebook name announcement

When caller information is received and it matches a phone number stored in the phonebook, the stored name in the phonebook is announced.

Ringer ID

This feature can help you identify who is calling by using different ringer tones for different groups of callers. When adding an entry to the phonebook, you can assign it to the desired group (page 22). When a call is received from a caller assigned to a group, the ringer you selected for that group rings after caller information is displayed. If you select “**Current ringer**” (default), the unit uses the ringer tone you selected on page 27 when calls from this group are received.

- 1 [M] → [MENU]
- 2 [↓]: “Group” → [SELECT]
- 3 [↓]: Select the desired group. → [SELECT]
- 4 [↓]: Select the current setting of the ringer ID. → [SELECT]

- 5 [↓]: Select the desired ringer tone. → [SAVE]
- 6 [OFF]

For Call Waiting Deluxe service users

To use Call Waiting Deluxe, you must subscribe to Call Waiting Deluxe from your service provider/telephone company.

This feature not only allows the unit currently in use to display the 2nd caller’s information, but also offers you a variety of ways to deal with the 2nd call.

Important:

- Please contact your service provider/telephone company for details and availability of this service in your area.
- This feature must be turned on before it can be used.

To turn Call Waiting Deluxe on/off

To use Call Waiting Deluxe, you must turn this feature on. The default setting is “off”.

- 1 [MENU]#215
- 2 [↓]: Select the desired setting.
- 3 [SAVE] → [OFF]

Call Waiting Deluxe service options

When a 2nd call is received, you can choose how to handle the call by selecting an option shown on the unit display.

Note:

- Your service provider/telephone company may not offer all of the options (page 35).

Call Display Service

Displayed option	Function
Answer	Answers the waiting call, while keeping the 1st call on hold.
Hold	Holds the waiting call. The caller will hear the prerecorded hold message played by your service provider/ telephone company.
Announce	The caller will hear the pre-recorded busy message played by your service provider/ telephone company (for example, "We are not available now.") and will then be disconnected.
Forward	Forwards the waiting call to the Voice Mail service provided by your service provider/ telephone company. You must subscribe to Voice Mail service to use this function.
Drop	Disconnects (drops) the current call and answers the waiting call.
Conference	Answers the waiting call and combines it with the current call to make a conference call (3-party call).
Return	Returns to the waiting caller while keeping the current call on hold.
Drop caller1	Disconnects (drops) the 1st call during a conference call.

Displayed option	Function
Drop caller2	Disconnects (drops) the 2nd call during a conference call.

To use Call Waiting Deluxe service

Handset

- 1 When you hear a Call Waiting tone during an outside call, press **[FLASH]**.
 - The option menu is displayed.
- 2 **[↕]**: Select the desired option. → **[SELECT]**
 - After selecting "Answer", "Hold", or "Conference", you can select another option. → **[FLASH]** → **[↕]**: Select the desired option. → **[SELECT]**

Base unit

- 1 When you hear a Call Waiting tone during an outside call, press **[FLASH]**.
 - The option menu is displayed.
- 2 **[↕]**: Select the desired option. → **[▶]**
 - After selecting "Answer", "Hold", or "Conference", you can select another option. → **[FLASH]** → **[↕]**: Select the desired option. → **[▶]**

Note for handset and base unit:

- To exit from the option menu, wait for 20 seconds.

Caller list

Important:

- Only 1 person can access the caller list at a time.

Call Display Service

- Make sure the unit's date and time setting is correct (page 14).

Viewing the caller list and calling back

Handset / Base unit

- 1 Proceed with the operation for your unit.
Handset: [◀] CID
Base unit: [◀◀] CID
- 2 Press [▼] to search from the most recent call, or [▲] to search from the oldest call.
- 3 Proceed with the operation for your unit.
Handset:
 - To call back, press [↶].
 - To exit, press [OFF].**Base unit:**
 - To call back, press [SP-PHONE].
 - To exit, press [■] (EXIT).

Note:

- If the entry has already been viewed or answered, “√” is displayed, even if it was viewed or answered using another unit.
- In step 2, if ▶ is displayed, not all of the information is shown. To see the remaining information:
Handset:
Press [▶]. To return to the previous screen, press [◀].

Base unit:

Press [▶▶]. To return to the previous screen, press [◀◀].

Editing a caller's phone number before calling back

You can edit a phone number in the caller list by adding the long distance code “1” or removing its area code.

Handset

- 1 [◀] CID
- 2 [↕]: Select the desired entry.
- 3 Press [EDIT] repeatedly until the phone number is shown in the desired format.

- ① 1 – Area code – Local phone number
Example: 1-555-321-5555
- ② Local phone number
Example: 321-5555
- ③ Area code – Local phone number
Example: 555-321-5555

4 [↶]

Base unit

- 1 [◀◀] CID
- 2 [↕]: Select the desired entry.
- 3 Press [EDIT] repeatedly until the phone number is shown in the desired format.

- ① 1 – Area code – Local phone number
Example: 1-555-321-5555
- ② Local phone number
Example: 321-5555
- ③ Area code – Local phone number
Example: 555-321-5555

4 [SP-PHONE]

Note for handset and base unit:

- The number edited in step 3 will not be saved in the caller list.

Erasing selected caller information

Handset

- 1 [◀] CID
- 2 [↕]: Select the desired entry.

3 [ERASE] → [↕]: "Yes"

4 [SELECT] → [OFF]

 Base unit

1 [←←] CID

2 [↕]: Select the desired entry.

3 [ERASE] → [↕]: "Yes"

4 [▶] → [■] (EXIT)

Erasing all caller information

 Handset

1 [←] CID

2 [ERASE] → [↕]: "Yes"

3 [SELECT] → [OFF]

 Base unit

1 [←←] CID

2 [ERASE] → [↕]: "Yes"

3 [▶]

Storing caller information to the phonebook

 Handset

1 [←] CID

2 [↕]: Select the desired entry.
• To edit the number, press [EDIT] repeatedly until the phone number is shown in the desired format.

3 [SAVE]

4 [↕]: "Phonebook" → [SELECT]

5 Continue from step 2, "Editing entries", page 23.

 Base unit

1 [←←] CID

2 [↕]: Select the desired entry.
• To edit the number, press [EDIT] repeatedly until the phone

number is shown in the desired format.

3 [☰] → [↕]: "Yes" → [▶]

4 [■] (EXIT)

Note:

- If you stored caller information to the phonebook using the base unit, the entry is automatically assigned to group 1.

Answering System

Answering system

The answering system can answer and record calls for you when you are unavailable to answer the phone.

You can also set the unit to play a greeting message but not to record caller messages by selecting “**Greeting only**” as the recording time setting (page 43).

Important:

- Only 1 person can access the answering system (listen to messages, record a greeting message, etc.) at a time.
- When callers leave messages, the unit records the day and time of each message. Make sure the date and time have been set correctly (page 14).

Memory capacity (including your greeting message)

The total recording capacity is about 16 minutes. A maximum of 64 messages can be recorded.

Note:

- When message memory becomes full:
 - “**Messages full**” is shown on the handset and base unit display.
 - The ANSWER ON/OFF indicator on the base unit flashes rapidly if the answering system is turned on.
 - If you use the pre-recorded greeting message, the unit automatically switches to another pre-recorded greeting message asking callers to call again later.
 - If you recorded your own greeting message, the same message is still announced to callers even though their messages are not recorded.

Turning the answering system on/off

Base unit

Press **[ANSWER ON/OFF]** to turn on/off the answering system.

Handset

- 1 **To turn on:**
[MENU]#327
To turn off:
[MENU]#328
- 2 **[OFF]**

Note for base unit and handset:

- When the answering system is turned on, the ANSWER ON/OFF indicator on the base unit lights up.

Call screening

While a caller is leaving a message, you can listen to the call through the unit's speaker.

Handset

To adjust the speaker volume, press **[▲]** or **[▼]** repeatedly. You can answer the call by pressing **[↶]**. Call screening can be set for each handset. The default setting is “on”.

- 1 **[MENU]#310**
- 2 **[↕]**: Select the desired setting. → **[SAVE]** → **[OFF]**

Base unit

To adjust the speaker volume, press **[▲]** or **[▼]** repeatedly. You can answer the call by pressing **[SP-PHONE]**.

To turn off while screening a call, press **[▼]** repeatedly until the sounds goes off.

- If you adjust the speaker volume while listening to messages or having a conversation, the speaker volume for call screening is turned on again.

Greeting message

When the unit answers a call, a greeting message is played to callers.

You can use either:

- your own greeting message
- a pre-recorded greeting message

Recording your greeting message

- 1 [MENU]#302
- 2 [↕]: "Yes" → [SELECT]
- 3 After a beep sounds, hold the handset about 20 cm (8 inches) away and speak clearly into the microphone (2 minutes max.).
- 4 Press [STOP] to stop recording.
- 5 [OFF]

Using a pre-recorded greeting message

The unit provides 2 pre-recorded greeting messages:

- If you erase or do not record your own greeting message, the unit plays a pre-recorded greeting asking callers to leave a message.
- If the message recording time (page 43) is set to "Greeting only", callers' messages are not recorded and the unit plays a different pre-recorded greeting message asking callers to call again.

Resetting to a pre-recorded greeting message

If you want to use a pre-recorded greeting message once you record your own greeting message, you need to erase your own greeting message.

- 1 [MENU]#304
- 2 [YES] → [OFF]

Playing back the greeting message

- 1 [MENU]#303
- 2 [OFF]

Listening to messages using the base unit

When new messages have been recorded:

- [▶] on the base unit flashes.
- "New message" is displayed.

Press [▶].

- If new messages have been recorded, the base unit plays back new messages.
- If there are no new messages, the base unit plays back all messages.

Operating the answering system during playback

Key	Operation
[▲] or [▼]	Adjust the speaker volume
[◀◀]	Repeat message*1
[▶▶]	Skip message
[CONF]	Pause message To resume playback, press [▶].
[■] (STOP)	Stop playback
[ERASE]	Erase currently playing message

*1 If pressed within the first 5 seconds of a message, the previous message is played.

Answering System

Calling back (Call Display subscribers only)

If caller information was received for the call, you can call the caller back while listening to a message.

Press **[SP-PHONE]** during playback.

- To edit the number before calling back, press **[EDIT]** repeatedly until the phone number is shown in the desired format (page 36).

Erasing all messages

Press **[ERASE]** 2 times while the unit is not in use.

Listening to messages using the handset

When new messages have been recorded:

- “**New message**” is displayed.
- The message indicator on the handset flashes slowly if the message alert feature is turned on (page 43).

1 To listen to new messages: **[PLAY]**

or

[MENU]#323

- If there are no new messages in the answering system, **[PLAY]** is not displayed.

To listen to all messages:

[MENU]#324

2 When finished, press **[OFF]**.

Note:

- To switch to the receiver, press **[↶]**.

Operating the answering system

[MENU] → **[↕]**: “**Answering device**” → **[SELECT]**

Key	Operation
[▲] or [▼]	Adjust the receiver/speaker volume (during playback)
1 or [◀]	Repeat message (during playback)*1
2 or [▶]	Skip message (during playback)
3	Enter the “ Settings ” menu
4	Play new messages
5	Play all messages
6	Play greeting message
7 6	Record greeting message
8	Turn answering system on
[PAUSE]	Pause message*2
9 or [STOP]	Stop recording Stop playback
0	Turn answering system off
* 4 *3	Erase currently playing message
* 5	Erase all messages
* 6	Reset to a pre-recorded greeting message

*1 If pressed within the first 5 seconds of a message, the previous message is played.

*2 To resume playback:
[↕]: “**Playback**” → **[SELECT]**

*3 You can also erase as follows:
[ERASE] → **[↕]**: “**Yes**” → **[SELECT]**

Calling back (Call Display subscribers only)

If caller information is received for the call, you can call the caller back while listening to a message.

- 1 Press **[PAUSE]** during playback.
- 2 **[↕]**: “Call back” → **[SELECT]**

Editing the number before calling back

- 1 Press **[PAUSE]** during playback.
- 2 **[↕]**: “Edit & Call” → **[SELECT]**
- 3 Press **[EDIT]** repeatedly until the phone number is shown in the desired format (page 36). → **[↶]**

Erasing all messages

- 1 **[MENU]****[#]****[3]****[2]****[5]**
- 2 **[↕]**: “Yes” → **[SELECT]** → **[OFF]**

Voice memo

Recording a voice memo

You can use the base unit to leave a voice memo (voice message) for yourself or someone else (3 minutes max.). Voice memos can be played back later with the same operation used to play back answering system messages.

- 1 **[MEMO]**
- 2 After the unit beeps, speak clearly about 20 cm (8 inches) away from the microphone.
- 3 To stop recording, press **[■]** (STOP).

Remote operation

Using a touch-tone phone, you can call your phone number from outside and access the unit to listen to messages or change answering system settings. The unit's voice guidance prompts you to press certain dial keys to perform different operations.

Remote access code

A 3-digit remote access code must be entered when operating the answering system remotely. This code prevents unauthorized parties from listening to your messages remotely. The default setting is “111”.

Important:

- To prevent unauthorized access to this product, we recommend that you regularly change the remote code.

- 1 **[MENU]****[#]****[3]****[0]****[6]**
- 2 Enter the desired 3-digit remote access code.
- 3 **[SAVE]** → **[OFF]**

Deactivating remote operation

Press **[X]** in step 2 on “Remote access code”, page 41.

- The entered remote access code is deleted.

Using the answering system remotely

- 1 Dial your phone number from a touch-tone phone.
- 2 After the greeting message starts, enter your remote access code.
- 3 Follow the voice guidance prompts as necessary or control the unit using remote commands (page 42).
- 4 When finished, hang up.

Voice guidance

During remote operation, the unit's voice guidance starts and prompts you to press **[1]** to perform a specific operation, or press **[2]** to listen to more available operations.

Answering System

Note:

- If you do not press any dial keys within 10 seconds after a voice guidance prompt, the unit disconnects your call.

Remote commands

You can press dial keys to access certain answering system functions without waiting for the voice guidance to prompt you.

Key	Operation
[1]	Repeat message (during playback)*1
[2]	Skip message (during playback)
[4]	Play new messages
[5]	Play all messages
[9]	Stop playback
[0]	Turn answering system off
[*][4]	Erase currently playing message
[*][5]	Erase all messages
[*][#]	End remote operation (or hang up)

*1 If pressed within the first 5 seconds of a message, the previous message is played.

Turning on the answering system remotely

If the answering system is off, you can turn it on remotely.

- 1 Dial your phone number from a touch-tone phone.
- 2 Let the phone ring 15 times.
 - A long beep is heard.

- 3 Enter your remote access code within 10 seconds after the long beep.
 - The greeting message is played back.
 - You can either hang up, or enter your remote access code again and begin remote operation (page 41).

Answering system settings

Number of rings before the unit answers a call

You can change the number of times the phone rings “**Ring count**” before the unit answers calls. You can select 2 to 7 rings, or “**Toll saver**”.

The default setting is “**4 rings**”.

“**Toll saver**”: The unit’s answering system answers at the end of the 2nd ring when new messages have been recorded, or at the end of the 5th ring when there are no new messages. If you call your phone from outside to listen to new messages (page 41), you know that there are no new messages when the phone rings for the 3rd time. You can then hang up without being charged for the call.

- 1 [MENU][#][2][1][1]
- 2 [↕]: Select the desired setting. → [SAVE] → [OFF]

For Voice Mail service subscribers

If you subscribe to a flat-rate service package that includes Call Display, Call Waiting, Voice Mail, and unlimited local/regional/long distance calls, please note the following:

- To use the Voice Mail service provided by your service provider/

telephone company rather than the unit's answering system, turn off the answering system (page 38).

- To use this unit's answering system rather than the Voice Mail service provided by your service provider/telephone company, please contact your service provider/telephone company to deactivate your Voice Mail service.
If your service provider/telephone company cannot do this:
 - Set this unit's "Ring count" setting so that this unit's answering system answers calls before the Voice Mail service of your service provider/telephone company does. It is necessary to check the number of rings required to activate the Voice Mail service provided by your service provider/telephone company before changing this setting.
 - Change the number of rings of the Voice Mail service so that the answering system can answer the call first. To do so, contact your service provider/telephone company.

Caller's recording time

You can change the maximum message recording time allowed for each caller. The default setting is "3 min".

- 1 [MENU]#305
- 2 [↕]: Select the desired setting. → [SAVE] → [OFF]

Selecting "Greeting only"

You can select "Greeting only" which sets the unit to announce a greeting message to callers but not record messages.

Select "Greeting only" in step 2 on "Caller's recording time", page 43.

Note:

- When you select "Greeting only":
 - If you do not record your own message, the unit will play the pre-recorded greeting-only message asking callers to call again later.
 - If you use your own message, record the greeting-only message asking callers to call again later (page 39).

Message alert

You can select whether or not the message indicator on the handset flashes slowly when new messages are recorded. The default setting is "On".

Important:

- If you stored the Voice Mail access number (page 44), the message indicator also flashes for newly recorded Voice Mail messages (page 45).

- 1 [MENU]#340
- 2 [↕]: Select the desired setting. → [SAVE] → [OFF]

Note:

- While message alert is on, battery operating time is shortened (page 10).

Voice Mail Service

Voice Mail service

Voice Mail is an automatic answering service offered by your service provider/telephone company. After you subscribe to this service, your service provider/telephone company's Voice Mail system answers calls for you when you are unavailable to answer the phone or when your line is busy. Messages are recorded by your service provider/telephone company, not your telephone. Please contact your service provider/telephone company for details of this service.

Important:

- To use the Voice Mail service provided by your service provider/telephone company rather than the unit's answering system, turn off the answering system (page 38). For details, see page 42.
- You need to store the Voice Mail access number to activate the message alert feature (page 43) for Voice Mail service.

Storing the Voice Mail (VM) access number

In order to listen to your Voice Mail messages, you must dial your service provider/telephone company's Voice Mail access number. Once you have stored your Voice Mail access number, you can dial it automatically (page 45).

- 1 **[MENU]****#****3****3****1**
- 2 Enter your access number (24 digits max.). → **[SAVE]** → **[OFF]**

Note:

- When storing your Voice Mail access number and your mailbox password, press **[PAUSE]** to add pauses (page 16) between the access

number and the password as necessary. Contact your service provider/telephone company for the required pause time.

Example:

1-222-333-4444 PPPP 8888

VM access Pauses Password
number

To erase the Voice Mail access number

- 1 **[MENU]****#****3****3****1**
- 2 Press and hold **[CLEAR]** until all digits are erased. → **[SAVE]** → **[OFF]**

Voice Mail (VM) tone detection

Handset / Base unit

Your service provider/telephone company sends special signals (sometimes called "Voice Mail tones" or "stutter tones") to the unit to let you know you have new Voice Mail messages. If you hear a series of dial tones followed by a continuous dial tone after you press **[]** on the handset or press **[SP-PHONE]** on the base unit, you have new Voice Mail messages. Soon after you hang up a call or after the phone stops ringing, your unit checks the phone line to see if new Voice Mail messages have been recorded.

Turn this feature off when:

- You do not subscribe to Voice Mail service.
 - Your service provider/telephone company does not send Voice Mail tones.
 - Your phone is connected to a PBX.
- If you are not sure which setting is required, contact your service provider/telephone company.

Turning VM tone detection on/off

The default setting is "On".

- 1 **[MENU]** **Ⓜ** **3** **3** **2**
- 2 **⏴**: Select the desired setting. →
[SAVE] → **[OFF]**

Listening to Voice Mail messages

The unit lets you know that you have new Voice Mail messages in the following ways:

- "New Voice Mail" is displayed on the handset and base unit if message indication service is available.
- The message indicator on the handset flashes slowly if the message alert feature is turned on ("Message alert", page 43).

Handset

- 1 **[VM]**
or
[MENU] **Ⓜ** **3** **3** **0**
 - The speakerphone turns on.
 - If there are no new messages in the Voice Mail, **[VM]** is not displayed.
- 2 Follow the pre-recorded instructions.
- 3 When finished, press **[OFF]**.

Base unit

To listen to Voice Mail messages, you have to dial your Voice Mail access number manually.

Note for handset and base unit:

- If the handset and base unit still indicate there are new messages even after you have listened to all new messages, turn it off by pressing and holding **Ⓜ** until the handset or base unit beeps.
- If your Voice Mail service uses Voice Mail tones and a message is over 3

minutes long, the unit may not indicate new messages.

- If your Voice Mail service uses Voice Mail tones, the tones are heard from any phone connected to the same line. If you want to use another phone to listen to Voice Mail messages, you have to dial your access number manually.

Intercom/Locator

Intercom

Intercom calls can be made:

- between handsets
- between a handset and the base unit

Note:

- If you receive an outside call while talking on the intercom, you hear 2 tones.
 - To answer the call with the handset, press **[OFF]**, then press **[↶]**.
 - To answer the call with the base unit, press **[SP-PHONE]** 2 times.
- When paging unit(s), the paged unit(s) beeps for 1 minute.

Making an intercom call

Handset

- 1 **[MENU]** → **[INT]**
- 2 **[↕]**: Select the desired unit. → **[SELECT]**
 - To stop paging, press **[OFF]**.
- 3 When you finish talking, press **[OFF]**.

Base unit

- 1 Press **[INTERCOM]**.
When 2 or more handsets are registered:
 - To page a specific handset, enter the handset number.
 - To page all handsets, press **[0]** or wait for a few seconds.
 - To stop paging, press **[INTERCOM]**.
- 2 When you finish talking, press **[INTERCOM]**.

Answering an intercom call

Handset

- 1 Press **[↶]** to answer the page.

- 2 When you finish talking, press **[OFF]**.

Base unit

- 1 Press **[INTERCOM]** to answer the page.
- 2 When you finish talking, press **[INTERCOM]**.

Handset locator

You can locate a misplaced handset by paging it.

- 1 **Base unit:** Press **[LOCATOR]**.
 - All registered handsets beep for 1 minute.
- 2 To stop paging:
Base unit:
Press **[LOCATOR]**.
Handset:
Press **[↶]**, then press **[OFF]**.

Transferring calls, conference calls

Outside calls can be transferred or a conference call with an outside party can be made:

- between 2 handsets
- between a handset and the base unit

Handset

- 1 During an outside call, press **[INT]** to put the call on hold.
- 2 **[↕]**: Select the desired unit. → **[SELECT]**
- 3 Wait for the paged party to answer.
 - If the paged party does not answer, press **[↶]** to return to the outside call.
- 4 **To complete the transfer:**
Press **[OFF]**.

- The outside call is being routed to the destination unit.

To establish a conference call:

[MENU] → **[↕]**: "Conference"
→ **[SELECT]**

- To leave the conference, press **[OFF]**. The other 2 parties can continue the conversation.
- To put the outside call on hold:
[MENU] → **[↕]**: "Hold" → **[SELECT]**
To resume the conference:
[MENU] → **[↕]**: "Conference"
→ **[SELECT]**

 **Base unit**

- 1** During an outside call, press **[INTERCOM]**.
When 2 or more handsets are registered:
 - To page a specific handset, enter the handset number.
 - To page all handsets, press **[0]** or wait for a few seconds.
- 2** Wait for the paged party to answer.
 - If paged party does not answer, press **[INTERCOM]** to return to the outside call.
- 3** **To complete the transfer:**
Press **[SP-PHONE]**.
 - The outside call is being routed to the handset.**To establish a conference call:**
Press **[CONF]**.
 - To leave the conference, press **[SP-PHONE]**. The other 2 parties can continue the conversation.
 - To put the outside call on hold, press **[HOLD]**. To resume the conference, press **[CONF]**.

Answering a transferred call

 **Handset**

Press **[↶]** to answer the page.

 **Base unit**

Press **[SP-PHONE]** to answer the page.

Useful Information

Wall mounting

The base unit can be mounted on a wall by revolving the bracket to "WALL" position (default: "DESK" stand position).

Note:

- Make sure that the wall and the fixing method are strong enough to support the weight of the unit.

Base unit

- 1 Turn the bracket 180 degrees counter-clockwise in the "WALL" direction until a click is heard.

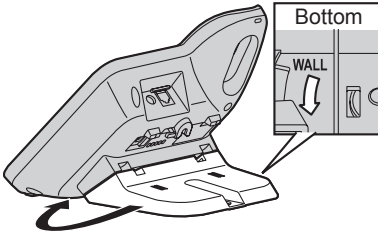

- The bracket cannot be removed. Do not turn the bracket more than 180 degrees.

- 2 Tuck in the telephone line cord (1). Connect the AC adaptor cord and telephone line cord (2).

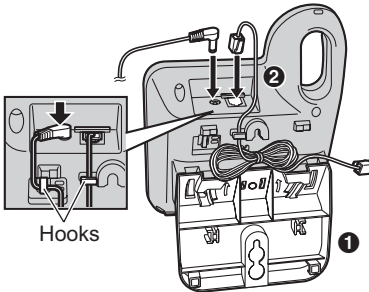

- 3 Mount the unit on a wall then slide down to secure in place.

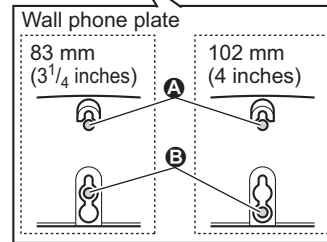
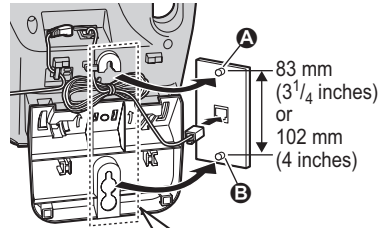

To stand on a desk

Turn the bracket 180 degrees clockwise from the "WALL" position to the "DESK" direction until a click is heard.

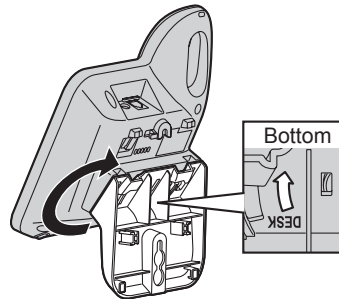

Charger

Drive the screws (not supplied) into the wall.

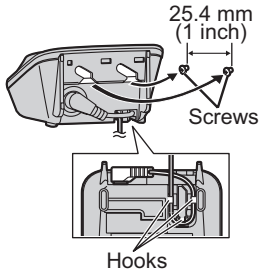

Useful Information

Error messages

Display message	Cause/solution
Access # to VM service is not stored	<ul style="list-style-type: none">● You have not stored the Voice Mail access number. Store the number (page 44).
Base no power or No link. Re-connect base AC adaptor. or No link.	<ul style="list-style-type: none">● The handset has lost communication with the base unit. Move closer to the base unit and try again.● Unplug the base unit's AC adaptor to reset the unit. Reconnect the adaptor and try again.● The handset's registration may have been cancelled. Re-register the handset (page 32).● When "No link." is displayed during a power failure, place a handset on the base unit to supply power to the base unit.
Busy	<ul style="list-style-type: none">● The called unit is in use.● Other units are in use and the system is busy. Try again later.● The handset you are using is too far from the base unit. Move closer and try again.
Check tel line	<ul style="list-style-type: none">● The supplied telephone line cord has not been connected yet or not connected properly. Check the connections (page 9).
Error!!	<ul style="list-style-type: none">● Recording was too short. Try again.
Invalid	<ul style="list-style-type: none">● There is no handset registered to the base unit matching the handset number you entered.● The handset is not registered to the base unit. Register the handset (page 32).
Requires subscription to Caller ID.	<ul style="list-style-type: none">● You must subscribe to a Call Display service. Once you receive caller information after subscribing to a Call Display service, this message will not be displayed.
Use rechargeable battery.	<ul style="list-style-type: none">● A wrong type of battery such as Alkaline or Manganese was inserted. Use only the rechargeable Ni-MH batteries noted on page 4, 6.

Troubleshooting

If you still have difficulties after following the instructions in this section, disconnect the base unit's AC adaptor, then reconnect the base unit's AC adaptor. Remove the batteries from the handset, and then insert the batteries into the handset again.

General use



Problem	Cause/solution
The handset does not turn on even after installing charged batteries.	<ul style="list-style-type: none"> Place the handset on the base unit or charger to turn on the handset.
The unit does not work.	<ul style="list-style-type: none"> Make sure the batteries are installed correctly (page 9). Fully charge the batteries (page 9). Check the connections (page 9). Unplug the base unit's AC adaptor to reset the unit. Reconnect the adaptor and try again. The handset has not been registered to the base unit. Register the handset (page 32).
I cannot hear a dial tone.	<ul style="list-style-type: none"> The base unit's AC adaptor or telephone line cord is not connected. Check the connections. Disconnect the base unit from the telephone line and connect the line to a known working telephone. If the working telephone operates properly, contact our service personnel to have the unit repaired. If the working telephone does not operate properly, contact your service provider/telephone company.
The indicator on the handset flashes slowly.	<ul style="list-style-type: none"> New messages have been recorded. Listen to the new messages (page 40). New Voice Mail messages have been recorded. Listen to the new Voice Mail messages (page 45).

Programmable settings

Problem	Cause/solution
The display is in a language I cannot read.	<ul style="list-style-type: none"> Change the display language (page 14).
I cannot register a handset to a base unit.	<ul style="list-style-type: none"> The maximum number of handsets (6) is already registered to the base unit. Cancel unused handset registrations from the base unit (page 32).

Useful Information

Battery recharge

Problem	Cause/solution
The handset beeps and/or  flashes.	<ul style="list-style-type: none">● Battery charge is low. Fully charge the batteries (page 9).
I fully charged the batteries, but <ul style="list-style-type: none">–  still flashes,–  is displayed, or– the operating time seems to be shorter.	<ul style="list-style-type: none">● Clean the battery ends (\oplus, \ominus) and the charge contacts with a dry cloth and charge again.● It is time to replace the batteries (page 9).

Making/answering calls, intercom

Problem	Cause/solution
 is displayed.	<ul style="list-style-type: none">● The handset is too far from the base unit. Move closer.● The base unit's AC adaptor is not properly connected. Reconnect AC adaptor to the base unit.● The handset is not registered to the base unit. Register it (page 32).
Noise is heard, sound cuts in and out.	<ul style="list-style-type: none">● You are using the handset or base unit in an area with high electrical interference. Re-position the base unit and use the handset away from sources of interference.● Move closer to the base unit.● If you use a DSL/ADSL service, we recommend connecting a DSL/ADSL filter between the base unit and the telephone line jack. Contact your DSL/ADSL provider for details.
The handset does not ring.	<ul style="list-style-type: none">● The ringer volume is turned off. Adjust the ringer volume (page 16).● Night mode is turned on. Turn it off (page 30).
The base unit does not ring.	<ul style="list-style-type: none">● The ringer volume is turned off. Adjust the ringer volume (page 17).
I cannot make a call.	<ul style="list-style-type: none">● The dialing mode may be set incorrectly. Change the setting (page 14).● The handset is too far from the base unit. Move closer and try again.
I cannot make long distance calls.	<ul style="list-style-type: none">● Make sure that you have long distance service.

Call Display/Talking Call Display

Problem	Cause/solution
<p>Caller information is not displayed.</p>	<ul style="list-style-type: none"> ● You must subscribe to Call Display service. Contact your service provider/telephone company for details. ● If your unit is connected to any additional telephone equipment such as a Call Display box or cordless telephone line jack, plug the unit directly into the wall jack. ● If you use a DSL/ADSL service, we recommend connecting a DSL/ADSL filter between the base unit and the telephone line jack. Contact your DSL/ADSL provider for details. ● The name display service may not be available in some areas. Contact your service provider/telephone company for details. ● Other telephone equipment may be interfering with this unit. Disconnect the other equipment and try again.
<p>Caller information is displayed or announced late.</p>	<ul style="list-style-type: none"> ● Depending on your service provider/telephone company, the unit may display or announce the caller's information at the 2nd ring or later. ● Move closer to the base unit.
<p>Caller information is not announced.</p>	<ul style="list-style-type: none"> ● The handset or base unit's ringer volume is turned off. Adjust it (page 16, 27). ● The Talking Call Display feature is turned off. Turn it on (page 27). ● The number of rings for the answering system is set to "2 rings" or "Toll saver". Select a different setting (page 42). ● If the base unit and another handset are having an intercom call, your handset does not announce caller information.
<p>I cannot dial the phone number edited in the caller list.</p>	<ul style="list-style-type: none"> ● The phone number you dialed might have been edited incorrectly (for example, the long distance "1" or the area code is missing). Edit the phone number with another pattern (page 36).
<p>Time on the unit has shifted.</p>	<ul style="list-style-type: none"> ● Incorrect time information from incoming Call Display changes the time. Set the time adjustment to "Manual" (off) (page 27).

Useful Information

Problem	Cause/solution
The 2nd caller's information is not displayed during an outside call. (Visual Call Waiting feature does not function.)	<ul style="list-style-type: none">● In order to use Call Display, Call Waiting, or Visual Call Waiting, you must first contact your service provider/telephone company and subscribe to the desired service. After subscribing, you may need to contact your service provider/telephone company again to activate this specific service, even if you already subscribed to both Call Display and Visual Call Waiting services.

Answering system

Problem	Cause/solution
The unit does not record new messages.	<ul style="list-style-type: none">● The answering system is turned off. Turn it on (page 38).● The message memory is full. Erase unnecessary messages (page 39).● The recording time is set to "Greeting only". Change the setting (page 43).● If you subscribe to a Voice Mail service, messages are recorded by your service provider/telephone company, not your telephone. Change the unit's number of rings setting or contact your service provider/telephone company (page 42).
I cannot operate the answering system.	<ul style="list-style-type: none">● Someone is using the unit. Wait for the other user to finish.● A caller is leaving a message. Wait for the caller to finish.● The handset is too far from the base unit. Move closer.
I cannot operate the answering system remotely.	<ul style="list-style-type: none">● The remote access code is not set. Set the remote access code (page 41).● You are entering the wrong remote access code. If you have forgotten your remote access code, enter the remote access code setting to check your current code (page 41).● Press each key firmly.● The answering system is turned off. Turn it on (page 42).

Useful Information

Liquid damage

Problem	Cause/solution
Liquid or other form of moisture has entered the handset/base unit.	<ul style="list-style-type: none">● Disconnect the AC adaptor and telephone line cord from the base unit. Remove the batteries from the handset and leave to dry for at least 3 days. After the handset/base unit are completely dry, reconnect the AC adaptor and telephone line cord. Insert the batteries and charge fully before use. If the unit does not work properly, contact an authorized service centre.

Caution:

- To avoid permanent damage, do not use a microwave oven to speed up the drying process.

Useful Information

Industry Canada Notices and other information

NOTICE:

This equipment meets the applicable Industry Canada Terminal Equipment Technical Specifications. This is confirmed by the registration number. The abbreviation, "IC:", before the registration number signifies that registration was performed based on a Declaration of Conformity indicating that Industry Canada technical specifications were met. It does not imply that Industry Canada approved the equipment.

Users should ensure, for their own protection, that the electrical ground connections of the power utility, telephone lines and internal metallic water pipe system, if present, are connected together. This precaution may be particularly important in rural areas.

NOTICE:

The **Ringer Equivalence Number (REN)** assigned to each terminal device provides an indication of the maximum number of terminals allowed to be connected to a telephone interface. The termination on an interface may consist of any combination of devices subject only to the requirement that the sum of the Ringer Equivalence Numbers of all the devices does not exceed 5.

The Ringer Equivalence Number (REN) of this unit: (found on the bottom of the unit).

NOTICE:

Operation is subject to the following two conditions: (1) this device may not cause interference, and (2) this device must accept any interference, including interference that may cause undesired operation of the device.

Privacy of communications may not be ensured when using this telephone. Some cordless telephones operate at frequencies that may cause interference to nearby TVs and VCRs. To minimize or prevent such interference, the base of the cordless telephone should not be placed near, or on top of, a TV or VCR. If interference is experienced, move the cordless telephone further away from the TV or VCR. This will often reduce, or eliminate, interference.

RF Exposure Warning:

- This product complies with IC radiation exposure limits set forth for an uncontrolled environment.
- To comply with IC RF exposure requirements, the base unit must be installed and operated 20 cm (8 inches) or more between product and all person's body (excluding extremities of hands, wrist and feet).
- This product may not be collocated or operated in conjunction with any other antenna or transmitter.
- The handset may be carried and operated with only the specific provided belt-clip. Other non-tested belt-clips or similar body-worn accessories may not comply and must be avoided.

Warranty

Panasonic Canada Inc.
5770 Ambler Drive, Mississauga, Ontario L4W 2T3
PANASONIC PRODUCT - LIMITED WARRANTY

EXCHANGE PROGRAM

Panasonic Canada Inc. warrants this product to be free from defects in material and workmanship under normal use and for a period as stated below from the date of original purchase agrees to, at its option either (a) repair your product with new or refurbished parts, (b) replace it with a new or a refurbished equivalent value product, or (c) refund your purchase price. The decision to repair, replace or refund will be made by Panasonic Canada Inc.

Telephone Accessory / Product

One (1) year

This warranty is given only to the original purchaser, or the person for whom it was purchased as a gift, of a Panasonic brand product mentioned above sold by an authorized Panasonic dealer in Canada and purchased and used in Canada, which product was not sold "as is", and which product was delivered to you in new condition in the original packaging.

IN ORDER TO BE ELIGIBLE TO RECEIVE WARRANTY SERVICE HEREUNDER, A PURCHASE RECEIPT OR OTHER PROOF OF DATE OF ORIGINAL PURCHASE, SHOWING AMOUNT PAID AND PLACE OF PURCHASE IS REQUIRED

LIMITATIONS AND EXCLUSIONS

This warranty **ONLY COVERS** failures due to defects in materials or workmanship, and **DOES NOT COVER** normal wear and tear or cosmetic damage. The warranty **ALSO DOES NOT COVER** damages which occurred in shipment, or failures which are caused by products not supplied by Panasonic Canada Inc., or failures which result from accidents, misuse, abuse, neglect, mishandling, misapplication, alteration, faulty installation, set-up adjustments, misadjustment of consumer controls, improper maintenance, improper batteries, power line surge, lightning damage, modification, introduction of sand, humidity or liquids, commercial use such as hotel, office, restaurant, or other business or rental use of the product, or service by anyone other than a Authorized Servicer, or damage that is attributable to acts of God.

Rechargeable batteries are warranted for ninety (90) days from date of original purchase.

THIS EXPRESS, LIMITED WARRANTY IS IN LIEU OF ALL OTHER WARRANTIES, EXPRESS OR IMPLIED, INCLUDING ANY IMPLIED WARRANTIES OF MERCHANTABILITY AND FITNESS FOR A PARTICULAR PURPOSE. IN NO EVENT WILL PANASONIC CANADA INC. BE LIABLE FOR ANY SPECIAL, INDIRECT OR CONSEQUENTIAL DAMAGES RESULTING FROM THE USE OF THIS PRODUCT OR ARISING OUT OF ANY BREACH OF ANY EXPRESS OR IMPLIED WARRANTY. (As examples, this warranty excludes damages for lost time, travel to and from the Authorized Servicer, loss of or damage to media or images, data or other memory or recorded content. This list of items is not exhaustive, but for illustration only.)

In certain instances, some jurisdictions do not allow the exclusion or limitation of incidental or consequential damages, or the exclusion of implied warranties, so the above limitations and exclusions may not be applicable. This warranty gives you specific legal rights and you may have other rights which vary depending on your province or territory.

CONTACT INFORMATION

For product information and operation assistance, please contact:

Our Customer Care Centre: Telephone #: 1-800-561-5505
Fax #: (905) 238-2360
Email link: "Support → contact us → email" on www.panasonic.ca

For defective product exchange within the warranty period, please contact the original dealer or our Customer Care Centre.

Index

Index

- # 4-way conference: 18
- A** Additional handset: 32
 - Alarm: 30
 - Answering calls: 16
 - Answering system
 - Call screening: 38
 - Erasing messages: 39, 40, 42
 - Greeting message: 39
 - Greeting only: 43
 - Listening to messages: 39, 40, 41
 - MEMO: 41
 - Number of rings: 42
 - Recording time: 43
 - Remote access code: 41
 - Remote operation: 41
 - Ring count: 42
 - Toll saver: 42
 - Turning on/off: 38, 40, 42
 - Auto talk: 16
- B** Battery: 9, 10
 - Belt clip: 13
 - Booster (Clarity booster): 18
- C** C.TWG (Call Waiting Deluxe): 34
 - Call block: 31
 - Call Display service: 33
 - Call share: 18
 - Call Waiting: 17
 - Caller list: 35
 - Caller list edit: 36
 - Chain dial: 24
 - CID (Call Display): 36
 - Conference calls: 46
 - Control type: 11, 12
 - Customer support: 28
- D** Date and time: 14
 - Dialing mode: 14
 - Direct command code: 25
 - Display
 - Contrast: 27, 29
 - Language: 14
- E** Eco mode: 10
 - Equalizer: 18
 - Error messages: 50
- F** Flash: 17, 28
- G** Groups: 22, 34
- H** Handset
 - Deregistration: 32
 - Locator: 46
 - Name: 31
 - Registration: 32
 - Hold: 17
- I** Intercom: 46
- K** Key tone: 27
- L** Line mode: 28
- M** Making calls: 15
 - Missed calls: 33
 - Mute: 17
- N** Night mode: 30
- P** Pause: 16
 - Phonebook: 22
 - Power failure (power back-up operation): 19
 - Privacy mode: 19
- R** Redialing: 15
 - Ringer ID: 34
 - Ringer tone: 27, 34
 - Rotary/pulse service: 18
- S** SP-PHONE (Speakerphone): 15
- T** Talking Call Display: 33
 - Temporary tone dialing: 18
 - Time adjustment: 26
 - Transferring calls: 46
 - Troubleshooting: 51
- V** Visual Call Waiting: 17
 - VM (Voice Mail): 44
 - Voice guidance language: 14
 - Voice Mail: 42, 44
 - Volume
 - Receiver: 15
 - Ringer (Base unit): 17
 - Ringer (Handset): 16, 27
 - Speaker: 15
- W** Wall mounting: 48

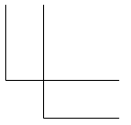
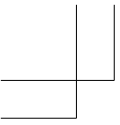

Notes

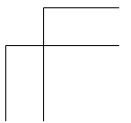
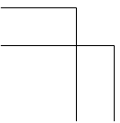
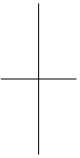

For your future reference

We recommend keeping a record of the following information to assist with any repair under warranty.

Serial No.	Date of purchase
(found on the bottom of the base unit)	
Name and address of dealer	

Attach your purchase receipt here.

Panasonic Canada Inc.

5770 Ambler Drive, Mississauga, Ontario L4W 2T3

© Panasonic System Networks Co., Ltd. 2011

Printed in Malaysia



TG6642C

PNQX3145ZA TT0111MG0