

**INVERTER**  
precision cook technology

**Panasonic**<sup>®</sup>

**Owner's Manual**  
**Steam Combination Oven**  
**Household Use Only**  
**Model No. NN-DS58HB**



**PLEASE READ THESE INSTRUCTIONS CAREFULLY BEFORE USING THIS PRODUCT, AND  
SAVE THIS MANUAL FOR FUTURE USE.**

Inverser le manuel pour lire les instructions en français.

Panasonic Canada Inc.  
5770 Ambler Drive  
Mississauga, Ontario  
L4W 2T3  
Tel: (905) 624-5010  
[www.panasonic.com](http://www.panasonic.com)

F0003BU01CP  
PA0217-11217  
Printed in China

© Panasonic Appliances Microwave Oven (Shanghai) Co., Ltd. 2017

# Table of Contents

## Safety Information

IMPORTANT SAFETY INSTRUCTIONS .....	3-5
Installation and Grounding Instructions .....	6-7
Food Preparation .....	8-9
Cookware Guide .....	10-12

## Operation

Location of Controls .....	13-14
Control Panel .....	15
Display Window .....	16
Dial Feature .....	16
Cooking Modes .....	17-18
Operation .....	19-43
Using the Microwave for the First Time .....	19
Function Features .....	19
Demo Mode .....	20
Setting the Clock .....	20
Menu Action ON/OFF .....	20
Setting the Child Safety Lock .....	20
Micro Power Feature .....	21
Micro Power Defrost Setting Feature .....	22
300 W + Steam .....	22
Steam Feature .....	23-24
Steam Shot Feature .....	24
Oven Feature .....	25-26
Grill Feature .....	27
Combination Feature .....	28-30
Crispy Grill .....	28
Combo 1 (Grill + Steam) .....	29
Combo 2 (Grill + Microwave) .....	30
Setting the Timer .....	31
3-Stage Feature .....	32
Quick 30 Feature .....	33
Popcorn .....	33
More/Less Feature .....	34
Inverter Turbo Defrost Feature .....	34
Auto Steam Feature .....	35

Auto Grill Feature .....	36
Auto Cook Feature .....	37
Menu Chart .....	38-41
Cleaning Feature .....	42-43
Deodorization Setting .....	42
Drain Water Setting .....	42
System Cleaning Setting .....	43
Cavity Cleaning Setting .....	43
Guide Lines .....	44
Defrosting Tips & Techniques .....	45
Defrosting Chart .....	45
Cooking Chart .....	46
Reheating Chart .....	47
Food Characteristics .....	48
Cooking Techniques .....	49

## Maintenance

Care and Cleaning of Your Microwave Oven .....	50-51
Before Requesting Service .....	52-53
Warranty .....	54

## General Information

Specifications .....	55
User's Record .....	55



## IMPORTANT SAFETY INSTRUCTIONS

### Your safety and the safety of others are very important.



We have provided important safety messages in this manual and on your appliance. Always read and obey all safety messages.

This is the safety alert symbol. It is used to alert you to potential hazards that can kill or hurt you and others.

All safety messages will follow the safety alert symbol and either the word "DANGER", "WARNING" or "CAUTION". These words mean:



### DANGER

You can be killed or seriously injured if you don't immediately follow instructions.



### WARNING

You can be killed or seriously injured if you don't follow instructions.



### CAUTION

You can be exposed to a potentially hazardous situation which, if not avoided, may result in minor or moderate injury.

All safety messages will tell you what the potential hazard is, tell you how to reduce the chance of injury, and tell you what can happen if the instructions are not followed.



## PRECAUTIONS TO AVOID POSSIBLE EXPOSURE TO EXCESSIVE MICROWAVE ENERGY

- (a) Do not attempt to operate this oven with the door open, since open-door operation can result in harmful exposure to microwave energy. It is important not to defeat or tamper with the safety interlocks.
- (b) Do not place any object between the oven front face and the door, or allow soil or cleaner residue to accumulate on sealing surfaces.
- (c) Do not operate the oven if it is damaged. It is particularly important that the oven door close properly and that there is no damage to the:
  - (1) door (bent),
  - (2) hinges and latches (broken or loosened),
  - (3) door seals and sealing surfaces.
- (d) The oven should not be adjusted or repaired by anyone except properly qualified service personnel.

## Thank you for purchasing a Panasonic Microwave Oven

Your microwave oven is a cooking appliance and you should use as much care as you use with a stove or any other cooking appliance. When using this electric appliance, basic safety precautions should be followed, including the following:



### WARNING

**To reduce the risk of burns, electric shock, fire, injury to persons, or exposure to excessive microwave energy:**

1. Read all instructions before using this appliance.
2. Read and follow the specific "**PRECAUTIONS TO AVOID POSSIBLE EXPOSURE TO EXCESSIVE MICROWAVE ENERGY**," above.
3. This appliance must be grounded. Connect only to a properly grounded outlet. See "**Grounding Instructions**" found on page 6.
4. As with any cooking appliance, **DO NOT** leave oven unattended while in use.
5. Install or locate this appliance only in accordance with the installation instructions found on page 6-7.
6. **DO NOT** cover or block any openings on this appliance.
7. **DO NOT** store this appliance outdoors. **DO NOT** use this product near water (for example, near a kitchen sink, in a wet basement, or near a swimming pool or similar locations).
8. Use this appliance only for its intended use as described in this manual. **DO NOT** use corrosive chemicals, vapors or non-food products in this appliance. This type of oven is specifically designed to heat or cook food. It is not designed for industrial or laboratory use. The use of corrosive chemicals in heating or cleaning will damage the appliance and may result in radiation leaks.
9. When cleaning surfaces of the door and oven that come together on closing the door, use only mild, non-abrasive soaps or detergents applied with a sponge or soft cloth.



## IMPORTANT SAFETY INSTRUCTIONS (continued)

10. **DO NOT** allow children to use this appliance, unless closely supervised by an adult. **DO NOT** assume that because a child has mastered one cooking skill he/she can cook everything.
11. **DO NOT** operate this appliance if it has a damaged cord or plug, if it is not working properly, or if it has been damaged or dropped.
12. **DO NOT** immerse cord or plug in water.
13. Keep cord away from heated surfaces.
14. **DO NOT** let cord hang over edge of a table or counter.
15. This appliance should be serviced only by qualified service personnel. Contact the nearest authorized service center for examination, repair or adjustment.
16. Some products such as whole eggs, with or without shell, narrow neck bottles and sealed containers (for example, closed glass jars) may explode and should not be heated in this oven.
17. To reduce the risk of fire in the oven cavity:
  - (a) **DO NOT** overcook food. Carefully attend appliance when paper, plastic, or other combustible materials are placed inside the oven to facilitate cooking.
  - (b) Remove wire twist-ties from paper or plastic bags before placing bag in oven.
  - (c) **If material inside the oven ignites, keep oven door closed, turn oven off, and disconnect the power cord, or shut off power at the fuse or circuit breaker panel.**
  - (d) **DO NOT** use the cavity for storage purposes. **DO NOT leave paper products, cooking utensils or food in the cavity when not in use.**
18. **Superheated Liquids:** Liquids, such as water, coffee or tea are able to be overheated beyond the boiling point without showing evidence (or signs) of boiling. Visible bubbling is not always present when the container is removed from the microwave oven. THIS COULD RESULT IN VERY HOT LIQUIDS SUDDENLY BOILING OVER WHEN THE CONTAINER IS DISTURBED OR A UTENSIL IS INSERTED INTO THE LIQUID. To reduce the risk of injury to persons:
  - (a) **STIR THE LIQUID BOTH BEFORE AND HALFWAY THROUGH HEATING.**
  - (b) **DO NOT heat water and oil, or fats together. The film of oil will trap steam, and may cause a violent eruption.**
  - (c) **DO NOT** use straight-sided containers with narrow necks.
  - (d) After heating, allow the container to stand in the microwave oven for a short time before removing the container.
19. **DO NOT** cook directly on the flat table. It can crack, and cause injury or damage to the oven.

### **WARNING**

## Safety Precautions

#### **TO AVOID THE RISK OF SHOCK:**

**DO NOT** remove outer panel from oven. Repairs must be done only by a qualified service person.

#### **TO REDUCE THE RISK OF EXPOSURE TO MICROWAVE ENERGY:**

**DO NOT** tamper with, or make any adjustments or repairs to Door, Control Panel Frame, Safety Interlock Switches, or any other part of the oven. Microwave leakage may result.

#### **TO AVOID THE RISK OF FIRE:**

1. **DO NOT** operate the microwave oven empty or use metal containers. When using the microwave oven without water or food, microwave energy cannot be absorbed and will continuously reflect throughout the cavity. This will cause arcing and damage the oven cavity, door or other components, which can lead to a fire hazard.

2. **DO NOT** store flammable materials next to, on top of, or in the oven.
3. **DO NOT** dry clothes, newspapers or other materials in the oven, or use newspaper or paper bags for cooking.
4. **DO NOT** hit or strike Control Panel. Damage to controls may occur.
5. **DO NOT** use recycled paper products unless the paper product is labeled as safe for microwave oven use. Recycled paper products may contain impurities, which may cause sparking.

#### **TO AVOID THE RISK OF SCALDING:**

POT HOLDERS should always be used when removing items from the oven. Heat is transferred from the HOT food to the cooking container and from the container to the flat table. The flat table can also be very HOT after removing the cooking container from the oven. Care in handling must be exercised.

For proper use of your oven, read remaining safety cautions and Owner's Manual.



## IMPORTANT SAFETY INSTRUCTIONS (continued)

### WARNING

1. The door seals and door seal areas should be cleaned with a damp cloth. The appliance should be inspected for damage to the door seals and door seal areas and if these areas are damaged the appliance should not be operated until it has been repaired by a service technician trained by the manufacturer.
2. Do not attempt to tamper with or make any adjustments or repairs to the door, control panel housing, safety interlock switches or any other part of the oven. Do not remove the outer panel from the oven which gives protection against exposure to microwave energy. Repairs should only be done by a qualified service technician.
3. Do not operate this appliance if it has a damaged CORD OR PLUG, if it is not working properly, or if it has been damaged or dropped. It is dangerous for anyone other than a service technician trained by the manufacturer to perform repair service.
4. If the supply cord of this appliance is damaged, it must be replaced with the special cord available from the manufacturer.
5. This appliance is not intended for use by persons (including children) with reduced physical, sensory or mental capabilities, or lack of experience and knowledge unless they have been given supervision or instruction concerning use of the appliance by a person responsible for their safety. Young children should be supervised to ensure that they do not play with the appliance.
6. Only allow children to use the oven without supervision when adequate instructions have been given so that the child is able to use the oven in a safe way and understands the hazards of improper use, including escaping steam. To prevent burns, ensure that children do not touch either the hot inner surfaces or the hot outer casing after operation of the oven.
7. Liquids and foods must not be heated in sealed containers since they are liable to explode.
8. Take CAUTION when sliding out the Grill Tray from the sliding rail, do not let the Grill Tray rest half way on the sliding rail inside the oven. The sliding rail inside the oven is not designed with a stop-lock and the rail can not hold the Grill Tray.
9. Do not use water tank if it is cracked or broken, as leaking water could result in electrical failure and danger of electric shock.

#### Attention: Hot Surfaces



**The appliance produces boiling hot steam.**

## SAVE THESE INSTRUCTIONS

For proper use of your oven, read remaining safety cautions and Owner's Manual.



# Installation and Grounding Instructions

## Examine Your Oven

Unpack oven, remove all packing material and examine the oven for any damage such as dents, broken door latches or cracks in the door. Notify dealer immediately if oven is damaged. **DO NOT** install if oven is damaged.

## Placement of Oven

1. The oven must be placed on a flat, stable surface, which is more than 36" (91.6 cm) height from the ground. Place the front surface of the door three inches or more from the counter top edge to avoid accidental tipping of the microwave

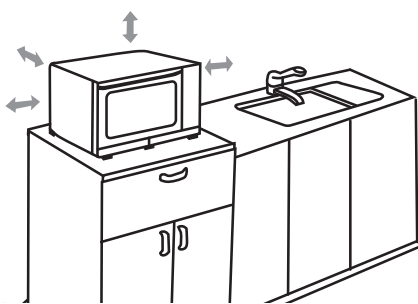

oven during normal use. For proper operation, the oven must have sufficient air flow. **Allow 6" (15 cm) of space on the top of the oven, 4" (10 cm) at the back, 2" (5 cm) on the left and the other side being open. If one side of the oven is placed flush against wall, the other side or the top must not be blocked. Do not remove the bottom feet from the oven.**

- (a) **DO NOT** block air vents. If they are blocked during operation, the oven may overheat and be damaged.
  - (b) **DO NOT** place oven near a hot, damp surface such as a gas or electric range, sink, or dishwasher.
  - (c) **DO NOT** operate oven when room humidity is excessive.
2. This oven is manufactured for household use only. It is not approved or tested for mobile vehicle, marine, or commercial use.

## Installation

**DO NOT** block air vents. If they are blocked during operation, the oven may overheat. If the oven overheats, a thermal safety device will turn the oven off. The oven will remain inoperable until it has cooled.

## WARNING: IMPROPER USE OF THE GROUNDING PLUG CAN RESULT IN A RISK OF ELECTRIC SHOCK.

Consult a qualified electrician or service person if the grounding instructions are not completely understood, or if doubt exists as to whether the appliance is properly grounded. If it is necessary to use an extension cord, use only a three-wire extension cord that has a three-prong polarized grounding plug, and a three-slot receptacle that will accept the plug of the appliance. The marked rating of the extension cord should be equal to or greater than the electrical rating of the appliance.

## Grounding Instructions

### THIS APPLIANCE MUST BE GROUNDED.

In the event of an electrical short circuit, grounding reduces the risk of electric shock by providing an escape wire for the electric current. This appliance is equipped with a cord having a grounding wire with a grounding plug. The plug must be plugged into an outlet that is properly installed and grounded.

- **Plug into properly installed and grounded three-prong outlet.**
- **DO NOT** remove ground prong.
- **DO NOT** use an adapter.

## Power Supply

1. A short power-supply cord is provided to reduce the risks resulting from becoming entangled in or tripping over a longer cord.
2. Longer cord sets or extension cords are available and may be used if care is exercised in their use. **DO NOT** let cord hang over edge of a table or counter.
3. If a long cord or extension cord is used,
  - (1) the marked electrical rating of the cord set or extension cord should be at least as great as the electrical rating of the appliance,
  - (2) the extension cord must be a grounding-type three-wire cord, and
  - (3) the longer cord should be arranged so that it will not drape over the countertop or tabletop where it can be pulled on by children or tripped over accidentally.

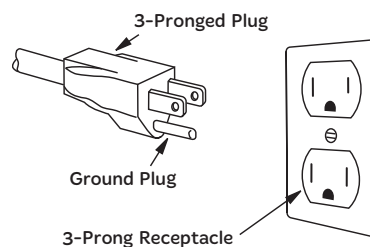



## Installation and Grounding Instructions (continued)

### Wiring Requirements

1. The oven must be operated on a SEPARATE CIRCUIT. No other appliance should share the circuit with the microwave oven. If it does, the branch circuit fuse may blow or the circuit breaker may trip.
2. The oven must be plugged into a 15 AMP or 20 AMP, 120 VOLT, 60 Hz GROUNDED OUTLET. **(Beginning in 2017, all new construction and all renovated single family homes must have at least a 20 A, 120 VOLT, 60 Hz GROUNDED OUTLET).** Where a standard two-prong outlet is encountered, it is the responsibility and obligation of the consumer to have it replaced with a properly grounded three-prong outlet.
3. The VOLTAGE used must be the same as specified on this microwave oven (120 V, 60 Hz). Using a higher voltage is dangerous and may result in a fire or oven damage. Using a lower voltage will cause slow cooking. Panasonic is NOT responsible for any damages resulting from the use of the oven with any voltage other than specified.

### TV / RADIO / WIRELESS EQUIPMENT INTERFERENCE

This product has been tested and found to comply with the limits for Microwave Oven, pursuant to Part 18 of the FCC Rules. This product can radiate radio frequency energy, which could cause interference to such products as radio, TV, baby monitor, cordless phone, Bluetooth, wireless router, etc., which can be confirmed by turning this product off and on. If present, the user is encouraged to try to correct by taking one or more of the following countermeasures:

- (1) Increase the spacing distance between the microwave oven and other product receiving the interference.
- (2) If possible, use a properly installed receiver antenna and/or reorient the receiving antenna of the other product receiving the interference.
- (3) Plug the microwave oven into a different outlet from the other product receiving the interference.
- (4) Clean door and sealing surfaces of the oven. (See Care and Cleaning of Your Microwave Oven)

### Fan Motor Operation

After using the oven, the fan may rotate to cool the electric components and "COOLING" appears in the display window. You can take out the food from the oven while the fan operates. It is recommended to keep the oven plugged in until the Fan Motor completely stops operating.

Note: It's normal for the door cooling fan (inside the door) to remain operating after the cooking. No "COOLING" display during this cooling period.

### Oven Light

When it becomes necessary to replace the oven light, please consult Panasonic for the nearest authorized service centre for examination or repair. Contact information is provided in the warranty page 54.



# Food Preparation

Follow these Safety Precautions when cooking in your oven.

## **IMPORTANT**

**Proper cooking depends upon the power, the time setting and quantity of food. If you use a smaller portion than recommended but cook at the time for the recommended portion, fire could result.**

### **1) HOME CANNING / STERILIZING / DRYING FOODS / SMALL QUANTITIES OF FOODS**

- **DO NOT** use your oven for home canning. Your oven cannot maintain the food at the proper canning temperature. The food may be contaminated and then spoil.
- **DO NOT** use the microwave oven to sterilize objects (baby bottles, etc.). It is difficult to keep the oven at the high temperature needed for sterilization.
- **DO NOT** dry meats, herbs, fruits or vegetables in your oven. Small quantities of food or foods with low moisture content can dry out, scorch or catch on fire if overheated.

### **2) POPCORN**

**Popcorn may be popped in a microwave oven corn popper. Microwave popcorn which pops in its own package is also available. Follow popcorn manufacturers' directions and use a brand suitable for the cooking power of your microwave oven.**

**CAUTION: When using pre-packaged microwave popcorn, you can follow recommended package instructions or use the Popcorn menu (refer to page 33). Otherwise, the popcorn may not pop adequately or may ignite and cause a fire. Never leave the oven unattended when popping popcorn. Allow the popcorn bag to cool before opening, and always open the bag facing away from your face and body to prevent steam burns.**



### **3) DEEP FAT FRYING**

- **DO NOT** deep fat fry in your microwave oven. Cooking oils may burst into flames and may cause damage to the oven and may result in burns. Microwave utensils may not withstand the temperature of the hot oil, and can shatter or melt.

### **4) FOODS WITH NONPOROUS SKINS**

- **DO NOT COOK / REHEAT WHOLE EGGS, WITH OR WITHOUT THE SHELL.**

Steam buildup in whole eggs may cause them to explode, and possibly damage the oven or cause injury. Reheating SLICED hard-boiled eggs and cooking SCRAMBLED eggs is safe.



- **Potatoes, apples, whole squash and sausages** are examples of foods with nonporous skins. These types of foods must be pierced before microwave cooking to prevent them from exploding.



**CAUTION: Cooking dry or old potatoes can cause fire.**

### **5) FLAT TABLE / COOKING CONTAINERS / FOIL**

- Cooking containers get hot during microwaving. Heat is transferred from the HOT food to the container and the flat table. Use pot holders when removing containers from the oven or when removing lids or plastic wrap covers from cooking containers, to avoid burns.
- The flat table will get hot during cooking. It should be allowed to cool before paper products, such as paper plates or microwave popcorn bags, are placed in the oven for microwave cooking.
- When using foil in the oven, allow at least 1-inch (2.5 cm) of space between foil and interior oven walls or door.
- Dishes with metallic trim should not be used, as arcing may occur.

### **6) PAPER TOWELS / CLOTHS**

- **DO NOT** use paper towels or cloths which contain a synthetic fiber woven into them. The synthetic fiber may cause the towel to ignite. Use paper toweling under supervision.



## Food Preparation (continued)

### 7) BROWNING DISHES / OVEN COOKING BAGS

- Browning dishes or grills are designed for microwave cooking only. Always follow instructions provided by the manufacturer. **DO NOT** preheat browning dish more than six minutes.
- If an oven cooking bag is used for microwave cooking, prepare according to package directions. **DO NOT** use a wire twist-tie to close bag. Instead use plastic ties, cotton string or a strip cut from the open end of the bag.



### 8) THERMOMETERS

- **DO NOT** use a conventional meat thermometer in your oven. Arcing may occur. Microwave safe thermometers are available for both meat and candy.



### 9) BABY FORMULA / BABY FOOD

- **DO NOT** heat baby formula or baby food in the microwave oven. The glass jar or surface of the food may appear warm while the interior can be so hot as to burn the infant's mouth and esophagus.



### 10) REHEATING PASTRY PRODUCTS

- When reheating pastry products, check temperatures of any fillings before eating. Some foods have fillings, which heat faster and can be extremely hot, while the surface remains warm to the touch (for example, jelly donuts).

### 11) GENERAL OVEN USAGE GUIDELINES

- **DO NOT** use the oven for any purpose other than the preparation of food. This oven is specifically designed to heat or cook food. **DO NOT** use this oven to heat chemicals or other non-food products.
- Before use, check that utensils/containers are suitable for use in microwave ovens.
- **DO NOT** attempt to use this microwave oven to dry newspaper, clothing or any other materials. They may catch fire.
- When the oven is not being used, **DO NOT** store any objects other than oven accessories inside the oven in case it is accidentally turned on.
- The appliance shall not be operated by Microwave or Combination **WITHOUT FOOD IN THE OVEN**. Operation in this manner may damage the appliance.
- If smoke or a fire occurs in the oven, touch the **Stop/Reset** Pad and leave the door closed in order to extinguish the flames. Disconnect the power cord, or shut off power at the fuse.

- During and after cooking with the steam function, do not open the oven door when your face is very close to the oven. Care must be taken when opening the door as steam may cause injury.

**CAUTION! Hot steam will escape when the door is opened. If there is steam in the oven, use caution when taking containers out of the oven. Always use oven gloves to remove items from the oven TO AVOID THE RISK OF SCALDING. Do Not reach in with your bare hands.**

- Extreme caution must be used when moving hot liquids.
- When handling cooking containers take care not to let the contents spill.
- Avoid hot steam, serious burns and scalds could result.
- To prevent injury, do not allow anyone to lean, hang, sit or place heavy items on the open door of the appliance. Severe personal injury could result.
- Do not use a steam cleaner to clean this appliance. The steam from the cleaning appliance could penetrate live components and permanently damage the oven or cause injury.
- The use of accessories not recommended by Panasonic may cause injury.

### 12) HEATER OPERATION

- Exterior oven surfaces, including air vents on the cabinet and the oven door will get hot during Oven, Steam, Combination or Grill functions. To prevent burns, take care when opening or closing the door and when inserting or removing food and accessories.
- The oven has heaters situated in the top and rear of the oven. During and after using either the Oven, Steam, Combination or Grill functions, all inside surfaces of the oven will be very hot. To prevent burns, care should be taken to avoid touching the inside surfaces of the oven.
- **TO AVOID THE RISK OF SCALDING**, please use caution when touching accessible parts when oven is operated in Oven, Grill or Combination mode, because the accessible parts may become extremely hot.

### 13) BEFORE USING YOUR OVEN

- Before using the oven for the first time, wipe excessive oil off in the oven cavity and operate the oven without food and accessories on Oven at 425 °F (220 °C), for 10 minutes. This will allow the oil that is **used for rust protection to be burned off. This is the only time the oven is used empty.** (with the exception of preheating on Oven.)
- **DO NOT** use the water tank without the sealed lid and never remove the sealing band from around the water tank lid, as leaking water could result in electrical failure and danger of electric shock.

# Cookware Guide

Item	Microwave	Grill	Oven	Combination			Steam	300 W + Steam	Comments
				Crispy Grill	Combo 1 (Grill + Steam)	Combo 2 (Grill + Microwave)			
Grill Tray (oven accessories)	No	Yes	Yes	Yes	Yes	No	Yes	No*	See details on page 13.
Wire Rack (oven accessories)	No	Yes	Yes	No	No	Yes	No	No	See details on page 13.
Aluminum Foil	Yes for Shielding only	Yes	Yes	No	Yes	Yes for Shielding only	No need	Yes for Shielding only	Small strips of foil can be molded around thin parts of meat or poultry to prevent overcooking. Arcing can occur if foil is too close to oven wall or door and damage to your oven will result.
Browning Dish	Yes	No	No	No	No	No	Yes	Yes	Browning dishes are designed for microwave cooking only. Check browning dish information for instructions and heating chart. Do not preheat for more than 6 minutes.
Dinnerware	Labeled "Oven/Microwave-safe"	Yes	Yes	Yes	No	Yes	Yes	Yes	Check manufacturers' use and care directions for use in oven/microwave heating. Some dinnerware may state on the back of the dish, "Oven/Microwave-safe".
	Labeled "Microwave-safe"	Yes	No	No	No	No	Yes	Yes	Some dinnerware may state on the back of the dish, "Oven/Microwave-safe".
	Unlabeled	No	No	No	No	No	No	No	See CONTAINER TEST on page 12.
Disposable polyester Paperboard Dishes	Yes	No	No	No	No	No	No	No	Some frozen foods are packaged in these dishes. Can be purchased in grocery stores.
Fast Food Carton with Metal Handle	No	No	No	No	No	No	No	No	Metal handle may cause arcing and create a fire hazard.
Frozen Dinner Tray Metal	No	Yes	Yes	No	Yes	No	Yes	No	Metal can cause arcing and damage to your oven in the Microwave and Combo 2 modes.
Frozen Dinner Tray Microwave-safe	Yes	No	No	No	No	No	Yes	Yes	For one time use only. Do not reuse.
Glass Jars	No	No	No	No	No	No	No	No	Most glass jars are not heat resistant. Do not use for cooking or reheating.
Heat Resistant Oven Glassware & Ceramics	Yes	Yes	Yes	No	Yes	Yes	Yes	Yes	Ideal for microwave cooking and browning. (See CONTAINER TEST on page 12.)

\* Follow the cook book.

## Cookware Guide (continued)

Item	Microwave	Grill	Oven	Combination			Steam	300 W + Steam	Comments
				Crispy Grill	Combo 1 (Grill + Steam)	Combo 2 (Grill + Microwave)			
Metal Convection Bake ware	No	Yes	Yes	No	Yes	No	Yes	No	Metal can cause arcing and damage to your oven in the Microwave and Combo 2 modes.
Metal Twist-Ties	No	Yes	Yes	No	Yes	No	Yes	No	Metal can cause arcing and damage to your oven in the Microwave and Combo 2 modes.
Oven Cooking Bag	Yes	Yes	Yes	No	Yes	Yes	Yes	Yes	Follow manufacturers' directions. Close bag with the nylon tie provided, a strip cut from the end of the bag, or a piece of cotton string. Do not close with metal twist-tie for the Microwave or Combo 2 mode. Make six ½-inch (1 cm) slits near the closure.
Paper bags	No	No	No	No	No	No	No	No	May cause a fire in the oven.
Paper Plates & Cups	Yes, with supervision	No	No	No	No	No	No	Yes, with supervision	Use to warm cooked foods, and to cook foods that require short cooking times such as hot dogs in the Microwave mode.
Paper Towels & Napkins	Yes, with supervision	No	No	No	No	No	No	Yes, with supervision	Use to warm rolls and sandwiches, only if labeled safe for microwave use.
Recycled Paper Towels & Napkins	No	No	No	No	No	No	No	No	Recycled paper products may contain impurities which may cause sparks or create a fire hazard.
Parchment Paper	Yes	Yes	Yes	No	No	Yes	No	No	Use as a cover to prevent spattering. Safe for use in the Microwave, Oven, Grill and Combination modes.
Plastic, Microwave-safe	Yes, use caution	No	No	No	No	No	Yes, use caution	Yes, use caution	Should be labeled, "Suitable for Microwave Heating". Check manufacturers' directions for recommended uses. Some microwave-safe plastic containers are not suitable for cooking foods with high fat or sugar content. The heat from hot food may cause the plastic to warp.
Plastic, Melamine	No	No	No	No	No	No	No	No	This material absorbs microwave energy. Dishes get HOT!

## Cookware Guide (continued)

Item	Microwave	Grill	Oven	Combination			Steam	300 W + Steam	Comments
				Crispy Grill	Combo 1 (Grill + Steam)	Combo 2 (Grill + Microwave)			
Plastic Foam Cups	Yes, short term only	No	No	No	No	No	No	Yes, short term only	Plastic foam will melt if foods reach a high temperature. Use caution to reheat foods to a low serving temperature only.
Silicon Rubber Container	Yes	Yes	Yes	No	Yes	Yes	Yes	Yes	Check Manufacturer's directions for recommended uses.
Plastic Wrap	Yes	No	No	No	No	No	No need	No need	Use to cover food during cooking to retain moisture and prevent spattering. Should be labeled "Suitable for Microwave Heating". Check package directions.
Straw, Wicker, Wood	Yes, short term only	No	No	No	No	No	Yes, short term only	Yes, short term only	Use only for short term reheating and to bring food to a low serving temperature. Wood may dry out & split or crack when used.
Thermometers, Microwave-safe	Yes	No	No	No	No	No	Yes	Yes	Use only microwave-safe meat and candy thermometers.
Thermometers, Conventional	No	Yes	Yes	No	No	No	No	No	Not suitable for use in microwave oven, will cause sparks and get hot.
Wax paper	Yes	No	No	No	No	No	Yes	Yes	Use as a cover to prevent spattering and to retain moisture in the Microwave mode only.

### CONTAINER TEST

**TO TEST A CONTAINER FOR SAFE MICROWAVE OVEN USE:** Fill a microwave-safe cup with cool water and place it in the microwave oven alongside the empty container to be tested; **heat one (1) minute at 1000 W.** If the container is microwave oven safe (transparent to microwave energy), the empty container should remain comfortably cool and the water should be hot. If the container is hot, it has absorbed some microwave energy and should NOT be used. This test cannot be used for plastic containers.

# Location of Controls

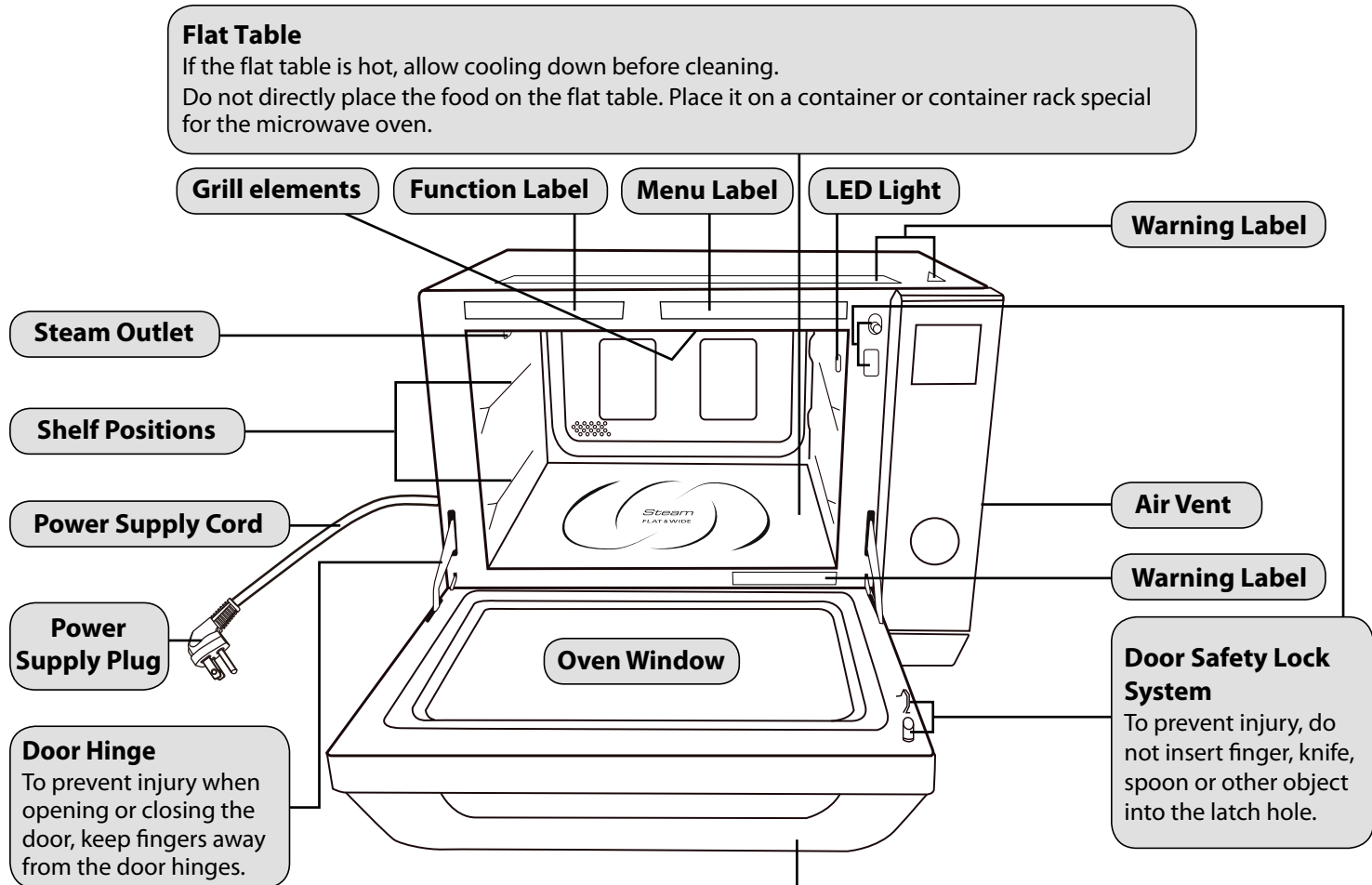

### Flat Table

If the flat table is hot, allow cooling down before cleaning.  
Do not directly place the food on the flat table. Place it on a container or container rack special for the microwave oven.

Steam Outlet

Shelf Positions

Power Supply Cord

Power Supply Plug

### Door Hinge

To prevent injury when opening or closing the door, keep fingers away from the door hinges.

Oven Window

Warning Label

Air Vent

Warning Label

### Door Safety Lock System

To prevent injury, do not insert finger, knife, spoon or other object into the latch hole.

### Bottom feeding technology

Please note that this product uses bottom feeding technology for microwave distribution which differs from traditional turntable side feeding methods and creates more useable space for a variety of different sized dishes. This microwave feeding style can give a difference in heating times (in microwave mode) when compared against side feeding appliances. This is quite normal and should not cause any concern.

### Door Handle

Opening the door during cooking will stop the cooking process without cancelling the program. Cooking resumes as soon as the door is closed and **Start** pad is touched. The oven light will turn on and stay on whenever the door is opened. It is quite safe to open the door at any time during a cooking program and there is no risk of Microwave exposure.



### Grill Tray

1. Do not place it on the oven window. Otherwise, the oven window may be damaged.
2. Use oven gloves when removing the Grill Tray as it will be very hot, and so will the roof and walls of the oven.
3. Grill Tray should be cleaned regularly.
4. Grill Tray is dishwasher safe.

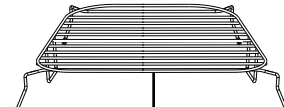

### Wire Rack

1. A Wire Rack is included with the oven in order to facilitate browning of small dishes.
2. Wire Rack should be cleaned regularly.
3. When using Wire Rack in the manual Grill, Oven and Combo 2 cooking modes, be careful to choose heat-proof containers; containers made of plastic or paper may melt or burn when exposed to the heat radiating from the grill.
4. When using the Combo 2 mode, never place any aluminum or metal container directly on Wire Rack. Always insert a glass plate or dish between Wire Rack and the aluminum container. This will prevent sparking that may damage the oven.
5. Do not use Wire Rack when cooking in the MICROWAVE mode only.

### Oven Light:

Oven Light will turn on during cooking and also when door is opened.

### NOTE:

The above illustration is for reference only.  
The Grill Tray and Wire Rack are the only accessories with this oven.  
All other cooking utensils mentioned in this manual must be purchased separately.

## Location of Controls (continued)

### Front View

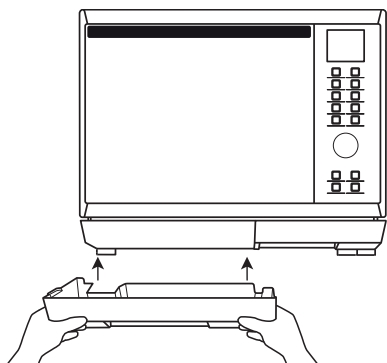
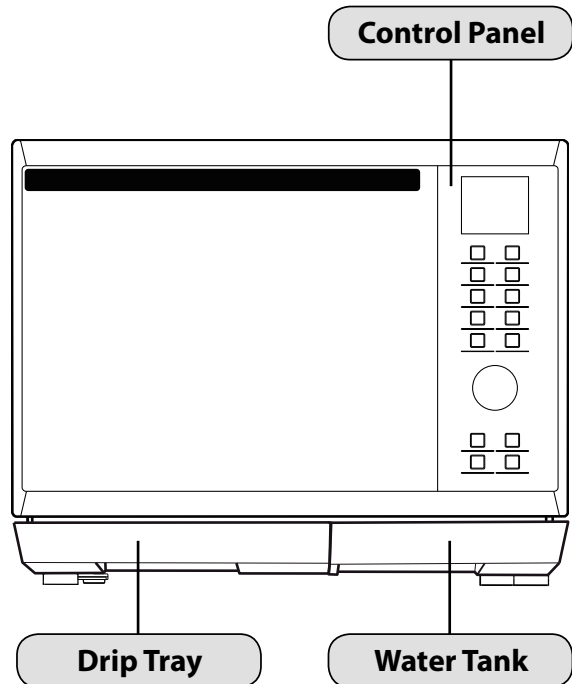

Re-position the drip tray by clicking back onto the legs.

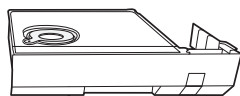

### Water Tank

Carefully remove the water tank from the oven. Remove the lid and fill with pure water (do not use mineral water). Replace the lid and position back in the oven. Ensure the lid is closed tightly and securely positioned, otherwise leakage may occur. It is recommended to clean the water tank in warm water once a week.

### Rear View

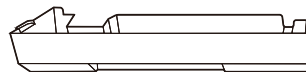
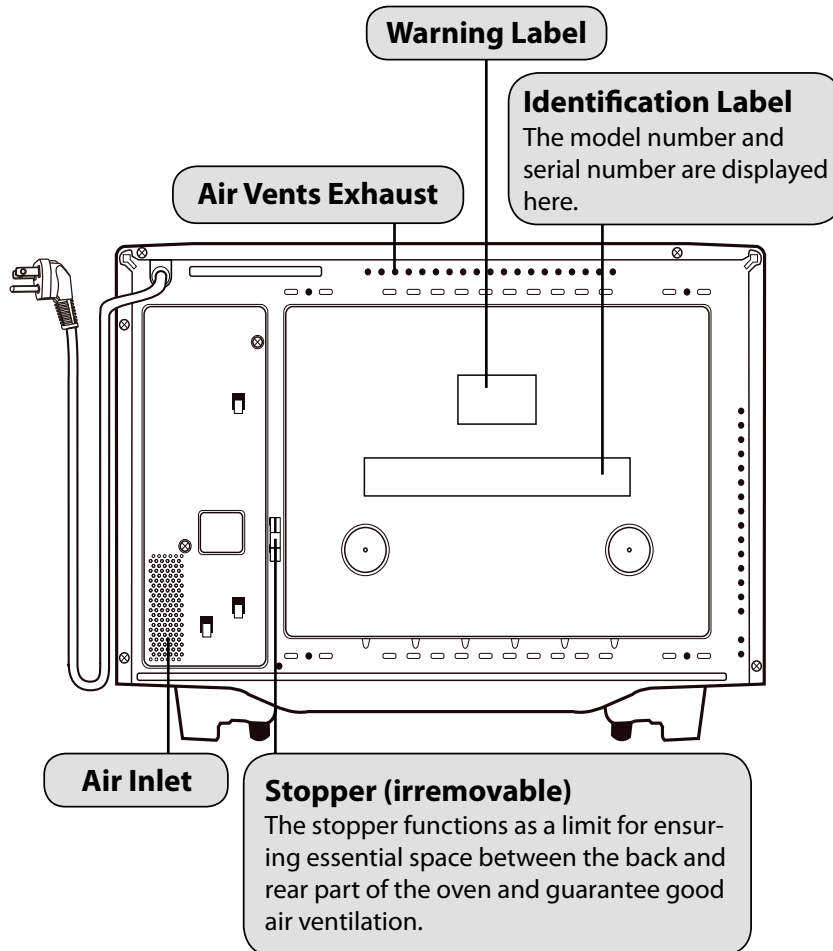

### Drip Tray

1. Before using the oven, the drip tray must be fitted as it collects excess water during cooking. The drip tray should be removed and cleaned on a regular basis.
2. Fit the drip tray by holding with both hands and clicking onto the front legs of the oven.
3. To remove the drip tray, hold with both hands and gently ease forward. Wash in warm soapy water. Re-position the drip tray by clicking back onto the legs.
4. DO NOT USE A DISHWASHER TO CLEAN THE DRIP TRAY.

### NOTE:

The above illustration is for reference only.

# Control Panel

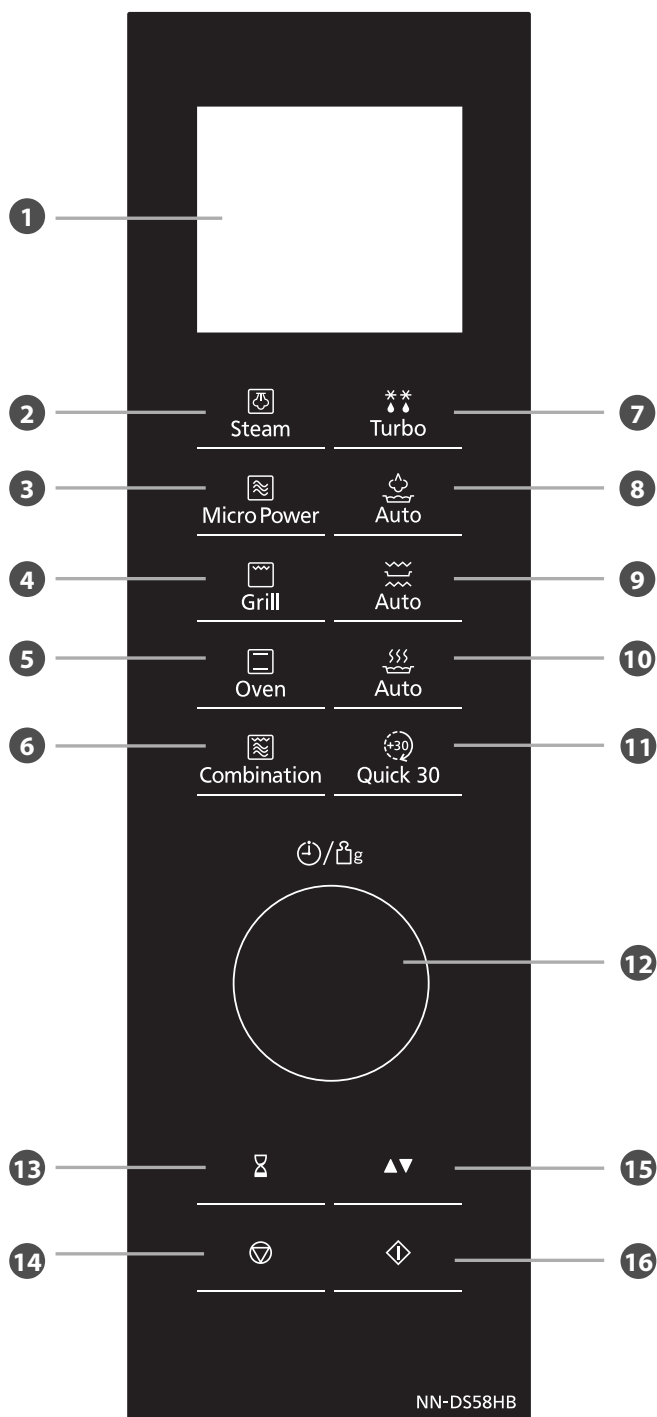

1. **Display Window** (see page 16)
2. **Steam** (see page 23-24)
3. **Micro Power** (see page 21-22)
4. **Grill** (see page 27)
5. **Oven** (see page 25-26)
6. **Combination** (see page 28-30)
7. **Inverter Turbo defrost** (see page 34)
8. **Auto steam programs** (see page 35)
9. **Auto grill programs** (see page 36)
10. **Auto cook programs / Cleaning** (see page 33, 37; page 42-43)
11. **Quick 30** (see page 33)
12. **Time/Weight Dial** (see page 16)
13. **Timer/Clock** (see page 20, 31)
14. **Stop/Reset**
  - Before cooking:** One touch clears your instructions.
  - During cooking:** One touch temporarily stops the cooking process. Another touch cancels all your instructions and colon or time of day appears in the display window.
15. **More/Less** (see page 34)
16. **Start**
  - One touch allows oven to begin functioning. If door is opened or **Stop/Reset** is touched once during oven operation, **Start** must again be touched to restart oven.

## Beep Sound:

When a pad is pressed correctly, a beep sound will be heard. If a pad is pressed and no beep is heard, the unit did not or could not accept the instruction. The oven will beep twice between programmed stages. The oven will beep 3 times after preheating. At the end of any completed program, the oven will beep 5 times.

## NOTE:

1. The oven will enter stand-by mode, when first plugged in and immediately after the last operation has completed.
2. When in standby mode, the brightness of the display will be reduced.
3. If an operation is set and **Start** is not touched, after 6 minutes, the oven will automatically cancel the operation. This display will revert back to clock or colon mode.

## NOTE:

The above illustration is for reference only.



## Display Window

To help you operate the oven conveniently, the present state will appear in the display window.

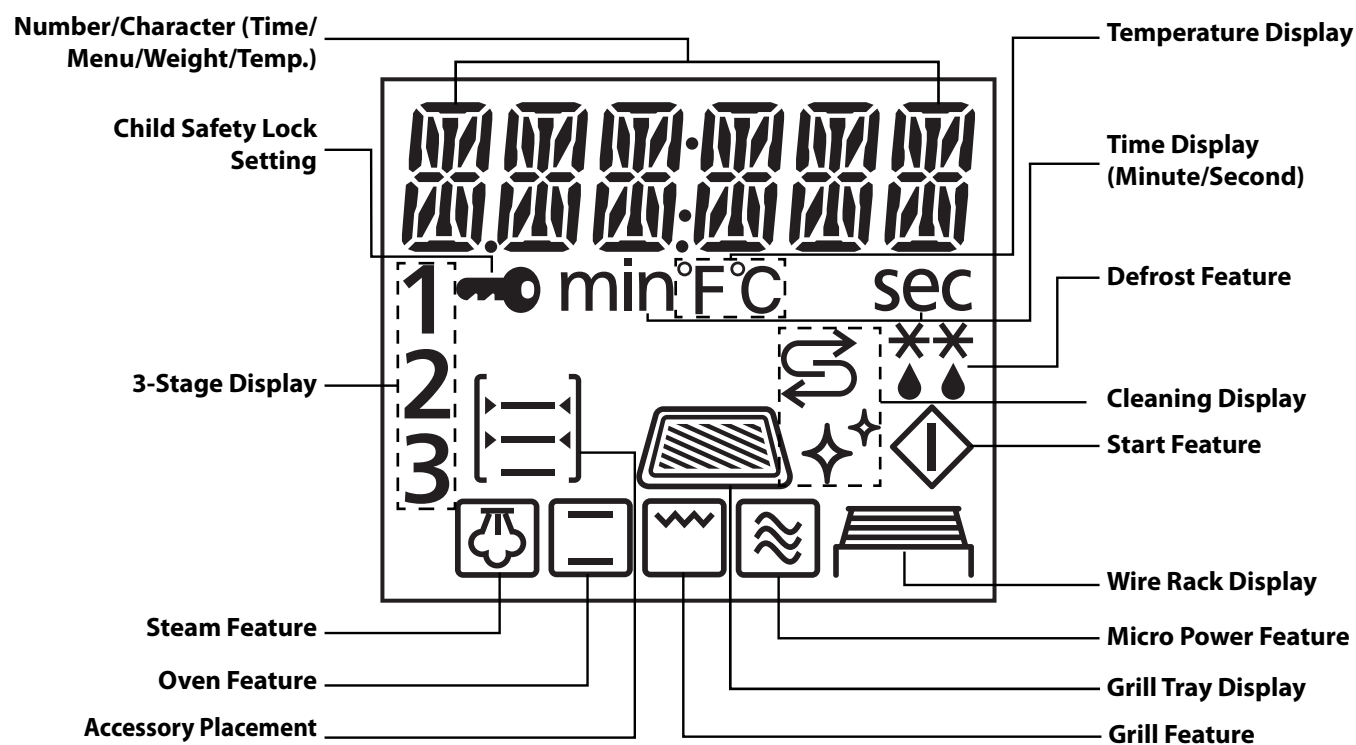

## Dial Feature

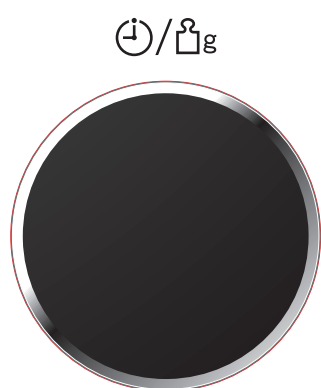

### Time Setting

To set cooking time or clock.

### Weight Setting

To set weight of food for inverter turbo defrost, auto steam, auto grill and auto cook menus.

### NOTE:

1. You can setting the time by **Time/Weight** dial or **Quick 30** pad. (But they cannot be used interactively.)
2. Touch **Quick 30** pad, time can be increased in 30 seconds increments, up to 5 minutes.

### NOTE:

The above illustration is for reference only.

# Cooking Modes

The diagrams shown below are examples of the accessories. It may vary depending on recipe/dish used.

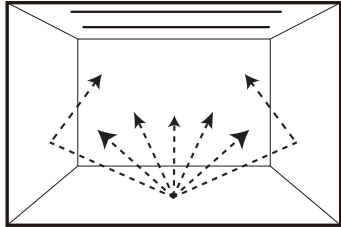
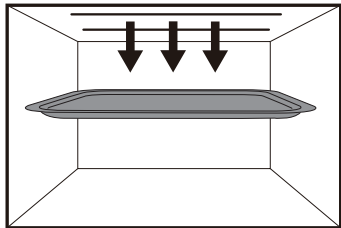
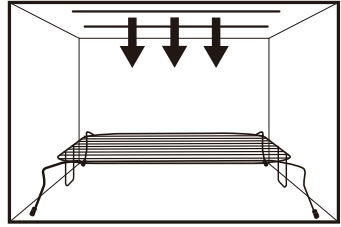
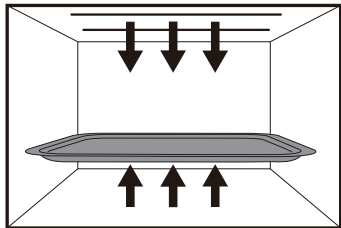
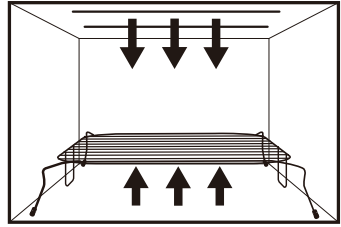
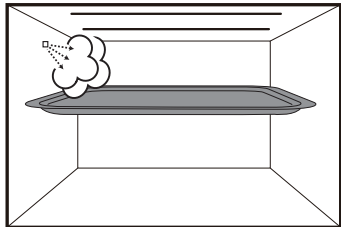
Cooking modes	Uses	Recommended accessories	Containers
<p><b>MICROWAVE</b></p> 	<ul style="list-style-type: none"> <li>Defrosting</li> <li>Reheating</li> <li>Melting: butter, chocolate, cheese.</li> <li>Cooking fish, vegetables, fruits, eggs.</li> <li>Preparing: stewed fruits, jam, sauces, custards, choux, pastry, caramel, meat, fish.</li> <li>Baking cakes without colour.</li> </ul> <p><b>No Preheating</b></p>	-	Use your own Pyrex® dishes, plates or bowls, directly on the base of the oven. Microwaveable, no metal.
<p><b>GRILL</b></p>  <p>or</p> 	<ul style="list-style-type: none"> <li>Grilling of meat or fish.</li> <li>Toast grilling.</li> <li>Colouring of gratin dishes or meringue pies.</li> </ul> <p><b>No Preheating</b></p>	Grill Tray or Wire Rack	Heatproof, metal tin can be used on Grill Tray in lower or upper shelf positions or place foods directly on Wire Rack with heatproof dishes underneath.
<p><b>OVEN</b></p>  <p>or</p> 	<ul style="list-style-type: none"> <li>Baking of small items with short cooking times: puff pastry, cookies, roll cakes, scones.</li> <li>Special baking: bread rolls or brioches, sponge cakes.</li> <li>Baking of pizzas and tarts.</li> </ul> <p><b>Preheating advised</b></p>	Grill Tray or Wire Rack	Heatproof, metal tin can be used on Grill Tray in lower or upper shelf positions or place foods directly on Wire Rack with heatproof dishes underneath.
<p><b>STEAM</b></p> 	<ul style="list-style-type: none"> <li>Cooking fish, vegetables, chicken, rice, and potatoes.</li> </ul> <p><b>No Preheating</b></p>	Grill Tray	Heatproof container on Grill Tray in upper or lower shelf positions.

## Cooking Modes (continued)

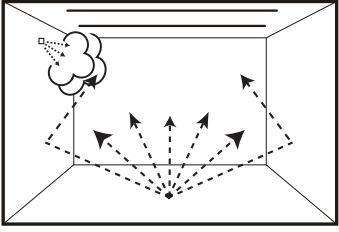
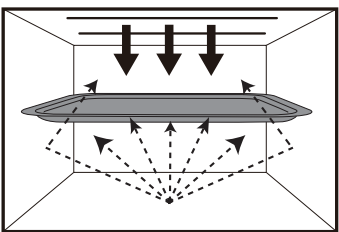
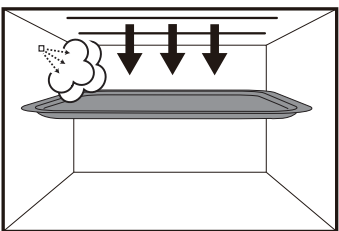
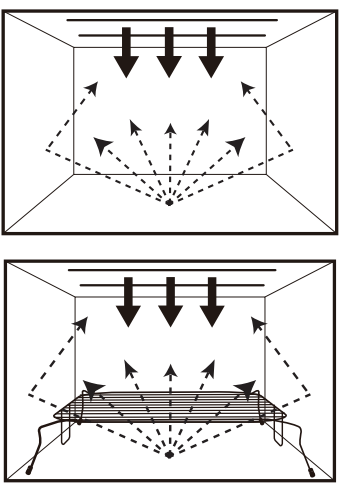
Cooking modes	Uses	Recommended accessories	Containers
<p style="text-align: center;"><b>300 W + STEAM (MICROWAVE + STEAM)</b></p> 	<ul style="list-style-type: none"> <li>Cooking fish, vegetables, chicken, rice, and potatoes.</li> </ul> <p><b>No Preheating</b></p>	-	Microwaveable and heatproof dishes placed directly on base of oven.
<p style="text-align: center;"><b>CRISPY GRILL</b></p> 	<ul style="list-style-type: none"> <li>Roasting chicken pieces, seafood, fried foods, meat skewers, frozen potato fries, pizza etc.</li> </ul> <p><b>No Preheating</b></p>	Grill Tray in upper or lower shelf positions.	-
<p style="text-align: center;"><b>COMBO 1 (GRILL + STEAM)</b></p> 	<ul style="list-style-type: none"> <li>Cooking gratins</li> <li>Kebabs</li> <li>Fish fillets</li> <li>Whole fish</li> <li>Part baked bread</li> </ul> <p><b>No Preheating</b></p>	Grill Tray	Microwaveable and heatproof dishes can be used on the Grill Tray in the lower or upper shelf positions.
<p style="text-align: center;"><b>COMBO 2 (GRILL + MICROWAVE)</b></p> 	<ul style="list-style-type: none"> <li>Cooking lasagne, meat, potatoes or vegetable gratins.</li> </ul> <p><b>No Preheating</b></p>	Wire Rack	Place foods directly on Wire Rack with microwaveable and heatproof dishes underneath. Or microwaveable and heatproof dishes placed directly on base of oven.

# Operation — Using the Microwave for the First Time / Function Features

## Using the Microwave for the First Time

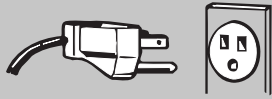

Display Window



Plug into a properly grounded electrical outlet. **"WELCOME TO PANASONIC REFER TO OWNER'S MANUAL BEFORE USE"** scrolls across display window.

## Function Features

This unique function of your Panasonic microwave oven allows you to establish the initial non-cooking features of your Oven. This microwave oven has the functions below:

- **WEIGHT/TEMPERATURE UNITS CHOICE**
- **LANGUAGE CHOICE**
- **BEEP CHOICE**

**Plug into a properly grounded electrical outlet.**

### WEIGHT/TEMPERATURE UNITS CHOICE:

The oven has a choice of Metric Units or Imperial Units display.

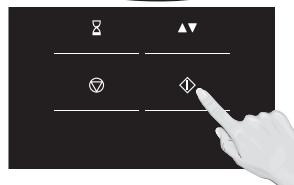

Touch **Start** once. **"LB-F/KG-C"** scrolls across display window.

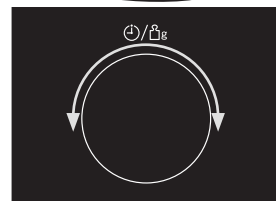

Select the **"LB-F"** or **"KG-C"** by turning **Time/Weight** dial. The default weight unit is LB-F.

**3**  
After setting, touch **Stop/Reset** to exit.

**LANGUAGE CHOICE:** The oven has a choice of English or French display.

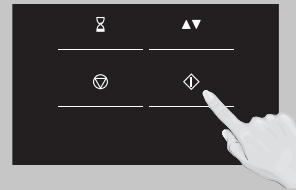

Touch **Start** twice. **"LANGUAGE"** scrolls across display window. The default language is English.

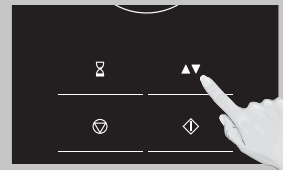

Touch **More/Less** once. The display language changes to French. Touch **More/Less** twice. The display language return to English.

**3**  
After setting, touch **Stop/Reset** to exit.

**BEEP CHOICE:** The oven has both Beep On and Beep Off mode.

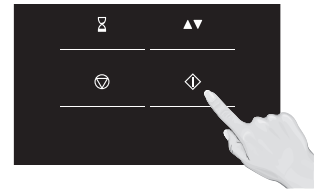

Touch **Start** 3 times. **"BEEP ON/OFF"** scrolls across display window. The default mode is Beep **ON**.

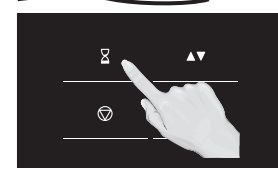
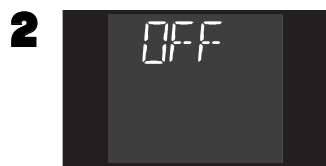

Touch **Timer/Clock** once. The mode changes to Beep **OFF**.

**3**  
After setting, touch **Stop/Reset** to exit.

### NOTES:

1. These choices can be selected only when you plug-in the oven.
2. Touch **Stop/Reset**, it will revert to initial mode (" : ").
3. After setting, it will revert back to Weight/Temperature Units Choice setting if **Start** pad is touched again, touch **Stop/Reset** to exit.

# Operation — Demo Mode/ Clock / Menu Action / Child Safety Lock

## Demo Mode

**1** When "DEMO MODE PRESS ANY KEY" or "D" appears in the display window, it means the oven is under demonstration mode, microwave does not emit. Demo mode is designed for retail store display. In this mode, the oven can be demonstrated with no cooking power in the oven.

**2**  
**To cancel:**

Tap **Micro Power** once, **Start** 4 times and **Stop/Reset** 4 times.

**Step 1.**

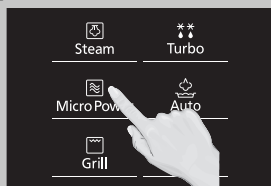

**Step 2.**

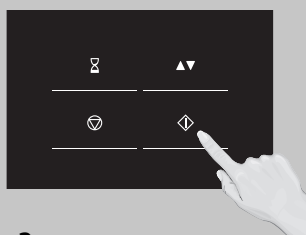

**Step 3.**

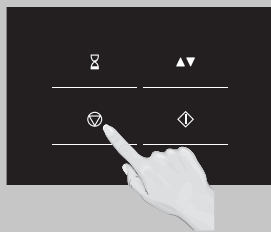

### NOTES:

1. To set Demo Mode, repeat step 1-3.
2. Default mode is Demo Mode off.

## Setting the Clock



With the oven NOT cooking, tap **Timer/Clock** twice; the colon will blink. Enter time of day using the **Time/Weight** dial.

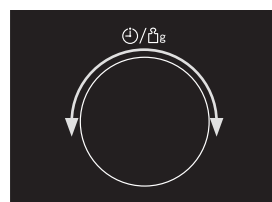

Set time of day by turning the **Time/Weight** dial. Time appears in the display window; colon continues flashing.



Touch **Timer/Clock** to finish setting and the colon (:) will stop blinking.

### NOTES:

1. To reset the clock, repeat steps.
2. The clock will retain the time of day as long as the oven is plugged in and electricity is supplied.
3. The clock is a 12-hour display.
4. Oven will not operate while colon (:) is flashing.
5. One turn of the dial will increase or decrease the time by 1 minute. Continuously turning the dial will rapidly increase or decrease the time.

## Menu Action ON/OFF

This feature helps you to program your oven by prompting the next step to be taken. When you become familiar with your oven, the prompt can be turned off. This feature can be selected when **colon or clock** appears in the display window.

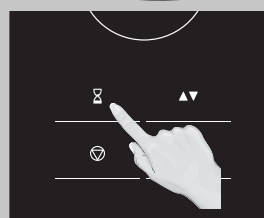

Touch **Timer/Clock** 4 times to set menu action on and off.

### NOTE:

Default mode is Menu Action on.

## Setting the Child Safety Lock

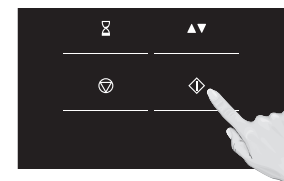
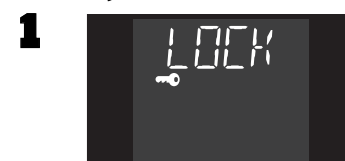

When the colon or time of day appears in the display, tap **Start** 3 times; "🔒" and "LOCK" will appear in the display.

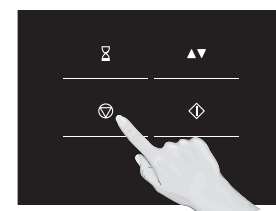

Tap **Stop/Reset** 3 times; the display will return to the colon or time of day and Child Lock will be cancelled.

### NOTES:

1. This feature prevents the electronic operation of the oven until cancelled. It does not lock the door.
2. To set or cancel child safety lock, **Start** or **Stop/Reset** must be tapped 3 times within 10 seconds.
3. You can set Child Lock feature when the display shows a colon or time of day.

# Operation — Micro Power Feature

## Micro Power Feature

This feature allows you to set the desired power and time for cooking by yourself. Do not place food directly on the base of the oven. Use your own dishes, plates or bowls covered with a lid or pierced cling film directly on the base of the oven.



Tap **Micro Power** until the power you require appears in the display window.

Touch	Power Level
once	1000 W (High)
twice	800 W (Med-High)
3 times	600 W (Medium)
4 times	440 W (Med-Low)
5 times	300 W (Defrost)
6 times	100 W (Low)
7 times	300 W (300 W + Steam)

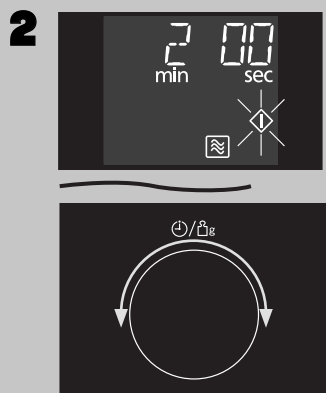

Select the cooking time by turning the **Time/Weight** dial.

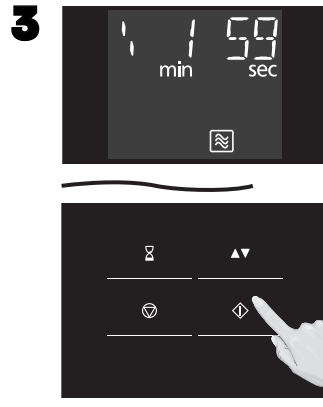

Touch once. The cooking program will start and the time in the display will count down.

## NOTES:

- When selecting 1000 W and 300 W + Steam, the maximum programmable time is 30 minutes. For other power levels, the maximum time is 1 hour 30 minutes.
- Do not attempt to use microwave only with any metal container in the oven.
- Do not place food directly onto the base of the oven. Place in a microwaveable or glass dish. Foods reheated or cooked by microwave only should be covered with a lid or pierced cling film, unless otherwise stated.
- Stand time can be programmed after microwave power and time setting.
- When cooking time is longer than 60 minutes, the time will appear in hours and minutes.
- The oven will automatically work on 1000 W microwave power if a cooking time is entered without the power level previously being selected.
- For reheating, use 1000 W for liquids, 800 W for most foods and 600 W for dense foods.
- For defrosting, use 300 W (DEFROST).

## For more than one stage cooking:

Repeat steps 1 to 2 above then touch **Start**. The maximum number of stages for cooking is 3. The oven will beep twice between stages. Five beeps will sound at the end of the entire sequence. (For further information, refer to page 32.)

## Micro Power:

The **Micro Power** pad gives you a selection of different power levels representing decreasing amounts of microwave energy, used for cooking foods at different speeds. e.g. The lower the micro power setting, the more evenly the food cooks, although it will take a little longer. To select the correct power level for cooking different foods.

# Operation — Micro Power Defrost / 300 W + Steam Feature

## Micro Power Defrost Setting Feature

This feature allows you to defrost meat, poultry and seafood by 300 W and time.



Tap **Micro Power** 5 times. Defrost symbol "☄" and microwave symbol "☇" will appear in the display window.

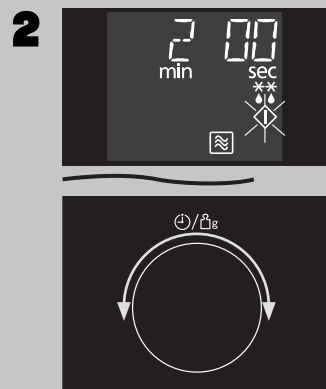

Select the defrosting time by turning the **Time/Weight** dial. (up to 1 hour 30 minutes)

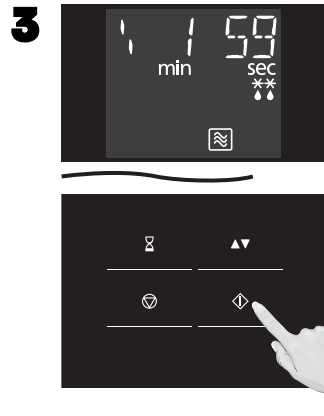

Touch once. The cooking program will start and the time in the display will count down.

### NOTE:

Opening the door and taking out the defrosted parts during the operating time is recommended. Turn over, stir or rearrange the parts which are still in icy.

## 300 W + Steam

This feature is a steam and microwave combined heating method by adjusting the settings. This can often reduce traditional oven cooking times and keep the food moist.



Tap **Micro Power** 7 times. Steam symbol "☁" and microwave symbol "☇" will appear in the display window.

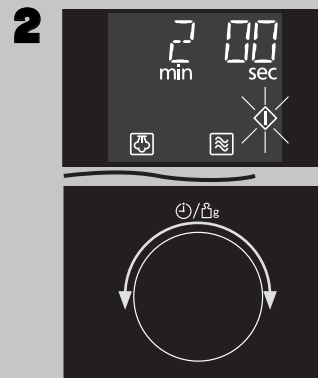

Select the cooking time by turning the **Time/Weight** dial. Maximum cooking time is 30 minutes.



Touch once. The cooking program will start and the time in the display will count down.

### NOTES:

1. Fill the water tank before use.
2. No cover lid or plastic wrap is required when using this feature.
3. The maximum time for cooking in this mode is 30 minutes. If required to cook for longer than this time, re-fill the water tank and repeat the above operation for the remaining time.
4. If during operation the water tank becomes empty, the oven will stop operation. The prompt in the display will ask you to re-fill the water tank. After re-filling the water tank and positioning back in the oven, touch **Start**. The oven will not continue cooking until the water tank has been re-filled and **Start** touched.
5. It may be necessary to wipe the excess water in the cavity after 300 W + Steam cooking.
6. Metal containers or dishes should not be used during cooking.

### Use of Accessory

- ☐ Directly on the base of the oven in a microwaveable and heatproof dish without cover.

For example:





# Operation — Steam Feature

## Steam Feature

The oven can be programmed as a steamer to cook vegetables, fish, chicken and rice. It can keep moisture of food and also can steam the food evenly. There are 3 different steam settings available.



Tap **Steam** until the power you require appears in the display window.

Touch	Power Level
once	Steam 1 (HIGH)
twice	Steam 2 (MEDIUM)
3 times	Steam 3 (LOW)

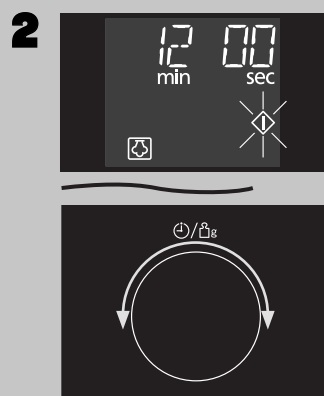

Select the cooking time by turning the **Time/Weight** dial. Maximum cooking time is 30 minutes.

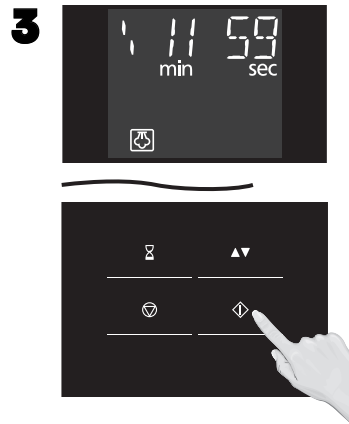

Touch once. Cooking will start. The time in the display window will count down.

## NOTES:

1. Fill the water tank before using the Steam function.
2. The maximum time for cooking in this mode is 30 minutes. If required to cook for longer than this time, re-fill the water tank and repeat the above operation for the remaining time.
3. If during operation the water tank becomes empty, the oven will stop operation. The prompt in the display will ask you to re-fill the water tank. After re-filling the water tank and positioning back in the oven, touch **Start**. The oven will not continue cooking until the water tank has been re-filled and **Start** touched.
4. It may be necessary to wipe the excess water in the cavity after Steam cooking.
5. It is possible to refill the water tank at any time during cooking, without having to touch **Stop/Reset** first.
6. After each steam operation carefully remove the drip tray from the front of the oven. Gently ease forwards, holding with both hands. After emptying, wash in warm soapy water. To re-position, click back into position on the oven legs. (See page 14)

## Caution:

1. The Grill Tray and surrounding oven will get very hot. Use oven gloves.
2. When removing the food or Grill Tray, hot water may drip from the oven top.
3. Steam may billow out when you open the door. If there is steam in the oven, do not reach in with your bare hands! Risk of burns! Use oven gloves.
4. During and after cooking with steam function, do not open the oven door when your face is very close to the oven. Care must be taken when opening the door as steam may cause injury.

# Operation — Steam Feature (continued) / Steam Shot Feature

## Steam Feature (continued)

### Guidelines for water tank

Carefully remove the water tank from the oven. Remove the lid and fill with tap water (do not use mineral water). Replace the lid and position back in the oven. Ensure the lid is closed tightly and securely positioned, otherwise leakage may occur. It is recommended to clean the water tank in warm water once a week.

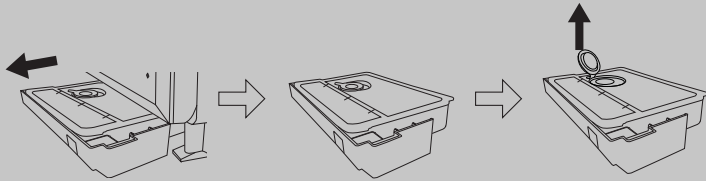

### Use of Accessory

When **steaming**, place food directly on the Grill Tray in the upper shelf position. For steaming larger food items, place the Grill Tray in the lower shelf position. During steaming, cooking juices collect in the watercourse of the tray.

Use oven gloves when removing the Grill Tray as it will be very hot, and so will the roof and walls of the oven.

### Grill Tray

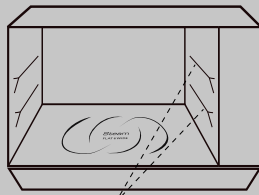

upper or lower shelf positions

For example:



## Steam Shot Feature

This feature allows you add steam during cooking (up to 3 minutes). Adding steam during cooking enhances heat distribution and aids the rising process of breads, cakes and pastries.

There are 5 types when you can use steam shot - microwave, grill, oven, crispy grill, Combo 2 (microwave + grill).

### 1 Set and operate the desired program.

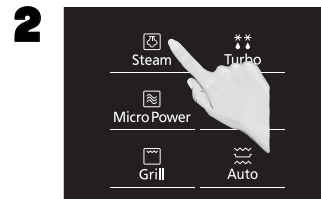

As required during operation, hold **Steam** for 2 seconds and 1 minute steam will be added.

### 3 Optional

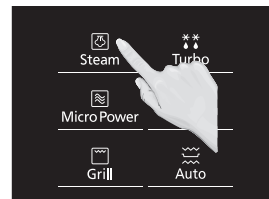

If you want to add 2 or 3 minutes, tap **Steam** pad 2 or 3 times within 3 seconds after step 2. The remaining time displayed includes steam shot time.

(Touch 3 times, time will decrease to zero. If you want to add steam again, please repeat step 3.)

## NOTES:

1. Steam shot is not available during preheating mode, 300 W + Steam, Combo 1 or at 100 °F (40 °C) Oven.
2. **Fill the water tank** before use.
3. The original program still counts down when operating steam shot.
4. The steam shot time can not exceed the remaining cooking time.
5. If adding 2 or 3 minutes, **Steam** must be tapped 2 or 3 times within a 3 second time period.
6. Wipe away excess water in the cavity and around the water tank after cooking with steam.
7. It can't change the cooking time by **Quick 30** and recall oven temperature or change oven temperature during steam shot running or setting.

## Caution:

1. The Grill Tray and surrounding oven will get very hot. Use oven gloves.
2. When removing the food or Grill Tray, hot water may drip from the oven top.
3. Steam may billow out when you open the door. If there is steam in the oven, do not reach in with your bare hands! Risk of burns! Use oven gloves.

# Operation — Oven Feature

## Oven Feature

Your combination oven can be used as an oven using the oven mode which uses top and bottom heat.

Temperature	
40 °C	100 °F
100 °C	200 °F
110 °C	225 °F
120 °C	250 °F
130 °C	275 °F
140 °C	300 °F
150 °C *	325 °F
160 °C	350 °F *
170 °C	375 °F
180 °C	400 °F
190 °C	425 °F
200 °C	
210 °C	
220 °C	

\* Default

### ■ With Preheating:

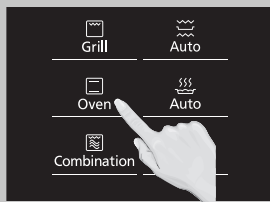
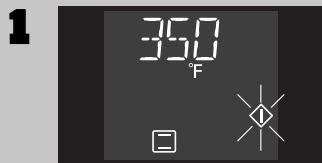

Tap **Oven**. The oven starts at 350 °F (150 °C). Tap **Oven** and the temperature will increase in 25 °F (10 °C) increments to 425 °F (220 °C), then 200 °F (100 °C).

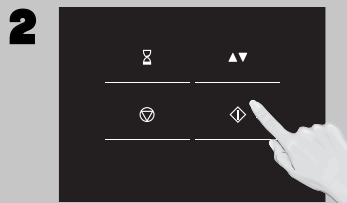

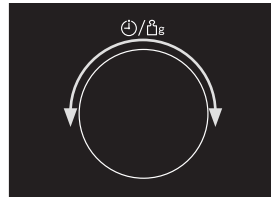

Touch **Start** to preheat the oven. "PREHEAT" will scroll across display window once then a "P" will appear in the display window. When preheating is completed, the oven will beep and "P END" will display in the display window. Then open the door and place the food inside.

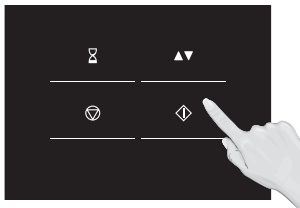
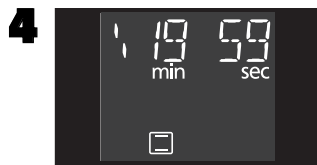

Select the cooking time turning the **Time/Weight** dial. Maximum cooking time is 1 hours 30 minutes.



Touch once. Cooking will start. The time in the display window will count down.

NOTE: Check that only the oven symbol  is still in the display. If the microwave symbol  is displayed this is incorrect and the program should be cancelled. Reselect the Oven setting.

### ■ Without Preheating:

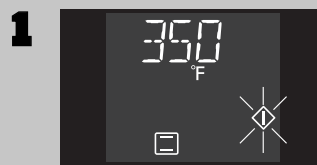

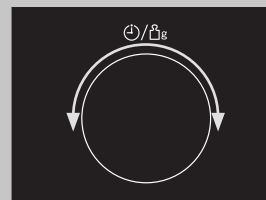
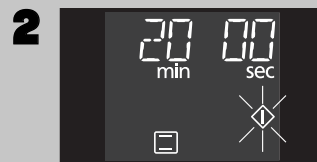

Tap **Oven**. The oven starts at 350 °F (150 °C). Tap **Oven** and the temperature will increase in 25 °F (10 °C) increments to 425 °F (220 °C), then 100 °F (40 °C) and 200 °F (100 °C).

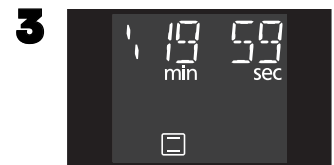

Select the cooking time turning the **Time/Weight** dial. Maximum cooking time is 1 hours 30 minutes.



Touch once. Cooking will start. The time in the display window will count down.

NOTE: Check that only the oven symbol  is still in the display. If the microwave symbol  is displayed this is incorrect and the program should be cancelled. Reselect the Oven setting.

# Operation — Oven Feature (continued)

## Oven Feature (continued)

### ■ Ferment Setting

E.g.: Perform the dough fermentation at 100 °F (40 °C) for 40 minutes.



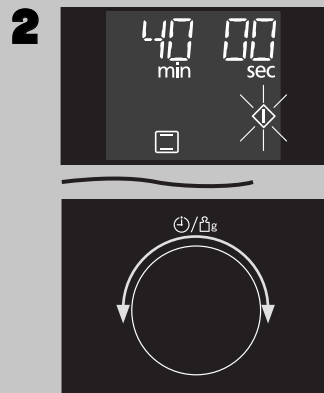

Tap **Oven**. Select desired temperature 100 °F (40 °C).

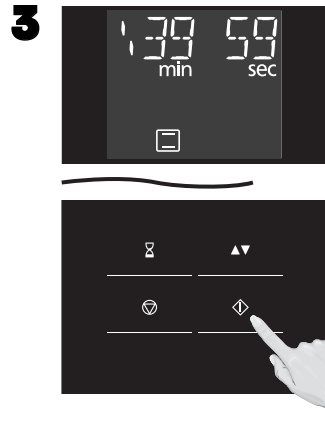

Select the cooking time turning the **Time/Weight** dial. Maximum cooking time is 1 hour 30 minutes.



Touch once. Cooking will start. The time in the display window will count down.

NOTE: Check that only the oven symbol  is still in the display. If the microwave symbol  is displayed this is incorrect and the program should be cancelled. Reselect the Oven setting.

### Guideline to oven temperatures

For best results always place food in a preheated oven. Don't forget that for ease of programming of the most commonly used temperatures, your oven will start at 350 °F (150 °C) and count up in 25 °F (10 °C) stages to 425 °F (220 °C), then back to down to 100 °F (40 °C) then 200 °F (100 °C). Food is generally cooked uncovered - unless it is stated in the instructions or recipe. It is recommended to rotate the Grill Tray 180° at  $\frac{2}{3}$  of total time to get more uniform cooking performance.

### Caution

The Grill Tray and surrounding oven will get very hot. Use oven gloves.

### Oven accessories to use

In oven mode, you can cook food directly on the Grill Tray in the upper or lower shelf position. Or you can place your standard metal baking tins and ovenware on the Grill Tray in the lower shelf position. Or you can place foods directly on Wire Rack with heatproof dishes underneath. Do not place tins and ovenware directly on the base of the oven in oven mode. Do not pre-heat on oven mode with the Grill Tray in position. You can use the Grill Tray as a baking dish for roasting potatoes or vegetables, and for baking fairy cakes, scones and cookies. It is also ideal for re-heating pre-cooked convenience pastry items.

When using the **Grill Tray**, please put in the upper or lower shelf positions.

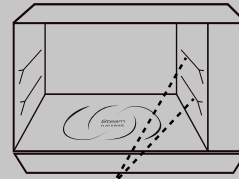

upper or lower shelf positions

For example:  
Baking: Grill Tray in lower shelf position.



When using the **Wire Rack**, please put on the flat table.

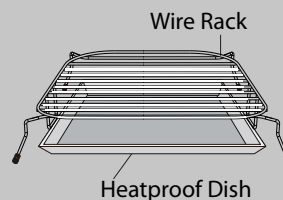

For example:



### NOTES:

1. Open the door using the pull down door because if **Stop/Reset** is touched the program may be cancelled.
2. The oven can not preheat to 100 °F (40 °C).
3. After touching **Start**, the selected temperature can be recalled and changed. Touch **Oven** once to indicate the temperature in the display window. While the temperature is recalled in the display window, you can change the temperature (except 100 °F (40 °C)) by tapping oven.
4. The oven will maintain the selected preheated temperature for approximately 30 minutes without open the door. If no food has been placed inside the oven or a cooking time set, then it will beep 5 times and automatically cancel the cooking program and revert to clock or time of day. Once you open the door and **Start** pad is not pressed, after 6 minutes, the oven will automatically cancel the preheat program. This display will revert back to clock or colon mode.

# Operation — Grill Feature

## Grill Feature

There are three power levels for grill. When grilling, heat is radiated from two heaters. It is especially suitable for thin slices of meat and seafood as well as bread and meals. Most foods require turning halfway during cooking. When turning food, open oven door and CAREFULLY remove the accessory by holding the accessories firmly.

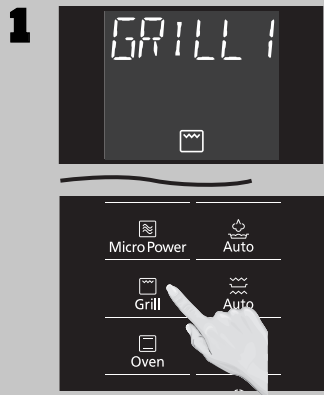

Tap **Grill** until the power you require appears in the display window.

Touch	Power Level
once	Grill1 (HIGH)
twice	Grill2 (MEDIUM)
3 times	Grill3 (LOW)

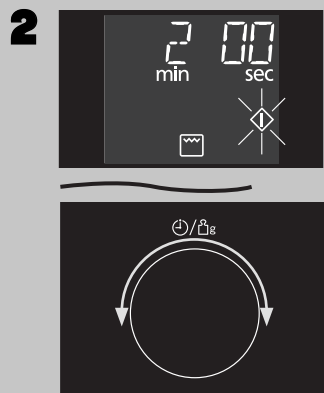

Select the cooking time by turning the **Time/Weight** dial. Maximum cooking time is 1 hours 30 minutes.

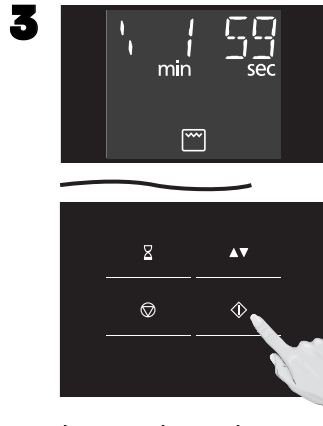

Touch once. The cooking program will start and the time in the display will count down.

### NOTE:

The grill will only operate with the oven door closed.

### Grilling times

When using the grill to cook foods, the cooking times will be similar to traditional grilling. Most foods will require turning halfway through the cooking time.

### Caution

The Grill Tray and surrounding oven will get very hot. Use oven gloves.

## Guidelines

Use the Grill Tray provided, as explained.

Most meat items e.g. bacon, sausages, chops can be cooked on the hottest setting Grill 1. This setting is also suitable for toasting bread, muffins and teacakes etc. Grill 2 and Grill 3 are used for more delicate foods or those that require a longer grill time e.g. fish or chicken portions. Never cover the food when grilling.

Always use oven gloves when removing the food and Grill Tray after grilling as they will be very hot.

After grilling it is important that the Grill Tray is removed for cleaning before reuse and that the oven walls and floor are wiped with a cloth squeezed in hot soapy water to remove any grease.

### Place food on Grill Tray

The Grill Tray will allow fat and juices to drip into the Watercourse to reduce excess splatter and smoke when grilling.

Use oven gloves when removing the Grill Tray as it will be very hot, and so will the roof and walls of the oven.

After turning, return food to the oven, close door and touch

**Start**. The oven will continue to count down the remaining cooking time. It is quite safe to open the oven door at any time to check the progress of the food as it is grilling.

## Oven accessories to use

When grilling fish, chops or small food items, the Grill Tray should be placed in the upper shelf position. For larger food items, the Grill Tray should be in the lower shelf position. Or you can place foods directly on Wire Rack with a heatproof dish underneath.

❑ When using the **Grill Tray**, please put in the upper or lower shelf positions.

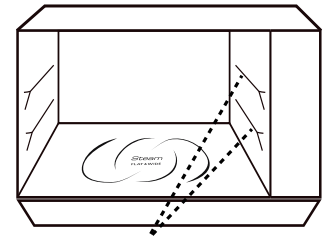

upper or lower shelf positions

For example:

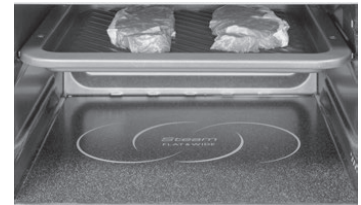

❑ When using the **Wire Rack**, please put on the flat table with a heatproof dish underneath.

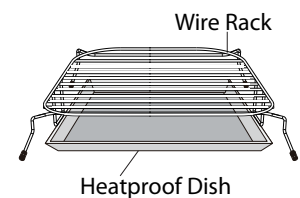

For example:



# Operation — Combination Feature (Crispy Grill)

## Combination Feature



Touch	Power Level
once	Crispy Grill
twice	Combo 1 (Grill + Steam)
3 times	Combo 2 (Grill + Microwave)

### ■ Crispy Grill

The crispy grill feature allows the upper and lower surfaces of food to be brown and crispy without turning over by means of the particular design of the Grill Tray only.

Food can get golden-brown and crispy effect without turning over. It is suitable for roasting all kinds of seafood, bread and meat pieces.



Touch once. "Crispy Grill" scrolls across in display window. Grill symbol , microwave symbol  and Grill Tray  symbol appear in the display window.

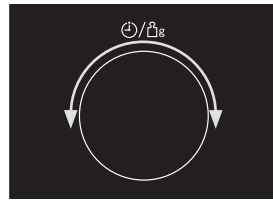

Select the cooking time by turning the **Time/Weight** dial. Maximum cooking time is 30 minutes.

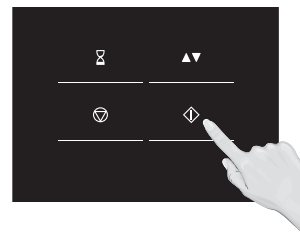

Touch once. Cooking will start. The time in the display window will count down.

### NOTES:

1. Always using Grill Tray during cooking in Crispy Grill feature.
2. Preheating is not available with Crispy Grill feature.
3. The maximum time for cooking in this mode is 30 minutes. If required to cook for longer than this time, repeat the left operation for the remaining time.

### Caution

The Grill Tray and surrounding oven will get very hot. Use oven gloves.

### Oven accessories to use

- Using Grill Tray in upper or lower shelf positions

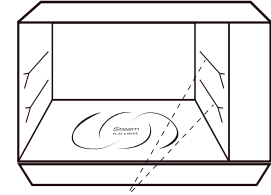

upper or lower shelf positions

For example:







# Operation — Combination Feature (Combo 1)

## Combination Feature (continued)

### ■ Combo 1 (Grill + Steam)

This feature is a Steam and Grill combined heating method by adjusting the settings. Steam and grill power works in a constant sequence alternatively, to keep the food in moisture through grilling while making cooking time shortened compared with that in a traditional way.



Touch "**Combination**" twice. Steam symbol  and Grill symbol  appear in the display window.

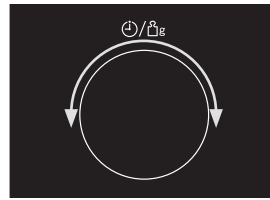

Select the cooking time by turning the **Time/Weight** dial. Maximum cooking time is 30 minutes.

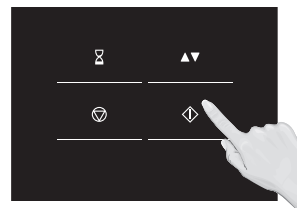

Touch once. Cooking will start. The time in the display window will count down.

### NOTES:

1. Fill the water tank before using the Combo 1 function.
2. The maximum time for cooking in this mode is 30 minutes. If required to cook for longer than this time, re-fill the water tank and repeat the left operation for the remaining time.
3. If during operation the water tank becomes empty, the oven will stop operation. The prompt in the display will ask you to re-fill the water tank. After re-filling the water tank and positioning back in the oven, touch **Start**. The oven will not continue cooking until the water tank has been re-filled and **Start** touched.
4. Preheating is not available with Combo 1 mode.
5. It is possible to refill water tank at any time during cooking, without having to touch **Stop/Reset** first.
6. It may be necessary to wipe the excess water in the cavity after Steam cooking.

### Containers to use

Microwaveable and heatproof dishes can be used on the Grill Tray in the lower or upper shelf positions.

### Guideline

1. Always use oven gloves when removing the food and Grill Tray after cooking as the oven and Grill Tray will be very hot.
2. After each steam operation carefully remove the drip tray from the front of the oven. Gently ease forwards, holding with both hands. After emptying, wash in warm soapy water. To re-position, click back into position on the oven legs.

### Caution

1. The Grill Tray and surrounding oven will get very hot. Use oven gloves.
2. When removing the food or Grill Tray, hot water may drip from the oven top.
3. Steam may billow out when you open the door. If there is steam in the oven, do not reach in with your bare hands! Risk of burns! Use oven gloves.
4. During and after cooking with steam function, do not open the oven door when your face is very close to the oven. Care must be taken when opening the door as steam may cause injury.
5. Take care when removing the drip tray.

### Oven accessories to use

- Using Grill Tray in upper or lower shelf positions

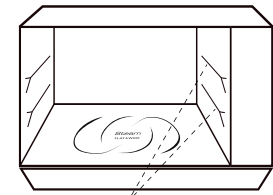

upper or lower shelf positions

For example:







# Operation — Combination Feature (Combo 2)

## Combination Feature (continued)

### ■ Combo 2 (Grill + Microwave)

It's a good way for roasting foods by combining microwave and grill effectively. It's suitable for roasting poultry, meat and seafood. This function can ensure the foods even cooking and keep the crispness of certain foods. Please open the door and turn over the foods when half of the cooking time, then continue cooking.



Tap "Combination" 3 times. Grill symbol  and microwave symbol  will appear in the display window.

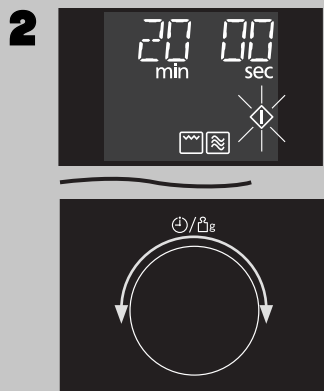

Select the cooking time by turning the **Time/Weight** dial. Maximum cooking time is 1 hours 30 minutes.

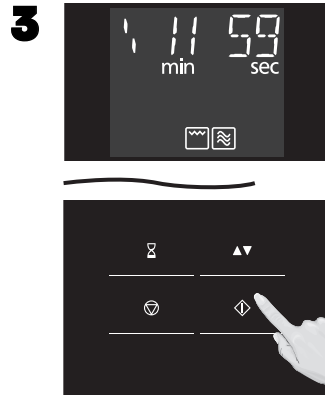

Touch once. Cooking will start. The time in the display window will count down.

### NOTE:

Preheating is not available with Combo 2 mode.

### Containers to use

Do not use plastic microwave containers on combination programs (unless suitable for combination cooking). Dishes must be able to withstand the heat of the top grill - heatproof glass e.g. Pyrex® or ceramic are ideal.

### Guideline

Food is always cooked uncovered.

### Caution

The Wire Rack and surrounding oven will get very hot. Use oven gloves.

### Oven accessories to use

Directly on the base of the oven in a microwaveable and heatproof dish. Or you can place foods directly on Wire Rack with microwaveable and heatproof dish underneath.

When using the Wire Rack, please put on the flat table with a microwaveable dish underneath.

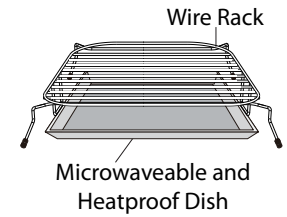

For example:



Directly on the base of the oven in a microwaveable and heatproof dish.

For example:



# Operation — Setting the Timer

## Setting the Timer

### To Use as a Kitchen Timer

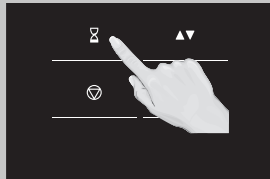

Touch once.

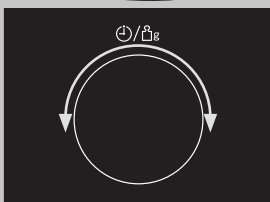
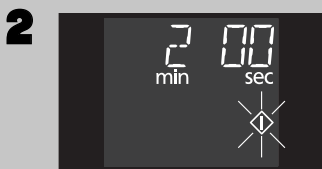

Set desired amount of time by turning the **Time/Weight** dial. (up to 1 hour 30 minutes)

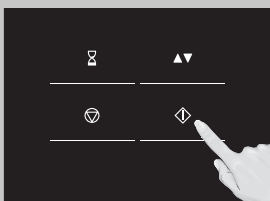
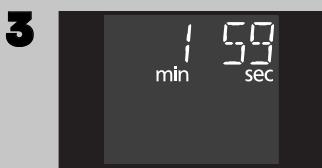

Touch once. Time will count down without oven operating.

### Setting a Standing Time

**1** Set the desired cooking program, by entering cooking method and time required. (up to 2 power stages)



Touch once.

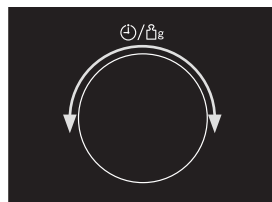
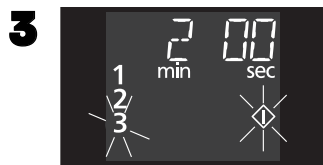

Set the standing time by turning the **Time/Weight** dial. (up to 1 hour 30 minutes)

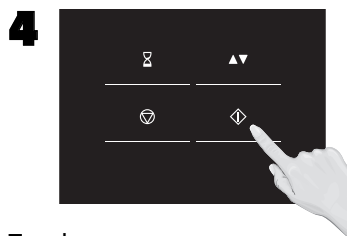

Touch once. Cooking will start. After cooking, standing time will count down without oven operating.

### Setting Delay Start

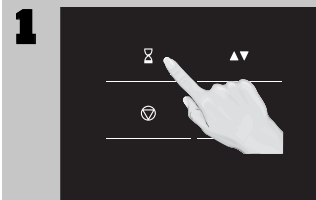

Touch once.

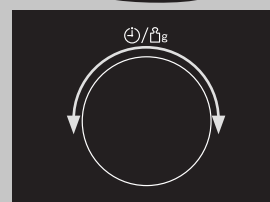
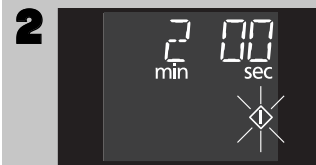

Set desired amount of delay time. (up to 1 hour 30 minutes)

**3** Set the desired cooking program, by entering cooking method and time required. (up to 2 power stages)

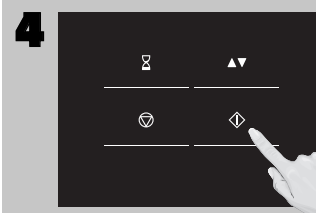

Touch once. Delayed time will count down without oven operating. Then cooking will start.

## NOTES:

1. If the oven door is opened during Kitchen Timer, Standing Time, Delay Start, the time in the display window will continue to count down.
2. Standing Time and Delay Start can not be programmed together with automatic, Oven and Crispy Grill feature. This is to prevent the starting temperature of food from rising before defrosting or cooking begins. A change in starting temperature could cause inaccurate results.
3. When using Standing time or Delay Start, it's up to 2 power stages.
4. If the programmed stand time exceeds one hour, the time will count down in units of minutes. If less than one hour, the time will count down in units of seconds.
5. Standing Time may also be used as a minute timer. In this case touch the **Timer/Clock**, set time and touch **Start**.

# Operation — 3-Stage Feature

## 3-Stage Feature

E.g.: Continually set  
[600 W] 2 minutes,  
[Steam 2] 2 minutes and  
[Grill 3] 2 minutes.

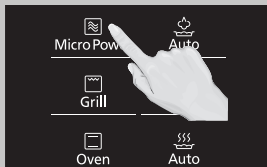

Tap **Micro Power** 3 times to select 600 W.

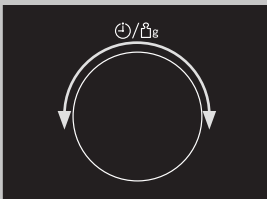
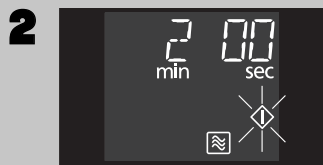

Select the cooking time to 2 minutes turning the **Time/Weight** dial.

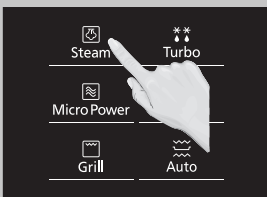
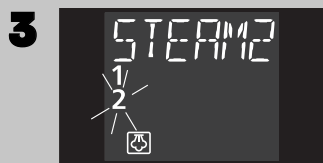

Tap **Steam** twice.

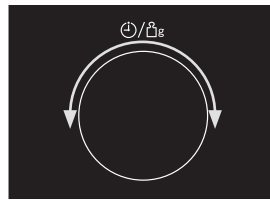

Select the cooking time to 2 minutes by turning the **Time/Weight** dial.

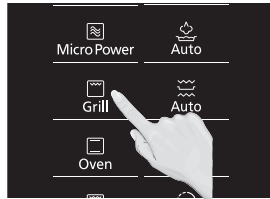
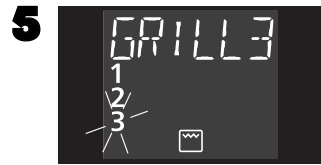

Tap **Grill** 3 times.

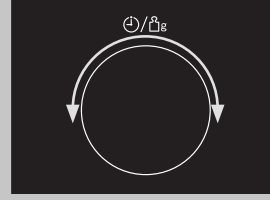
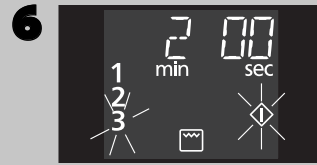

Select the cooking time to 2 minutes by turning the **Time/Weight** dial.

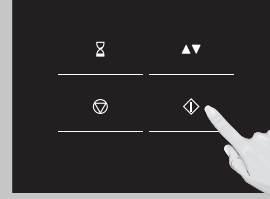

Touch once.  
The time will count down at the first stage in the display window.

## NOTES:

1. For 3-stage cooking, enter another cooking program before touching **Start**.
2. During operation, touching **Stop/Reset** once will stop the operation. Touching **Start** will re-start the programmed operation. Touching **Stop/Reset** twice will stop and clear the programmed operation.
3. Whilst not operating, touching **Stop/Reset** will clear the selected program.
4. Auto programs (such as auto cook, inverter turbo defrost and auto steam) can not be used with 3 stages cooking.
5. Oven and Crispy Grill cannot be used with 3 stages cooking.
6. The maximum time contain every steam cook (Steam, 300 W + Steam and Combo 1) can not be set over 30 minutes in this feature.

# Operation — Quick 30 Feature / Popcorn

## Quick 30 Feature

Set or add cooking time in 30 seconds increments up to 5 minutes.

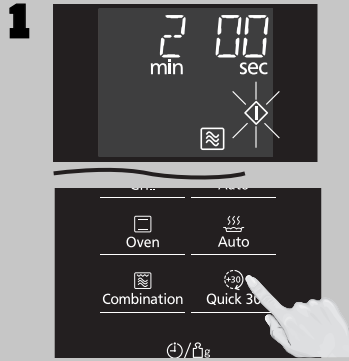

Touch **Quick 30** to set the desired cooking time (up to 5 minutes). Each touch is 30 seconds. Time appears in the display. Power level is pre-set at 1000 W.



Touch **Start**; the cooking will start and the time will count down in the display. At the end of cooking, five beeps will sound.

## NOTES:

1. If desired, you can use other power levels. Select desired power level before touching Quick 30.
2. After setting the time by Quick 30, you cannot use the Time/Weight dial.
3. **Quick 30 can also be used to add more time during manual cooking.**
4. This feature is available for Microwave, Grill, Combination, Timer, Oven, Steam and 300 W + Steam feature.  
\* To set time, this feature can not available for Oven (with preheating) .
5. Auto program (such as inverter turbo defrost, auto steam, auto grill and auto cook feature) can't be use in Quick 30 feature.

## Popcorn

(Example: To pop 2.75 oz (78 g) of popcorn)

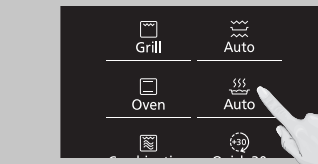

Touch once.

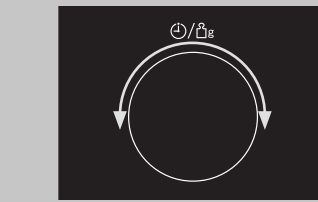
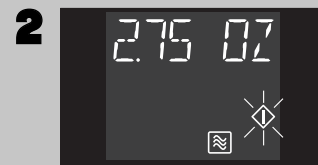

Select the desired weight by turning the **Time/Weight** dial.

Weight
1.5 oz (42 g)
2.75 oz (78 g)
3.5 oz (99 g)

## 3 Optional

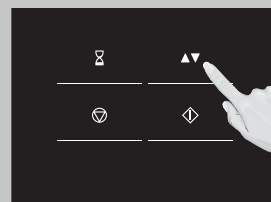
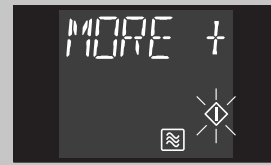

If desired, touch **More/Less** once to add 10 seconds or twice to add 20 seconds. Touch **More/Less** 3 times to subtract 10 seconds or 4 times to subtract 20 seconds.

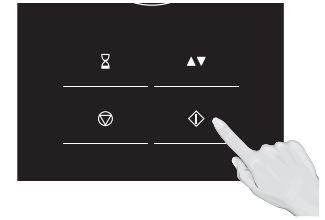

Touch once.

After several seconds, cooking time appears in the display window and begins to count down. At the end of cooking, five beeps will sound.

## NOTES:

1. Pop one bag at a time.
2. Place bag in oven according to manufacturers' directions.
3. Start with popcorn at room temperature.
4. Allow popped corn to sit unopened for a few minutes.
5. Open bag carefully to prevent burns, because steam will escape.
6. Do not reheat unpopped kernels or reuse bag.
7. If popcorn is of a different weight than listed, follow instructions on popcorn package.
8. **Never leave the oven unattended.**
9. **If popping slows to 2 to 3 seconds between pops, stop oven. Overcooking can burn popcorn or cause fire.**
10. When popping multiple bags one right after the other, the cooking time may vary slightly. This does not affect the popcorn results.
11. If "HOT" appears in the display window, the oven temperature is too high from previous use and an auto program can not be set. Cooking mode and time may still be set manually.

# Operation — More/Less Feature & Inverter Turbo Defrost Feature

## More/Less Feature

This feature is only available for Popcorn menu:

By using the **More/Less** pad, the programs can be adjusted to cook popcorn for a longer or shorter time if desired.

- 1 tap = Adds approx. 10 secs
- 2 taps = Adds approx. 20 secs
- 3 taps = Subtracts approx. 10 secs
- 4 taps = Subtracts approx. 20 secs
- 5 taps = Original setting

Touch **More/Less** pad before touching **Start**.

## Inverter Turbo Defrost Feature

This feature allows you to defrost meat, poultry and seafood automatically by just setting the weight of the food.

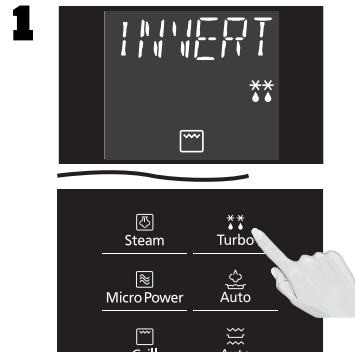

Touch once.

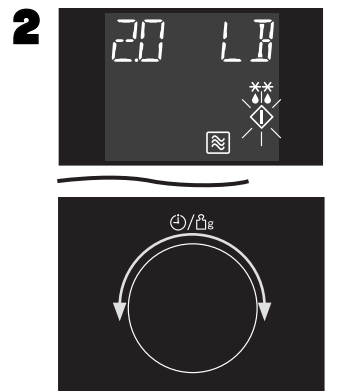

Set weight. Select the weight by turning the **Time/Weight** dial. The **Time/Weight** dial will count up in 0.1 lb (0.1 kg) steps.

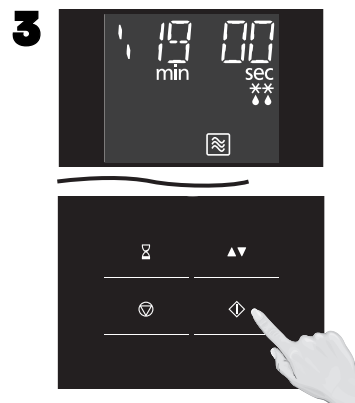

Touch once. Defrosting will start. The time will count down.

## Conversion Chart:

Follow the chart to convert ounces or hundredths of a pound into tenths of a pound. To use Inverter Turbo Defrost, enter the weight of the food in lbs. (1.0) and tenths of a lb. (0.1). If a piece of meat weighs 1.95 lbs. or 1 lb. 14 oz., enter 1.9 lbs.

Ounces	Hundredths of a Pound	Tenths of a Pound
0	.01 - .05	0.0
1 - 2	.06 - .15	0.1
3 - 4	.16 - .25	0.2
5	.26 - .35	0.3
6 - 7	.36 - .45	0.4
8	.46 - .55	0.5
9 - 10	.56 - .65	0.6
11 - 12	.66 - .75	0.7
13	.76 - .85	0.8
14 - 15	.86 - .95	0.9

## NOTES:

1. The shape and size of the food will determine the maximum weight the oven can accommodate. The recommended maximum weight of food depends on the oven cavity size. The maximum weight for Inverter Turbo Defrost is 6 lbs. (3 kg).
2. The oven will beep twice during the total defrosting time. This indicates that food should be turned, broken apart or removed. After attending to food, close door and touch **Start** to resume defrosting.
3. Allow standing time to ensure the food is completely defrosted.
4. If "HOT" appears in the display window, the oven temperature is too high from previous use and an auto program can not be set. Cooking mode and time may still be set manually.

## Operation — Auto Steam Feature

### Auto Steam Feature

This feature allows you to steam some of your favourite foods by setting the weight only. The oven determines the steam level and the cooking time automatically. Select the category and set the weight of the food.

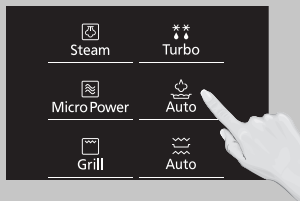

Tap **Auto Steam** until the desired menu you require scroll across in the display window.  
(For the menu chart, refer to page 38.)

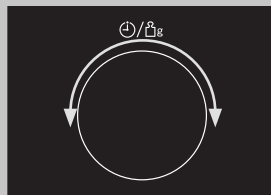

Select desired serving/weight by turning **Time/Weight** dial.

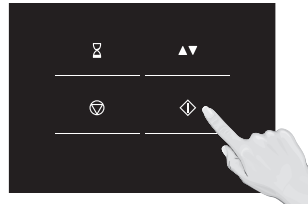

Touch once. The cooking program will start and the time in the display will count down.

### NOTES:

1. **Fill the water tank** before cooking.
2. The auto steam programs must only be used for foods described.
3. Only cook foods within the weight ranges described.
4. Always weigh the food rather than relying on the package weight information.
5. Do not cover foods on the auto steam programs.
6. Most foods benefit from a standing time after cooking on an auto program, to allow heat to continue conducting to the centre.
7. To allow for some variations that occur in food, check that food is thoroughly cooked and piping hot before serving.
8. The temperature for frozen food is assumed to be 0 °F (-18 °C) to -2 °F (-20 °C). The temperature of chilled food is assumed to be 41 °F (+5 °C) to 46 °F (+8 °C) (refrigerator temperature).
9. If "HOT" appears in the display window, the oven temperature is too high from previous use and an auto program can not be set. Cooking mode and time may still be set manually.
10. When you select an automatic program, symbols will appear in the display to show the cooking mode that will be used and the accessories that are needed.

# Operation — Auto Grill Feature

## Auto Grill Feature

This feature allows you to cook some of your favourite foods by setting the weight only. The oven determines the power level and the cooking time automatically. Select the category and set the weight of the food.

It is suitable for roasting all kinds of seafood, bread and meat pieces.

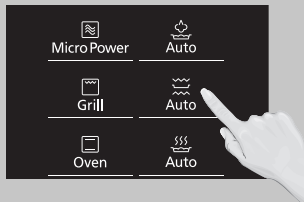

Tap **Auto Grill** until the desired menu you require scroll across in the display window.  
(For the menu chart, refer to page 39.)

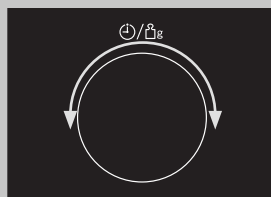

Select desired serving/weight by turning **Time/Weight** dial.

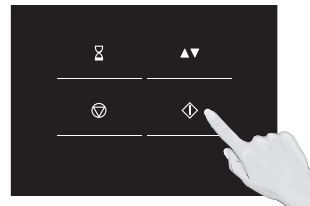

Touch once. The cooking program will start and the time in the display will count down.

## NOTES:

1. **Fill the water tank** if required. (Steam icon appear in the display window.)
2. Only cook foods within the weight ranges described.
3. Always weigh the food rather than relying on the package weight information.
4. The temperature for frozen food is assumed to be 0 °F (-18 °C) to -2 °F (-20 °C). The temperature of chilled food is assumed to be 41 °F (+5 °C) to 46 °F (+8 °C) (refrigerator temperature).
5. Most foods benefit from a standing time after cooking on an auto program, to allow heat to continue conducting to the centre.
6. To allow for some variations that occur in food, check that food is thoroughly cooked and piping hot before serving.
7. If "HOT" appears in the display window, the oven temperature is too high from previous use and an auto program can not be set. Cooking mode and time may still be set manually.
8. When you select an automatic program, symbols will appear in the display to show the cooking mode that will be used and the accessories that are needed.



# Operation — Auto Cook Feature

## Auto Cook Feature

This feature allows you to cook some of your favourite foods by setting the weight only. The oven determines the power level and the cooking time automatically. Select the category and set the weight of the food.

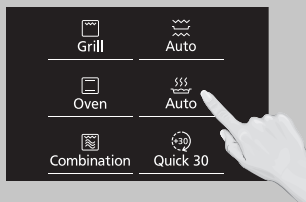
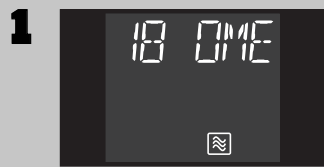

Tap **Auto Cook** until the desired menu you require scroll across in the display window.  
(For the menu chart, refer to page 40-41.)

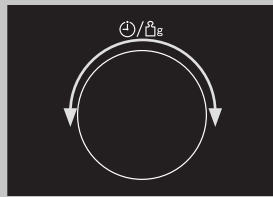
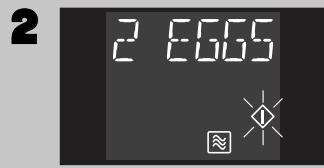

Select desired serving/weight by turning **Time/Weight** dial.

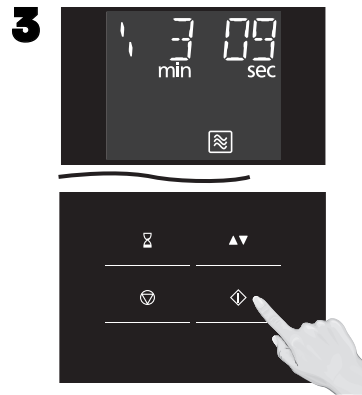

Touch once. The cooking program will start and the time in the display will count down.

## NOTES:

1. The auto cook programs must only be used for foods described.
2. Only cook foods within the weight ranges described.
3. Always weigh the food rather than relying on the package weight information.
4. The temperature for frozen food is assumed to be 0 °F (-18 °C) to -2 °F (-20 °C). The temperature of chilled food is assumed to be 41 °F (+5 °C) to 46 °F (+8 °C) (refrigerator temperature).
5. Most foods benefit from a standing time after cooking on an auto program, to allow heat to continue conducting to the centre.
6. To allow for some variations that occur in food, check that food is thoroughly cooked and piping hot before serving.
7. If "HOT" appears in the display window, the oven temperature is too high from previous use and an auto program can not be set. Cooking mode and time may still be set manually.
8. When you select an automatic program, symbols will appear in the display to show the cooking mode that will be used and the accessories that are needed.

# Operation — Menu Chart (Auto Steam Menus)



## Auto Steam Menus

Touch	Menu	Serving/Weight				Accessories and Placement
x 1	1. Fresh Vegetables	7 oz. (200 g)	9 oz. (250 g)	11 oz. (300 g)	-	Grill Tray in upper shelf position
x 2	2. Frozen Vegetables	7 oz. (200 g)	9 oz. (250 g)	11 oz. (300 g)	-	Grill Tray in upper shelf position
x 3	3. Boiled Potatoes	7 oz. (200 g)	11 oz. (300 g)	14 oz. (400 g)	18 oz. (500 g)	Grill Tray in upper shelf position
x 4	4. Chicken Breast	7 oz. (200 g)	11 oz. (300 g)	14 oz. (400 g)	18 oz. (500 g)	Grill Tray in upper shelf position
x 5	5. Fresh Fish Fillets	7 oz. (200 g)	11 oz. (300 g)	14 oz. (400 g)	18 oz. (500 g)	Grill Tray in upper shelf position
x 6	6. Frozen Fish Fillets	7 oz. (200 g)	11 oz. (300 g)	14 oz. (400 g)	18 oz. (500 g)	Grill Tray in upper shelf position
x 7	7. Whole Fish	7 oz. (200 g)	11 oz. (300 g)	14 oz. (400 g)	18 oz. (500 g)	Grill Tray in upper shelf position

### 1. Fresh Vegetables

It is suitable for steaming fresh vegetables, such as broccoli, cauliflower and carrots. All pieces should be the same size. Wash thoroughly. **Fill water tank.** Place prepared vegetables on Grill Tray. Place in the upper shelf position. Select the program and weight then touch **Start**.

### 2. Frozen Vegetables

It is suitable for steaming frozen vegetables such as carrots, broccoli, cauliflower and green beans. All pieces should be the same size. **Fill water tank.** Place vegetables on Grill Tray. Place in the upper shelf position. Select the program and weight then touch **Start**.

### 3. Boiled Potatoes

It is suitable to steaming boiled potatoes. Peel potatoes and cut into 1 oz. - 1.4 oz. (30 g - 40 g) each. **Fill water tank.** Place prepared potatoes on Grill Tray. Place in the upper shelf position. Select the program and weight then touch **Start**.

### 4. Chicken Breast

It is suitable to steaming chicken breast. Each chicken breast should weigh between 3.5 oz. - 5 oz. (100 g - 150 g). Wash thoroughly. **Fill water tank.** Place chicken breast on Grill Tray. Place in the upper shelf position. Select the program and weight then touch **Start**.

### 5. Fresh Fish Fillets

It is suitable to steaming fresh fish fillets. Each fresh fish fillets should weigh between 3.5 oz. - 7 oz. (100 g - 200 g). Wash thoroughly. **Fill water tank.** Place fresh fish on Grill Tray. Place in the upper shelf position. Select the program and weight then touch **Start**.

### 6. Frozen Fish Fillets

It is suitable to steaming frozen fish fillets. Each frozen fish fillets should weigh between 3.5 oz. - 7 oz. (100 g - 200 g). Wash thoroughly. **Fill water tank.** Place frozen fish on Grill Tray. Place in the upper shelf position. Select the program and weight then touch **Start**.

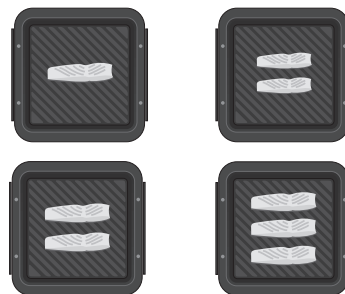
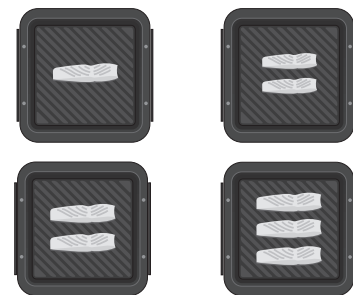

### 7. Whole Fish

It is suitable to steaming fresh whole fish such as trout, sea bream, mackerel, sea bass, sardines. **Fill water tank.** Place whole fish onto dish and then put on the Grill Tray. Place in the upper shelf position. Select the program and weight then touch **Start**.

# Operation — Menu Chart (Auto Grill Menus)

## Auto Grill Menus

Touch Auto	Menu	Serving/Weight				Accessories and Placement
x 1	8. Fish Fillets	11 oz. (300 g)	14 oz. (400 g)	18 oz. (500 g)	-	Grill Tray in upper shelf position
x 2	9. Chicken Pieces	7 oz. (200 g)	14 oz. (400 g)	21 oz. (600 g)	-	Grill Tray in upper shelf position
x 3	10. Baked Potato	1 pc.	2 pcs.	3 pcs.	4 pcs.	Grill Tray in upper shelf position
x 4	11. Chilled Pizza	7 oz. (200 g)	11 oz. (300 g)	14 oz. (400 g)	18 oz. (500 g)	Grill Tray in upper shelf position
x 5	12. Frozen Pizza	10 oz. (280 g)	13 oz. (370 g)	18 oz. (500 g)	-	Grill Tray in upper shelf position
x 6	13. Grilled Sandwich	1 pc.	2 pcs.	3 pcs.	4 pcs.	Grill Tray in upper shelf position
x 7	14. Chicken Nuggets	4 pcs. - 6 pcs.	8 pcs. - 10 pcs.	-	-	Grill Tray in upper shelf position

### 8. Fish Fillets

Suitable for frying fresh fish fillets like salmon weighing a maximum 5.4 oz. - 6.4 oz. (150 g - 180 g) each without turning, thickness of pieces not more than 1¼ inches (3 cm). **Fill water tank.** Place the fish fillets skin side down on Grill Tray. Place the Grill Tray in upper shelf position. Select the program and weight, then touch **Start**.



### 9. Chicken Pieces

Suitable for cooking chicken pieces such as wings, drumsticks, thighs, half breasts etc. Chicken pieces should be thawed completely before cooking. Each chicken piece should weigh between 3 oz. - 4 oz. (80 g - 120 g). Pierce the chicken skin a few times before cooking. **Fill water tank.** Place chicken pieces on Grill Tray. Place in the upper shelf position. Select the program and weight, then touch **Start**.

### 10. Baked Potato

It is suitable for cooking whole potatoes with their skin left on. Choose medium sized potatoes weighing approximately 7 oz. - 9 oz. (200 g - 250 g) each. Wash and scrub potatoes and dry well. Prick with a fork several times. Place on Grill Tray in the upper shelf position. Select the program and weight then touch **Start**. At the end of cooking time, allow the potato to stand for 5 to 10 minutes.

### 11. Chilled Pizza

It is suitable for cooking chilled pizza. Remove all packaging and place the pizza onto the Grill Tray. Place in the upper shelf position. Select the program and weight then touch **Start**. If additional time is needed, continue to cook manually.

### 12. Frozen Pizza

It is suitable for cooking frozen pizza. Remove all packaging and place the pizza onto the Grill Tray. Place in the upper shelf position. Select the program and weight then touch **Start**. If additional time is needed, continue to cook manually.

### 13. Grilled Sandwich

It is suitable for cooking frozen pocket sandwich. Remove all packaging and place the food onto the Grill Tray. Place in the upper shelf position. Select the program and weight then touch **Start**.

### 14. Chicken Nuggets

Place pre-cooked frozen chicken nuggets on Grill Tray. Place in the upper shelf position. Select the program and weight, then touch **Start**.

# Operation — Menu Chart (Auto Cook Menus)

## Auto Auto Cook Menus

Touch Auto	Menu	Serving/Weight				Recommended Containers	Accessories and Placement
x 1	15. Popcorn	1.5 oz. (42 g)	2.75 oz. (78 g)	3.5 oz. (99 g)	-	-	Flat table
x 2	16. Oatmeal	½ cup (125 ml)	1 cup (250 ml)	-	-	Microwave-safe container	Flat table
x 3	17. Breakfast Sausage	2 links	4 links	6 links	8 links	Paper plate or Microwave-safe container	Flat table
x 4	18. Omelet	2 eggs	3 eggs	4 eggs	-	Microwave-safe container with plastic wrap	Flat table
x 5	19. Quinoa	¼ cup (60 ml)	½ cup (125 ml)	1 cup (250 ml)	-	Microwave-safe container with plastic wrap	Flat table

### 15. Popcorn

Remove wrapper, place bag on the bottom of the oven according to manufacturers' directions. Select the program and weight then touch **Start**.

#### Notes:

Please refer to page 33 for details.

### 16. Oatmeal

It is suitable for cooking oatmeal. Place oatmeal and tap water into a microwave-safe dish. See chart below for quantities.

Oatmeal	Tap Water	Dish Size
½ cup (125 ml)	1 cup (250 ml)	4 cups (1 litre)
1 cup (250 ml)	1¾ cups (437 ml)	6 cups (1.5 litre)

Do not cover. Place the container on the bottom of the oven. Select the program and weight then touch **Start**. At the end of cooking time, allow to stir food before serving.

### 17. Breakfast Sausage

It is suitable for cooking breakfast sausage that has been chilled in refrigerator. Place breakfast sausage links on paper plate in a radial pattern. Do not cover. Place the container on the bottom of the oven. Select the program and weight then touch **Start**.

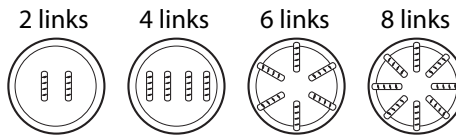

### 18. Omelet

It is suitable for cooking Omelet. See chart below for quantities.

Butter (melted)	Eggs	Milk	Salt and pepper
1 tbsp. (15 ml)	2	2 tbsp. (30 ml)	taste
1 tbsp. (15 ml)	3	3 tbsp. (45 ml)	taste
1 tbsp. (15 ml)	4	4 tbsp. (60 ml)	taste

Turn a microwave-safe plate to coat the bottom with melted butter. Meanwhile, combine the remaining ingredients in a separate bowl, beat together, and pour into the plate. Cover securely with vented plastic wrap. Place the container on the bottom of the oven. Select the program and weight then touch **Start**.

### 19. Quinoa

It is suitable for cooking quinoa. Place quinoa in a microwave-safe casserole dish. Use the above chart as a guide:

Quinoa	Tap water	Dish Size
¼ cup (60 ml)	½ cup (125 ml)	4 cups (1 litre)
½ cup (125 ml)	1 cup (250 ml)	6 cups (1.5 litre)
1 cup (250 ml)	2 cups (500 ml)	10 cups (2.5 litre)

Allow at least ½ depth of volume for evaporation to prevent boiling over. Cover securely with plastic wrap. Place the container on the bottom of the oven. Select the program and weight then touch **Start**. Open the door to STIR WHEN TWO BEEPS HEARD during cooking, touch **Start** to continue. At the end of the cooking, let stand 10-15 minutes.

# Operation — Menu Chart (Auto Cook Menus) (continued)

## Auto Auto Cook Menus (continued)

Touch Auto	Menu	Serving/Weight				Recommended Containers	Accessories and Placement
x 6	20. Soup	1 cup (250 ml)	2 cups (500 ml)			Microwave-safe container with plastic wrap	Flat table
x 7	21. Frozen Entrées	8 oz. (220 g)	10 oz. (280 g)	20 oz. (560 g)	28 oz. (800 g)	Microwave-safe container with plastic wrap	Flat table
x 8	22. White Rice	½ cup (125 ml)	1 cup (250 ml)	1½ cups (375 ml)	-	Microwave-safe container with plastic wrap	Flat table
x 9	23. Melt Butter	2 tablespoons (30 ml)	4 tablespoons (60 ml)	8 tablespoons (120 ml)	-	Microwave-safe container with plastic wrap	Flat table
x 10	24. Deodorization*	* is the Cleaning Feature (For details, see pages 42-43.)					
x 11	25. Drain Water*						
x 12	26. System Cleaning*						
x 13	27. Cavity Cleaning*						

### 20. Soup

It is suitable for reheating soup. Pour soup into a microwave-safe serving bowl. Cover securely with vented plastic wrap. Place the container on the bottom of the oven. Select the program and weight then touch **Start**. Stir after cooking.

### 21. Frozen Entrées

It is suitable for reheating frozen entrées. Follow manufacturers' directions for preparation. Cover securely with vented plastic wrap. Place food on the bottom of the oven. Select the program and weight then touch **Start**. Open the door to STIR WHEN TWO BEEPS HEARD during cooking, touch **Start** to continue. Be careful when removing the film cover after cooking. Remove facing away from you to avoid steam burns. At the end of cooking time, allow to stir food and stand for 2 minutes before serving. If additional time is needed, continue to cook manually.

**Note:** This is not suitable for cooking without covering the container.

### 22. White Rice

It is suitable for cooking white rice. Place rice with hot tap water in a microwave-safe casserole dish. See chart below for quantities.

Rice	Hot tap water	Dish Size
½ cup (125 ml)	1 cup (250 ml)	6 cups (1.5 litre)
1 cup (250 ml)	2 cups (500 ml)	10 cups (2.5 litre)
1½ cups (375 ml)	3 cups (750 ml)	12 cups (3 litre)

Allow at least ½ depth of volume for evaporation to prevent boiling over. Cover securely with plastic wrap. Place the container on the bottom of the oven. Select the program and weight then touch **Start**. Open the door to STIR WHEN TWO BEEPS HEARD during cooking, touch **Start** to continue. At the end of cooking time, allow to stand for 5 minutes before serving.

### 23. Melt Butter

Remove wrapper, cut butter into 1¼ inches (3 cm) cube, and place into a microwave safe dish. Melt with lid or plastic wrap. Select the program and weight then touch **Start**. Stir after cooking.

# Operation — Cleaning Feature (Deodorization / Drain Water)

## 24. Deodorization Setting

This feature is suitable for cleaning the particular smell from the microwave oven (20 minutes is needed).

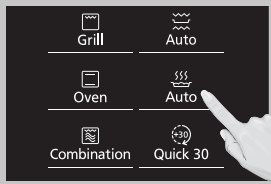
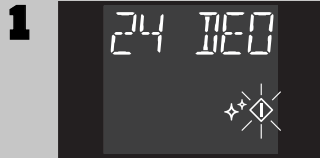

Touch 10 times.

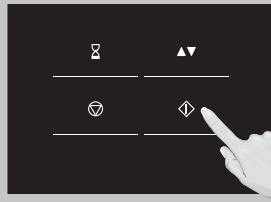
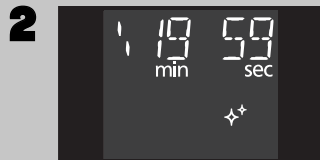

Touch once.  
The cooking time appears in the display window and begins to count down.

## 25. Drain Water Setting

Water is pumped through the system to clean the pipes. The water is drained into the drip tray.

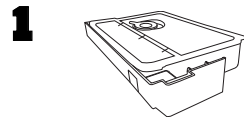

Add 3 oz. (100 ml) of water to the water tank. Ensure drip tray is empty.

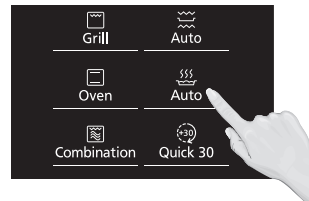
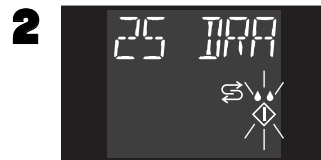

Touch 11 times.

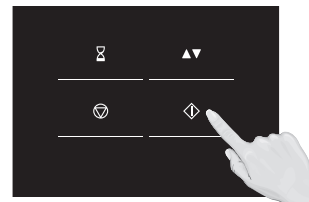

Touch once.  
Empty the drip tray after the program has finished.

### NOTES:

1. Only run this program with 3 oz. (100 ml) of water in the tank.
2. Do not remove the drip tray during the drain water program.
3. Empty the drip tray and rinse with running water after the program has finished.

### Caution:

If the Drain Water program is used directly after a steam cooking program, hot water may be drained into the drip tray.

# Operation — Cleaning Feature (System Cleaning / Cavity Cleaning) (continued)

## 26. System Cleaning Setting

The first stage of this program cleans the system with a citric acid solution. The second stage runs water through the system to rinse the pipes.

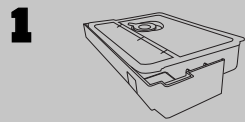

Make a solution of 16 g citric acid and ¾ tasse (200 g) of water, add the solution to the water tank. Ensure drip tray is empty.

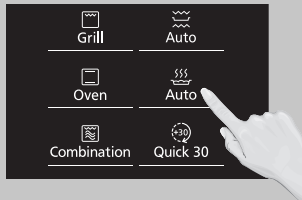
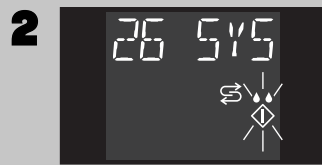

Touch 12 times.

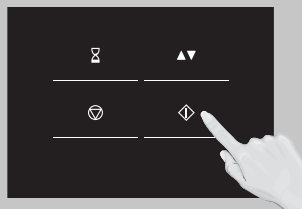
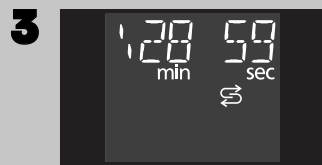

Touch once.  
The program will run for approx. 29 minutes.

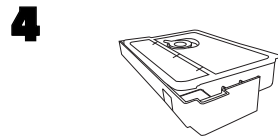

After the program has paused, empty the drip tray and fill the water tank with water (to max level).

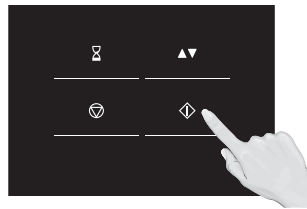

Touch once.  
The program will run for approx. 1 minute. Empty the drip tray after the program has finished.

### NOTES:

1. **Fill the water tank** before use.
2. When "☞" appears in the display, run the 'system cleaning' program.
3. If the system cleaning program is not used regularly, the pipe will get blocked and the steaming performance will be less effective.
4. Do not remove the drip tray during the drain program.
5. Empty the drip tray and rinse with running tap water after the program has finished.

## 27. Cavity Cleaning Setting

This feature is available when the cavity is built up with fat or grease (20 minutes is needed).

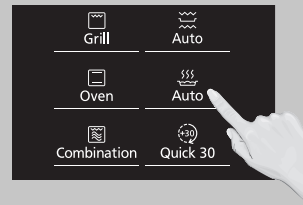

Touch 13 times.

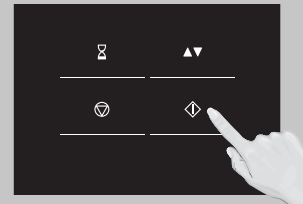
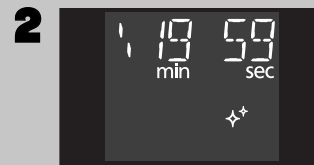

Touch once.  
The cooking time appears in the display window and begins to count down.

### NOTES:

1. **Fill the water tank** before use.
2. After cleaning, open the door and wipe with a damp cloth.

## Guide Lines



### Micro Power

1000 W	Boil water. Cook fresh fruits, vegetables, preserved fruit and candies.
800 W	Cook fish and seafood, meat, poultry, eggs and cakes.
600 W	Cook cakes, stew food, and melt butter and chocolate.
440 W	Cook tough meat, stew soup and soften butter.
300 W	Defrost meat, poultry or seafood.
100 W	Keep food warm and soften ice cream.
300 W + Steam	All foods cooking by Steam feature, can use this feature too. It is suitable for cooking foods quickly.



### Grill

Grill 1	Grill garlic Bread, Toast.
Grill 2	Grill seafood.
Grill 3	Grill slice meat or poultry pieces.



### Oven

100 °F (40 °C)	Proving Bread or Pizza dough
300 °F /325 °F (150/160 °C)	Macaroons
350 °F (180 °C)	Victoria Sandwich, Fairy Cakes, Meat Joints, Swiss Roll
375 °F (190 °C)	Gratins, Lasagne, Pastry Pies
400 °F (200 °C)	Stuffed Peppers, Scones
425 °F (220 °C)	Vegetable parcels, bread, garlic bread, roast potatoes, baking pizza.



### Steam

Steam 1	Steam vegetable, chicken, meat, etc.
Steam 2	Steam seafood, poached egg and souffle, etc.
Steam 3	Melt chocolate, defrost raspberries.
Steam shot*	Use during Microwave, Grill, Crispy grill, Combo 2 and Oven cooking.



### Combination

Crispy Grill	Frozen deep pan pizza, Frozen thin and crispy pizza, Chilled sausage roll, Chilled breaded fish
Combo 1	Grill chicken wings, Kebabs, Grill spring rolls
Combo 2	Cook sea food and puddings

\* Steam shot — we can touch Steam pad to add steam during cooking. For "Steam shot" details, see page 24.



## Defrosting Tips & Techniques

### Preparation for freezing:

1. Freeze meats, poultry, and fish in packages with only 1 or 2 layers of food. Place wax paper between layers.
2. Package in heavy-duty plastic wraps, bags (labeled "For Freezer"), or freezer paper.
3. Remove as much air as possible.
4. Seal securely, date, and label.

### To Defrost:

1. Remove wrapper. This helps moisture to evaporate. Juices from food can get hot and cook the food.
2. Set food in microwave-safe dish.
3. Place roasts fat-side down. Place whole poultry breast-side down.
4. Select power and minimum time so that items will be under-defrosted.
5. Drain liquids during defrosting.
6. Turn over (invert) items during defrosting.
7. Shield edges and ends if needed. (See Cooking Techniques).

### After Defrosting:























1. Large items may be icy in the centre. Defrosting will complete during **STANDING TIME**.
2. Let stand, covered, following stand time directions on page 31.
3. Rinse foods as indicated in the chart.
4. Items which have been layered should be rinsed separately or have a longer stand time.

## Defrosting Chart

### Defrosting Chart (by setting Micro Power at Defrost):

Food	Approx. Time (minutes per 1 lb [500 g])	Instruction
<b>Meat</b>		
<b>Beef</b>		
Minced Beef	6 - 8	Halfway through the defrost cycle, break apart minced beef, separate chops and remove meat that is defrosted.
Roast: Topside	7 - 9	
Roast: Beef Tenderloin	7 - 9	
Roast: Chuck or Rump	6 - 8	
Roast: Sirloin, rolled	7 - 9	
Steak	6 - 7	
Miscellaneous	6 - 8	
<b>Lamb</b>		
Roast	6 - 8	Large roasts may still be icy in centre. Let stand.
Chops	5 - 7	
Ribs	5 - 7	
<b>Poultry</b>		
Chicken/whole	7 - 9	Turn poultry over two to four times during defrosting. Halfway through the defrost cycle, shield end of drumsticks, wings, breast bones and ends of poultry with foil. Break apart chicken pieces and remove small pieces such as wings, which may be defrosted before larger pieces. Rinse poultry under cold water to remove ice crystals. Let stand 5 to 10 minutes, before cooking.
Chicken/pieces	6 - 8	
Chicken/fillets	6 - 8	
Duck	6 - 8	
Turkey	7 - 9	
<b>Fish &amp; shellfish</b>		
Fish Fillets	6 - 8	Halfway through the defrost cycle, turn whole fish or blocks of fillets over. Also, break apart prawns or scallops. Remove any pieces that are defrosted.  Let stand, 5 to 10 minutes, before cooking.
Whole Fish	6 - 8	
Crabmeat	5 - 7	
Lobster Tails	5 - 7	
Sea Scallops	4 - 6	
Green Prawns	5 - 7	

# Cooking Chart

Food	Weight/ Quantity	Pad	Power Level	Time to Select (approx.)	Instructions
<b>Meat</b>					
Lamb joint	Maximum weight 3.3 lb (1.5 kg)		350 °F (180 °C)	20 mins per 500 g plus 25-30 mins	Preheat oven. Cook on Grill Tray in lower shelf position. Turn halfway. Wrap in foil and allow to stand for 10 mins after cooking.
Steak -medium	5 oz. (150 g)		Grill 1	8-9 mins	Place on Grill Tray in upper shelf position. Turn halfway
Steak -well done				10-12 mins	
Beef joint -well done	Maximum weight 3.3 lb (1.5 kg)		425 °F (220 °C)	20 mins per 500 g plus 30-35 mins	Preheat oven. Place on Grill Tray in lower shelf position. Turn halfway.
Roast lamb	3.3 lb (1.5 kg)		Combo 2	55-60 mins	Place lamb on Wire Rack with a heaterproof dish underneath. Turn halfway.
<b>Fish and Shellfish</b>					
Fresh fish fillets	500 g (1 lb)		600 W	5-7 mins	Place in a microwave safe and heat-proof dish with cover on base of oven.
Frozen fish fillets	500 g (1 lb)		1000 W	9-10 mins	
Prawns	500 g (1 lb)		600 W	5-7 mins	
Mussels	500 g (1 lb)		600 W	5-7 mins	
Fish thin fillets	500 g (1 lb)		300 W + Steam	5-7 mins	<b>Fill the water tank.</b> Place in a microwave safe and heat-proof dish without cover on base of oven.
<b>Poultry</b>					
Chicken breasts (boneless and skinless)	9 oz. (250 g)		Steam 1	28-30 mins	<b>Fill the water tank.</b> Place on Grill Tray in upper shelf position.
Chicken legs	21 oz. (600 g)		Combo 2	30 mins	Place on Grill Tray in upper shelf position.
Whole chicken	per 1 lb (500 g)		375 °F (190 °C)	30-35 mins	Preheat the oven. Place chicken on Wire Rack with a heaterproof dish underneath. Turn halfway.
<b>Fresh vegetable</b>					
Asparagus	7 oz. (200 g)		300 W + Steam	5-6 mins	<b>Fill the water tank.</b> Place in a microwave safe and heat-proof dish without cover on base of oven.
Broccoli	9 oz. (250 g)		300 W + Steam	7-8 mins	
Peas	7 oz. (200 g)		300 W + Steam	4-5 mins	
Boiled potatoes	1 lb (500 g)		300 W + Steam	14-15 mins	
Roasted potatoes	14 oz. (400 g)		Combo 2	20-22 mins	Place potatoes on Wire Rack with a heaterproof dish underneath. Turn halfway.
Gratins (dauphine potatoes, moussaka, lasagnes, tartifette, shepard's pie, macaroni)	28 oz. (800 g)	 then 	Combo 2 then Grill 1	15-20 mins then 5 mins	Place in heatproof dish on base of oven.
<b>Rice</b>					
Long grain white	9 oz. (250 g)		1000 W	11-13 mins	Use a 5 L microwave safe container. Add 550 ml boiling water. Cover partly and stir halfway.
<b>Pasta</b>					
Fusilli	7 oz. (200 g)		1000 W	10 mins	Use a 5 L microwave safe container. Add 550 ml boiling water and 15 ml oil. Cover partly and stir halfway.
Spaghetti	9 oz. (250 g)		1000 W	8-10 mins	

# Reheating Chart

The times given in the charts below are a guideline only, and will vary depending on STARTING temperature, dish size and quantity. Pastry or bread items reheated by microwave will be soft not crisp.

Food	Weight/ Quantity	Pad	Power Level	Cooking Time (approx.)	Instructions
Chilled meal	7 oz. (200 g)		1000 W	2 mins - 2 mins 30 secs	Place in a microwave safe and heat-proof dish on base of oven.
Chilled fried food	14 oz. (400 g)	then	Combo 2 then Grill 3	3-5 mins then 4 mins	Place food on Wire Rack with a heaterproof dish underneath. Turn halfway.
Frozen meal	7 oz. (200 g)		1000 W	3 mins 30 secs - 4 mins	Place in a microwave safe and heat-proof dish on base of oven.
Sandwich	3.5 oz. (100 g)		1000 W	30 secs	Place in a microwave safe and heat-proof dish on base of oven.
Canned soup	20 oz liq. (600 ml)		1000 W	3-4 mins	Place in a microwave safe and heat-proof dish with cover on base of oven. Stir half way and end of cooking.
Beverage	8 oz liq. (235 ml)		1000 W	1 min 30 secs	Place in a microwave safe cup on base of oven. Stir half way and end of cooking.
Milk	1 tasse (250 ml)		1000 W	1 min - 1 min 20 secs	Place in a microwave safe cup on base of oven. Stir half way and end of cooking.
<b>Canned vegetables</b>					Place in a microwave safe and heat-proof bowl with cover. Place on base and stir halfway.
Bean	14.5 oz. (415 g)		1000 W	2 mins 30 secs - 3 mins	
Tomato	14 oz. (400 g)		1000 W	2 mins	
Mushrooms	10 oz. (290 g)		1000 W	2 mins - 2 mins 30 secs	
Sweetcorn	11.5 oz. (330 g)		1000 W	2 mins - 2 mins 30 secs	
Meat pies	5 oz. (150 g)		1000 W	1 min 30 secs- 2 mins	Place in a microwave safe and heat-proof bowl on base.
			Crispy Grill	11-12 mins	Remove product from foil container and place on Grill Tray in the lower shelf position.
Quiche	14 oz. (400 g)		Crispy Grill	13-15 mins	Remove product from foil container and place on Grill Tray in the lower shelf position.
Frozen fruit tart	16 oz. (450 g)		Crispy Grill	9-12 mins	Remove product from foil container and place on Grill Tray in the lower shelf position.
Frozen egg tart	10.5 oz. (300 g)		Crispy Grill	10-11 mins	Remove product from foil container and place on Grill Tray in the lower shelf position.
Frozen spring rolls	7 oz. (200 g)		Crispy Grill	8-11 mins	Brush oil on the spring rolls. Place on Grill Tray in the upper shelf position.
Frozen Pizza	10.5 oz. (300 g)		Crispy Grill	7-9 mins	Remove product from foil container and place on Grill Tray in the upper shelf position.

# Food Characteristics

## Bone and Fat

Both bone and fat affect cooking. Bones may cause irregular cooking. Meat next to the tips of bones may overcook while meat positioned under a large bone, such as a ham bone, may be undercooked. Large amounts of fat absorb microwave energy and the meat next to these areas may overcook.



## Shape

Uniform sizes heat more evenly. The thin end of a drumstick will cook more quickly than the meaty end. To compensate for irregular shapes, place thin parts toward the center of the dish and thick pieces toward the edge.

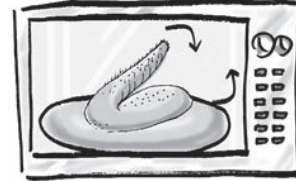

## Density

Porous, airy foods such as breads, cakes or rolls take less time to cook than heavy, dense foods such as potatoes and roasts. When reheating donuts or other foods with different centers be very careful. Certain foods have centers made with sugar, water, or fat and these centers attract microwaves (for example, jelly donuts). When a jelly donut is heated, the jelly can become extremely hot while the exterior remains warm to the touch. This could result in a burn if the food is not allowed to cool properly in the center.



## Size

Thin pieces cook more quickly than thick pieces.



## Starting Temperature

Foods that are at room temperature take less time to cook than if they are chilled, refrigerated or frozen.



## Quantity

Two potatoes take longer to cook than one potato. As the quantity of the food decreases so does the cooking time. Overcooking will cause the moisture content in the food to decrease and a fire could result. Never leave microwave unattended while in use.



# Cooking Techniques

## Piercing

Foods with skins or membranes must be pierced, scored or have a strip of skin peeled before cooking to allow steam to escape. Pierce clams, oysters, chicken livers, whole potatoes and whole vegetables. Whole apples or new potatoes should have a 1-inch strip of skin peeled before cooking. Score sausages and frankfurters. Do not Cook/Reheat whole eggs, with or without the shell. Steam buildup in whole eggs may cause them to explode, and possibly damage the oven or cause injury. Reheating SLICED hard-boiled eggs and cooking SCRAMBLED eggs is safe.



## Browning

Foods will not have the same brown appearance as conventionally cooked foods or those foods which are cooked utilizing a browning feature. Meats and poultry may be coated with browning sauce, Worcestershire sauce, barbecue sauce or shake-on browning sauce. To use, combine browning sauce with melted butter or margarine and brush on before cooking. For quick breads or muffins, brown sugar can be used in the recipe in place of granulated sugar, or the surface can be sprinkled with dark spices before baking.



## Spacing

Individual foods, such as baked potatoes, cupcakes and appetizers, will cook more evenly if placed in the oven equal distances apart. When possible, arrange foods in a circular pattern.



## Covering

As with conventional cooking, moisture evaporates during microwave cooking. Casserole lids or plastic wrap are used for a tighter seal. When using plastic wrap, vent the plastic wrap by folding back part of the plastic wrap from the edge of the dish to allow steam to escape. Loosen or remove plastic wrap as recipe directs for stand time. When removing plastic wrap covers, as well as any glass lids, be careful to remove them away from you to avoid steam burns. Various degrees of moisture retention are also obtained by using wax paper or paper towels.

## Shielding

Thin areas of meat and poultry cook more quickly than meaty portions. To prevent overcooking, these thin areas can be shielded with strips of aluminum foil. Wooden toothpicks may be used to hold the foil in place.

**▲ CAUTION** is to be exercised when using foil. Arcing can occur if foil is too close to oven wall or door and damage to your oven will result.

## Cooking Time

Cooking times will vary because of food shape variations, starting temperature, and regional preferences. Always cook food for the minimum cooking time given in a recipe and check for doneness. If the food is undercooked, continue cooking. It is easier to add time to an undercooked product. Once the food is overcooked, nothing can be done.

## Stirring

Stirring is usually necessary during microwave cooking. Always bring the cooked outside edges toward the center and the less cooked center portions toward the outside of the dish.

## Rearranging

Rearrange small items such as chicken pieces, shrimp, hamburger patties or pork chops. Rearrange pieces from the edge to the center and pieces from the center to the edge of the dish.

## Turning

It is not possible to stir some foods to distribute the heat evenly. At times, microwave energy will concentrate in one area of the food. To help ensure even cooking, these foods need to be turned. Turn over large foods, such as roasts or turkeys, halfway through cooking.

## Standing Time

Most foods will continue to cook by conduction after the microwave oven is turned off. After cooking meat, the internal temperature will rise 5 °F to 15 °F (3 °C to 8 °C), if allowed to stand, tented with foil, for 10 to 15 minutes. Casseroles and vegetables need a shorter amount of standing time, but this standing time is necessary to allow foods to complete cooking to the center without overcooking on the edges.

## Test for Doneness

The same tests for doneness used in conventional cooking may be used for microwave cooking. Meat is done when fork-tender or splits at fibers. Chicken is done when juices are clear yellow and drumstick moves freely. Fish is done when it flakes and is opaque. Cake is done when a toothpick or cake tester is inserted and comes out clean.

Check foods to see that they are cooked according to the United States Department of Agriculture's recommended temperatures. To test for doneness, insert a meat thermometer in a thick or dense area away from fat or bone. NEVER leave the thermometer in the food during cooking, unless it is approved for oven use.

Cook all food to these minimum internal temperatures as measured with a food thermometer before removing food from oven. For reasons of personal preference, you may choose to cook food at higher temperatures.

Product	Minimum Internal Temperature & Rest Time
Beef, Pork, Veal & Lamb Steaks, chops, roasts	145 °F (63 °C) and allow to rest for at least 3 minutes
Ground meats	160 °F (71 °C)
Ham, fresh or smoked (uncooked)	145 °F (63 °C) and allow to rest for at least 3 min.
Fully Cooked Ham (to reheat)	Reheat cooked hams packaged in USDA-inspected plants to 140 °F (60 °C); all others to 165 °F (74 °C).
All Poultry (breasts, whole bird, legs, thighs, and wings, ground poultry, and stuffing)	165 °F (74 °C)
Eggs	160 °F (71 °C)
Fish & Shellfish	145 °F (63 °C)
Leftovers	165 °F (74 °C)
Casseroles	165 °F (74 °C)

## Care and Cleaning of Your Microwave Oven

Please see below and the following page for particular cleaning instructions for each section of the oven.

**BEFORE CLEANING:** Unplug oven at wall outlet. If outlet is inaccessible, leave oven door open while cleaning.

**AFTER CLEANING:** Touch **Stop/Reset** to clear the Display.

- Outside oven surfaces:** Clean with a damp cloth. To prevent damage to the operating parts inside the oven, water should not be allowed to seep into ventilation openings.
- Label:** Do not remove. Wipe with a damp cloth.
- Upper heater:** Clean the upper heater after it is completely cold. Wipe with a soft and damp cloth carefully to avoid breaking the heater and hurting your fingers by the broken heater.
- Flat table:** Always clean the flat table after cooling down with a mild detergent and wipe to dry.
- Control Panel:** Do not allow the Control Panel to become wet. Clean with a soft, damp cloth. Do not use detergents, abrasives or sprayon cleaners on the Control Panel. When cleaning the Control Panel, leave oven door open to prevent oven from accidentally turning on. After cleaning touch **Stop/Reset** pad to clear display window.
- Inside the Oven:** Wipe with a damp cloth after using. Mild detergent may be used if needed. Do not use harsh detergents or abrasives.
- Oven Door:** Wipe with a soft dry cloth when steam accumulates inside or around the outside of the oven door. During cooking, especially under high humidity conditions, steam is given off from the food. (Some steam will condense on cooler surfaces, such as the oven door. This is normal.)

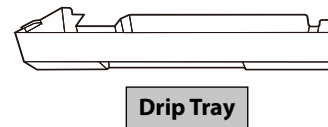
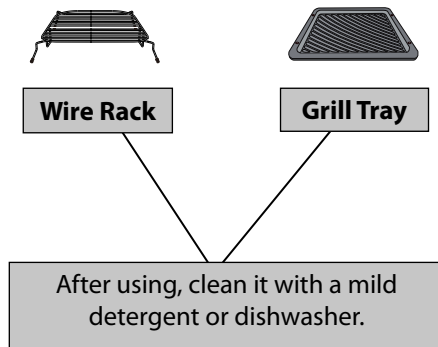
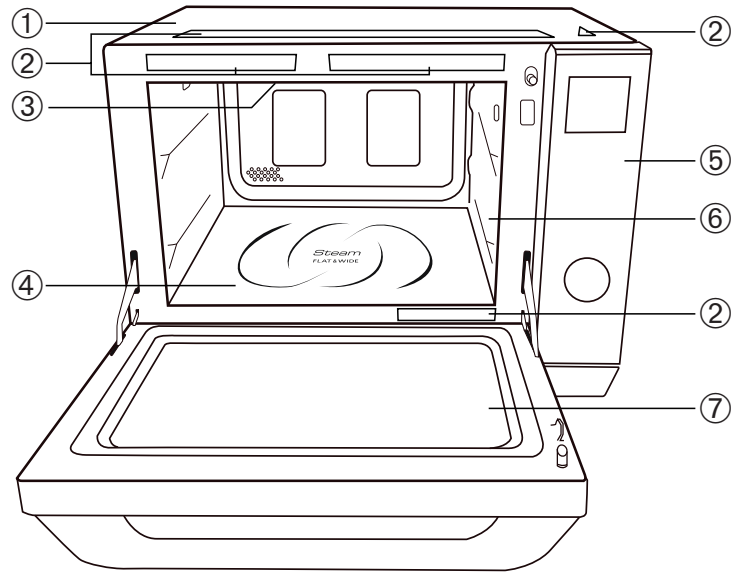

1. Always keep the drip tray clean.
2. Clean and wipe dry after use.
3. After cleaning, re-connect the drip tray to the plastic feet.
4. DO NOT USE A DISHWASHER TO CLEAN THE DRIP TRAY.

### NOTES:

1. When using the Grill, Oven or cooking in the Combination (Crispy Grill/Combo 1/Combo 2) mode, some foods may inevitably splatter grease on to the oven walls. If the oven is not cleaned, occasionally it may start to "smoke" during use. These marks will be more difficult to clean later.
2. After Grill, Oven, Combination (Crispy Grill/Combo 1/Combo 2) cooking the ceiling and walls of the oven should be cleaned with a soft cloth squeezed in soapy water. Particular care should be taken to keep the window area clean particularly after cooking by Grill, Oven, Combination (Crispy Grill/Combo 1/Combo 2). Stubborn spots inside the oven can be removed by using a small amount of microwave oven cleaner sprayed onto a soft damp cloth. Wipe onto problem spots, leave for recommended time and then wipe off. This method can not be used to clean the oven door. DO NOT SPRAY DIRECTLY INSIDE THE OVEN. A steam cleaner is not to be used for cleaning.
3. Failure to maintain the oven in a clean condition could lead to deterioration of the surface that could adversely affect the life of the appliance and possibly result in a hazardous situation.
4. Do not use harsh abrasive cleaners or sharp metal scrapers to clean the oven door glass since they can scratch the surface, which may result in shattering of the glass.
5. When it becomes necessary to replace the oven light, please consult the service center specified by Panasonic.

**IT IS IMPORTANT TO KEEP THE OVEN CLEAN AND DRY. FOOD RESIDUE AND CONDENSATION MAY CAUSE RUSTING OR ARCING AND DAMAGE TO THE OVEN. AFTER USE, WIPE DRY ALL SURFACES.**



# Care and Cleaning of Your Microwave Oven (continued)

## Cleaning the Water Tank

Clean with a soft sponge in water.



Remove the water tank and clean the compartment where the water tank is inserted.

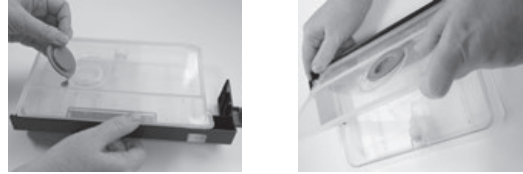

Open the water supply cap, remove the lid and pipe cap and clean.

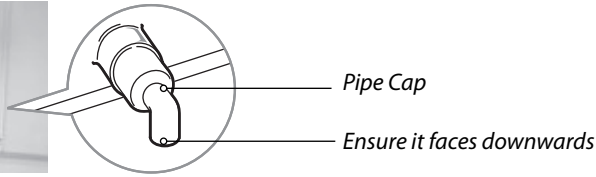

If the pipe cap is difficult to remove, wiggle from side to side. When re-fitting, make sure that the pipe faces down (see diagram).

The front of the tank can also be removed for cleaning.

### Removing the Front Cover

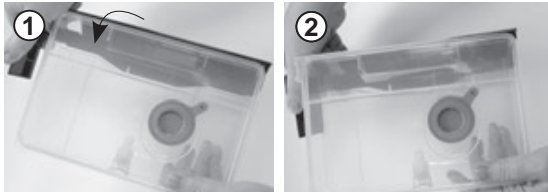

1. Lightly twist the cover until the far side unclips.
2. Continue to twist until the near side unclips.

### Re-fitting the Front Cover

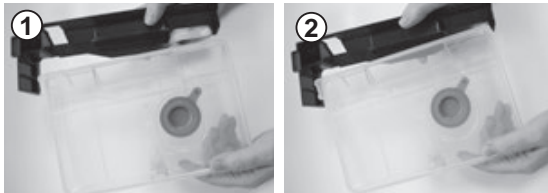

1. Align the slots on the cover with the holes on the tank.
2. Insert and push down until it clicks.

### NOTES:

1. Clean the water tank at least once a week to prevent build up of limescale.
2. Do not use a dishwasher to clean the water tank or parts of the water tank.



## Before Requesting Service

### THESE THINGS ARE NORMAL

My oven causes interference with my TV. Is this normal?	Some radio, TV, Wi-Fi, cordless telephone, baby monitor, blue tooth or other wireless equipment interference might occur when you cook with the microwave oven. This interference is similar to the interference caused by small appliances such as mixers, vacuums, blow dryers, etc. It does not indicate a problem with your oven.
Steam accumulates on the oven door and warm air comes from the oven vents.	During cooking, steam and warm air are given off from the food. Most of the steam and warm air are removed from the oven by the air which circulates in the oven cavity. However, some steam will condense on cooler surfaces such as the oven door. This is normal.
I accidentally ran my microwave oven without any food in it.	Running the oven empty for a short time will not damage the oven. However, we do not recommend this.
The oven has an odour and generates smoke when using Grill, Oven or Combination function.	It is essential that your oven is wiped out regularly particularly after cooking by Grill, Oven or Combination. Any fat and grease that builds up on the roof and walls of the oven will begin to smoke if not cleaned.
There are humming and clicking noises from my oven when I cook by Combination.	These noise occur as the oven automatically switch the grill. This is normal.
Some smoke will be given off from the cavity when using Grill, Oven or Combination for the first time.	It caused by the excessive oil in the cavity and oil used for rust protection volatilizing.

## Before Requesting Service (continued)

See below before calling for service, as most problems can easily be remedied by following these simple solutions:

PROBLEM	POSSIBLE CAUSE	REMEDY
Oven will not turn on.	The oven is not plugged in securely.	Remove plug from outlet, wait 10 seconds and re-insert.
	Main circuit breaker or main fuse is tripped or blown.	Reset main circuit breaker or replace main fuse.
	There is a problem with the outlet.	Plug another appliance into the outlet to check if the outlet is working.
Oven will not start cooking.	The door is not closed completely.	Close the oven door securely.
	<b>Start</b> pad was not touched after programming	Touch <b>Start</b> pad.
	Another program has already been entered into the oven.	Touch <b>Stop/Reset</b> pad to cancel the previous program and program again.
	The program has not been entered correctly.	Program again according to the Owner's Manual.
	<b>Stop/Reset</b> pad has been touched accidentally.	Program oven again.
"HOT" appears in the display window.	The cavity is overheated.	Operate again after it cools down.
"COOLING" appears in the display window.	The fan is operating to cool the electric components.	The word "COOLING" will disappear after the fan stops.
The "🔒" and "LOCK" appears in the display window.	The Child Lock was activated by tapping <b>Start</b> pad 3 times.	Deactivate Lock by tapping <b>Stop/Reset</b> pad 3 times.
The oven stops cooking and "SERVICE" appears in the display window.	The display indicates a problem with microwave generation system.	Please contact an authorised Service Center (see next page).
If "FILL WATER TANK" appear twice in display window during cooking, and water tank still empty, then "U14" will appear.	The water tank is empty.	<ul style="list-style-type: none"> <li>• If "FILL WATER TANK" appears in the display window. Re-fill the water tank, position back in the oven and touch <b>Start</b> pad to resume cooking.</li> <li>• If "U14" appears in the display window. Re-fill the water tank, position back in the oven. Touch <b>Stop/Reset</b> pad to reset.</li> </ul>
"DEMO MODE PRESS ANY KEY" or "D" appears in the display window.	The oven is under demonstration mode.	Tap <b>Micro Power</b> pad once, <b>Start</b> pad 4 times and <b>Stop/Reset</b> pad 4 times.

Demonstration mode is designed for retail store display. Cooking and other functions will not operate during the demonstration mode. If it seems there is a problem with the oven, contact an authorized Service Centre.

# Warranty

Panasonic Canada Inc.  
5770 Ambler Drive, Mississauga, Ontario L4W 2T3  
**Panasonic PRODUCT – LIMITED WARRANTY**

Panasonic Canada Inc. warrants this product to be free from defects in material and workmanship under normal use and for a period as stated below from the date of original purchase agrees to, at its option either (a) repair your product with new or refurbished parts, (b) replace it with a new or a refurbished equivalent value product, or (c) refund your purchase price. The decision to repair, replace or refund will be made by Panasonic Canada Inc.

Category	Service type	Parts	Labour	Magnetron
Counter top microwave oven (except Prestige models)	Carry-in	1 Year	1 Year	Additional 4 Years (Part only)
Counter top microwave oven – Prestige model (Genius Prestige, Genius Prestige Plus and Genius Prestige Grill)	In-home	2 Years	2 Years	Additional 3 Years (Part only)
Microwave Convection oven	In-home	2 Years	2 Years	Additional 3 Years (Part only)
Over The Range (OTR) microwave oven	In-home	2 Years	2 Years	Additional 3 Years (Part only)

In-home Service will be carried out only to locations accessible by roads and within 50 km of an authorized Panasonic service facility.

This warranty is given only to the original purchaser, or the person for whom it was purchased as a gift, of a Panasonic brand product mentioned above sold by an authorized Panasonic dealer in Canada and purchased and used in Canada, which product was not sold "as is", and which product was delivered to you in new condition in the original packaging.

**IN ORDER TO BE ELIGIBLE TO RECEIVE WARRANTY SERVICE HEREUNDER, A PURCHASE RECEIPT OR OTHER PROOF OF DATE OF ORIGINAL PURCHASE, SHOWING AMOUNT PAID AND PLACE OF PURCHASE IS REQUIRED**

## **LIMITATIONS AND EXCLUSIONS**

This warranty ONLY COVERS failures due to defects in materials or workmanship, and DOES NOT COVER normal wear and tear or cosmetic damage. The warranty ALSO DOES NOT COVER damages which occurred in shipment, or failures which are caused by products not supplied by Panasonic Canada Inc., or failures which result from accidents, misuse, abuse, neglect, mishandling, misapplication, alteration, faulty installation, set-up adjustments, misadjustment of consumer controls, improper maintenance, power line surge, lightning damage, modification, introduction of sand, humidity or liquids, commercial use such as hotel, office, restaurant, or other business or rental use of the product, or service by anyone other than a Authorized Servicer, or damage that is attributable to acts of God.

**Over-The-Range cooktop light bulbs are excluded from coverage under this warranty.  
In the case where the microwave oven is built-in, the warranty will be voided if using a non-Panasonic trim kit.**

THIS EXPRESS, LIMITED WARRANTY IS IN LIEU OF ALL OTHER WARRANTIES, EXPRESS OR IMPLIED, INCLUDING ANY IMPLIED WARRANTIES OF MERCHANTABILITY AND FITNESS FOR A PARTICULAR PURPOSE. IN NO EVENT WILL Panasonic Canada Inc. BE LIABLE FOR ANY SPECIAL, INDIRECT OR CONSEQUENTIAL DAMAGES RESULTING FROM THE USE OF THIS PRODUCT OR ARISING OUT OF ANY BREACH OF ANY EXPRESS OR IMPLIED WARRANTY. (As examples, this warranty excludes damages for lost time, travel to and from the Authorized Servicer, loss of or damage to media or images, data or other memory or recorded content. This list of items is not exhaustive, but for illustration only.)

In certain instances, some jurisdictions do not allow the exclusion or limitation of incidental or consequential damages, or the exclusion of implied warranties, so the above limitations and exclusions may not be applicable. This warranty gives you specific legal rights and you may have other rights which vary depending on your province or territory.

## **WARRANTY SERVICE**

### **PRODUCT OPERATION ASSISTANCE**

For product information and operation assistance, please visit our Support page: [www.panasonic.ca/english/support](http://www.panasonic.ca/english/support)

### **PRODUCT REPAIRS**

Please locate your nearest Authorized Servicentre: [panasonic.ca/english/support/servicentrelocator](http://panasonic.ca/english/support/servicentrelocator)

### **IF YOU SHIP THE PRODUCT TO A SERVICENTRE**

Carefully pack and send prepaid, adequately insured and preferably in the original carton.  
Include details of the defect claimed, and proof of date of original purchase.

## Specifications

Power Source .....	120 V, 60 Hz
Power Consumption:	
Microwave .....	8.6 A 1020 W
Steam .....	8.5 A 1020 W
Grill .....	10.1 A 1220 W
Oven .....	10.5 A 1270 W
Combination .....	12.2 A 1450 W
Cooking Power*:	
Microwave .....	1000 W
Grill .....	1200 W
Oven .....	1250 W
Grill Heater Top .....	1200 W
Outside Dimensions (W x H x D): .....	20.1" (512 mm) (W) x 13.6" (347 mm) (H) x 16.4" (416 mm) (D)
Oven Cavity Dimensions (W x H x D): .....	13.2" (335 mm) (W) x 9.4" (238 mm) (H) x 13.8" (350 mm) (D)
Operating Frequency: .....	2450 MHz
Net Weight .....	Approx. 36 lb (16.4 kg)

\*IEC Test procedure

Specifications subject to change without notice.

## User's Record

The serial number of this product may be found on the back side of the oven or on the left side of the control panel. You should note the model number and the serial number of this oven in the space provided and retain this book as a permanent record of your purchase for future reference.

Model No. \_\_\_\_\_

Serial No. \_\_\_\_\_

Date of Purchase \_\_\_\_\_