

Panasonic®

Owner's Manual
Microwave Oven
Household Use Only
Model No. NN-SC64MW



READ ALL INSTRUCTIONS CAREFULLY BEFORE USING THE OVEN.

For assistance, please contact us via the web at:

<http://www.panasonic.ca/english/support>

CONTENTS

Safety Information

IMPORTANT SAFETY INSTRUCTIONS	1-2
Installation and Grounding Instructions.....	3-5
Food Preparation.....	5-6
Cookware Guide	7
Location of Controls	8

Operation

Using the Microwave for the First Time	9
Setting the Clock	9
Setting the Child Safety Lock.....	9
Cooking.....	10
Setting a Standing Time	10
Setting a Delayed Start.....	11
Quick 30.....	11
Keep Warm	11
Popcorn	12
Turbo Defrost	13
Defrosting Tips & Techniques.....	13
Sensor Reheat.....	14
Sensor Cook.....	14
Sensor Cook Chart.....	15
Setting the Timer.....	16
Microwave Recipes.....	17
Food Characteristics.....	18

Maintenance

Care and Cleaning of Your Microwave Oven.....	19
Shop Accessories.....	19
Before Requesting Service	20
Limited Warranty (Only for Canada)	21

General Information

Specifications.....	22
User's Record	23



IMPORTANT SAFETY INSTRUCTIONS

Your safety and the safety of others are very important.



We have provided important safety messages in this manual and on your appliance. Always read and obey all safety messages.

This is the safety alert symbol. It is used to alert you to potential hazards that can kill or hurt you and others.

All safety messages will follow the safety alert symbol and either the word "DANGER", "WARNING" or "CAUTION". These words mean:

DANGER

You can be killed or seriously injured if you don't immediately follow instructions.

WARNING

You can be killed or seriously injured if you don't follow instructions.

CAUTION

You can be exposed to a potentially hazardous situation which, if not avoided, may result in minor or moderate injury.

All safety messages will tell you what the potential hazard is, tell you how to reduce the chance of injury, and tell you what can happen if the instructions are not followed.



PRECAUTIONS TO AVOID POSSIBLE EXPOSURE TO EXCESSIVE MICROWAVE ENERGY

- (a) **DO NOT** attempt to operate this oven with the door open since open-door operation can result in harmful exposure to microwave energy. It is important not to defeat or tamper with the safety interlocks.
- (b) **DO NOT** place any object between the oven front face and the door or allow soil or cleaner residue to accumulate on sealing surfaces.
- (c) **DO NOT** operate the oven if it is damaged. It is particularly

important that the oven door close properly and that there is no damage to the:

- (1) DOOR (bent),
- (2) HINGES AND LATCHES (broken or loosened),
- (3) DOOR SEALS AND SEALING SURFACES.
- (d) The oven should not be adjusted or repaired by anyone except properly qualified service personnel.

Thank you for purchasing a Panasonic Microwave Oven

When using electrical appliances basic safety precautions should be followed, including the following.

WARNING

To reduce the risk of burns, electric shock, fire, injury to persons, or exposure to excessive microwave energy:

1. Read all instructions before using the appliance.
2. Read and follow the specific: "**PRECAUTIONS TO AVOID POSSIBLE EXPOSURE TO EXCESSIVE MICROWAVE ENERGY**" found on page 1.
3. This appliance must be grounded. Connect only to properly grounded outlet. See "**GROUNDING INSTRUCTIONS**" found on page 3.
4. Install or locate this appliance only in accordance with the provided installation instructions.
5. As with any appliance, close supervision is necessary when used by children.
6. When cleaning surfaces of door and oven that comes together on closing the door, use only mild, nonabrasive soaps, or detergent applied with a sponge or soft cloth.
7. Keep cord away from heated surface.
8. Liquids, such as water, coffee, or tea are able to overheat beyond the boiling point without appearing to be boiling. Visible bubbling or boiling when the container is removed from the microwave oven is not always present. **THIS COULD RESULT IN VERY HOT LIQUID SUDDENLY BOILING OVER WHEN THE CONTAINER IS DISTURBED OR A UTENSIL IS INSERTED INTO THE LIQUID.** To reduce the risk of injury to persons:
 - (a) **DO NOT** overheat the liquid.

IMPORTANT SAFETY INSTRUCTIONS (continued)

- (b) Stir the liquid both before and halfway through heating it.
 - (c) **DO NOT** use straight-sided containers with narrow necks.
 - (d) After heating, allow the container to stand in the microwave oven for a short time before removing the container.
 - (e) Use extreme care when inserting a spoon or other utensil into the container.
9. This appliance should be serviced only by qualified service personnel. Contact nearest authorized service facility for examination, repair, or adjustment.
 10. To reduce the risk of fire in the oven cavity:
 - (a) **DO NOT** overcook food. Carefully attend appliance when paper, plastic, or other combustible materials are placed inside the oven to facilitate cooking.
 - (b) Remove wire twist-ties from paper or plastic bag before placing bag in oven.
 - (c) If material inside of the oven ignites, keep oven door closed, turn oven off, and disconnect the power cord, or shut off power at the fuse or circuit breaker panel.
 - (d) **DO NOT** use the cavity for storage purposes. **DO NOT** leave paper products, cooking utensils, or food in the cavity when not in use.
 11. Some products such as whole eggs and sealed containers, for example, closed glass jars are able to explode and should not be heated in this oven.
 12. **DO NOT** store this appliance outdoors. **DO NOT** use this product near water - for example, near a kitchen sink, in a wet basement, near a swimming pool, or similar location.
 13. **DO NOT** immerse cord or plug in water or any other liquid.
 14. Use this appliance only for its intended use as described in the manual. **Do not** use corrosive chemicals or vapors in this appliance. This type of oven is specifically designed to heat, cook or dry food. It is not designed for industrial or laboratory use.
 15. **DO NOT** operate this appliance if it has a damaged cord or plug, if it is not working properly, or if it has been damaged or dropped.
 16. **DO NOT** cover or block any openings on the appliance.
 17. **DO NOT** let cord hang over edge of table or counter.

SAVE THESE INSTRUCTIONS HOUSEHOLD USE ONLY (NOT FOR COMMERCIAL USE)



UTENSILS

CAUTION

Personal Injury Hazard:

Tightly-closed utensils could explode. Closed containers should be opened and plastic pouches should be pierced before cooking.

See the instructions on "Materials you can use in microwave oven." or "Materials can not be used in microwave oven."

There may be certain non-metallic utensils that are not safe to use for microwaving. If in doubt, you can test the utensil in question following the procedure below.

Utensil Test:

1. Fill a microwave-safe container with 1 cup of cold water (250ml) along with the utensil in question.

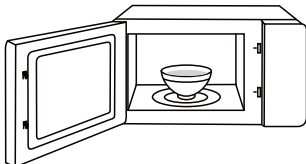

2. Cook on maximum power for 1 min.
3. Carefully feel the utensil. If the empty utensil is warm, do not use it for microwave cooking.
4. **DO NOT** exceed 1 min cooking time.

CAUTION

KEEP THE CAVITY CLEAN

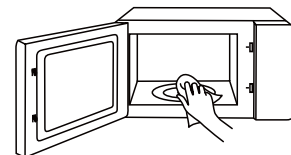



RADIO INTERFERENCE

1. Operation of the microwave oven may cause interference to your radio, TV or similar equipment.
2. When there is interference, it may be reduced or eliminated by taking the following measures:
 - (a) Clean door and sealing surface of the oven.
 - (b) Reorient the receiving antenna of radio or television.
 - (c) Relocate the microwave oven with respect to the receiver.
 - (d) Move the microwave oven away from the receiver.
 - (e) Plug the microwave oven into a different outlet so that microwave oven and receiver are on different branch circuits.

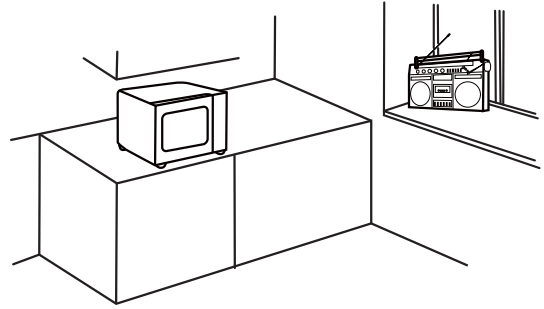

GROUNDING INSTRUCTIONS

Grounding Instructions

THIS APPLIANCE MUST BE GROUNDED.

In the event of an electrical short circuit, grounding reduces the risk of electric shock by providing an escape wire for the electric current. This appliance is equipped with a cord having a grounding wire with a grounding plug. The plug must be plugged into an outlet that is properly installed and grounded.

WARNING

Improper use of the grounding can result in a risk of electric shock. Consult a qualified electrician or serviceman if the grounding instructions are not completely understood, or if doubt exists as to whether the appliance is properly grounded. If it is necessary to use an extension cord, use only a 3-wire extension cord that has a 3-blade grounded plug, and 3-slot receptacle that will accept the plug on the appliance. The marked rating of the extension cord shall be equal to or greater than the electrical rating of the appliance.

DANGER

Electric Shock Hazard:

Touching some of the internal components can cause serious personal injury or death. Do not disassemble this appliance.

WARNING

Electric Shock Hazard:

Improper use of the grounding can result in electric shock. Do not plug into an outlet until appliance is properly installed and grounded.

1. A short power-supply cord is provided to reduce the risks resulting from becoming entangled in or tripping over a longer cord.
2. Longer cord sets, or extension cords, are not recommended.
3. If a long cord or extension cord is used:
 - (a) The marked electrical rating of the cord set or extension cord should be at least as great as the electrical rating of the appliance.
 - (b) The extension cord must be a grounding-type 3-wire cord.
 - (c) The longer cord should be arranged so that it will not drape over the counter top or tabletop where it can be pulled on by children or tripped over unintentionally.



Grounding Instructions

Grounding Instructions

THIS APPLIANCE MUST BE GROUNDED.

In the event of an electrical short circuit, grounding reduces the risk of electric shock by providing an escape wire for the electric current. This appliance is equipped with a cord having a grounding wire with a grounding plug.

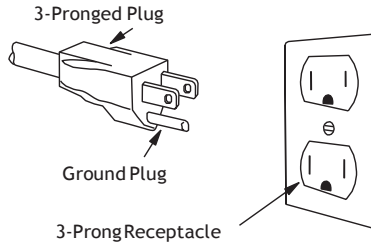

The plug must be plugged into an outlet that is properly installed and grounded.

- **Plug into properly installed and grounded three-prong outlet.**
- **DO NOT** remove ground prong.
- **DO NOT** use an adapter.

Wiring Requirements

1. The oven must be operated on a DEDICATED CIRCUIT. No other appliance should share the circuit with the microwave oven. If it does, the branch circuit fuse may blow or the circuit breaker may trip.
2. The oven must be plugged into at least a 20 A, 120 V, 60 Hz GROUNDED OUTLET. Where a standard two-prong outlet is encountered, it is the personal responsibility and obligation of the consumer to have it replaced with a properly grounded three-prong outlet.
3. The VOLTAGE used must be the same as specified on this microwave oven (120 V, 60 Hz).
4. Using a higher voltage is dangerous and may result in a fire or oven damage. Using a lower voltage will cause slow cooking. Panasonic is NOT responsible for any damages resulting from the use of the oven with any voltage other than specified.

TV / RADIO/WIRELESS EQUIPMENT INTERFERENCE

This product has been tested and found to comply with the limits or Microwave Oven, pursuant to Part 18 of the FCC Rules. This product can radiate radio frequency energy, which could cause interference to such products as radio, TV, baby monitor, cordless phone, Bluetooth, wireless router, etc., which can be confirmed by turning this product off and on. If present, the user is encouraged to try to correct by taking one or more of the following countermeasures:

- (1) Increase the spacing distance between the microwave oven and other product receiving the interference.
- (2) If possible, use a properly installed receiver antenna and/or reorient the receiving antenna of the other product receiving the interference.
- (3) Plug the microwave oven into a different outlet from the other product receiving the interference.
- (4) Clean door and sealing surfaces of the oven. (See Care and Cleaning of Your Microwave Oven)

Installation

Examine Your Oven

Unpack oven, remove all packing material and examine the oven for any damage such as dents, broken door latches or cracks in the door. Notify dealer immediately if oven is damaged. **DO NOT** install if oven is damaged.

Placement of Oven

1. The oven must be placed on a flat, stable surface. For proper ventilation, a minimum clearance of 3.0 inches (7.5cm) is required between the oven and any adjacent walls and right side must be open. Leave a minimum clearance of 12 inches (30cm) above the oven.

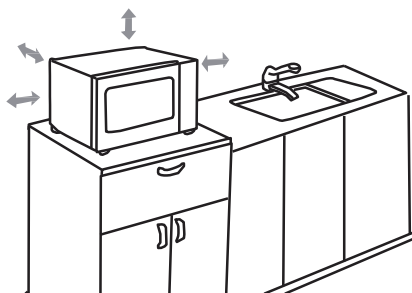

- (a) **DO NOT** block air vents. If they are blocked during operation, the oven may overheat and be damaged.
 - (b) **DO NOT** place oven near a hot, damp surface such as a gas or electric range, sink, or dishwasher.
 - (c) **DO NOT** operate oven when room humidity is excessive.
2. This oven is manufactured for household use only. It is not approved or tested for mobile vehicle, marine, or commercial use.

Installation

1. **DO NOT** block air vents. If they are blocked during operation, the oven may overheat. If the oven overheats, a thermal safety device will turn the oven off. The oven will remain inoperable until it has cooled.

Food Preparation

Follow these Safety Precautions when cooking in your oven.

IMPORTANT

Proper cooking depends upon the power, the time setting and quantity of food. If you use a smaller portion than recommended but cook at the time for the recommended portion, fire could result.

1) HOME CANNING / STERILIZING / DRYING FOODS / SMALL QUANTITIES OF FOODS

- **DO NOT** use your oven for home canning. Your oven cannot maintain the food at the proper canning temperature. The food may be contaminated and then spoil.
- **DO NOT** use the microwave oven to sterilize objects (baby bottles, etc.). It is difficult to keep the oven at the high temperature needed for sterilization.
- **DO NOT** dry meats, herbs, fruits or vegetables in your oven. Small quantities of food or foods with low moisture content can dry out, scorch or catch on fire if overheated.

2) POPCORN

Popcorn may be popped in a microwave oven corn popper. Microwave popcorn that pops in its own package is also available. Follow popcorn manufacturers' directions and use a brand suitable for the cooking power of your microwave oven.

CAUTION: *When using pre-packaged microwave popcorn, you can follow recommended package instructions or use the Popcorn button (refer to page 10). Otherwise, the popcorn may not pop adequately or may ignite and cause a fire. Never leave the oven unattended when popping popcorn. Allow the popcorn bag to cool before opening, and always open the bag facing away from your face and body to prevent steam burns.*



Food Preparation (continued)

3) DEEP FAT FRYING

- **DO NOT** deep fat fry in your microwave oven. Cooking oils may burst into flames and may cause damage to the oven and may result in burns. Microwave utensils may not withstand the temperature of the hot oil, and can shatter or melt.

4) FOODS WITH NONPOROUS SKINS

- **DO NOT COOK / REHEAT WHOLE EGGS, WITH OR WITHOUT THE SHELL.**

Steam buildup in whole eggs may cause them to explode, and possibly damage the oven or cause injury. Reheating SLICED hard-boiled eggs and cooking SCRAMBLED eggs is safe.

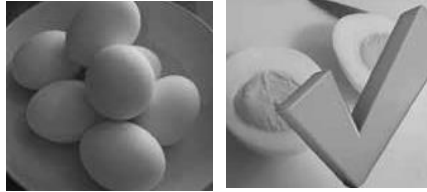

- **Potatoes, apples, whole squash and sausages** are examples of foods with nonporous skins. These types of foods must be pierced before microwave cooking to prevent them from exploding.

CAUTION: Cooking dry or old potatoes can cause fire.



5) GLASS TRAY / COOKING CONTAINERS / FOIL

- Cooking containers get hot during microwaving. Heat is transferred from the HOT food to the container and the Glass Tray. Use pot holders when removing containers from the oven or when removing lids or plastic wrap covers from cooking containers, to avoid burns.
- The Glass Tray will get hot during cooking. It should be allowed to cool before handling or before paper products, such as paper plates or microwave popcorn bags, are placed in the oven for microwave cooking.
- When using foil in the oven, allow at least 1-inch (2.5 cm) of space between foil and interior oven walls or door.
- Dishes with metallic trim should not be used, as arcing may occur.

6) PAPER TOWELS / CLOTHS

- **DO NOT** use paper towels or cloths that contain a synthetic fiber woven into them. The synthetic fiber may cause the towel to ignite. Use paper toweling under supervision.

7) BROWNING DISHES / OVEN COOKING BAGS

- Only use browning dishes that are designed for microwave cooking. Check browning dish information for instructions/heating chart. **DO NOT** preheat browning dish more than six minutes.
- If an oven cooking bag is used for microwave cooking, prepare according to package directions. **DO NOT** use a wire twist-tie to close bag. Instead use plastic ties, cotton string or a strip cut from the open end of the bag.



8) THERMOMETERS

- **DO NOT** use a conventional meat thermometer in your oven. Arcing may occur. Microwave safe thermometers are available for both meat and candy.



9) BABY FORMULA / BABY FOOD

- **DO NOT** heat baby formula or baby food in the microwave oven. The glass jar or surface of the food may appear warm while the interior can be so hot as to burn the infant's mouth and esophagus.



10) REHEATING PASTRY PRODUCTS

- When reheating pastry products, check temperatures of any fillings before eating. Some foods have fillings, which heat faster and can be extremely hot, while the surface remains warm to the touch (for example, jelly donuts).

11) GENERAL OVEN USAGE GUIDELINES

- **DO NOT** use the oven for any purpose other than the preparation of food.

Cookware Guide

This section answers the question, "Can I use in the Microwave?"

Aluminum Foil

It is not recommended to use. Arcing can occur if foil is too close to oven wall or door and cause damage to your oven.



Browning Dish

Yes. Only use browning dishes that are designed for microwave cooking. Check browning dish information for instructions/heating chart. Do not preheat for more than six minutes.

Brown Paper Bags

No. They may cause a fire in the oven.



Microwave Safe

Yes. If labeled Microwave Safe, check manufacturers' directions for use in microwave heating. Some dinnerware may state on the back of the dish, "Oven-MicrowaveSafe".



Dinnerware

If unlabeled, use **CONTAINER TEST** below.

Disposable Polyester Paperboard Dishes

Yes. Some frozen foods are packaged in these dishes. Also can be purchased in some grocery stores.



Fast Food Cartons with Metal Handle

No. Metal handle may cause arcing.



Frozen Dinner Trays

If made for the microwave, then yes. If it contains metal, then no.



Glass Jars

No. Most glass jars are not heat resistant.



Heat Resistant Oven Glassware/Ceramic

Yes, but only ones for microwave cooking and browning. (See **CONTAINER TEST** below.)



Metal Bakeware

No. Metal can cause arcing and damage to your oven.



Metal Twist-Ties

No. May cause arcing which could cause a fire in the oven.



Oven Cooking Bag

Yes. Follow manufacturers' directions. Close bag with the nylon tie provided, a strip cut from the end of the bag, or a piece of cotton string. Do not close with metal twist-tie. Make six 1/2-inch slits near the closure.

Paper Plates/Cups

Yes. Use to warm cooked foods, and to cook foods that require short cooking time, such as hot dogs. **Do not microwave paper cups; they may overheat and ignite.**



Towels & Napkins

Yes, only paper napkins/towels. Use to warm rolls and sandwiches, only if labeled safe for microwave use. Do NOT use recycled paper towels.



Parchment Paper

Yes. Use as a cover to prevent splattering.

Plastic Cookware

Yes, with caution. Should be labeled, "Suitable for Microwave Heating."



Check Microwave Safe manufacturers' directions for recommended uses. Some microwave safe plastic containers are not suitable for cooking foods with high fat or sugar content. The heat from hot food may cause warping.

Plastic, Melamine

No. This material absorbs microwave energy. Dishes get HOT!

Plastic Foam Cups

Yes, with caution. Plastic foam will melt if foods reach a high temperature. Use short term only to reheat foods to a low serving temperature. **Do not microwave paper cups; they may overheat and ignite.**



Plastic Wrap

Yes. Use to cover food during cooking to retain moisture and prevent splattering. Should be labeled "Suitable for Microwave Heating". Check package directions.



Straw, Wicker, Wood

Yes, short term only. Use only for short term reheating and to bring food to a low serving temperature. Wood may dry out, split or crack.



Thermometers

Only microwave safe thermometers can be used, NOT conventional thermometers.



Wax Paper

Yes. Use as a cover to prevent splattering and to retain moisture.



CONTAINER TEST

TO TEST A CONTAINER FOR SAFE MICROWAVE OVEN USE: Fill a microwave safe cup with cool water and place it in the microwave oven along side the empty container to be tested; **heat one (1) minute at P10 (HIGH)**. If the container is microwave oven safe (transparent to microwave energy), the empty container should remain comfortably cool and the water should be hot. If the container is hot, it has absorbed some microwave energy and should NOT be used. This test cannot be used for plastic containers.



Location of Controls

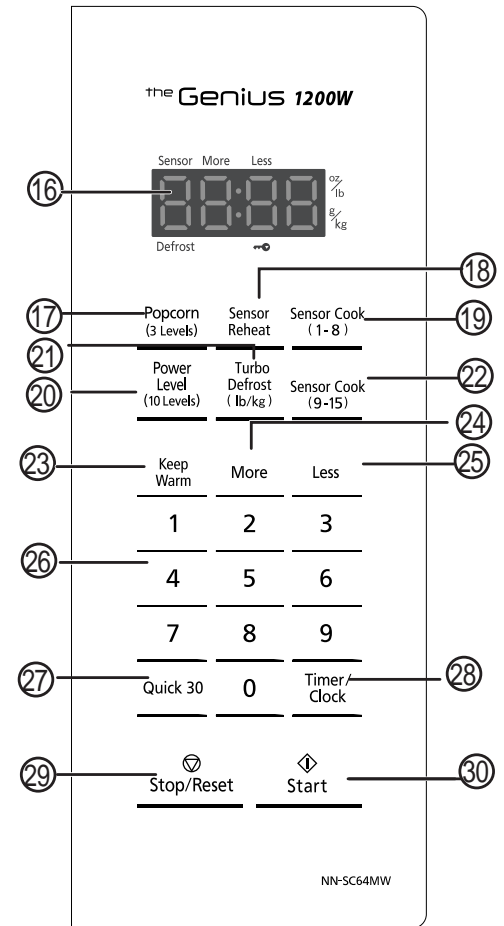
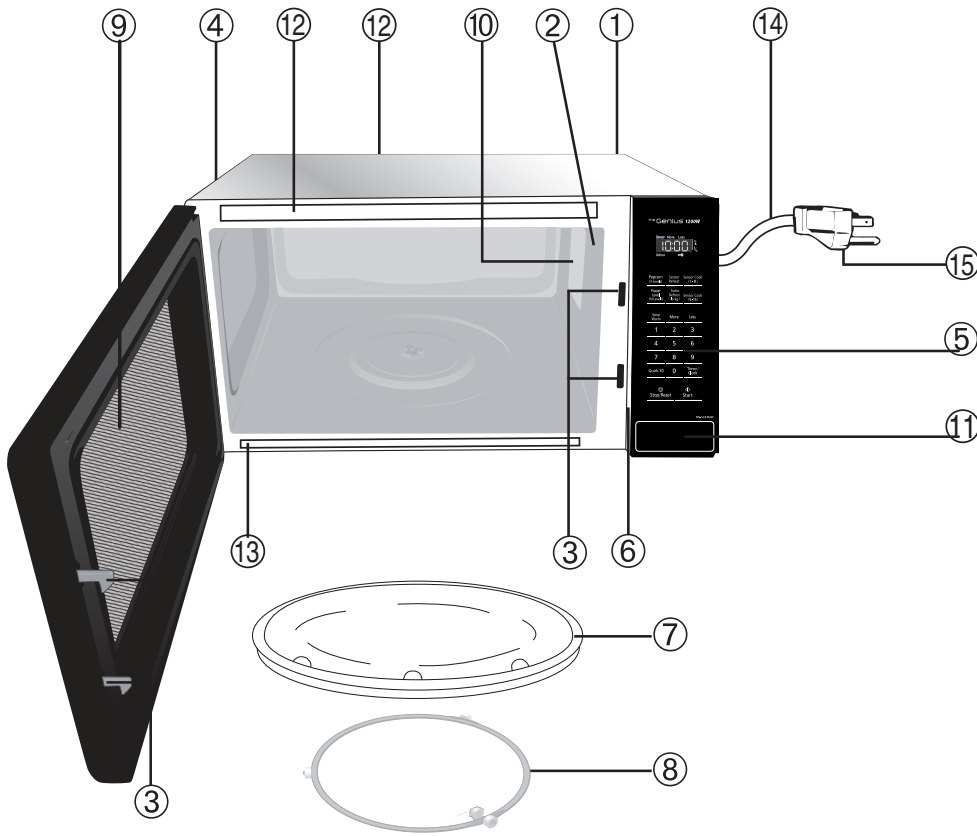

- 1 External Air Vent
- 2 Internal Air Vent
- 3 Door Safety Lock System
- 4 Exhaust Air Vent
- 5 Control Panel
- 6 Identification Plate
- 7 Glass Tray
- 8 Roller Ring
- 9 Heat/Vapor Barrier Film
(do not remove)
- 10 Waveguide Cover
(do not remove)
- 11 Door Release Button
- 12 Warning label
- 13 Menu label
- 14 Power Supply Cord
- 15 Power Supply Plug
- 16 Display Window
- 17 Popcorn Pad (See page 11)
- 18 Sensor Reheat Pad
(See page 13)
- 19 Sensor Cook Pad (See page 13)
- 20 Power level Pad (See page 9)
- 21 Turbo Defrost Pad
(See page 12)
- 22 Sensor Cook Pad (See page 13)
- 23 Keep Warm Pad (See page 10)
- 24 More Pad (See page 11)
- 25 Less Pad (See page 11)
- 26 Number Pads
- 27 Quick 30 Pad
- 28 Timer/Clock Pad
(See page 8 and 14)
- 29 Stop/Reset Pad
Before cooking: One tap clears all your instructions. During cooking: one tap temporarily stops the cooking process. Another tap cancels all your instructions, and time of day or colon appears in the display window.
- 30 Start Pad
After cooking program setting, one tap allows oven to begin functioning. If door is opened or

Stop/Reset Pad is pressed once during oven operation, Start Pad must be pressed again to restart oven.

Beep Sound:

When a pad is pressed correctly, a beep will be heard. If a pad is pressed and no beep is heard, the unit did not or cannot accept the instruction. When operating, the oven will beep twice between programmed stages. At the end of any complete program, the oven will beep 5 times.

NOTE:

If no operation after cooking program setting, 6 minutes later, the oven will automatically cancel the cooking program. The display will return to clock or colon display.

Operation

Using the Microwave for the First Time

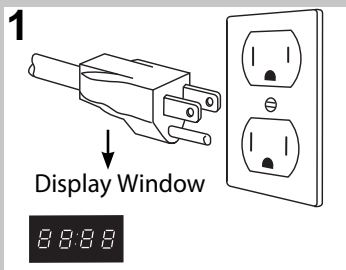

Plug into a properly grounded electrical outlet. The oven automatically defaults to the imperial measure system (oz/lb) with beep on mode.

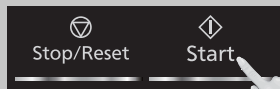
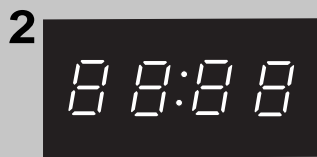

Press **Start** once to enter the weight system.

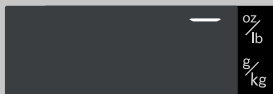
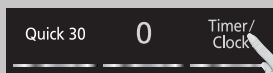

Press **Timer/Clock** to cycle between the weight system, Metric (g/kg) or Imperial (oz/lb).

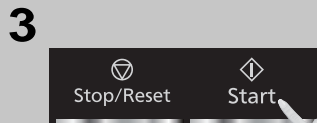

Press **Start** once again to access to the sound switch system. (If you press start twice after plug-in, you can skip the weight system and access the sound switch system.)



The screen will display **bEEP**.

4



Press **Timer/Clock** to cycle between the sound switch system. Beep On or Beep Off.

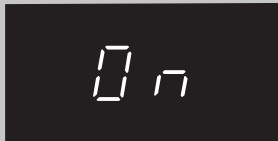

The default mode is Beep On. The screen will display On.

5

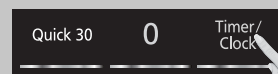

Press **Timer/Clock** once



The mode change to Beep off. The screen will display off.

Press **Timer/Clock** to cycle between the sound system, On or off.

6

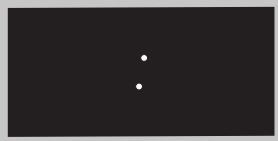

Press **Stop/Reset** to confirm; a colon (:) will appear in the display window.

NOTES:

1. These choices can be selected only when you plug-in the oven.
2. After beep setting, it will revert back to the metric weight measurement setting if start pad is pressed again.
3. Press **Stop/Reset** pad to exit.

Setting the Clock



With the oven NOT cooking, press **Timer/Clock** twice; the colon will blink. Enter time of day using the **Number** pads.



Press **Timer/Clock** to finish setting and the colon (:) will stop blinking.

NOTES:

1. To reset the clock, repeat steps.
2. The clock will retain the time of day as long as the oven is plugged in and electricity is supplied.
3. The clock is a 12-hour display.
4. Oven will not operate while colon (:) is flashing.

Setting the Child Safety Lock

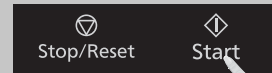

When the time of day appears in the display, press **Start** three times;

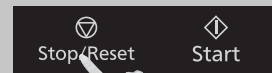
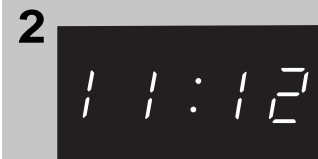

Press **Stop/Reset** three times; the display will return to the time of the day and Child Lock will be cancelled.

NOTES:

1. This feature prevents the electronic operation of the oven until cancelled. It does not lock the door.
2. To set or cancel child safety lock, Start or Stop/Reset pad must be pressed 3 times within 10 seconds.
3. You can set Child Lock feature when the display shows a colon or time of day.

Operation (continued)

Cooking

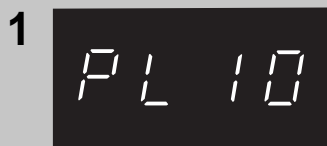

If cooking at high power (PL10), skip to step 2. Press **Power Level** until the desired power level appears in the display. PL10 is the highest and PL1 is the lowest.

Press	Power Level
once	PL10 (HIGH)
twice	PL9
3 times	PL8
4 times	PL7 (MED-HIGH)
5 times	PL6 (MEDIUM)
6 times	PL5
7 times	PL4
8 times	PL3 (MED-LOW)/ DEFROST
9 times	PL2
10 times	PL1 (LOW)

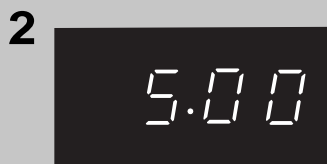

Set Cooking Time using the **Number** pads. PL10 (HIGH) has max. cooking time of 30 minutes. For other power levels, the max. time is 99 minutes, 99 seconds.



Press **Start**; the cooking will start and the time will count down in the display. At the end of cooking, five beeps will sound.

NOTES:

1. For reheating, use PL10 (HIGH) for liquids, PL7 (MED-HIGH) for most foods, and PL6 (MEDIUM) for dense foods.
2. For defrosting, use PL3 (MED-LOW).

DO NOT OVERCOOK: This oven requires less time to cook than older units. Overcooking will cause food to dry out and may cause a fire. A microwave oven's cooking power tells you the amount of microwave power available for cooking.

Stage Cooking:

For more than one stage of cooking, repeat steps 1 and 2 for each stage of cooking before pressing **Start**. The maximum number of stages for cooking is three. When operating, two beeps will sound between each stage. Five beeps will sound at the end of the entire sequence.

Note: After running the oven at PL10 power continuously for 30 min, if the cook process is not complete, the oven will automatically adjust to PL8 power to protect the microwave and complete the cook cycle.

If you want to cook again at PL10 power, you will need to wait 15 min before restarting.

Setting a Standing Time

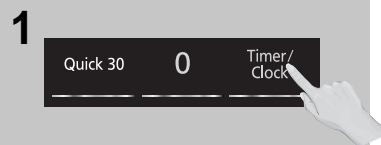

Some recipes call for a standing time after cooking. To do this, repeat steps 1 and 2 in the **Cooking** section on previous page. Then press **Timer/Clock**.

Note: Do not skip step 1, even use high power PL10.

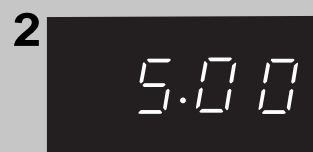

Set desired amount of stand time using **Number** pads (up to 99 minutes, 99 seconds).

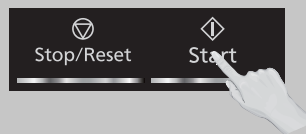
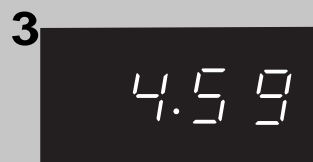

Press **Start**. The timer will start and then beep twice at the end of cooking time (the beginning of standing time). Five beeps will sound when standing time is done.

Continued on the Next Page

Operation (continued)

Setting a Delayed Start

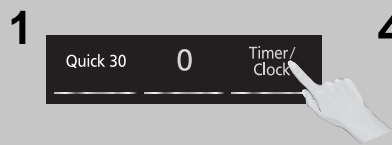

The start time can be delayed to start cooking at a later time. To do this, first press **Timer/Clock**.

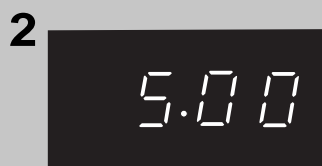

Enter the desired delay time (up to 99 minutes, 99 seconds) using the **Number** pads.

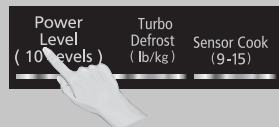
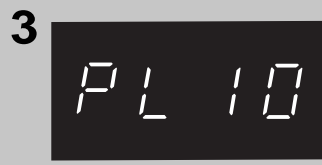

Press **Power Level** until the desired power level appears in the display. PL10 is the highest and PL1 is the lowest.

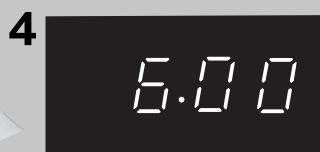

Set Cooking Time using the **Number** pads (see previous page for maximum times).

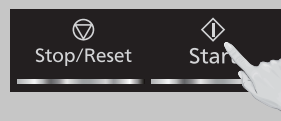
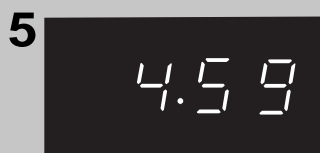

Press **Start**; the delay time will count down, then cooking will begin. At the end of cooking, five beeps will sound.

NOTES:

1. When each stage finishes, the oven will beep twice. At the end of the program, the oven will beep five times.
2. If the oven door is opened during Stand Time, Kitchen Timer or Delay Time, the time on the display will continue to count down.
3. Stand Time and Delay start cannot be programmed before any automatic function. This is to prevent the starting temperature of food from rising.

Quick 30

(Set or add cooking time in 30 seconds increments)



Press **Quick 30** until the desired cooking time (up to 5 minutes) appears in the display. Power Level is pre-set at PL10.



Press **Start**; the cooking will start and the time will count down in the display. At the end of cooking, five beeps will sound.

NOTES:

1. If desired, you can use other power levels. Select desired power level before pressing **Quick 30**.
2. After setting the time by Quick 30 pad, you cannot use the Number Pads.
3. Quick 30 pad can also be used to add more time during manual cooking.

Keep Warm

(Will keep food warm for up to 30 minutes after cooking)



Press **Keep Warm**.

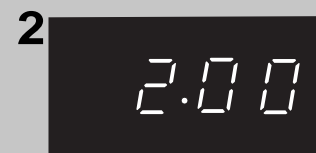

Set warming time using **Number** pads, up to 30 minutes. This example shows two minutes. At the end of warming, five beeps will sound.

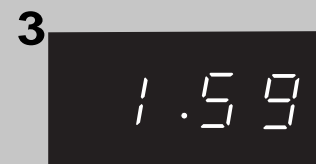

Press **Start**; the cooking will start and the time will count down in the display. At the end of cooking, five beeps will sound.

NOTES:

Keep Warm can be set as the final stage after cook time has been manually entered. It cannot be used with sensor or auto features.

Popcorn

(Example: To pop 3.5 oz (100 g). of popcorn)

1



Press **Popcorn** until the desired size appears in the display. Once for 3.5 oz (100g), twice for 3.0 oz (85 g), or three times for 1.75 oz (50 g).

2

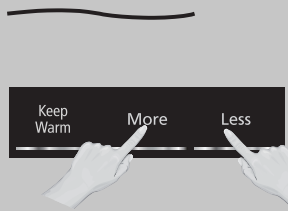
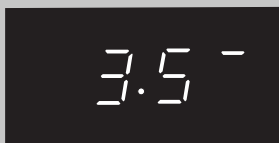

If desired, press **More** once to add 10 seconds or twice to add 20 seconds. Press **Less** once to subtract 10 seconds or twice to subtract 20 seconds.

3

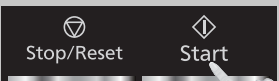

Press **Start**; the cooking will start and the time will count down in the display. At the end of cooking, five beeps will sound.

NOTES:

1. Pop one bag at a time.
2. Place bag in oven according to manufacturers' directions.
3. Start with popcorn at room temperature.
4. Allow popped corn to sit unopened for a few minutes.
5. Open bag carefully to prevent burns, because steam will escape.
6. Do not reheat unpopped kernels or reuse bag.
7. If popcorn is of a different weight than listed, follow instructions on popcorn package.
8. **Never leave the oven unattended.**
9. **If popping slows to 2 to 3 seconds between pops, stop oven. Overcooking can burn popcorn or cause fire.**
10. When popping multiple bags one right after the other, the cooking time may vary slightly. This does not affect the popcorn results.

Operation (continued)

Turbo Defrost

1



This feature allows you to defrost foods such as meat, poultry and seafood, simply by entering the weight. Press **Turbo Defrost**.

2



“dEF” will appear briefly in the display, then a dash will appear next to the weight units. Enter weight of the food using the **Number** pads.

3

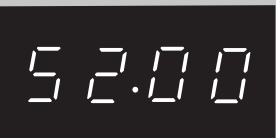

Press **Start**. Defrosting will start. Larger weight foods will cause a signal midway through defrosting. If two beeps sound, turn over and/or rearrange foods.

NOTE:

The maximum weight for Auto Defrost is 6 lbs. (2.7 kg).

Conversion

Follow the chart to convert ounces or hundredths of a pound into tenths of a pound. To use Auto Defrost, enter the weight of the food in pounds (1.0) and tenths of a pound (0.1). If a piece of meat weighs 1.95 lbs or 1 lb 14 oz, enter 1.9 lbs.

Ounces	Hundredths of a Pound	Tenths of a Pound
0	.01 - .05	0.0
1 - 2	.06 - .15	0.1
3 - 4	.16 - .25	0.2
5	.26 - .35	0.3
6 - 7	.36 - .45	0.4
8	.46 - .55	0.5
9 - 10	.56 - .65	0.6
11 - 12	.66 - .75	0.7
13	.76 - .85	0.8
14 - 15	.86 - .95	0.9

Defrosting Tips & Techniques

Preparation For Freezing:

1. Freeze meats, poultry, and fish in packages with only one or two layers of food. Place wax paper between layers.
2. Package in heavy-duty plastic wraps, bags (labeled “For Freezer”), or freezer paper.
3. Remove as much air as possible.
4. Seal securely, date, and label.

5. Drain liquids during defrosting.
6. Turn over (invert) items during defrosting.

After Defrosting:

1. Large items may be icy in the center. Defrosting will complete during Standing Time.
 2. Let stand, covered, following stand time directions on page 9.
 3. Rinse foods indicated in the chart.
 4. Items which have been layered should be rinsed separately or have a longer stand time.
- To Defrost:**
1. Remove wrapper. This helps moisture to evaporate. Juices from food can get hot and cook the food.
 2. Set food in microwave safe dish.
 3. Place roasts fat-side down. Place whole poultry breast-side down.
 4. Select power and minimum time so that items will be under-defrosted.

FOOD	DEFROST TIME at P3 mins (per lb)	DURING DEFROSTING	AFTER DEFROSTING	
			Stand Time	Rinse
Fish and Seafood				
Crabmeat [up to 3 lbs. (1.4 kg)]	6	Break apart/Rearrange	5 min.	YES
Fish Steaks	4 to 6	Turn over		
Fish Fillets	4 to 6	Turn over/Rearrange		
Sea Scallops	4 to 6	Break apart/Remove defrosted pieces		
Whole fish	4 to 6	Turn over		
Meat				
Ground Meat	4 to 5	Turn over/Remove defrosted portion	10 min.	NO
Roasts [2½-4 lbs. (1.1-1.8 kg)]	4 to 8	Turn over	30 min. in fridge.	
Chops/Steak	6 to 8	Turn over/Rearrange	5 min.	
Ribs/T-bone	6 to 8	Turn over/Rearrange		
Stew Meat	4 to 8	Break apart/Remove defrosted pieces		
Liver (thinly sliced)	4 to 6	Drain liquid/Turn over/Separate pieces		
Bacon (sliced)	4	Turn over	---	
Poultry				
Chicken, Whole [up to 3 lbs. (1.4 kg)]	4 to 6	Turn over	20 min. in fridge.	YES
Cutlets	4 to 6	Break apart/Turn over/Remove defrosted Pieces	5 min.	
Pieces	4 to 6	Break apart/Turn over	10 min.	
Cornish hens	6 to 8	Turn over		
Turkey Breast [5-6 lbs. (2.3-2.7 kg)]	6	Turn over	20 min. in fridge.	

Sensor Reheat

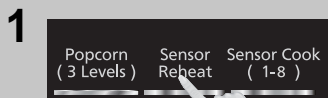

Press **Sensor Reheat**.



If desired, press **More** to add 20% more time than suggested. Press **Less** to subtract 20% cooking time.

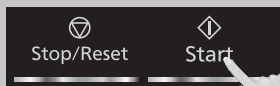

Press **Start**. Reheating is complete when five beeps sound.

NOTES:

1. After having used the Sensor Reheat feature a few times, you may decide you would prefer your food cooked to a different doneness – that is why you would utilize the More/Less pads.
2. When steam is detected by the Sensor and two beeps sound, the remaining cooking time will appear in the display.

Casseroles: Add three to four tablespoons of liquid, cover with lid or vented plastic wrap. Stir when time appears in the display window.

Canned foods: Empty contents into casserole dish or serving bowl, cover dish with lid or vented plastic wrap. After reheating, let stand for a few minutes.

Plate of food: Arrange food on plate; top with butter, gravy, etc. Cover with lid or vented plastic wrap. After reheating, let stand for a few minutes.

DO NOT USE SENSOR REHEAT:

1. To reheat bread and pastry products. Use manual power and time for these foods.
2. For raw or uncooked foods.
3. If oven cavity is warm.
4. For beverages.
5. For frozen foods.

Sensor Cook



Press **Sensor Cook** until the number corresponding to the desired food appears in the display (*see chart on the next page*).



If desired, press **More** to add 20% more time than suggested. Press **Less** to subtract 20% cooking time.

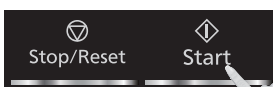

Press **Start**. Cooking is complete when five beeps sound.

NOTES:

1. After having used the Sensor Cook feature a few times, you may decide you would prefer your food cooked to a different doneness – that is why you would utilize the More/Less pads.
2. When steam is detected by the Sensor and two beeps sound, the remaining cooking time will appear in the display.
3. Automatic features are provided for your convenience. If results are not suitable to your individual preference, or if serving size is other than what is listed on page 13, please refer to manual cooking on page 9.

For the best results with the SENSOR, follow these recommendations:

BEFORE Reheating/Cooking:

1. The room temperature surrounding the oven should be below 95° F (35° C).
2. Food weight should exceed 4 oz. (110 g).
3. Be sure the glass tray, the outside of the cooking containers and the inside of the microwave oven are dry before placing food in the oven. Residual beads of moisture turning into steam can mislead the sensor.
4. Cover food with lid, or with vented plastic wrap. Never use tightly sealed plastic containers—they can prevent steam from escaping and cause food to overcook.

DURING Reheating/Cooking:

DO NOT open the oven door until two beeps sound and cooking time appears in the display. Doing so will cause inaccurate cooking since the steam from food is no longer contained within the oven cavity. Once the cooking time begins to count down, the oven door may be opened to stir, turn or rearrange foods.

AFTER Reheating/Cooking:

All foods should have a standing time.

Operation (continued)

Sensor Cook Chart (1 - 8)

See the chart below for Sensor Cook categories.

Recipe	Serving/Weight	Hints
1. Potato	1 - 4 potatoes (6 - 8 oz. each) (170 - 220 g)	Pierce each potato with a fork 6 times spacing around surface. Place potato or potatoes around the edge of paper-towel-lined glass tray (Turntable), at least 1 inch (2.5 cm) apart. Do not cover. Turn over after 2 beeps. Let stand 5 minutes to complete cooking.
2. Fresh Vegetables	4 - 16 oz. (110 - 450 g)	All pieces should be the same size. Wash thoroughly, add 1 tbsp. of water per ½ cup of vegetables, and cover with lid or vented plastic wrap. Do not salt/butter until after cooking. After 2 beeps, stir or rearrange. Re-cover and press Start .
3. Frozen Vegetables	8 - 16 oz. (220 - 450 g)	Wash thoroughly, add 1 tbsp. of water per ½ cup of vegetables, and cover with lid or vented plastic wrap. Do not salt/butter until after cooking. (Not suitable for vegetables in butter or sauce.) After 2 beeps, stir or rearrange. Re-cover and press Start .
4. Frozen Pizza (single)	6-12 oz. (170-340 g)	Follow manufacturers' directions for preparation. Add more time of cooking if needed.
5. Frozen Entrées	6 - 32 oz. (170 - 900 g)	Follow manufacturers' directions for preparation. After 2 beeps, stir or rearrange. Be careful when removing the film cover after cooking. Remove facing away from you to avoid steam burns. If additional time is needed, continue to cook manually.
6. Casserole	16 - 32 oz (450 - 900 g)	Use appropriate amount of liquid. Cover with lid. After cooking, stand for 5 minutes. (See page 16 for casserole recipes.)
7. Fish Fillet	4 - 16 oz (110 - 450g)	Arrange in a single layer. Cover with lid or vented plastic wrap.
8. Frozen Lasagna	6 - 32 oz (170 - 900 g)	Follow manufacturers' directions for preparation. After cooking, let stand for 2minutes. Be careful when removing the film cover after cooking. Remove facing away from you to avoid steam burns. If additional time is needed, continue to cook manually.

Operation (continued)

Sensor Cook Chart (9 - 15)

See the chart below for Sensor Cook categories.

9. Pasta	1.75 - 5.5 oz. (50 - 155 g)	Place 1.75 oz.(50 g) pasta with 3 cups (750 ml) hot tap water in a 2 qt microwave safe casserole, salt and oil, if desired, covered with lid or vented plastic wrap. For 4 oz.(110 g) pasta use 4 cups (1000 ml)hot tap water, for 5.5 oz.(155 g) pasta use 6 cups (1500 ml) hot tap water in 3 qt casserole.
10. Stew	4 - 6 Serv.	In a 3 qt casserole dish, crumble 1 pound(450 g) lean ground beef and stir in 2 medium onions (chopped), 1/4 teaspoon dried garlic pieces. Cover with plastic wrap and cook on P10 for 6 minutes. Stir after cooking. Drain. Add 16 oz.(450 g) pinto or red kidney beans, 15 oz.(430 g) stewed tomatoes (chopped), 15 oz.(430 g) tomato sauce, 1 teaspoon salt and 2 to 3 tablespoons chili powder. Cover with lid. Cook with the " 10.Stew" sensor cook. After 2 beeps, stir. Re-cover and press Start . Stir after cooking. Cover again and let stand 7 minutes before serving.
11. Oatmeal	0.5 - 1 cup (40 - 80 g)	Place inside a microwave safe serving bowl with no cover. Follow manufacturers' directions for preparation.
12. Soup	250 - 500 ml (1 - 2 cups)	Pour soup into a microwave safe serving bowl. Cover with vented plastic wrap. Stir after cooking.
13. Omelet	2 - 4 eggs	Follow Basic Omelet recipe on page 16.
14. White Rice	0.5 - 1.5 cups	Place rice with hot tap water in a microwave safe casserole dish. Cover with lid or vented plastic wrap. Let stand 5 to 10 minutes before serving. Add 1 1/2 parts water to 1 part rice.
15. Brown Rice	0.5 - 1.5 cups	Place rice with hot tap water in a microwave safe casserole dish. Cover with lid or vented plastic wrap. Let stand 5 to 10 minutes before serving. Add 2 parts water to 1 part rice.

Setting the Timer



This feature allows you to program the oven as a kitchen timer. Press **Timer /Clock** once.

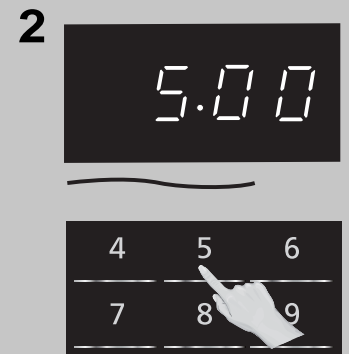

Set desired amount of time using **Number** pads (up to 99 minutes, 99 seconds).



Press **Start**. The timer will count down without cooking and beep five times when done.

Caution: If oven lamp is lit while using the timer feature, the oven is **NOT** set properly; **STOP OVEN IMMEDIATELY** and re-read instructions.

MICROWAVE RECIPES

OMELET

Basic Omelet Recipe

Yield: 1 Serving

1 tablespoon butter or margarine

2 eggs

2 tablespoons milk

Salt and ground black pepper, if desired Heat butter in a microwave safe 8-inch round dish, 20 seconds at PL10, or until melted.

Turn the dish to coat the bottom with butter.

Meanwhile, combine the remaining ingredients in a separate bowl, beat together and pour into the dish. Cook, covered with vented plastic wrap, cook 2 minutes at PL10. Let stand 2 minutes. With a spatula, loosen the edges of the omelet from the dish, fold into thirds to serve. **Always beat the eggs before making the omelet.**

NOTE: Double ingredients for a 4-egg Omelet.

MACARONI AND CHEESE

Yield: 4 - 6 servings

2 1/2 tablespoons butter

1 1/2 tablespoons chopped onion

1/2 clove minced garlic

4 tablespoons all-purpose flour

2/3 teaspoon dry mustard

2/3 teaspoon salt

1/8 teaspoon ground black pepper

1 1/2 cups milk

1 1/2 cups grated cheddar cheese

140 g (5 oz.) (dry weight) macaroni, cooked and drained

3 tablespoons bread crumbs

2/3 teaspoon paprika

In a 3qt. casserole dish, melt the butter for 40 seconds at PL10, with cover with lid or vented plastic wrap. Add onion and garlic, cover the casserole dish with lid or vented plastic wrap, and cook for 1 minute at PL10. Stir in flour, mustard, salt and pepper, and gradually add the milk. Cover the casserole dish with lid or vented plastic wrap and cook for 3-4 minutes at PL10 until sauce thickens, stirring once.

Add the cheddar cheese and the macaroni into the sauce and stir well.

Sprinkle the bread crumbs and paprika on the top of the dish.

Cover with lid or vented plastic wrap.

Cook with the "6. Casserole" Sensor Cook.

BEEF AND MACARONI CASSEROLE

Yield: 4 - 6 servings

220 g (1/2 pound) lean ground beef

1/2 small onion, chopped

1/4 green bell pepper, chopped

1/2 cup chopped celery

1 (430 g/15 oz.) can tomato sauce

2/3 cup water

1/2 cup uncooked elbow macaroni

1/2 teaspoon parsley

1/4 teaspoon salt

1/8 teaspoon ground black pepper

1/4 cup grated cheddar cheese

Crumble the ground beef in a 3qt. casserole dish. Cook for 5-7 minutes at PL6 or until the meat is cooked, stirring twice. Stir in onion, peppers and celery. Cook for 3-4 minutes at PL10. Stir in the remaining ingredients, except cheese. Cover with lid or vented plastic wrap.

Cook with the "6. Casserole" Sensor Cook. Sprinkle with cheese. Cover and let stand 5 minutes.

Food Characteristics

Food Characteristics

Bone and Fat

Both bone and fat affect cooking. Bones may cause irregular cooking. Meat next to the tips of bones may overcook while meat positioned under a large bone, such as a ham bone, may be undercooked. Large amounts of fat absorb microwave energy and the meat next to these areas may overcook.



Density

Porous, airy foods such as breads, cakes or rolls take less time to cook than heavy, dense foods such as potatoes and roasts. When reheating donuts or other foods with different centers be very careful. Certain foods have centers made with sugar, water, or fat and these centers attract microwaves (for example, jelly donuts). When a jelly donut is heated, the jelly can become extremely hot while the exterior remains warm to the touch. This could result in a burn if the food is not allowed to cool properly in the center.



Quantity

Two potatoes take longer to cook than one potato. As the quantity of the food decreases so does the cooking time. Overcooking will cause the moisture content in the food to decrease and a fire could result. Never leave microwave unattended while in use.



Shape

Uniform sizes heat more evenly. The thin end of a drumstick will cook more quickly than the meaty end. To compensate for irregular shapes, place thin parts toward the center of the dish and thick pieces toward the edge.



Size

Thin pieces cook more quickly than thick pieces.



Starting Temperature

Foods that are at room temperature take less time to cook than if they are chilled, refrigerated or frozen.



Cooking Techniques

Piercing

Foods with skins or membranes must be pierced, scored or have a strip of skin peeled before cooking to allow steam to escape. Pierce clams, oysters, chicken livers, whole potatoes and whole vegetables. Whole apples or new potatoes should have a 1-inch strip of skin peeled before cooking. Score sausages and frankfurters. Do not Cook/Reheat whole eggs, with or without the shell. Steam buildup in whole eggs may cause them to explode, and possibly damage the oven or cause injury. Reheating SLICED hard-boiled eggs and cooking SCRAMBLED eggs is safe.

Browning

Foods will not have the same brown appearance as conventionally cooked foods or those foods which are cooked utilizing a browning feature. Meats and poultry may be coated with browning sauce, Worcestershire sauce, barbecue sauce or shake-on browning sauce. To use, combine browning sauce with melted butter or margarine and brush on before cooking. For quick breads or muffins, brown sugar can be used in the recipe in place of granulated sugar, or the surface can be sprinkled with dark spices before cooking.

Spacing

Individual foods, such as baked potatoes, cupcakes and appetizers, will cook more evenly if placed in the oven equal distances apart. When possible, arrange foods in a circular pattern.

Covering

As with conventional cooking, moisture evaporates during microwave cooking. Casserole lids or plastic wrap are used for a tighter seal. When using plastic wrap, vent the plastic wrap by folding back part of the plastic wrap from the edge of the dish to allow steam to escape. Loosen or remove plastic wrap as recipe directs for stand time. When removing plastic wrap covers, as well as any glass lids, be careful to remove them away from you to avoid steam burns. Various degrees of moisture retention are also obtained by using wax paper or paper towels.

Cooking Time

Cooking times will vary because of food shape variations, starting temperature, and regional preferences. Always cook food for the minimum cooking time given in a recipe and check for doneness. If the food is undercooked, continue cooking. It is easier to add time to an undercooked product. Once the food is overcooked, nothing can be done.

Stirring

Stirring is usually necessary during microwave cooking. Always bring the cooked outside edges toward the center and the less cooked center portions toward the outside of the dish.

Rearranging

Rearrange small items such as chicken pieces, shrimp, hamburger patties or pork chops. Rearrange pieces from the edge to the center and pieces from the center to the edge of the dish.

Turning

It is not possible to stir some foods to distribute the heat evenly. At times, microwave energy will concentrate in one area of the food. To help ensure even cooking, these foods need to be turned. Turn over large foods, such as roasts or turkeys, halfway through cooking.

Standing Time

Most foods will continue to cook by conduction after the microwave oven is turned off. After cooking meat, the internal temperature will rise 5 °F to 15 °F (3 °C to 8 °C), if allowed to stand, tented with foil, for 10 to 15 minutes. Casseroles and vegetables need a shorter amount of standing time, but this standing time is necessary to allow foods to complete cooking to the center without overcooking on the edges.

Test for Doneness

The same tests for doneness used in conventional cooking may be used for microwave cooking. Meat is done when fork-tender or splits at fibers. Chicken is done when juices are clear yellow and drumstick moves freely. Fish is done when it flakes and is opaque. Cake is done when a toothpick or cake tester is inserted and comes out clean.

Check foods to see that they are cooked to the United States Department of Agriculture's recommended temperatures.

To test for doneness, insert a meat thermometer in a thick or dense area away from fat or bone. NEVER leave the thermometer in the food during cooking, unless it is approved for microwave oven use.

Temp	Food
160 °F	For fresh pork, ground meat, boneless white poultry, fish, seafood, egg dishes and frozen prepared food.
165 °F	For leftover, ready-to-reheat refrigerated, and deli and carryout "fresh" food.
170 °F	For white meat poultry.
180 °F	For dark meat poultry.

Care and Cleaning of Your Microwave Oven

Please see below and the following page for particular cleaning instructions for each section of the oven.

BEFORE CLEANING: Unplug oven at wall outlet. If outlet is inaccessible, leave oven door open while cleaning.

AFTER CLEANING: Be sure to place the Roller Ring and the Glass Tray in the proper position and press Stop/Reset Button to clear the Display.

- 1. Outside oven surfaces:** Clean with a damp cloth. To prevent damage to the operating parts inside the oven, water should not be allowed to seep into ventilation openings.
- 2. Label:** Do not remove. Wipe with a damp cloth.
- 3. Inside the Oven:** Wipe with a damp cloth after using. Mild detergent may be used if needed. Do not use harsh detergents or abrasives.
- 4. Oven Door:** Wipe with a soft dry cloth when steam accumulates inside or around the outside of the oven door. During cooking, especially under high humidity conditions, steam is given off from the food. (Some steam will condense on cooler surfaces, such as the oven door. This is normal.) Inside surface is covered with a heat and vapor barrier film. **Do not remove.**
- 5. Oven Cavity Floor:** Clean the bottom surface of the oven with mild detergent, water or window cleaner, and dry.
- 6. Wave Guide Cover:** Do not remove Wave Guide Cover. **It is important to keep cover clean in the same manner as the inside of the oven.**
- 7. Control Panel:** The Control Panel is covered with a removable protective film to prevent scratches during shipping. Small bubbles may appear under this film, so if this is the case, remove by applying masking or clear tape to an exposed corner and pull gently. If the Control Panel becomes wet, clean it with a soft dry cloth. Do not use harsh detergents or abrasives.
- 8. Glass Tray:** Remove and wash in warm soapy water or in a dishwasher.
- 9. Roller Ring:** Roller Ring may be washed in mild soapy water or dishwasher. These areas should be kept clean to avoid excessive noise.

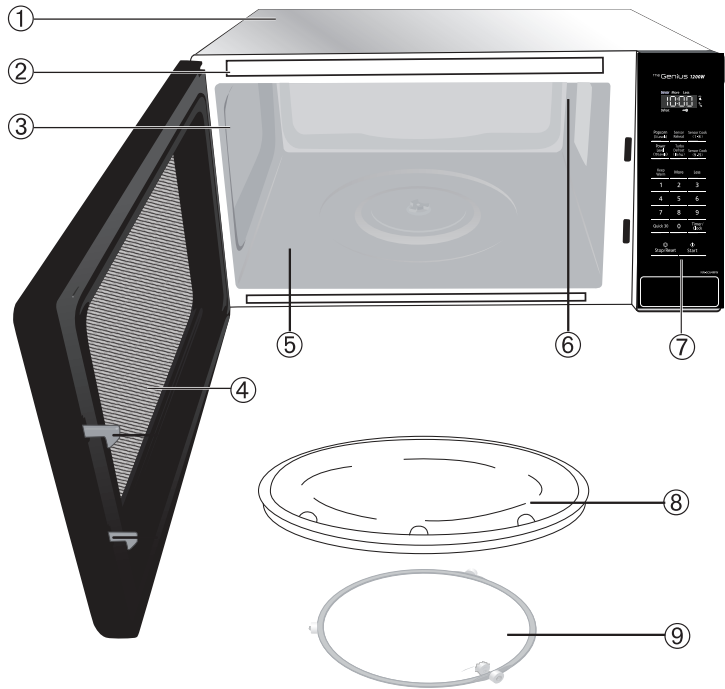

IT IS IMPORTANT TO KEEP THE OVEN CLEAN AND DRY. FOOD RESIDUE AND CONDENSATION MAY CAUSE RUSTING OR ARCING AND DAMAGE TO THE OVEN. AFTER USE, WIPE DRY ALL SURFACES, INCLUDING VENT OPENINGS, OVEN SEAMS, AND UNDER GLASS TRAY.

Shop Accessories

Purchase Parts, Accessories and Instruction Books online for all Panasonic Products by visiting our Web Site at:

<http://www.panasonic.ca/english/support>

Parts Available to Order:

Instructions/Operating Manual (this book)	16170000A86730
Glass Tray	12570000008334
Roller Ring Assembly	12170000004310

Before Requesting Service

See below before calling for service, as most problems can easily be remedied by following these simple solutions:

<p>The oven causes TV interference.</p>	<p>Some radio and TV interference might occur when you cook with the microwave oven. This interference is similar to the interference caused by small appliances such as mixers, vacuums, blow dryers, etc. It does not indicate a problem with your oven.</p>
<p>Steam accumulates on oven door and warm air comes from the oven vents.</p>	<p>During cooking, steam and warm air are given off from the food. Most of the steam and warm air are removed from the oven by the air which circulates in the oven cavity. However, some steam will condense on cooler surfaces such as the oven door. This is normal. After use, the oven should be wiped dry (see page 15).</p>
<p>Oven will not turn on.</p>	<p>The oven is not plugged in securely or needs to be reset; remove plug from outlet, wait ten seconds and re-insert. Main circuit breaker or main fuse is tripped; reset main circuit breaker or replace main fuse. There is a problem with the outlet; plug another appliance into the outlet to check if it is working.</p>
<p>Oven will not start cooking.</p>	<p>The door is not completely closed; close the oven door securely. Start was not pressed after programming; press Start. Another program is already entered into the oven; press Stop/Reset to cancel the previous program and enter new program. The program is not correct; program again according to the Operating Instructions. Stop/Reset has been pressed accidentally; program oven again.</p>
<p>The Glass Tray wobbles.</p>	<p>The Glass Tray is not positioned properly on the Roller Ring or there is food under the Roller Ring; take out Glass Tray and Roller Ring. Wipe with a damp cloth and reset Roller Ring and Glass Tray properly.</p>
<p>When the oven is operating, there is noise coming from the Glass Tray.</p>	<p>The Roller Ring and oven bottom are dirty; clean these parts according to Care and Cleaning of Your Microwave Oven (see page 15).</p>
<p>"" appears in the display.</p>	<p>The CHILD SAFETY LOCK was activated by pressing Start three times; Deactivate CHILD SAFETY LOCK by pressing Stop/Reset three times.</p>

Limited Warranty (Only for Canada)

Panasonic Canada Inc.

5770 Ambler Drive, Mississauga, Ontario L4W 2T3

PANASONIC PRODUCT – LIMITED WARRANTY

Panasonic Canada Inc. warrants this product to be free from defects in material and workmanship under normal use and for a period as stated below from the date of original purchase agrees to, at its option either (a) repair your product with new or refurbished parts, (b) replace it with a new or a refurbished equivalent value product, or (c) refund your purchase price. The decision to repair, replace or refund will be made by Panasonic Canada Inc.

Category	Service type	Parts	Labour	Magnetron
Counter top microwave oven	Carry-in	1 Year	1 Year	Additional 4 Years (Part only)

This warranty is given only to the original purchaser, or the person for whom it was purchased as a gift, of a Panasonic brand product mentioned above sold by an authorized Panasonic dealer in Canada and purchased and used in Canada, which product was not sold “as is”, and which product was delivered to you in new condition in the original packaging.

IN ORDER TO BE ELIGIBLE TO RECEIVE WARRANTY SERVICE HEREUNDER, A PURCHASE RECEIPT OR OTHER PROOF OF DATE OF ORIGINAL PURCHASE, SHOWING AMOUNT PAID AND PLACE OF PURCHASE IS REQUIRED

LIMITATIONS AND EXCLUSIONS

This warranty ONLY COVERS failures due to defects in materials or workmanship, and DOES NOT COVER normal wear and tear or cosmetic damage. The warranty ALSO DOES NOT COVER damages which occurred in shipment, or failures which are caused by products not supplied by Panasonic Canada Inc., or failures which result from accidents, misuse, abuse, neglect, mishandling, misapplication, alteration, faulty installation, set-up adjustments, misadjustment of consumer controls, improper maintenance, power line surge, lightning damage, modification, introduction of sand, humidity or liquids, commercial use such as hotel, office, restaurant, or other business or rental use of the product, or service by anyone other than a Authorized Servicer, or damage that is attributable to acts of God.

THIS EXPRESS, LIMITED WARRANTY IS IN LIEU OF ALL OTHER WARRANTIES, EXPRESS OR IMPLIED, INCLUDING ANY IMPLIED WARRANTIES OF MERCHANTABILITY AND FITNESS FOR A PARTICULAR PURPOSE. IN NO EVENT WILL PANASONIC CANADA INC. BE LIABLE FOR ANY SPECIAL, INDIRECT OR CONSEQUENTIAL DAMAGES RESULTING FROM THE USE OF THIS PRODUCT OR ARISING OUT OF ANY BREACH OF ANY EXPRESS OR IMPLIED WARRANTY. (As examples, this warranty excludes damages for lost time, travel to and from the Authorized Servicer, loss of or damage to media or images, data or other memory or recorded content. This list of items is not exhaustive, but for illustration only.)

In certain instances, some jurisdictions do not allow the exclusion or limitation of incidental or consequential damages, or the exclusion of implied warranties, so the above limitations and exclusions may not be applicable. This warranty gives you specific legal rights and you may have other rights which vary depending on your province or territory.

WARRANTY SERVICE

For product information and operation assistance, please contact our Support page:
www.panasonic.ca/english/support

PRODUCT REPAIRS

Please locate your nearest Authorized Servicentre: panasonic.ca/english/support/servicentrelocator

IF YOU SHIP THE PRODUCT TO A SERVICENTRE

Carefully pack and send prepaid, adequately insured and preferably in the original carton.
Include details of the defect claimed, and proof of date of original purchase.

Specifications

Power Source	120 V, 60 Hz
Power Consumption	12 Amps, 1,400 W
Cooking Power*	1,200 W
Outside Dimensions (W x H x D).....	20 ⁷ / ₁₆ " x 12 ³ / ₈ " x 16 ¹ / ₈ " (519 mm x 315 mm x 410 mm)
Oven Cavity Dimensions (W x H x D).....	13 ⁷ / ₈ " x 10 ³ / ₈ " x 15 ³ / ₁₆ " (353 mm x 261.5 mm x 387.8 mm)
Operating Frequency.....	2,450 MHz
Net Weight.....	Approx. 27.6 lbs (12.5kg)

*IEC Test procedure

Specifications subject to change without notice.

User's Record

The serial number of this product may be found on the back side of the oven or on the left side of the control panel. You should note the model number and the serial number of this oven in the space provided and retain this book as a permanent record of your purchase for future reference.

Model No. _____

Serial No. _____

Date of Purchase _____

Panasonic Canada Inc.
5770 Ambler Drive, Mississauga, ON L4W 2T3

