



Panasonic®

Owner's Manual
Microwave Oven
Household Use Only
Model No. NN-ST77LS
NN-ST74LS
NN-ST75LW
NN-ST75LB



NN-ST77LS

**PLEASE READ THESE INSTRUCTIONS CAREFULLY BEFORE USING THIS PRODUCT,
AND SAVE THIS MANUAL FOR FUTURE USE.**

Inverser le manuel pour lire les instructions en français.

Panasonic Canada Inc.
5770 Ambler Drive
Mississauga, Ontario
L4W 2T3
www.panasonic.com

F0003CK20CP
PA0220-0
Printed in China

© Panasonic Appliances Microwave Oven (Shanghai) Co., Ltd. 2020

CONTENTS

Safety Information

IMPORTANT SAFETY INSTRUCTIONS	3-5
Installation and Grounding Instructions	6
Food Preparation.....	7-8
Location of Controls	10
Control Panel.....	11

Operation

Using the Microwave for the First Time	12
Setting the Clock.....	12
Setting the Child Safety Lock	12
Cooking	13
Keep Warm.....	13-14
Quick 30	14
Add Time	14
Turbo Defrost.....	15
Defrosting Tips & Techniques	15
Setting the Kitchen Timer.....	16
Setting a Standing Time.....	16
Setting a Delayed Start.....	16-17
Popcorn.....	17
Coffee/Milk.....	18
Frozen Foods.....	18
Sensor Reheat	19
Sensor Cook.....	19
Sensor Cook Chart.....	20
Microwave shortcuts	21-22
Food Characteristics	23-24

Maintenance

Care and Cleaning of Your Microwave Oven.....	25
Shop Accessories	25
Before Requesting Service	26
WARRANTY	27

General Information

Cookware Guide	9
Specifications.....	28
Trim Kit Information	28
User's Record.....	29



IMPORTANT SAFETY INSTRUCTIONS

Your safety and the safety of others are very important.



We have provided important safety messages in this manual and on your appliance. Always read and obey all safety messages.

This is the safety alert symbol. It is used to alert you to potential hazards that can kill or hurt you and others.

All safety messages will follow the safety alert symbol and either the word "DANGER," "WARNING" or "CAUTION". These words mean:

DANGER

You can be killed or seriously injured if you don't immediately follow instructions.

WARNING

You can be killed or seriously injured if you don't follow instructions.

CAUTION

You can be exposed to a potentially hazardous situation which, if not avoided, may result in minor or moderate injury.

All safety messages will tell you what the potential hazard is, tell you how to reduce the chance of injury, and tell you what can happen if the instructions are not followed.



PRECAUTIONS TO AVOID POSSIBLE EXPOSURE TO EXCESSIVE MICROWAVE ENERGY

- | | |
|--|--|
| <p>(a) DO NOT attempt to operate this oven with the door open, since open-door operation can result in harmful exposure to microwave energy. It is important not to defeat or tamper with the safety interlocks.</p> <p>(b) DO NOT place any object between the oven front face and the door, or allow soil or cleaner residue to accumulate on sealing surfaces.</p> <p>(c) DO NOT operate the oven if it is damaged. It is particularly</p> | <p>important that the oven door close properly and that there is no damage to the:</p> <p>(1) door (bent),</p> <p>(2) hinges and latches (broken or loosened),</p> <p>(3) door seals and sealing surfaces.</p> <p>(d) The oven should not be adjusted or repaired by anyone except properly qualified service personnel.</p> |
|--|--|

Thank you for purchasing a Panasonic Microwave Oven

Your microwave oven is a cooking appliance and you should use as much care as you use with a stove or any other cooking appliance. When using this electric appliance, basic safety precautions should be followed, including the following:

WARNING

To reduce the risk of burns, electric shock, fire, injury to persons, or exposure to excessive microwave energy:

1. Read all instructions before using this appliance.
2. Read and follow the specific "PRECAUTIONS TO AVOID POSSIBLE EXPOSURE TO EXCESSIVE MICROWAVE ENERGY," above.
3. This appliance must be grounded. Connect only to a properly grounded outlet. See "GROUNDING INSTRUCTIONS" found on page 6.
4. As with any cooking appliance, **DO NOT** leave oven unattended while in use.
5. Install or locate this appliance only in accordance with the installation instructions found on page 6.
6. **DO NOT** cover or block any openings on this appliance.
7. **DO NOT** store this appliance outdoors. **DO NOT** use this product near water (for example, near a kitchen sink, in a wet basement, or near a swimming pool or similar locations).
8. Use this appliance only for its intended use as described in this manual. **DO NOT** use corrosive chemicals, vapors or non-food products in this appliance. This type of oven is specifically designed to heat or cook food. It is not designed for industrial or laboratory use. The use of corrosive chemicals in heating or cleaning will damage the appliance and may result in radiation leaks.



IMPORTANT SAFETY INSTRUCTIONS (continued)

9. When cleaning surfaces of the door and oven that come together on closing the door, use only mild, non-abrasive soaps or detergents applied with a sponge or soft cloth.
10. **DO NOT** allow children to use this appliance, unless closely supervised by an adult. **DO NOT** assume that because a child has mastered one cooking skill he/she can cook everything.
11. **DO NOT** operate this appliance if it has a damaged cord or plug, if it is not working properly, or if it has been damaged or dropped.
12. **DO NOT** immerse cord or plug in water.
13. Keep cord away from heated surfaces.
14. **DO NOT** let cord hang over edge of a table or counter.
15. This appliance should be serviced only by qualified service personnel. Contact the nearest authorized service center for examination, repair or adjustment.
16. Some products such as whole eggs, with or without shell, narrow neck bottles and sealed containers (for example, closed glass jars) may explode and should not be heated in this oven.
17. To reduce the risk of fire in the oven cavity:
 - (a) **DO NOT** overcook food. Carefully attend appliance when paper, plastic, or other combustible materials are placed inside the oven to facilitate cooking.
 - (b) Remove wire twist-ties from paper or plastic bags before placing bag in oven.
 - (c) **If material inside the oven ignites, keep oven door closed, turn oven off, and disconnect the power cord, or shut off power at the fuse or circuit breaker panel.**
 - (d) **DO NOT** use the cavity for storage purposes. **DO NOT leave paper products, cooking utensils or food in the cavity when not in use.**
18. **Superheated Liquids:** Liquids, such as water, coffee or tea are able to be overheated beyond the boiling point without showing evidence (or signs) of boiling. Visible bubbling is not always present when the container is removed from the microwave oven. THIS COULD RESULT IN VERY HOT LIQUIDS SUDDENLY BOILING OVER WHEN THE CONTAINER IS DISTURBED OR A UTENSIL IS INSERTED INTO THE LIQUID. To reduce the risk of injury to persons:
 - (a) **STIR THE LIQUID BOTH BEFORE AND HALFWAY THROUGH HEATING.**
 - (b) **DO NOT heat water and oil, or fats together. The film of oil will trap steam, and may cause a violent eruption.**
 - (c) **DO NOT** use straight-sided containers with narrow necks.
 - (d) After heating, allow the container to stand in the microwave oven for a short time before removing the container.
19. **DO NOT** cook directly on the glass tray. It can crack, and cause injury or damage to the oven.

SAVE THESE INSTRUCTIONS

For proper use of your oven, read remaining safety cautions and owner's manual.



IMPORTANT SAFETY INSTRUCTIONS (continued)

! WARNING

Safety Precautions

TO AVOID THE RISK OF SHOCK:

DO NOT remove top or outer panel from oven. Repairs must be done only by a qualified service person.

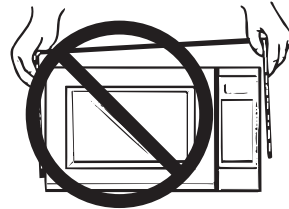

TO REDUCE THE RISK OF EXPOSURE TO MICROWAVE ENERGY:

DO NOT tamper with, or make any adjustments or repairs to Door, Control Panel Frame, Safety Interlock Switches, or any other part of the oven. Microwave leakage may result.

TO AVOID THE RISK OF ARCING DAMAGE OR FIRE:

1. **DO NOT** operate the microwave oven empty, **cook small food portions unattended**, or use metal containers. When using the microwave oven without water or food, **or cook too small a serving**, microwave energy cannot be absorbed and will continuously reflect throughout the cavity. This will cause arcing and damage the oven cavity, door or other components.



2. **DO NOT** store flammable materials next to, on top of, or in the oven.

3. **DO NOT** dry clothes, newspapers or other materials in the oven, or use newspaper or paper bags for cooking.

4. **DO NOT** hit or strike Control Panel. Damage to controls may occur.



5. **DO NOT** use recycled paper products unless the paper product is labeled as safe for microwave oven use. Recycled paper products may contain impurities, which may cause sparking.

TO AVOID THE RISK OF SCALDING:

POT HOLDERS should always be used when removing items from the oven. Heat is transferred from the HOT food to the cooking container and from the container to the Glass Tray. The Glass Tray can also be very HOT after removing the cooking container from the oven. Care in handling must be exercised.



Glass Tray

1. **DO NOT** operate the oven without the Roller Ring and the Glass Tray in place.
2. **DO NOT** operate the oven without the Glass Tray fully engaged on the drive hub. Improper cooking or damage to the oven could result. Verify that the Glass Tray is properly engaged and rotating by observing its rotation when you press **Start**. **Note:** The Glass Tray can turn in either direction.
3. Use only the Glass Tray specifically designed for this oven. **DO NOT** substitute any other Glass Tray.
4. If the Glass Tray is hot, allow to cool before cleaning or placing in water.
5. **DO NOT** cook directly on the Glass Tray. Always place food in a microwave safe dish, or on a rack set in a microwave safe dish.
6. If food or utensil on the Glass Tray touches oven walls, causing the tray to stop moving, the tray will automatically rotate in the opposite direction.

Roller Ring

1. The Roller Ring and oven floor should be cleaned frequently to prevent excessive noise.
2. Always replace the Roller Ring and the Glass Tray in their proper positions.
3. The Roller Ring must always be used for cooking along with the Glass Tray.



Installation and Grounding Instructions

Examine Your Oven

Unpack oven, remove all packing material and examine the oven for any damage such as dents, broken door latches or cracks in the door. Notify dealer immediately if oven is damaged. **DO NOT** install if oven is damaged.

Placement of Oven

- The oven must be placed on a flat, stable surface. Place the front surface of the door 3 inches (7.6 cm) or more from the counter top edge to avoid accidental tipping of the microwave oven during normal use. For proper operation, the oven must have sufficient air flow. Allow 3 inches (7.6 cm) of space on both sides of the oven and 2 inches (5 cm) of space on top of the oven.
 - DO NOT** block air vents. If they are blocked during operation, the oven may overheat and be damaged.
 - DO NOT** place oven near a hot, damp surface such as a gas or electric range, or dishwasher.
 - DO NOT** operate oven when room humidity is excessive.
- This oven is manufactured for household use only. It is not approved or tested for mobile vehicle, marine, or commercial use.

Installation

- DO NOT** block air vents. If they are blocked during operation, the oven may overheat. If the oven overheats, a thermal safety device will turn the oven off. The oven will remain inoperable until it has cooled.
- If the oven is designed for installation into a wall cabinet, only use the proper Panasonic trim kit available from a local Panasonic dealer, or online from the Panasonic Canada eStore. Follow all instructions packed with the trim kit.
- Use of a non-Panasonic trim kit will void the Manufacturer's warranty for the Microwave oven.

WARNING: IMPROPER USE OF THE GROUNDING PLUG CAN RESULT IN A RISK OF ELECTRIC SHOCK.

Consult a qualified electrician or service person if the grounding instructions are not completely understood, or if doubt exists as to whether the appliance is properly grounded. If it is necessary to use an extension cord, use only a three-wire extension cord that has a three-prong polarized grounding plug, and a three-slot receptacle that will accept the plug of the appliance. The marked rating of the extension cord should be equal to or greater than the electrical rating of the appliance.

Grounding Instructions

THIS APPLIANCE MUST BE GROUNDED.

In the event of an electrical short circuit, grounding reduces the risk of electric shock by providing an escape wire for the electric current. This appliance is equipped with a cord having a grounding wire with a grounding plug. The plug must be plugged into an outlet that is properly installed and grounded.

- Plug into properly installed and grounded three-prong outlet.**
- DO NOT** remove ground prong.
- DO NOT** use an adapter.

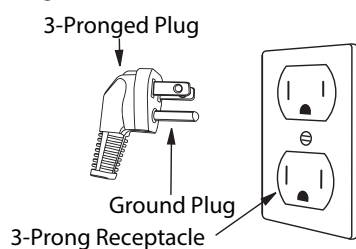

Power Supply

- A short power-supply cord is provided to reduce the risks resulting from becoming entangled in or tripping over a longer cord.
- Longer cord sets or extension cords may be used if care is exercised in their use. **DO NOT** let cord hang over edge of a table or counter.
- If a long cord or extension cord is used,
 - The marked electrical rating of the cord set or extension cord should be at least as great as the electrical rating of the appliance.
 - The extension cord must be a grounding-type 3-wire cord.
 - The longer cord should be arranged so that it will not drape over the counter top or tabletop where it can be pulled on by children or tripped over accidentally.

Wiring Requirements

- The oven must be operated on a SEPARATE CIRCUIT. No other appliance should share the circuit with the microwave oven. If it does, the branch circuit fuse may blow or the circuit breaker may trip.
- The oven must be plugged into at least a 15 A or 20 A, 120 V, 60 Hz GROUNDED OUTLET. **(Beginning in 2017, all new construction and all renovated single family homes must have at least a 20 A, 120 VOLT, 60 Hz GROUNDED OUTLET).** Where a standard two-prong outlet is encountered, it is the responsibility and obligation of the consumer to have it replaced with a properly grounded three-prong outlet.
- The VOLTAGE used must be the same as specified on this microwave oven (120 V, 60 Hz). Using a higher voltage is dangerous and may result in a fire or oven damage. Using a lower voltage will cause slow cooking. Panasonic is NOT responsible for any damages resulting from the use of the oven with any voltage other than specified.

TV / RADIO / WIRELESS EQUIPMENT INTERFERENCE

This product has been tested and found to comply with the limits for Microwave Oven. This product can radiate radio frequency energy, which could cause interference to such products as radio, TV, baby monitor, cordless phone, Bluetooth, wireless router, etc., which can be confirmed by turning this product off and on. If present, the user is encouraged to try to correct by taking one or more of the following countermeasures:

- Increase the spacing distance between the microwave oven and other product receiving the interference.
- If possible, use a properly installed receiver antenna and/or reorient the receiving antenna of the other product receiving the interference.
- Plug the microwave oven into a different outlet from the other product receiving the interference.
- Clean door and sealing surfaces of the oven. (See Care and Cleaning of Your Microwave Oven)

Food Preparation

Follow these Safety Precautions when cooking in your oven.

IMPORTANT

Proper cooking depends upon the power, the time setting and quantity of food. If you use a smaller portion than recommended but cook at the time for the recommended portion, fire could result.

1) HOME CANNING / STERILIZING / DRYING FOODS / SMALL QUANTITIES OF FOODS

- **DO NOT** use your oven for home canning. Your oven cannot maintain the food at the proper canning temperature. The food may be contaminated and then spoil.
- **DO NOT** use the microwave oven to sterilize objects (baby bottles, etc.). It is difficult to keep the oven at the high temperature needed for sterilization.
- **DO NOT** dry meats, herbs, fruits or vegetables in your oven. Small quantities of food or foods with low moisture content can dry out, scorch or catch on fire if overheated.
- **DO NOT** prepare small food portions at high power. This can cause energy concentration at a fixed spot, which can lead to arcing and damage to your oven. Select a lower cook power setting when preparing small portions.

2) POPCORN

Popcorn may be popped in a microwave oven corn popper. Microwave popcorn that pops in its own package is also available. Follow popcorn manufacturers' directions and use a brand suitable for the cooking power of your microwave oven.

CAUTION: *When using pre-packaged microwave popcorn, you can follow recommended package instructions or use the Popcorn pad (refer to page 17). Otherwise, the popcorn may not pop adequately or may ignite and cause a fire. Never leave the oven unattended when popping popcorn. Allow the popcorn bag to cool before opening, and always open the bag facing away from your face and body to prevent steam burns.*



3) DEEP FAT FRYING

- **DO NOT** deep fat fry in your microwave oven. Cooking oils may burst into flames and may cause damage to the oven and may result in burns. Microwave utensils may not withstand the temperature of the hot oil, and can shatter or melt.

4) FOODS WITH NONPOROUS SKINS

- **DO NOT COOK / REHEAT WHOLE EGGS, WITH OR WITHOUT THE SHELL.**

Steam buildup in whole eggs may cause them to explode, and possibly damage the oven or cause injury. Reheating SLICED hard-boiled eggs and cooking SCRAMBLED eggs is safe.



- **Potatoes, apples, whole squash and sausages** are examples of foods with nonporous skins. These types of foods must be pierced before microwave cooking to prevent them from exploding.

CAUTION: *Cooking dry or old potatoes can cause fire.*



5) GLASS TRAY / COOKING CONTAINERS / FOIL

- Cooking containers get hot during microwaving. Heat is transferred from the HOT food to the container and the Glass Tray. Use pot holders when removing containers from the oven or when removing lids or plastic wrap covers from cooking containers, to avoid burns.
- The Glass Tray will get hot during cooking. It should be allowed to cool before handling or before paper products, such as paper plates or microwave popcorn bags, are placed in the oven for microwave cooking.
- When using foil in the oven, allow at least 1-inch (2.5 cm) of space between foil and interior oven walls or door.
- Dishes with metallic trim should not be used, as arcing may occur.

6) PAPER TOWELS / CLOTHS

- **DO NOT** use paper towels or cloths that contain a synthetic fiber woven into them. The synthetic fiber may cause the towel to ignite. Use paper toweling under supervision.

7) BROWNING DISHES / OVEN COOKING BAGS

- Browning dishes or grills are designed for microwave cooking only. Always follow instructions provided by the manufacturer. **DO NOT** preheat browning dish more than six minutes.
- If an oven cooking bag is used for microwave cooking, prepare according to package directions. **DO NOT** use a wire twist-tie to close bag. Instead use plastic ties, cotton string or a strip cut from the open end of the bag.



Food Preparation (continued)

8) THERMOMETERS

- **DO NOT** use a conventional meat thermometer in your oven. Arcing may occur. Microwave safe thermometers are available for both meat and candy.



9) BABY FORMULA / BABY FOOD

- **DO NOT** heat baby formula or baby food in the microwave oven. The glass jar or surface of the food may appear warm while the interior can be so hot as to burn the infant's mouth and esophagus.



10) REHEATING PASTRY PRODUCTS

- When reheating pastry products, check temperatures of any fillings before eating. Some foods have fillings, which heat faster and can be extremely hot, while the surface remains warm to the touch (for example, jelly donuts).

11) GENERAL OVEN USAGE GUIDELINES

- **DO NOT** use the oven for any purpose other than the preparation of food.

This oven is specifically designed to heat or cook food. **DO NOT** use this oven to heat chemicals or other non-food products.

Cookware Guide

This section answers the question, "Can I use in the Microwave?"

Aluminum Foil

It is not recommended to use. Arcing can occur if foil is too close to oven wall or door and cause damage to your oven.



Browning Dish

Yes. Only use browning dishes that are designed for microwave cooking. Check browning dish information for instructions/heating chart. Do not preheat for more than six minutes.

Brown Paper Bags

No. They may cause a fire in the oven.



Microwave Safe

Yes. If labeled Microwave Safe, check manufacturers' directions for use in microwave heating. Some dinnerware may state on the back of the dish, "Oven-Microwave Safe".

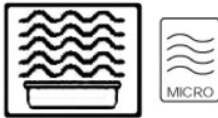

Dinnerware

If unlabeled, use CONTAINER TEST below.

Disposable Polyester Paperboard Dishes

Yes. Some frozen foods are packaged in these dishes. Also can be purchased in some grocery stores.



Fast Food Cartons with Metal Handle

No. Metal handle may cause arcing.



Frozen Dinner Trays

If made for the microwave, then yes. If it contains metal, then no.



Glass Jars

No. Most glass jars are not heat resistant.



Heat Resistant Oven Glassware/Ceramic

Yes, but only ones for microwave cooking and browning. (See CONTAINER TEST below.)



Metal Bakeware

No. Metal can cause arcing and damage to your oven.



Metal Twist-Ties

No. May cause arcing which could cause a fire in the oven.



Oven Cooking Bag

Yes. Follow manufacturers' directions. Close bag with the nylon tie provided, a strip cut from the end of the bag, or a piece of cotton string. Do not close with metal twist-tie. Make six 1/2-inch (1 cm) slits near the closure.

Paper Plates/Cups

Yes. Use to warm cooked foods, and to cook foods that require short cooking time, such as hot dogs. **Do not microwave paper cups; they may overheat and ignite.**



Towels & Napkins

Yes, only paper napkins/towels. Use to warm rolls and sandwiches, only if labeled safe for microwave use. Do NOT use recycled paper towels.



Parchment Paper

Yes. Use as a cover to prevent splattering.

Plastic Cookware

Yes, with caution. Should be labeled, "Suitable for Microwave Heating."



Check Microwave Safe manufacturers' directions for recommended uses. Some microwave safe plastic containers are not suitable for cooking foods with high fat or sugar content. The heat from hot food may cause warping.

Plastic, Melamine

No. This material absorbs microwave energy. Dishes get HOT!

Plastic Foam Cups

Yes, with caution. Plastic foam will melt if foods reach a high temperature. Use short term only to reheat foods to a low serving temperature. **Do not microwave paper cups; they may overheat and ignite.**



Plastic Wrap

Yes. Use to cover food during cooking to retain moisture and prevent splattering. Should be labeled "Suitable for Microwave Heating". Check package directions.



Straw, Wicker, Wood

Yes, short term only. Use only for short term reheating and to bring food to a low serving temperature. Wood may dry out, split or crack.



Thermometers

Only microwave safe thermometers can be used, NOT conventional thermometers.



Wax Paper

Yes. Use as a cover to prevent splattering and to retain moisture.



CONTAINER TEST

TO TEST A CONTAINER FOR SAFE MICROWAVE OVEN USE: Fill a microwave safe cup with cool water and place it in the microwave oven along side the empty container to be tested; **heat one (1) minute at P10 (HIGH)**. If the container is microwave oven safe (transparent to microwave energy), the empty container should remain comfortably cool and the water should be hot. If the container is hot, it has absorbed some microwave energy and should NOT be used. This test cannot be used for plastic containers.



Location of Controls

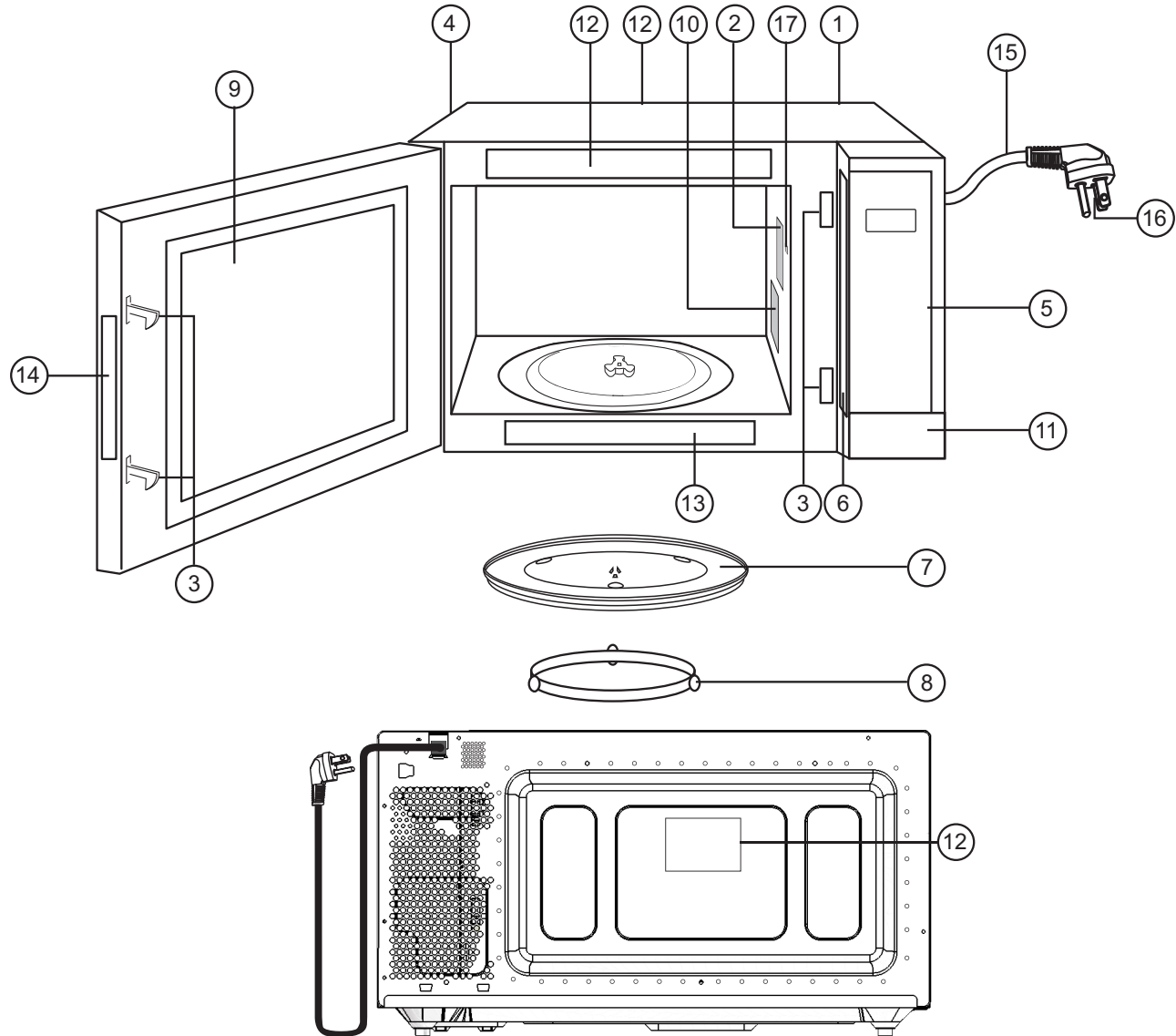

- ① **External Air Vent**
- ② **Internal Air Vent**
- ③ **Door Safety Lock System**
- ④ **Exhaust Air Vent**
- ⑤ **Control Panel**
- ⑥ **Identification Plate**
- ⑦ **Glass Tray**
- ⑧ **Roller Ring**
- ⑨ **Heat/Vapor Barrier Film**
(do not remove)
- ⑩ **Waveguide Cover**
(do not remove)
- ⑪ **Door Release Button**

- ⑫ **Warning Label**
- ⑬ **Menu Label**
- ⑭ **DHHS Label**
- ⑮ **Power Supply Cord**
- ⑯ **Power Supply Plug**
- ⑰ **Oven Light**

Oven light will turn on during cooking and also when door is opened.

NOTE:

The illustration is for reference only.

Control Panel

The control panels of NN-ST77LS/NN-ST74LS/NN-ST75LW/NN-ST75LB have the same key layout and function.

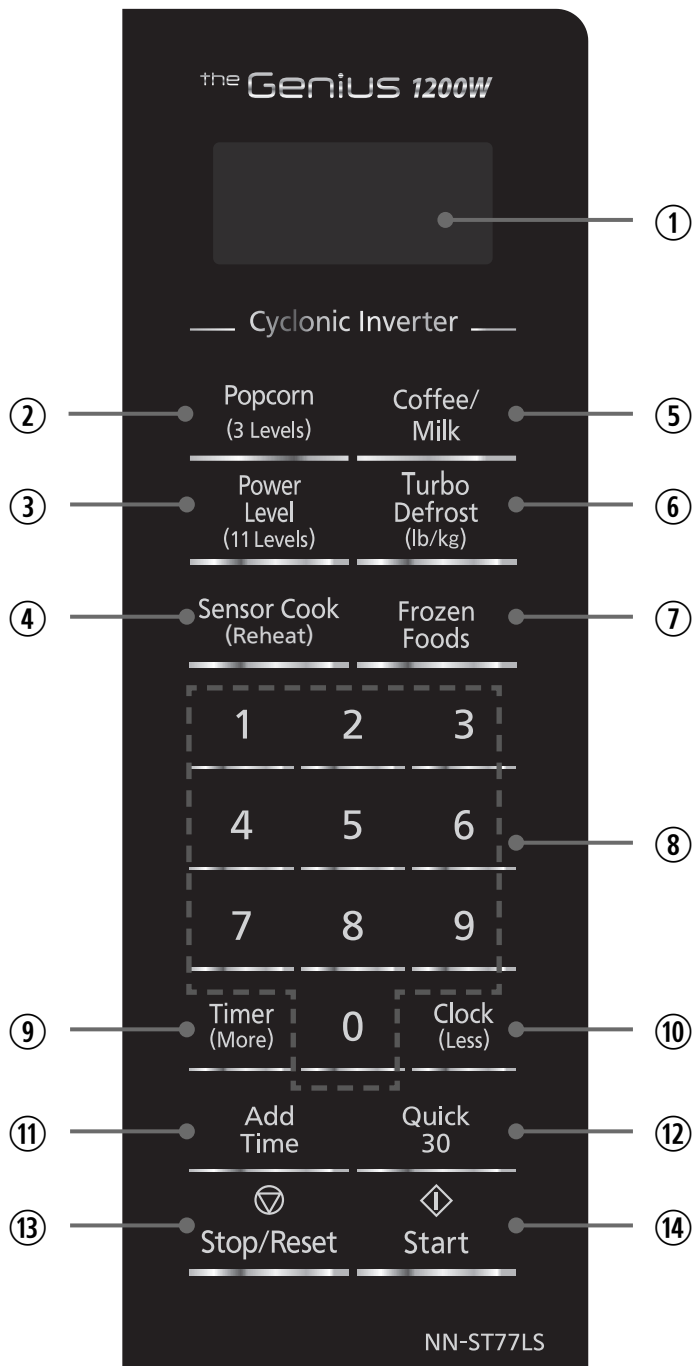

- ① **Display Window**
- ② **Popcorn Pad** (See page 17)
- ③ **Power Level Pad** (See page 13)
- ④ **Sensor Cook (Reheat) Pad** (See page 19)
- ⑤ **Coffee/Milk Pad** (See page 18)
- ⑥ **Turbo Defrost Pad** (See page 15)
- ⑦ **Frozen Foods Pad** (See page 18)
- ⑧ **Number Pads**
- ⑨ **Timer (More) Pad** (See page 16-19)
- ⑩ **Clock (Less) Pad** (See page 12, 17-19)
- ⑪ **Add Time Pad** (See page 14)
- ⑫ **Quick 30 Pad** (See page 14)
- ⑬ **Stop/Reset Pad**
Before cooking: One press clears all your instructions.
During cooking: One press temporarily stops the cooking process. Another tap cancels all your instructions, and time of day or colon appears in the display window.
- ⑭ **Start Pad**
 After cooking program setting, one press allows oven to begin functioning. If door is opened or **Stop/Reset** Pad is pressed once during oven operation, **Start** Pad must be pressed again to restart oven.

Beep Sound:

When a pad is pressed correctly, a beep will be heard. If a pad is pressed and no beep is heard, the unit did not or cannot accept the instruction. When operating, the oven will beep twice between programmed stages. At the end of any complete program, the oven will beep 5 times.

NOTE:

If no operation after cooking program setting, 6 minutes later, the oven will automatically cancel the cooking program. The display will return to clock or colon display.

NOTE:

The illustration is for reference only.

Operation

Using the Microwave for the First Time

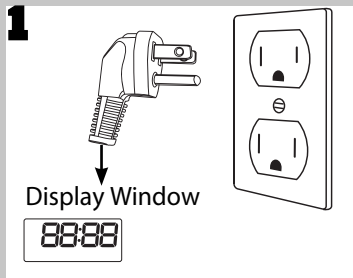

Plug into a properly grounded electrical outlet.

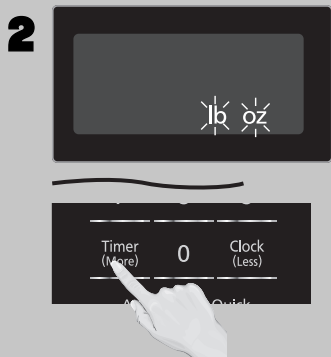

Press **Start** once, then Press **Timer (More)** to cycle between the weight system, Imperial (oz/lb) or Metric (g/kg).



Press **Start** once, then Press **Timer (More)** to cycle between the Beep on or Beep off.

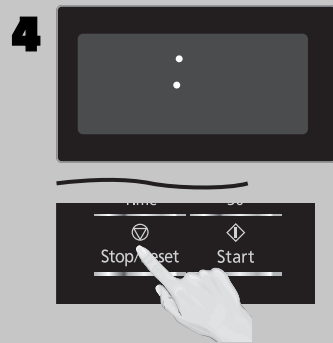

Press **Stop/Reset** to confirm; a colon (:) will appear in the display window.

NOTES:

These choices can be selected only when you plug-in the oven.

Setting the Clock

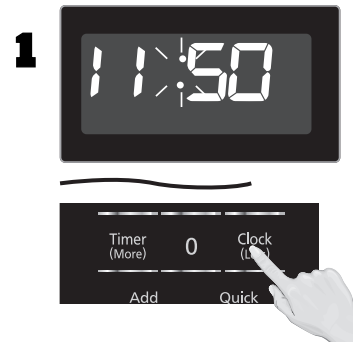

With the oven **NOT** cooking, press **Clock (Less)** once; the colon will blink. Enter time of day using the **Number** pads.



Press **Clock (Less)** to finish setting and the colon (:) will stop blinking.

NOTES:

1. To reset the clock, repeat steps.
2. The clock will retain the time of day as long as the oven is plugged in and electricity is supplied.
3. The clock is a 12-hour display.
4. Oven will not operate while colon (:) is flashing.

Setting the Child Safety Lock

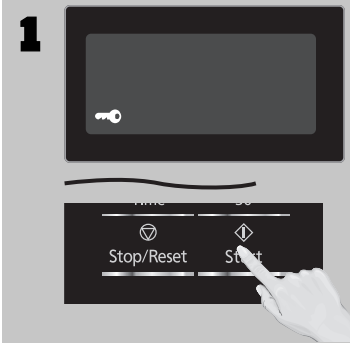

When the time of day appears in the display, press **Start** three times; "🔑" will appear in the display.

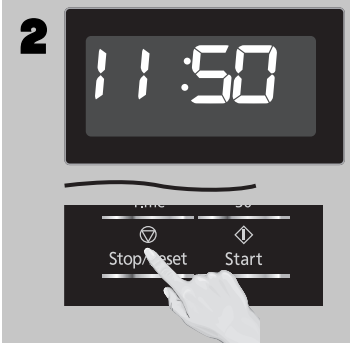

Press **Stop/Reset** three times; the display will return to the time of the day and Child Safety Lock will be cancelled.

NOTES:

1. This feature prevents the electronic operation of the oven until cancelled. It does not lock the door.
2. To set or cancel Child Safety Lock, **Start** or **Stop/Reset** pad must be pressed 3 times within 10 seconds.
3. You can set Child Safety Lock feature when the display shows a colon or time of day.

Operation (continued)

Cooking

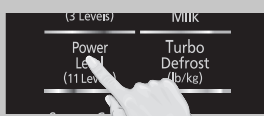
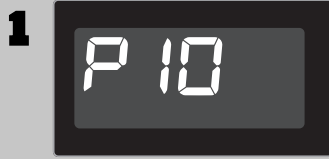

If cooking at high power (P10), skip to step 2. Press **Power Level** until the desired power level appears in the display. P10 is the highest and P1 is the lowest. P0 is the keep warm feature.

Press	Power Level
once	P10 (HIGH)
twice	P9
3 times	P8
4 times	P7 (MED-HIGH)
5 times	P6 (MEDIUM)
6 times	P5
7 times	P4
8 times	P3 (MED-LOW)/ DEFROST
9 times	P2
10 times	P1 (LOW)
11 times	P0 (KEEP WARM)

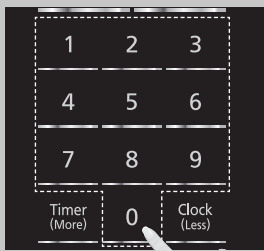

Set cooking time using the **Number** pads. P10 (HIGH) and P0 (KEEP WARM) have max. cooking time of 30 minutes. For other power levels, the max. time is 99 minutes, 99 seconds.

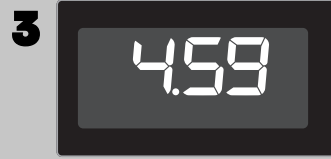

Press **Start**; the cooking will start and the time will count down in the display. At the end of cooking, five beeps will sound.

NOTES:

- For reheating, use P10 (HIGH) for liquids, P7 (MED-HIGH) for most foods, and P6 (MEDIUM) for dense foods.
- For defrosting, use P3 (MED-LOW).
- After pressing **Start**, the selected power level can be recalled. Hold **Power Level** for 2 seconds, then the display window will indicate the power level and keep for 2 seconds.

DO NOT OVERCOOK:

This oven requires less time to cook than older units. Overcooking will cause food to dry out and may cause a fire. A microwave oven's cooking power tells you the amount of microwave power available for cooking.

3 stage Cooking:

For more than one stage of cooking, repeat steps 1 and 2 for each stage of cooking before pressing **Start**. The maximum number of stages for cooking is three. When operating, two beeps will sound between each stage. Five beeps will sound at the end of the entire sequence. Automatic function (such as Frozen Foods, Sensor Cook (Reheat), Popcorn, Coffee/Milk and Turbo Defrost) can not be used with 3 stage Cooking.

Caution:

DO NOT defrost food at a high power setting. Doing so can cause energy concentration at a focused point, which can lead to arcing and damage to the oven. Use the "Defrost" function instead.

Keep Warm

(Will keep cooked food warm for up to 30 minutes after cooking)

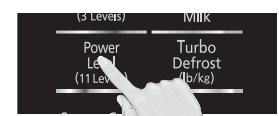

Press **Power Level** 11 times to select the P0 (KEEP WARM).

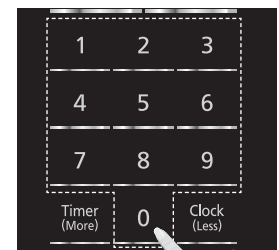

Set warming time using **Number** pads (up to 30 minutes). Set 20 minutes cooking for an example.



Press **Start**; the cooking will start and the time will count down in the display. At the end of cooking, five beeps will sound.

Continued on the Next Page

Operation (continued)

Keep Warm (continued)

NOTES:

1. P0 (KEEP WARM) can be set as the final stage after cook time has been manually entered. It cannot be used with Automatic function (such as Frozen Foods, Sensor Cook (Reheat), Popcorn, Coffee/Milk and Turbo Defrost).
2. After pressing **Start**, the selected power level can be recalled. Hold **Power Level** for 2 seconds, then the display window will indicate the power level and keep for 2 seconds.

Quick 30 (Set or add cooking time in 30 seconds increments)

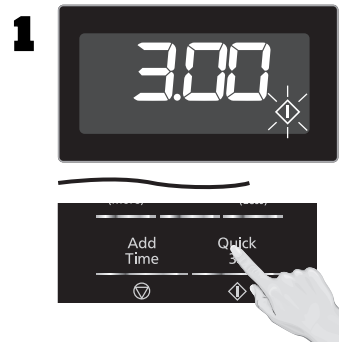

Press **Quick 30** until the desired cooking time (up to 5 minutes) appears in the display. Power Level is pre-set at P10.



Press **Start**; the cooking will start and the time will count down in the display. At the end of cooking, five beeps will sound.

NOTES:

1. This function is not available for Automatic function (such as Frozen Foods, Sensor Cook (Reheat), Popcorn, Coffee/Milk and Turbo Defrost). If desired, you can use other power levels. Select desired power level before pressing **Quick 30**.
2. After setting the time by **Quick 30** pad, you cannot use the **Number Pads**.
3. **Quick 30** pad can also be used to add more time during manual cooking.

Add Time (This feature allows you to add cooking time at the end of previous cooking.)

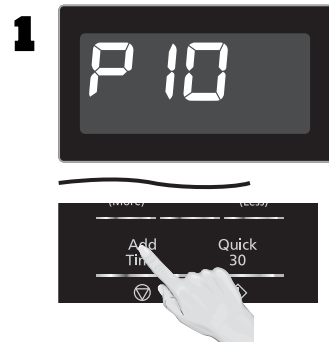

After cooking, press **Add Time**.

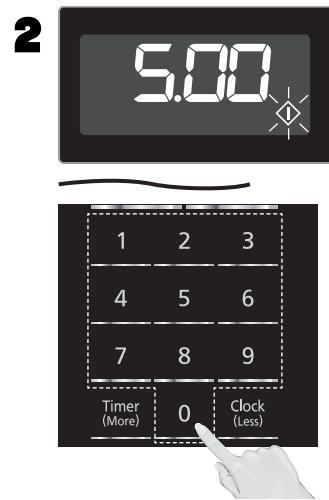

Add cooking time by pressing the **Number pads**. Maximum cooking time: Microwave: P10 or P0 up to 30 minutes; other powers up to 99 minutes and 99 seconds.



Press **Start**. Time will be added. The time in the display window will count down.

NOTES:

1. This function is not available for Automatic function (such as Frozen Foods, Sensor Cook (Reheat), Popcorn, Coffee/Milk and Turbo Defrost).
2. The Add Time function will be cancelled if you do not perform any operation for 1 minute after cooking.
3. The Add Time function can be used after the 3-stage cooking.
4. The power level is the same as the last stage.

Operation (continued)

Turbo Defrost

1

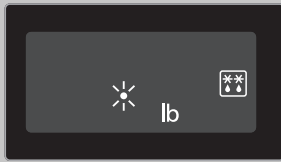

This feature allows you to defrost foods such as meat, poultry and seafood, simply by entering the weight. Press **Turbo Defrost**.

2

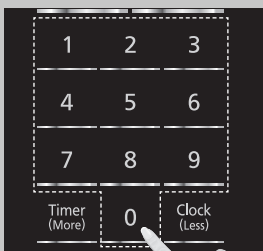
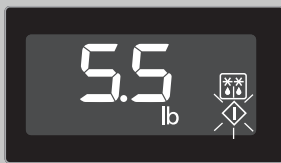

Enter weight of the food using the **Number** pads.

3



Press **Start**. Defrosting will start. Larger weight foods will cause a signal midway through defrosting. If two beeps sound, turn over and/or rearrange foods.

NOTE:

The maximum weight for Turbo Defrost is 6 lbs. (3 kg).

Conversion

Follow the chart to convert ounces or hundredths of a pound into tenths of a pound. To use Turbo Defrost, enter the weight of the food in pounds (1.0) and tenths of a pound (0.1). If a piece of meat weighs 1.95 lbs or 1 lb 14 oz., enter 1.9 lbs.

Ounces	Hundredths of a Pound	Tenths of a Pound
0	.01 - .05	0.0
1 - 2	.06 - .15	0.1
3 - 4	.16 - .25	0.2
5	.26 - .35	0.3
6 - 7	.36 - .45	0.4
8	.46 - .55	0.5
9 - 10	.56 - .65	0.6
11 - 12	.66 - .75	0.7
13	.76 - .85	0.8
14 - 15	.86 - .95	0.9

Defrosting Tips & Techniques

Preparation For Freezing:

1. Freeze meats, poultry, and fish in packages with only one or two layers of food. Place wax paper between layers.
2. Package in heavy-duty plastic wraps, bags (labeled "For Freezer"), or freezer paper.
3. Remove as much air as possible.
4. Seal securely, date, and label.

To Defrost:

1. Remove wrapper. This helps moisture to evaporate. Juices from food can get hot and cook the food.
2. Set food in microwave safe dish.
3. Place roasts fat-side down. Place whole poultry breast-side down.
4. Select power and minimum time so that items will be under-defrosted.

5. Drain liquids during defrosting.
6. Turn over (invert) items during defrosting.

After Defrosting:

1. Large items may be icy in the center. Defrosting will complete during Standing Time.
2. Let stand, covered, following standing time directions on page 16.
3. Rinse foods indicated in the chart.
4. Items which have been layered should be rinsed separately or have a longer standing time.

FOOD	DEFROST TIME at P3 mins (per lb)	DURING DEFROSTING	AFTER DEFROSTING		
			Standing Time	Rinse (cold water)	
Fish and Seafood [up to 3 lbs. (1.4 kg)]	6	Break apart/Rearrange	5 min.	YES	
Crabmeat					
Fish Steaks	4 to 6	Turn over			
Fish Fillets	4 to 6	Turn over/Rearrange/Shield ends			
Sea Scallops	4 to 6	Break apart/Remove defrosted pieces			
Whole fish	4 to 6	Turn over			
Meat			10 min.	NO	
Ground Meat	4 to 5	Turn over/Remove defrosted portion/Shield edges			
Roasts [2½-4 lbs. (1.1-1.8 kg)]	5 to 8	Turn over/Shield ends and defrosted surface	30 min. in refrig.		
Chops/Steak	6 to 8	Turn over/Rearrange/Shield ends and defrosted surface	5 min.		
Ribs/T-bone	6 to 8	Turn over/Rearrange/Shield ends and defrosted surface			
Stew Meat	4 to 8	Break apart/Rearrange/Remove defrosted pieces			
Liver (thinly sliced)	4 to 6	Drain liquid/Turn over/Separate pieces			
Bacon (sliced)	4	Turn over	---		
Poultry			20 min. in refrig.		YES
Chicken, Whole [up to 3 lbs. (1.4 kg)]	4 to 6	Turn over/Shield			
Cutlets	4 to 6	Break apart/Turn over/Remove defrosted Pieces	5 min.		
Pieces	4 to 6	Break apart/Turn over/Shield	10 min.		
Cornish hens	6 to 8	Turn over/Shield			
Turkey Breast [5-6 lbs. (2.3-2.7 kg)]	6	Turn over/Shield	20 min. in refrig.		

Operation (continued)

Setting the Kitchen Timer



This feature allows you to program the oven as a kitchen timer. Press **Timer (More)** once.

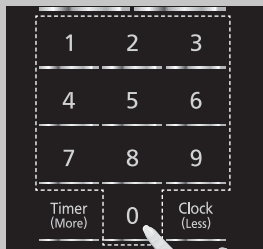

Set desired amount of time using **Number** pads (up to 99 minutes, 99 seconds).

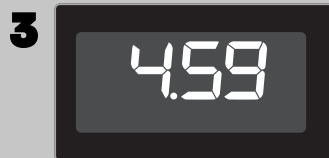

Press **Start**. The timer will count down without cooking and beep five times when done.

Caution: If oven lamp is lit while using the timer feature with door closed, the oven is **NOT** set properly; **STOP OVEN IMMEDIATELY** and re-read instructions.

Setting a Standing Time

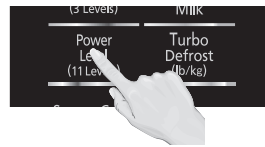

Some recipes call for a standing time after cooking. Press **Power Level** until the desired power level appears in the display.

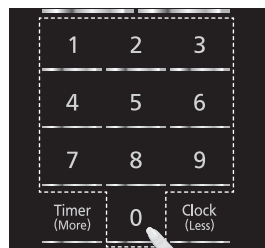

Set cooking time using the **Number** pads (see page 13 for maximum times).



Press **Timer (More)** once.

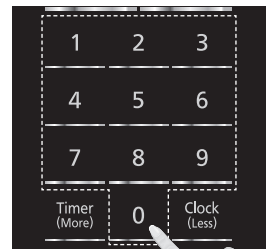

Set desired standing time using **Number** pads (up to 99 minutes, 99 seconds).



Press **Start**. The timer will start and then beep twice at the end of cooking time (the beginning of standing time). Five beeps will sound when standing time is done.

Setting a Delayed Start



This feature can be used to delay the start of your cooking. To do this, first press **Timer (More)**.

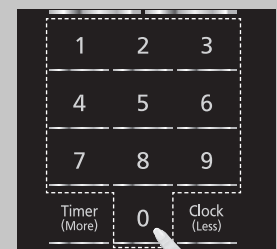

Enter the desired delay time (up to 99 minutes, 99 seconds) using the **Number** pads.

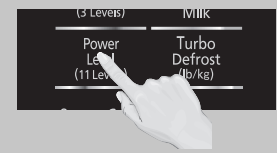
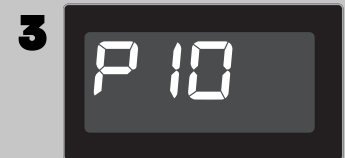

Press **Power Level** until the desired power level appears in the display.

Continued on the Next Page

Operation (continued)

Setting a Delayed Start (continued)

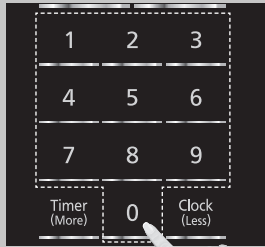
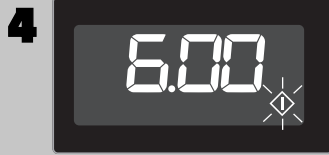

Set Cooking Time using the **Number** pads (see page 13 for maximum times).

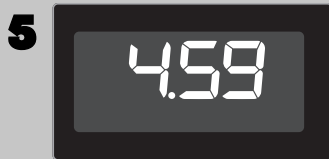

Press **Start**; the delay time will count down, then cooking will begin. At the end of cooking, five beeps will sound.

NOTES:

1. When each stage finishes, the oven will beep twice. At the end of the program, the oven will beep five times.
2. If the oven door is opened during Standing Time, Kitchen Timer or Delayed Start, the time on the display will continue to count down.
3. Standing Time and Delayed Start cannot be programmed before any automatic function (such as Frozen Foods, Sensor Cook (Reheat), Popcorn, Coffee/Milk and Turbo Defrost). This is to prevent the starting temperature of food from rising.
4. When using Standing Time or Delayed Start, it's up to 2 power stages.

Popcorn

(Example: To pop 3.2 oz. (91 g) of popcorn)

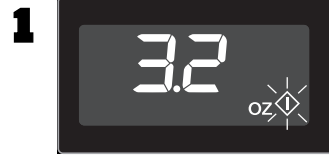

Press **Popcorn** until the desired size appears in the display.

Press	Menu
once	3.2 oz. (91 g)
twice	2.75 oz. (78 g)
3 times	1.5 oz. (42 g)



Press **Start**; After several seconds, cooking time appears in the display window and begins to count down.

NOTES:

1. If the user desires, More/Less adjustment can be done. Press **Timer (More)** once to add 10 seconds or twice to add 20 seconds. Press **Clock (Less)** once to subtract 10 seconds or twice to subtract 20 seconds. Press **Timer (More)** or **Clock (Less)** before pressing **Start**.
2. Pop one bag at a time.
3. Place bag in oven according to manufacturers' directions.
4. Start with popcorn at room temperature.
5. Allow popped corn to sit unopened for a few minutes.
6. Open bag carefully to prevent burns, because steam will escape.
7. Do not reheat unpopped kernels or reuse bag.
8. If popcorn is of a different weight than listed, follow instructions on popcorn package.
9. **Never leave the oven unattended.**
10. **If popping slows to 2 to 3 seconds between pops, stop oven. Overcooking can burn popcorn or cause fire.**
11. When popping multiple bags one right after the other, the cooking time may vary slightly. This does not affect the popcorn results.

Operation (continued)

Coffee/Milk

(Example: To reheat 2 cups coffee.)



Press **Coffee/Milk** until the desired menu appears in the display window.

Press	Menu
once	1 cup coffee (1-1)
twice	2 cups coffee (1-2)
3 times	1 cup milk (2-1)
4 times	2 cups milk (2-2)



Press **Start**. Reheat will start. The time in the display window will count down.

NOTES:

1. If the user desires, More/Less adjustment can be done. Press **Timer (More)** to add 10% more time than suggested. Press **Clock (Less)** to subtract 10% cooking time. Press **Timer (More)** or **Clock (Less)** before pressing **Start**.
2. Use a microwave safe cup.
3. Heated coffee/milk can erupt if not mixed with air. Do not heat coffee/milk in your microwave oven without stirring before and halfway through heating.
4. Care must be exercised not to overheat coffee/milk when using the Coffee/Milk feature. It is programmed to give proper result when heating 1 cup or 2 cups of coffee/milk, starting from room temperature for coffee and refrigerator temperature for milk. Overheating will cause an increased risk of scalding, or water eruption. Refer to page 4, item 18.
5. 1 cup of milk is $\frac{3}{4}$ cup (200 ml) to 1 cup (250 ml) and 1 cup of coffee is $\frac{7}{16}$ cup (150 ml) to $\frac{3}{4}$ cup (200 ml).

Frozen Foods

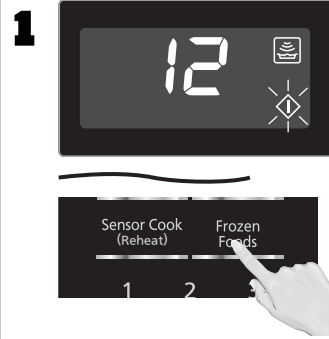

Press **Frozen Foods** until the number corresponding to the desired menu appears in the display.

Press	Menu
once	Frozen Entrées
twice	Frozen Pizza (single)
3 times	Frozen Vegetables
4 times	Frozen Dinners

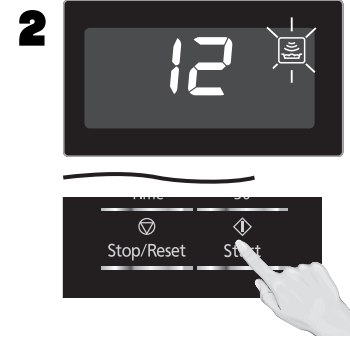

Press **Start**. Cooking is complete when five beeps sound.

NOTES:

If the user desires, More/Less adjustment can be done. Press **Timer (More)** to add 20% more time than suggested. Press **Clock (Less)** to subtract 20% cooking time. Press **Timer (More)** or **Clock (Less)** before pressing **Start**.

Frozen Foods Chart

See the chart below for Frozen Foods categories.

Menu	Serving/Weight	Hints
12. Frozen Entrées	8 – 28 oz. (220 – 800 g)	Follow manufacturers' directions for preparation. After 2 beeps, stir or rearrange. Be careful when removing the film cover after cooking. Remove facing away from you to avoid steam burns. If additional time is needed, continue to cook manually.
13. Frozen Pizza (single)	8 oz. (220 g)	Follow manufacturers' directions for preparation. Add more time of cooking if needed.
14. Frozen Vegetables	6 – 16 oz. (170 – 450 g)	Place vegetables into cooking container. Add 2 tbsps (30 ml) of water, and cover with lid or vented plastic wrap. Do not salt/butter until after cooking. (Not suitable for vegetables in butter or sauce.)
15. Frozen Dinners	11 – 16 oz. (300 – 450 g)	Follow manufacturers' directions for covering or removing covers. Do not use frozen foods packaged in foil trays. After 2 beeps, stir or rearrange.

Operation (continued)

Sensor Reheat

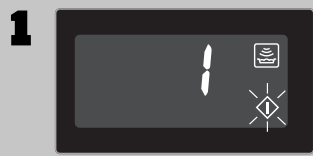

Press **Sensor Cook (Reheat)** once.

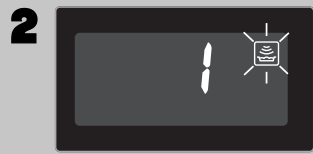

Press **Start**. Reheating is complete when five beeps sound.

NOTES:

1. If the user desires, More/Less adjustment can be done. Press **Timer (More)** to add 20% more time than suggested. Press **Clock (Less)** to subtract 20% cooking time. Press **Timer (More)** or **Clock (Less)** before pressing **Start**.
2. After having used the Sensor Reheat feature a few times, you may decide you would prefer your food cooked to a different doneness – that is why you would utilize the **Timer (More)** or **Clock (Less)** pads.
3. When steam is detected by the Genius Sensor and two beeps sound, the remaining cooking time will appear in the display.

Casseroles: Add 45 to 60 ml (3 to 4 tablespoons) of liquid, cover with lid or vented plastic wrap. Stir when time appears in the display window.

Canned foods: Empty contents into casserole dish or serving bowl, cover dish with lid or vented plastic wrap. After reheating, let stand for a few minutes.

Plate of food: Arrange food on plate; top with butter, gravy, etc. Cover with lid or vented plastic wrap. After reheating, let stand for a few minutes.

DO NOT USE SENSOR REHEAT:

1. To reheat bread and pastry products. Use manual power and time for these foods.
2. For raw or uncooked foods.
3. If oven cavity is warm.
4. For beverages.
5. For frozen foods.

Sensor Cook



Press **Sensor Cook (Reheat)** until the number corresponding to the desired food appears in the display (see chart on the next page).



Press **Start**. Cooking is complete when five beeps sound.

NOTES:

1. If the user desires, More/Less adjustment can be done. Press **Timer (More)** to add 20% more time than suggested. Press **Clock (Less)** to subtract 20% cooking time. Press **Timer (More)** or **Clock (Less)** before pressing **Start**.
2. After having used the Sensor Cook feature a few times, you may decide you would prefer your food cooked to a different doneness – that is why you would utilize the **Timer (More)** or **Clock (Less)** pad.

3. When steam is detected by the Genius Sensor and two beeps sound, the remaining cooking time will appear in the display.
4. Automatic features are provided for your convenience. If results are not suitable to your individual preference, or if serving size is other than what is listed on page 20, please refer to manual cooking on page 13.

For the best results with the GENIUS SENSOR, follow these recommendations:

BEFORE Reheating/Cooking:

1. The room temperature surrounding the oven should be below 95 °F (35 °C).
2. Food weight should exceed 4 oz. (110 g).
3. Be sure the glass tray, the outside of the cooking containers and the inside of the microwave oven are dry before placing food in the oven. Residual beads of moisture turning into steam can mislead the sensor.
4. Cover food with lid, or with vented plastic wrap. Never use tightly sealed plastic containers—they can prevent steam from escaping and cause food to overcook.

DURING Reheating/Cooking:

DO NOT open the oven door until two beeps sound and cooking time appears in the display. Doing so will cause inaccurate cooking since the steam from food is no longer contained within the oven cavity. Once the cooking time begins to count down, the oven door may be opened to stir, turn or rearrange foods.

AFTER Reheating/Cooking:

All foods should have a standing time.

Operation (continued)

Sensor Cook Chart

See the chart below for Sensor Cook categories.

Menu	Serving/Weight	Hints
1. Sensor Reheat	4 – 16 oz. (110 – 450 g)	All foods, such as casseroles, plated dinners, soups, stews, pasta dishes (except lasagne) and canned foods, must be pre-cooked. Foods should be reheated from refrigerator or room temperature, do not reheat frozen foods on this setting. Do not reheat in foil or plastic containers as unsuccessful reheating times will result. All foods should be covered with vented plastic wrap or a fitting lid. Where possible after heating, stir foods and stand covered for 3 to 5 minutes before serving.
2. Oatmeal	½ – 1 cup (40 – 80 g)	Place oatmeal in a microwave safe serving bowl with no cover. Follow manufacturers' directions for preparation.
3. Breakfast Sausage	2 – 8 links	Follow manufacturers' directions for preparation of pre-cooked breakfast sausage. Place in a radial pattern.
4. Omelet	2 – 4 eggs	Follow basic Omelet recipe on this page.
5. Quinoa	¼ – 1 cup (45 – 180 g)	Place quinoa in a 1.5 to 3 qt microwave safe casserole dish. Add 2 parts water to 1 part quinoa. For ¼ cup (45 g), triple water may need as necessary. Cover with lid or vented plastic wrap. After 2 beeps, stir. Let stand 14 minutes before serving.
6. Soup	1 – 2 cups (250 – 500 ml)	Pour soup into a microwave safe serving bowl. Cover with lid or vented plastic wrap. Stir after cooking.
7. Potatoes (pierce skin)	1 – 4 potatoes (6 – 8 oz. each) (170 – 220 g)	Pierce each potato with a fork 6 times spacing around surface. Place potato or potatoes around the edge of paper-towel-lined Glass Tray (Turntable), at least 1 inch (2.5 cm) apart. Do not cover. After 2 beeps, turn over. Let stand 5 minutes to complete cooking.
8. Fresh Vegetables	4 – 16 oz. (110 – 450 g)	All pieces should be the same size. Wash thoroughly, add 1 tbsp (15 ml) of water per 4 oz (110 g) of vegetables, and cover with lid or vented plastic wrap. Do not salt/butter until after cooking.
9. White Rice	½ – 1 ½ cups (110 – 335 g)	Place rice with hot tap water in a microwave safe casserole dish. Cover with lid or vented plastic wrap. Let stand 5 to 10 minutes before serving. Add 2 parts water to 1 part rice.
10. Pasta	2 – 8 oz. (55 – 220 g)	Place 2 oz. (55 g) pasta with 3 cups (750 ml) hot tap water in a 2 qt microwave safe casserole, salt and oil, if desired, covered with lid or vented plastic wrap. For 4 oz. (110 g) pasta use 4 cups (1000 ml) water, for 6 oz. (165 g) pasta use 6 cups (1500 ml) hot water in 3 qt casserole, for 8 oz. (220 g) pasta use 7 cups (1750 ml) hot tap water.
11. Fish Fillets	4 – 16 oz. (110 – 450 g)	Arrange in a single layer. Cover with lid or vented plastic wrap.

Recipe

OMELET

Basic Omelet Recipe

1 Tablespoon (15 ml) butter or margarine

2 Eggs

2 Tablespoons (30 ml) milk

Salt and ground black pepper, if desired.

Heat butter in a microwave safe 9-inch (23 cm) pie plate, 20 seconds at P10, or until melted.

Turn the plate to coat the bottom with butter. Meanwhile, combine the remaining ingredients in a separate bowl, beat together and pour into the pie plate. Cook, covered with vented plastic wrap, using OMELET selection. Let stand 2 minutes. With a spatula, loosen the edges of the omelet from the plate, fold into thirds to serve. **Always beat the eggs before making the omelet.**

Yield: 1 Serving

Approx. cooking time: 4 minutes.

NOTE: Double ingredients for a 4-egg Omelet.

Microwave Shortcuts

Food	Power	Time (in mins.)	Directions
To separate refrigerated Bacon , 1 pound (450 g)	P10 (HIGH)	30 sec.	Remove wrapper and place in microwave safe dish. After heating, use a plastic spatula to separate slices.
To soften Brown Sugar , 1 cup (250 ml)	P10 (HIGH)	20 - 30 sec.	Place brown sugar in microwave safe dish with a slice of bread. Cover with lid or plastic wrap.
To soften refrigerated Butter , 1 stick, ¼ pound (110 g) To melt refrigerated Butter , 1 stick, ¼ pound (110 g)	P3 (MED-LOW) P6 (MEDIUM)	1 1½ - 2	Remove wrapper and place butter in a microwave safe dish. Remove wrapper and place butter in a microwave safe dish covered with lid or vented plastic wrap.
To melt Chocolate , 1 square, 1 oz. (28 g) To melt Chocolate , ½ cup (125 ml) chips	P6 (MEDIUM) P6 (MEDIUM)	1 - 1½ 1 - 1½	Remove wrapper and place chocolate in a microwave safe dish. After heating, stir until completely melted. <i>NOTE: Chocolate holds its shape even when softened.</i>
To toast Coconut , ½ cup (125 ml)	P10 (HIGH)	1	Place in a microwave safe dish. Stir every 30 seconds.
To soften Cream Cheese , 8 oz. (220 g)	P3 (MED-LOW)	1 - 2	Remove wrapper and place in a microwave safe bowl.
To brown Ground Beef , 1 pound (450 g)	P10 (HIGH)	4 - 5	Crumble into a microwave safe colander set into another dish. Cover with plastic wrap. Stir twice. Drain grease.
To cook Vegetables , Fresh (½ lb.) (225 g) Frozen (10 oz.) (280 g) Canned (15 oz.) (430 g)	P8 P8 P8	3½ - 4 3½ - 4 3½ - 4	All pieces should be the same size. Wash thoroughly, add 1 tbsp (15 ml) of water per ½ cup (125 ml) of vegetables, and cover with lid or vented plastic wrap. Do not salt/butter until after cooking. Wash thoroughly, add 1 tbsp (15 ml) of water per ½ cup (125 ml) of vegetables, and cover with lid or vented plastic wrap. Do not salt/butter until after cooking. (Not suitable for vegetables in butter or sauce.) Empty contents into microwave safe serving bowl. Do not cover.
To cook baked Potato , (6 - 8 oz. each) (170 - 220 g) 1 piece 2 pieces	P8 P8	3½ - 4 6 - 7	Pierce each potato with a fork 6 times spacing around surface. Place potato or potatoes around the edge of paper-towel-lined glass tray (Turntable), at least 1 inch (2.5 cm) apart. Do not cover. Let stand 5 minutes to complete cooking.
To steam Hand Towel - 4	P10 (HIGH)	20 - 30 sec.	Soak in water, then wring out excess. Place on a microwave safe dish. heat. Present immediately.

Microwave Shortcuts (continued)

Food	Power	Time (in mins.)	Directions
To soften Ice Cream , ½ gallon (2 L)	P3 (MED-LOW)	1 – 1½	Check often to prevent melting.
Cup of liquid To boil water, broth, etc. 1 cup, 8 oz. (250 ml) 2 cups, 16 oz. (500 ml)	P10 (HIGH) P10 (HIGH)	1½ – 2 2½ – 3	Heated liquids can erupt if not stirred. Do not heat liquids in microwave oven without stirring before heating.
Cup of liquid To warm Beverage , 1 cup, 8 oz. (250 ml) 2 cups, 16 oz. (500 ml)	P7 (MED-HIGH) P7 (MED-HIGH)	1½ – 2 2½ – 3	
To roast Nuts , 1½ cups (375 ml)	P10 (HIGH)	3 – 4	
To toast Sesame Seeds , ¼ cup (60 ml)	P10 (HIGH)	2 – 2½	Place in a small microwave safe bowl. Stir twice.
To skin Tomatoes , (one at a time)	P10 (HIGH)	30 sec.	Place tomato into a microwave safe bowl containing boiling water. Rinse and peel. Repeat for each tomato.
To remove Cooking Odors	P10 (HIGH)	5	Combine 1 to 1½ cups (250 – 375 ml) water with the juice and peel of one lemon in a 2 quart microwave safe bowl. After water finishes boiling, wipe interior of oven with a cloth. You can also use a combination of several whole cloves and ¼ cup (60 ml) of vinegar with 1 cup (250 ml) of water.

Food Characteristics

Bone and Fat

Both bone and fat affect cooking. Bones may cause irregular cooking. Meat next to the tips of bones may overcook while meat positioned under a large bone, such as a ham bone, may be undercooked. Large amounts of fat absorb microwave energy and the meat next to these areas may overcook.



Density

Porous, airy foods such as breads, cakes or rolls take less time to cook than heavy, dense foods such as potatoes and roasts. When reheating donuts or other foods with different centers be very careful. Certain foods have centers made with sugar, water, or fat and these centers attract microwaves (for example, jelly donuts). When a jelly donut is heated, the jelly can become extremely hot while the exterior remains warm to the touch. This could result in a burn if the food is not allowed to cool properly in the center.

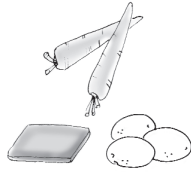

Quantity

Two potatoes take longer to cook than one potato. As the quantity of the food decreases so does the cooking time. Overcooking will cause the moisture content in the food to decrease and a fire could result. Never leave microwave unattended while in use.



Shape

Uniform sizes heat more evenly. The thin end of a drumstick will cook more quickly than the meaty end. To compensate for irregular shapes, place thin parts toward the center of the dish and thick pieces toward the edge.



Size

Thin pieces cook more quickly than thick pieces.



Starting Temperature

Foods that are at room temperature take less time to cook than if they are chilled, refrigerated or frozen.



Cooking Techniques

Piercing

Foods with skins or membranes must be pierced, scored or have a strip of skin peeled before cooking to allow steam to escape. Pierce clams, oysters, chicken livers, whole potatoes and whole vegetables. Whole apples or new potatoes should have a 1-inch (2.5 cm) strip of skin peeled before cooking. Score sausages and frankfurters. Do not Cook/Reheat whole eggs, with or without the shell. Steam buildup in whole eggs may cause them to explode, and possibly damage the oven or cause injury. Reheating SLICED hard-boiled eggs and cooking SCRAMBLED eggs is safe.

Browning

Foods will not have the same brown appearance as conventionally cooked foods or those foods which are cooked utilizing a browning feature. Meats and poultry may be coated with browning sauce, Worcestershire sauce, barbecue sauce or shake-on browning sauce. To use, combine browning sauce with melted butter or margarine and brush on before cooking. For quick breads or muffins, brown sugar can be used in the recipe in place of granulated sugar, or the surface can be sprinkled with dark spices before baking.

Spacing

Individual foods, such as baked potatoes, cupcakes and appetizers, will cook more evenly if placed in the oven equal distances apart. When possible, arrange foods in a circular pattern.

Covering

As with conventional cooking, moisture evaporates during microwave cooking. Casserole lids or plastic wrap are used for a tighter seal. When using plastic wrap, vent the plastic wrap by folding back part of the plastic wrap from the edge of the dish to allow steam to escape. Loosen or remove plastic wrap as recipe directs for standing time. When removing plastic wrap covers, as well as any glass lids, be careful to remove them away from you to avoid steam burns. Various degrees of moisture retention are also obtained by using wax paper or paper towels.

Shielding

Thin areas of meat and poultry cook more quickly than meaty portions. To prevent overcooking, these thin areas can be shielded with strips of aluminum foil. Wooden toothpicks may be used to hold the foil in place.

▲ CAUTION is to be exercised when using foil. Arcing can occur if foil is too close to oven wall or door and damage to your oven will result.

Cooking Time

Cooking times will vary because of food shape variations, starting temperature, and regional preferences. Always cook food for the minimum cooking time given in a recipe and check for doneness. If the food is undercooked, continue cooking. It is easier to add time to an undercooked product. Once the food is overcooked, nothing can be done.

Food Characteristics (continued)

Stirring

Stirring is usually necessary during microwave cooking. Always bring the cooked outside edges toward the center and the less cooked center portions toward the outside of the dish.

Rearranging

Rearrange small items such as chicken pieces, shrimp, hamburger patties or pork chops. Rearrange pieces from the edge to the center and pieces from the center to the edge of the dish.

Turning

It is not possible to stir some foods to distribute the heat evenly. At times, microwave energy will concentrate in one area of the food. To help ensure even cooking, these foods need to be turned. Turn over large foods, such as roasts or turkeys, halfway through cooking.

Standing Time

Most foods will continue to cook by conduction after the microwave oven is turned off. After cooking meat, the internal temperature will rise 5 °F to 15 °F (3 °C to 8 °C), if allowed to stand, tented with foil, for 10 to 15 minutes. Casseroles and vegetables need a shorter amount of standing time, but this standing time is necessary to allow foods to complete cooking to the center without overcooking on the edges.

Test for Doneness

The same tests for doneness used in conventional cooking may be used for microwave cooking. Meat is done when fork-tender or splits at fibers. Chicken is done when juices are clear yellow and drumstick moves freely. Fish is done when it flakes and is opaque. Cake is done when a toothpick or cake tester is inserted and comes out clean.

Check foods to see that they are cooked to the United States Department of Agriculture's recommended temperatures.

To test for doneness, insert a meat thermometer in a thick or dense area away from fat or bone. NEVER leave the thermometer in the food during cooking, unless it is approved for microwave oven use.

Cook all food to these minimum internal temperatures as measured with a food thermometer before removing food from oven. For reasons of personal preference, you may choose to cook food at higher temperatures.

Product	Minimum Internal Temperature & Rest Time
Beef, Pork, Veal & Lamb Steaks, chops, roasts	145 °F (63 °C) and allow to rest for at least 3 minutes
Ground meats	160 °F (71 °C)
Ham, fresh or smoked (uncooked)	145 °F (63 °C) and allow to rest for at least 3 min.
Fully Cooked Ham (to reheat)	Reheat cooked hams packaged in USDA-inspected plants to 140 °F (60 °C); all others to 165 °F (74 °C).
All Poultry (breasts, whole bird, legs, thighs, and wings, ground poultry, and stuffing)	165 °F (74 °C)
Eggs	160 °F (71 °C)
Fish & Shellfish	145 °F (63 °C)
Leftovers	165 °F (74 °C)
Casseroles	165 °F (74 °C)

Care and Cleaning of Your Microwave Oven

Please see below and the following page for particular cleaning instructions for each section of the oven.

BEFORE CLEANING: Unplug oven at wall outlet. If outlet is inaccessible, leave oven door open while cleaning.

AFTER CLEANING: Be sure to place the Roller Ring and the Glass Tray in the proper position and press **Stop/Reset** Pad to clear the Display.

1. **Outside oven surfaces:** Clean with a damp cloth. To prevent damage to the operating parts inside the oven, water should not be allowed to seep into ventilation openings.
2. **Label:** Do not remove. Wipe with a damp cloth.
3. **Inside the Oven:** Wipe with a damp cloth after using. Mild detergent may be used if needed. Do not use harsh detergents or abrasives.
4. **Oven Door:** Wipe with a soft dry cloth when steam accumulates inside or around the outside of the oven door. During cooking, especially under high humidity conditions, steam is given off from the food. (Some steam will condense on cooler surfaces, such as the oven door. This is normal.) Inside surface is covered with a heat and vapor barrier film. **Do not remove.**
5. **Oven Cavity Floor:** Clean the bottom surface of the oven with mild detergent, water or window cleaner, and dry.
6. **Waveguide Cover:** Do not remove Wave Guide Cover. It is important to keep cover clean in the same manner as the inside of the oven. Failure to do so may damage the cover.
7. **Control Panel:** If the Control Panel becomes wet, clean it with a soft dry cloth. Do not use harsh detergents or abrasives. For some models: The Control Panel is covered with a removable protective film to prevent scratches during shipping. Small bubbles may appear under this film, so if this is the case, remove by applying masking or clear tape to an exposed corner and pull gently.
8. **Glass Tray:** Remove and wash in warm soapy water or in a dishwasher.
9. **Roller Ring:** Roller Ring may be washed in mild soapy water or dishwasher. These areas should be kept clean to avoid excessive noise.

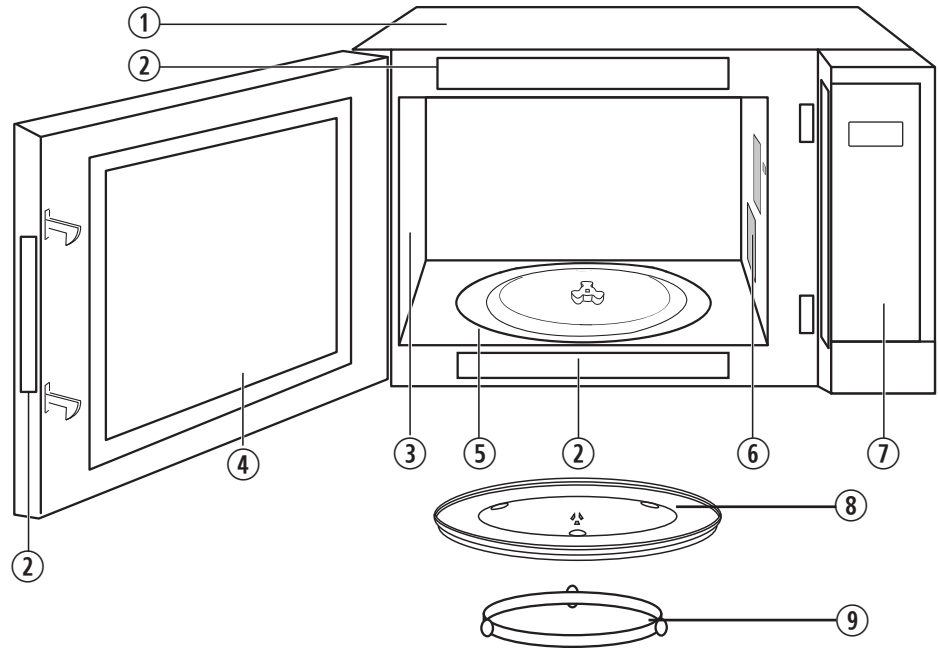

AS WITH ANY COOKING APPLIANCE, MICROWAVE OVENS REQUIRE THE SAME LEVEL OF CARE TO PREVENT OVERHEATING OR DAMAGE. IT IS IMPORTANT TO KEEP THE OVEN CLEAN AND DRY. FOOD RESIDUE AND CONDENSATION MAY CAUSE RUSTING OR ARCING AND DAMAGE TO THE OVEN. AFTER USE, WIPE DRY ALL SURFACES, INCLUDING VENT OPENINGS, OVEN SEAMS, AND UNDER GLASS TRAY.

NOTE:

1. After cooking, the oven should be cleaned with a soft cloth moistened with soapy water. If the oven is not cleaned occasionally to eliminate grease, it can accumulate and cause the oven to "Smoke" during use.
2. DO NOT SPRAY DIRECTLY INSIDE THE OVEN.
A steam cleaner is not to be used for cleaning.
3. The illustration is for reference only.

Shop Accessories

Purchase Parts, Accessories and Owner's Manual online for all Panasonic Products by visiting our Web Site at:

shop.panasonic.ca

Parts Available to Order

Owner's Manual (this book)	F0003CK20CP
Glass Tray	F06014W00AP
Roller Ring Assembly	F290DBP20AP

Before Requesting Service

See below before calling for service, as most problems can easily be remedied by following these simple solutions:

Problem	Solution
The oven causes TV interference.	Some radio, TV, Wi-Fi, cordless telephone, baby monitor, blue tooth or other wireless equipment interference might occur when you cook with the microwave oven. This interference is similar to the interference caused by small appliances such as mixers, vacuums, blow dryers, etc. It does not indicate a problem with your oven.
Steam accumulates on oven door and warm air comes from the oven vents.	During cooking, steam and warm air are given off from the food. Most of the steam and warm air are removed from the oven by the air which circulates in the oven cavity. However, some steam will condense on cooler surfaces such as the oven door. This is normal. After use, the oven should be wiped dry (see page 25).
Oven will not turn on.	The oven is not plugged in securely or needs to be reset; remove plug from outlet, wait ten seconds and re-insert. Main circuit breaker or main fuse is tripped; reset main circuit breaker or replace main fuse. There is a problem with the outlet; plug another appliance into the outlet to check if it is working.
Oven will not start cooking.	The door is not completely closed; close the oven door securely. Start was not pressed after programming; press Start . Another program is already entered into the oven; press Stop/Reset to cancel the previous program and enter new program. The program is not correct; program again according to the owner's manual. Stop/Reset has been pressed accidentally; program oven again.
The Glass Tray wobbles.	The Glass Tray is not positioned properly on the Roller Ring or there is food under the Roller Ring; take out Glass Tray and Roller Ring. Wipe with a damp cloth and reset Roller Ring and Glass Tray properly.
When the oven is operating, there is noise coming from the Glass Tray.	The Roller Ring and oven bottom are dirty; clean these parts according to Care and Cleaning of Your Microwave Oven (see page 25).
The "🔒" appears in the display.	The CHILD SAFETY LOCK was activated by pressing Start three times; Deactivate CHILD SAFETY LOCK by pressing Stop/Reset three times.
The oven stops cooking and nothing appears in the display window.	If the Display Window is blank, there is a problem with the microwave generation system; Please contact an authorised Service Center (see next page).

WARRANTY

Panasonic Canada Inc.
5770 Ambler Drive, Mississauga, Ontario L4W 2T3
Panasonic PRODUCT – LIMITED WARRANTY

Panasonic Canada Inc. warrants this product to be free from defects in material and workmanship under normal use and for a period as stated below from the date of original purchase agrees to, at its option either (a) repair your product with new or refurbished parts, (b) replace it with a new or a refurbished equivalent value product, or (c) refund your purchase price. The decision to repair, replace or refund will be made by Panasonic Canada Inc.

Category	Service type	Parts	Labour	Magnetron
Counter top microwave oven (except Prestige models)	Carry-in	1 Year	1 Year	Additional 4 Years (Part only)
Counter top microwave oven – Prestige model (Genius Prestige, Genius Prestige Plus and Genius Prestige Grill)	In-home	2 Years	2 Years	Additional 3 Years (Part only)
Microwave Convection oven	In-home	2 Years	2 Years	Additional 3 Years (Part only)
Over The Range (OTR) microwave oven	In-home	2 Years	2 Years	Additional 3 Years (Part only)

In-home Service will be carried out only to locations accessible by roads and within 50 km of an authorized Panasonic service facility.

This warranty is given only to the original purchaser, or the person for whom it was purchased as a gift, of a Panasonic brand product mentioned above sold by an authorized Panasonic dealer in Canada and purchased and used in Canada, which product was not sold "as is", and which product was delivered to you in new condition in the original packaging.

IN ORDER TO BE ELIGIBLE TO RECEIVE WARRANTY SERVICE HEREUNDER, A PURCHASE RECEIPT OR OTHER PROOF OF DATE OF ORIGINAL PURCHASE, SHOWING AMOUNT PAID AND PLACE OF PURCHASE IS REQUIRED

LIMITATIONS AND EXCLUSIONS

This warranty ONLY COVERS failures due to defects in materials or workmanship, and DOES NOT COVER normal wear and tear or cosmetic damage. The warranty ALSO DOES NOT COVER damages which occurred in shipment, or failures which are caused by products not supplied by **Panasonic Canada Inc.**, or failures which result from accidents, misuse, abuse, neglect, mishandling, misapplication, alteration, faulty installation, set-up adjustments, misadjustment of consumer controls, improper maintenance, power line surge, lightning damage, modification, introduction of sand, humidity or liquids, commercial use such as hotel, office, restaurant, or other business or rental use of the product, or service by anyone other than a Authorized Servicer, or damage that is attributable to acts of God.

Over-The-Range cooktop light bulbs are excluded from coverage under this warranty.

In the case where the microwave oven is built-in, the warranty will be voided if using a non-Panasonic trim kit.

THIS EXPRESS, LIMITED WARRANTY IS IN LIEU OF ALL OTHER WARRANTIES, EXPRESS OR IMPLIED, INCLUDING ANY IMPLIED WARRANTIES OF MERCHANTABILITY AND FITNESS FOR A PARTICULAR PURPOSE. IN NO EVENT WILL Panasonic Canada Inc. BE LIABLE FOR ANY SPECIAL, INDIRECT OR CONSEQUENTIAL DAMAGES RESULTING FROM THE USE OF THIS PRODUCT OR ARISING OUT OF ANY BREACH OF ANY EXPRESS OR IMPLIED WARRANTY. (As examples, this warranty excludes damages for lost time, travel to and from the Authorized Servicer, loss of or damage to media or images, data or other memory or recorded content. This list of items is not exhaustive, but for illustration only.)

In certain instances, some jurisdictions do not allow the exclusion or limitation of incidental or consequential damages, or the exclusion of implied warranties, so the above limitations and exclusions may not be applicable. This warranty gives you specific legal rights and you may have other rights which vary depending on your province or territory.

WARRANTY SERVICE

PRODUCT OPERATION ASSISTANCE

For product information and operation assistance, please visit our Support page: www.panasonic.ca/english/support

PRODUCT REPAIRS

Please locate your nearest Authorized Servicentre: panasonic.ca/english/support/servicentrelocator

IF YOU SHIP THE PRODUCT TO A SERVICENTRE

Carefully pack and send prepaid, adequately insured and preferably in the original carton.
Include details of the defect claimed, and proof of date of original purchase.

Specifications

Power Source	120 V, 60 Hz
Power Consumption	12.3 Amps, 1,460W
Cooking Power*	1,200 W
Operating Frequency	2,450 MHz
Outside Dimensions (W x H x D)	21 ⁷ / ₈ " x 11 ¹⁵ / ₁₆ " x 19 ⁷ / ₁₆ " (555 mm x 304 mm x 493 mm)
Oven Cavity Dimensions (W x H x D)	15 ¹¹ / ₁₆ " x 8 ¹ / ₄ " x 18 ¹ / ₂ " (398 mm x 210 mm x 470 mm)
Net Weight	Approx. 31.5 lbs. (14.3 kg)

*IEC Test procedure

Specifications subject to change without notice.

Trim Kit Information

Trim Kit 24" (only for NN-ST77LS/NN-ST74LS)

Model Number	NN-TK714S
Outside Dimensions (W x H)	23 ¹ / ₂ " x 16 ¹ / ₂ " (596 mm x 410 mm)
Cabinet Opening (W x H x D)	23 ⁵ / ₈ " x 15 ⁹ / ₁₆ " x 21" (600 mm x 395 mm x 533 mm)

Trim Kit 27" (only for NN-ST77LS/NN-ST74LS)

Model Number	NN-TK72LS/NN-TK722S
Outside Dimensions (W x H)	27" x 16 ¹ / ₂ " (684 mm x 419 mm)
Cabinet Opening (W x H x D)	25 ¹ / ₂ " x 15 ⁵ / ₁₆ " x 21" (648 mm x 389 mm x 533 mm)

Trim Kit 30" (only for NN-ST77LS/NN-ST74LS)

Model Number	NN-TK73LS/NN-TK732S
Outside Dimensions (W x H)	30" x 16 ¹ / ₂ " (760 mm x 419 mm)
Cabinet Opening (W x H x D)	28 ¹ / ₂ " x 15 ⁵ / ₁₆ " x 21" (724 mm x 389 mm x 533 mm)

Trim kit explanation:

	Face type	Cabinet type
NN-TK722/TK732SSAP	with louver	Both (w and w/o back vent opening)
NN-TK72L/TK73LSSAP	without louver (Flat)	Back vent opening type only



User's Record

The serial number of this product may be found on the back side of the oven or on the left side of the control panel. You should note the model number and the serial number of this oven in the space provided and retain this book as a permanent record of your purchase for future reference.

Model No. _____

Serial No. _____

Date of Purchase _____