

DIGITAL Palmcorder®
CAMCORDER

Panasonic®

Operating Instructions

Digital Video Camcorder

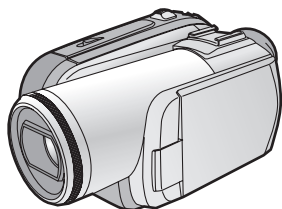

Model No. **PV-GS320**



Before connecting, operating or adjusting this product, please read the instructions completely.

Spanish Quick Use Guide is included.

Guía para rápida consulta en español está incluida.

LEICA
DICOMAR



Mini DV



For USA assistance, please call: 1-800-211-PANA(7262) or, contact us via the web at: <http://www.panasonic.com/contactinfo>

For Canadian assistance, please call: 1-800-561-5505 or visit us at www.panasonic.ca



LSQT1091 A

Things You Should Know

Thank you for choosing Panasonic!

You have purchased one of the most sophisticated and reliable products on the market today. Used properly, we're sure it will bring you and your family years of enjoyment. Please take time to fill in the information on the right.

The serial number is on the tag located on the underside of your Camcorder. Be sure to **retain this manual** as your convenient Camcorder information source.

Date of Purchase

Dealer Purchased From

Dealer Address

Dealer Phone No.

Model No.

Serial No.

Safety Precautions

WARNING: TO PREVENT FIRE OR SHOCK HAZARD, DO NOT EXPOSE THIS EQUIPMENT TO RAIN OR MOISTURE.

Your ^{Mini} **DX** Camcorder is designed to record and play back in Standard Play (SP) mode and Long Play (LP) mode

It is recommended that only cassette tapes that have been tested and inspected for use in Camcorder with the ^{Mini} **DX** mark be used.

The following mark and symbols are located on bottom of the unit.

	CAUTION RISK OF ELECTRIC SHOCK DO NOT OPEN	
CAUTION: TO REDUCE THE RISK OF ELECTRIC SHOCK, DO NOT REMOVE SCREWS. NO USER-SERVICEABLE PARTS INSIDE. REFER SERVICING TO QUALIFIED SERVICE PERSONNEL.		



The lightning flash with arrowhead symbol, within an equilateral triangle, is intended to alert the user to the presence of uninsulated "dangerous voltage" within the product's enclosure that may be of sufficient magnitude to constitute a risk of electric shock to persons.



The exclamation point within an equilateral triangle is intended to alert the user to the presence of important operating and maintenance (servicing) instructions in the literature accompanying the appliance.

WARNING:

TO REDUCE THE RISK OF FIRE, ELECTRIC SHOCK OR PRODUCT DAMAGE,

- **DO NOT EXPOSE THIS APPARATUS TO RAIN, MOISTURE, DRIPPING OR SPLASHING AND THAT NO OBJECTS FILLED WITH LIQUIDS, SUCH AS VASES, SHALL BE PLACED ON THE APPARATUS.**
- **USE ONLY THE RECOMMENDED ACCESSORIES.**
- **DO NOT REMOVE THE COVER (OR BACK); THERE ARE NO USER SERVICEABLE PARTS INSIDE. REFER SERVICING TO QUALIFIED SERVICE PERSONNEL.**

CAUTION!

DO NOT INSTALL OR PLACE THIS UNIT IN A BOOKCASE, BUILT-IN CABINET OR IN ANOTHER CONFINED SPACE. ENSURE THE UNIT IS WELL VENTILATED. TO PREVENT RISK OF ELECTRIC SHOCK OR FIRE HAZARD DUE TO OVERHEATING, ENSURE THAT CURTAINS AND ANY OTHER MATERIALS DO NOT OBSTRUCT THE VENTILATION VENTS.

THE FOLLOWING APPLIES ONLY IN THE U.S.A.

FCC Note: This equipment has been tested and found to comply with the limits for a Class B digital device, pursuant to Part 15 of the FCC Rules. These limits are designed to provide reasonable protection against harmful interference in a residential installation. This equipment generates, uses, and can radiate radio frequency energy and, if not installed and used in accordance with the instructions, may cause harmful interference to radio communications. However, there is no guarantee that interference will not occur in a particular installation. If this equipment does cause harmful interference to radio or television reception, which can be determined by turning the equipment off and on, the user is encouraged to try to correct the interference by one or more of the following measures:

- Reorient or relocate the receiving antenna.
- Increase the separation between the equipment and receiver.
- Connect the equipment into an outlet on a circuit different from that to which the receiver is connected.
- Consult the dealer or an experienced radio/TV technician for help.

FCC Caution: To assure continued compliance, follow the attached installation instructions and use only shielded interface cables with ferrite core when connecting to computer or peripheral devices. Any changes or modifications not expressly approved by the party responsible for compliance could void the user's authority to operate this equipment.

Declaration of Conformity

Trade Name: Panasonic
Model No.: PV-GS320
Responsible party: Panasonic Corporation of North America
One Panasonic Way, Secaucus, NJ 07094
Support Contact: Panasonic Consumer Electronics Company
1-800-211-PANA(7262)

This device complies with Part 15 of the FCC Rules. Operation is subject to the following two conditions: (1) This device may not cause harmful interference, and (2) this device must accept any interference received, including interference that may cause undesired operation.

WARNING

- **AS WITH ANY SMALL OBJECT, SD CARDS CAN BE SWALLOWED BY YOUNG CHILDREN. DO NOT ALLOW CHILDREN TO HANDLE THE SD CARD.**

THE FOLLOWING APPLIES ONLY IN CANADA

This Class B digital apparatus complies with Canadian ICES-003.

IMPORTANT SAFETY INSTRUCTIONS

Read these operating instructions carefully before using the unit. Follow the safety instructions on the unit and the applicable safety instructions listed below. Keep these operating instructions handy for future reference.

- 1) Read these instructions.
- 2) Keep these instructions.
- 3) Heed all warnings.
- 4) Follow all instructions.
- 5) Do not use this apparatus near water.
- 6) Clean only with dry cloth.
- 7) Do not block any ventilation openings. Install in accordance with the manufacturer's instructions.
- 8) Do not install near any heat sources such as radiators, heat registers, stoves, or other apparatus (including amplifiers) that produce heat.
- 9) Do not defeat the safety purpose of the polarized or grounding-type plug. A polarized plug has two blades with one wider than the other. A grounding-type plug has two blades and a third grounding prong. The wide blade or the third prong are provided for your safety. If the provided plug does not fit into your outlet, consult an electrician for replacement of the obsolete outlet.
- 10) Protect the power cord from being walked on or pinched particularly at plugs, convenience receptacles, and the point where they exit from the apparatus.
- 11) Only use attachments/accessories specified by the manufacturer.
- 12) Use only with the cart, stand, tripod, bracket, or table specified by the manufacturer, or sold with the apparatus. When a cart is used, use caution when moving the cart/apparatus combination to avoid injury from tip-over.
- 13) Unplug this apparatus during lightning storms or when unused for long periods of time.
- 14) Refer all servicing to qualified service personnel. Servicing is required when the apparatus has been damaged in any way, such as power-supply cord or plug is damaged, liquid has been spilled or objects have fallen into the apparatus, the apparatus has been exposed to rain or moisture, does not operate normally, or has been dropped.



Precautions

USE & LOCATION

WARNING

- **TO AVOID SHOCK HAZARD ...** Your Camcorder and power supply should not be exposed to rain or moisture. Do not connect the power supply or operate your Camcorder if it gets wet. Your Camcorder has been designed for outdoor use, however it is not designed to sustain direct exposure to water, rain, sleet, snow, sand, dust, or a direct splashing from a pool or even a cup of coffee. This action could permanently damage the internal parts of your Camcorder. Do not attempt to disassemble this unit. There are no user serviceable parts inside. Unplug your Camcorder from the power supply before cleaning.

CAUTION

- **DO NOT AIM YOUR CAMCORDER AT THE SUN OR OTHER BRIGHT OBJECTS**
- **DO NOT LEAVE THE CAMCORDER WITH THE EVF AIMED DIRECTLY AT THE SUN AS THIS MAY CAUSE DAMAGE TO THE INTERNAL PARTS OF THE EVF**
- **DO NOT EXPOSE YOUR CAMCORDER TO EXTENDED HIGH TEMPERATURE ...** Such as, in direct sunlight, inside a closed car, next to a heater, etc... This action could permanently damage the internal parts of your Camcorder.
- **AVOID SUDDEN CHANGES IN TEMPERATURE ...** If the unit is suddenly moved from a cold place to a warm place, moisture may form on the tape and inside the unit.

- **DO NOT LEAVE YOUR CAMCORDER OR THE POWER SUPPLY TURNED ON WHEN NOT IN USE.**

- **STORAGE OF YOUR CAMCORDER ...** Store and handle your Camcorder in a manner that will not subject it to unnecessary movement (avoid shaking and striking). Your Camcorder contains a sensitive pick-up device which could be damaged by improper handling or storage.

CARE

- **TO CLEAN YOUR CAMCORDER ...** Do not use strong or abrasive detergents when cleaning your Camcorder body.
- **TO PROTECT THE LENS ...** Do not touch the surface of the lens with your hand. Use a commercial Camcorder lens solution and lens paper when cleaning the lens. Improper cleaning can scratch the lens coating.
- **TO PROTECT THE FINISH OF YOUR CAMCORDER ...** Before handling your Camcorder, make sure your hands and face are free from any chemical products, such as suntan lotion, as it may damage the finish.

-If you see this symbol-

Information on Disposal in other Countries outside the European Union



This symbol is only valid in the European Union.

If you wish to discard this product, please contact your local authorities or dealer and ask for the correct method of disposal.

Batteries

1. Battery pack (Lithium ion battery pack)

- Use the specified unit to recharge the battery pack.
- Do not use the battery pack with equipment other than the specified unit.
- Do not get dirt, sand, liquids, or other foreign matter on the terminals.
- Do not touch the plug terminals (+ and -) with metal objects.
- Do not disassemble, remodel, heat or throw into fire.

2. Button-type battery (Lithium battery)

- Insert with poles aligned.
- Do not touch the terminals (+ and -) with metal objects.
- Do not recharge, disassemble, remodel, heat or throw into fire.
- Keep out of reach of children.

If any electrolyte should come into contact with your hands or clothes, wash it off thoroughly with water.

If any electrolyte should come into contact with your eyes, never rub the eyes. Rinse eyes thoroughly with water, and then consult a doctor.

Warning

Risk of fire, explosion and burns. Do not disassemble.

Do not heat the batteries above the following temperatures or incinerate.

Button-type battery 60 °C (140 °F)

Battery pack 60 °C (140 °F)

AC adaptor

This AC adaptor operates on AC between 110V and 240 V.

But

- In the U.S.A. and Canada, the AC adaptor must be connected to a 120V AC power supply only.
- When connecting to an AC supply outside of the U.S.A. or Canada, use a plug adaptor to suit the AC outlet configuration.
- When connecting to a supply of greater than AC 125V, ensure the cord you use is suited to the voltage of the AC supply and the rated current of the AC adaptor.
- Contact an electrical parts distributor for assistance in selecting a suitable AC plug adaptor or AC cord set.

The socket outlet shall be installed near the equipment and easily accessible. The mains plug of the power supply cord shall remain readily operable. To completely disconnect this apparatus from the AC Mains, disconnect the power supply cord plug from AC receptacle.

Marking sign is located on bottom of the unit.

Apparatus Claims of U.S. Patent Nos. 4,631,603, 4,577,216, and 4,819,098, licensed for limited viewing.

This product incorporates copyright protection technology that is protected by method claims of certain U.S. patents and other intellectual property rights owned by Macrovision Corporation and other rights owners. Use of this copyright protection technology must be authorized by Macrovision Corporation, and is intended for home and other limited viewing uses only unless otherwise authorized by Macrovision Corporation. Reverse engineering or disassembly is prohibited.

U.S.A./CANADA CONSUMERS: ATTENTION:



A lithium ion/polymer battery that is recyclable powers the product you have purchased. Please call 1-800-8-BATTERY for information on how to recycle this battery.

Before opening the CD-ROM package, please read the following.

End User License Agreement (for USB Driver, Quick Movie Magic and MotionDV STUDIO)

You ("Licensee") are granted a license for the Software defined in this End User Software Agreement ("Agreement") on condition that you agree to the terms and conditions of this Agreement. If Licensee does not agree to the terms and conditions of this Agreement, promptly return the Software to Matsushita Electric Industrial Co., Ltd. ("Matsushita"), its distributors or dealers from which you made the purchase.

Article 1 License

Licensee is granted the right to use the software, including the information recorded or described on the CD-ROM, instruction manuals, and any other media provided to Licensee (collectively "Software"), but all applicable rights to patents, copyrights, trademarks and trade secrets in the Software are not transferred to Licensee.

Article 2 Use by a Third Party

Licensee may not use, copy, modify, transfer or allow any third party, whether free of charge or not, to use, copy or modify the Software, except as expressly provided for in this Agreement.

Article 3 Restrictions on Copying the Software

Licensee may make a single copy of the Software in whole or in part solely for back-up purpose.

Article 4 Computer

Licensee may only use the Software on a single computer at a single location.

Article 5 Reverse Engineering, Decompiling or Disassembly

Licensee may not reverse engineer, decompile, or disassemble the Software, except to the extent either of them is permitted under law or regulation of the country where Licensee resides. Matsushita, or its distributors or dealers will not be responsible for any defects in the Software or damage to Licensee caused by Licensee's reverse engineering, decompiling, or disassembly of the Software.

Article 6 Limitation of Liability

The Software is provided "AS-IS" without warranty of any kind, either expressed or implied, including, but not limited to, warranties of non-infringement, merchantability and/or fitness for a particular purpose. Further, Matsushita does not warrant that the operation of the Software will be uninterrupted or error free. Matsushita or any of its distributors or dealers will not be liable for any damage suffered by Licensee arising from or in connection with Licensee's use of the Software.

Article 7 Export Control

Licensee agrees not to export or re-export to any country the Software in any form without the appropriate export licenses under regulations of the country where Licensee resides, if necessary.

Article 8 Termination of License

The right granted to Licensee hereunder will be automatically terminated if Licensee violates any of the terms and conditions of this Agreement. Upon such automatic termination, Licensee must destroy the Software and related documentation together with all the copies thereof at Licensee's own expense.

Contents

Before using	Record mode
Quick Guide.....	Check before recording.....
Accessories.....	Recording on a tape.....
Parts identification and handling.....	Recording check.....
Attaching the lens cap.....	Blank search function.....
How to remove the Sensor tag (for U.S.A. only).....	Recording still pictures on a card while recording image onto a tape.....
The grip belt.....	Recording still pictures onto a card (Photoshot).....
Power supply.....	Zoom in/out function.....
Charging time and recordable time.....	Recording yourself.....
Turning the Camcorder on.....	Backlight compensation function.....
Setting date and time.....	MagicPix function.....
Using the LCD monitor.....	Soft skin mode.....
Using the viewfinder.....	Tele macro function.....
Quick Start.....	Fade in/fade out function.....
Inserting/removing a cassette.....	Wind noise reduction function.....
Inserting/removing a card.....	Auto Ground-Directional Standby (AGS).....
Selecting a mode.....	Self-timer recording.....
How to use the joystick.....	Wide/4:3 function.....
Help mode.....	Optical image stabilizer function.....
Switching the language.....	Guideline function.....
Using the menu screen.....	Recording in various situations (Scene mode).....
Adjusting LCD monitor/viewfinder.....	Recording in natural colors (White balance).....
Using the remote control.....	Manual focus adjustment.....
	Manual shutter speed/aperture adjustment... ..

Playback mode	
Playing back tape	42
Slow-motion playback/ frame-by-frame playback	43
Variable-speed search function	43
Playback on TV	44
Playing back card	44
Deleting files recorded on a card	45
Formatting a card.....	46
Protecting files on a card	46
Writing the printing data on a card (DPOF setting)	46

Edit mode	
Recording from a tape onto a card	47
Copying onto a DVD recorder or a VCR (Dubbing)	47
Using the DV Interface Cable for Recording (Digital Dubbing)	48
Audio dubbing.....	49
PC Connection With DV Interface Cable	50
Printing pictures by directly connecting to the printer (PictBridge)	50

With a PC	
Check before Use	52
Using the Camcorder with a PC	52
Connecting Computer and Camcorder	53
Using as a Web camera	54
Using Quick Movie Magic or MotionDV STUDIO.....	57
Using on Macintosh	60
To disconnect USB cable safely.....	60
If you no longer need software or driver (Uninstall)	61
Notes	61

Menu	
Menu list	63
Menus related to taking pictures	65
Menus related to playback	65
Other menus.....	65

Others	
Indications	66
Warning/alarm indications	67
Functions cannot be used simultaneously	68
Before requesting repair (Problems and solutions)	69
Cautions for Use.....	72
Explanation of terms.....	75
Specifications	77
Camcorder Accessory System	79
Camcorder Accessory Order Form (For USA Customers)	80
Request for Service Notice (USA Only)	81
Limited Warranty (For USA Customers).....	82
Customer Services Directory.....	83
Warranty (For Canadian Customers)	84
Index.....	85
Spanish Quick Use Guide/ Guía española para el uso rápido.....	86

Quick Guide

■ Charging the battery

- 1 Connect the AC cable to the AC adaptor and the AC jack.
- 2 Put the battery on the battery mount by aligning the mark and then securely plug it in.

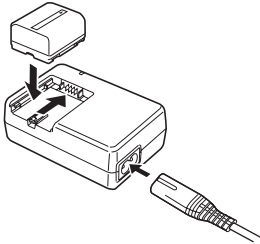

■ Attaching the battery

Push the battery against the battery holder and slide it until it clicks.

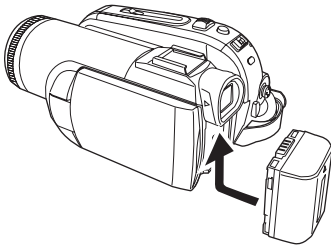

■ Inserting/removing a cassette

- 1 Slide the [OPEN/EJECT] lever and open the cassette cover.



- 2 After the cassette holder is opened, insert/remove the cassette.

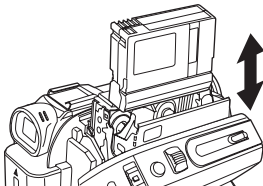

- 3 Push the [PUSH] mark ① in order to close the cassette holder.

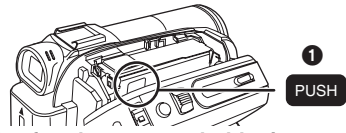

- 4 Only after the cassette holder is completely housed, close the cassette cover.

■ Inserting/removing a card

- 1 Open the card slot cover.

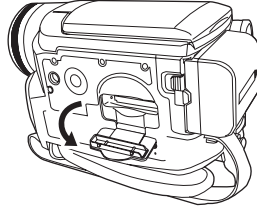

- 2 Insert/remove the card into/from the card slot.

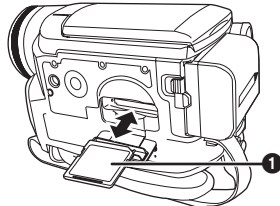

- When inserting a card, face the label side ① towards you and push it straight in with one stroke as far as it goes.
- When removing the card, open the card slot cover and press the center of the card and then pull it straight out.

- 3 Securely close the card slot cover.

■ How to turn on the power

- 1 While pressing the button ①, set the [OFF/ON] switch to [ON].

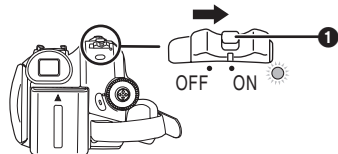

■ How to turn off the power

1 While pressing the button ①, set the [OFF/ON] switch to [OFF].

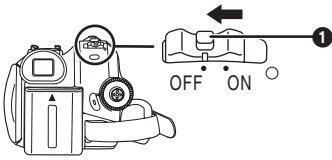

■ Recording on a tape

●Set to Tape Recording Mode.

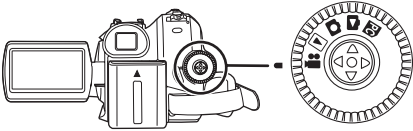

1 Press the recording start/stop button to start recording.

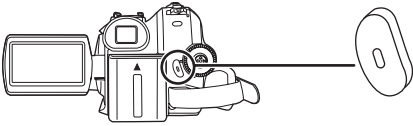

2 Press the recording start/stop button again to pause recording.



■ Recording still pictures onto a card (Photoshot)

●Set to Card Recording Mode.

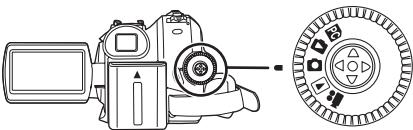

1 Press the Photoshot button [📷].

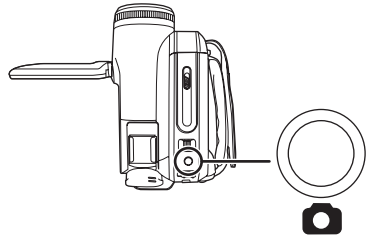

■ Playing back tape

●Set to Tape Playback Mode.

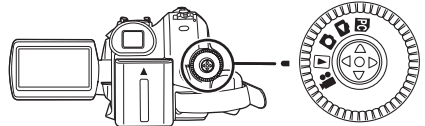

1 Operate with joystick.



▶/||: Playback/Pause

◀◀: Rewind/Review playback (Reverts to playback with the ▶/|| icon.)

▶▶: Fast forward/Cue playback (Reverts to playback with the ▶/|| icon.)

■: Stop

■ Playing back card

●Set to Card Playback Mode.

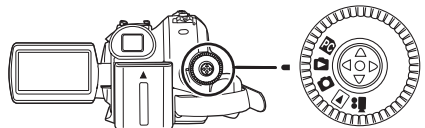

1 Operate with joystick.

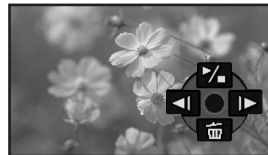

◀: Plays back the previous picture.

▶: Plays back the next picture.

▶/■: Slide show (Plays back the still pictures on the card in order) start/pause

Before using

Accessories

The following are the accessories supplied with this product.

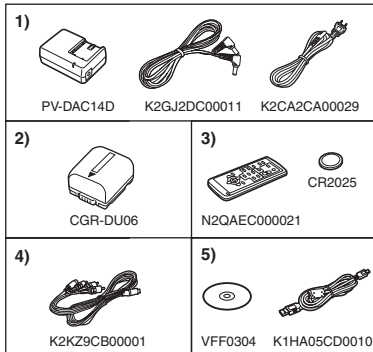

- 1) **AC adaptor, DC cable, AC cable** -15-
- 2) **Battery pack** -15-
- 3) **Remote control, button-type battery** -26-

< For USA-California only >

This product contains a CR Coin Cell Lithium Battery which contains Perchlorate Material – special handling may apply.
See www.dtsc.ca.gov/hazardouswaste/perchlorate.

- 4) **Multi cable** -44-, -47-
- 5) **USB cable and CD-ROM** -50-, -52-

Parts identification and handling

Camcorder

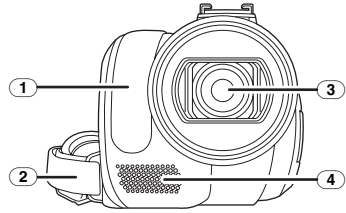

- ① **White balance sensor** -40-
- Remote control sensor** -27-
- ② **Grip belt** -14-
- ③ **Lens (LEICA DICOMAR)**
 - LEICA is a registered trademark of Leica microsystems IR GmbH and DICOMAR is a registered trademark of Leica Camera AG.
- ④ **Microphone (built-in, stereo)** -33-, -36-, -49-

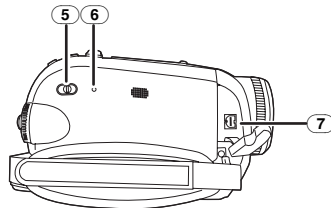

- ⑤ **Mode select switch [AUTO/MANUAL/ FOCUS]** -28-, -38-, -39-, -40-, -41-
- ⑥ **Reset button [RESET]** -71-
- ⑦ **Audio-video/S-Video output terminal [A/V]** -44-, -47-
 - Use the supplied Multi cable only.

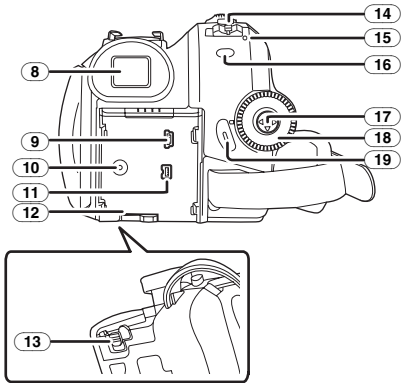

8 Viewfinder -18-, -75-

Due to limitations in LCD production technology, there may be some tiny bright or dark spots on the Viewfinder screen. However, this is not a malfunction and does not affect the recorded picture.

- 9 USB terminal [ψ] -50-, -52-
- 10 DC input terminal [DC/C.C.IN] -15-
- 11 DV input/output terminal [DV] -47-, -48-, -50-, -57-, -60-
- 12 Battery holder
- 13 Battery release lever [BATTERY] -15-
- 14 Power switch [OFF/ON] -16-
- 15 Status indicator -16-
- 16 Menu button [MENU] -24-
- 17 Joystick -22-
- 18 Mode dial -21-
- 19 Recording start/stop button -29-

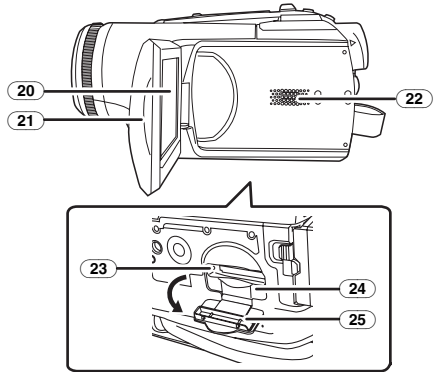

20 LCD monitor -18-, -75-

Due to limitations in LCD production technology, there may be some tiny bright or dark spots on the LCD monitor screen. However, this is not a malfunction and does not affect the recorded picture.

- 21 LCD monitor open part -18-
- 22 Speaker -42-
- 23 Card access lamp -21-
- 24 Card slot -21-
- 25 Card slot cover -20-

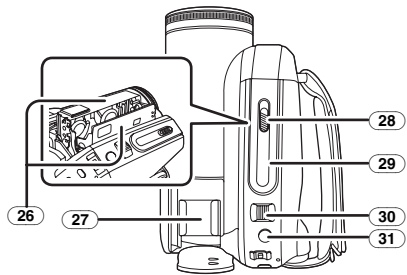

- 26 Cassette holder -20-
- 27 Accessory shoe
 - Accessories, such as a Video DC light (optional), are attached here.
- 28 Cassette eject lever [OPENEJECT] -20-
- 29 Cassette cover -20-
- 30 Zoom lever [W/T] -32-
Volume lever [- \square /VOL+] -42-
- 31 Photoshot button [\square] -30-, -31-

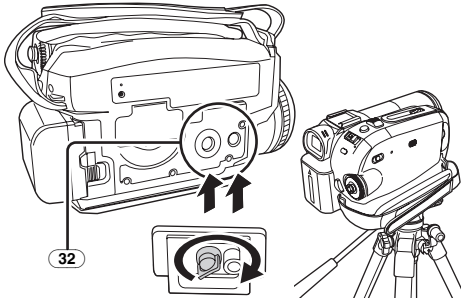

32 Tripod receptacle

This is a hole for attaching the Camcorder to optional tripod. (Please carefully read the operating instructions for how to attach the tripod to the Camcorder.)

- You cannot open the card slot cover when the tripod is used. Insert the card first and then attach the tripod.

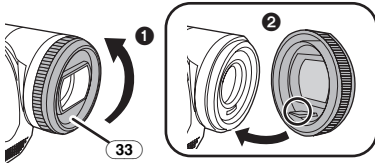

33 Lens hood

In order to remove the lens hood, rotate it counter-clockwise **1**. In order to fit it, place into slot **2** and then rotate it clockwise.

Attaching the lens cap

Fit the lens cap to protect the surface of the lens.

- The lens cap and the lens cap cord come pre-attached to the grip belt.
- When not using the lens cap, pull the lens cap cord in the direction of the arrow. **1**
- When you are not recording, be sure to cover the lens with the lens cap for protection. **2**

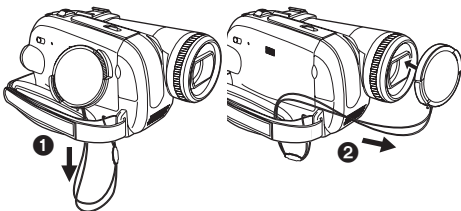

- When you remove the lens cap, press the knobs firmly.

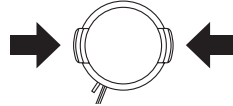

How to remove the Sensor tag (for U.S.A. only)

1 Flip the grip belt.

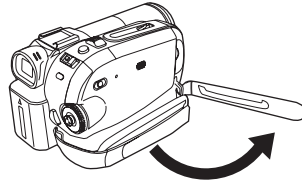

2 Remove the Sensor tag and then fix the grip belt.

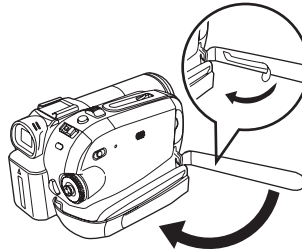

The grip belt

Adjust the belt length so it fits your hand.

1 Adjust the belt length and the pad position.

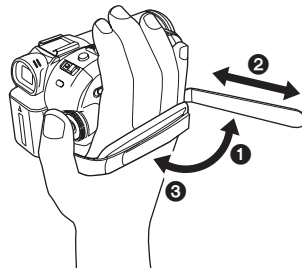

- 1** Flip the belt.
- 2** Adjust the length.
- 3** Fix the belt.

Power supply

■ Charging the battery

When this product is purchased, the battery is not charged. Charge the battery before using this product.

- Battery charging time. (-16-)
- We recommend using Panasonic batteries. (-12-, -79-)
- If you use other batteries, we cannot guarantee the quality of this product.
- If the DC cable is connected to the AC adaptor, then the battery will not get charged. Remove the DC cable from the AC adaptor.

1 Connect the AC cable to the AC adaptor and the AC jack.

2 Put the battery on the battery mount by aligning the mark and then securely plug it in.

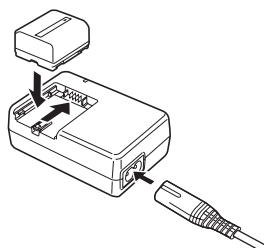

■ Charging lamp

Lights up: Charging

Goes off: Charging completed

Flashing: The battery is over discharged (discharged excessively). In a while, the lamp will light up and normal charging will start.

When the battery temperature is excessively high or low, the [CHARGE] lamp flashes and the charging time will be longer than normal.

CAUTION

Danger of explosion if battery is incorrectly replaced. Replace only with the same or equivalent type recommended by the manufacturer. Dispose of used batteries according to the manufacturer's instructions.

■ Connecting to the AC outlet

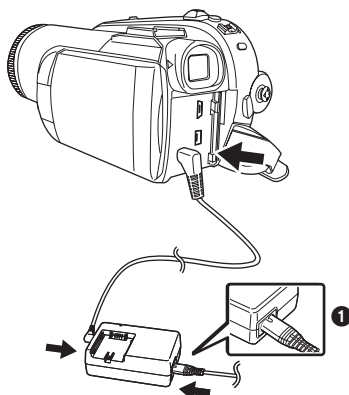

1 Connect the AC cable to the AC adaptor and the AC jack.

2 Connect the DC cable to the AC adaptor.

3 Connect the DC cable to this product.

- The output plug of the AC cable is not completely connected to the AC adaptor jack. As shown in **1**, there is a gap.
- Do not use the power cord for other equipment since the power cord is exclusively designed for this Camcorder. Do not use the power cord from other equipment for this Camcorder.

■ Attaching the battery

Push the battery against the battery holder and slide it until it clicks.

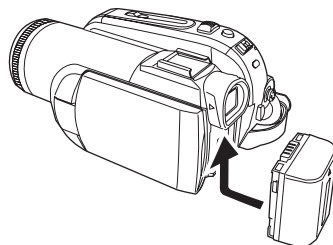

■ Removing the battery

While sliding the [BATTERY] lever, slide the battery to remove it.

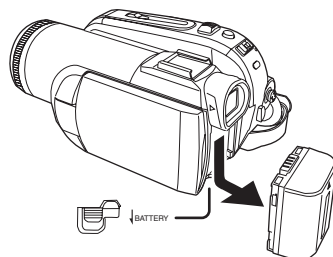

- Hold the battery with your hand so it does not fall.
- Before removing the battery, be sure to set the [OFF/ON] switch to [OFF].

Charging time and recordable time

The times shown in the tables below are for when the temperature is 25 °C (77 °F) and the humidity is 60%. If the temperature is higher or lower than 25 °C (77 °F), the charging time will become longer.

Supplied battery/ CGR-DU06 (7.2 V/ 640 mAh)	Ⓐ	1 h 40 min
	Ⓑ	1 h 15 min (1 h 10 min)
	Ⓒ	30 min (30 min)
CGA-DU12 (7.2 V/ 1150 mAh)	Ⓐ	2 h 25 min
	Ⓑ	2 h 15 min (2 h 05 min)
	Ⓒ	1 h (55 min)
CGA-DU21 (7.2 V/ 2040 mAh)	Ⓐ	3 h 55 min
	Ⓑ	4 h (3 h 45 min)
	Ⓒ	1 h 45 min (1 h 30 min)







- Ⓐ Charging time
- Ⓑ Maximum continuously recordable time
- Ⓒ Actual recordable time

(The actual recordable time refers to the recordable time on tape when repeatedly starting/stopping recording, turning the unit on/off, moving the zoom lever etc.)

“1 h 40 min” indicates 1 hour 40 minutes.

- The battery CGR-DU06 is supplied.
- The charging time and recordable time shown in the table are approximations. The times indicate the recordable time when the viewfinder is used. The times in parentheses indicate the recordable time when the LCD monitor is used.
- We recommend the Battery Pack CGA-DU12 and CGA-DU21 for long recording time (2 hours or more for continuous recording, 1 hour or more for actual recording).

- The actual time may become shorter than this. The recordable time shown in the table are approximations. The recordable time will become shorter in the following cases:
 - When you use both the viewfinder and the LCD monitor simultaneously while rotating the LCD monitor frontward to record yourself, etc.

- When you use this Camcorder with the LCD monitor lit up with the [POWER LCD] setting.
- The batteries heat up after use or charging. The main unit of the Camcorder being used will also heat up. This is normal.
- Along with the reduction of the battery capacity, the display will change:  →  →  → . If the battery discharges, then  () will flash.

Turning the Camcorder on

When the Camcorder is turned on with the lens cap attached, the automatic white balance adjustment (-75-) may not function properly. Please turn the Camcorder on after removing the lens cap.

How to turn on the power

- 1 While pressing the button , set the [OFF/ON] switch to [ON].

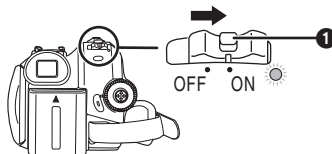

- The Status indicator lights red and the power turns on.
- In Tape Recording Mode or Card Recording Mode, if the [OFF/ON] switch is set to [ON] while the LCD monitor is closed and the viewfinder is retracted, the power turns off.

How to turn off the power

- 1 While pressing the button , set the [OFF/ON] switch to [OFF].

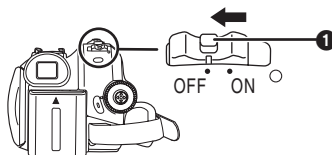

- Set the [OFF/ON] switch to [OFF] when not using the Camcorder.
- The Status indicator goes off when the power turns off.

■ How to turn the power on and off with the LCD monitor/viewfinder

When the power switch is set to [ON], the power can be turned on and off with the LCD monitor and the viewfinder when the unit is in Tape Recording Mode or Card Recording Mode.



1 Open the LCD monitor out or extend the viewfinder to use. (-18-)

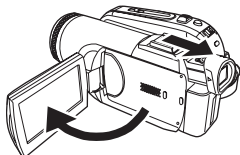

- The LCD monitor or viewfinder will be activated.

2 Close the LCD monitor and retract the viewfinder.

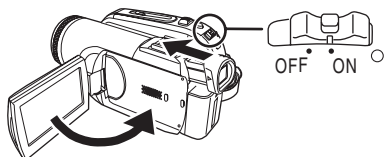

- The power will not turn off unless the LCD monitor is closed and the viewfinder is retracted.
- The Status indicator automatically goes off and the power turns off. (If quick start is set to [ON] (-19-), the unit goes into quick start standby mode and the Status indicator lights green.)
- The power does not turn off even if the LCD monitor is closed and the viewfinder is retracted while recording on a tape.

3 Open the LCD monitor or extend the viewfinder to turn the power on and use the Camcorder again.

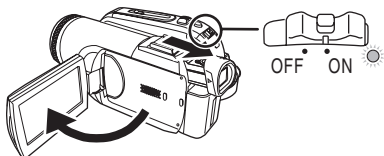

- The Status indicator lights red and the power turns on.

Setting date and time

When the Camcorder is turned on for the first time, [SET DATE AND TIME] will appear.

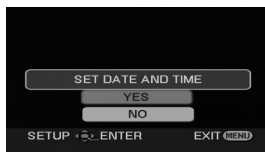

- Select [YES] and press the center of the joystick. Perform steps 2 and 3 below to set the date/time.

If the screen shows the incorrect date/time, then adjust it.

• Set to Tape Recording Mode or Card Recording Mode.

1 Set [BASIC] >> [CLOCK SET] >> [YES]. (-24-)



2 Move the joystick left or right in order to select the item to be set. Then move the joystick up or down to set the desired value.

- The year will change as follows:
2000, 2001, ..., 2089, 2000, ...
- The 12-hour clock is used.

3 Press the joystick to determine the setting.

- The clock function starts at [00] seconds.

■ About date/time

- The date and time function are driven by a built-in lithium battery.
- Make sure to check the time before recording.

■ Recharging the built-in lithium battery

- If [⊕] or [-] is appears when the Camcorder is turned on, then the built-in lithium battery has run down. Use the steps below to charge the battery. When turning on the power for the first time after charging, [SET DATE AND TIME] will appear. Select [YES] and set the date and time. Connect the AC adaptor to the Camcorder or attach the battery to the Camcorder and the built-in lithium battery will be recharged. Leave the Camcorder as is for approx. 24 hours and the battery will drive the date and time for approx. 6 months. (Even if the [OFF/ON] switch is set to [OFF], the battery is still being recharged.)

Using the LCD monitor

You can record the image while viewing it on the opened LCD monitor.

- 1 Pull the LCD monitor out in the direction of the arrow.

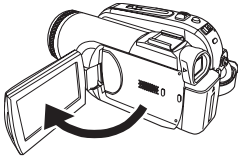

- It can open up to 90°.

- 2 Adjust the angle of the LCD monitor according to your preference.

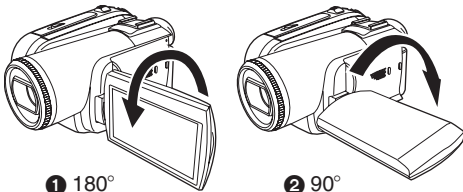

1 180°

2 90°

- It can rotate up to 180° 1 towards the lens or 90° 2 towards the viewfinder.

- The brightness and color level of the LCD monitor can be adjusted from the menu.
- If it is forcibly opened or rotated, the Camcorder may be damaged or fail.
- If the LCD monitor is rotated by 180° towards the lens and the viewfinder is extended (when recording yourself), the LCD monitor and the viewfinder simultaneously light.

Using the viewfinder

■ Extending the viewfinder

- 1 Pull out the viewfinder and extend it by pinching the extension knob.

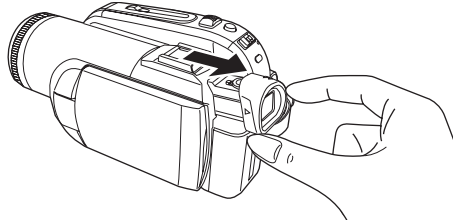

- The viewfinder will be activated. (If the LCD monitor is opened, the viewfinder will be deactivated.)

■ Adjusting the field of view

- 1 Adjust the focus by sliding the eyepiece corrector knob.

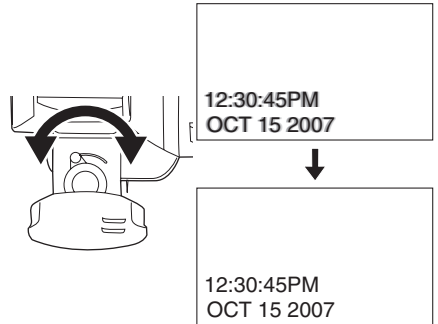

- You can adjust the brightness of the viewfinder from the menu.

Quick Start

When Quick Start is ON the battery power is still being consumed, even when the LCD Monitor and the Viewfinder are closed.

The Camcorder will resume recording/pause mode about 1.7 seconds after the LCD Monitor and the Viewfinder are reopened.

- Please note in Quick Start Mode approximately half the pause recording power is being consumed.

Using Quick Start Mode will reduce the battery recording/playback time.

- This is only activated in the following cases.
 - While using the battery
 - A tape or a card is inserted, while the Tape Recording Mode is set.
 - A card is inserted, while the Card Recording Mode is set.
 - While using the AC adaptor
 - Quick Start can be used even if a tape/card is not inserted.

• Set to Tape/Card Recording Mode.

1 Set [SETUP] >> [QUICK START] >> [ON].

(-24-)

2 While the [OFF/ON] switch is still set to [ON], close the LCD monitor and retract the Viewfinder.

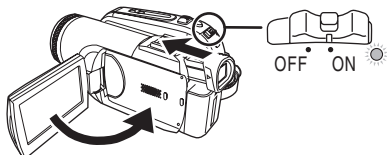

- The Status indicator lights green and the unit goes into quick start standby mode.
- The Camcorder will not go into quick start standby mode unless the LCD monitor is closed and the viewfinder is retracted.

3 Open the LCD monitor or extend the Viewfinder.

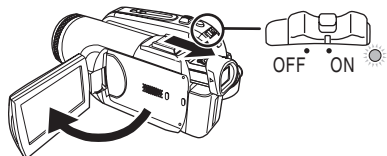

- The Status indicator lights red and the Camcorder is put into recording pause approx. 1.7 seconds after it is turned on.

■ To cancel Quick Start

1 Set [SETUP] >> [QUICK START] >> [OFF].

(-24-)

- If the [OFF/ON] switch is set to [OFF] while the unit is in quick start standby mode, the power turns off.
 - If the standby continues for approx. 30 minutes, then the Status indicator will go off and the Camcorder will be completely turned off.
-
- In the following cases, quick start is canceled and the power turns off.
 - When the Mode dial is moved.
 - When the battery or AC adaptor is removed.
 - When both the tape and card are removed while using the battery in Tape Recording Mode.
 - When the card is removed while using the battery in Card Recording Mode.

- When the Camcorder is quick-started with the white balance on automatic, it may take some time until the white balance is adjusted if the scene being recorded has a light source different from the scene last recorded. (When the MagicPix function is used, however, the white balance of the scene last recorded is retained.)

- If the power is turned on in quick start standby mode, the zoom magnification becomes 1X and the picture size may differ from what it was before quick start standby.

- If [POWER SAVE] (-29-) is set to [5 MINUTES] and the unit automatically goes into quick start standby mode, set the [OFF/ON] switch to [OFF], then to [ON] again. Also, close the LCD monitor and retract the viewfinder and then open the LCD monitor or extend the viewfinder again.

Inserting/removing a cassette

- 1 Fit the AC adaptor or the battery and turn on the power.
- 2 Slide the [OPEN/EJECT] lever and open the cassette cover.



- When the cover is fully opened, the cassette holder will come out.

- 3 After the cassette holder is opened, insert/remove the cassette.

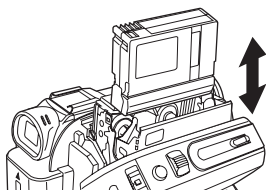

- When inserting a cassette, orient it as shown in the figure and then securely insert it as far as it goes.
- When removing, pull it straight out.

- 4 Push the [PUSH] mark ① in order to close the cassette holder.

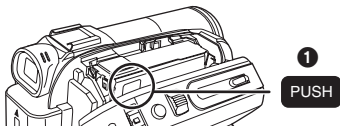

- The cassette holder is housed.

- 5 Only after the cassette holder is completely housed, close the cassette cover tightly.

- When inserting a previously recorded cassette, use the blank search function to find the position where you want to continue recording. If you are overwriting a previously recorded cassette, be sure to find the position where you want to continue recording.
- When closing the cassette cover, do not get anything, such as a cable, caught in the cover.
- After use, be sure to rewind the cassette completely, remove it and put it in a case. Store the case in an upright position. (-74-)
- If the indicator of the condensation does not display on the LCD screen and/or EVF and you notice condensation on the lens or the main unit, do not open the cassette cover otherwise

condensation may be formed on the heads or the cassette tape. (-72-)

■ When the cassette holder does not come out

- Close the cassette cover completely and then open it again completely.
- Check if the battery has run down.

■ When the cassette holder cannot be housed

- Set the [OFF/ON] switch to [OFF], then to [ON] again.
- Check if the battery has run down.

■ Accidental erasure prevention

If the accidental erasure prevention slider ① of a cassette is opened (slide in the direction of the [SAVE] arrow), the cassette cannot be recorded. When recording, close the accidental erasure prevention slider of the cassette (slide in the direction of the [REC] arrow).

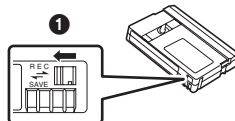

Inserting/removing a card

Before inserting/removing a card, set the [OFF/ON] switch to [OFF].

- If the card is inserted or removed with the power turned on, this Camcorder may malfunction or the data recorded on the card may be lost.

- 1 Turn off the power ①.

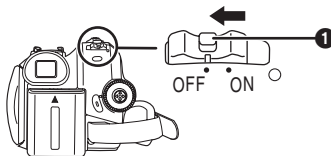

- Check that the Status indicator has gone off.

- 2 Open the card slot cover.

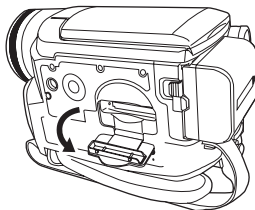

3 Insert/remove the card into/from the card slot.

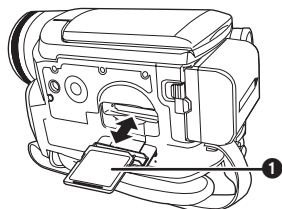

- When inserting a card, face the label side ❶ towards you and push it straight in with one stroke as far as it goes.
- When removing the card, press the center of the card and then pull it straight out.

4 Securely close the card slot cover.

Concerning the card

- Do not format the card with another Camcorder or any personal computer. This operation may make the card unusable.
- 4 GB Memory Cards must be SDHC Memory Cards.
- Memory Cards greater than 4 GB without the SDHC Logo are not compliant with the SD specifications.

Card access lamp

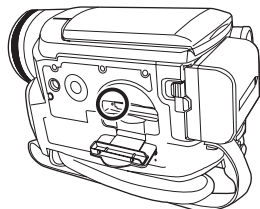

- When the Camcorder accesses the card (reading, recording, playback, erasing, etc.), the access lamp lights up.
- If the following operations are performed when the access lamp is lit, then the card or the recorded data may be damaged or the Camcorder may malfunction.
 - Inserting or removing the card.
 - Operating the [OFF/ON] switch or the mode dial.
 - Removing the battery or AC adaptor.

SD Card

- The memory capacity indicated on the SD Card label corresponds to the total amount of capacity to protect and manage the copyright and the capacity available as conventional memory for a Camcorder, personal computer or other equipment.

This unit is compatible with both SD Memory cards and SDHC Memory cards. You can only use SDHC Memory cards on devices that are compatible with them. You cannot use SDHC Memory cards on devices that are only compatible with SD Memory cards. (When using a SDHC Memory card on another device, be sure to read the operating instructions for that device.)

Concerning the write protection switch on the SD Card

- The SD Card has a write protection switch on it. If the switch is moved to [LOCK], you cannot write to the card, erase the data on it or format it. If it is moved back, you can.

Selecting a mode

Rotate the mode dial to select the desired mode.

1 Rotate the mode dial.

- Set your desired mode to ❶.

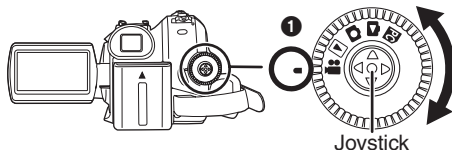

TAPE RECORDING MODE

Use this when you record the image on a tape. (Also, you can simultaneously record still pictures on a card while recording images on a tape.)

TAPE PLAYBACK MODE

Use this to play back a tape.

CARD RECORDING MODE

Use this to record still pictures on a card.

CARD PLAYBACK MODE

Use this to play back the still pictures recorded on a card.

PC CONNECTION MODE

You can view or edit the still pictures recorded on a card on your personal computer. -53-

How to use the joystick

Basic joystick operations

Operations on the menu screen and selection of files to be played back on the multi-image display

Move the joystick up, down, left or right to select an item or file and then push in the center to set it.

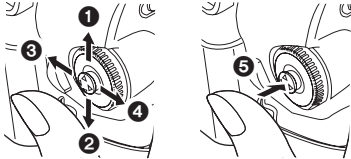

1	Select by moving up.
2	Select by moving down.
3	Select by moving left.
4	Select by moving right.
5	Set by pushing the center.

Joystick and screen display

Push the center of the joystick and icons will be displayed on the screen. Each time the joystick is moved down, the indication changes.

(In the Tape playback mode or the Card playback mode, the icons will be automatically displayed on the screen.)

1) Tape recording mode ([AUTO/MANUAL/FOCUS] switch is set to [AUTO])

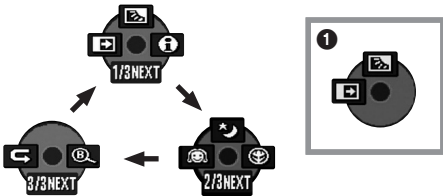

1/3	◀	☐	Fade	-35-
	▲	☐	Backlight compensation	-33-
	▶	ⓘ	Help mode	-23-
2/3	◀	☺	Soft skin mode	-34-
	▶	⊕	Tele macro	-35-
	▲	☆	MagicPix	-34-
3/3	◀	Ⓜ	Recording check	-30-
	▶	🔍	Blank search	-30-

● 1 is displayed while recording on a tape.

2) Tape recording mode ([AUTO/MANUAL/FOCUS] switch is set to [MANUAL])

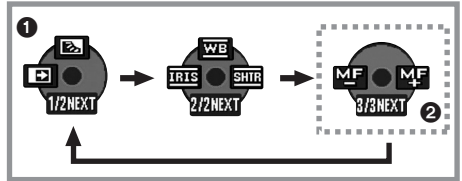
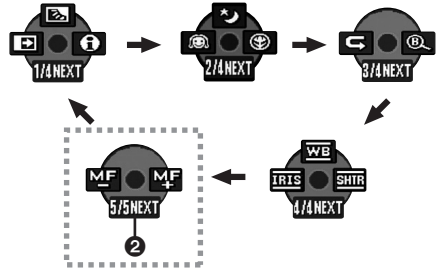

4/4	◀	IRIS	Iris or gain value	-41-
	▲	WB	White balance	-39-
	▶	SHTR	Shutter speed	-41-
5/5	◀	MF	Manual focus adjustment	-40-
	▶	MF+		

- 1 is displayed while recording on a tape.
- 2 is displayed only when the ([AUTO/MANUAL/FOCUS] switch is set to [FOCUS]).

3) Tape playback mode



	▲	⏪	Playback/pause	-42-
	▼	■	Stop	-42-
	◀	⏮	Rewind (review playback)	-42-
	▶	⏭	Fast forward (cue playback)	-42-

4) Card recording mode
 ([AUTO/MANUAL/FOCUS] switch is set to [AUTO])

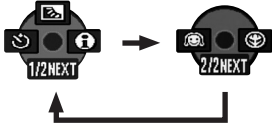

1/2	◀	🕒	Self-timer recording	-37-
	▲	📷	Backlight compensation	-33-
	▶	📌	Help mode	-23-
2/2	◀	😊	Soft skin mode	-34-
	▶	📷	Tele macro	-35-

5) Card recording mode
 ([AUTO/MANUAL/FOCUS] switch is set to [MANUAL])

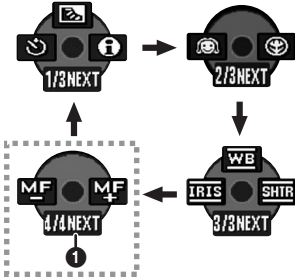

3/3	◀	IRIS	Iris or gain value	-41-
	▲	WB	White balance	-39-
	▶	SHTR	Shutter speed	-41-
4/4	▶	MF	Manual focus adjustment	-40-

• 1 is displayed only when the ([AUTO/MANUAL/FOCUS] switch is set to [FOCUS]).

6) Card playback mode



	▲	📷	Slide show start/pause	-44-
	▼	🗑️	Delete	-45-
	◀	◀	Playback the previous picture	-44-
	▶	▶	Playback the next picture	-44-

Help mode

Select an icon for an explanation of the function.

• Set to Tape/Card Recording Mode.

1 Press the joystick to display the icon during the recording pause. Move the joystick down until icon 1 appears.



2 Move the joystick right to select the Help mode icon [📌].

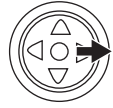

• The help mode explains the operation icons that are displayed when the [AUTO/MANUAL/FOCUS] switch is set to [AUTO] in Tape/Card Recording Mode.

3 Move the joystick up, left or right to select the desired icon.

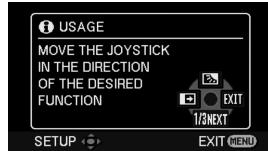

• An explanation of the selected icon is displayed on the screen.

• Each time the joystick is moved down, the indication changes.

■ To exit the Help mode

Select [EXIT] icon or press the [MENU] button.

• When the Help mode is used, it is not possible to record or set the functions.

Switching the language

You can switch the language on the screen display or the menu screen.

1 Set [LANGUAGE] >> select the desired language.



Using the menu screen

For each individual menu, please refer to -63-.

1 Press the [MENU] button.

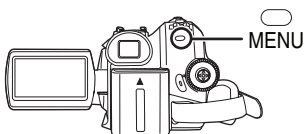

- The menu corresponding to the mode selected by the mode dial is displayed.
- Do not switch the mode dial when the menu is displayed.

2 Move the joystick up or down in order to select the top menu.



3 Move the joystick right or press it to set the selection.



4 Move the joystick up or down in order to select the sub-menu.

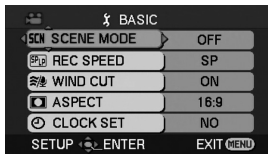

5 Move the joystick right or press it to set the selection.



6 Move the joystick up or down in order to select the item to be set.

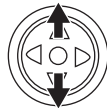
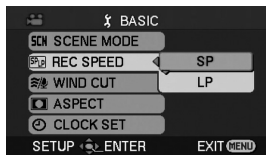

7 Press the joystick to determine the setting.



■ To exit the menu screen

Press the [MENU] button.

■ To get back to the previous screen

Move the joystick left.



■ About the menu setting

- The menu is not displayed while recording on a tape or a card. Also, you cannot record on a tape or a card while the menu is displayed.

■ Operating with remote control

The menu screen transition is the same as when the buttons on the main unit are used.

1 Press the [MENU] button.

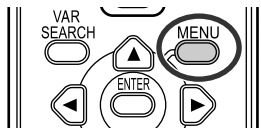

2 Select a menu item.

- Use the direction buttons (▲, ◀, ▶, ▼) and [ENTER] button in place of the joystick on the main unit.

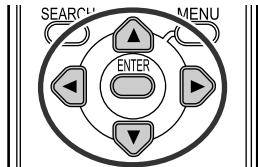

3 Press the [MENU] button to exit the menu screen.

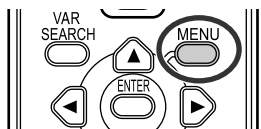

Adjusting LCD monitor/viewfinder

■ Adjusting the brightness and color level

1 Set [SETUP] >> [LCD SET] or [EVF SET] >> [YES].

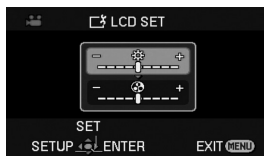

2 Move the joystick up or down in order to select the item to be adjusted.

[LCD SET]

☼ : Brightness of the LCD monitor

⊗ : Color level of the LCD monitor

[EVF SET]

☼ : Brightness of the viewfinder

3 Move the joystick left or right to move the bar indication representing the brightness.

4 Press the [MENU] button or the joystick to complete the settings.

- When the LCD monitor is rotated by 180° towards the lens, the brightness of the LCD monitor cannot be adjusted.
- To adjust the brightness of the viewfinder, close the LCD monitor and extend the viewfinder to activate it.
- These settings will not affect the images actually recorded.

■ In order to increase the brightness of the entire LCD monitor

1 Set [SETUP] >> [POWER LCD] >> [ON].

- The [] indication appears on the LCD monitor.
- If the [POWER LCD] is set to [ON], the entire LCD monitor will become approx. twice as bright as usual.

- To cancel the [POWER LCD] function, set [SETUP] >> [POWER LCD] >> [OFF].
- This will not affect the images to be recorded.
- If you turn on the Camcorder when the AC adaptor is used, the [POWER LCD] function will automatically be activated.
- You cannot use this function in PC Connection Mode.

Using the remote control

Remote control

Using the remote control supplied will enable control of almost all functions of this Camcorder.

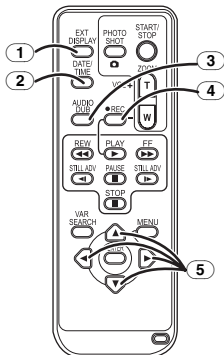

- ① On-screen display button [EXT DISPLAY] -44
- ② Date/time button [DATE/TIME] -65-
- ③ Audio dubbing button [AUDIO DUB] -49-
- ④ Record button [●REC] -48-
- ⑤ Direction buttons [▲, ◀, ▶, ▼] -25-

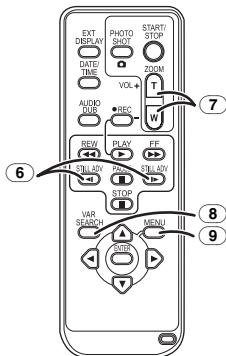

- ⑥ Slow/frame-by-frame forward buttons [◀, ▶] (◀: reverse, ▶: forward) -43-
- ⑦ Zoom/volume button [ZOOM/VOL] *
- ⑧ Search button [VAR SEARCH] -43-
- ⑨ Menu button [MENU] *-25-

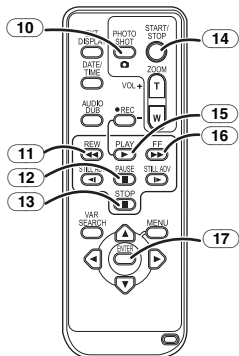

- ⑩ Photoshot button [PHOTO SHOT] *
- ⑪ Rewind/review button [◀◀]
- ⑫ Pause button [||]
- ⑬ Stop button [■]
- ⑭ Recording start/stop button [START/STOP] *
- ⑮ Playback button [▶▶]
- ⑯ Fast forward/cue button [▶▶▶]
- ⑰ Enter button [ENTER] -25-

* means that these buttons function in the same manner as the corresponding buttons on the Camcorder.

Install a button-type battery

Install the button-type battery supplied in the remote control before using it.

- 1 While pressing the stopper ①, pull out the battery holder.

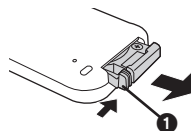

- 2 Set the button-type battery with its (+) mark facing upward and get the battery holder back in place.

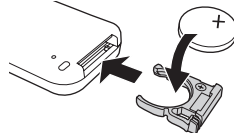

CAUTION

Danger of explosion if battery is incorrectly replaced. Replace only with the same or equivalent type recommended by the manufacturer. Dispose of used batteries according to the manufacturer's instructions.

Replace battery with Panasonic PART NO. CR2025 only. Use of another battery may present a risk of fire or explosion.
 Caution: Battery may explode if mistreated.
 Dispose of used battery promptly. Keep away from children.
 Do not recharge, disassemble or dispose of in fire.

■ Remote control usable range

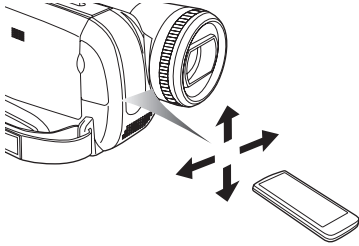

- The distance between the remote control and the Camcorder: Within approx. 5 m (16 feet)
 Angle: Approx. 10° up and 15° down, left and right.

■ Selecting the remote control mode

If 2 Camcorders are used simultaneously, set the mode for one pair of Camcorder and remote control to [VCR1] and that of the other pair to [VCR2]. This will prevent interference between the 2 pairs. (The default setting is [VCR1]. When the button-type battery is replaced, the setting will revert to the default [VCR1].)

1 Setting on the Camcorder:

Set [SETUP] >> [REMOTE] >> [VCR1] or [VCR2].

2 Setting on the remote control:

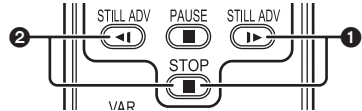

[VCR1]:

Press [▶] and [■] simultaneously. ①

[VCR2]:

Press [◀] and [■] simultaneously. ②

■ Concerning the button-type battery

- When the button-type battery runs down, replace it with a new battery (part number: CR2025). The battery is normally expected to last about 1 year, but it depends on operation frequency.
 - Keep the button-type battery out of the reach of children.
-
- If the remote control mode of the Camcorder and that of the remote control do not match with each other, "REMOTE" will appear. When the remote control is operated for the first time after the Camcorder is turned on, "CHECK REMOTE MODE" (-67-) will appear and operation is impossible. Set the same remote control mode.
 - The remote control is intended for indoor operation. Outdoors or under strong light, the Camcorder may not operate properly even within the usable ranges.

Record mode

Check before recording

Check the following before recording important events such as weddings or when the Camcorder has not been used for a long time.

Conduct a test recording to make sure that the image recording and the audio recording work properly.

Basic Camcorder positioning

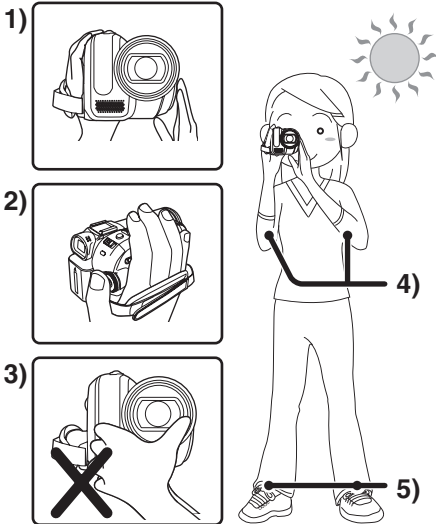

- 1) Hold the Camcorder with both hands.
- 2) Run your hand through the grip belt.
- 3) Do not cover the microphones or sensors with your hands.
- 4) Keep your arms near your body.
- 5) Slightly open your legs.

- When you are outdoors, record pictures with the sunlight as far in the background as possible. If the subject is backlit, it will become dark in the recording.

Check points

- Remove the lens cap. (-14-)
(When the Camcorder is turned on with the lens cap attached, the automatic white balance adjustment may not function properly. Please turn the Camcorder on after removing the lens cap.)
- Grip belt adjustment (-14-)
- Open the LCD monitor or extend the viewfinder. (Recording cannot start while the LCD monitor is closed and the viewfinder is retracted. Even if the LCD monitor and viewfinder are closed during recording, the power will not turn off until recording stops.)

- Adjusting LCD monitor/viewfinder (-25-)
- Power supply (-15-)
- Insert a cassette/card (-20-)
- Setting date/time (-17-)
- Getting the remote control ready (-26-)
- Setting SP/LP mode (-28-)

About auto mode

- Set the [AUTO/MANUAL/FOCUS] switch to [AUTO] and color balance (white balance) and focusing will be adjusted automatically.
 - Auto white balance: -75-
 - Auto focusing: -76-
- Depending on the brightness of the subject etc., the aperture and shutter speed are automatically adjusted for an optimum brightness. (When set to the tape recording mode: The shutter speed is adjusted to a maximum of 1/250.)
- Color balance and focus may not be adjusted depending on light sources or scenes. If so, manually adjust the white balance and focus.

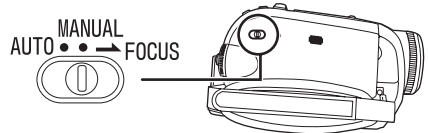

- Scene mode setting (-38-)
- White balance setting (-39-)
- Shutter speed setting (-41-)
- Iris/gain value setting (-41-)
- Focus setting (-40-)

Recording mode

You can switch the tape recording mode.

- Set to Tape Recording/Playback Mode.

1 Set [BASIC] or [ADVANCED] >> [REC SPEED] >> [SP] or [LP].

If the LP mode is selected, the recording time will be 1.5 times the SP mode, but some functions will be disabled.

- We recommend using the SP mode for important recording.
- In order to fully exhibit the performances of the LP mode, we recommend using Panasonic cassettes marked LP mode.
- It is not possible to dub audio onto image recorded in the LP mode. (-49-)
- In the LP mode, the picture quality will not be degraded in comparison with the SP mode, but mosaic noise may appear on the playback image or some functions may be disabled.
 - Playback on other digital video equipment or on digital video equipment without the LP mode.
 - Playback of the image on other digital video equipment recorded in the LP mode.
 - Slow/frame-by-frame playback.

Recording on a tape

Remove the lens cap. (-14)

(When the Camcorder is turned on with the lens cap attached, the automatic white balance adjustment may not function properly. Please turn the Camcorder on after removing the lens cap.)

When this unit is purchased, the aspect ratio is set to [16:9] for recording images compatible with a wide-screen TV. To make this unit compatible with regular TVs (4:3), change the [ASPECT] setting before recording the images (-37-) or change the [TV ASPECT] setting when watching them on the connected TV (-44-).

● Set to Tape Recording Mode.

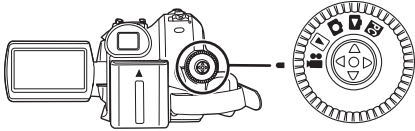

1 Press the recording start/stop button to start recording.

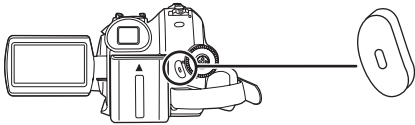

2 Press the recording start/stop button again to pause recording.



- For the recording time on a tape, refer to -16-.
- Carry out a recording check (-30-) to verify that the image is recorded properly.
- In order to find the unrecorded section, carry out the blank search (-30-).
- If you want to preserve the original sound recorded when audio dubbing (-49-), set [ADVANCED] >> [AUDIO REC] >> [12bit] to take pictures.

■ On-screen display in the tape recording mode

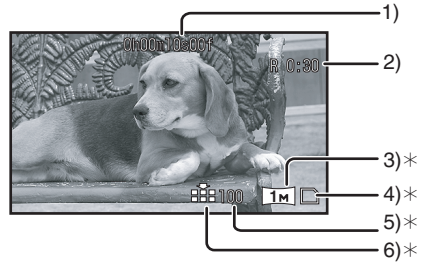

*These are only displayed when you press the Photoshot button [] halfway while a card is inserted. These are not displayed when using the remote control.

- 1) Recording time elapse
- 2) Remaining tape time indication
- 3) Still picture size
- 4) Card indication (-66-)
- 5) Number of recordable still pictures (When no picture can be recorded, this indication will flash in red.)
- 6) Quality of still pictures

■ Concerning the remaining tape time indication on the screen

- The remaining tape time is indicated in minutes. (When it reaches less than 3 minutes, the indication starts flashing.)
- During a 15-second or shorter recording, the remaining tape time indication may not be displayed or the remaining tape time may not be displayed correctly.
- In some cases, the remaining tape time indication may display remaining tape time that is 2 to 3 minutes shorter than the actual remaining tape time.

■ [POWER SAVE]

[OFF]:

When 5 minutes passes without any operation, the standby mode will be automatically set. In the standby mode, [] blinks and it takes more time than usual to start recording after you press the recording start/stop button.

[5 MINUTES]: When 5 minutes passes without any operation, the Camcorder automatically turns off to protect the tape or to prevent the battery from running down. When you want to use the Camcorder, turn it on again.

● In the following cases, the power may not turn off even when [POWER SAVE] >> [5 MINUTES] is set.

- When connected to the AC outlet (When using the AC adaptor)

- When connected with the USB cable or the DV cable to a personal computer or other equipment
- When in PC Connection Mode

Recording check

The last image recorded is played back for 2 to 3 seconds. After checking, the Camcorder will be set to a recording pause.

•Set to Tape Recording Mode.

- 1 Press the joystick to display the icon during the recording pause. Move the joystick down until icon ❶ appears.
- 2 Move the joystick left to select the recording check icon [⏮].



- The [RECORDING CHECK STARTED] indication appears on the screen of the Camcorder.

Blank search function

Searches for the last part of the image recorded (unused part of the tape). After the search is finished, the blank search function is canceled and the Camcorder is put into recording pause.

•Set to Tape Recording Mode.

- 1 Press the joystick to display the icon during the recording pause. Move the joystick down until icon ❶ appears.
- 2 Move the joystick right to select the blank search icon [Ⓜ].



- 3 When the confirmation message appears, select [YES] and press the center of the joystick.

Stopping blank search midway through

Move the joystick down to select the [■] icon.

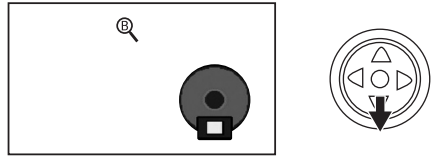

- If the cassette tape has no blank part, then the Camcorder will stop at the end of the tape.
- The Camcorder stops at a point approx. 1 second before the end of the last image recorded. When you start recording at that point, the image can be recorded seamlessly from the last image.

Recording still pictures on a card while recording image onto a tape

You can record still pictures while recording image onto a tape.

•Set to Tape Recording Mode.

- 1 Press the Photoshot button [📷] fully while recording image onto a tape.

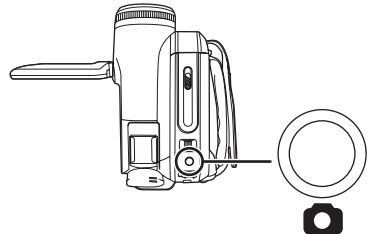

- For the number of still pictures that can be recorded on a card, refer to -78-.
- When recording pictures onto a card, the recording start/stop button is disabled.
- You can select the picture quality for still pictures to be recorded. (-32-)
- In order to record higher quality still pictures, you must use the card recording mode.
- When recording still pictures, hold the Camcorder firmly with your hands and keep your arms stationary at your side so as not to shake the Camcorder.

Select the size of still pictures to be recorded on a card in Tape Recording Mode

- 1 Set [ADVANCED] >> [PICTURE SIZE] >> select the desired picture size.

ASPECT [16:9]:

1M :1280×720

0.2M :640×360

ASPECT [4:3]:

1M: 1280×960**0.3M**: 640×480

Recording still pictures onto a card (Photoshot)

● Set to Card Recording Mode.

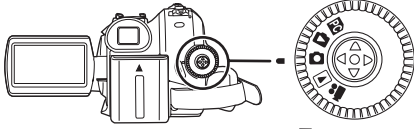

1 Press the Photoshot button [P] halfway in order to adjust focusing.

(For auto focusing only)

- If you set [O.I.S.] to [ON], then the image stabilizer function will be more effective. ([MEGA] (MEGA Optical image stabilizer)) will be indicated.)
- The iris/gain value is fixed and this Camcorder focuses on the subject automatically.

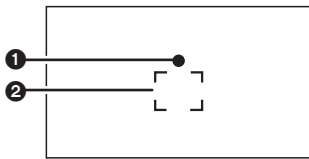
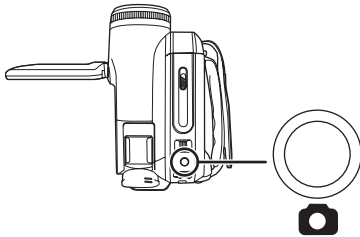

- 1 Shutter chance mark
○ (The white lamp flashes.):
Focusing
 - (The green lamp lights up.):
When in focus
- No mark: When focusing is unsuccessful
- The shutter chance mark is indicated as follows when the Photoshot button [P] is not pressed halfway. Please use it as a guide for recording.
 - (The green lamp lights up.):
When in focus and a good picture can be recorded
 - (The white lamp lights up.):
Almost in focus
- 2 Focus area

2 Press the Photoshot button [P] fully.

■ To record still pictures clearly

- When zooming in on the subject with a magnification of 4× or higher, it is difficult to reduce the slight shaking from holding the Camcorder by hand. We recommend decreasing the zoom magnification and approaching the subject when recording.
- When recording still pictures, hold the Camcorder firmly with your hands and keep your arms stationary at your side so as not to shake the Camcorder.
- You can record stable pictures without shaking by using a tripod and the remote control.

- For the number of still pictures that can be recorded on a card, refer to -78-.
- Moving pictures and sound cannot be recorded onto a card.
- While data is being recorded on a card, do not operate the mode dial.
- When the access lamp is lit, do not remove the card.
- Another product may degrade or not play back data recorded on this Camcorder.
- If you set [PICT.QUALITY] >> [MOSAIC], mosaic-pattern noise may appear on a playback image depending on the picture content.
- When the [PICTURE SIZE] is set to other than [0.2M] or [0.3M], the mega pixel recording mode is set.
- It is not possible to press the [PHOTO SHOT] button on the remote control halfway.

■ On-screen display in the card recording mode

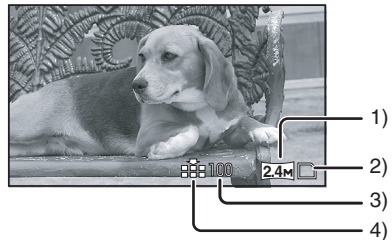

- 1) Still picture size
- 2) Card indication (-66-)
- 3) Number of recordable still pictures (When no picture can be recorded, this indication will flash in red.)
- 4) Quality of still pictures

■ Select the size of still pictures to be recorded on a card

1 Set [BASIC] >> [PICTURE SIZE] >> select the desired picture size.

ASPECT [16:9]:

2.4M: 2048×1152**0.2M**: 640×360

ASPECT [4:3]:

3.M: 2048×1512

2.M: 1600×1200

1.M: 1280×960

0.3.M: 640×480

- When you purchase this unit, [ASPECT] is set to [16:9]. The sides of pictures recorded when [16:9] is set may be cut at printing. Check before printing.

■ Select the picture quality for photoshot images

1 Set [BASIC] >> [PICT.QUALITY] >> select the desired picture quality.

[]: High picture quality

[]: Normal picture quality

- You can also change the picture quality on [ADVANCED] >> [PICT.QUALITY] in the tape recording mode.

■ Recording with a shutter operation effect

You can add a shutter operation simulating sound.

1 Set [ADVANCED] >> [SHTR EFFECT] >> [ON].

■ About the shutter chance mark

- The shutter chance mark does not appear in manual focus mode.
- When the subject is not easily focused, focus on the subject manually.
- You can record still pictures on the card even if the shutter chance mark does not appear, but pictures may be recorded without being focused.
- The shutter chance mark does not appear or has difficulty displaying in the following cases.
 - When the zoom magnification is high.
 - When the Camcorder is shaken.
 - When the subject is moving.
 - When the subject stands in front of a light source.
 - When close subjects and far subjects are included in the same scene.
 - When the scene is dark.
 - When there is a bright part in the scene.
 - When the scene is filled with only horizontal lines.
 - When the scene lacks contrast.
 - When recording on tape.

■ Concerning the focusing area

- When there is a contrasting object ahead or behind the subject in the focus area, the subject may not be focused. If so, move the contrasting object out of the focus area.
- Even when it is still difficult to focus, adjust the focus manually.

Zoom in/out function

You can zoom in up to 10× optically.

● Set to Tape/Card Recording Mode.

1 Wide-angle recording (zoom out):

Push the [W/T] lever towards [W].

Close-up recording (zoom in):

Push the [W/T] lever towards [T].

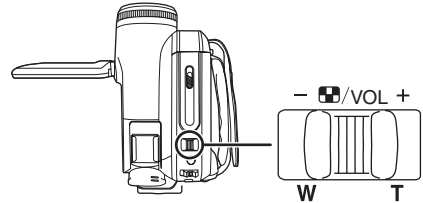

- When zooming in and taking a picture while holding the Camcorder by hand, we recommend using the image stabilizer function.
- When you are zooming in on a faraway subject, a sharper focus is achieved if the recording subject is 1 m (3.3 feet) or further from the Camcorder.
- When the zoom speed is high, the subject may not be focused easily.
- When the zoom magnification is 1×, the Camcorder can focus on a subject approx. 4 cm (1.6 inches) away from the lens.
- Be aware that a mechanical sound may be recorded when the [W/T] lever is released while zooming. Gently move the zoom lever back to its original position before releasing it.

Digital zoom function

If the zoom magnification exceeds 10 times, then the digital zoom function will be activated. The digital zoom function allows you to select a magnification from 25× to 700×.

● Set to Tape Recording Mode.

- 1 Set [ADVANCED] >> [D.ZOOM] >> [25×] or [700×].

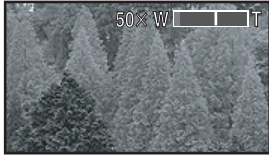

[OFF]: Optical zoom only (Up to 10×)

[25×]: Digital zoom (Up to 25×)

[700×]: Digital zoom (Up to 700×)

- The larger the digital zoom magnification, the more the image quality is degraded.
- When the Card Recording mode is used, the digital zoom function cannot be used.

About the variable speed zoom function

- The zoom speed varies according to the amount of movement of the [W/T] lever.
- The variable speed zoom function cannot be used with the remote control.

To use the zoom microphone function

Interlocked with the zooming operation, the microphone will clearly capture sounds far away with the tele-shot or those in the vicinity with the wide-angle shot.

● Set to Tape Recording Mode.

- 1 Set [ADVANCED] >> [ZOOM MIC] >> [ON].



Recording yourself

You can record yourself while viewing the LCD monitor. You can record persons in front of the Camcorder while presenting them the image. The image is horizontally flipped as if you see a mirror image. (However the image to be recorded is not altered.)

● Extend the viewfinder to see the picture while recording.

- 1 Rotate the LCD monitor towards the lens side.

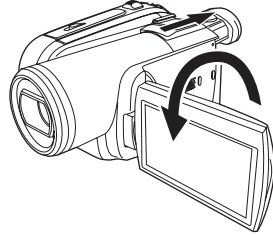

- When the Wide function is set, a vertically oriented display appears on the viewfinder screen, this is normal and not indicative of any trouble.
- When the LCD monitor is rotated towards the lens side, the icon will not be displayed even if you push the center of the joystick.

Backlight compensation function

This protects a backlit subject from being darkened.

● Set to Tape/Card Recording Mode.

- 1 Press the joystick to display the icon. Move the joystick down until icon ❶ appears.
- 2 Move the joystick up to select the backlight compensation icon [B.C.].



- The [BACKLIGHT COMPENSATION ON] indication appears on the screen of the Camcorder.
- The image on the screen will become brighter.

● To return to normal recording

Select the [B.C.] icon again.

- The [BACKLIGHT COMPENSATION OFF] indication appears on the screen of the Camcorder.

- Backlight compensation is canceled when you turn off the power or operate the mode dial.
- Backlight compensation is canceled when you activate the MagicPix function.

MagicPix function

This function allows you to record color subjects in dark locations to stand out against the background.

Attach the Camcorder to a tripod and you can record images free from vibration.

- Recorded scene is seen as if frames were missed.

Set to Tape Recording Mode.

- Press the joystick to display the icon. Move the joystick down until icon ❶ appears.
- Move the joystick up to select the MagicPix icon [★].

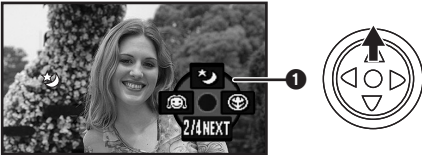

- The [MAGICPIX ON] indication appears on the screen of the Camcorder.
- If it is difficult to focus, adjust the focus manually. (-40-)

To cancel the MagicPix function

Select the [★] icon again.

- The [MAGICPIX OFF] indication appears on the screen of the Camcorder.

- If set in a bright place, the screen may become whitish for a while.
- The MagicPix function makes the signal charging time of the CCD up to approximately 30× longer than usual, so that dark scenes (a minimum of 1 lx) can be recorded brightly. For this reason, bright dots that are usually invisible may be seen, but this is not a malfunction.
- The MagicPix function is canceled when you turn off the power or operate the mode dial.

Soft skin mode

This allows the skin color to be recorded in a softer tone. This is more effective if you record a person closely from the torso up.

Set to Tape/Card Recording Mode.

- Press the joystick to display the icon. Move the joystick down until icon ❶ appears.
- Move the joystick left to select the soft skin icon [☺].



- The [SOFT SKIN MODE ON] indication appears on the screen of the Camcorder.

To cancel the soft skin mode

Select the [☺] icon again.

- The [SOFT SKIN MODE OFF] indication appears on the screen of the Camcorder.

- If the background or anything else in the scene has colors similar to the skin color, they will also be smoothed.
- If the brightness is insufficient, the effect may not be clear.

Tele macro function

By focusing only on the subject and blurring the background, the image can be impressive. This Camcorder can focus on the subject at a distance of approx. 50 cm (20 inches).

●Set to Tape/Card Recording Mode.

- 1 Press the joystick to display the icon. Move the joystick down until icon ❶ appears.
- 2 Move the joystick right to select the tele-macro icon [📷].

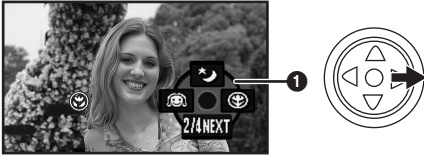

- The [TELE MACRO ON] indication appears on the screen of the Camcorder.
- If the magnification is 10× or less, then it is automatically set to 10×.

■ To cancel the tele macro function

Select the [📷] icon again.

- The [TELE MACRO OFF] indication appears on the screen of the Camcorder.
-
- If a sharper focus cannot be achieved, adjust the focus manually.
 - In the following cases, the tele macro function is canceled.
 - The zoom magnification becomes lower than 10×.
 - The power is off or the mode dial is operated.

Fade in/fade out function

Fade in

The image and audio gradually appear.

Fade out

The image and audio gradually disappear.

●Set to Tape Recording Mode.

- 1 Press the joystick to display the icon. Move the joystick down until icon ❶ appears.
- 2 Move the joystick left to select the fade icon [📺].

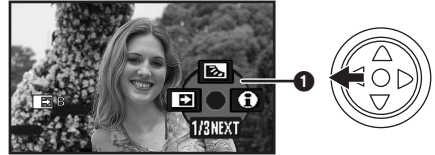

- The [FADE ON] indication appears on the screen of the Camcorder.

3 Press the recording start/stop button.

Start recording. (fade in)

When you start recording, the image/audio disappears completely and the image/audio gradually appears.



Pause recording. (fade out)

The image/audio gradually disappears. After the image/audio completely disappears, recording stops.



■ To cancel fading

Select the [📺] icon again.

- The [FADE OFF] indication appears on the screen of the Camcorder.

■ To select the color for fade in/fade out

The color which appears in fading pictures can be selected.

1 Set [ADVANCED] >> [FADE COLOR] >> [BLACK] or [WHITE].

- While the fade in/fade out function is selected, it takes several seconds to display the image when you start recording images. Besides, it also takes several seconds to pause recording.

Wind noise reduction function

This reduces the wind noise coming into the microphone when recording.

● Set to Tape Recording Mode.

1 Set [BASIC] >> [WIND CUT] >> [ON].

**■ To cancel the wind noise reduction function**

Set [BASIC] >> [WIND CUT] >> [OFF].

- The default setting is [ON].
- Reduces the wind noise depending on the wind strength. (If this function is activated in strong winds, the stereo effect may be reduced. When the wind weakens, the stereo effect will be restored.)

Auto Ground-Directional Standby (AGS)

This function prevents unnecessary recording when you forget to pause recording and walk with the Camcorder tilted upside down while recording continues.

- If the Camcorder continues to be tilted upside down from the normal horizontal position while recording on a tape, it is automatically put into recording pause.



[AGS]: Auto Ground-Directional Standby

● Set to Tape Recording Mode.

Set [SETUP] >> [AGS] >> [ON].

■ To cancel Auto Ground-Directional Standby

Set [SETUP] >> [AGS] >> [OFF].

- The AGS function may activate and cause the Camcorder to pause the recording if you are recording a subject right above or right below you. In these cases, set [AGS] >> [OFF] then continue the recording.
- Use the recording start/stop button to pause or stop the recording. The AGS function is only a backup function for when you forget to pause the recording.
- The time it takes the Camcorder to be put into recording pause after being tilted upside down varies depending on the operating conditions.

Self-timer recording

You can record still pictures on a card using the timer.

● Set to Card Recording Mode.

- 1 Press the joystick to display the icon. Move the joystick down until icon ❶ appears.
- 2 Move the joystick left to select the self-timer recording icon [⌚].

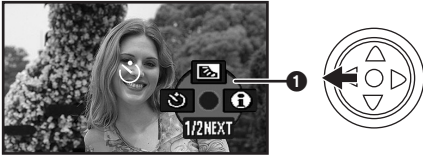

- The [SELF-TIMER ON] indication appears on the screen of the Camcorder.

3 Press the Photoshot button [📷].

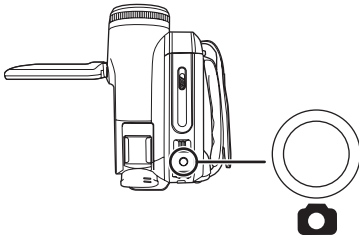

- After the [⌚] indication flashes for approx. 10 seconds, recording will start. After recording, the self-timer will be canceled.
- If you press the Photoshot button [📷] halfway and then fully, the subject is focused when the button is pressed halfway.
- When you press the Photoshot button [📷] fully, the subject is focused just before recording.

■ To stop the timer midway through

Press the [MENU] button.

- The self-timer standby mode is canceled when you turn off the power or operate the mode dial.

Wide/4:3 function

This allows you to record images compatible with wide-screen TVs.

Wide Function

Images are recorded with a 16:9 aspect ratio.

4:3 Function

Images are recorded with a 4:3 aspect ratio.

● Set to Tape/Card Recording Mode.

1 Wide Function

Set [BASIC] >> [ASPECT] >> [16:9].

4:3 Function

Set [BASIC] >> [ASPECT] >> [4:3].

■ To Cancel the Wide/4:3 Function

Wide Function

Set [BASIC] >> [ASPECT] >> [4:3].

4:3 Function

Set [BASIC] >> [ASPECT] >> [16:9].

- The default setting is [16:9].
- In the wide-screen mode, the menu screens, operation icons and other screen displays appear horizontally oriented.
- When images are played back on a TV screen, the date/time indication may be erased in some cases.
- Depending on the TV, the picture quality may deteriorate.
- If still pictures recorded with a 4:3 aspect ratio are played back when [TV ASPECT] is set to [16:9], part of the operation icons and other displays will appear on the black bands on the left and right of the picture.
- Concerning the TV to be connected and TV used for playback
 - When playing back images taken by this unit on a TV screen, change the setting established by Tape/Card playback mode [SETUP] >> [TV ASPECT] to match the aspect ratio (4:3 or 16:9) of the TV monitor to be connected. (-44-)
 - Depending on the settings of the TV connected, the images may not be displayed properly. For more information, please read the operating instructions for the TV.

Optical image stabilizer function

This feature reduces the jitter caused by hand movement when recording.

● Set to Tape/Card Recording Mode.

1 Set [ADVANCED] >> [O.I.S.] >> [ON].



■ To cancel the optical image stabilizer function

Set [ADVANCED] >> [O.I.S.] >> [OFF].

- When recording still pictures in the Card Recording mode, pressing the Photoshot button [] halfway increases the effect of the image stabilizer function. (MEGA Optical Image Stabilizer)
- In the following cases, the optical image stabilizer function may not work effectively.
 - When the digital zoom is used
 - When the Camcorder is shaken greatly
 - When you record a moving subject while tracking it

Guideline function

View the slope and the balance of the image while recording.

You can check if the image is level while recording motion pictures. The function can also be used to estimate the balance of the composition.

● Set to Tape/Card Recording Mode.

1 Set [ADVANCED] >> [GUIDE LINES] >> [ON].



■ To Cancel the Guideline Function

Set [ADVANCED] >> [GUIDE LINES] >> [OFF].

- The guide lines do not appear on the images actually recorded.

Recording in various situations (Scene mode)

When you record images in different situations, this mode automatically sets optimum shutter speeds and apertures.

● Set to Tape/Card Recording Mode.

1 Set the [AUTO/MANUAL/FOCUS] switch to [MANUAL].

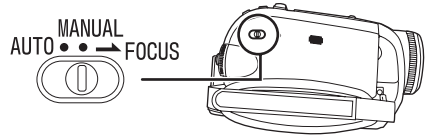

2 Set [BASIC] >> [SCENE MODE] >> select the desired mode.

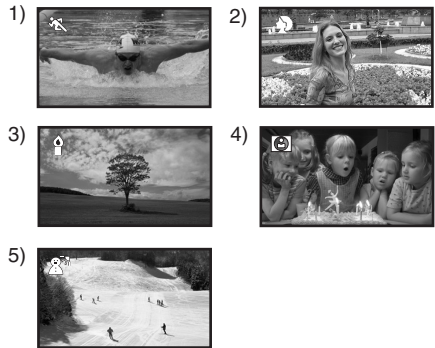

1) [] Sports mode

- To record sports scenes or scenes where there are quick motions

2) [] Portrait mode

- To make people stand out against the background

3) [] Low light mode

- To make the scene brighter in dark conditions

4) [] Spotlight mode

- To make the subject under a spotlight look more attractive

5) [] Surf & snow mode

- To record images in bright places such as ski slopes and beaches

■ To cancel the scene mode function

Set [BASIC] >> [SCENE MODE] >> [OFF] or set the [AUTO/MANUAL/FOCUS] switch to [AUTO].

Sports mode

- This mode reduces Camcorder shakes for slow-motion playback or playback pause of recorded pictures.
- During normal playback, the image movement may not look smooth.
- Avoid recording under fluorescent light, mercury light or sodium light because the color and brightness of the playback image may change.
- If you record a subject illuminated with strong light or a highly reflective subject, vertical lines of light may appear.
- If the brightness is insufficient, the sports mode does not function. The [] indication flashes.
- If this mode is used indoors, the screen may flicker.

Portrait mode

- If this mode is used indoors, the screen may flicker. If so, change the scene mode setting to [OFF].

Low light mode

- Extremely dark scenes may not be able to be recorded finely.

Spotlight mode

- If the recording subject is extremely bright, the recorded image may become whitish and the periphery of the recorded image extremely dark.

Surf & snow mode

- If the recording subject is extremely bright, the recorded image may become whitish.

Recording in natural colors (White balance)

The automatic white balance function may not reproduce natural colors depending on the scenes or lighting conditions. If so, you can adjust the white balance manually.

● Set to Tape/Card Recording Mode.

1 Set the [AUTO/MANUAL/FOCUS] switch to [MANUAL].

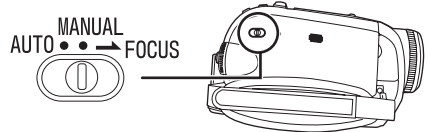

2 Move the joystick up to select the white balance icon [WB].



3 Move the joystick left or right in order to select the white balance mode.

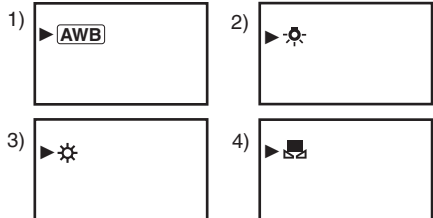

- 1) Auto white balance adjustment [**[AWB]**]
- 2) Indoor mode (for recording under incandescent lamps) [**[]**]
- 3) Outdoor mode [**[]**]
- 4) Manual adjustment mode [**[]**]

■ To restore to the automatic adjustment

Move the joystick left or right until the [**[AWB]**] indication appears. Or, set the [AUTO/MANUAL/FOCUS] switch to [AUTO].

- When the Camcorder is turned on with the lens cap attached, the automatic white balance adjustment may not function properly. Please turn the Camcorder on after removing the lens cap.
- When setting both the white balance and the iris/gain, set the white balance first.
- Whenever recording conditions change, re-set the white balance for correct adjustment.

■ To set the white balance manually

Select [] in Step 3. Then, while viewing a white subject on the entire screen, move the joystick up to select the [] indication.

■ About flashing of the [] indication When the manual adjustment mode is selected

Flashing indicates that the white balance previously adjusted is stored. This setting is stored until the white balance is adjusted again.

When white balance cannot be set in the manual adjustment mode

White balance may not be adjusted properly in the manual adjustment mode in dark places. If required, use the auto white balance mode.

Setting in the manual adjustment mode

When the setting is completed, it will keep lit.

■ About the white balance sensor

The white balance sensor detects the type of light source during recording.

Do not cover the white balance sensor during recording or it may not function properly.

■ About the black balance adjustment

This is one of the 3CCD system functions that automatically adjusts the black when the white balance is set in the manual adjustment mode. When the black balance is being adjusted, the screen will temporarily go black. (It is not possible to adjust the black balance manually.)

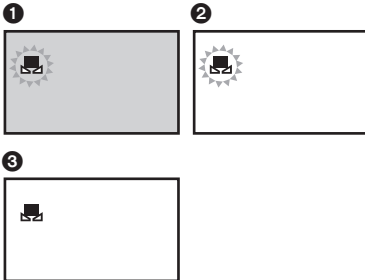

- 1 Black balance adjustment (Flashes.)
- 2 White balance adjustment (Flashes.)
- 3 Adjustment completed (Lights up.)

Manual focus adjustment

If auto focusing is difficult due to the conditions, then manual focusing is available.

● Set to Tape/Card Recording Mode.

1 Set the [AUTO/MANUAL/FOCUS] switch to [MANUAL].

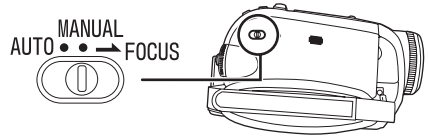

2 Set the [AUTO/MANUAL/FOCUS] switch to [FOCUS].

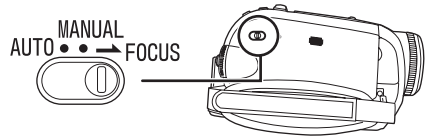

● The [MNL] indication and the manual focus [MF] indication appears.

3 Move the joystick left or right in order to adjust the focus.



● When focused with a wide angle, the subject may not be in focus when zoomed in. First, zoom in on the subject and then focus on it.

■ To restore to the automatic adjustment

Set the [AUTO/MANUAL/FOCUS] switch to [AUTO] or [FOCUS].

Manual shutter speed/aperture adjustment

Shutter Speed

Adjust it when recording fast-moving subjects.

Aperture

Adjust it when the screen is too bright or too dark.

● Set to Tape/Card Recording Mode.

1 Set the [AUTO/MANUAL/FOCUS] switch to [MANUAL].

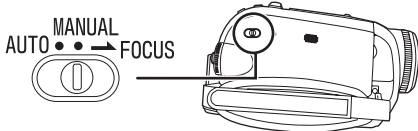

2 Move the joystick left or right to select aperture icon [IRIS] or shutter speed icon [SHTR].



3 Move the joystick left or right in order to adjust the shutter speed or aperture.

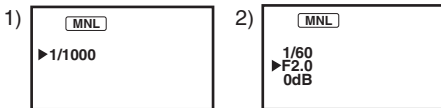

- 1) Shutter speed
- 2) (Aperture) Iris/gain value

■ To restore to automatic adjustment

Set the [AUTO/MANUAL/FOCUS] switch to [AUTO].

Manual shutter speed adjustment

- Avoid recording under fluorescent light, mercury light or sodium light because the color and brightness of the playback image may change.
- If you increase the shutter speed manually, the sensitivity lowers and accordingly the gain value increases automatically, which may increase the noise on the screen.
- You may see vertical lines of light in the playback image of a brightly shining subject or highly reflective subject, but this is not a malfunction.

- During normal playback, image movement may not look smooth.
- When recording in an extremely bright place, the color of the screen may change or flicker. If this happens adjust the shutter speed manually to 1/60 or 1/100.

Manual iris/gain adjustment

- Set the shutter speed before setting the aperture (iris/gain) when manually adjusting both settings.
- If the value does not become "OPEN", you cannot adjust the gain value.
- If the gain value is increased, the noise on the screen increases.
- Depending on the zoom magnification, there are iris values that are not displayed.

■ Shutter speed range

1/60 to 1/8000 seconds: Tape Recording Mode

1/30 to 1/2000 seconds: Card Recording Mode

The shutter speed closer to 1/8000 is faster.

■ Iris/gain value range

CLOSE (Closed), F16, ..., F2.0,

OPEN (Opened: F1.8) 0dB, ..., 18dB

Value closer to [CLOSE] darkens the image.

Value closer to [18dB] brightens the image.

Values with dB are gain values.

Playback mode

Playing back tape

- Set to Tape Playback Mode.
(An operation icon automatically appears on the LCD monitor.)

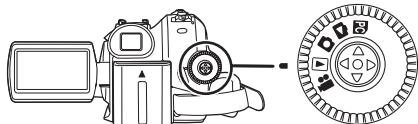

1 Operate with joystick.

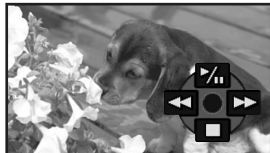

- ▶/||: Playback/Pause
- ◀◀: Rewind/Review playback (Reverts to playback with the ▶/|| icon.)
- ▶▶: Fast forward/Cue playback (Reverts to playback with the ▶/|| icon.)
- : Stop

- The power will not turn off when the LCD monitor and the viewfinder are closed and retracted during Tape playback mode.
- During cue/review playback, fast-moving images may show noise as a mosaic.
- Before and after cue/review playback, the screen may become blue for a moment or images may be disturbed.

■ To adjust volume

Adjust the speaker volume for playback.

- 1 Move the [- □/VOL+] lever to adjust the volume.

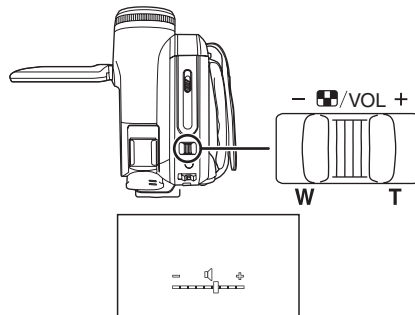

Towards [+]: increases the volume

Towards [-]: decreases the volume

(The nearer the bar is to [+], the higher the volume.)

- On the remote control, press the [T] button to increase the volume or the [W] button to decrease it.

- When the adjustment is completed, the volume indication will disappear.
- If you do not hear the sound, check the settings of [SETUP] >> [12bit AUDIO].

■ Repeat playback

When the tape end is reached, the tape will be rewound and played back again.

- 1 Set [ADVANCED] >> [REPEAT PLAY] >> [ON].

- The [↺▶] indication appears. (In order to cancel the repeat playback mode, set [REPEAT PLAY] >> [OFF] or turn off the power.)
- When you set [USB FUNCTION] >> [WEB CAM] and then connect the USB cable, the repeat playback mode is canceled.

■ Settings on the audio

- If you cannot listen to the desired audio when playing back a tape, check the settings in [SETUP] >> [12bit AUDIO].
- When you record and dub the audio in [12bit] and set [SETUP] >> [12bit AUDIO] >> [MIX], the audio will be played back in stereo sound regardless of the settings in [AUDIO OUT].

Slow-motion playback/ frame-by-frame playback

● **Set to Tape Playback Mode. (Slow-motion playback can only be performed by using the remote control.)**

Slow-motion playback

If the image is recorded in the SP mode, then it will be played back at a speed approx. 1/5 the normal speed.

If the image is recorded in the LP mode, then it will be played back at a speed approx. 1/3 the normal speed.

1 Press the [◀] button or the [▶] button on the remote control.

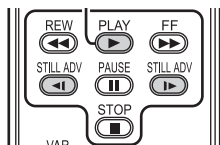

- If the slow-motion playback continues for approx. 10 minutes or more, then the playback will automatically stop. (10 minutes of slow-motion playback is equivalent to approx. 2 minutes in the SP mode or approx. 3 minutes in the LP mode.)

Frame-by-frame playback

1 During playback, press the [||] button on the remote control.

2 Press the [◀] button or the [▶] button on the remote control.

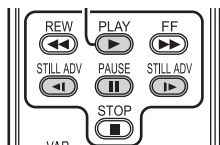

- Pushing the [-] [VOL+] lever towards [T] (normal direction) or towards [W] (reversed direction) of this Camcorder during playback pause also turns into the frame-by-frame playback. If you keep pushing the lever, then the images will continuously be played back frame by frame.

- The pause icon appears for an instant. Continuous frame-by-frame playback will start after the pause icon disappears.

■ To return to normal playback

Press the [PLAY ▶] button on the remote control or move the joystick up to the [▶] icon to start playback.

Slow-motion playback

- In the reversed slow-motion playback, the time code indication may be unstable.

Frame-by-frame playback

- Press and hold the [◀] or the [▶] button in the playback pause and then the images will continuously be played back frame by frame.

Variable-speed search function

The speed of cue/review playback can be varied. (This operation is only available when using the remote control.)

● **Set to Tape Playback Mode and play back a tape.**

1 Press the [VAR SEARCH] button on the remote control.

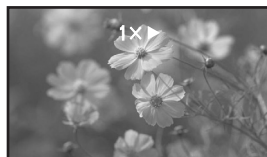

2 Press the [▲] or [▼] button to vary the speed.

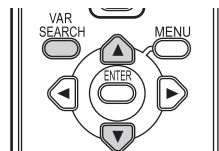

- The speeds for cue/review playback are 1/5× (SP mode slow-motion playback only), 1/3× (LP mode slow-motion playback only), 2×, 5×, 10×, 20×.

■ To return to normal playback

Press the [VAR SEARCH] button or [PLAY ▶] button on the remote control.

- Images may be shown in a mosaic-like pattern.
- The sound is muted during search.
- This function is canceled when the operation icon is displayed.
- When you cue/review playback at 20×, the speed switches to 10× near the end of the tape. ([10×] flashes on the screen.)

Playback on TV

Images recorded by this Camcorder can be played back on a TV.

● Insert a recorded tape or card into this Camcorder.

- Be sure that the power of the unit is turned off before connecting it to a TV

1 Connect the Camcorder and a TV.

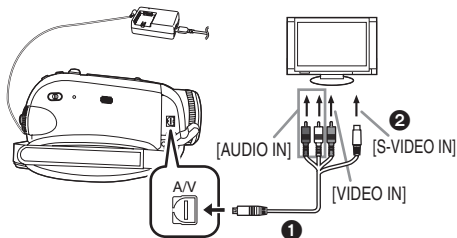

- Connect the Camcorder and a TV by using the Multi cable ①.
- If the TV has an S-Video terminal, then also connect to this terminal ②. It allows you to enjoy more beautiful images. (Do not forget to also connect to the Video and Audio terminals.)

2 Turn on this Camcorder and set the mode dial to the Tape Playback Mode (or Card Playback Mode).

3 Select the input channel on the TV.

- If the images are not played back correctly on the TV (e.g. they are displayed vertically), perform the menu operations in accordance with the aspect ratio of the TV monitor. Set [SETUP] >> [TV ASPECT] >> [16:9] or [4:3].

4 Move the joystick up to select the [▶/||] icon to start playback.

- The image and audio are output on the TV.

5 Move the joystick down to select the [■] icon to stop playback.

- Whenever plugging in the S-Video terminal, plug in the VIDEO IN terminal and AUDIO IN terminal, too.
- Use the AC adaptor to free you from worrying about the battery running down.

■ If the image or audio from this Camcorder is not output on the TV

- Check that the plugs are inserted as far as they go.
- Check the [12bit AUDIO] settings. (-50-)
- Check the connected terminal.
- Check the TV's input setting (input switch). (For more information, please read the operating instructions for the TV.)

■ To display the on-screen information on the TV

The information displayed on the LCD monitor or the viewfinder (operation icon, time code and mode indication, etc.) can be displayed on the TV.

(This operation is only available when using the remote control.)

1 Press the [EXT DISPLAY] button on the remote control.

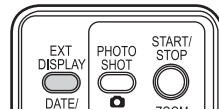

- Press the button again to erase the information.

Playing back card

● Set to Card Playback Mode.

(An operation icon automatically appears on the LCD monitor.)

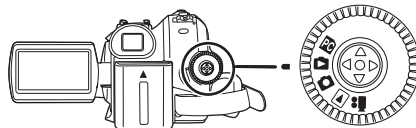

1 Operate with joystick.

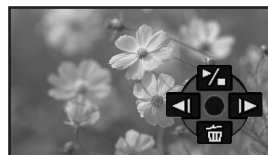

- ◀: Plays back the previous picture
- ▶: Plays back the next picture
- ▶/■: Slide show (Plays back the still pictures on the card in order) start/pause

- The power will not turn off when the LCD monitor and the viewfinder are closed and retracted during Card playback mode.
- Even if the operation icon does not appear, the previous or next picture can be displayed.
- While the data on a card are played back, do not operate the mode dial.
- When the access lamp is lit, do not remove the card.
- Depending on the picture size, it may take time to display the file.
- If you attempt to play back file recorded in a different format or file data is defective, the whole display becomes bluish and the

“UNPLAYABLE CARD” indication may appear as warning.

- When playing back still pictures recorded in 4:3 mode ([3.1m], [2m], [1m], [0.3m]) on a wide-screen TV, the picture quality may deteriorate.
- When playing back a file recorded on other equipment, the date and time display is different from when it was recorded.

■ To display multiple playback files

Multiple files on the card (6 files on 1 screen) are displayed.

- 1 Move the [-] [VOL+] lever to switch the images.



- Towards [+]: Full-screen display (Displays 1 image.)
 Towards [-]: Multi-screen display (Displays 6 files on 1 screen.)

- In the multi-screen display,
 - Move the joystick to select a file (The selected file will be encircled by a orange frame) and press to determine it. The selected file is full-screen displayed.
 - If there are 7 files or more, then move the joystick. The next or previous multi-screen will be displayed.

■ About the compatibility of still pictures

- The Camcorder is compliant with the unified standard DCF (Design rule for Camera File system) established by JEITA (Japan Electronics and Information Technology Industries Association).
- The file format supported by this Camcorder is JPEG. (Not all JPEG formatted files will be played back.)
- If an out-of-specs file is played back, the folder/file name may not be displayed.
- The Camcorder may degrade or not play back data recorded or created on another brand of Camcorder and vice versa.

Deleting files recorded on a card

The deleted files cannot be restored.

- **Set to Card Playback Mode.**

- 1 Move the joystick left or right to select a file to delete.

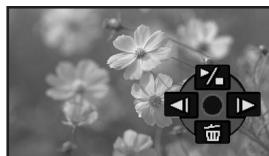

- You can select a file in the multi-screen display. After selecting the file, press the joystick and display the operation icon.

- 2 Move the joystick down to select [DELETE].

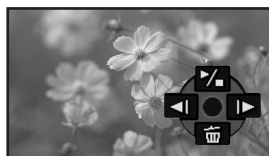

- 3 Move the joystick up or down in order to select [DELETE 1 FILE] and then press it.

- 4 When the confirmation message appears, select [YES] and press the joystick.

- In order to stop deletion, select [NO].

■ To delete all files

- 1 Move the joystick down to select [DELETE].



- 2 Move the joystick up or down in order to select [ALL FILES] and then press it.

- 3 When the confirmation message appears, select [YES] and press the joystick.

- Do not turn off the power while deleting.
- To delete files, use the AC adaptor or a sufficiently charged battery.
- In case of [ALL FILES], the deletion may take time if there are many files on the card.
- If the “CARD FULL” indication appears when recording, the card is full and no further data can be recorded. Insert a new card or set the Camcorder to Card Playback Mode and delete unnecessary files.
- If files conforming to DCF standard are deleted, all the data related to the files will be deleted.

■ Deleting still picture files recorded on a card by other equipment

- A still picture file (other than JPEG) that cannot be played back on the Camcorder may be deleted.

Note:

To delete multiple files on the SD Card (selected files) connect to a PC and use the SD Drive feature.

Formatting a card

Please be aware that if a card is formatted, then all the data recorded on the card will be erased. Store important data on a personal computer, etc.

● Set to Card Playback Mode.

- 1 Set [ADVANCED] >> [FORMAT CARD] >> [YES].
- 2 When the confirmation message appears, select [YES] and press the joystick in order to format the card.



- In order to stop formatting, select [NO].

- Normally, it is not necessary to format the card. If a message appears even though you insert and remove the card several times, format it.
- If the SD Card is formatted on other equipment, it may take longer to record or you may not be able to use the SD Card. In this case, format the SD Card on this unit.
(Do not format it on a PC etc.)
- This unit supports SD Memory Cards formatted in FAT12 system and FAT16 system based on SD Memory Card Specifications and SDHC Memory Cards formatted in FAT32 system.

Protecting files on a card

Files recorded on a card can be protected so that they may not be deleted by mistake. (Even if the files are protected, they will be deleted if the card is formatted.)

● Set to Card Playback Mode.

- 1 Set [BASIC] >> [PROTECT] >> [YES].
- 2 Move the joystick to select a file to be protected and then press it.

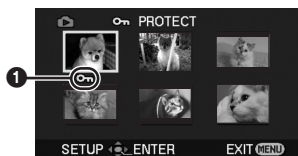

- The [] Indication ① appears and the selected file is protected. Press the joystick again and the protection is canceled.
- 2 or more files can be protected in succession.

■ To complete the settings

Press the [MENU] button.

Writing the printing data on a card (DPOF setting)

You can write the data of pictures to be printed, number of prints and other information (DPOF data) onto the card.

● Set to Card Playback Mode.

- 1 Set [ADVANCED] >> [DPOF SET] >> [SET].
- 2 Move the joystick to select a file to be set and then press it.

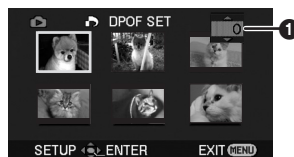

- The number of prints ① set to be in DPOF is displayed.

- 3 Move the joystick up or down in order to select the number of prints and then press it.

- You can select from 0 to 999. (The number of pictures to be printed can be set for a printer supporting DPOF.)
- 2 or more files can be set in succession.

■ To complete the settings

Press the [MENU] button.

- DPOF settings made on another Camcorder may not be recognized by this Camcorder. Please perform the DPOF settings on your Camcorder.

■ To set so that all pictures are not printed

Select [CANCEL ALL] in Step 1.

■ What is DPOF?

DPOF stands for Digital Print Order Format. This enables the printing information to be added to the pictures on the card so that it can be used on a system supporting DPOF.

Edit mode

Recording from a tape onto a card

Still pictures can be recorded on a memory card from scenes that have already been recorded on a cassette.

- Set to Tape Playback Mode.
- Insert a tape which already has recorded contents and a card.

1 Start playback.



2 Pause at the scene you wish to record and press the Photoshot button [📷].

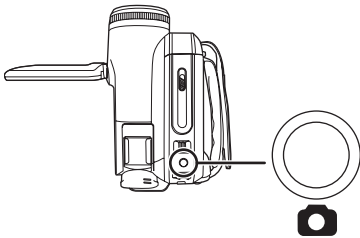

- Audio will not be recorded.

- The size of still pictures recorded on a card becomes [0.2m] (16:9) or [0.3m] (4:3). (This is not mega pixel still-picture recording.)
- If you set [TV ASPECT] >> [4:3], black bands are added to the top and bottom of the picture when wide pictures are recorded to the card. (-37-)
- If you press the Photoshot button [📷] without pausing, blurred pictures may be recorded.

Copying onto a DVD recorder or a VCR (Dubbing)

Pictures recorded by the Camcorder can be stored on a DVD-RAM or other such media. Refer to the instructions for the recorder.

- Place a recorded cassette in the Camcorder and an unrecorded DVD-RAM or cassette in the DVD recorder or VCR.

1 Connect the Camcorder and the recorder.

Connecting with the Multi cable

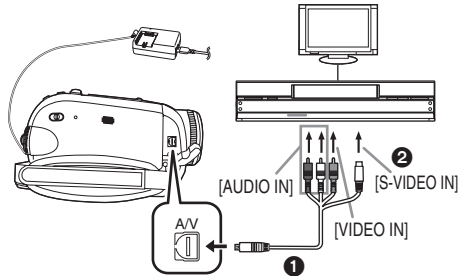

- Connect the Camcorder and the recorder by using the Multi cable ①.
- If the recorder has an S-Video terminal, then also connect to this terminal ②. It allows you to copy clearer image.

Connecting with the optional DV cable: PV-DDC9/PV-DDC9-K (Only for equipment with a DV terminal)

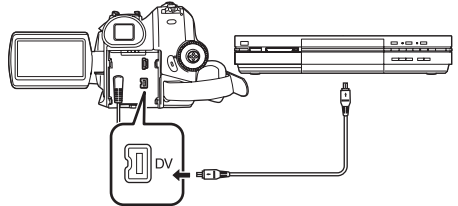

- 2 Turn on the Camcorder and set to Tape Playback Mode.
- 3 Select the input channel on the TV set and recorder.
- 4 Move the joystick up to select the [▶/||] icon to start playback. (Player)
 - The image and sound are reproduced.
- 5 Start recording. (Recorder)
- 6 Stop recording. (Recorder)
- 7 Move the joystick down to select the [■] icon to stop playback. (Player)

- If you record (dub) images onto another video device and then play them back on a wide-screen TV, the images may be stretched vertically. In this case, refer to the operating instructions for the device that you are recording (dubbing) to or read the operating instructions for the TV and set to 16:9 (full).
- For more information, refer to the operating instructions for your TV set and recorder.
- When you do not need functional indications or date and time indication, set [SETUP] >> [DISPLAY] >> [OFF] or set [BASIC] >> [DATE/TIME] >> [OFF] in the Tape Playback Mode. (When you connect the Camcorder and a recorder with the DV cable, these indications may not appear.)

■ When neither image nor sound from the Camcorder is output to the TV set

- Check that the plugs are inserted as far as they go.
- Check the [12bit AUDIO] settings. (-50-)
- Check the connected terminal.

Using the DV Interface Cable for Recording (Digital Dubbing)

By connecting other digital video equipment with DV terminal and the Camcorder by using the DV cable PV-DDC9/PV-DDC9-K (optional) ❶, high-image-quality dubbing can be done in digital format.

● Set to Tape Playback Mode. (Player/recorder)

1 Connect the Camcorder and digital video equipment with the DV cable.

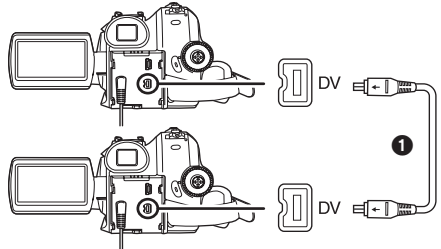

2 Set [ADVANCED] >> [REC STDBY] >> [YES]. (Recorder)

- You do not have to follow this step when the remote control is used in the digital dubbing.

3 Start playback. (Player)

4 Start recording. (Recorder)

When operating with the main unit:

Move the joystick up to select [●/II] icon.

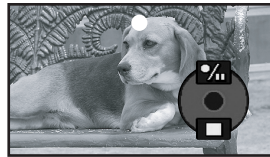

When operating with the remote control:

While pressing the [●REC] button on the remote control, press the [PLAY ►] button.

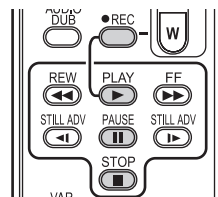

5 Move the joystick up to select the [●/II] icon again or press the [II] button on the remote control to stop recording. (Recorder)

6 Stop playback. (Player)

■ To cancel the standby for recording

When the Camcorder is standby for recording, move the joystick down and select the [■] icon or press the [■] button on the remote control.

- Do not plug or unplug the DV cable during dubbing or the dubbing may not be completed properly.
- If a picture (bilingual video, etc.) containing main sound and sub sound has been dubbed, select the desired sound by [SETUP] >> [AUDIO OUT] on playback.
- Even if you use a device equipped with DV terminals such as IEEE1394, you may not be able to perform digital dubbing in some cases. For more information, see the instructions for equipment connected.
- Regardless of the menu settings on the recorder, digital dubbing is carried out in the same mode as the [AUDIO REC] mode of the playback tape.
- The images on the recorder monitor may be disturbed, but it does not affect the recorded images.
- If a picture containing a copyright protection signal (copy guard) is recorded by the Camcorder, the picture is distorted by mosaic-like patterns at playback.
- Disconnect the USB cable since input signals from the external input terminal cannot be recorded while it is connected with the USB cable.
- While pictures are input from the DV terminal, the operation icon blinks on instead of appearing from the side of the screen when you press the center of the joy stick.
- While pictures are input from the DV terminal, the TV aspect will not change even if you change the setting for [TV ASPECT] in the [SETUP] menu.

CAUTION:

Unauthorized exchanging and/or copying of copyrighted recordings may be copyright infringement.

Audio dubbing

You can add music or narration to the recorded cassette.

(Audio dubbing can only be performed by using the remote control.)

● **Set to Tape Playback Mode.**

1 Find a scene that you want to add sound to and press the [II] button on the remote control.

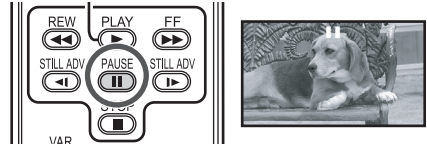

2 Press the [AUDIO DUB] button on the remote control to make audio dubbing ready.

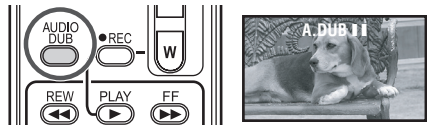

3 Press the [II] button on the remote control to start audio dubbing.

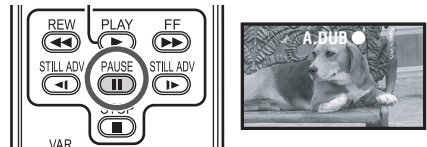

● Be sure that the sound is directed towards the built-in microphone.

4 Press the [II] button on the remote control to stop audio dubbing.

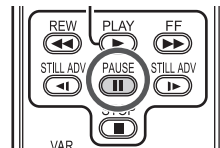

● If a tape has a non-recorded portion when the tape is dubbed, images and sounds may be disturbed when this portion of the tape is played back.

Before recording with audio dubbing

- **Set to Tape Recording Mode.**
- When you want to preserve the original sound taken during recording, set [ADVANCED] >> [AUDIO REC] >> [12bit] to take pictures. (When set [16bit], the sounds taken during recording are erased after recording with audio dubbing.)
- Set [BASIC] >> [REC SPEED] >> [SP] to take pictures.

To play back the sound recorded with audio dubbing

You can switch between the sound recorded with audio dubbing and the original sound.

Set [SETUP] >> [12bit AUDIO] >> [ST2] or [MIX].

[ST1]: It only plays back the original sound.

[ST2]: It only plays back the sound added by audio dubbing.

[MIX]: It simultaneously plays back the original sound and the sound added with audio dubbing.

- During audio dubbing, it is automatically set to [ST2].

PC Connection With DV Interface Cable

A video clip can be transferred directly to your PC (personal computer) via a DV Interface Cable (optional) using products and software from a number of video editing software companies. Using products from video editing software companies allows you to capture and edit video clips using the DV Interface.

Panasonic DVC are OHCI compliant and should have no problem working with any OHCI compliant FireWire Card/Video — Editing software package.

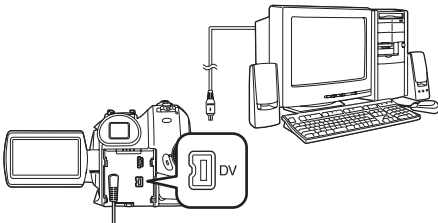

- Personal computer must be equipped with a DV Terminal.
- During Camcorder playback, do not disconnect the DV Interface Cable or turn the Camcorder off as this may cause a PC hang-up error.
- IEEE1394 Interface must conform to OHCI (Open Host Controller Interface Specification).

Printing pictures by directly connecting to the printer (PictBridge)

To print pictures by directly connecting the Camcorder to the printer, use a printer compatible with PictBridge. (Read the operating instructions for the printer.)

Insert a card and set to Card Playback Mode.

- 1 Connect the Camcorder and the printer with the supplied USB cable.**

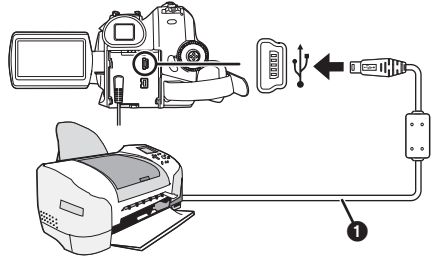

- 1** USB cable



- The [PictBridge] indication appears on the screen of the Camcorder. (When the printer is being recognized, the [PictBridge] indication blinks.)
- When no card is inserted in the Camcorder, the [PictBridge] indication does not appear. (You cannot print any pictures.)
- When the Camcorder and the printer are not connected properly, the [PictBridge] indication keeps blinking. (It will blink for over approx. 1 minute.) Connect the cable or check the printer.
- When images are displayed in multi-screen, they cannot be printed.

2 Select [SINGLE PRINT] or [DPOF PRINT].

- If there is no file with a DPOF setting, you cannot select [DPOF PRINT].
- When you select [DPOF PRINT] for printing, set the number of prints in DPOF setting.
- When [DPOF PRINT] is selected, print after you determine the paper size. (Step 6)
- When [DPOF PRINT] is selected, date printing is unavailable.

3 Move the joystick left and right to select a desired picture and then press it.



4 Select the desired number of prints.

- You can set up to 9 prints.

5 Select the setting for date printing.

- If the printer is not capable of date printing, this setting is unavailable.

6 Select [PAPER SIZE].

[STANDARD]: Size specific to the printer

[4×5 INCH]

[5×7 INCH]

[4×6 INCH]

[A4]

- You cannot set paper sizes not supported by the printer.

7 Select [PAGE LAYOUT].

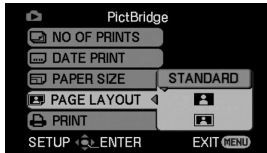

[STANDARD]: Layout set on the printer

[]: No frame

[]: With frame

- You cannot set a layout not supported by the printer.

8 Set [PRINT] >> [YES] to start printing.

■ When you stop printing halfway

Move the joystick down.

- Avoid the following operations during printing. These operations disable proper printing.
 - Disconnecting the USB cable
 - Removing the card
 - Switching the mode dial
 - Turning off the power
- Check the settings for the paper size, quality of print, etc. on the printer.
- Still pictures recorded on other equipment may not be printed.
- When the Camcorder and the printer are connected in the Tape Recording/Playback Mode, the [**WEB**] Indication may appear on the LCD monitor. However, pictures cannot be printed.
- The sides of pictures recorded when [16:9] is set may be cut at printing. (When you purchase this unit, [ASPECT] is set to [16:9].) When using a printer with a trimming or borderless function,

cancel this setting. (Refer to the operating instructions of the printer for details.)

- If your photos are sent to a professional photo printing service, please request that they are printed in their original aspect ratio.
- Connect the printer directly to this unit. Do not use a USB hub.

With a PC

Check before Use

Available software and required drivers vary depending on the OS of the personal computer. Check the required software and drivers with the table described below and then install them from the CD-ROM.

Supplied CD-ROM is available for Windows only.

Purpose of use	Software used	Installation of drivers		
		Windows XP	Windows 2000	Mac OS
1)	①	Not required	Not required	Not required*8
2)	②	Not required*1, 3	Not required*1, 5	Not required*8
	③	Not required*1, 2, 3	USB Driver*1, 2, 5	Not available
3)	②	Not required*1, 3	Not required*1, 5	Not required*8
	③	Not available	Not available	Not available
4)	④	USB Driver*1, 4, 6	USB Driver*5, 7	Not available

- 1) Copying files in the card onto the personal computer
 - PC connection mode
 - 2) Capturing pictures on the tape to the personal computer
 - Tape recording mode
 - Tape playback mode
 - 3) Recording pictures on the personal computer to the tape
 - Tape playback mode
 - 4) Using the Camcorder as a WEB camera
 - Tape recording mode
 - Tape playback mode
- ① No software
(The Camcorder is used as a removable disc.)
 - ② Quick Movie Magic/MotionDV STUDIO (Connect with the DV cable (optional).)
iMovie 4/iMovie HD (Connect with a FireWire (DV) cable (not supplied).)
 - ③ Quick Movie Magic/MotionDV STUDIO (Connect with the USB cable (supplied).)
 - ④ Windows Messenger/MSN Messenger/
Windows Live Messenger

- *1 If DirectX 9.0b/9.0c is not installed in the personal computer you use, the installation of [DirectX] is required.
 - *2 The personal computer you use should comply with USB 2.0 (Hi-Speed).
 - *3 Available only on Windows XP SP2
 - *4 Available only on Windows XP SP1/SP2
 - *5 Available only on Windows 2000 SP4
 - *6 Not required for Windows XP SP2
 - *7 Available only on MSN messenger
 - *8 Available only on Mac OS X v10.3 to 10.4
- If using other brands of video editing software, please consult with your retailer for compatibility.

Using the Camcorder with a PC

An image stored on the DV Cassette can be transferred to your personal computer.

■ Software Installation

- 1 Turn on Computer and start up Windows.
- 2 Insert supplied CD-ROM into the CD-ROM drive.

- [Setup Menu] appears.



- 3 Select the software to be installed from [Setup Menu].

- USB Driver -54-, -57-:

If the Camcorder is connected to your personal computer, you can send video from the Camcorder to the other parties via a network or by the Internet.

It is also needed when you use Quick Movie Magic or MotionDV STUDIO with USB connection. (Windows 2000 only)

- DirectX -54-, -57-:

To activate Quick Movie Magic or MotionDV STUDIO, Microsoft DirectX 9.0b/9.0c should be installed. (If you install USB Driver, DirectX 9.0b is automatically installed.)

- Quick Movie Magic -57-:

Using the Quick Movie Magic software allows you to easily import video on a tape to a personal computer and then auto edit the imported video. For advanced importing and editing, use MotionDV STUDIO.

● MotionDV STUDIO -57-:

Using the MotionDV STUDIO software allows you to capture video recorded on a tape or images viewed through the lens of a Camcorder. Connecting the Camcorder with the DV cable also allows you to output images edited on the personal computer to the tape in the Camcorder.

4 Follow the instructions on the computer screen until the installation is complete.

- Setup window will disappear when the installation is complete.

Note:

If a window does not appear automatically, click the “start” Button on your desktop and then click “Run”. When the “Run” Box is open, type in “D:\InstMenu.exe” and click “OK”. (“D” is used when the CD-ROM drive is drive D.)

Connecting Computer and Camcorder

Before making these connections, turn off all devices, which are to be connected.

■ Operating environment

- Despite having the operating environment indicated, it may not be possible to use the program with some types of personal computers.

For Windows

OS:

IBM® PC/AT compatible personal computer with pre-installed;
Microsoft Windows 2000 Professional
Microsoft Windows XP Home Edition/Professional

CPU:

Intel Pentium II 300 MHz or higher
(including compatible CPU)

RAM:

32 MB or more (64 MB or more recommended)

Interface:

USB 1.1 or later — A type

- The USB equipment operates with the driver installed as standard with the OS.

For Macintosh

OS:

Mac OS X v 10.3 to v 10.4

CPU:

PowerPC G3 (400 MHz or higher), G4, G5
Intel Core Duo, Intel Core Solo

RAM:

64 MB or more

- The USB equipment operates with the driver installed as standard with the OS.

■ Using the Built-in SD Drive

By connecting the Camcorder and personal computer with the USB cable, you can transfer still images saved on a Memory Card directly to your personal computer.

- 1 Insert the Memory Card into the Camcorder.
- 2 Set the Camcorder to PC Connection Mode.

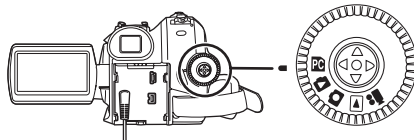

- 3 Connect the Camcorder to your personal computer with the USB cable.

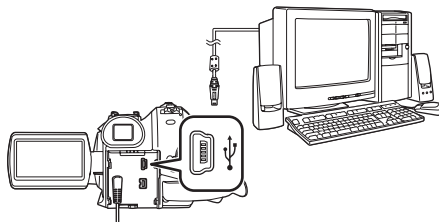

- 4 Camcorder power is turned on.
- 5 For Windows 2000 users, open [My Computer] and click [Removable Disk]. For Windows XP users, click [Open folder to view files using Windows Explorer] and then [OK].
- 6 Double-click a file you want to view.
 - You can view images stored on the Memory Card and also save them to your hard disk.
 - Do not change file or folder names on the personal computer. The images on the Memory Card may not be viewable on the Camcorder.
 - The appropriate driver to recognize the Camcorder is automatically installed by Windows Plug and Play when connected for the first time.
 - After the USB cable is connected to the Camcorder, open [My Computer] or [Windows Explorer] to check that the drive is displayed as a removable disk drive (only when card is inserted into the Camcorder). It enables you to operate it in the same way as a floppy disk drive and you can use the same drag and drop or copy methods.

Using as a Web camera

If the Camcorder is connected to your personal computer, you can send video and sound from the Camcorder to other parties via the network.

Note:

- Do not connect the USB cable until the USB Driver is installed.

Please see chart below:

[Send]		[Receive]	[Software]
Windows XP	←OK→	Windows XP	Windows Messenger/MSN Messenger/Windows Live Messenger
Windows XP	←OK→	Windows 2000	MSN Messenger/Windows Live Messenger
Windows 2000	←OK→	Windows 2000	MSN Messenger

Operating environment

OS:

IBM PC/AT compatible personal computer with pre-installed;

Microsoft Windows XP Home Edition/Professional SP1 or SP2 *1

Microsoft Windows 2000 Professional SP4

CPU:

Intel Pentium III 450 MHz or higher (including compatible CPU)

RAM:

128 MB or more (256 MB or more recommended)

Free hard disk space:

250 MB or more

Communication Speed:

56 kbps or faster is recommended

Interface:

USB 1.1 or later — A type

Graphic display:

High Color (16 bit) or more

Desktop resolution of 800×600 pixels or more

Other requirements (to send/receive audio):

Sound card

Speaker or headphones

Necessary software:

Windows Messenger 5.0/5.1 (Windows XP)

MSN Messenger 7.0/7.5 (Windows 2000/ XP)

Windows Live Messenger 8.0 (Windows XP)

DirectX 9.0b/9.0c

*1 When your OS is Windows XP SP2, the USB driver is not needed.

- This software is not compatible with a multi-CPU environment.

- This software is not compatible with a multi-boot environment.

- Operation on Microsoft Windows XP Media Center Edition, Tablet PC Edition and 64 bit operating system is not guaranteed.

To use the Camcorder as a Web camera, the following conditions must be met.

- If the installed version is not the latest, update it by performing the Windows update.
- To upgrade Windows XP to SP2, click [start] >> [All Programs] >> [Windows Update]. (Requires Internet connection.)
- To upgrade Windows 2000 to SP4, click [start] >> [Windows Update]. (Requires Internet connection.)
- Install Windows Messenger/Windows Live Messenger (Windows XP). If you have a version of Windows Messenger that is older than 5.0/5.1, download the latest version (5.0/5.1) from the Microsoft Home Page. The latest version of MSN Messenger/Windows Live Messenger can also be downloaded from the Microsoft Home Page. <http://www.microsoft.com/> (For download and installation instructions, please refer to Help on the Home Page.)
- Depending on the security setting on the PC, proper communication may not be possible.

Installing USB Driver

DirectX 9.0b must be installed in your PC if it is not already installed.

- When DirectX 9.0b is installed, applications supported by previous versions of DirectX may not run. In this case, consult the manufacturers of the disabled applications.

1 Insert the supplied CD-ROM into the personal computer's CD-ROM drive.

- Quit all applications.
- [Setup Menu] appears.

2 Click [USB Driver].

- The set up program starts running.

3 Depending on your system environment, installation of "DirectX 9.0b" may be required. Click [Yes] and continue with installation.

- After "DirectX 9.0b" is installed, the computer will restart.
- Do not remove the CD-ROM.
- Installation may take a little while.

4 Finish installation by following the on-screen instructions.

- Click [Next] and proceed with installation.
- After completing the installation, Click [Finish].

5 Click [OK].

Connecting the Camcorder to personal computer (For Use as a Web Camera)

1 Install the supplied USB Driver on the provided CD-ROM.

2 Set the Mode Dial to Tape Recording Mode.

3 Set [ADVANCED] >> [USB FUNCTION] >> [WEB CAM].



- To send pictures recorded on a tape to another personal computer using Windows Live Messenger/Windows Messenger/MSN Messenger, set [BASIC] >> [USB FUNCTION] >> [WEB CAM] on Tape Playback Mode before connecting the Camcorder to your personal computer.

When you use the Camcorder as a Web camera in the Tape Playback Mode, the indication of the operation icon is different from the one in usual operation.

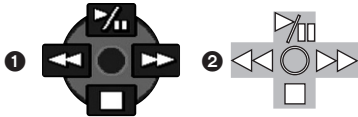

- 1 In usual operation
 - 2 In the WEB CAMERA mode (Tape Playback Mode)
- Even if you move the joystick up/down/right/left (▶/⏏, ◼, ▶▶, ◀◀), the selected direction on the operation icon is not lit in yellow.
 - The operation icon blinks on instead of appearing from the side of the screen when you press the center of the joystick.
- 4 Connect the Camcorder to a personal computer with the USB cable.**
- When the Camcorder and the personal computer (with Windows 2000) are connected via a USB cable, a message, such as the one below, is displayed. However, testing by the manufacturer has confirmed the functionality of this Camcorder with Windows 2000. Click [Yes] and proceed.



5 Start Windows Live Messenger (for Windows XP users), Windows Messenger (for Windows XP users) or MSN Messenger (for Windows 2000/XP users).

- Click [start] >> [Programs] >> [Windows Messenger], [MSN Messenger] or [Windows Live Messenger].

- You may not be able to communicate with the other parties via the network if they are not using the same Messenger application (software) as you are. (The only exception is the combination of MSN Messenger and Windows Live Messenger.)
- If the Camcorder is used as a Web Camera, the quality of the video to be exchanged will depend on the Internet connection status.
- In the WEB CAMERA mode, video cannot be recorded onto a tape or a card.
- You cannot output the video input from the DV terminal to the display of the PC.
- In the WEB CAMERA mode, the audio may be interrupted in the middle of communication depending on the communication environment or the performance of the personal computer.

Setting up Windows Messenger

When starting Windows Messenger for the first time, its setup screen is displayed. (However, the screen is not displayed if the Windows Messenger setup has already been done.) For more details, please read the corresponding Help file.

1 Click [Click here to sign in].



- 2 Select [.NET Messaging Service] and click [OK].
- 3 After the .NET Passport Wizard is displayed, click [Next].



- Please refer to the instruction manual of your personal computer for how to configure the audio and the microphone.
 - To communicate with persons using Windows in other languages, setting up using alphabets or numbers is recommended.
- 4 According to the procedures displayed on the screen, continue the setup.**

5 After the setup is completed, sign in and start Windows Messenger.

- Windows Messenger is activated.



6 Click on [Audio Tuning Wizard...] in the [Tools] menu to confirm that equipment is connected correctly.

7 Select [USB Video Device] in the [Camera] menu.

8 Select [DVC] in the [Microphone] menu.

- Please refer to the HELP file of Windows Messenger to understand its operation.
- During set up, if [Primary video capture device] selection screen is displayed, [Panasonic DVC Web Camera] is selected.

■ Setting up MSN Messenger/Windows Live Messenger

When starting MSN Messenger/Windows Live Messenger for the first time, its setup screen is displayed. (However, the screen is not displayed if MSN Messenger/Windows Live Messenger setup has already been done.) For more details, please read the corresponding Help file.

In the case of MSN Messenger 7.0

1 Click [Sign In].



2 Type in your Sign-in name and password.

- If you do not have your Sign-in name and password, click [Get one here].

3 Please carefully read the displayed contents and then proceed.

4 After the setup is completed, sign in and start MSN Messenger.



5 Click on [Audio Tuning Wizard...] in the [Tools] menu to confirm that the equipment is connected correctly.

6 Select the microphone attached to the PC in the [Microphone] menu.

7 Click [Web Camera Settings...] in the [Tools] menu.

8 Confirm that the [Panasonic DVC Web Camera Device] is selected.

In the case of MSN Messenger 7.5/Windows Live Messenger 8.0

1 Type in your E-mail address and password.



- If you do not have a password, click [Get a new account].

2 After setup is completed, sign in and start MSN Messenger.

3 Click [Audio and Video Setup] in the [Tools] menu and then click [Next].

4 Set up the speaker settings.

5 Select [DVC] in the microphone setup screen.



6 Select [USB Video Device] in the Webcam setup screen and then click [Finish].

- For other information about MSN Messenger/Windows Live Messenger, please refer to Help.

- When access is finished, close MSN Messenger/Windows Live Messenger, then turn off the Camcorder. Finally, disconnect the USB cable.

Using Quick Movie Magic or MotionDV STUDIO

When the OS is Windows 2000/XP, the Camcorder can be connected to the personal computer with the DV cable.

When the OS is Windows 2000/XP, the Camcorder can be connected to the personal computer with the USB cable. However, when the OS is Windows 2000, USB driver must be installed.

- Do not connect the USB cable until the USB driver is installed.

■ Operating environment

OS:

IBM PC/AT compatible personal computer with pre-installed;

Microsoft Windows XP Home Edition/
Professional SP2

Microsoft Windows 2000 Professional SP4

CPU:

Intel Pentium III 800 MHz or higher (including compatible CPU)

Graphic display:

High Color (16 bit) or more
(32 bit recommended)

Desktop resolution of 1024×768 pixels or more
(Supporting the overlay of DirectDraw)

Sound:

PCM sound source (Compatible DirectSound)

RAM:

256 MB or more

(Adding more memory enables you to operate the personal computer more comfortably.)

Hard disk:

Ultra DMA – 33 or more

Free hard disk space:

640 MB or more

(When you capture video, 1 GB is needed for data of approx. 4 minutes.)

Interface:

DV (IEEE1394) terminal (IEEE1394.a)

USB terminal (Hi-Speed USB (USB 2.0) compliant) (A type)

Necessary software:

DirectX 9.0b/9.0c

Windows Media Player 6.4 to 10

Other requirements:

Mouse

- This software is not compatible with a multi-CPU environment.
- This software is not compatible with a multi-boot environment.
- Operation on Microsoft Windows XP Media Center Edition, Tablet PC Edition and 64 bit operating system is not guaranteed.

■ Installing USB Driver

Install this when your OS is Windows 2000 SP4. (When your OS is Windows XP SP2, installing USB driver is not needed.) USB Driver must be installed when you connect the Camcorder to the PC with the USB cable and use Quick Movie Magic or MotionDV STUDIO.

DirectX 9.0b is installed in your PC if it is not installed beforehand.

- When DirectX 9.0b is installed, applications supported by previous versions of DirectX may not run. In this case, consult the manufacturers of the applications disabled.

1 Insert the supplied CD-ROM into the personal computer's CD-ROM drive.

- Quit all applications.
- [Setup Menu] appears.

2 Click [USB Driver].

- The set up program starts running.

3 Depending on your system environment, installation of "DirectX 9.0b" may be required. Click [Yes] and continue with installation.

- After "DirectX 9.0b" is installed, the computer will restart.
- Do not remove the CD-ROM.
- Installation may take a little while.

4 Finish installation by following the on-screen instructions.

- Click [Next] and proceed with installation.
- After completing the installation, Click [Finish].

5 Click [OK].

Installation of Quick Movie Magic/ MotionDV STUDIO

1 Insert the supplied CD-ROM into the personal computer's CD-ROM drive.

- Quit all applications.
- [Setup Menu] appears.

2 Click the [Quick Movie Magic]/ [MotionDV STUDIO].



3 Click [Next].

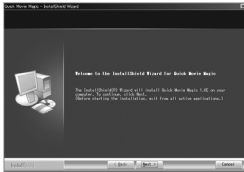

- After reading the displayed contents, please carry out the installation according to instructions.

4 Select the Video system.

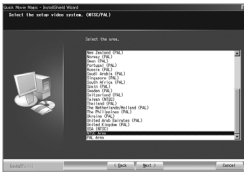

5 After the completion of setup, click on [Finish].

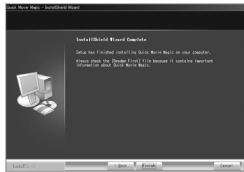

- Sample data is installed concurrently with the Quick Movie Magic/MotionDV STUDIO software.

6 Click [Finish].

To start Quick Movie Magic or MotionDV STUDIO

If you wish to capture data from a tape, set the Camcorder to Tape Playback Mode and insert the tape.

If you wish to capture images from the lens of the Camcorder, set the Camcorder to the Tape Recording Mode and remove the tape and the card. (MotionDV STUDIO only)

About the PDF operating instructions for Quick Movie Magic/MotionDV STUDIO

For details on how to use the software applications, read the help file.

1 Set [start] >> [All Programs (Programs)] >> [Panasonic] >> [Quick Movie Magic 1.0E] or [MotionDV STUDIO 5.6E LE for DV] >> [Manual (PDF format)].

- Start Quick Movie Magic/MotionDV STUDIO and select [Help] >> [Help] from the menu to display the help file.
- You will need Adobe Acrobat Reader 5.0 or later to read the PDF operating instructions.

With USB cable (supplied)

OS:

Windows XP SP2

Windows 2000 SP4

- The personal computer should be equipped with an USB terminal (Hi-Speed USB (USB 2.0) compliant) (A type).

Confirmation before connection (for Windows 2000/XP)

When you connect the personal computer and the Camcorder with the USB cable and then use Quick Movie Magic or MotionDV STUDIO on Windows XP SP2 or Windows 2000 SP4, check the driver of the USB host controller.

- It is required to use the driver for which [Microsoft] is displayed on [Driver Provider] in [Driver] tab.

1 Select [start] >> [Settings] >> [Control Panel] to start [System].

- [System Properties] is displayed.

2 Click [Hardware] tab and then click [Device Manager] then [Universal Serial Bus Controller].

3 Right-click [Enhanced Host Controller] and then select [Properties].

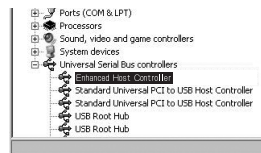

- The indication [Enhanced Host Controller] is changed as [EHCI] depending on the host controller you use.

4 Click [Driver] tab to check the description on [Driver Provider].



- If [Microsoft] is displayed on [Driver Provider], the confirmation procedure is completed.

If a description other than [Microsoft] is displayed

- Update the driver with the following procedure.
- 1 Click [Update Driver...].**



2 Check [Install from a list or specific location (Advanced)] and then click [Next].



- When your OS is Windows 2000, click [Next] after [Update Device Driver Wizard] appears.

3 (For Windows XP Users)

Check [Don't search. I will choose the driver to install] and then click [Next].

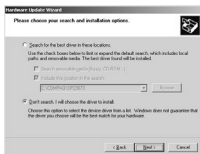

(For Windows 2000 Users)

Check [Display a list of the known drivers for this device so that I can choose a specific driver] and then click [Next].

4 Click [Standard Universal PCI to USB Host Controller] and then click [Next].



5 Click [Finish].

- The update of the driver is completed. Connect the Camcorder.

Connecting the Camcorder to a personal computer

- 1 Set the Mode Dial to Tape Recording Mode or Tape Playback Mode.**
- 2 Set [BASIC] or [ADVANCED] >> [USB FUNCTION] >> [MOTION DV].**



3 Connect the Camcorder to the personal computer with USB cable.

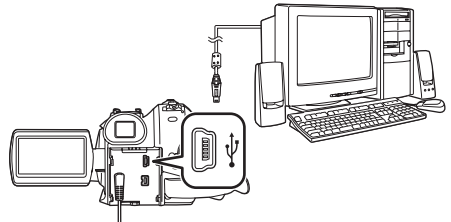

4 Select [start] >> [All Programs (Programs)] >> [Panasonic] >> [Quick Movie Magic 1.0E] or [MotionDV STUDIO 5.6E LE for DV] >> [Quick Movie Magic] or [MotionDV STUDIO LE for DV].

- Using the MotionDV STUDIO for Windows, a variety of visual effects can be added and titles can be created.
- You cannot record a video edited by the PC onto the tape in the Camcorder.
- When 2 or more USB devices are connected to a personal computer or when devices are connected through USB hubs or by using extension cables, proper operation is not guaranteed.
- When connected to the keyboard USB terminal, normal function may not be possible.

With DV cable (optional)**OS:**

Windows 2000/XP

- 1 Set the Mode Dial to Tape Recording Mode or Tape Playback Mode.
- 2 Connect the Camcorder to the personal computer with DV cable.

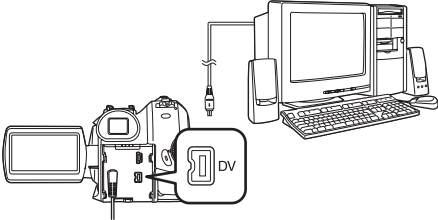

- 3 Select [start] >> [All Programs (Programs)] >> [Panasonic] >> [Quick Movie Magic 1.0E] or [MotionDV STUDIO 5.6E LE for DV] >> [Quick Movie Magic] or [MotionDV STUDIO LE for DV].
- You can record the video edited by the PC onto the tape in the Camcorder.

Using on Macintosh**Operating environment on iMovie 4/ iMovie HD****OS:**

Mac OS X v 10.3 to v 10.4

CPU:PowerPC G3 (400 MHz or higher), G4, G5
Intel Core Duo, Intel Core Solo**Interface:**

DV (FireWire) terminal (IEEE1394.a)

- The supplied CD-ROM is available for Windows only.
- iMovie/iMovie HD, included with any new Macintosh or sold with iLife.

- 1 Set the Camcorder to Tape Playback Mode.
- 2 Connect the Camcorder to your Macintosh with the DV Interface Cable (optional).

- For more information, please contact Apple Computer, Inc. at <http://www.apple.com>.

Copying still pictures on PC

- 1 Set the Camcorder to PC Connection Mode.
- 2 Connect the Camcorder to the personal computer via the supplied USB cable.
- 3 Double-click [NO_NAME] or [Untitled] displayed on the desktop.
 - Files are stored in [100CDPFP] folder in the [DCIM] folder.

- 4 Using a drag-and-drop operation, move the pictures you want to acquire or the folder storing those pictures to any different folder on the personal computer.

To disconnect USB cable safely

If USB cable is disconnected while the computer is on, error dialog box may appear. In such a case click [OK] and close the dialog box. By following the steps below you can disconnect the cable safely.

- 1 Double click the  icon in task tray.
 - The hardware disconnection dialog box appears.



- 2 Select [USB Mass Storage Device] and click [Stop].
- 3 Verify [Matshita DVC USB Device] is selected and click [OK].



- You can safely disconnect the cable.

Note on the driver name displayed

The driver name displayed will differ depending on your OS, operating environment and the mode of the Camcorder.

- Make sure Camcorder's Card Access Lamp is off and disconnect the cable. Also, the icon will not be displayed when in Tape Recording Mode or Tape Playback Mode.

CAUTION:

If you disconnect the USB cable while the Card Access Lamp is on, it may damage the Card data.

If the above operation is not performed correctly, when data is copied from the personal computer to an SD Card, the copied data may be damaged. When the following operations are performed, the same results will occur as when the USB cable is incorrectly removed (above). Therefore, it is imperative that the above operation is completed before proceeding.

- When SD Card is removed.

- When Camcorder power is turned OFF.

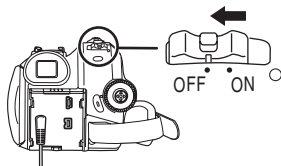

- When Mode Dial is turned to change modes.

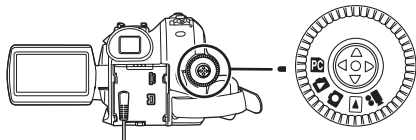

When using on Macintosh

Drag the [NO_NAME] or [Untitled] disk icon to the [Trash] and then disconnect the USB cable.

If you no longer need software or driver (Uninstall)

- 1 Select [start] (>> [Settings]) >> [Control Panel], select the software or the driver from [Add/Remove Programs] to uninstall.
- Uninstalling steps may vary depending on the OS. Please refer to the user manual of your OS.

Notes

- Microsoft® and Windows® are either registered trademarks or trademarks of Microsoft Corporation in the United States and/or other countries.
- Intel®, Pentium®, Intel® Core™ Duo and Intel® Core™ Solo are the registered trademarks or trademarks of the Intel Corporation.
- Apple, Mac OS, iMovie/iMovie HD, FireWire are either registered trademarks or trademarks of Apple Computer, Inc. in the United States and/or other countries.
- All other names, company names, product names, etc. in these instructions are the trademarks or registered trademarks of their respective corporations.
- Microsoft product screen shot(s) reprinted with permission from Microsoft Corporation.
- The names of the products you are using may differ from the names given in the text. Depending on the operating environment and other factors, the contents of the screens used in these instructions may not necessarily match what you will see on your screen.
- Although the screens in these Operating Instructions are shown in English for the sake of example, other languages are supported as well.
- These instructions do not cover the basic operations of the personal computer or define any terms. For this information, refer to the Operating Instructions which accompany your personal computer.
- Do not disconnect USB cable while the status indicator of Camcorder is on. It may freeze the software or destroy the data in transfer.
- If the Camcorder is used as a Web Camera while virus checking software is running, the Camcorder's operation may stop midway through. In this case, exit the Messenger, reconnect the Camcorder and restart the Messenger.
- Do not delete the folders in Memory Card such as picture folder. Memory card may not be recognized if folders are deleted.
- When the Camcorder is switched to the PC Connection Mode while it is connected to the personal computer, the operation mode of the Camcorder cannot be switched. In this case, disconnect the USB cable. Switch the operation mode of the Camcorder and reconnect the cable.

- If you install the USB driver while the USB cable is connected or if you do not follow these Operating Instructions, the Camcorder will not be recognized correctly. In this case, delete the driver from [Device Manager] as described below, uninstall the driver and re-install it. Set the Camcorder to Tape Recording Mode, Tape Playback Mode or PC Connection Mode, connect it to the personal computer and delete [DVC] or [Web-Camera] from [Device Manager].

Depending on your personal computer, one of the following screens may appear.

- 1 Your personal computer does not support USB 2.0 (Hi-Speed) so the video on tape cannot be imported from the Camcorder to the personal computer with the USB cable. Connect to an USB interface port etc.
 - You can use the WEB camera function.



- 2 The personal computer has recognized a USB 2.0 (Hi-Speed) driver other than the Microsoft driver. Update the driver to make sure that it operates properly. -59-



- 3 The USB 2.0 (Hi-Speed) driver may not be recognized correctly. Update the driver to make sure that it operates properly. -59-

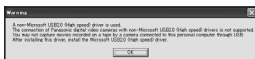

About the SD Card

The SD Card is an external Memory Card that is available in various capacities. It has a write protect switch to prevent data writing and card formatting, as well as a copyright protection function.

- SDHC Logo is a trademark.
- miniSD Logo is a trademark.
- All other company and product names in the operating instructions are trademarks or registered trademarks of their respective corporations.

Files recorded on a SD Card

It may not be possible to play back the files on this Camcorder recorded on and created by other equipment or vice versa. For this reason, check the compatibility of the equipment in advance.

About the compatibility of the card files

Data files recorded on an SD Card by this Camcorder conform with DCF (Design rule for Camera File system) established by JEITA (Japan Electronics and Information Technology Industries Association).

- If you attempt to play back files recorded with this Camcorder on other equipment or to play back files recorded with other equipment on this Camcorder, you may not be able to play them back. Please check the compatibility with the other equipment in advance.

About the folder structure when using the Memory Card in a personal computer

- When a Card with data recorded on it is inserted into a personal computer, folders will be displayed as shown in the following figure.

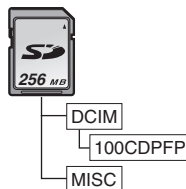

[100CDPFP]: The images (IMGA0001.JPG, etc.) in this folder are recorded in the JPEG format.

[MISC]: Files in which DPOF Data has been set to the image are in this folder.

- [DCIM] etc. are necessary items in the folder structure. They have nothing to do with actual operation.
- In Card Mode, the Camcorder automatically saves file numbers (IMGA0001.JPG, etc.) along with the images. The file numbers are recorded with each image as consecutive numbers.
- When using the software without indication function, indication data, such as date, are not displayed. Depending on the software in use, the date and the time may not be displayed correctly.
- The memory capacity indicated on the SD Card label corresponds to the total card capacity. Some of this capacity is used to protect and manage the copyright data and not all capacity is available as conventional memory for a Camcorder, personal computer or others.

Menu

Menu list

Menu figures and illustrations are provided for easy-to-understand explanations and so they are different from the actual menu indications.

■ [TAPE RECORDING MENU]

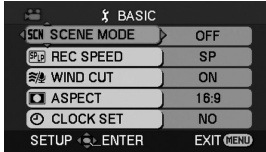

- 1) [BASIC]
 - [SCENE MODE] -38-
 - [REC SPEED] -28-
 - [WIND CUT] -36-
 - [ASPECT] -37-
 - [CLOCK SET] -17-
- 2) [ADVANCED]
 - [PICT.QUALITY] -32-
 - [PICTURE SIZE] -30-
 - [O.I.S.] -38-
 - [GUIDE LINES] -38-
 - [FADE COLOR] -36-
 - [AUDIO REC] -65-
 - [USB FUNCTION] -55-
 - [D.ZOOM] -33-
 - [ZOOM MIC] -33-
- 3) [SETUP]
 - [DISPLAY] -65-
 - [DATE/TIME] -65-
 - [POWER SAVE] -29-
 - [QUICK START] -19-
 - [AGS] -36-
 - [REMOTE] -27-
 - [BEEP SOUND] -65-
 - [POWER LCD] -25-
 - [LCD SET] -25-
 - [EVF SET] -25-
 - [INITIAL SET] -65-
 - [DEMO MODE] -65-
- 4) [LANGUAGE] -24-

■ [TAPE PLAYBACK MENU]

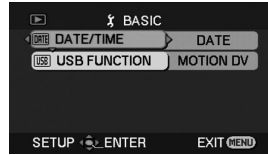

- 1) [BASIC]
 - [DATE/TIME] -65-
 - [USB FUNCTION] -55-
- 2) [ADVANCED]
 - [REC SPEED] -28-
 - [REC STDBY] -48-
 - [REC DATA] -65-
 - [PICT.QUALITY] -32-
 - [REPEAT PLAY] -42-
- 3) [SETUP]
 - [12bit AUDIO] -50-
 - [AUDIO OUT] -65-
 - [DISPLAY] -65-
 - [REMOTE] -27-
 - [POWER LCD] -25-
 - [LCD SET] -25-
 - [EVF SET] -25-
 - [POWER SAVE] -29-
 - [TV ASPECT] -44-
- 4) [LANGUAGE] -24-

■ [CARD RECORDING MENU]

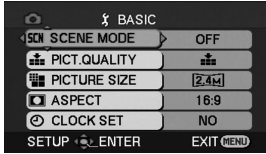

1) [BASIC]

- [SCENE MODE] -38-
- [PICT.QUALITY] -32-
- [PICTURE SIZE] -31-
- [ASPECT] -37-
- [CLOCK SET] -17-

2) [ADVANCED]

- [O.I.S.] -38-
- [GUIDE LINES] -38-
- [SHTR EFFECT] -32-

3) [SETUP]

- [DISPLAY] -65-
- [DATE/TIME] -65-
- [POWER SAVE] -29-
- [QUICK START] -19-
- [REMOTE] -27-
- [BEEP SOUND] -65-
- [POWER LCD] -25-
- [LCD SET] -25-
- [EVF SET] -25-
- [INITIAL SET] -65-

4) [LANGUAGE] -24-

■ [CARD PLAYBACK MENU]

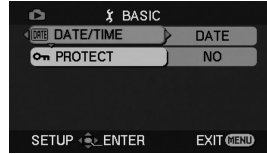

1) [BASIC]

- [DATE/TIME] -65-
- [PROTECT] -46-

2) [ADVANCED]

- [DPOF SET] -46-
- [FORMAT CARD] -46-

3) [SETUP]

- [DISPLAY] -65-
- [REMOTE] -27-
- [POWER LCD] -25-
- [LCD SET] -25-
- [EVF SET] -25-
- [POWER SAVE] -29-
- [TV ASPECT] -44-

4) [LANGUAGE] -24-

Menus related to taking pictures

■ [DATE/TIME]

This switches between date and time indications.

- The Camcorder automatically records the date and time the picture was taken on the tape/card.
- You can also show or change the date/time indication by repeatedly pressing the [DATE/TIME] button on the remote control.

■ [AUDIO REC]

Switches the audio (PCM audio) recording systems.

[12bit]: Records audio in "12 bit 32 kHz 4 tracks".
(The original audio signals can be kept after the other audio signals are dubbed.)

[16bit]: Records audio in "16 bit 48 kHz 2 tracks".
Audio can be recorded in higher quality.
(If audio signals are dubbed, then the original audio signals will be erased.)

■ [DISPLAY]

Set to [ON] and the display mode can be switched to all functions. Set to [OFF] and it can be switched to minimum display.

■ [BEEP SOUND]

Set to [ON] and confirmation/alarm beeps are issued as follows.

1 Beep

- When you start recording
- When you turn on the power
- When the unit goes from quick start standby mode to recording pause

2 Beeps

- When you pause recording
- When you turn off the power
- When the unit goes into quick start standby mode

2 Beeps for 4 times

- When a cassette with its erasure prevention tab set to [SAVE] is inserted, condensation occurs (-72-) and at other times. Check the sentence displayed on the screen. (-67-)

Menus related to playback

■ [REC DATA]

Set to [ON] and the settings (shutter speed, iris/gain values and white balance settings (-39-), etc.) used during the recordings are displayed during playback.

- If the [AUTO/MANUAL/FOCUS] switch was set to [AUTO] when recording, [AUTO] appears on the display.
- When there is no data, [---] appears on the display.
- If data recorded on this unit is played back on other equipment (or a tape recorded on other equipment is played back on this unit), the settings information is sometimes not displayed normally.

■ [AUDIO OUT]

This switches the sound to be played back.

[STEREO]: Stereo sound (main sound and sub sound)

[L]: Left channel sound (main sound)

[R]: Right channel sound (sub sound)

Other menus

■ [INITIAL SET]

When there is a menu that cannot be selected depending on a combination of functions, set to [YES] for changing the menu settings back to the initial shipping condition.

(Language setting cannot be back to the initial shipping condition.)

■ [DEMO MODE]

If you set to [DEMO MODE] >> [ON] without inserting a cassette and a card, the Camcorder is automatically set to the demonstration mode for introducing its functions. If any button is pressed or operated, the demonstration mode is canceled. If no operations take place for approx.

10 minutes, the demonstration mode automatically starts. To terminate the demonstration mode, insert a cassette or a card or set to [DEMO MODE] >> [OFF]. For normal use, set this function to [OFF].

Others























Indications



Various functions and the Camcorder status are shown on the screen.

Basic indications



- : Remaining battery power
- 0h00m00s00f: Time code
- 3:30:45PM: Date/Time indication

Recording indications



















- RO:45: Remaining tape time
- Remaining tape time is indicated in minutes.
(When it reaches less than 3 minutes, the indication starts flashing.)
- SP: Standard Play mode
(Recording speed mode) -28-
- LP: Long Play mode
(Recording speed mode) -28-
- : Recording -29-
- || (Green): Recording pause -29-
- || (Green flash): Standby mode
- || (Red): Fade out
- : POWER LCD -25-
- : Recording check -30-
- : Wide mode -37-
- : Automatic mode -28-
- : Manual mode -38-
- MF: Manual focus -40-
- 5×: Zoom magnification indication
-32-
- : Backlight mode -33-
- : Optical image stabilizer -38-
- 1/500: Shutter speed -41-
- F2.4: F number -41-
- 6dB: Gain value -41-
- : WEB CAMERA mode
(Recording) -51-
- : Soft skin mode -34-
- : Tele macro -35-
- : Fade (White) -35-
- : Fade (Black) -35-
- : Blank search -30-
- : MagicPix function -34-
- : Zoom microphone -33-
- : Wind noise reduction -36-
- : Sports mode (Scene mode) -38-
- : Portrait mode (Scene mode) -38-
- : Low light mode (Scene mode)
-38-
- : Spotlight mode (Scene mode)
-38-
- : Surf & snow mode (Scene mode)
-38-
- : Auto white balance -39-

- : Indoor mode (recording under incandescent lamp) -39-
- : Outdoor mode -39-
- : White balance adjustment mode
-39-

Playback indications

- : Recording underway
- ▶: Playback -42-
- ||: Pause -42-
- ▶▶: Fast forward/Cue playback -42-
- ◀◀: Rewind/Review playback -42-
- ▶/◀: Slow motion playback -43-
- |||/◀|||: Frame-by-frame playback -43-
- 2×▶▶: Variable-speed search -43-
- : Repeat playback -42-
- : WEB CAMERA mode (Playback)
-51-
- A.DUB ●: Audio dubbing -49-
- A.DUB ||: Audio dubbing pause -49-
- 12bit, 16bit: Audio recording mode -65-
- : Volume adjustment -42-

Card







- (White): Shutter chance mark -31-
- (Green): Shutter chance mark -31-
- : MEGA Optical Image Stabilizer
-31-
- : Self-timer recording -37-
-  (White): Photoshot mode
-  (Green): While the card is being read
-  (Red): While photoshot recording is activated
-  (Red): While the card is being accessed in PC Connection Mode
-  (Red flash): Using a card that cannot be recognized
-  (. . .): Photoshot picture quality -32-
- 18: Remaining number of photoshot pictures (When the remaining number of photoshot pictures reaches 0, the red indication flashes.)
- : Slide show playback -44-
- : PictBridge mode -50-
- 100-0001: Folder/File display
- No.00: File number
-  1: Number of DPOF Setting -46-
- : Protect setting -46-
-  0.2M: [640×360] Image size
-  1M: [1280×720] Image size
-  2.4M: [2048×1152] Image size
-  0.3M: [640×480] Image size
-  1M: [1280×960] Image size
-  2M: [1600×1200] Image size
-  3.1M: [2048×1512] Image size

- For images not recorded with this unit, the number of horizontal and vertical pixels may differ so the image size is not displayed.



Warning/alarm indications

If any one of the following indications lights up or flashes, please check the Camcorder.

Confirmatory indications

- : A cassette with the accidental erasure prevention slider placed in the [SAVE] position is inserted.
No cassette is inserted.
- : The built-in battery is low. -17-
- : The warning/alarm indication appears when you record yourself. Turn the LCD monitor towards the viewfinder and check the warning/alarm indication.
- : No card is inserted.
- REMOTE :
An incorrect remote control mode has been selected. -27-
- END:
The tape came to the end during recording.
- : The video heads are dirty. -72-

Textual indications

-  DEW DETECT/ EJECT TAPE:
Condensation has occurred. Take out the cassette and wait for a while. It takes some time until the cassette holder opens, but this is not a malfunction. -72-
- LOW BATTERY:
The battery is low. Recharge it. -15-
- NO TAPE :
No tape is inserted. -20-
- TAPE END:
The tape came to the end during recording.
- CHECK REC TAB:
You are attempting to record pictures on a tape with the accidental erasure prevention slider placed in the [SAVE] position. You are attempting audio dubbing or digital dubbing on a tape with the accidental erasure prevention slider placed in the [SAVE] position. -20-
- CHECK REMOTE MODE:
An incorrect remote control mode has been selected. This is only displayed at the first operation of the remote control after powering-on. -27-

WRONG TAPE FORMAT:

You are attempting to play back a tape section that has been recorded with a different TV system. This cassette is incompatible.

UNPLAYABLE CARD:

You are attempting to play back data not compatible with this Camcorder.

CLOSE CASSETTE DOOR:

The cassette cover is open. Close the cassette cover. -20-

UNABLE TO A.DUB (LP RECORDED):

Audio dubbing cannot be performed because the original recording was in LP mode.

UNABLE TO A.DUB:

You are attempting to perform audio dubbing on a non-recorded tape.

CANNOT RECORD IN AGS MODE:

The AGS function is activated. -36-

COPY PROTECTED:

Images cannot be recorded correctly because the medium is protected by a copy guard.

CARD ERROR:

This card is not compatible with this Camcorder.

You are attempting to format a failed card. This message is displayed when you attempt to insert an incompatible card into the Card Slot.

NO CARD:

No card is inserted.

CARD FULL:

Card does not have sufficient memory remaining.
Select Card Playback Mode and delete unnecessary files.

NO DATA:

There are no any recorded files on the card.

FILE LOCKED:

You are attempting to erase protected files.

CARD LOCKED:

The write protection switch on the SD Card is set to [LOCK].

NEED HEAD CLEANING:

The video heads are dirty. -72-

PUSH THE RESET SWITCH:

An irregularity in the equipment has been detected. Press the [RESET] button (-71-). This may solve the problem.

CHANGE MODE TO USE USB:

The USB cable is connected to the Camcorder in Card Recording Mode.

DISCONNECT USB CABLE:

You are attempting to turn the mode dial in PC Connection Mode with the USB cable connected to the Camcorder. You are attempting to record pictures on a tape/card with the USB cable connected to the Camcorder.

NO INK IN PRINTER:

There is no ink. Check the connected printer.

NO PAPER IN PRINTER:

There is no paper. Check the connected printer.

PRINTER ERROR:

Check the connected printer.

PC DOES NOT SUPPORT USB2.0:

The Camcorder is connected to a personal computer that does not support USB 2.0.

CAN NOT USE USB:

You are connecting the USB cable with the DV cable connected.

CHANGE TO MANUAL MODE:

You are attempting to select the item on the [SCENE MODE] when the [AUTO/MANUAL/FOCUS] switch is set to [AUTO].

CAN NOT OPERATE (MOTION DV MODE):

You are attempting to change [D.ZOOM] setting during MotionDV Mode.

Functions that cannot be used simultaneously

Some functions in the Camcorder are disabled or cannot be selected due to its specifications. The table below shows examples of functions restricted by conditions.

Functions	Conditions which disable the functions
<ul style="list-style-type: none"> ● Digital zoom ● Fade 	<ul style="list-style-type: none"> ● When the Card Recording mode is used
<ul style="list-style-type: none"> ● Backlight compensation 	<ul style="list-style-type: none"> ● When the MagicPix function is used ● When the iris/gain is set
<ul style="list-style-type: none"> ● Help mode ● Recording check ● Blank search ● Soft skin ● Tele macro 	<ul style="list-style-type: none"> ● While recording to a tape
<ul style="list-style-type: none"> ● MagicPix 	<ul style="list-style-type: none"> ● While recording to a tape ● When the Card Recording mode is used
<ul style="list-style-type: none"> ● Scene mode 	<ul style="list-style-type: none"> ● When setting the [AUTO/MANUAL/FOCUS] switch to [AUTO] ● When the MagicPix function is used
<ul style="list-style-type: none"> ● Change of white balance 	<ul style="list-style-type: none"> ● When digital zoom (10× or higher) is used ● When the MagicPix function is used
<ul style="list-style-type: none"> ● Adjusting the shutter speed, iris/gain 	<ul style="list-style-type: none"> ● When the MagicPix function is used ● When the scene mode is used
<ul style="list-style-type: none"> ● Variable-speed search 	<ul style="list-style-type: none"> ● During repeat playback
<ul style="list-style-type: none"> ● Deleting files 	<ul style="list-style-type: none"> ● When the write protect switch on the card is set to [LOCK] ● When the file is protected
<ul style="list-style-type: none"> ● Formatting 	<ul style="list-style-type: none"> ● When the write protect switch on the card is set to [LOCK]

<ul style="list-style-type: none"> ● Audio dubbing 	<ul style="list-style-type: none"> ● The section of a tape recorded in LP mode ● The blank section of a tape ● Sounds sent through the DV terminal
---	---

Before requesting repair (Problems and solutions)

Power/Body

1: The Camcorder power cannot be turned on.

- Is the battery fully charged? Use a fully charged battery.
- The battery protection circuit may have operated. Attach the battery to the AC adaptor for 5 to 10 seconds. If the Camcorder still cannot be used, the battery is faulty.
- Is the LCD monitor opened or the viewfinder extended?

2: The Camcorder power is turned off automatically.

- If you set [POWER SAVE] to [5 MINUTES] and do not operate the Camcorder for about 5 continuous minutes, the power is automatically turned off for tape protection and power conservation. To resume recording, turn the [OFF/ON] switch to [OFF]. Then turn it to [ON] again. (-29-) Also, if you set [POWER SAVE] to [OFF], the power does not automatically turn off.

3: The Camcorder power does not stay on long enough.

- Is the battery low? If the remaining battery power indication is flashing or the message "LOW BATTERY" is displayed, the battery has run down. Charge the battery or attach a fully charged battery. (-15-)
- Has condensation occurred? When you carry the Camcorder from a cold place into a warm place, condensation may occur inside it. If so, the power is turned off automatically, disabling all operations except for taking cassettes out. Wait until the condensation indication disappears. (-72-)

4: Battery runs down quickly.

- Is the battery fully charged? Charge it with the AC adaptor. (-15-)
- Are you using the battery in an extremely cold place? The battery is affected by ambient temperature. In cold places, the operating time of the battery becomes shorter.
- Has the battery worn out? The battery has a limited life. If the operating time is still too short even after the battery is fully charged, depending on the usage, the battery has worn out and can no longer be used.

5: The Camcorder cannot be operated though powered up.

The Camcorder does not operate normally.

- The Camcorder cannot be operated unless you open the LCD monitor or extend the viewfinder.
- Remove the cassette and the card and then press the [RESET] button. (-71-) If normal conditions are not restored yet, turn off the power. Then, about 1 minute later, turn on the power again. (Conducting the above operation when the access lamp is on may destroy the data on the card.)

6: The cassette cannot be removed.

- Does the status indicator comes on when opening the cassette cover? (-16-) Make sure that the battery and the AC adaptor are properly connected. (-15-)
- Is the battery in use discharged? Charge the battery and remove the cassette.
- Close the cassette cover completely and fully open it again. (-20-)

7: No operation other than cassette removal can be performed.

- Has condensation occurred? Wait until the condensation indication disappears. (-72-)

8: The remote control does not function.

- Has the button-type battery of the remote control run out? Replace it with a new button-type battery. (-26-)
- Is the setting on the remote control correct? If the setting on the remote control is not in agreement with the [REMOTE] setting on the Camcorder, the remote control does not operate. (-27-)

Recording

1: Recording does not start although power is supplied to the Camcorder and the cassette is correctly inserted.

- Is the accidental erasure prevention slider on the cassette open? If it is open (set to [SAVE]), recording cannot be performed. (-20-)
- Is the tape wound to the end? Insert a new cassette.
- Is the recording mode set? When in the playback mode, recording cannot be performed. (-21-)
- Has condensation occurred? No operation other than cassette removal can be performed when condensation occurs. Wait until the condensation indication disappears. (-72-)
- Is the cassette cover open? If the cover is open, the Camcorder may not operate normally. Close the cassette cover. (-20-)

2: The screen has changed suddenly.

- Has the demonstration started? In the Tape Recording mode, if you set [DEMO MODE] >> [ON] without inserting a cassette and a card, the demonstration starts. For normal use, set this function to [OFF]. (-65-)

3: A cassette cannot be inserted.

- Has condensation occurred? Wait until the condensation indication disappears.

4: Auto focus function does not work.

- Is manual focus mode selected? If auto focus mode is selected, focus is automatically adjusted.
- There are some recording subjects and surroundings for which the auto focus does not operate correctly. (-76-) If so, use the manual focus mode to adjust the focus. (-40-)

5: The Camcorder arbitrarily stops recording.

- Is the AGS function activated? Record in the normal horizontal position or set [AGS] to [OFF]. (-36-)

Indications**1: A sentence is displayed in red in the screen center.**

- Read the contents and respond to them. (-67-)

2: The time code becomes inaccurate.

- The time code indication counter may not be constant in the reversed slow-motion playback, but this is not a malfunction.

3: The remaining tape time indication disappears.

- The remaining tape time indication may disappear temporarily during frame-by-frame playback or other operation. If you continue ordinary recording or playback, the indication is restored.

4: The remaining tape time indication does not match the actual remaining tape time.

- If scenes of less than 15 seconds are continuously recorded, the remaining tape time cannot be correctly displayed.
- In some cases, the remaining tape time indication may show remaining tape time that is 2 to 3 minutes shorter than the actual remaining tape time.

5: A function indication such as mode indication, remaining tape time indication or time code indication is not shown.

- If you set [SETUP] >> [DISPLAY] >> [OFF], indications other than the tape running condition, warning and date indications disappear.

Playback (Sound)**1: Sound is not played back from the built-in speaker of the Camcorder.**

- Is the volume too low? During playback, push the [-VOL+] lever to display the volume indication and adjust it. (-42-)

2: Different sounds are reproduced at the same time.

- Have you set [SETUP] >> [12bit AUDIO] >> [MIX]? If you set [AUDIO REC] >> [12bit] and dub audio to a recorded tape, you can hear the sound on recording and the sound dubbed at a

later time. To hear the sounds separately, set to [ST1] or [ST2]. (-50-)

- Have you set [SETUP] >> [AUDIO OUT] >> [STEREO] and reproduced a picture containing the main sound and sub sound? Set to [L] to hear main sound and set to [R] to hear the sub sound. (-65-)

3: Audio dubbing cannot be performed.

- Is the accidental erasure prevention slider on the cassette open? If it is open (set to [SAVE]), audio dubbing cannot be performed. (-20-)
- Are you attempting to edit a tape portion that was recorded in LP mode? LP mode does not allow audio dubbing. (-28-)

4: The original sound was erased when audio dubbing was performed.

- If you perform audio dubbing on a recording made in [16bit] mode, the original sound will be erased. If you wish to preserve the original sound, be sure to select [12bit] mode when recording.

5: Sounds cannot be played back.

- Although a cassette with no audio dubbing is being played, have you set [SETUP] >> [12bit AUDIO] >> [ST2]? To play back a cassette with no audio dubbing, set [12bit AUDIO] >> [ST1]. (-50-)
- Is the variable speed search function working? Press the [VAR SEARCH] button on the remote control to cancel the variable speed search function. (-43-)

Playback (Pictures)**1: Although the Camcorder is correctly connected to a TV, playback images cannot be seen. The playback images are vertical.**

- Have you selected video input on the TV? Please read the operating instructions of your TV and select the channel that matches the input terminals used for the connection.
- Is the [TV ASPECT] setting correct? Change the setting to match the aspect ratio of the TV. [SETUP] >> [TV ASPECT] >> [16:9] or [4:3].

2: Mosaic-pattern noise appears on images during cue or review playback.

- This phenomenon is characteristic of digital video systems. It is not a malfunction.

3: Horizontal stripes appear on images during cue and review playback.

- Horizontal stripes may appear depending on the scene, but this is not a malfunction.

4: Playback picture is not clear.

- Are the heads of the Camcorder dirty? If the heads are dirty, playback image cannot be clear. Clean the heads by using the head cleaner for digital video (optional). (-72-)
- If the terminal for the Multi cable is soiled, noises may appear on the screen. Wipe the soil

off the terminal with a soft cloth and then connect the cable to the A/V terminal.

- Is a picture containing a copyright protection signal (copy guard) being recorded? When a protected picture is played back by the Camcorder, mosaic-like patterns appear on the picture.

Card

1: Recorded pictures are not clear.

- Have you set [BASIC] >> [PICT.QUALITY] >> []? If recording is done with it set to [], pictures with fine details may include a mosaic-like pattern. Set [PICT.QUALITY] >> []. (-32-)

2: A file recorded on a card cannot be deleted.

- Is the file protected? Protected files cannot be deleted. (-46-)
- For the SD Card, if the write protect switch is set to [LOCK], then deletion is disabled. (-21-)

3: Photoshot playback images do not look normal.

- The picture may be damaged. In order to prevent the loss of image data, backing up on a cassette or a personal computer is recommended.

4: Even if a card is formatted, it cannot be used.

- Either the Camcorder or the card may be damaged. Please consult a dealer. Use an SD Card from 8 MB to 4 GB with this unit. (-79-)

5: During playback, [UNPLAYABLE CARD] is displayed.

- The image was either recorded in a different format or data is damaged.

6: When the SD card is inserted in another device, it is not recognized.

- Check that the device is compatible with the capacity or type of SD card (SD Memory Card/SDHC Memory Card) that you inserted. (-21-, -62-) Refer to the operating instructions of the device for details.

Others

1: The indication disappears, the screen is frozen or no operation can be performed.

- Turn off the power to the Camcorder. If the power cannot be turned off, press the [RESET] button or detach the battery or AC adaptor and then reattach it. After that, turn on the power again. If normal operation is still not restored, detach the power connected and consult the dealer who you purchased the Camcorder from.

2: "PUSH THE RESET SWITCH" is displayed.

- An irregularity in the Camcorder has been automatically detected. Remove the cassette or the card for data protection and then press the [RESET] button with the boss **A**. The Camcorder will be activated.

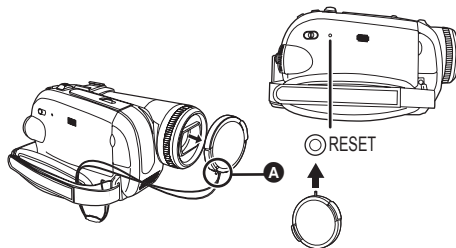

- If you do not press the [RESET] button, the power to the Camcorder is turned off automatically about 1 minute later.
- Even after you press the [RESET] button, the indication may still appear repeatedly. If so, the Camcorder needs repair. Detach the power connected and consult the dealer who you purchased the Camcorder from. Do not attempt to repair the unit by yourself.

3: Even if connected by the USB cable, the Camcorder is not recognized by the PC.

- Is the USB driver installed? (-54-)

4: When the USB cable is disconnected, an error message will appear on PC.

- To disconnect the USB cable safely, double-click the [] icon in the task tray and follow the instructions on the screen.

5: The Camcorder malfunctions on editing, dubbing from digital video equipment or using "MotionDV STUDIO 5.6E LE for DV" or "Quick Movie Magic 1.0E".

- If a tape is recorded in multiple modes such as SP and LP (recording mode), 12bit and 16bit (sound recording mode), 4:3 and wide, recorded and unrecorded parts, the Camcorder may malfunction at a point where the mode switches. When you edit, do not record in multiple modes.

6: The warning/alarm indication [!] appears when the Camcorder is operated in the WEB camera mode.

- Did you press the menu button or the recording start/stop button? You cannot use the menu or record onto the tape/card in the WEB camera mode.
- Is the setting for the remote control correct?
- Did you attempt to play a tape without inserting it? Insert a tape.
- Did you attempt to play a tape with copyright protection (copy guard)? Pictures of the tape with copyright protection (copy guard) cannot be displayed on the PC. (The audio of the tape can be played.)
- Is the USB driver installed? (-54-)

Cautions for Use

■ About condensation

If you turn the Camcorder on when condensation occurs on the head or the tape, condensation Indication [] (yellow or red) is displayed on the viewfinder or the LCD monitor and the messages [] DEW DETECT or [] EJECT TAPE (only when the tape is inserted) appear. If so, follow the procedure below.

1 Remove the tape if it is inserted.

- It takes about 20 seconds to open the cassette holder. This is not a malfunction.

2 Leave the Camcorder with the cassette cover closed and the battery attached, to cool or warm it to the ambient temperature.

- The status indicator blinks for about 1 minute and then the Camcorder automatically turns off. Leave it for about 1.5 to 2 hours.

3 Turn the Camcorder on again, set it to the Tape Recording/Playback Mode and then check if the condensation indication disappears.

Especially in cold areas, moisture may be frozen. If so, it may take more time before the condensation indication disappears.

Watch for condensation even before the condensation indication is displayed.

- If the indicator of the condensation does not display on the LCD screen and/or EVF and you notice condensation on the lens or the main unit, do not open the cassette cover otherwise condensation may be formed on the heads or the cassette tape.

When the lens is fogged:

Set the [OFF/ON] switch to [OFF] and leave the Camcorder in this condition for about 1 hour. When the lens temperature becomes close to the ambient temperature, the fogging disappears naturally.

■ About dirty heads

If video heads (the parts that closely contact with the tape) become dirty, normal recording and playback are not properly performed.

Clean the heads with the digital video head cleaner.

- Insert the head cleaner into the Camcorder, set it to the Tape Playback Mode and play it back for about 10 seconds. (If you do not stop the playback, it automatically stops about 15 seconds later.)
- We recommend cleaning the heads periodically.

If the heads become dirty, “NEED HEAD CLEANING” appears during recording. During playback, moreover, the following symptoms appear.

- Mosaic-like noise appears partially or the sound is interrupted.
- Black or blue mosaic-like horizontal stripes appear.
- The whole screen becomes blue and there is no picture or sound.

When normal playback cannot be performed even after the head cleaning

One possible cause is that normal recording could not be performed because the heads were dirty at the time of recording. Clean the heads and perform recording and playback again. If normal playback can be performed, the heads are clean. Before an important recording, be sure to conduct a test recording to make sure that normal recording can be performed.

- If the heads become dirty soon after cleaning, the problem may be the tape. If so, try another cassette.
- During playback, the picture or sound may be interrupted momentarily, but this is not a malfunction of the Camcorder. (One possible cause is that the playback is interrupted by dirt or dust that momentarily adheres to the heads.)

■ About the Camcorder

- When the Camcorder is used for a long time, the Camcorder body becomes warm, but this is not a malfunction.

Keep the Digital Video Camcorder as far away as possible from electromagnetic equipment (such as microwave ovens, TVs, video games etc.).

- If you use the Digital Video Camcorder on top of or near a TV, the pictures and sound on the Digital Video Camcorder may be disrupted by electromagnetic wave radiation.
- Do not use the Digital Video Camcorder near cell phones because doing so may result in noise adversely affecting the pictures and sound.
- Recorded data may be damaged, or pictures may be distorted, by strong magnetic fields created by speakers or large motors.
- Electromagnetic wave radiation generated by microprocessors may adversely affect the Digital Video Camcorder, disturbing the pictures and sound.
- If the Digital Video Camcorder is adversely affected by electromagnetic equipment and stops functioning properly, turn the Digital Video Camcorder off and remove the battery or disconnect AC adaptor. Then reinsert the

battery or reconnect AC adaptor and turn the Digital Video Camcorder on.

Do not use the Digital Video Camcorder near radio transmitters or high-voltage lines.

- If you record near radio transmitters or high-voltage lines, the recorded pictures and sound may be adversely affected.

Do not spray insecticides or volatile chemicals onto the Camcorder.

- If the Camcorder is sprayed with such chemicals, the Camcorder body may become deformed and the surface finish may peel off.
- Do not keep rubber or plastic products in contact with the Camcorder for a long time.

When you use your Camcorder in a sandy or dusty place such as on a beach, do not let sand or fine dust get into the body and terminals of the Camcorder. Also, protect the Camcorder from getting wet.

- Sand or dust may damage the Camcorder or cassette. (Care should be taken when inserting and removing a cassette.)
- If sea water splashes onto the Camcorder, wet a soft cloth with tap water, wring it well and use it to wipe the Camcorder body carefully. Then, wipe it again thoroughly with a soft dry cloth.

While carrying the Camcorder, do not drop or bump it.

- A strong impact on the Camcorder may break its housing, causing it to malfunction.

Do not use benzene, paint thinner or alcohol for cleaning the Camcorder.

- Before cleaning, detach the battery or pull out the AC cable from the AC jack.
- The Camcorder body may be discolored and the surface finish may peel off.
- Wipe the Camcorder with a soft dry cloth to remove dust and fingerprints. To remove stubborn stains, wring well a cloth that is soaked in a neutral detergent diluted with water and wipe the Camcorder with it. Afterwards, wipe it with a dry cloth.
- When you use a chemical dust cloth, follow the instructions.

Do not use this Camcorder for surveillance purposes or other business use.

- If you use the Camcorder for a long time, the internal temperature increases and, consequently, this may cause malfunction.
- This Camcorder is not intended for business use.

When you are not going to use Camcorder for an extended time

- When storing the unit in a cupboard or a cabinet, it is recommended that you put a desiccant (silica gel) in with it.

■ About the battery

The battery used in the Camcorder is a rechargeable lithium ion battery. This battery is susceptible to temperature and humidity and the effect of temperature increases with increasing or decreasing temperature. In the low temperature range, the fully charged indication may not appear or the low battery indication may appear about 5 minutes after the start of use. At high temperature, moreover, the protection function may work, disabling use of the Camcorder.

Be sure to detach the battery after use.

- If the battery is left attached to the Camcorder, a minute amount of current is consumed even when the Camcorder power is [OFF]. If the battery is left attached to the Camcorder for a long time, over-discharge takes place. The battery may become unusable after it is charged.
- The battery should be stored in a cool place free from humidity, with as constant temperature as possible. (Recommended temperature: 15 °C to 25 °C (59 °F to 77 °F), Recommended humidity: 40% to 60%)
- Extremely high temperatures or low temperatures will shorten the life of the battery.
- If the battery is kept in a high-temperature, high-humidity or oily-smoky places, the terminals may rust and cause malfunctions.
- To store the battery for a long period of time, we recommend you charge it once every year and store it again after you have completely used up the charged capacity.
- Dust and other matter attached to the battery terminals should be removed.

Prepare spare batteries when going out for recording.

- Charge batteries enough to last for 3 to 4 times the period during you want to record pictures in. In cold places such as a ski resort, the period during which you can record pictures is shortened.
- When you travel, do not forget to bring an AC adaptor so that you can recharge the batteries at your destination.

If you drop the battery accidentally, check to see if the terminals are deformed.

- Attaching a deformed battery to the Camcorder or AC adaptor may damage the Camcorder or AC adaptor.

Do not throw old battery into fire.

- Heating a battery or throwing it into a fire may result in an explosion.

If the operating time is very short even after the battery has been recharged, the battery has worn out. Please purchase a new battery.

■ About the AC adaptor

- If the battery is warm, charging requires more time than normal.
- If the temperature of the battery is extremely high or extremely low, the [CHARGE] lamp may continue flashing and the battery may not be charged. After the battery temperature has decreased or increased sufficiently, recharging starts automatically. So, wait for a while. If the lamp still continues flashing even after the recharging, the battery or AC adaptor may be faulty. If so, please contact a dealer.
- If you use the AC adaptor near a radio, radio reception may be disturbed. Keep the AC adaptor 1 m (3.3 feet) or more away from radio.
- When using the AC adaptor, it may generate whirring sounds. However, this is normal.
- After use, be sure to pull out the AC cable from the AC jack. (If they are left connected, a minute amount of current is consumed.)
- Always keep the electrodes of the AC adaptor and battery clean.

■ About the cassette

Never place the cassette in a high temperature place.

- The tape may be damaged, producing mosaic-like noise at the time of playback.

When storing the cassette after use, be sure to rewind the tape to the beginning and take it out.

- If the cassette is left for more than 6 months (depending on the storage condition) in the Camcorder or stopped midway, the tape may sag and be damaged.
- Once every 6 months, wind the tape to the end and then rewind it to the beginning. If the cassette is left for 1 year or longer without winding or rewinding, the tape may be deformed by expansion or shrinkage attributable to temperature and humidity. The wound tape may stick to itself.
- Dust, direct sunlight (ultraviolet rays) and humidity may damage the tape. Such usage may cause damage to the Camcorder and the heads.
- After use, be sure to rewind the tape to the beginning, put the cassette in the case to protect it from dust and store it upright.

Keep the cassette away from strong magnetism.

- Apparatus using magnets such as magnetic necklaces and toys have magnetic force that is stronger than expected and they may erase the contents of a recording or may increase noise.

■ About the card

When inserting or removing the card, always set the [OFF/ON] switch to [OFF].

When the access lamp is illuminated (During access to the card), do not pull out the card, rotate the mode dial, turn off the power or cause any vibrations or impact.

Do not leave the card in places where there is high temperature or direct sunlight or where electromagnetic waves or static electricity are easily generated. Moreover, do not fold or drop the card.

- The card may break or the contents of the card may be destroyed or erased.
- Do not touch the terminals on the back of the card.
- Electrical noise, static electricity or failure of the Camcorder or the card may damage or erase the data stored on the card. We recommend saving important data on a personal computer by using a USB cable, PC card adaptor and USB reader/writer.

After use, be sure to remove the card from the Camcorder for storage.

- After use or when storing or carrying the card, put it in the storage case.
- Do not allow dust, water or foreign substances to adhere to the terminals on the back of the card. Moreover, do not touch the terminals with your hand.
- Keep the Memory Card out of reach of children to prevent swallowing.

■ Folder structure of the card

The folder structure of the card formatted by the Camcorder will be displayed on the PC as the illustration below.

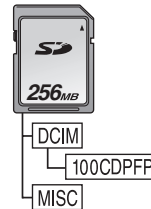

- Up to 999 pictures can be recorded on 100CDPFP folder etc.
- Files with the DPOF settings can be recorded on MISC folder.

LCD monitor/viewfinder

LCD monitor

- When the LCD monitor gets dirty, wipe it with a dry soft cloth.
- In a place with drastic temperature changes, condensation may form on the LCD monitor. Wipe it with soft dry cloth.
- If your Camcorder is extremely cold, the LCD monitor is slightly darker than usual immediately after you turn the power on. However, as the internal temperature increases, it goes back to normal brightness.

Extremely high precision technology is employed to produce the LCD monitor screen featuring a total of approximately 123,000 pixels. The result is more than 99.99% effective pixels with a mere 0.01% of the pixels inactive or always lit. However, this is not a malfunction and does not affect the recorded picture.

Viewfinder

Extremely high precision technology is employed to produce the viewfinder screen featuring a total of approximately 113,000 pixels. The result is more than 99.99% effective pixels with a mere 0.01% of the pixels inactive or always lit. However, this is not a malfunction and does not affect the recorded picture.

Periodical check-ups

- To maintain the highest image quality, we recommend replacing worn parts such as heads after approx. 1000 hours of use. (This, however, depends on operating conditions including temperature, humidity and dust.)

Explanation of terms

Automatic white balance

White balance adjustment recognizes the color of light and adjusts so the white color will become a pure white. The Camcorder determines the hue of light that comes through the lens and white balance sensor, thereby judging the recording condition and selects the closest hue setting. This is called automatic white balance adjustment. However, since the Camcorder only stores white color information under several light sources, automatic white balance adjustment does not function normally under the other light sources.

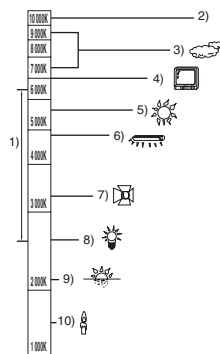

Outside of the effective range of automatic white balance adjustment, the image will become reddish or bluish. Even within the effective range of automatic white balance adjustment, the automatic white balance adjustment may not function properly if there is more than one light source. For light outside the functional auto white balance adjustment range, use the manual white balance adjustment mode.

- 1) The effective range of automatic white balance adjustment on this Camcorder
- 2) Blue sky
- 3) Cloudy sky (rain)
- 4) TV screen
- 5) Sunlight
- 6) White fluorescent lamp
- 7) Halogen light bulb
- 8) Incandescent light bulb
- 9) Sunrise or sunset
- 10) Candlelight

■ White balance

The image recorded by the Camcorder may become bluish or reddish under the influence of light sources. To avoid such phenomena, adjust the white balance.

White balance adjustment determines the white color under different light sources. By recognizing which is the white color under sunlight and which is the white color under a fluorescent lamp, the Camcorder can adjust the balance among the other colors.

Since white is the reference of all colors (light), the Camcorder can record pictures in a natural hue if it can recognize the reference white color.

■ Auto focus

Auto focus automatically moves the focusing lens forward and backward inside the Camcorder to bring the subject into focus.

Auto focus has the following characteristics.

- Adjusts so that the vertical lines of a subject are seen more clearly.
- Attempts to bring an object with higher contrast into focus.
- Focuses on the screen center only.

Due to these characteristics, auto focus does not work correctly in the following situations. Record pictures in the manual focus mode.

Recording a subject with one end located closer to the Camcorder and the other end farther away from it

- As auto focus adjusts at the center of an image, it may be impossible to focus on a subject that is located in both the foreground and background.

Recording a subject behind dirty or dusty glass

- The subject behind the glass will not be focused because the focus is on the dirty glass.

Recording a subject that is surrounded by objects with glossy surfaces or by highly reflective objects

- The recording subject may become blurry because the Camcorder focuses on the objects with glossy surfaces or on highly reflective objects.

Recording a subject in dark surroundings

- The Camcorder cannot focus correctly because the light information that comes through the lens decreases considerably.

Recording a fast-moving subject

- As the focus lens-inside moves mechanically, it cannot keep up with a fast-moving subject.

Recording a subject with little contrast

- A subject with little contrast, such as a white wall, may become blurry because the Camcorder achieves focus based upon the vertical lines of an image.

Specifications

Digital Video Camcorder

Information for your safety

Power source:

DC 7.9/7.2 V

Power consumption:

Recording

5.2 W

Recording format:

Mini DV (Consumer-use digital video SD format)

Tape used:

6.35 mm digital video tape

Recording/playback time:

SP: 80 min; LP: 120 min (with DVM80)

Video
Recording system:

Digital component

Television system:

EIA Standard: 525 lines, 60 fields NTSC color signal

Audio
Recording system:

PCM digital recording

16 bit (48 kHz/2 ch), 12 bit (32 kHz/4 ch)

Image sensor:

1/6-inch 3CCD image sensor

[Effective pixels]

Moving picture: 640 K×3 (4:3), 540 K×3 (16:9)/

Still picture: 710 K×3 (4:3), 540 K×3 (16:9)/

Total: 800 K×3

Lens:

Auto Iris, F1.8 to F2.8, Focal length; 3.0 mm to

30.0 mm, Macro (Full range AF)

Filter diameter:

37 mm

Zoom:

10:1 Power zoom

Monitor:

2.7-inch LCD

Viewfinder:

Color electronic viewfinder

Microphone:

Stereo (with a zoom function)

Speaker:

1 round speaker \varnothing 20 mm

Standard illumination:

1,400 lx

Minimum required illumination:

8 lx (Low light mode: 1/60)

1 lx (MagicPix mode)

Video output level:

1.0 V_{p-p}, 75 Ω

S-Video output level:

Y Output: 1.0 V_{p-p}, 75 Ω

C Output: 0.286 V_{p-p}, 75 Ω

Audio output level (Line):

316 mV, 600 Ω

USB:

Card reader/writer function, USB 2.0 compliant

(Hi-Speed)

No copyright protection support

PictBridge-compliant

Digital interface:

DV input/output terminal (IEEE1394, 4-pin)

Dimensions:

78.5 mm (W)×72.6 mm (H)×136.0 mm (D)

3.091 inch (W)×2.859 inch (H)×5.355 inch (D)

(excluding the projecting parts)

Mass:

Approx. 450 g (0.99 lbs)

(without the supplied battery, DV cassette and lens cap)

Operating temperature:

0 °C to 40 °C (32 °F to 104 °F)

Operating humidity:

10% to 80%

Card memory functions
Recording media:

SD Memory Card: 8 MB/16 MB/32 MB/64 MB/

128 MB/256 MB/512 MB/1 GB/2 GB (Maximum)

(FAT12 and FAT16 format corresponding)

SDHC Memory Card: 4 GB (Maximum)

(FAT32 format corresponding)

Please confirm the latest information on the following website.

<http://panasonic.co.jp/pavc/global/cs>

Still picture recording file format:

JPEG (Design rule for Camera File system, based on Exif 2.2 standard), DPOF corresponding

Still picture size:

2048×1512

2048×1152

1600×1200

1280×960

1280×720

640×480

640×360

WEB camera
Compression:

Motion JPEG

Image size:

320×240 pixels (QVGA)

Frame rate:

Approx. 6 fps

AC adaptor

Information for your safety

Power source:

AC 110 V to 240 V, 50/60 Hz

Power consumption:

19 W

DC output:

DC 7.9 V, 1.4 A (Camcorder operation)

DC 8.4 V, 0.65 A (Battery charging)

Dimensions:

61 mm (W)×32 mm (H)×91 mm (D)







2.40 inch (W)×1.26 inch (H)×3.58 inch (D)

Mass:









Approx. 110 g (0.24 lbs)

Specifications may change without prior notice.

**Maximum number of still pictures recordable on an SD Card (optional)
[16:9] mode:**









PICTURE SIZE	0.2M		1M *		2.4M	
						
8 MB	45	95	12	19	4	7
16 MB	100	200	29	46	11	18
32 MB	220	440	64	98	24	39
64 MB	440	880	130	200	51	81
128 MB	880	1760	250	390	99	155
256 MB	1760	3520	530	810	210	330
512 MB	3520	7040	1040	1600	410	650
1 GB	7040	14080	2090	3200	820	1290
2 GB	14080	28160	4250	6510	1680	2630
4 GB	28160	56320	8350	12780	3290	5170

[4:3] mode:

PICTURE SIZE	0.3M		1M		2M		3.1M	
								
8 MB	45	95	9	15	5	9	3	5
16 MB	100	200	21	35	13	21	8	13
32 MB	220	440	47	75	30	47	18	29
64 MB	440	880	98	155	63	98	39	62
128 MB	880	1760	185	300	120	185	75	120
256 MB	1760	3520	390	620	250	390	160	250
512 MB	3520	7040	780	1230	500	780	320	490
1 GB	7040	14080	1550	2470	1010	1550	630	990
2 GB	14080	28160	3160	5030	2050	3160	1290	2010
4 GB	28160	56320	6210	9870	4020	6210	2530	3950

- * is displayed only in Tape Recording Mode.
- The numbers shown in the table are approximations.
- These figures vary depending on the subject being photographed.

Camcorder Accessory System

Accessory#	Figure	Description
PV-DAC14		AC adaptor with AC cable and DC cables
*CGR-DU06A/1B		640 mAh/Rechargeable Lithium Ion Battery Pack
*CGA-DU12A/1B		1150 mAh/Rechargeable Lithium Ion Battery Pack
*CGA-DU21A/1B		2040 mAh/Rechargeable Lithium Ion Battery Pack
PV-DDC9 (For USA) PV-DDC9-K (For Canada)		DV Interface Cable (4-pin to 4-pin)
RP-SDR04GU1K RP-SDR02GU1A RP-SDR01GU1A RP-SDR512U1A RP-SDR256U1A		Class 2 4 GB SDHC Memory Card Class 2 2 GB SD Memory Card Class 2 1 GB SD Memory Card Class 2 512 MB SD Memory Card Class 2 256 MB SD Memory Card
RP-SDK02GU1A RP-SDH01GU1A RP-SDK512U1A RP-SDH256U1A		High Speed 2 GB SD Memory Card High Speed 1 GB SD Memory Card High Speed 512 MB SD Memory Card High Speed 256 MB SD Memory Card
RP-SDV04GU1A RP-SDV02GU1A RP-SDV01GU1A		Class 6 4 GB SDHC Memory Card Class 6 2 GB SD Memory Card Class 6 1 GB SD Memory Card
RP-SS01GU1K RP-SS512BU1K RP-SS256BU1K		miniSD 1 GB SD Memory Card miniSD 512 MB SD Memory Card miniSD 256 MB SD Memory Card
VW-LDC10		
PV-HB002 (USA only)		Carrying Case

*Please refer to page -16-, concerning the battery charging time and available recording time.

NOTE: Accessories and/or model numbers may vary by country. Please consult your local dealer.

Camcorder Accessory Order Form (For USA Customers)

Please photocopy this form when placing an order.

1. Palmcorder Model # _____

2. Items Ordered

Accessory #	Description	Price Each	Quantity	Total Price
Subtotal				
Your State & Local Sales Tax				
Shipping & Handling				6.95
Total Enclosed				

3. Method of payment (check one)

- Check of Money Order enclosed (NO C.O.D.SHIPMENTS)
- VISA Credit Card # _____
- MasterCard Expiration Date _____
- Discover Customer Signature _____

Make Check or Money Order Payable to: PANASONIC ACCESSORIES

(Please do not send cash)

4. Shipping information (UPS delivery requires complete street address)

Ship To:

Mr.

Mrs.

Ms. _____

First Last

Phone#:

Day () _____

Street Address _____

Night () _____

City State Zip

TO OBTAIN ANY OF OUR PALMCORDER ACCESSORIES YOU CAN DO ANY OF
THE FOLLOWING:
VISIT YOUR LOCAL PANASONIC DEALER
OR
CALL PANASONIC'S ACCESSORY ORDER LINE AT 1-800-332-5368
[6 AM-6 PM M-F, PACIFIC TIME]
OR
MAIL THIS ORDER TO: PANASONIC SERVICES COMPANY ACCESSORY ORDER OFFICE
20421 84th Avenue South Kent, WA. 98032

In CANADA, please contact your local Panasonic dealer for more information on Accessories.

Request for Service Notice (USA Only)

Please photocopy this form when making a request for service notice, in the unlikely event this product needs service.

Request for Service Notice:

- Please include your **proof of purchase.**
(Failure to do so will delay your repair.)
 - To further speed your repair, please provide an explanation of what is wrong with the unit and any symptom it is exhibiting.
-
-
-
-

Mail this completed form and your Proof of Purchase along with your unit to:
Panasonic Camera and Digital Service Center
1590 Touhy Ave.
Elk Grove Village, IL 60007

Limited Warranty (For USA Customers)

PANASONIC CONSUMER ELECTRONICS
 COMPANY, DIVISION OF PANASONIC
 CORPORATION OF NORTH AMERICA
 One Panasonic Way, Secaucus, New Jersey 07094

PANASONIC PUERTO RICO, INC.
 Ave. 65 de Infantería, Km. 9.5 San Gabriel Industrial Park,
 Carolina, Puerto Rico 00985

**Panasonic Video Products
 Limited Warranty**

Limited Warranty Coverage

If your product does not work properly because of a defect in materials or workmanship, Panasonic Consumer Electronics Company or Panasonic Puerto Rico, Inc. (collectively referred to as "the warrantor") will, for the length of the period indicated on the chart below, which starts with the date of original purchase ("warranty period"), at its option either (a) repair your product with new or refurbished parts, or (b) replace it with a new or a refurbished product. The decision to repair or replace will be made by the warrantor.

Product	Parts	Labor	Service	Contact Number
Camcorder	One (1) Year (except CCD Image Sensor) CCD Image Sensor - 6 (Six) Months	Ninety (90) Days Ninety (90) Days	Carry-In or Mail-In	1-800-211-PANA(7262)
DVD/VCR Deck, A/V Mixer	One (1) Year	Ninety (90) Days	Carry-In or Mail-In	1-800-211-PANA(7262)
TV/VCR, TV/DVD, TV/DVD/VCR Combination	One (1) Year (except CRT) CRT - Two (2) Years	Ninety (90) Days Ninety (90) Days	Carry-In: 21" CRT and Smaller In-Home or Carry-In: 22" CRT and Larger	1-800-211-PANA(7262)
TV/HDR Combination	One (1) Year (except CRT) CRT - Two (2) Years	Ninety (90) Days Ninety (90) Days	In-Home or Carry-In	1-888-843-9788
Rechargeable Batteries (in exchange for defective item)	Ten (10) Days	Not Applicable	Carry-In or Mail-In	1-800-211-PANA(7262)
Tape (in exchange for defective item)	Five (5) Days	Not Applicable	Carry-In or Mail-In	1-800-211-PANA(7262)
Memory Cards (in exchange for defective item)	Ninety (90) Days	Not Applicable	Carry-In or Mail-In	1-800-211-PANA(7262)

During the "Labor" warranty period there will be no charge for labor. During the "Parts" warranty period, there will be no charge for parts. You must carry-in or mail-in (prepaid) your product or arrange for in-home service, as applicable, during the warranty period. If non-rechargeable batteries are included, they are not warranted. This warranty only applies to products purchased and serviced in the United States or Puerto Rico. This warranty is extended only to the original purchaser of a new product which was not sold "as is". A purchase receipt or other proof of the original purchase date is required for warranty service.

Carry-In, Mail-in (Prepaid) or In-Home Service

For Carry-In, Mail-In (prepaid) or In-Home Service (as applicable) in the United States call toll free contact number listed above or visit Panasonic Web Site: <http://www.panasonic.com>

For assistance in Puerto Rico call Panasonic Puerto Rico, Inc. (787)-750-4300 or fax (787)-768-2910.

In-Home service, if applicable, requires clear, complete and easy access to the product by the authorized servicer and does not include removal or re-installation of an installed product. It is possible that certain in-home repairs will not be completed in-home, but will require that the product, or parts of the product, be removed for shop diagnosis and/or repair and then returned.

Limited Warranty Limits And Exclusions

This warranty ONLY COVERS failures due to defects in materials or workmanship, and DOES NOT COVER normal wear and tear or cosmetic damage, nor does it cover markings or retained images on the picture tube resulting from viewing fixed images (including, among other things, letterbox pictures on standard 4:3 screen TV's, or non-expanded standard 4:3 pictures on wide screen TV's, or onscreen data in a stationary and fixed location). The warranty ALSO DOES NOT COVER damages which occurred in shipment, or failures which are caused by products not supplied by the warrantor, or failures which result from accidents, misuse, abuse, neglect, bug infestation, mishandling, misapplication, alteration, faulty installation, set-up adjustments, misadjustment of consumer controls, improper maintenance, power line surge, lightning damage, modification, or commercial use (such as in a hotel, office, restaurant, or other business), rental use of the product, service by anyone other than a Factory Service Center or other Authorized Servicer, or damage that is attributable to acts of God.

THERE ARE NO EXPRESS WARRANTIES EXCEPT AS LISTED UNDER "LIMITED WARRANTY COVERAGE". THE WARRANTOR IS NOT LIABLE FOR INCIDENTAL OR CONSEQUENTIAL DAMAGES RESULTING FROM THE USE OF THIS PRODUCT, OR ARISING OUT OF ANY BREACH OF THIS WARRANTY.

(As examples, this excludes damages for lost time, cost of having someone remove or re-install an installed unit if applicable, or travel to and from the servicer, loss of media or images, data or other memory or recorded content. The items listed are not exclusive, but are for illustration only.)

ALL EXPRESS AND IMPLIED WARRANTIES, INCLUDING THE WARRANTY OF MERCHANTABILITY, ARE LIMITED TO THE PERIOD OF THE LIMITED WARRANTY.

Some states do not allow the exclusion or limitation of incidental or consequential damages, or limitations on how long an implied warranty lasts, so the exclusions may not apply to you. This warranty gives you specific legal rights and you may also have other rights which vary from state to state. If a problem with this product develops during or after the warranty period, you may contact your dealer or Service Center. If the problem is not handled to your satisfaction, then write to the warrantor's Consumer Affairs Department at the addresses listed for the warrantor.

PARTS AND SERVICE (INCLUDING COST OF AN IN-HOME SERVICE CALL, WHERE APPLICABLE) WHICH ARE NOT COVERED BY THIS LIMITED WARRANTY ARE YOUR RESPONSIBILITY.

Customer Services Directory

Service in Canada: As per Service Center listed in Canadian warranty information on page -84-

Obtain Product Information and Operating Assistance; locate your nearest Dealer or Service Center; purchase Parts and Accessories; or make Customer Service and Literature requests by visiting our Web Site at:

<http://www.panasonic.com/consumersupport>

or, contact us via the web at:

<http://www.panasonic.com/contactinfo>

You may also contact us directly at:

1-800-211-PANA (7262),

Monday-Friday 9 am-9 pm; Saturday-Sunday 10 am-7 pm, EST

For hearing or speech impaired TTY users, TTY : 1-877-833-8855

Accessory Purchases

Purchase Parts, Accessories and Instruction Books online for all Panasonic Products by visiting our Web Site at:

<http://www.pasc.panasonic.com>

or, send your request by E-mail to:

npcparts@us.panasonic.com

You may also contact us directly at:

1-800-332-5368 (Phone) 1-800-237-9080 (Fax Only) (Monday – Friday 9 am to 9 pm, EST.)

Panasonic Services Company

20421 84th Avenue South,

Kent, WA 98032

(We Accept Visa, MasterCard, Discover Card, American Express, and Personal Checks)

For hearing or speech impaired TTY users, TTY : 1-866-605-1277

Product Repairs

Centralized Factory Service Center

MAIL TO:

Panasonic Camera and Digital Service Center

1590 Touhy Ave.

Elk Grove Village, IL 60007

Please carefully pack and ship, prepaid and insured, to the Elk Grove Village Centralized Factory Service Center.

Customer's in Puerto Rico, please ship or carry in to location below ("Service in Puerto Rico").

Service in Puerto Rico

Panasonic Puerto Rico, Inc.

Ave. 65 de Infantería, Km. 9.5, San Gabriel Industrial Park,

Carolina, Puerto Rico 00985

Phone (787)750-4300, Fax (787)768-2910

As of November 2006

Warranty (For Canadian Customers)

Panasonic Canada Inc.

5770 Ambler Drive, Mississauga, Ontario L4W 2T3

PANASONIC PRODUCT – LIMITED WARRANTY

Panasonic Canada Inc. warrants this product to be free from defects in material and workmanship and agrees to remedy any such defect for a period as stated below from the date of original purchase.

Camcorder Product – One (1) year, parts and labour

LIMITATIONS AND EXCLUSIONS

This warranty does not apply to products purchased outside Canada or to any product which has been improperly installed, subjected to usage for which the product was not designed, misused or abused, damaged during shipping, or which has been altered or repaired in any way that affects the reliability or detracts from the performance, nor does it cover any product which is used commercially. Dry cell batteries are also excluded from coverage under this warranty.

This warranty is extended to the original end user purchaser only. A purchase receipt or other proof of date of original purchase is required before warranty service is performed.

THIS EXPRESS, LIMITED WARRANTY IS IN LIEU OF ALL OTHER WARRANTIES, EXPRESS OR IMPLIED, INCLUDING ANY IMPLIED WARRANTIES OF MERCHANTABILITY AND FITNESS FOR A PARTICULAR PURPOSE.

IN NO EVENT WILL PANASONIC CANADA INC. BE LIABLE FOR ANY SPECIAL, INDIRECT OR CONSEQUENTIAL DAMAGES.

In certain instances, some jurisdictions do not allow the exclusion or limitation of incidental or consequential damages, or the exclusion of implied warranties, so the above limitations and exclusions may not be applicable.

WARRANTY SERVICE

FOR PRODUCT OPERATION ASSISTANCE, please contact:

Our Customer Care Centre: Telephone #: (905) 624-5505
1-800 #: 1-800-561-5505
Fax #: (905) 238-2360
Email link: "Customer support" on www.panasonic.ca

FOR PRODUCT REPAIRS, please locate your nearest Authorized Servicentre at www.panasonic.ca :

Link: "ServicentresTM locator" under "Customer support"

IF YOU SHIP THE PRODUCT TO A SERVICENTRE

Carefully pack and send prepaid, adequately insured and preferably in the original carton.
Include details of the defect claimed, and proof of date of original purchase.

Index

■ Numerics	
4:3 Function	37
■ A	
AC Adaptor	15, 74
Aperture	41
Audio Dubbing	49
Auto Ground-Directional Standby (AGS)	36
■ B	
Backlight Compensation	33
Black Balance	40
Blank Search	30
■ C	
Camcorder Accessory Order Form	80
Card Playback	44
Charging the Battery	15
Condensation	72
Customer Services Directory	83
■ D	
Date/Time Setting	17
Digital Dubbing	48
Digital Zoom	33
DPOF Setting	46
Dubbing	47
■ E	
Erasure Prevention Slider	20
■ F	
Fade	35
Formatting	46
Frame-by-frame playback	43
■ G	
Guideline	38
■ H	
Help mode	23
■ L	
LCD Monitor	18, 75
Limited Warranty (Canada)	84
Limited Warranty (USA)	82
Low Light Mode	38
■ M	
MagicPix Function	34
Manual Focus	40
Mega Optical Image Stabilizer	38
Mode Dial	21
MotionDV STUDIO	57
■ P	
Photoshot	31
PictBridge	50
Portrait Mode	38
■ Q	
Quick Movie Magic	57
Quick Start	19
■ R	
Recording Check	30
Recording Speed	28
Remaining Tape Time	66
Remote Control	26
Repeat Playback	42
Request for Service Notice (USA Only)	81
■ S	
Scene mode	38
SD Card	62
Self-Recording	33
Self-timer Recording	37
Shutter Speed	41
Slow Motion Playback	43
Soft Skin Mode	34
Sound Volume	42
SP/LP Mode	28
Sports Mode	38
Spotlight Mode	38
Surf & Snow Mode	38
■ T	
Tele Macro Function	35
■ V	
Variable Speed Search	43
Video Head Clogging	72
Viewfinder	18, 75
■ W	
Web Camera	54
White Balance	39
Wide Function	37
Wind noise reduction function	36
■ Z	
Zoom	32
Zoom Microphone	33

Spanish Quick Use Guide/ Guía española para el uso rápido

■ Carga de la batería

- 1 Conecte el cable eléctrico de CA al adaptador de CA y a la toma de la red de CA.
- 2 Meta la batería en el respectivo soporte alineando la marca, luego encájela.

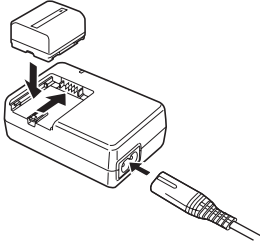

■ Montaje de la batería

Empuje la batería contra el porta batería y hágala deslizar hasta que dispare.

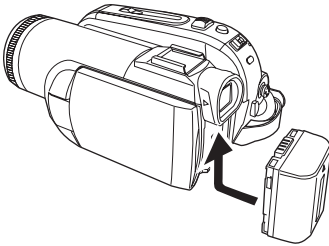

■ Insertar/quitar un cassette

- 1 Haga deslizar la palanca [OPEN/EJECT] y abra la tapa del cassette.



- 2 Una vez que el compartimiento del cassette esté abierto, inserte/quite el cassette.

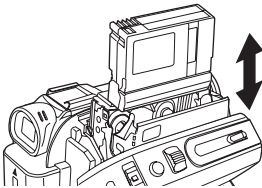

- 3 Apriete la marca [PUSH] 1 a fin de cerrar el compartimiento del cassette.

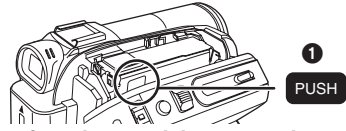

- 4 Sólo cierre la tapa del cassette después de que el respectivo compartimiento esté cabalmente alojado.

■ Insertar/quitar una tarjeta

- 1 Luego abra la tapa de la ranura de la tarjeta.

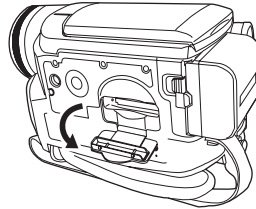

- 2 Inserte/quite la tarjeta en/de la ranura.

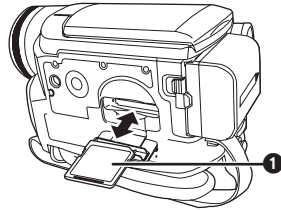

- Cuando inserta una tarjeta, con su lado etiquetado vuelto 1 hacia Ud., la apriete derecha de un solo golpe hasta que tope.
- Cuando quita la tarjeta, abra la tapa de la respectiva ranura, apriete en el medio de la tarjeta y tírela fuera derecha.

- 3 Cierre firmemente la tapa de la ranura de la tarjeta.

■ Cómo activar la alimentación

- 1 Mientras que oprime el botón 1, ponga el interruptor [OFF/ON] en [ON].

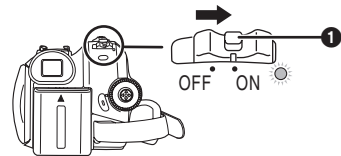

■ Cómo apagar la alimentación

1 Mientras que oprime el botón ❶, ponga el interruptor [OFF/ON] en [OFF].

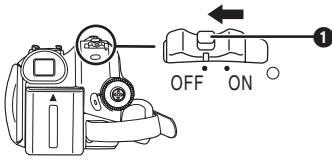

■ Grabación en una cinta

● Ajuste al modo de grabación de cinta.

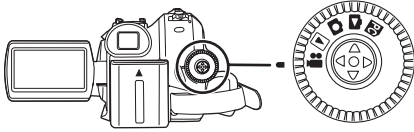

1 Oprima el botón de inicio/parada de la grabación para empezar a grabar.

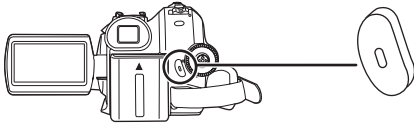

2 Oprima de nuevo el botón de inicio/parada de la grabación para detener brevemente la grabación.



■ Grabación de imágenes fijas en una tarjeta (Photoshot)

● Ajuste al modo de grabación de tarjeta.

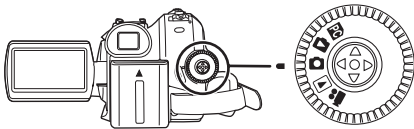

1 Oprima el botón de Photoshot [📷].

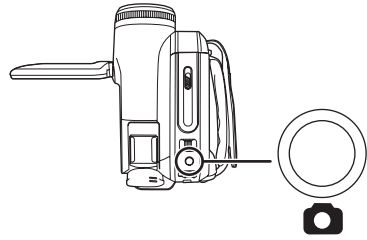

■ Reproducción de la cinta

● Ajuste al modo de reproducción de cinta.

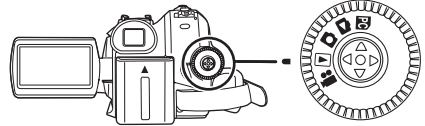

1 Actúe en la palanca de mando.



▶/||: Reproducción/Pausa

◀◀: Rebobinado/Localización regresiva (Vuelve para reproducir con el icono ▶/||.)

▶▶: Avance rápido/Localización progresiva (Vuelve para reproducir con el icono ▶/||.)

■: Parada

■ Reproducción de tarjeta

● Ajuste al modo de reproducción de imagen.

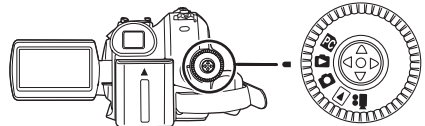

1 Actúe en la palanca de mando.

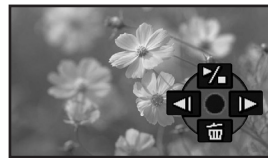

◀◀: Reproducción de la imagen anterior.

▶▶: Reproducción de la siguiente imagen.

▶/■: Diapositiva (Reproduce por orden las imágenes fijas en la tarjeta), inicio/parada

**Panasonic Consumer Electronics Company,
Division of Panasonic Corporation of North America**

One Panasonic Way, Secaucus, NJ 07094

Panasonic Puerto Rico, Inc.

Ave. 65 de Infantería, Km. 9.5, San Gabriel Industrial Park, Carolina, Puerto Rico 00985

Panasonic Canada Inc.

5770 Ambler Drive, Mississauga, Ontario, L4W 2T3



Printed in Japan

LSQT1091 A

F1106Ak0 (7500 Ⓐ)

