

Compact Stereo System

Model No. **SC-HC25**



As an ENERGY STAR® Partner, Panasonic has determined that this product meets the ENERGY STAR® guidelines for energy efficiency.

Dear Customer

Thank you for purchasing this system.

For optimum performance and safety, read these instructions fully before you connect, operate or adjust this system.

Keep this manual for future reference.

Your system and the illustrations can look differently.

Do the procedures with the remote control. You can also use the buttons on the main unit if they are the same.

Supplied Accessories

Check and identify the supplied accessories.

Use numbers indicated in parentheses when asking for replacement parts. (Product numbers correct as of January 2011. This may be subject to change.)

To order accessories, refer to "Accessory Purchases (United States and Puerto Rico)" on page 11.

1 x AC power supply cord

(K2CB2CB00021)

1 x AM loop antenna

(N1DY00010)

1 x FM indoor antenna

(RSAX0002)

1 x Remote control

(N2QAYB000640)

If you have any questions contact

1-800-211-PANA (7262)

The warranty can be found on page 11.

Please return the product registration card (if included), or register via the internet at:

www.panasonic.com/register

La guía rápida en español se encuentra en la página 12 a 15.

IMPORTANT SAFETY INSTRUCTIONS

Read these operating instructions carefully before using the unit. Follow the safety instructions on the unit and the applicable safety instructions listed below. Keep these operating instructions handy for future reference.

- 1) Read these instructions.
- 2) Keep these instructions.
- 3) Heed all warnings.
- 4) Follow all instructions.
- 5) Do not use this apparatus near water.
- 6) Clean only with dry cloth.
- 7) Do not block any ventilation openings. Install in accordance with the manufacturer's instructions.
- 8) Do not install near any heat sources such as radiators, heat registers, stoves, or other apparatus (including amplifiers) that produce heat.
- 9) Do not defeat the safety purpose of the polarized or grounding-type plug. A polarized plug has two blades with one wider than the other. A grounding-type plug has two blades and a third grounding prong. The wide blade or the third prong are provided for your safety. If the provided plug does not fit into your outlet, consult an electrician for replacement of the obsolete outlet.
- 10) Protect the power cord from being walked on or pinched particularly at plugs, convenience receptacles, and the point where they exit from the apparatus.
- 11) Only use attachments/accessories specified by the manufacturer.
- 12) Use only with the cart, stand, tripod, bracket, or table specified by the manufacturer, or sold with the apparatus. When a cart is used, use caution when moving the cart/apparatus combination to avoid injury from tip-over.
- 13) Unplug this apparatus during lightning storms or when unused for long periods of time.
- 14) Refer all servicing to qualified service personnel. Servicing is required when the apparatus has been damaged in any way, such as power-supply cord or plug is damaged, liquid has been spilled or objects have fallen into the apparatus, the apparatus has been exposed to rain or moisture, does not operate normally, or has been dropped.



Listening caution



Selecting fine audio equipment such as the unit you've just purchased is only the start of your musical enjoyment. Now it's time to consider how you can maximize the fun and excitement your equipment offers. This manufacturer and the Electronic Industries Association's Consumer Electronics Group want you to get the most out of your equipment by playing it at a safe level. One that lets the sound come through loud and clear without annoying blaring or distortion—and, most importantly, without affecting your sensitive hearing.

We recommend that you avoid prolonged exposure to excessive noise.

Sound can be deceiving. Over time your hearing "comfort level" adapts to higher volumes of sound. So what sounds "normal" can actually be loud and harmful to your hearing.

Guard against this by setting your equipment at a safe level BEFORE your hearing adapts.

To establish a safe level:

- Start your volume control at a low setting.
- Slowly increase the sound until you can hear it comfortably and clearly, and without distortion.

Once you have established a comfortable sound level:

- Leave it there.

Taking a minute to do this now will help to prevent hearing damage or loss in the future. After all, we want you listening for a lifetime.

– If you see this symbol –

Information on Disposal in other Countries outside the European Union



This symbol is only valid in the European Union. If you wish to discard this product, please contact your local authorities or dealer and ask for the correct method of disposal.

Product service

1. **Damage requiring service** — The unit should be serviced by qualified service personnel if:
 - (a) The AC power supply cord or the plug has been damaged; or
 - (b) Objects or liquids have gotten into the unit; or
 - (c) The unit has been exposed to rain; or
 - (d) The unit does not operate normally or exhibits a marked change in performance; or
 - (e) The unit has been dropped or the cabinet damaged.
2. **Servicing** — Do not attempt to service the unit beyond that described in these operating instructions. Refer all other servicing to authorized servicing personnel.
3. **Replacement parts** — When parts need replacing ensure the servicer uses parts specified by the manufacturer or parts that have the same characteristics as the original parts. Unauthorized substitutes may result in fire, electric shock, or other hazards.
4. **Safety check** — After repairs or service, ask the servicer to perform safety checks to confirm that the unit is in proper working condition.

Product information

For product information or assistance with product operation: Refer to "Customer Services Directory (United States and Puerto Rico)" on page 11.

Table of contents

IMPORTANT SAFETY INSTRUCTIONS	3
Listening caution	3
Product service	3
Preparing the remote control	4
Making the connections	4
Overview of controls	5
Discs	6
Using an iPod or iPhone	7
Radio	8
Clock and timers	8
Sound effects	9
External equipment	9
Remote control code	9
Troubleshooting guide	9
Maintenance	10
Specifications	10
Limited Warranty	11

Español

Cómo preparar el control remoto	12
Cómo realizar las conexiones	12
Visión de los controles	13
Discos	14
Cómo usar un iPod o iPhone	14
Radio	15
Reloj y temporizador	15

Preparing the remote control

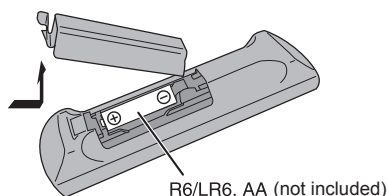

Use alkaline or manganese battery.

Install the battery so that the poles (+ and -) align with those in the remote control.

Point the remote control at the remote control sensor (➔ 5), away from obstacles, at a maximum range of 7 m (23 feet) directly in front of the main unit.

CAUTION!

- Do not break open or short-circuit the battery.
- Do not charge the alkaline or manganese battery.
- Do not use the battery if the cover has peeled off.
- Do not heat or expose to flame.
- Do not leave the battery(ies) in an automobile exposed to direct sunlight for a long period of time with doors and windows closed.
- Mishandling of battery can cause electrolyte leakage, which can cause a fire.
- Remove the battery if you do not use the remote control for a long period of time. Keep in a cool, dark area.

CAUTION!

Danger of explosion if battery is incorrectly replaced. Replace only with the same or equivalent type recommended by the manufacturer. Dispose of used batteries according to the manufacturer's instructions.

Made for
 iPod  iPhone

"Made for iPod" and "Made for iPhone" mean that an electronic accessory has been designed to connect specifically to iPod, or iPhone, respectively, and has been certified by the developer to meet Apple performance standards.

Apple is not responsible for the operation of this device or its compliance with safety and regulatory standards.

Please note that the use of this accessory with iPod, or iPhone may affect wireless performance.

iPhone, iPod, iPod classic, iPod nano, and iPod touch are trademarks of Apple Inc., registered in the U.S. and other countries.

MPEG Layer-3 audio coding technology licensed from Fraunhofer IIS and Thomson.

Making the connections

Conserving power

The system consumes approximately 0.1 W when it is in standby mode. Disconnect the power supply if you do not use the system. Some settings will be lost after you disconnect the system. You have to set them again.

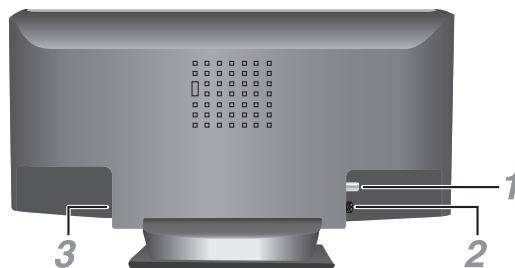

1 Connect the FM indoor antenna.

Place the antenna where reception is best.

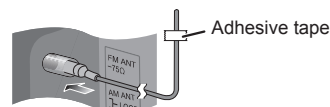

2 Connect the AM loop antenna.

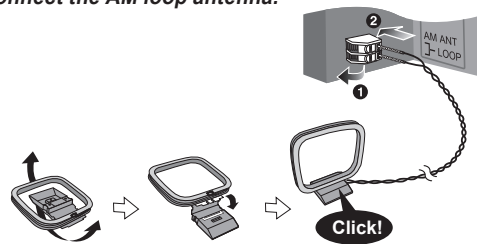

3 Connect the AC power supply cord.

Use the included AC power supply cord with this system only. Do not use an AC power supply cord from other equipment.

Note:

- These speakers do not have magnetic shielding. Do not put them near TVs, PCs or other equipment easily influenced by magnetism.
- You cannot remove the net of the speakers.

Remote control



- 1 **Standby/on switch** [⏻], [⏻/⏪], **POWER** (→ 8, 10)
Press to switch the unit from on to standby mode or vice versa. In standby mode, the unit is still consuming a small amount of power.
- 2 **Numeric buttons [1 to 9, 0, ≥10]**
To select a 2-digit number
Example: 16: [≥10] → [1] → [6]
- 3 Delete a programmed track (→ 6)
- 4 **Select source**
[iPod]: Select iPod (→ 7)
[CD]: Select disc (→ 6)
[RADIO, EXT-IN]: Select radio or AUX (→ 8, 9)
- 5 **Basic operation**
[▶/||]: Playback or pause operation
[■]: Stop playback
[◀], [▶]: Skip track
Select preset radio station
[◀◀], [▶▶]: Search track
Tune in to the radio station
[◀◀/▶▶], [▶▶/▶▶]: Skip and search track
Select preset radio station
- 6 Select the sound effects (→ 9)
- 7 Select the iPod menu item (→ 7)
- 8 View the information shown on the display panel.
Decrease the brightness of the display panel
Press and hold the button to use this function.
To cancel, press and hold the button again.
- 9 Set the sleep timer (→ 8)
Set the clock and timer (→ 8)
- 10 Set the program function (→ 6, 8)
- 11 Adjust the volume of the system
- 12 **Mute the sound of the system**
Press the button again to cancel.
"MUTE" is also canceled when you adjust the volume or when you switch off the system.
- 13 Set the play menu item (→ 6)
- 14 Set the radio menu item (→ 8)
- 15 [▲, ▼]: Skip album
Adjust clock setting
[◀, ▶]: Select the item in the menu
[OK]: Confirm the setting
- 16 **Automatically switch off the system**
This function switches off the system (except in radio source) if you do not use the system for approximately 30 minutes.
To cancel, press the button two times.
- 17 **Headphones jack** (🎧)
Plug type: Ø 3.5 mm (1/8") stereo (not included)
 - Avoid listening for prolonged periods of time to prevent hearing damage.
 - Excessive sound pressure from earphones and headphones can cause hearing loss.
 - Listening at full volume for long periods may damage the user's ears. Be sure to use the supplied or recommended headphones or earphones.
- 18 AUX jack
- 19 Open or close the sliding door
- 20 Display panel
- 21 Sliding door
- 22 Remote control sensor
- 23 Open or close the iPod or iPhone dock

Main unit

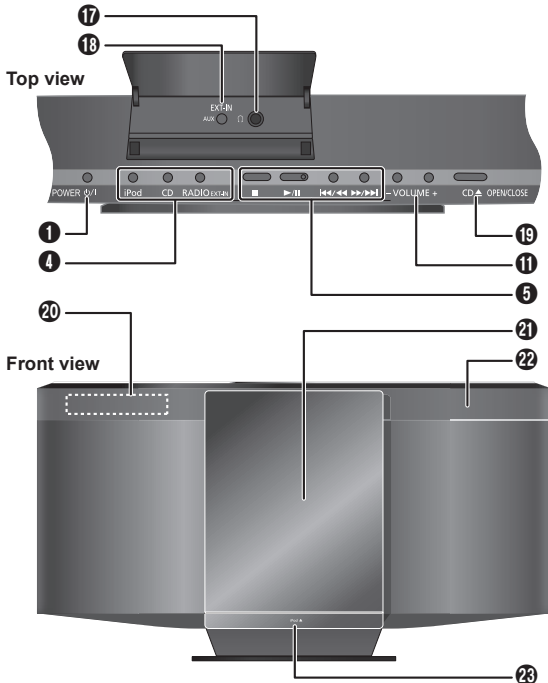

Discs

Playing discs

- 1 Press [CD ▲, OPEN/CLOSE] on the main unit to open the sliding door.
Put in a disc with the label facing towards you.
Press [CD ▲, OPEN/CLOSE] again to close the sliding door.



- 2 Press [CD] and then press [▶/||] to start playback.
Keep fingers away from the sliding door when it is closing.

Stop playback	Press [■] during playback.
Pause playback	Press [▶/] during playback. Press again to continue playback.
Skip album	[MP3] Press [▲, ▼].
Skip track	Press [◀◀] or [▶▶] (main unit: [◀◀/▶▶] or [▶▶/▶▶]).
Search through track	[CD] Press and hold [◀◀] or [▶▶] (main unit: [◀◀/▶▶] or [▶▶/▶▶]).

Playmode function

- 1 Press [PLAY MENU] to select "PLAYMODE".
- 2 Press [◀, ▶] and then press [OK] to select the desired mode.

OFF PLAYMODE	Play all tracks.
1-TRACK 1TR	Play one selected track on the disc. Press the numeric buttons to select the track. Playback starts from the selected track.
1-ALBUM 1ALBUM	[MP3] Play one selected album on the disc. Press [▲, ▼] to select the album.
RANDOM RND	Play a disc randomly.
1-ALBUM RANDOM 1ALBUM RND	[MP3] Play all tracks in one selected album randomly. Press [▲, ▼] to select the album.

Note:

- During random playback, you cannot skip to tracks which have been played or press the numeric buttons.
- This function does not work with "Program playback".
- The setting returns to default "OFF PLAYMODE" when you open the sliding door.

Repeat playback

You can repeat "Program playback" or other selected "Playmode function".

- 1 Press [PLAY MENU] to select "REPEAT".
- 2 Press [◀, ▶] to select "ON REPEAT" and then press [OK].
"⏮" is shown.
To cancel, select "OFF REPEAT".

Program playback

This function allows you to program up to 24 tracks.

[CD]

- 1 Press [PROGRAM] in the stop mode.
"PGM" is shown.
- 2 Press the numeric buttons to select the desired track.
Do this step again to program other tracks.
- 3 Press [▶/||] to start playback.

[MP3]

- 1 Press [PROGRAM] in the stop mode.
- 2 Press [▲, ▼] to select the desired album.
- 3 Press [▶▶] and then press the numeric buttons to select the desired track.
- 4 Press [OK].
Do steps 2 through 4 again to program other tracks.
- 5 Press [▶/||] to start playback.

Cancel program mode	Press [PROGRAM] in the stop mode.
Replay the program	Press [PROGRAM] and then press [▶/].
Check program contents	Press [◀◀] or [▶▶] when "PGM" is shown in the stop mode. To check while programming, press [PROGRAM] two times after "PGM" is shown, then press [◀◀] or [▶▶].
Clear the last track	Press [DEL] in the stop mode.
Clear all programmed tracks	Press [■] in the stop mode. "CLR ALL" is shown. Within 5 seconds, press [■] again.

Note:

The program memory is cleared when you open the sliding door.

Viewing available information

You can view the available information on the display panel.

Press [DISPLAY].

Note:

- Maximum characters that can be shown: approximately 30
- This system supports ver. 1.0, 1.1 and 2.3 ID3 tags.
- Text data that the system does not support can show differently.

Note on using a DualDisc

A DualDisc does not playback if the side of the digital audio content does not meet the technical specifications of the Compact Disc Digital Audio (CD-DA) format.

Note on CDs

- This system can access up to 99 tracks.
- This system can play MP3 files and CD-DA format audio CD-R/RW that have been finalized.
- This system can fail to play some CD-R/RW because of the condition of the recording.

Note on MP3s

- Files are treated as tracks and folders are treated as albums.
- This system can access up to 999 tracks, 255 albums (including root folder) and 20 sessions.
- Disc must conform to ISO9660 level 1 or 2 (except for extended formats).
- To play in a certain order, prefix the folder and file names with 3-digit numbers in the order you want them to play.

Limitations on MP3 playback

- If you have recorded MP3s on the same disc as CD-DA, only the format recorded in the first session can be played.
- Some MP3s cannot be played because of the condition of the disc or recording.
- Recordings will not necessarily be played in the order you recorded them.

Using an iPod or iPhone

1 Push [▲, iPod] to open the dock tray.

2 Insert a compatible dock adapter.

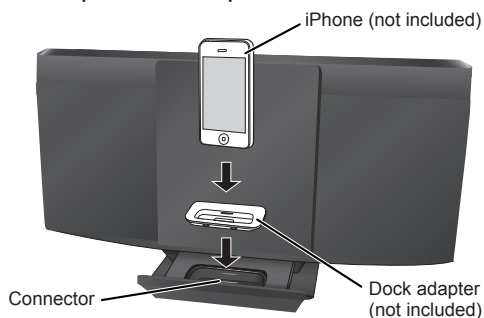

3 Connect the iPod or iPhone firmly.

Make sure to remove the iPod or iPhone from its case.

4 Press [iPod] and then press [▶/||] to start playback.

Pause playback	Press [▶/] or [■].
Skip track	Press [◀◀] or [▶▶] (main unit: [◀◀/▶▶] or [▶▶/▶▶]).
Search the current track	Press and hold [◀◀] or [▶▶] (main unit: [◀◀/▶▶] or [▶▶/▶▶]).
View iPod or iPhone menu, Return to previous menu	Press [iPod MENU] in the play mode.
Select an iPod or iPhone menu item	Press [▲, ▼] and then press [OK].

Note:

- Make sure to align your iPod or iPhone with the connector when inserting the iPod or iPhone.
- The operations may vary or not work depending on the iPod or iPhone models.
- Depending on the model, it may be necessary to remove the iPod or iPhone and select the album, artist, etc. on the iPod or iPhone.
- Read the User Guide of the iPod or iPhone for operating instructions.

Charging an iPod or iPhone

An iPod or iPhone is charged automatically when connected to the system (even when the system is in standby mode).

- See the iPod or iPhone display for its battery charging status.
- Disconnect the iPod or iPhone if it is not used for an extended period of time after charging is complete.
- Charging stops when the battery is fully charged. The battery will deplete naturally.

Compatible iPod and iPhone

Update your iPod or iPhone with the latest software before using this unit.

Compatibility depends on the software version of your iPod or iPhone.

- iPod touch 4th generation (8GB, 32GB, 64GB)
- iPod nano 6th generation (8GB, 16GB)
- iPod touch 3rd generation (32GB, 64GB)
- iPod nano 5th generation (video camera) (8GB, 16GB)
- iPod touch 2nd generation (8GB, 16GB, 32GB)
- iPod classic [120GB, 160GB (2009)]
- iPod nano 4th generation (video) (8GB, 16GB)
- iPod classic (160GB) (2007)
- iPod touch 1st generation (8GB, 16GB, 32GB)
- iPod nano 3rd generation (video) (4GB, 8GB)
- iPod classic (80GB)
- iPod nano 2nd generation (aluminum) (2GB, 4GB, 8GB)
- iPod 5th generation (video) (60GB, 80GB)
- iPod 5th generation (video) (30GB)
- iPod nano 1st generation (1GB, 2GB, 4GB)
- iPhone 4 (16GB, 32GB)
- iPhone 3GS (8GB, 16GB, 32GB)
- iPhone 3G (8GB, 16GB)
- iPhone (4GB, 8GB, 16GB)

Note on iPhone

- All phone features can only be controlled by the touch screen of the iPhone.
- The system does not show incoming calls or the phone status.
- Playback will stop when there is an incoming call.
- A call is not canceled when you connect or disconnect the iPhone from the system.
- There is no Apple Inc. specification that will guarantee the above iPhone response. iPhone responses can be different on newer models or with new software.

Radio

Manual tuning

- 1 Press [RADIO, EXT-IN] to select "FM" or "AM".
- 2 Press [◀◀] or [▶▶] to select the frequency of the required station.
To tune automatically, press and hold the button until the frequency starts changing quickly.

To improve the sound quality

When "FM" is selected

- 1 Press [RADIO MENU] to select "FM MODE".
 - 2 Press [◀, ▶] to select "MONO" and then press [OK].
To cancel, select "STEREO".
- "MONO" is also canceled when you change the frequency.
 - Turn off "MONO" for normal listening.

When "AM" is selected

- 1 Press [RADIO MENU] to select "B.PROOF".
- 2 Press [◀, ▶] to select "BP 1" or "BP 2" and then press [OK].

Memory presetting

30 FM and 15 AM stations can be preset.

Preparation

Press [RADIO, EXT-IN] to select "FM" or "AM".

Automatic presetting

- 1 Press [OK] to select "LOWEST" or "CURRENT" frequency.
- 2 Press [RADIO MENU] to select "A.PRESET" and then press [OK].
"START?" is shown.
- 3 Press [OK] to start presetting.

Manual presetting

- 1 Press [◀◀] or [▶▶] to tune in to the station.
- 2 Press [PROGRAM].
- 3 Press the numeric buttons to select a preset number.
Do steps 1 through 3 again to preset more stations.
The new station replaces any station that occupies the same preset number.

Selecting a preset station

Press the numeric buttons, [◀◀] or [▶▶] (main unit: [◀◀/▶▶] or [▶▶/▶▶]) to select the preset station.

FM or AM allocation setting (by main unit only)

This system can also receive FM broadcasts allocated in 0.1 MHz steps or AM broadcasts allocated in 9 kHz steps.

- 1 Press [RADIO, EXT-IN] to select "FM" or "AM".
 - 2 Press and hold [RADIO, EXT-IN].
After a few seconds, the display panel shows the current minimum radio frequency. Release the button when the minimum frequency changes.
- To go back to the initial setting, do the above steps again.
 - After you change the setting, preset frequencies are erased.

Clock and timers

Setting the clock

This is a 12-hour clock.

- 1 Press [CLOCK/TIMER] to select "CLOCK".
- 2 Within 10 seconds, press [▲, ▼] to set the time.
- 3 Press [OK].

Press [CLOCK/TIMER] to show the clock for a few seconds.

Note:

Reset the clock regularly to maintain accuracy.

Sleep timer

The sleep timer switches off the system after the set time.

Press [SLEEP] to select the setting (in minutes).

To cancel, select "OFF".

30 MIN → 60 MIN → 90 MIN → 120 MIN → OFF
↑

To show the remaining time

Press [SLEEP].

Note:

- The sleep timer can be used together with the play timer.
- The sleep timer always comes first. Be sure not to set an overlap of timers.

Play timer

You can set the timer to come on at a certain time to wake you up.

Switch on the system and set the clock.

Prepare the music source you want to listen to (disc, radio, iPod, iPhone or AUX) and set the volume.

- 1 Press [CLOCK/TIMER] to select "⊙PLAY 1", "⊙PLAY 2" or "⊙PLAY 3".
- 2 Within 10 seconds, press [▲, ▼] to set the start time.
- 3 Press [OK].
- 4 Do steps 2 and 3 again to set the end time.

To start the timer

- 5 Press [⊙, PLAY] to start "⊙PLAY 1", "⊙PLAY 2" or "⊙PLAY 3".

- 6 Press [⏻] to switch off the system.

The system must be switched off for the timer to operate.

Change the settings	Do steps 1 through 4 and 6 again (⇒ above).
Change the source or volume	1) Press [⊙, PLAY] two times to remove the timer indicator on the display panel. 2) Change the source or volume. 3) Do steps 5 and 6 (⇒ above).
Check the settings	Press [CLOCK/TIMER] to select "⊙PLAY 1", "⊙PLAY 2" or "⊙PLAY 3".
Cancel	Press [⊙, PLAY] two times to remove the timer indicator on the display panel.

Note:

- The play timer starts at a low volume and increases gradually to the preset level.
- The timer comes on at the set time every day if the timer is on.
- If you switch off the system and switch on again while a timer is in operation, the timer will not stop at the end time.

Sound effects

Changing the sound quality

- 1 Press [SOUND] to select a sound effect.
- 2 Within 3 seconds, press [◀, ▶] to select the desired setting.

BASS	-4 to +4
TREBLE	
SURROUND	"ON SURROUND" or "OFF SURROUND"
INPUT LEVEL (For AUX source)	"NORMAL" or "HIGH"

Preset EQ

Press [PRESET EQ] to select a setting.

HEAVY	Adds punch to rock
SOFT	For background music
CLEAR	Clarifies higher frequencies
VOCAL	Adds gloss to vocal
FLAT	Cancels the all sound effect

D.BASS

This function lets you enjoy a powerful bass effect.

Press [D.BASS] to select "ON D.BASS" or "OFF D.BASS".

External equipment

Using the auxiliary input

You can connect a portable audio equipment and listen to the audio through this system.

Preparation

Switch off the equalizer (if any) of the portable audio equipment to prevent sound distortion.

Decrease the volume of the system and the portable audio equipment before you connect or disconnect the portable audio equipment.

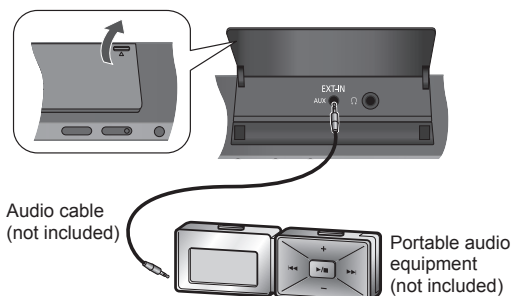

- 1 Connect the portable audio equipment.
Plug type: Ø 3.5 mm (1/8") stereo

- 2 Press [RADIO, EXT-IN] to select "AUX".

- 3 Play the portable audio equipment.

To adjust the audio input level (⇒ "Changing the sound quality").
Select "NORMAL" if the sound is distorted during "HIGH" input level.

Note:

- Read the operating instructions of the portable audio equipment for details.
- Components and cables are sold separately.

Remote control code

When other Panasonic equipment responds to the remote control of this system, change the remote control code for this system.

Preparation

Press [RADIO, EXT-IN] to select "AUX".

To set the code to "REMOTE 2"

- 1 Press and hold [RADIO, EXT-IN] on the main unit and [2] on the remote control until "REMOTE 2" is shown.
- 2 Press and hold [OK] and [2] for a minimum of 4 seconds.

To set the code to "REMOTE 1"

- 1 Press and hold [RADIO, EXT-IN] on the main unit and [1] on the remote control until "REMOTE 1" is shown.
- 2 Press and hold [OK] and [1] for a minimum of 4 seconds.

Troubleshooting guide

Before requesting service, make the following checks. If you are in doubt about some of the check points, or if the solutions indicated do not solve the problem, refer to "Customer Services Directory" (United States and Puerto Rico) on page 11.

Common problems

No operations can be done with the remote control.

- Examine that the battery is installed correctly.

Sound is distorted or no sound.

- Increase the volume.
- Switch off the system, determine and correct the cause, then switch the system on again. It can be caused by straining of the speakers through excessive volume or power, and when using the system in a hot environment.

A "humming" sound can be heard during playback.

- An AC power supply cord or fluorescent light is near the cable. Keep other appliances and cords away from the cable of this system.

Discs

Display not shown correctly.

Playback does not start.

- You have not put in the disc correctly. Put it in correctly.
- Disc is dirty. Clean the disc.
- Replace the disc if it is scratched, warped, or non-standard.
- There is condensation. Let the system dry for 1 to 2 hours.

The total number of tracks shown is incorrect.

The disc cannot be read.

Distorted sound is heard.

- You put in a disc that the system cannot play. Change to a playable disc.
- You put in a disc that has not been finalized.

Radio

A beat sound is heard.

- Switch off the TV or move it away from the system.
- Set to "BP 1" or "BP 2" when in AM tuner mode.

A low hum is heard during AM broadcasts.

- Move the antenna away from other cables and cords.

■ iPod or iPhone

You cannot switch on the iPod or iPhone.

- Examine that the battery of the iPod or iPhone is not depleted.
- Switch off the iPod or iPhone and the system before you connect the iPod or iPhone. Connect the iPod or iPhone and try again.

No sound

- Switch off the iPod or iPhone and remove from the system. Connect the iPod or iPhone to the system and switch it on and play it again.

■ Main unit displays

“NO PLAY”

- Examine the content. You can only play supported format.

“F76” or “F61”

- There is a power supply problem.

“ERROR”

- An incorrect operation was done. Read the instructions and try again.

“NOT MP3/ERROR”

- An unsupported MP3 format. The system will skip that track and play the next one.

“VBR-”

- The system cannot show the remaining play time for variable bit rate (VBR) tracks.

“NODEVICE”

- The iPod or iPhone is not connected. Examine the connection.

Memory reset (Initialization)

When the following situations occur, refer to the instructions below to reset the memory:

- There is no response when buttons are pressed.
- You want to clear and reset the memory contents.

To reset the memory

- 1 Disconnect the AC power supply cord.**
(Wait 3 minutes before you continue with step 2.)
- 2 While you press and hold [⏻, POWER] on the main unit, connect the AC power supply cord again.**
“-----” shows on the display panel.
- 3 Release [⏻, POWER].**
All the settings are set back to the factory preset. It is necessary to set the memory items again.

Maintenance

To clean this system, wipe with a soft, dry cloth.

- Never use alcohol, paint thinner or benzene to clean this system.
- Before using chemically treated cloth, read the instructions that came with the cloth carefully.

Specifications

■ Amplifier section

RMS output power stereo mode

Front Ch (both ch driven)	5 W per channel (6 Ω), 1 kHz, 10% THD
Total RMS stereo mode power	10 W

FTC output power stereo mode

Front Ch (both ch driven)	4.5 W per channel (6 Ω), 60 Hz to 20 kHz, 10% THD
Total FTC stereo mode power	9 W

■ FM/AM tuner, terminals section

Preset station	FM 30 stations AM 15 stations
----------------	----------------------------------

Frequency modulation (FM)

Frequency range	87.9 MHz to 107.9 MHz (200 kHz step) 87.5 MHz to 108.0 MHz (100 kHz step)
Antenna terminals	75 Ω (unbalanced)

Amplitude modulation (AM)

Frequency range	520 kHz to 1710 kHz (10 kHz step) 522 kHz to 1629 kHz (9 kHz step)
-----------------	---

Headphone jack

Terminal	Stereo, 3.5 mm (1/8") jack
----------	----------------------------

AUX (rear)

Terminal	Stereo, 3.5 mm (1/8") jack
----------	----------------------------

■ Disc section

Disc played [8 cm (3") or 12 cm (5")]

CD, CD-R/RW (CD-DA, MP3* formatted disc)

* MPEG-1 Layer 3, MPEG-2 Layer 3

Pick up

Wavelength	790 nm (CD)
Laser power	CLASS I (CD)

Audio output (Disc)

Number of channels	2 ch (FL, FR)
FL = Front left channel	
FR = Front right channel	

■ Speaker section

Type	1 way, 1 speaker system (bass reflex)
Speaker unit(s)	
Full range	8 cm (3 1/8") cone type
Impedance	6 Ω
Frequency range	60 Hz to 25 kHz (-16 dB) 90 Hz to 22 kHz (-10 dB)

■ General

Power supply	AC 120, 60 Hz
Power consumption	14 W
Dimensions (W x H x D)	400 mm x 221 mm x 110 mm (15 3/4" x 8 3/4" x 4 1/2") [D = 69 mm (2 3/4") minimum] [D = 149 mm (5 3/4") tray open]
Mass (weight)	2.1 kg (4.6 lb.)
Operating temperature range	0°C to +40°C (+32°F to +104°F)
Operating humidity range	35% to 80% RH (no condensation)

Power consumption in standby mode	0.1 W (approximate)
-----------------------------------	---------------------

Note:

- 1) Specifications are subject to change without notice. Mass and dimensions are approximate.
- 2) Total harmonic distortion is measured by the digital spectrum analyzer.

Limited Warranty

Panasonic Consumer Electronics Company,
Division of Panasonic Corporation of North America
One Panasonic Way, Secaucus, New Jersey 07094

Panasonic Home Audio Products Limited Warranty

Limited Warranty Coverage (For USA and Puerto Rico Only)

If your product does not work properly because of a defect in materials or workmanship, Panasonic Consumer Electronics Company (referred to as "the warrantor") will, for the length of the period indicated on the chart below, which starts with the date of original purchase ("warranty period"), at its option either (a) repair your product with new or refurbished parts, (b) replace it with a new or a refurbished equivalent value product, or (c) refund your purchase price. The decision to repair, replace or refund will be made by the warrantor.

Product or Part Name	Parts	Labor
Audio Products (except items below)	1 year	1 year
DVD Home Theater System	1 year	1 year
Home Theater Audio System	1 year	1 year
USB Reader-writer, PC Card Adapters (defective exchange)	1 year	Not Applicable
Accessories: Headphones, cartridges, Microphones, Adapters	90 days	90 days
Rechargeable Batteries, DVD-RAM Disc (defective exchange)	10 days	Not Applicable
SD Memory Cards, Rechargeable Battery Packs (defective exchange)	90 days	Not Applicable

During the "Labor" warranty period there will be no charge for labor. During the "Parts" warranty period, there will be no charge for parts. This Limited Warranty excludes both parts and labor for non-rechargeable batteries, antennas, and cosmetic parts (cabinet). This warranty only applies to products purchased and serviced in the United States or Puerto Rico. This warranty is extended only to the original purchaser of a new product which was not sold "as is".

Carry-In or Mail-In Service

To find a service center please visit <http://www.panasonic.com/help> or call 1-800-211-PANA (7262).

When shipping the unit, carefully pack, include all accessories, and send it prepaid, adequately insured and preferably in the original carton. When shipping Lithium Ion batteries please visit our Web Site at www.panasonic.com/BatteryHandling as Panasonic is committed to providing the most up to date information. Include a letter detailing the complaint, a return address and provide a daytime phone number where you can be reached. A valid registered receipt is required under the Limited Warranty.

IF REPAIR IS NEEDED DURING THE WARRANTY PERIOD, THE PURCHASER WILL BE REQUIRED TO FURNISH A SALES RECEIPT/PROOF OF PURCHASE INDICATING DATE OF PURCHASE, AMOUNT PAID AND PLACE OF PURCHASE. CUSTOMER WILL BE CHARGED FOR THE REPAIR OF ANY UNIT RECEIVED WITHOUT SUCH PROOF OF PURCHASE.

Limited Warranty Limits And Exclusions

This warranty ONLY COVERS failures due to defects in materials or workmanship, and DOES NOT COVER normal wear and tear or cosmetic damage. The warranty ALSO DOES NOT COVER damages which occurred in shipment, or failures which are caused by products not supplied by the warrantor, or failures which result from accidents, misuse, abuse, neglect, mishandling, misapplication, alteration, faulty installation, set-up adjustments, misadjustment of consumer controls, improper maintenance, power line surge, lightning damage, modification, introduction of sand, humidity or liquids, commercial use such as hotel, office, restaurant, or other business or rental use of the product, or service by anyone other than a Factory Service Center or other Authorized Servicer, or damage that is attributable to acts of God.

THERE ARE NO EXPRESS WARRANTIES EXCEPT AS LISTED UNDER "LIMITED WARRANTY COVERAGE".

THE WARRANTOR IS NOT LIABLE FOR INCIDENTAL OR CONSEQUENTIAL DAMAGES RESULTING FROM THE USE OF THIS PRODUCT, OR ARISING OUT OF ANY BREACH OF THIS WARRANTY. (As examples, this excludes damages for lost time, travel to and from the servicer, loss of or damage to media or images, data or other memory or recorded content. The items listed are not exclusive, but for illustration only.)

ALL EXPRESS AND IMPLIED WARRANTIES, INCLUDING THE WARRANTY OF MERCHANTABILITY, ARE LIMITED TO THE PERIOD OF THE LIMITED WARRANTY.

Some states do not allow the exclusion or limitation of incidental or consequential damages, or limitations on how long an implied warranty lasts, so the exclusions may not apply to you.

This warranty gives you specific legal rights and you may also have other rights which vary from state to state. If a problem with this product develops during or after the warranty period, you may contact your dealer or Service Center. If the problem is not handled to your satisfaction, then write to the warrantor's Consumer Affairs Department at the addresses listed for the warrantor.

PARTS AND SERVICE, WHICH ARE NOT COVERED BY THIS LIMITED WARRANTY, ARE YOUR RESPONSIBILITY.

Customer Services Directory (United States and Puerto Rico)

Obtain Product Information and Operating Assistance; locate your nearest Dealer or Service Center; purchase Parts and Accessories; or make Customer Service and Literature requests by visiting our Web Site at:

<http://www.panasonic.com/help>

or, contact us via the web at:

<http://www.panasonic.com/contactinfo>

You may also contact us directly at:

1-800-211-PANA (7262)

Monday-Friday 9am-9pm, Saturday-Sunday 10am-7pm EST

For hearing or speech impaired TTY users, TTY: 1-877-833-8855

Accessory Purchases (United States and Puerto Rico)

Purchase Parts, Accessories and Instruction Books online for all Panasonic Products by visiting our Web Site at:

<http://www.pstc.panasonic.com>

or, send your request by E-mail to:

npcparts@us.panasonic.com

You may also contact us directly at:

1-800-332-5368 (Phone) 1-800-237-9080 (Fax Only)

(Monday-Friday 9am-9pm EST)

Panasonic Service and Technology Company

20421 84th Avenue South, Kent, WA 98032

(We accept Visa, MasterCard, Discover Card, American Express, and Personal Checks)

For hearing or speech impaired TTY users, TTY: 1-866-605-1277

As of December 2010

Cómo preparar el control remoto

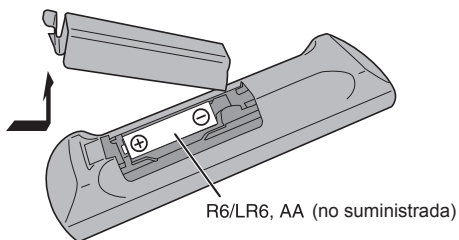

Use pila alcalinas o de manganeso.

Instale la pila de modo que los polos (+ y -) queden alineados con los del control remoto.

Apunte el control remoto al sensor del control remoto (➔ 13), lejos de obstáculos, dentro de un rango máximo de 7 m (23 pies) directamente al frente de la unidad principal.

¡ADVERTENCIA!

- No desarme o provoque un cortocircuito con la pila.
- No intente recargar pilas alcalinas o de manganeso.
- No use pila cuya cubierta haya sido arrancada.
- No caliente o exponga a las llamas.
- No deje la(s) pilas(s) en un automóvil expuesto a luz solar directa durante un largo período de tiempo con las puertas y ventanas cerradas.
- Un mal manejo de la pila del control remoto podría provocar fugas electrolíticas, que podrían causar un incendio.
- Saque la pila si no va a usar el control remoto durante un período prolongado. Guárdelas en un lugar fresco y oscuro.

¡ADVERTENCIA!

Hay peligro de explosión si se sustituye incorrectamente la pila. Sólo sustituya con el mismo tipo o equivalente recomendado por el fabricante. Deseche las pilas usadas según instrucciones del fabricante.

Cómo realizar las conexiones

Cómo ahorrar energía

El sistema consume aproximadamente 0.1 W cuando está en modo de espera. Desconecte la fuente de alimentación cuando no use el sistema.

Se perderán algunas configuraciones cuando desconecte el sistema. Tendrá que configurarlas nuevamente.



1 Conecte la antena interior FM.

Coloque la antena donde la recepción sea la mejor.

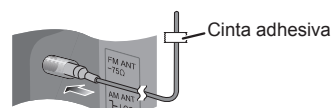

2 Conecte la antena de cuadro AM.

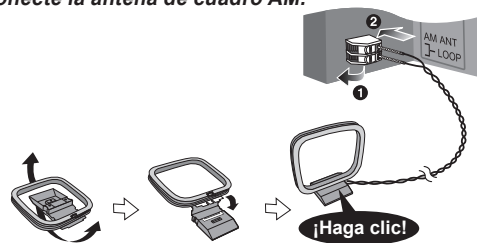

3 Conecte el cable de alimentación de CA.

Use exclusivamente el cable de alimentación de CA suministrado con este sistema.

No use un cable de alimentación de CA de otro equipo.

Nota:

- Estas bocinas no disponen de blindaje magnético. No los ponga cerca de televisores, computadores personales y otros equipos a los que afecte fácilmente el magnetismo.
- No puede quitar la red de las bocinas.

Control remoto



1 Interruptor de alimentación en espera/conectada [⏻], [⏻/⏻], **POWER** (→ 10, 15)
Pulse este interruptor para cambiar del modo de alimentación conectada al modo de alimentación en espera o viceversa. En el modo de alimentación en espera, la unidad consume una pequeña cantidad de corriente.

2 Botones numéricos [1 a 9, 0, ≥10]
Para configurar un número de dos dígitos
Ejemplo: 16: [≥10] → [1] → [6]

3 Borre una pista programada (→ 6)

4 Seleccionar fuente
[iPod]: Seleccione iPod (→ 14)
[CD]: Seleccione disco (→ 14)
[RADIO, EXT-IN]: Seleccione radio o AUX (→ 9, 15)

5 Operación básica
[▶/||]: Operación de reproducción o pausa
[■]: Detener reproducción
[◀◀], [▶▶]: Saltar pista
Seleccione estación de radio predeterminadas
[◀◀], [▶▶]: Busque pista
Sintonice la estación de radio
[◀◀/▶▶], [▶▶/▶▶]: Saltar y busque pista
Seleccione estación de radio predeterminada

6 Seleccione los efectos de sonido (→ 9)

7 Seleccione el ítem menú del iPod (→ 14)

8 Visualice la información mostrada en el panel de visualización.
Disminuya el brillo del panel de visualización
Pulse y mantenga pulsado el botón para usar esta función.
Para cancelar, pulse y mantenga pulsado el botón nuevamente.

9 Configure el temporizador de apagado automático (→ 8)
Configure el reloj y el temporizador (→ 15)

10 Configure la función el programa (→ 6, 15)

11 Ajuste el volumen del sistema.

12 Desactive el sonido del sistema
Pulse el botón nuevamente para cancelar.
"MUTE" también se cancela cuando usted ajusta el volumen o cuando apaga el sistema.

13 Configurar el ítem del menú de reproducción (→ 14)

14 Configurar el ítem del menú de radio (→ 15)

15 [▲, ▼]: Saltar álbum
Ajustar la configuración del reloj
[◀, ▶]: Seleccionar el ítem en el menú
[OK]: Confirmar los configuración

16 Apagar automáticamente el sistema
Esta función apaga el sistema (excepto cuando se está en fuente de radio) si no utiliza el sistema durante aproximadamente 30 minutos.
Para cancelar, pulse el botón dos veces.

17 Toma de audífonos (🎧)
Tipo de clavija: estéreo de Ø 3.5 mm (1/8") (no suministrada)
• Procure evitar utilizarlos mucho rato con el fin de evitar lesiones auditivas.
• La presión excesiva de los auriculares puede causar pérdida de audición.
• Escuchar a todo volumen durante períodos prolongados podría dañar los oídos del usuario. Asegúrese de usar los audífonos o auriculares suministrados o recomendados.

18 Toma AUX

19 Abre o cierra la puerta corredera

20 Panel de visualización

21 Puerta corredera

22 Sensor del control remoto

23 Abre o cierra la estación de acoplamiento del iPod o iPhone

Unidad principal

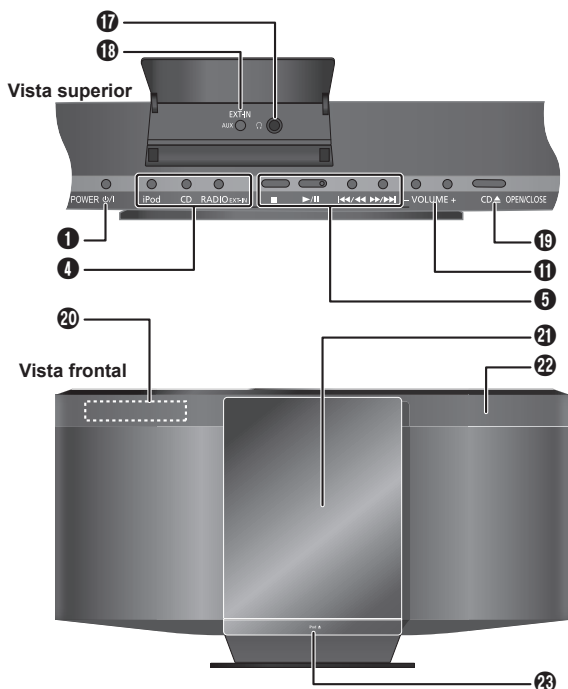

Discos

Cómo reproducir discos

- 1 Pulse [CD ▲, OPEN/CLOSE] en la unidad principal para abrir la puerta corrediza
Coloque un disco con la etiqueta mirando hacia usted.
Pulse [CD ▲, OPEN/CLOSE] nuevamente para cerrar la puerta corrediza.



- 2 Pulse [CD] y después pulse [▶/II] para iniciar la reproducción.
Aleje los dedos de la puerta corrediza cuando está cerrando.

Detener reproducción	Pulse [■] durante la reproducción.
Pausar reproducción	Pulse [▶/II] durante la reproducción. Pulse nuevamente para continuar la reproducción.
Saltar álbum	[MP3] Pulse [▲, ▼].
Saltar pista	Pulse [◀◀] o [▶▶] (unidad principal: [◀◀/▶▶] o [▶▶/▶▶]).
Buscar por pista	[CD] Pulse y mantenga pulsado [◀◀] o [▶▶] (unidad principal: [◀◀/▶▶] o [▶▶/▶▶]).

Función de modo de reproducción

- 1 Pulse [PLAY MENU] para seleccionar "PLAYMODE".
- 2 Pulse [◀, ▶] y luego pulse [OK] para seleccionar el modo deseado.

OFF PLAYMODE	Reproducir todas las pistas.
1-TRACK <small>1TR</small>	Reproduce una pista seleccionada del disco. Pulse los botones numéricos para seleccionar la pista. La reproducción empieza desde la pista seleccionada.
1-ALBUM <small>1ALBUM</small>	[MP3] Reproduce un álbum seleccionado del disco. Pulse [▲, ▼] para seleccionar el álbum.
RANDOM <small>RND</small>	Reproduce un disco aleatoriamente.
1- ALBUM RANDOM <small>1ALBUM RND</small>	[MP3] Reproduce todas las pistas de un álbum seleccionado aleatoriamente. Pulse [▲, ▼] para seleccionar el álbum.

Repetir la reproducción

- 1 Pulse [PLAY MENU] para seleccionar "REPEAT".
- 2 Pulse [◀, ▶] para seleccionar "ON REPEAT" y después pulse [OK].
Se visualiza "Ⓞ".
Para cancelar, seleccione "OFF REPEAT".

Cómo usar un iPod o iPhone

Preparación

Actualice su iPod o iPhone con el software más reciente.

- 1 Pulse [▲, iPod] para abrir la bandeja de la estación de acoplamiento.
- 2 Inserte un adaptador de estación de acoplamiento compatible.

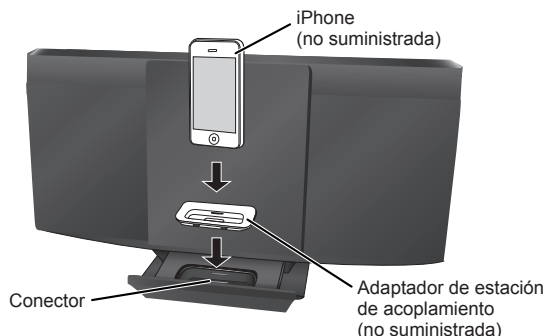

- 3 Conecte el iPod o el iPhone con firmeza.
Asegúrese de quitar el iPod o el iPhone de su funda.
- 4 Pulse [iPod] y después pulse [▶/II] para iniciar la reproducción.

Pausar reproducción	Pulse [▶/II] o [■].
Saltar pista	Pulse [◀◀] o [▶▶] (unidad principal: [◀◀/▶▶] o [▶▶/▶▶]).
Busque la pista actual	Pulse y mantenga pulsado [◀◀] o [▶▶] (unidad principal: [◀◀/▶▶] o [▶▶/▶▶]).
Vea el menú del iPod o iPhone, Regrese al menú anterior	Pulse [iPod MENU] en el modo reproducción.
Seleccione un ítem del menú del iPod ou iPhone	Pulse [▲, ▼] y después pulse [OK].

Nota:

- Asegúrese de alinear su iPod o iPhone con el conector al insertarlo.
- Dependiendo del modelo, podría requerirse quitar el iPod o el iPhone y elegir el álbum, artista, etc. en el iPod o en el iPhone.
- El funcionamiento podría variar dependiendo de los modelos de iPod o iPhone.
- Lea la Guía de Usuario del iPod o iPhone para ver las instrucciones de funcionamiento.

Radio

Sintonización manual

- 1 Pulse [RADIO, EXT-IN] para seleccionar "FM" o "AM".
- 2 Pulse [◀◀] o [▶▶] para seleccionar la frecuencia de la emisora requerida.
Para sintonizar automáticamente, pulse y mantenga pulsado el botón hasta que la frecuencia comience a cambiar rápidamente.

Para mejorar la calidad del sonido

Cuando se haya seleccionado "FM"

- 1 Pulse [RADIO MENU] para seleccionar "FM MODE".
 - 2 Pulse [◀, ▶] para seleccionar "MONO" y después pulse [OK].
Para cancelar, seleccione "STEREO".
- "MONO" también se cancela cuando cambia la frecuencia.
 - Deje "MONO" desactivado para la escucha normal.

Cuando se haya seleccionado "AM"

- 1 Pulse [RADIO MENU] para seleccionar "B.PROOF".
- 2 Pulse [◀, ▶] para seleccionar "BP 1" o "BP 2" y después pulse [OK].

Presintonización de la memoria

Se pueden preconfigurar 30 emisoras de FM y 15 de AM.

Preparación

Pulse [RADIO, EXT-IN] para seleccionar "FM" o "AM".

Preconfiguración automática

- 1 Pulse [OK] para seleccionar la frecuencia "LOWEST" (más baja) o "CURRENT" (actual).
- 2 Pulse [RADIO MENU] para seleccionar "A.PRESET" y después pulse [OK].
Se visualiza "START?".
- 3 Pulse [OK] para iniciar la preconfiguración.

Preconfiguración manual

- 1 Pulse [◀◀] o [▶▶] para sintonizar la estación.
- 2 Pulse [PROGRAM].
- 3 Pulse los botones numéricos para seleccionar un número preconfigurado.
Realice los pasos 1 al 3 nuevamente para preconfigurar más estaciones.
La estación más reciente reemplazará cualquier estación que ocupe el mismo número preconfigurado.

Selección de una emisora preconfigurada

Pulse los botones numéricos, [◀◀] o [▶▶] (unidad principal: [◀◀/◀◀] o [▶▶/▶▶]) para seleccionar la estación preconfigurada.

Reloj y temporizador

Configuración de la hora

Éste es un reloj con un sistema de 12 horas.

- 1 Pulse [CLOCK/TIMER] para seleccionar "CLOCK".
- 2 **Dentro de 10 segundos**, pulse [▲, ▼] para configurar la hora.
- 3 Pulse [OK].

Pulse [CLOCK/TIMER] para visualizar el reloj durante unos segundos.

Nota:

Vuelva a poner en hora el reloj frecuentemente para mantener su exactitud.

Temporizador de reproducción

Puede configurar el temporizador para activarse a una hora determinada y despertarle.

Encienda la unidad y configure la hora del reloj.

Prepare la fuente musical que desea escuchar (disco, radio, iPod, iPhone o AUX) y configure el volumen.

- 1 Pulse [CLOCK/TIMER] para seleccionar "⊖PLAY 1", "⊖PLAY 2" o "⊖PLAY 3".
 - 2 **Dentro de 10 segundos**, pulse [▲, ▼] para configurar la hora de inicio.
 - 3 Pulse [OK].
 - 4 Repita los pasos 2 y 3 para configurar la hora de finalización.
- Para iniciar el temporizador**
- 5 Pulse [⊖, PLAY] para iniciar "⊖PLAY 1", "⊖PLAY 2" o "⊖PLAY 3".
 - 6 Pulse [⏻] para apagar el sistema.
La sistema debe estar apagado para que el temporizador funcione.

Cambiar la configuración	Ejecute los pasos del 1 al 4 y el 6 nuevamente (➡ arriba).
Cambiar la fuente o el volumen	1) Pulse [⊖, PLAY] dos veces para eliminar el indicador del temporizador del panel de visualización. 2) Cambiar la fuente o el volumen. 3) Ejecute los pasos 5 y 6 (➡ arriba).
Compruebe la configuración	Pulse [CLOCK/TIMER] para seleccionar "⊖PLAY 1", "⊖PLAY 2" o "⊖PLAY 3".
Cancelar	Pulse [⊖, PLAY] dos veces para eliminar el indicador del temporizador del panel de visualización.

Nota:

- El temporizador de reproducción iniciará con un volumen bajo y aumentará gradualmente hasta el nivel preconfigurado.
- Si el temporizador está activo, se encenderá todos los días a la hora configurada.
- Si apaga el sistema y lo vuelve a encender mientras está funcionando el temporizador, el temporizador no terminará a la hora final.

Panasonic Consumer Electronics Company,
Division of Panasonic Corporation of North America
One Panasonic Way, Secaucus,
New Jersey 07094
<http://www.panasonic.com>

(En) (Sp)