

Panasonic®

Owner's Manual Compact Stereo System

Model No. SC-HC400

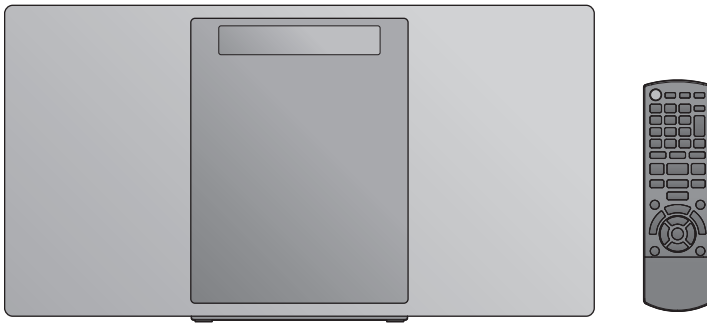

Thank you for purchasing this product.
Please read these instructions carefully before using this product,
and save this manual for future use.

Included Installation Instructions (→ 3, 18 and 19)

The installation work should be done by a qualified installation specialist.

Before commencing work, carefully read these installation instructions and the operating instructions to ensure that installation is performed correctly.

(Please keep these instructions. You may need them when maintaining or moving this unit.)

If you have any questions, visit:
www.panasonic.ca/english/support

Panasonic Canada Inc.

5770 Ambler Drive,
Mississauga, Ontario,
L4W 2T3

www.panasonic.com

© Panasonic Corporation 2017

Printed in Malaysia

PC

En

TQBJ2049

F0317YM1037

IMPORTANT SAFETY INSTRUCTIONS

Read these operating instructions carefully before using the unit. Follow the safety instructions on the unit and the applicable safety instructions listed below. Keep these operating instructions handy for future reference.

- 1 Read these instructions.
- 2 Keep these instructions.
- 3 Heed all warnings.
- 4 Follow all instructions.
- 5 Do not use this apparatus near water.
- 6 Clean only with dry cloth.
- 7 Do not block any ventilation openings. Install in accordance with the manufacturer's instructions.
- 8 Do not install near any heat sources such as radiators, heat registers, stoves, or other apparatus (including amplifiers) that produce heat.
- 9 Do not defeat the safety purpose of the polarized or grounding-type plug. A polarized plug has two blades with one wider than the other. A grounding-type plug has two blades and a third grounding prong. The wide blade or the third prong are provided for your safety. If the provided plug does not fit into your outlet, consult an electrician for replacement of the obsolete outlet.
- 10 Protect the power cord from being walked on or pinched particularly at plugs, convenience receptacles, and the point where they exit from the apparatus.
- 11 Only use attachments/accessories specified by the manufacturer.
- 12 Use only with the cart, stand, tripod, bracket, or table specified by the manufacturer, or sold with the apparatus. When a cart is used, use caution when moving the cart/apparatus combination to avoid injury from tip-over.
- 13 Unplug this apparatus during lightning storms or when unused for long periods of time.
- 14 Refer all servicing to qualified service personnel. Servicing is required when the apparatus has been damaged in any way, such as power-supply cord or plug is damaged, liquid has been spilled or objects have fallen into the apparatus, the apparatus has been exposed to rain or moisture, does not operate normally, or has been dropped.



WARNING

Unit

- To reduce the risk of fire, electric shock or product damage,
 - Do not expose this unit to rain, moisture, dripping or splashing.
 - Do not place objects filled with liquids, such as vases, on this unit.
 - Use only the recommended accessories.
 - Do not remove covers.
 - Do not repair this unit by yourself. Refer servicing to qualified service personnel.

AC power supply cord

- The power plug is the disconnecting device. Install this unit so that the power plug can be unplugged from the socket outlet immediately.

CAUTION

Unit

- This unit utilizes a laser. Use of controls or adjustments or performance of procedures other than those specified herein may result in hazardous radiation exposure.
- Do not place sources of naked flames, such as lighted candles, on this unit.

Placement

- To reduce the risk of fire, electric shock or product damage,
 - Do not install or place this unit in a bookcase, built-in cabinet or in another confined space. Ensure this unit is well ventilated.
 - Do not obstruct this unit's ventilation openings with newspapers, tablecloths, curtains, and similar items.

Battery

- Danger of explosion if battery is incorrectly replaced. Replace only with the type recommended by the manufacturer.
- Mishandling of batteries can cause electrolyte leakage and may cause a fire.
 - Remove the battery if you do not intend to use the remote control for a long period of time. Store in a cool, dark place.
 - Do not heat or expose to flame.
 - Do not leave the battery(ies) in a car exposed to direct sunlight for a long period of time with doors and windows closed.
 - Do not take apart or short circuit.
 - Do not recharge alkaline or manganese batteries.
 - Do not use batteries if the covering has been peeled off.
- When disposing of the batteries, please contact your local authorities or dealer and ask for the correct method of disposal.

CAN ICES-3(B)/NMB-3(B)

Contains IC: 216A-B21R1401

This device complies with Industry Canada's license-exempt RSSs. Operation is subject to the following two conditions:
(1) this device may not cause interference, and
(2) this device must accept any interference, including interference that may cause undesired operation of the device.

This transmitter must not be co-located or operated in conjunction with any other antenna or transmitter.

This equipment complies with IC radiation exposure limits set forth for an uncontrolled environment and meets the RSS-102 of the IC radio frequency (RF) Exposure rules. This equipment has very low levels of RF energy that is deemed to comply without maximum permissive exposure evaluation (MPE). But it is desirable that it should be installed and operated keeping the radiator at least 20 cm (7 7/8") or more away from person's body (excluding extremities: hands, wrists, feet and ankles).

The device meets the exemption from the routine evaluation limits in section 2.5 of RSS 102 and compliance with RSS-102 RF exposure, users can obtain Canadian information on RF exposure and compliance.





CAUTION



RISK OF ELECTRIC SHOCK
DO NOT OPEN



CAUTION : TO REDUCE THE RISK OF ELECTRIC SHOCK, DO NOT REMOVE SCREWS. NO USER-SERVICEABLE PARTS INSIDE. REFER SERVICING TO QUALIFIED SERVICE PERSONNEL.

-  The lightning flash with arrowhead symbol, within an equilateral triangle, is intended to alert the user to the presence of uninsulated "dangerous voltage" within the product's enclosure that may be of sufficient magnitude to constitute a risk of electric shock to persons.
-  The exclamation point within an equilateral triangle is intended to alert the user to the presence of important operating and maintenance (servicing) instructions in the literature accompanying the appliance.

The symbols on this product (including the accessories) represent the following:

- ~ AC
- DC
-  Class II equipment (The construction of the product is double-insulated.)
- | On
-  Standby

About descriptions in these operating instructions

- Pages to be referred to are indicated as "→ ○○".
- Unless otherwise indicated, operations are described using the remote control. You can also use the controls on this unit if they are the same.

Table of contents

IMPORTANT SAFETY INSTRUCTIONS..... 2

Accessories..... 3

Control reference guide..... 4

Using the remote control..... 5

Licenses..... 5

Connections..... 6

Inserting media..... 7

Bluetooth® operations 8

About Bluetooth® 9

Media playback controls 9

Listening to FM radio..... 11

Sound adjustment..... 12

Clock and Timer 12

Others..... 13

Troubleshooting..... 14

Unit and media care 16

Playable media 16

Specifications 17

Attaching the unit to a wall (optional) 18

Limited Warranty..... 20

Accessories

Check the supplied accessories before using this unit.

- 1 Remote control**
(N2QAYB001139)
- 1 Battery for remote control**
- 1 AC power supply cord**
(For the black model: K2CB2YY00110)
(For the silver model: K2CB2YY00111)
- 1 FM indoor antenna**
(RSAX0002)



Wall mounting accessories

- 1 Safety holder**
(TPBDA004)
- 2 Wall mount brackets**
(RSC1262-1)
- 1 Wall mounting sheet**

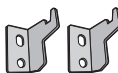
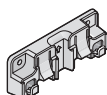

- Use this sheet for wall mounting. (→ 18)

The enclosed Canadian French label sheet corresponds to the English display on the top, front and rear of the main unit.



- Do not use AC power supply cord with other equipment.
- Product numbers provided in these operating instructions are correct as of February 2017. These may be subject to change.

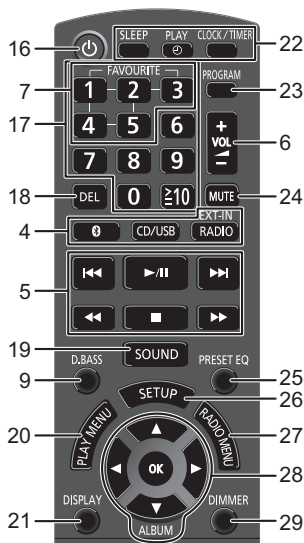

- 16 Turn the unit on or off
- 17 Select number
 - To select a 2-digit number
Example: 16: [≧10] → [1] → [6]
 - To select a 3-digit number
Example: 124: [≧10] → [1] → [2] → [4]
- 18 Delete a programed track
- 19 Enter sound menu
- 20 Set the play menu item
- 21 Change the displayed information
- 22 Clock and timer operation
- 23 Set the program function
- 24 Mute the sound
Press again to cancel. "MUTE" is also canceled when the volume is adjusted or the unit is turned off.
- 25 Select preset EQ
- 26 Enter setup menu
- 27 Set the radio menu item
- 28 Selection/OK
- 29 Dim the display panel and indicator
Press again to cancel.

Using the remote control

Insert the battery so the terminals (+ and -) match those in the remote control.

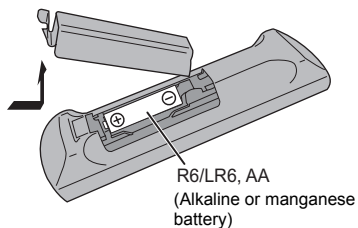

Point it at the remote control signal sensor on this unit.

- To avoid interference, please do not put any objects in front of signal sensor.

Licenses

The Bluetooth® word mark and logos are registered trademarks owned by Bluetooth SIG, Inc. and any use of such marks by Panasonic Corporation is under license. Other trademarks and trade names are those of their respective owners.

MPEG Layer-3 audio coding technology licensed from Fraunhofer IIS and Thomson.

Connections

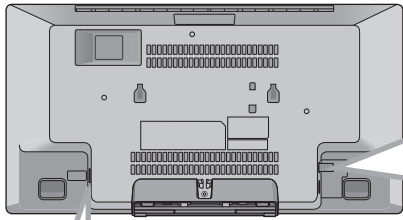

1 Connect the antenna.

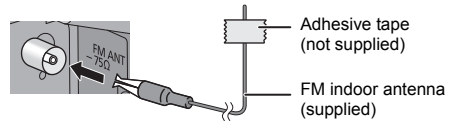

2 Connect the AC power supply cord after all other connections are completed.

This unit consumes a small amount of AC power (→ 17) even when turned off.

- In the interest of energy conservation, if you will not be using this unit for an extended period of time, unplug it from the AC outlet.
- Some settings will be lost after you disconnect the system. You have to set them again.

To an AC outlet

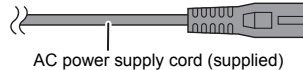

- Tape the antenna to a wall or column in a position with the least amount of interference.
- If radio reception is poor, use an outdoor antenna (not supplied).

Connect an external music device

1 Connect an external music device using an audio cable (not supplied).

- Plug type: $\varnothing 3.5$ mm (1/8") stereo

2 Press [RADIO, EXT-IN] repeatedly to select "AUX" and start playback on the connected device.

To select the sound input level of the external device

1 While in AUX mode, press [SOUND] repeatedly to select "INPUT LEVEL".

2 Press [◀, ▶] to select "NORMAL" or "HIGH" and then press [OK].

- The factory default is "NORMAL".

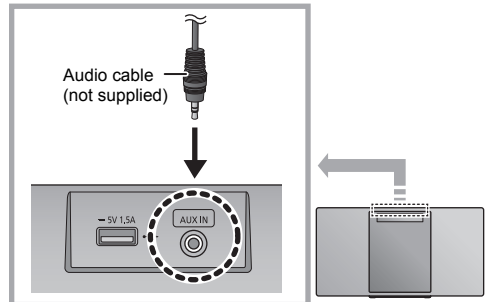

- To improve sound distortion when "HIGH" is selected, select "NORMAL".
- Switch the equalizer off or turn the volume of the external device down to reduce the input signal. High level of input signal will distort the sound.
- For details, refer to the operating instructions of the device.

Inserting media

■ Connecting a USB device

- Insert the USB device directly. Do not use any USB extension cable.
- Please disconnect the USB device if you finish using.
- Before removing the USB device, select a source other than "USB".

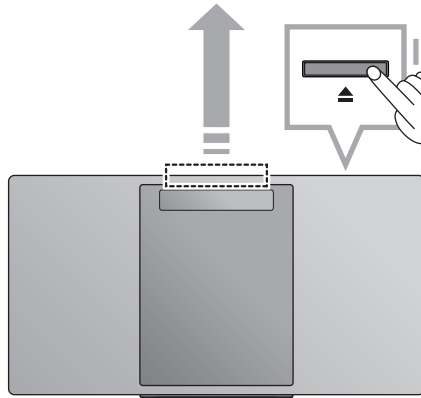
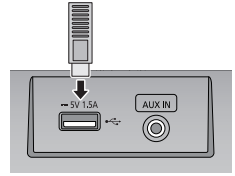

■ Inserting a CD

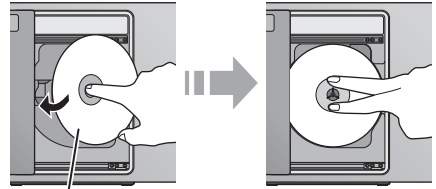

The label side

- Make sure to tilt the disc so as not to touch the sliding door.
- Do not open the sliding door manually.

■ Charging a device

Charging starts when a device (rated value: 5 V/1.5 A) is connected to the USB port of this unit.

1 Turn the unit on.

2 Connect a device.

↳ Confirm from the screen of the connected device, etc. to make sure charging has started.

- A cable compatible with your device is required. Use the cable that comes with your device.
- Even if you connect a cable compatible with the USB port of this unit, your device may not be charged. In that case, use the charger that comes with the device.
- Depending on your device, using other chargers may not work. Check the operating instructions of your device before use.
- Do not connect a device with a rated value higher than 5 V/1.5 A to this unit.
- To check if charging is complete, look at the screen of the connected device, etc.
- Once fully charged, remove the USB cable from the USB port.
- After the device has started charging, you can turn the unit to standby mode.
 - When charging a depleted device, do not turn the unit to standby mode until the device becomes operational.

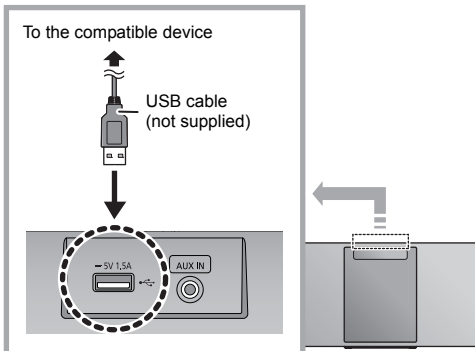

- Make sure that the unit does not fall when inserting or removing media.
- When moving this unit, be sure to remove all media and turn this unit to standby mode.

About Bluetooth®

Panasonic bears no responsibility for data and/or information that is compromised during a wireless transmission.

■ Frequency band used

- This system uses the 2.4 GHz frequency band.

■ Certification of this device

- This system conforms to frequency restrictions and has received certification based on frequency laws. Thus, a wireless permit is not necessary.
- The actions below are punishable by law in some countries:
 - Taking apart or modifying the system.
 - Removing specification indications.

■ Restrictions of use

- Wireless transmission and/or usage with all Bluetooth® equipped devices is not guaranteed.
- All devices must conform to standards set by Bluetooth SIG, Inc.
- Depending on the specifications and settings of a device, it can fail to connect or some operations can be different.
- This system supports Bluetooth® security features. But depending on the operating environment and/or settings, this security is possibly not sufficient. Transmit data wirelessly to this system with caution.
- This system cannot transmit data to a Bluetooth® device.

■ Range of use

- Use this device at a maximum range of 10 m (33 ft). The range can decrease depending on the environment, obstacles or interference.

■ Interference from other devices

- This system may not function properly and troubles such as noise and sound jumps may arise due to radio wave interference if this system is located too close to other Bluetooth® devices or the devices that use the 2.4 GHz band.
- This system may not function properly if radio waves from a nearby broadcasting station, etc. is too strong.

■ Intended usage

- This system is for normal, general use only.
- Do not use this system near an equipment or in an environment that is sensitive to radio frequency interference (example: airports, hospitals, laboratories, etc).

Media playback controls

The following marks indicate the availability of the feature.

- [CD]**: CD audio in CD-DA format or a CD that contains MP3 files (→ 16)
- [USB]**: USB devices containing MP3 file (→ 16)
- [BLUETOOTH]**: Connected Bluetooth® device (→ 8)

Basic play

([CD], [USB], [BLUETOOTH])

Preparation

- Turn the unit on.
- Insert the media or connect the Bluetooth® compatible device. (→ 7, 8)

1

Select the audio source.

For disc:

Press [CD/USB] repeatedly to select "CD".

For USB device:

Press [CD/USB] repeatedly to select "USB".

For Bluetooth® device:

Press [] to select "BLUETOOTH".

(When selecting using this unit, press [SELECTOR, -  PAIRING].)

2

Press [▶/||] to start playback.

Basic controls

Stop	Press [■]. <ul style="list-style-type: none">• [USB]: The position is memorized and "RESUME" is displayed.• [USB]: Press [■] twice to stop the playback fully.
Pause	Press [▶/]. Press again to continue playback.
Skip	Press [◀◀] or [▶▶] to skip track. (This unit: [◀◀/◀◀] or [▶▶/▶▶]) [CD] (MP3), [USB] Press [▲] or [▼] to skip the album.
Search	During play or pause, press and hold [◀◀] or [▶▶]. (This unit: [◀◀/◀◀] or [▶▶/▶▶])

■ To display information

([CD], [USB], [BLUETOOTH])

You can display the track, artist, album name, file type, bit rate, and other information. (The information varies depending on the audio source.)

Press [DISPLAY] repeatedly.

e.g. **[USB]** (MP3)

"A□□□": MP3 album number.

"T□□□": MP3 track number.

("□" stands for a number.)



- To use this unit's remote control with a Bluetooth® device, the Bluetooth® device must support AVRCP (Audio Video Remote Control Profile). Depending on the status of the device, some controls may not work.
- **CD**, **USB**: Tracks can be selected by pressing the numeric buttons.
- Maximum number of displayable characters: Approx. 32
- This system supports ver. 1 and 2 ID3 tags.
- Text data that is not supported will not be displayed or will be shown differently.

Playback modes **(CD, USB)**

Select the playback mode.

- 1 Press [PLAY MENU] repeatedly to select "PLAYMODE" or "REPEAT".
- 2 Press [◀, ▶] to select the setting and then press [OK].

PLAYMODE

OFF PLAYMODE	Cancels the play mode setting.
1-TRACK	Only plays the selected track. • "1", "➤" is displayed. (Skip to the desired track.)
1-ALBUM	Only plays the selected album. • Press [▲] or [▼] to select the album. • "1", "■" is displayed.
RANDOM	Plays the contents randomly. • "RND" is displayed.
1-ALBUM RANDOM	Plays the tracks in the selected album randomly. • Press [▲] or [▼] to select the album. • "1", "■", "RND" is displayed.

REPEAT

ON REPEAT	Turns on repeat mode. • "🔄" is displayed.
OFF REPEAT	Turns off repeat mode.



- During random playback, you cannot skip to tracks which have been played or press the numeric buttons.
- Playmode function does not work with "Program play".
- The mode is canceled when you open the sliding door or remove the USB device.

Program play

(CD, USB)

This function allows you to program up to 24 tracks.

CD (CD-DA)

- 1 Press [PROGRAM] in the stop mode.
 - "PROGRAM" is shown for a few seconds.
- 2 Press the numeric buttons to select the desired track.
 - Do this step again to program other tracks.
- 3 Press [▶/||] to start playback.

CD (MP3), **USB**

- 1 Press [PROGRAM] in the stop mode.
 - "PROGRAM" is shown for a few seconds.
- 2 Press [▲, ▼] to select the desired album.
- 3 Press [▶▶] and then press the numeric buttons to select the desired track.
- 4 Press [OK].
 - Do steps 2 through 4 again to program other tracks.
- 5 Press [▶/||] to start playback.

Check program contents	Press [◀◀] or [▶▶] in the stop mode.
Clear the last track	Press [DEL] in the stop mode.
Cancel program mode	Press [PROGRAM] in the stop mode. • "PGM OFF" is shown for a few seconds.
Clear all programmed tracks	Press [■] in the stop mode. "CLEAR ALL" is shown. Within 5 seconds, press [■] again.



- The program memory is cleared when you open the sliding door or remove the USB device.

Listening to FM radio

You can preset up to 30 FM channels. Channel 1 to 5 will be set as the favorite stations under (FAVOURITE) [1] to [5]. (→ right, "Changing the stations stored under (FAVOURITE) [1] to [5]")

Preparation

- Make sure that the antenna is connected. (→ 6)
- Turn the unit on.
- Press [RADIO, EXT-IN] repeatedly to select "FM".

Presetting stations automatically

- 1 Press [RADIO MENU] to select "A.PRESET".
- 2 Press [◀, ▶] to select "LOWEST" or "CURRENT" and then press [OK].

LOWEST:

To begin auto preset with the lowest frequency ("FM 87.9" or "FM 87.5").

CURRENT:

To begin auto preset with the current frequency.*1

- The tuner starts to preset all the stations it can receive into the channels in ascending order.

*1: To change the frequency, refer to "Manual tuning".

Listening to a preset channel

Press the numeric buttons, [1◀◀] or [▶▶5] to select the preset station.

- Alternatively, press [1◀◀/◀◀] or [▶▶/▶▶5] on this unit when "PRESET" is selected as the tune mode*2.
- You can select channel 1 to 5 by pressing one of (FAVOURITE) [1] to [5] on this unit.

Manual tuning

Press [◀◀] or [▶▶] to tune in to the station.

- Alternatively, press [1◀◀/◀◀] or [▶▶/▶▶5] on this unit when "MANUAL" is selected as the tune mode*2.

To tune automatically, press and hold the button until the frequency starts changing quickly.

- *2: To change the tune mode
- 1 Press [RADIO MENU] repeatedly to select "TUNE MODE".
 - 2 Press [◀, ▶] to select "MANUAL" or "PRESET", and then press [OK].

Presetting stations manually

- 1 While listening to the radio broadcast Press [PROGRAM].
- 2 Press the numeric buttons to select a preset number.
 - Do steps 1 through 2 again to preset more stations.



- A station previously stored is overwritten when another station is stored in the same channel preset.

Changing the stations stored under (FAVOURITE) [1] to [5]

You can change the stations stored under (FAVOURITE) [1] to [5] easily.

While listening to the radio broadcast Press and hold one of [1] to [5] until "P □" appears on the display.

("□" stands for a number.)



- When you change the stations stored under (FAVOURITE) [1] to [5], channel 1 to 5 are also changed to the same corresponding stations.

To display the current FM signal status

Press [DISPLAY].

"FM ST": FM stereo broadcast is being received.

"FM - - -": No broadcast is received or FM broadcast received is weak or in monaural.

"FM MONO": You have set the "FM MODE" to "MONO". (→ 14, "If noise is excessive during FM reception.")



- "STEREO" is displayed when this unit tunes to a stereo broadcast.

Sound adjustment

The following sound effects can be added to the audio output.

- 1 Press [SOUND] repeatedly to select the effect.
- 2 Press [◀, ▶] to select the setting and then press [OK].

"MY SOUND" (My sound)	"SOUND 1", "SOUND 2", or "SOUND 3". (→ below, "Saving the sound settings")
"BASS" (Bass) or "TREBLE" (Treble)	Adjust the level (-4 to +4).
"SURROUND" (Surround)	"ON SURROUND" or "OFF SURROUND". • Alternatively, press [SURROUND] on this unit.
"CLEAR-MODE DIALOG" (Clear-mode Dialogue)	"ON CLEAR-MODE DIALOG" or "OFF CLEAR-MODE DIALOG".
"WALL MOUNT" (Wall mount)	"MODE 1 WALL MOUNT", "MODE 2 WALL MOUNT" or "OFF WALL MOUNT". • Alternatively, press [WALL MOUNT] on this unit.

- You may experience a reduction in sound quality when these effects are used with some sources. If this occurs, turn the sound effects off.
- When "AUX" is selected as the source, you can select "INPUT LEVEL" to adjust the sound input level of the external device. (→ 6)

Saving the sound settings

You can save your desired sound settings to "SOUND 1", "SOUND 2" or "SOUND 3" as "MY SOUND".

- 1 Adjust your desired sound effects. (→ above)
- 2 Press [SETUP] to select "SAVE MY SOUND".
- 3 Press [◀, ▶] to select a setting number and then press [OK].
 - "SAVED" is displayed.
 - The sound settings previously saved will be replaced when you save new settings to the same setting number.

Recalling the sound settings you have saved

- 1 Press [SOUND] to select "MY SOUND".
- 2 Press [◀, ▶] to select the desired sound setting number and then press [OK].

D.Bass

Press [D.BASS] to select "ON D.BASS" or "OFF D.BASS".

- Alternatively, press [D.BASS] on the unit.

Preset EQ

Press [PRESET EQ] repeatedly to select "HEAVY" (heavy), "SOFT" (soft), "CLEAR" (clear), "VOCAL" (vocal) or "FLAT" (flat/off).



- When "PRESET EQ" is selected, Bass and Treble settings will be changed to the settings in preset EQ setting.

Clock and Timer

Setting the clock

This is a 12-hour clock.

- 1 Press [CLOCK/TIMER] to select "CLOCK".
- 2 Press [▲, ▼] to set the time and then press [OK].

To check the time

Press [CLOCK/TIMER].



- The clock is reset when there is a power failure or when the AC power supply cord is removed.
- Reset the clock regularly to maintain accuracy.

Sleep timer

The sleep timer can turn the unit off after a set time.

Press [SLEEP] repeatedly to select the setting (in minutes).

"SLEEP 30" → "SLEEP 60" → "SLEEP 90" → "SLEEP 120"
↑ "OFF" (Cancel) ↓



- The remaining time is indicated on the unit's display at every minute except when other operations are performed. "SLEEP 1" is always shown when only 1 minute remains.
- The play timer and sleep timer can be used together. The sleep timer is always the main timer on the unit.

Play timer

You can set the timer so this unit turns on at a certain time every day.

Preparation

Set the clock.

- 1 Press [CLOCK/TIMER] repeatedly to select "TIMER ADJ".
- 2 Press [▲, ▼] to set the starting time ("ON TIME") and then press [OK].
- 3 Press [▲, ▼] to set the finishing time ("OFF TIME") and then press [OK].
- 4 Press [▲, ▼] to select the music source* and then press [OK].

Turning the timer on

- 1 Prepare the selected music source and set the desired volume.
- 2 Press [⊙, PLAY].
 - "⊙" is displayed.
 - To cancel, press [⊙, PLAY] again.
- 3 Press [⏻] to turn the unit to standby mode.

To check the settings

Press [CLOCK/TIMER] repeatedly to select "TIMER ADJ".
(During standby, press [CLOCK/TIMER] twice.)



- The timer starts at a low volume and increases gradually to the preset level.
- The timer comes on at the set time every day if the timer is on.
- If you turn off the unit and turn it on again while a timer is in operation, the timer will not stop at the end time.

* "CD", "USB" and "FM" can be set as the music source.

Others

Auto off function

As a factory default, this unit will turn to standby mode automatically if there is no sound and it is not being used for approximately 20 minutes.

To cancel this function

- 1 Press [SETUP] repeatedly to select "AUTO OFF".
- 2 Press [◀, ▶] to select "OFF" and then press [OK].



- To turn the function on, select "ON" in step 2.
- This setting cannot be selected when radio is the source.
- When connected to a Bluetooth® device, the function does not work.

Bluetooth® standby

When "SC-HC400" is selected from a paired Bluetooth® device's Bluetooth® menu, this unit will turn on automatically from standby mode and establish a Bluetooth® connection.

- 1 Press [SETUP] repeatedly to select "BLUETOOTH STANDBY".
- 2 Press [◀, ▶] to select "ON" and then press [OK].



- To turn the function off, select "OFF" in step 2.
- The factory default is "OFF". If this function is set to "ON", the standby power consumption will increase.

Changing the unit and remote control code

When other Panasonic equipment responds to the supplied remote control, change the remote control code.

- 1 Press [CD/USB] repeatedly to select "CD".
- 2 Press and hold [■] on the unit and [2] on the remote control until the unit's display shows "REMOTE 2".
- 3 Press and hold [OK] and [2] on the remote control for at least 4 seconds.



- To change the mode back to "REMOTE 1", repeat the steps above but replace [2] with [1].

Software update

Occasionally, Panasonic may release updated software for this system that may add or improve the way a feature operates. These updates are available free of charge.

For more details, refer to the following website.

<http://panasonic.jp/support/global/cs/>
(This site is in English only.)

Checking the software version

Press [SETUP] repeatedly to select "SW VER." and then press [OK].

The version of the installed software is displayed.

- Press [OK] to exit.

Troubleshooting

Before requesting service, make the following checks. If you are uncertain about some of the check points, or if the solutions indicated in the following guide does not resolve the issue, then consult your dealer for instructions.

To return all settings to the factory defaults

When the following situations occur, reset the memory:

- There is no response when buttons are pressed.
 - You want to clear and reset the settings.
- ① Disconnect the AC power supply cord. (Wait for at least 30 seconds before proceeding to step ②.)
 - ② While pressing and holding down [⏻/|] on the unit, reconnect the AC power supply cord.
 - Keep holding down [⏻/|] until "-----" appears on the display.
 - ③ Release [⏻/|].



- The settings are returned to the factory defaults. It is necessary to set the settings again.

General

Cannot turn on the unit.

- After connecting the AC power supply cord, wait about 10 seconds before turning on the unit.

Humming heard during playback.

- If an AC power supply cord or fluorescent lights are near the cords, then keep other appliances and cords away from the cables.

The unit does not work.

- One of the unit's safety devices may have been activated.
 - ① Press [⏻/|] on the unit to switch the unit to standby.
 - If the unit does not turn off, disconnect the AC power supply cord from the AC outlet, reconnect it to the outlet after about 30 seconds. Then wait for about 10 seconds.
 - ② Press [⏻/|] on the unit to switch it on. If the unit still cannot be operated, consult the dealer.

Charging does not start during standby mode.

- Turn the unit on. Check the charging has started, and then turn the unit to standby mode. (→ 7)

Noise is heard.

- When a device is connected to both the AUX IN jack and the USB port, noise may be generated depending on the device. In this case, remove the USB cable from the USB port.

Remote control

The remote control does not work properly.

- The battery is depleted or inserted incorrectly. (→ 5)

Disc

Incorrect display or play does not start.

- Make sure that the disc is compatible with this unit. (→ 16)
- There is moisture on the lens. Wait for about an hour and then try again.

USB

No response when [▶/|] is pressed.

- Disconnect the USB device and then reconnect it. Alternatively, turn the unit off and on again.

The USB drive or its contents cannot be read.

- The USB drive format or its contents is/are not compatible with the unit (→ 16).
- The USB host function of this product may not work with some USB devices.

Slow operation of the USB flash drive.

- Large file size or high memory USB flash drive takes longer time to read.

The elapsed time displayed is different from the actual play time.

- Copy the data to another USB device or backup the data and reformat the USB device.

Radio

If noise is excessive during FM reception.

- Change the audio to be output as monaural.
 - ① Press [RADIO MENU] repeatedly to select "FM MODE".
 - ② Press [◀, ▶] to select "MONO" and then press [OK]. The sound becomes monaural.
 - To cancel, select "STEREO" or change the frequency. In normal circumstances, select "STEREO".

Static or noisy reception is heard while listening to a radio broadcast.

- Confirm the antenna is properly connected. (→ 6)
- Adjust the position of the antenna.
- Try to keep a certain amount of distance between the antenna and AC power supply cord.
- Try using an outdoor antenna if there are buildings or mountains nearby.
- Turn the TV or other audio players off or separate it from this unit.
- Keep this unit away from mobile phones if there is interference.

Stations cannot be selected.

- Change the FM frequency step.
 - ① Press [SELECTOR, -] [PAIRING] repeatedly to select "FM".
 - ② Press and hold [■] on the unit.
 - After a few seconds the display changes to show the current lowest frequency. Continue to hold the button down. The lowest frequency changes and the step is changed.

Bluetooth®

Pairing cannot be completed.

- Check the Bluetooth® device condition.

The device cannot be connected.

- The pairing of the device was unsuccessful or the registration has been replaced. Try re-pairing the device. (→ 8)
- This unit might be connected to a different device. Disconnect the other device and try re-pairing the device. (→ 8)
- If "MODE 2" is selected in "LINK MODE", select "MODE 1". (→ 8)
- If the problem persists, turn the unit off and on, then try again.

The device is connected, but audio cannot be heard through this unit.

- For some built-in Bluetooth® devices, you have to set the audio output to "SC-HC400" manually. Read the operating instructions for the device for details.

The sound is interrupted.

- The device is out of the 10 m (33 ft) communication range. Place the Bluetooth® device closer to this unit.
- Remove any interference between this unit and the device.
- Other devices that use the 2.4 GHz frequency band, such as wireless routers, microwaves, cordless phones, etc. are interfering. Place the Bluetooth® device closer to this unit and distance it from the other devices.
- Select "MODE 1" for stable communication. (→ 8)

Messages

The following messages or service numbers may appear on the unit's display.

"--:--"

- You plugged the AC power supply cord in for the first time or there was a power failure recently. Set the time (→ 12).

"ADJUST CLOCK"

- Clock is not set. Adjust the clock accordingly.

"ADJUST TIMER"

- Play timer is not set. Adjust the play timer accordingly.

"AUTO OFF"

- The unit has been left unused for about 20 minutes and will shut down within a minute. Press any button to cancel it.

"ERROR"

- Incorrect operation is performed. Read the instructions and try again.

"F□□" / "F□□□" ("□" stands for a number.)

- There is a problem with this unit.
Disconnect the AC power supply cord from the AC outlet, reconnect it to the outlet after about 30 seconds. Wait for about 10 seconds, then turn on the unit. If the problem still persists, disconnect the AC power supply cord and consult your dealer.

"ILLEGAL OPEN"

- Sliding door is in the wrong position. After turning off the unit, disconnect the AC power supply cord from the AC outlet, reconnect it to the outlet after about 30 seconds. Wait for about 10 seconds, then turn on the unit. If the message is still displayed, disconnect the AC power supply cord and consult your dealer.

"LINKING"

- This system is trying to connect to the last connected Bluetooth® device when "BLUETOOTH" is selected.

"NO DEVICE"

- The USB device is not inserted correctly. Read the instructions and try again (→ 7).

"NO DISC"

- Insert the disc to be played (→ 7).

"NO PLAY"

- Examine the content. You can only play supported format. (→ 17)
- The files in the USB device can be corrupted. Format the USB device and try again.
- The unit may have a problem. Turn the unit off and then on again.

"NOT SUPPORTED"

- You have connected an unsupported USB device.

"PGM FULL"

- The number of programmed tracks is more than 24.

"PLAYERROR"

- You played an unsupported file. The system will skip that track and play the next one.

"READING"

- The unit is checking the "CD"/"USB" information. After this display has disappeared, start operating.

"REMOTE □" ("□" stands for a number.)

- The remote control and this unit are using different codes. Change the code on the remote control.
 - When "REMOTE 1" is displayed, press and hold [OK] and [1] for at least 4 seconds.
 - When "REMOTE 2" is displayed, press and hold [OK] and [2] for at least 4 seconds.

"SOUND □ NOT SET" ("□" stands for a number.)

- There is no saved setting under the selected sound setting number. Save the sound settings. (→ 12)

"USB OVER CURRENT ERROR"

- The USB device is drawing too much power. Select a source other than "USB", remove the USB and turn the unit off.

"VBR"

- The system cannot show the remaining play time for variable bit rate (VBR) tracks.

"WAIT"

- This is displayed, for example, when this unit is turning off.

Unit and media care

Pull out the AC power supply cord from the outlet before maintenance.

■ Clean this unit with a soft, dry cloth

- When dirt is heavy, wring a wet cloth tightly to wipe the dirt, and then wipe it with a dry cloth.
- When cleaning the speaker covers, use a fine cloth. Do not use tissues or other materials that can fall apart. Small pieces may get stuck inside the speaker cover.
- Never use alcohol, paint thinner or benzine to clean this unit.
- Before using chemically treated cloth, carefully read the cloth's instructions.

■ Maintenance of the lens

- Clean the lens regularly to prevent malfunctions. Use a dust blower to remove dust and a cotton swab if it is extremely dirty.
- You cannot use a CD type lens cleaner.
- Do not leave the sliding door open for prolonged periods of time. This will cause the lens to get dirty.
- Be careful not to touch the lens with your fingers.

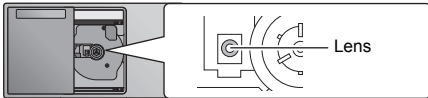

■ Clean discs

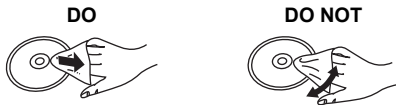

Wipe with a damp cloth and then wipe dry.

■ Disc handling precautions

- Handle discs by the edges to avoid inadvertent scratches or fingerprints on the disc.
- Do not attach labels or stickers to discs.
- Do not use record cleaning sprays, benzine, thinner, static electricity prevention liquids or any other solvent.
- Do not use the following discs:
 - Discs with exposed adhesive from removed stickers or labels (rented discs etc.).
 - Discs that are badly warped or cracked.
 - Irregularly shaped discs, such as heart shapes.

■ To dispose or transfer this unit

The unit may keep the user settings information in the unit. If you discard this unit either by disposal or transfer, then follow the procedure to return all the settings to the factory defaults to delete the user settings.

(→ 14, "To return all settings to the factory defaults")

Playable media

Compatible CD

- A disc with the CD Logo.



- This unit can play back discs that conform to the CD-DA format.
- This system can play back CD-R/RW with CD-DA or MP3 format content.
- The unit may not be able to play some discs due to the condition of the recording.
- Before playback, finalize the disc on the device it was recorded on.
- If the disc includes both MP3 and normal audio data (CD-DA), the unit plays the type recorded in the inner part of the disc.
- This unit cannot play files recorded using packet write.
- Disc must conform to ISO9660 level 1 or 2 (except for extended formats).



- Some CD-R/RW cannot be played because of the condition of the recording.
- MP3 files are defined as tracks and folders are defined as albums.
- This system can access up to:
 - CD-DA: 99 tracks
 - MP3: 999 tracks, 255 albums (including root folder)
- Recordings will not necessarily be played in the order you recorded them.

Compatible USB devices

- This unit does not guarantee connection with all USB devices.
- FAT12, FAT16 and FAT32 file systems are supported.
- This unit supports USB 2.0 Full Speed.
- USB devices with storage capacity of more than 32 GB cannot work in some conditions.
- Supported format: Files with the extension ".mp3" or ".MP3".
- Depending on how you create the files, they may not play in the order you numbered them or may not play at all.



- Files are defined as tracks and folders are defined as albums.
- This system can access up to:
 - 800 albums (including root folder)
 - 8000 tracks
 - 999 tracks in one album

Specifications

■ GENERAL

Power consumption	23 W
Power consumption in standby mode (When "BLUETOOTH STANDBY" is "OFF")*1	Approx. 0.2 W
(When "BLUETOOTH STANDBY" is "ON")*1	Approx. 0.3 W
Power supply	AC 120 V, 60 Hz

Dimensions (W×H×D)

420 mm×225 mm×102 mm
(16 ¹⁷/₃₂"×8 ²⁷/₃₂"×4 ¹/₃₂"

Mass Approx. 2.4 kg (5.3 lbs)

Operating temperature range
0 °C to +40 °C (+32 °F to +104 °F)

Operating humidity range
35% to 80% RH (no condensation)

■ AMPLIFIER SECTION

Output power

RMS Output Power

Front Ch (both ch driven)

20 W per channel (8 Ω), 1 kHz, 10% THD

Total RMS power 40 W

■ TUNER SECTION

Preset Memory FM 30 stations

Frequency Modulation (FM)

Frequency range

87.9 MHz to 107.9 MHz (200 kHz step)

87.5 MHz to 108.0 MHz (100 kHz step)

Antenna terminals 75 Ω (unbalanced)

■ DISC SECTION

Disc played (8 cm (3") or 12 cm (5"))

CD, CD-R/RW (CD-DA, MP3*2)

Pick up

Wavelength 790 nm (CD)

■ SPEAKER SECTION

Speaker unit(s)

Full Range 8 cm (3 ¹/₈") cone type×2

■ TERMINAL SECTION

USB Port

USB Port power DC OUT 5 V 1.5 A

USB Standard USB 2.0 full speed

Media file format support MP3*2 (*.mp3)

Audio support format

MP3*2

Sampling frequency 32/44.1/48 kHz

Audio word size 16 bits

Channel count 2 ch

USB device file system FAT12, FAT16, FAT32

AUX IN Stereo, 3.5 mm (¹/₈") jack

■ Bluetooth® SECTION

Version Bluetooth® Ver.2.1+EDR

Class Class 2

Supported Profiles A2DP, AVRCP

Frequency band 2.4 GHz band FH-SS

Operation Distance 10 m (33 ft) Line of sight

Supported Codec SBC



- Specifications are subject to change without notice.
- Mass and dimensions are approximate.
- Total harmonic distortion is measured by a digital spectrum analyzer.

*1: No device is connected to the USB port before turning to standby mode.

*2: MPEG-1 Layer 3, MPEG-2 Layer 3

Attaching the unit to a wall (optional)

This unit can be wall mounted using the supplied wall mount brackets, safety holder, etc. Make sure that the wall and the screws used for securing to the wall are capable of supporting at least 36 kg (79.4 lbs). The screws and other items are not supplied as the type and size will vary with each installation.

- Refer to step 6 and step 7 of "Wall mount instructions" for details about the required screws.
- As an additional protective measure, attach the unit to the wall with the fall prevention cord.

Installation accessories

Supplied accessories

- 2 Wall mount brackets
- 1 Safety holder
- 1 Wall mounting sheet

Additionally required accessories (commercially available)

- 4 Wall mount bracket fixing screws
- 2 Safety holder fixing screws
- 1 Fall prevention cord*
- 1 Screw eye

* Use a cord that is capable of supporting over 36 kg (79.4 lbs) (with a diameter of about 1.5 mm (1/16")).

- Keep the screws out of reach of children to prevent swallowing.
- Keep the wall mount brackets out of reach of children to prevent swallowing.
- Keep the screw eye out of reach of children to prevent swallowing.

Safety precautions

Professional installation is required.

The installation should never be done by any other than a qualified installation specialist. PANASONIC DISCLAIMS ANY PROPERTY DAMAGE AND/OR SERIOUS INJURY, INCLUDING DEATH RESULTING FROM IMPROPER INSTALLATION OR INCORRECT HANDLING.

WARNING:

To prevent injury, this apparatus must be securely attached to the wall in accordance with the installation instructions.

Wall mount instructions

Before installation, turn the unit off and disconnect the AC power supply cord from the AC outlet.

- 1 Unscrew the fixing screw at the rear of the unit.

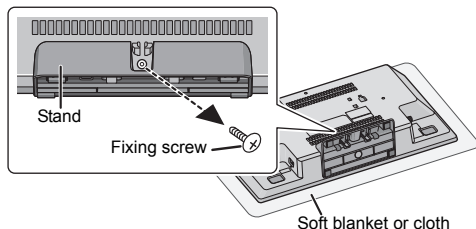

- 2 Detach the stand from the unit while pressing the catches upward.
 - While lifting the catches upwards, gently pull the stand forward.

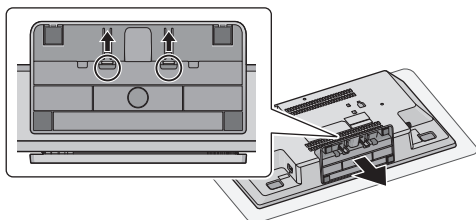

Keep the removed screw and stand for future use.

- When using the unit in a non-wall-mounted position again, be sure to reattach the stand to the unit and secure it with its screw.

- 3 Attach the fall prevention cord (not supplied) to this unit.

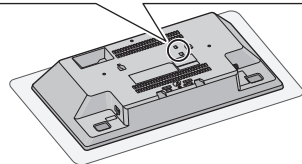
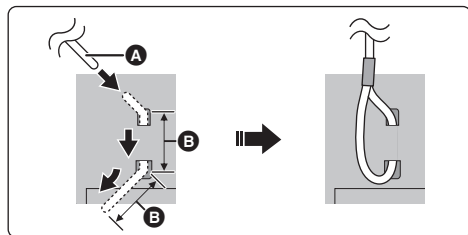

- **A Fall prevention cord (not supplied)**
 - Bend the cord twice from the tip, each at 45° and 5 mm (3/16") apart for it to go through the holes.
- **B 5 mm (3/16")**

4 Put up the wall mounting sheet on the wall where the unit is to be mounted.

- Spread out the wall mounting sheet when taping it to the wall.

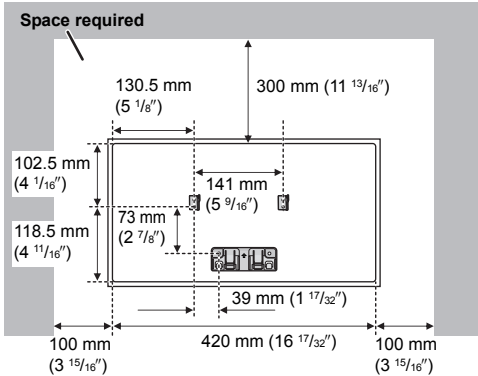
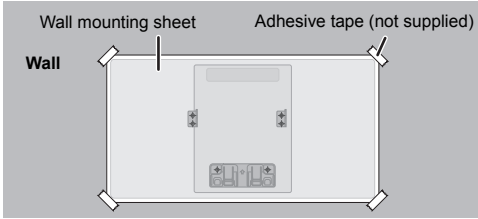

5 Make holes on the wall at the center of each cross mark on the sheet.

- Take the sheet away from the wall after its use.

6 Attach each wall mount bracket to the wall with two screws (not supplied).

- Use a level to ensure both wall mount brackets are level.

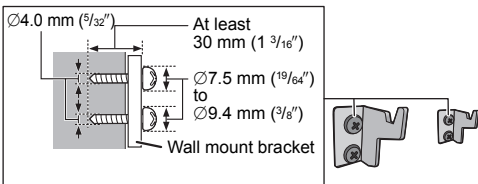

7 Attach the safety holder with two screws (not supplied) to the wall.

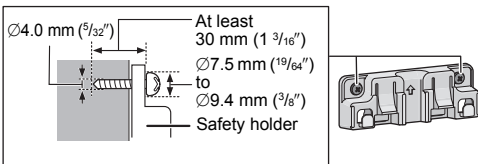

8 Attach the unit.

- 1 Hook the unit securely onto the wall mount brackets with both hands.
- Connect the antenna and the AC power supply cord to the unit before hanging the unit onto the wall. (→ 6)

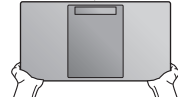
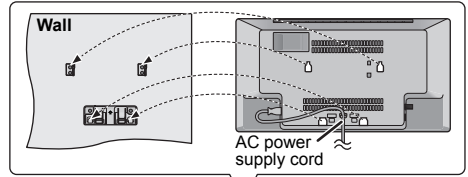

- 2 Slightly uplift the unit vertically until reaching the hook of the safety holder, and push lower so that the unit is hooked and locked in the safety holder.
- The unit will be locked onto the safety holder with a click sound.
- After hanging the unit, release your hands carefully to confirm the unit sits securely on the wall mount brackets and the safety holder.

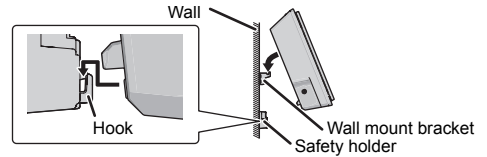

9 Attach the fall prevention cord (not supplied) to the wall.

- Make sure that the slack of the cord is minimal.

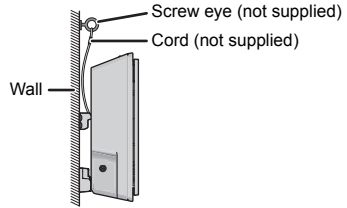

■ To release the unit from the safety holder

While pressing two catches of the safety holder, uplift the unit vertically.

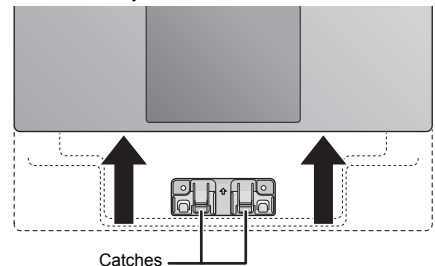

Limited Warranty

Panasonic Canada Inc.

5770 Ambler Drive, Mississauga, Ontario L4W 2T3

PANASONIC PRODUCT - LIMITED WARRANTY

Panasonic Canada Inc. warrants this product to be free from defects in material and workmanship under normal use and for a period as stated below from the date of original purchase agrees to, at its option either (a) repair your product with new or refurbished parts, (b) replace it with a new or a refurbished equivalent value product, or (c) refund your purchase price. The decision to repair, replace or refund will be made by Panasonic Canada Inc.

Panasonic BD/DVD Product - One (1) year, parts and labour

Panasonic Audio Receivers - One (1) year, parts and labour

Home Theater Systems Product - One (1) year, parts and labour

This warranty is given only to the original purchaser, or the person for whom it was purchased as a gift, of a Panasonic brand product mentioned above sold by an authorized Panasonic dealer in Canada and purchased and used in Canada, which product was not sold "as is", and which product was delivered to you in new condition in the original packaging.

IN ORDER TO BE ELIGIBLE TO RECEIVE WARRANTY SERVICE HEREUNDER, A PURCHASE RECEIPT OR OTHER PROOF OF DATE OF ORIGINAL PURCHASE, SHOWING AMOUNT PAID AND PLACE OF PURCHASE IS REQUIRED

LIMITATIONS AND EXCLUSIONS

This warranty **ONLY COVERS** failures due to defects in materials or workmanship, and **DOES NOT COVER** normal wear and tear or cosmetic damage. The warranty **ALSO DOES NOT COVER** damages which occurred in shipment, or failures which are caused by products not supplied by Panasonic Canada Inc., or failures which result from accidents, misuse, abuse, neglect, mishandling, misapplication, alteration, faulty installation, set-up adjustments, misadjustment of consumer controls, improper maintenance, power line surge, lightning damage, modification, introduction of sand, humidity or liquids, commercial use such as hotel, office, restaurant, or other business or rental use of the product, or service by anyone other than an Authorized Servicer, or damage that is attributable to acts of God.

Dry cell batteries are also excluded from coverage under this warranty.

THIS EXPRESS, LIMITED WARRANTY IS IN LIEU OF ALL OTHER WARRANTIES, EXPRESS OR IMPLIED, INCLUDING ANY IMPLIED WARRANTIES OF MERCHANTABILITY AND FITNESS FOR A PARTICULAR PURPOSE. IN NO EVENT WILL PANASONIC CANADA INC. BE LIABLE FOR ANY SPECIAL, INDIRECT OR CONSEQUENTIAL DAMAGES RESULTING FROM THE USE OF THIS PRODUCT OR ARISING OUT OF ANY BREACH OF ANY EXPRESS OR IMPLIED WARRANTY. (As examples, this warranty excludes damages for lost time, travel to and from the Authorized Servicer, loss of or damage to media or images, data or other memory or recorded content. This list of items is not exhaustive, but for illustration only.)

In certain instances, some jurisdictions do not allow the exclusion or limitation of incidental or consequential damages, or the exclusion of implied warranties, so the above limitations and exclusions may not be applicable. This warranty gives you specific legal rights and you may have other rights which vary depending on your province or territory.

WARRANTY SERVICE

For product operation, repairs and information assistance, please visit our Support page: www.panasonic.ca/english/support

IF YOU SHIP THE PRODUCT TO A SERVICENTRE

Carefully pack and send prepaid, adequately insured and preferably in the original carton. Include details of the defect claimed, and proof of date of original purchase.

The model number and serial number of this product can be found on either the back or the bottom of the unit.

Please note them in the space provided below and keep for future reference.

MODEL NUMBER SC-HC400
SERIAL NUMBER _____
NUMBER _____

User memo:

DATE OF PURCHASE	_____
DEALER NAME	_____
DEALER ADDRESS	_____
TELEPHONE NUMBER	_____