

Panasonic®

Owner's Manual Home Theater Audio System

Model No. SC-HTB580



Thank you for purchasing this product.
Please read these instructions carefully before using this product,
and save this manual for future use.

If you have any questions, visit:
U.S.A.: www.panasonic.com/support
Canada: www.panasonic.ca/english/support

Register online at www.panasonic.com/register (U.S. customers only)

Included Installation Instructions

The installation work should be done by a qualified installation specialist. (⇒ p. 13 to 18)
Before commencing work, carefully read these installation instructions and the operating instructions
to ensure that installation is performed correctly.
(Please keep these instructions. You may need them when maintaining or moving this system.)

IMPORTANT SAFETY INSTRUCTIONS

Read these operating instructions carefully before using the unit. Follow the safety instructions on the unit and the applicable safety instructions listed below. Keep these operating instructions handy for future reference.

- 1 Read these instructions.
- 2 Keep these instructions.
- 3 Heed all warnings.
- 4 Follow all instructions.
- 5 Do not use this apparatus near water.
- 6 Clean only with dry cloth.
- 7 Do not block any ventilation openings. Install in accordance with the manufacturer's instructions.
- 8 Do not install near any heat sources such as radiators, heat registers, stoves, or other apparatus (including amplifiers) that produce heat.
- 9 Do not defeat the safety purpose of the polarized or grounding-type plug. A polarized plug has two blades with one wider than the other.

A grounding-type plug has two blades and a third grounding prong. The wide blade or the third prong are provided for your safety. If the provided plug does not fit into your outlet, consult an electrician for replacement of the obsolete outlet.

- 10 Protect the power cord from being walked on or pinched particularly at plugs, convenience receptacles, and the point where they exit from the apparatus.
- 11 Only use attachments/accessories specified by the manufacturer.
- 12 Use only with the cart, stand, tripod, bracket, or table specified by the manufacturer, or sold with the apparatus. When a cart is used, use caution when moving the cart/apparatus combination to avoid injury from tip-over.
- 13 Unplug this apparatus during lightning storms or when unused for long periods of time.
- 14 Refer all servicing to qualified service personnel. Servicing is required when the apparatus has been damaged in any way, such as power-supply cord or plug is damaged, liquid has been spilled or objects have fallen into the apparatus, the apparatus has been exposed to rain or moisture, does not operate normally, or has been dropped.



WARNING

Unit

- To reduce the risk of fire, electric shock or product damage,
 - Do not expose this unit to rain, moisture, dripping or splashing.
 - Do not place objects filled with liquids, such as vases, on this unit.
 - Use only the recommended accessories.
 - Do not remove covers.
 - Do not repair this unit by yourself. Refer servicing to qualified service personnel.
- To prevent injury, this apparatus must be securely attached to the wall in accordance with the installation instructions.

AC power supply cord

- The power plug is the disconnecting device. Install this unit so that the power plug can be unplugged from the socket outlet immediately.

Button-type battery (Lithium battery)

- Risk of fire, explosion and burns. Do not disassemble, heat above 60 °C (140 °F) or incinerate.

Small object

- Keep the screws out of reach of children to prevent swallowing.
- Keep the adhesive tape out of reach of children to prevent swallowing.
- Keep the button-type battery out of reach of children to prevent swallowing.



DO NOT INGEST BATTERY, CHEMICAL BURN HAZARD

This product contains a coin/button cell battery. If the coin/button cell battery is swallowed, it can cause severe internal burns in just 2 hours and can lead to death. Keep new and used batteries away from children. If the battery compartment does not close securely, stop using the product and keep it away from children. If you think batteries might have been swallowed or placed inside any part of the body, seek immediate medical attention.

If any electrolyte should come into contact with your hands or clothes, wash it off thoroughly with water. If any electrolyte should come into contact with your eyes, never rub the eyes. Rinse eyes thoroughly with water, and then consult a doctor.

<For USA-California only>

This product contains a CR Coin Cell Lithium Battery which contains Perchlorate Material — special handling may apply. See www.dtsc.ca.gov/hazardouswaste/perchlorate.

CAUTION

Unit

- Do not place sources of naked flames, such as lighted candles, on this unit.
- Product Identification Marking is located on the bottom of the unit.

Placement

- To reduce the risk of fire, electric shock or product damage,
 - Do not install or place this unit in a bookcase, built-in cabinet or in another confined space. Ensure this unit is well ventilated.
 - Do not obstruct this unit's ventilation openings with newspapers, tablecloths, curtains, and similar items.

Button-type battery (Lithium battery)

- Danger of explosion if battery is incorrectly replaced. Replace only with the type recommended by the manufacturer.
- Keep out of reach of children.
- Insert with poles aligned.
- Mishandling of batteries can cause electrolyte leakage and may cause a fire.
 - Remove the battery if you do not intend to use the remote control for a long period of time. Store in a cool, dark place.
 - Do not heat or expose to flame.
 - Do not leave the battery(ies) in a car exposed to direct sunlight for a long period of time with doors and windows closed.
 - Do not touch the terminals (+ and -) with metal objects.
 - Do not recharge, disassemble, remodel, heat or throw into fire.
- When disposing of the batteries, please contact your local authorities or dealer and ask for the correct method of disposal.

The following mark and symbols are located on bottom of the unit.

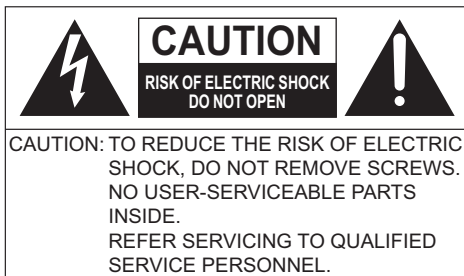

The lightning flash with arrowhead symbol, within an equilateral triangle, is intended to alert the user to the presence of uninsulated "dangerous voltage" within the product's enclosure that may be of sufficient magnitude to constitute a risk of electric shock to persons.



The exclamation point within an equilateral triangle is intended to alert the user to the presence of important operating and maintenance (servicing) instructions in the literature accompanying the appliance.

THE FOLLOWING APPLIES ONLY IN THE U.S.A.

FCC Note:

This equipment has been tested and found to comply with the limits for a Class B digital device, pursuant to Part 15 of the FCC Rules.

These limits are designed to provide reasonable protection against harmful interference in a residential installation. This equipment generates, uses and can radiate radio frequency energy and, if not installed and used in accordance with the instructions, may cause harmful interference to radio communications.

However, there is no guarantee that interference will not occur in a particular installation. If this equipment does cause harmful interference to radio or television reception, which can be determined by turning the equipment off and on, the user is encouraged to try to correct the interference by one or more of the following measures:

- Reorient or relocate the receiving antenna.
- Increase the separation between the equipment and receiver.
- Connect the equipment into an outlet on a circuit different from that to which the receiver is connected.
- Consult the dealer or an experienced radio/TV technician for help.

Any unauthorized changes or modifications to this equipment would void the user's authority to operate this device.

This device complies with Part 15 of the FCC Rules.

Operation is subject to the following two conditions:

- (1) This device may not cause harmful interference, and
- (2) this device must accept any interference received, including interference that may cause undesired operation.

Responsible Party:

Panasonic Corporation of North America

Two Riverfront Plaza, Newark, NJ 07102-5490

Support Contact: <http://www.panasonic.com/contactinfo>

THE FOLLOWING APPLIES ONLY IN CANADA.

This device complies with RSS-210 of the IC Rules.

Operation is subject to the following two conditions:

- (1) This device may not cause harmful interference,
- (2) This device must accept any interference received, including interference that may cause undesired operation of the device.

CAN ICES-3(B)/NMB-3(B)

THE FOLLOWING APPLIES IN THE U.S.A. AND CANADA

This transmitter must not be co-located or operated in conjunction with any other antenna or transmitter.

This equipment complies with FCC/IC radiation exposure limits set forth for an uncontrolled environment and meets the FCC radio frequency (RF) Exposure Guidelines in Supplement C to OET65 and RSS-102 of the IC radio frequency (RF) Exposure rules. This equipment has very low levels of RF energy that is deemed to comply without maximum permissive exposure evaluation (MPE). But it is desirable that it should be installed and operated keeping the radiator at least 20 cm ($7\frac{7}{8}$ ") or more away from person's body (excluding extremities: hands, wrists, feet and ankles).

Conforms to UL STD 60065.

Certified to CAN/CSA STD C22.2 No.60065.

Table of contents

IMPORTANT SAFETY INSTRUCTIONS	2
-------------------------------------	---

Before use

Supplied items	5
This system (SC-HTB580)	5
Accessories	5
Control reference guide	6
This system (Front)	6
This system (Rear)	7
Remote control	8

Getting started

Step 1 Connections	9
Connection with the TV	9
Connection from an HDMI compatible device	10
Connection to a 4K Ultra HD TV	11
Using the IR Blaster	11
AC power supply cord connection	12
Step 2 Placement	13
Safety Precautions	13
The active subwoofer	13
Wireless interference	13
Selecting the placement method	14
When placing the main unit on a rack or on a table	15
When attaching the main unit to a wall	16
Step 3 Wireless connections	19
Active subwoofer wireless connection	19
Bluetooth® connection	19
Remote control code	20

Operations

Using this system	21
3D sound	22
Sound menu	22
Audio format	23
Setup menu	24
Linked operations with the TV (VIERA Link™ “HDAVI Control™”)	25

Reference

Troubleshooting	26
About Bluetooth®	29
Unit care	29
Licenses	29
Specifications	30
Limited Warranty (ONLY FOR U.S.A.)	32
Limited Warranty (ONLY FOR CANADA)	33

- The illustrations shown may differ from your unit.
- Instructions in this Owner's Manual are described mainly with the remote control, but you can perform the operations on the main unit if the controls are the same.



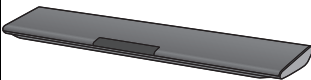
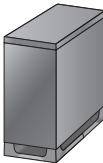

Supplied items

This system (SC-HTB580)

<input type="checkbox"/> 1 Main unit (speaker) (SU-HTB580) 	<input type="checkbox"/> 1 Active subwoofer (SB-HWA580) 
--	--

Accessories

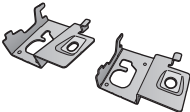
Check the supplied accessories before using this system.

<input type="checkbox"/> 1 Remote control (with a battery) (N2QAYC000098) 	<input type="checkbox"/> 1 IR Blaster (K2ZZ02C00007) 	<input type="checkbox"/> 2 Wall mount brackets (RMQ2281A, RMQ2281B) 
<input type="checkbox"/> 2 AC power supply cords (K2CB2CB00022) 	<input type="checkbox"/> 2 Screws (XYN5+J14FJK) 	

(ONLY FOR CANADA)

The enclosed Canadian French label sheet corresponds to the English display on the remote control and the side and rear of the main unit and active subwoofer.



- Product numbers are correct as of December 2013. These may be subject to change.
- For U.S.A.:
To order accessories, refer to "Accessory Purchases (United States)" on page 32.
For Canada: To order accessories, call the dealer from whom you have made your purchase.
- The supplied AC power supply cord is for use with this system only.
Do not use it with other equipment. Also, do not use cords from other equipment with this system.

Control reference guide

This system (Front)

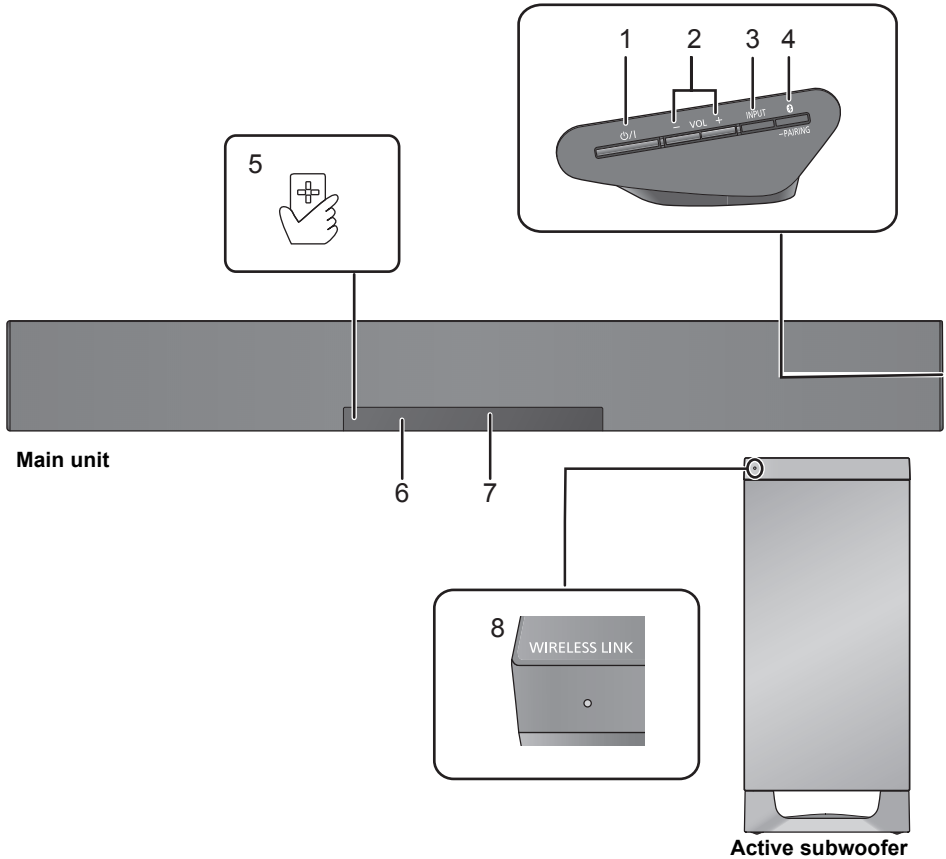

- 1 Standby/on switch (ON/OFF)**
Press to switch the unit from on to standby mode or vice versa. In standby mode, the unit is still consuming a small amount of power.
- 2 Adjust the volume on this system (⇒ p. 21)**
- 3 Select the input source (⇒ p. 21)**
“TV” → “BD/DVD” → “BLUETOOTH”
↑
- 4 Select the Bluetooth® device as the source (⇒ p. 21)**
- 5 NFC touch area (⇒ p. 20)**
- 6 Remote control signal sensor (⇒ p. 8)**
- 7 Display**
- 8 WIRELESS LINK indicator (⇒ p. 19)**

This system (Rear)

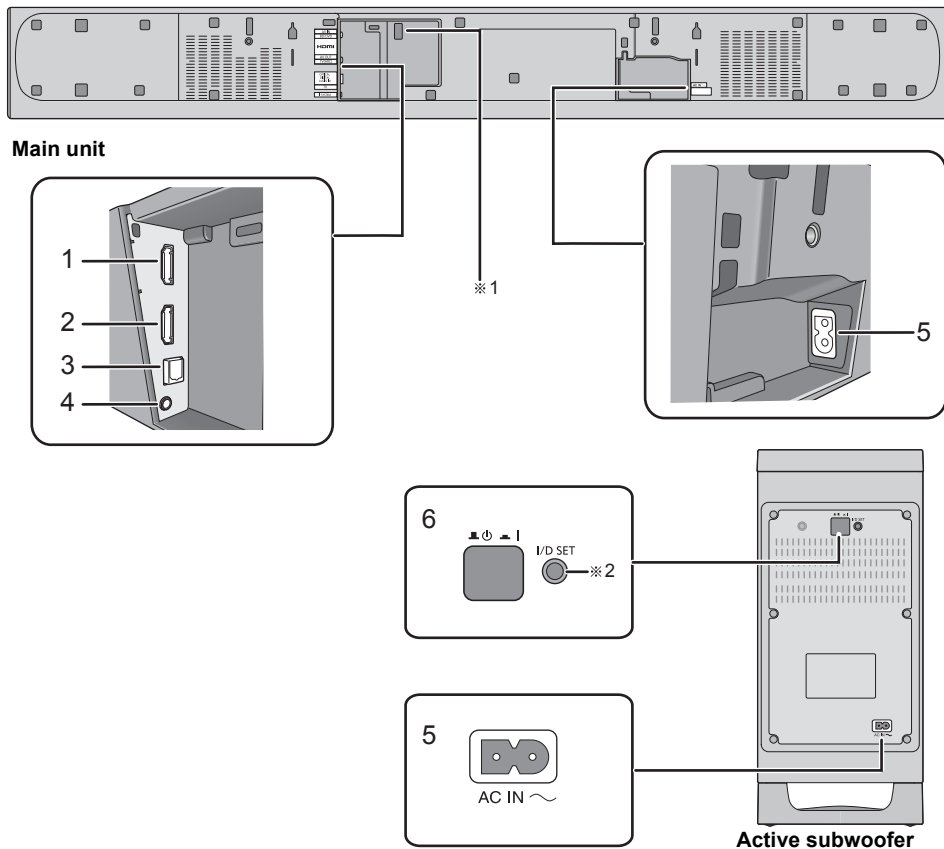

- 1 HDMI AV IN (BD/DVD) terminal (⇒ p. 10)
- 2 HDMI AV OUT (TV (ARC)) terminal (ARC compatible) (⇒ p. 9, 10)
- 3 OPTICAL DIGITAL AUDIO IN (TV) terminal (⇒ p. 10)

- 4 Ir SYSTEM terminal (⇒ p. 11, 12)
- 5 AC IN terminal (⇒ p. 12)
- 6 Active subwoofer on/off button (⇒ p. 19)

※ 1 For service use only

※ 2 The I/D SET button is only used when the main unit is not paired with the active subwoofer. (⇒ p. 28)

Remote control

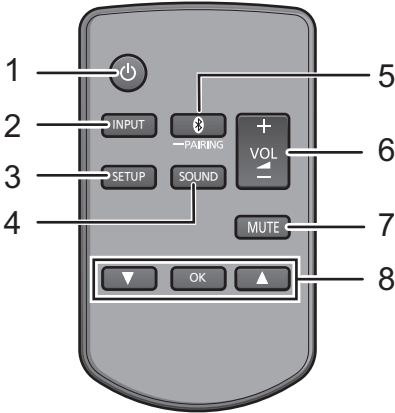

- 1 Turn the main unit on or off (⇒ p. 21)
- 2 Select the input source (⇒ p. 21)
 “TV” → “BD/DVD” → “BLUETOOTH”
- 3 Select the setup menu (⇒ p. 24)
- 4 Select the sound menu (⇒ p. 22)
- 5 Select the Bluetooth® device as the source (⇒ p. 21)
- 6 Adjust the volume on this system (⇒ p. 21)
- 7 Mute (⇒ p. 21)
- 8 Select and confirm the option

■ About remote control signal sensor

The remote control signal sensor is located on the main unit.

- Use the remote control within the correct operation range.
 Distance: Within approx. 7 m (23 ft) directly in front
 Angle: Approx. 30° left and right

For table top layout

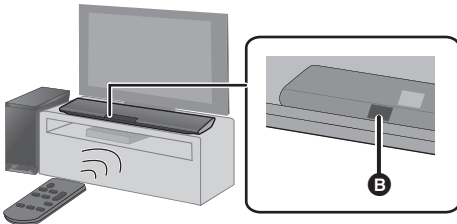

For wall mounting layout

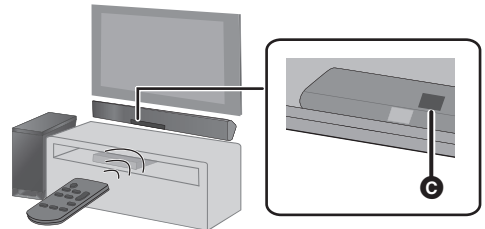

- B** Remote control signal sensor for table top layout
- C** Remote control signal sensor for wall mounting layout

■ Before using for the first time

Remove the insulation sheet **A**.

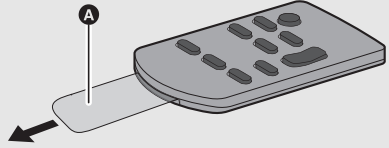

■ To replace a button-type battery

Battery type: CR2025 3V (Lithium battery)

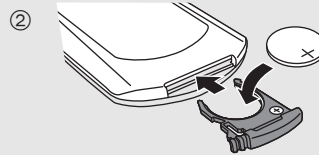
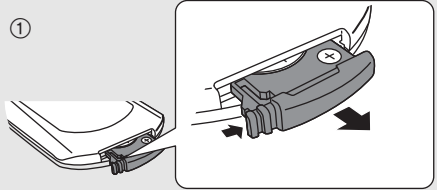

- Set the button-type battery with its (+) mark facing upward.

Step 1 Connections

- Turn off all equipment before connection and read the appropriate operating instructions.
- **Do not connect the AC power supply cord until all other connections are completed.**

■ HDMI (High-Definition Multimedia Interface)

- The HDMI connection supports VIERA Link "HDAVI Control" (⇒ p. 25) when used with a compatible Panasonic TV.
- Use ARC compatible High Speed HDMI Cables. Non-HDMI-compliant cables cannot be utilized.
- It is recommended that you use Panasonic's HDMI cable.

■ IR (Infrared) Blaster

- Do not use the IR Blaster if the TV's remote control sensor is not blocked by the main unit. (⇒ p. 14)

Connection with the TV

1 Verify if the TV's HDMI terminal is labeled "HDMI (ARC)".

Connection differs depending on the label printed next to the HDMI terminal.

Labeled "HDMI (ARC)": Connection A

Not labeled "HDMI (ARC)": Connection B

■ What is ARC?

ARC is an abbreviation of Audio Return Channel, also known as HDMI ARC. It refers to one of the HDMI functions. When the main unit is connected to the terminal labeled "HDMI (ARC)" on the TV, the optical digital audio cable that is usually required in order to listen to sound from a TV is no longer required. Video, pictures and sound can be enjoyed with a single HDMI cable.

2 Make the connection.

A Labeled "HDMI (ARC)"

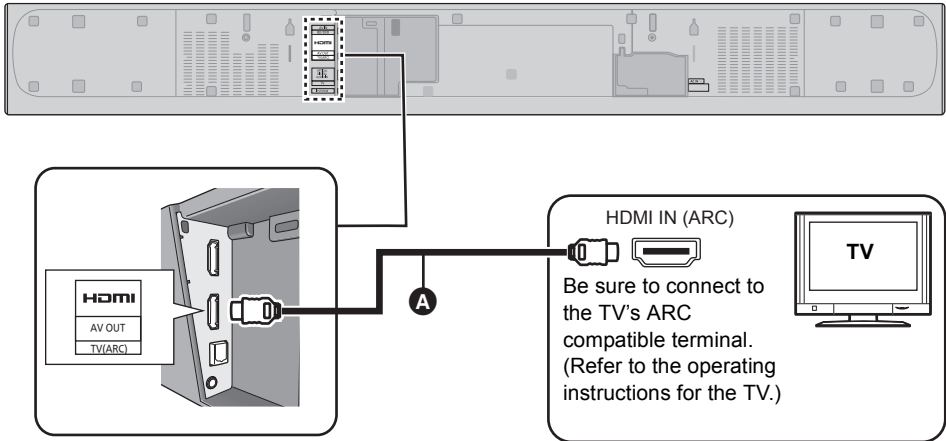

A HDMI cable

B Not labeled “HDMI (ARC)”

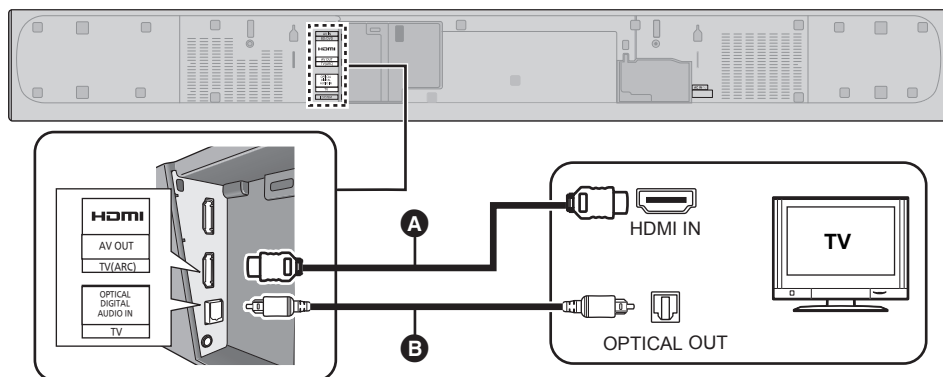

A HDMI cable

B Optical digital audio cable

- When the optical digital audio cable is connected, insert the tip correctly into the terminal.

Connection from an HDMI compatible device

The audio signal can be directed from the connected Blu-ray Disc player, DVD player, Set top box, etc. to this system.

Preparation

- Connect the main unit to the TV. (⇒ p. 9)

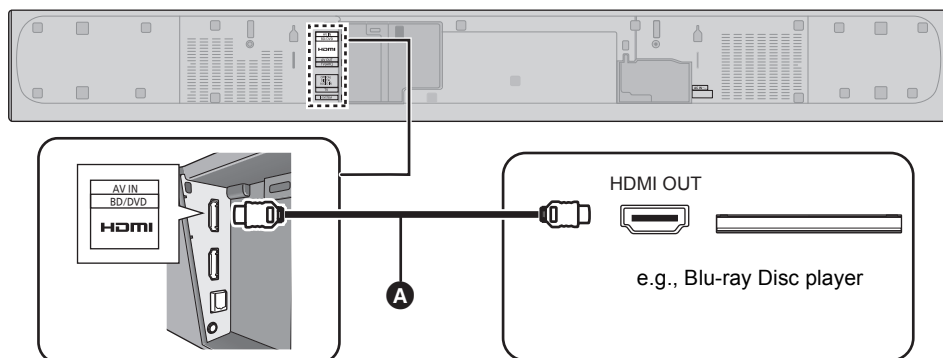

A HDMI cable

HDMI standby pass-through

Even if the main unit is in standby mode, the audio and/or video signal from the device connected to the HDMI AV IN terminal will be sent to the TV connected to the HDMI AV OUT terminal (the sound will not be output from this system).

3D compatibility

Compatible with FULL HD 3D TV and Blu-ray Disc player.

- The main unit can pass-through the 3D video signal from a 3D compatible Blu-ray Disc player to a FULL HD 3D TV.



- Refer to the operating instructions of the connected HDMI compatible device for the settings required to output the video and audio signals.

Connection to a 4K Ultra HD TV

This system cannot pass-through the 4K content of a 4K compatible equipment to a 4K Ultra HD TV. However, you can connect the system to a 4K Ultra HD TV to enjoy the 4K content.

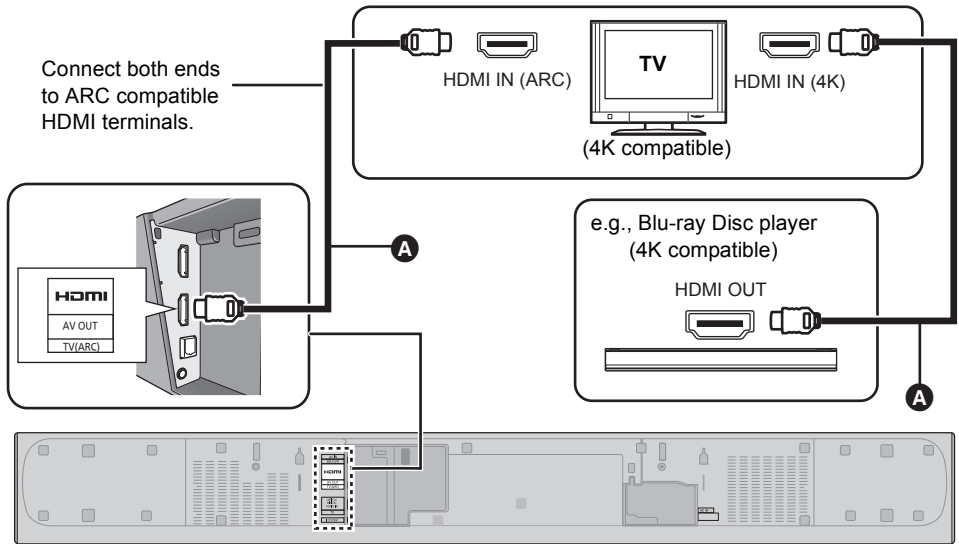

A HDMI cable



- Refer to the operating instructions of the 4K Ultra HD TV (VIERA) and the 4K/60p compatible equipment for setup and for playing the 4K content.
- To enjoy multi-channel output from this system, set the audio output of other equipment to Bitstream.
- The audio signal input to this system is up to 5.1 channels.

Using the IR Blaster

With the IR Blaster connection, it is possible to send the IR signal received by this system's remote control signal sensor to the TV's sensor.

Use the TV's remote control within the operation range of this system's remote control signal sensor.

- For the operation range, refer to page 8.

1 Connect the jack plug to the main unit's Ir SYSTEM terminal.

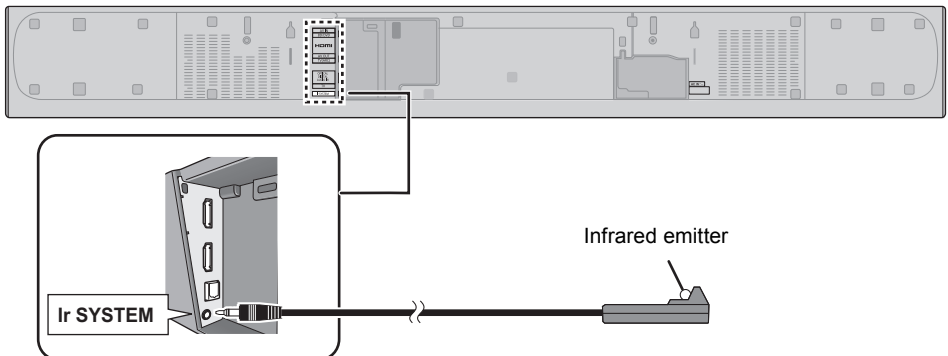

2 Place the infrared emitter in sight of the TV's remote control signal sensor.

- For the location of the TV's remote control signal sensor, refer to the operating instructions for the TV.

3 Aim the TV's remote control at this system's remote control sensor and operate the TV.

- For the location of this system's remote control signal sensor, refer to page 8.
- Make sure to clean the surface, where the adhesive tape is to be attached.
- If you peel off the adhesive tape, the surface may become damaged and exposed adhesive may remain. Once you have confirmed the TV is operating correctly, secure it by attaching the adhesive tape.



- The supplied IR Blaster is only compatible with Panasonic TVs.

■ Placement example

On the rear of the main unit:

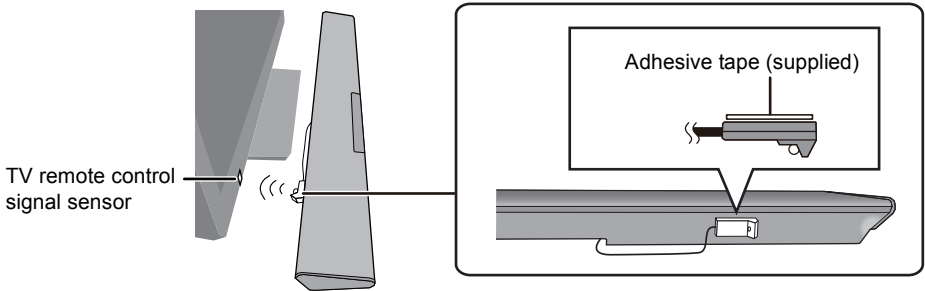

AC power supply cord connection

- Connect only after all other connections are completed.

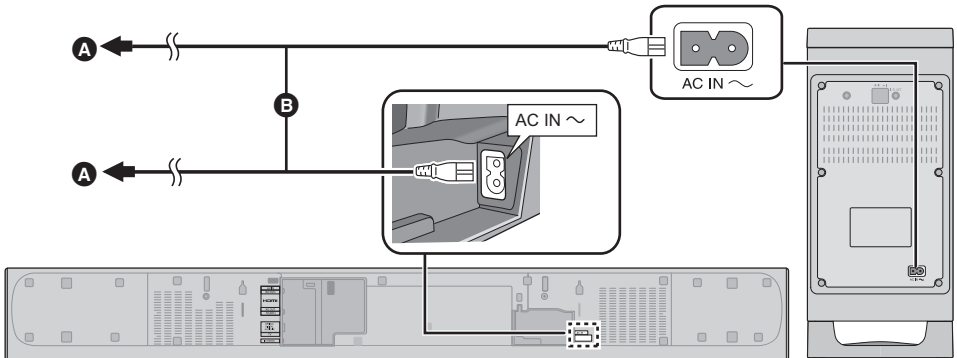

A To an AC outlet

B AC power supply cord (supplied)

- This system consumes a small amount of AC power (⇒ p. 30) even when it is turned off. In the interest of power conservation, if you will not be using this system for a long time, unplug it from the AC outlet.

Step 2 Placement

Safety Precautions

Professional installation is required.

The installation should never be done by any other than a qualified installation specialist. PANASONIC DISCLAIMS ANY PROPERTY DAMAGE AND/OR SERIOUS INJURY, INCLUDING DEATH RESULTING FROM IMPROPER INSTALLATION OR INCORRECT HANDLING.

- Be sure to install the main unit as indicated within this Owner's Manual.
- Attach using techniques suited to the structure and materials of the installation location.



Caution

- This system is to be used only as indicated in these instructions. Failure to do so may lead to damage to the amplifier and/or the speaker, and may result in the risk of fire. Consult a qualified service person if damage has occurred or if you experience a sudden change in performance.
- Do not attempt to attach the main unit to a wall using methods other than those described in this manual.



- Do not hold the main unit in one hand to avoid injury, you may drop the main unit when carrying it.
- To prevent damage or scratches, lay down a soft cloth and perform the assembly on it.

The active subwoofer

When carrying the active subwoofer

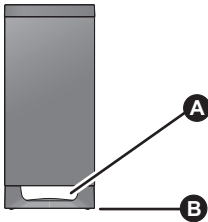

- A** Do not hold the active subwoofer from this opening. The parts inside may get damaged.
- B** Always hold the bottom of the active subwoofer when moving it.

Wireless interference

To avoid interference, maintain the following distances between the main unit/active subwoofer and other electronic devices that use the same radio frequency (2.4 GHz band).

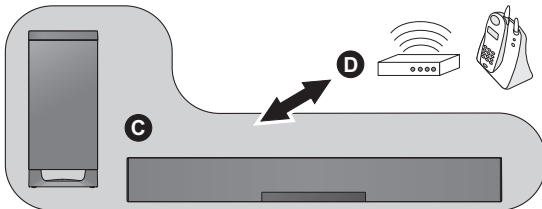

- C** Main unit/active subwoofer
- D** Wireless router, cordless phone and other electronic devices: approx. 2 m (6 1/2 ft)

Selecting the placement method

Choose a placement method that suits you best.

When placing the main unit on a rack or on a table

- Place the main unit on a flat and horizontal surface.



Page 15

When attaching the main unit to a wall

- Place the main unit on a flat and vertical surface.



Page 16

■ When placing the main unit in front of the TV

The main unit may block or interfere with the TV's various sensors (C.A.T.S. (Contrast Automatic Tracking System) sensor, remote control sensor, etc.) and the 3D Eyewear transmitters on a 3D compatible TV.

- If interference occurs, move the main unit further away from the TV. If the TV still does not function correctly, try using it in a rack or in the wall mount position.

■ If the TV's remote control sensor is blocked by the main unit

Try using the TV's remote control from a different angle. If the problem persists, use the supplied IR Blaster to relay the signal to the TV. (⇒ p. 11, 12)



- Place the active subwoofer within a few meters of the main unit and in a horizontal position with the top panel facing upward.
- Do not use the main unit or the active subwoofer in a metal cabinet.
- Placing the active subwoofer too close to the walls and corners can result in excessive bass. Cover walls and windows with thick curtains.
- If irregular coloring occurs on your TV, turn the TV off for about 30 minutes. If it persists, move the main unit and active subwoofer further away from the TV.
- Keep magnetized items away. Magnetized cards, watches, etc., can be damaged if placed too close to the main unit and active subwoofer.

When placing the main unit on a rack or on a table

Additionally required accessories (commercially available)

- Fall prevention cord × 2
- Screw eyes (to attach the fall prevention cord) × 2



- Use commercially available screws that are capable of supporting over 26 kg (57.3 lbs).
- Use a cord that is capable of supporting over 26 kg (57.3 lbs) (with a diameter of about 1.5 mm (1/16")).

1 Attach the cord to the main unit.

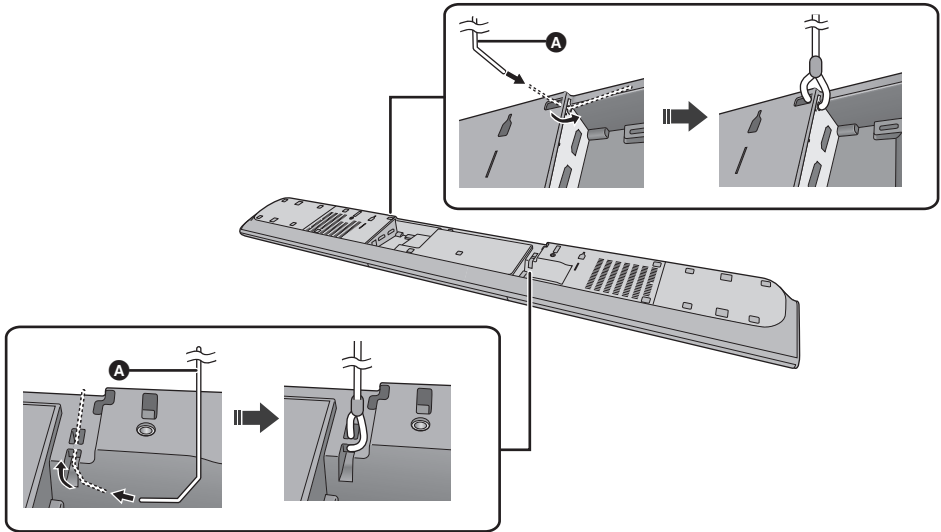

A Cord*

- ※ If the cord cannot be threaded through the holes, try bending the cord in 2 locations, about 5 mm (3/16") apart from the tip, at an angle of 45° (as illustrated above).

2 Place the main unit in the desired position and attach each cord onto the rack or table.

- Make sure that the slack of the cord is minimal.
- Do not lean the main unit against the TV or wall.

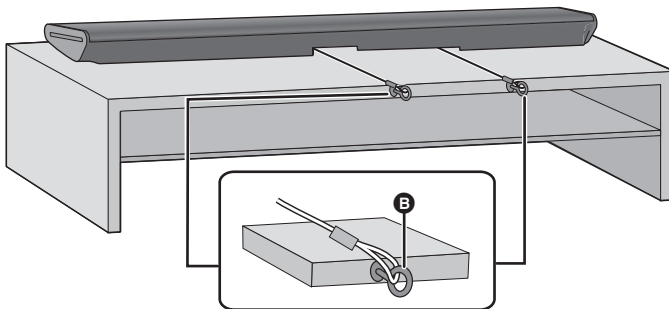

B Screw eye

- Attach at a position capable of supporting over 26 kg (57.3 lbs).
- Depending on the placement of the main unit, the screwing position of the screw eye may differ.

When attaching the main unit to a wall

The main unit can be wall mounted using the supplied wall mount brackets, etc. Make sure that the screw used and the wall are strong enough to support the weight of at least 26 kg (57.3 lbs).

The screws and other items are not supplied as the type and size will vary with each installation.

- Refer to step 3 for details about the required screws.
- Be sure to attach the fall prevention cord as a secondary safety measure.

Supplied accessories

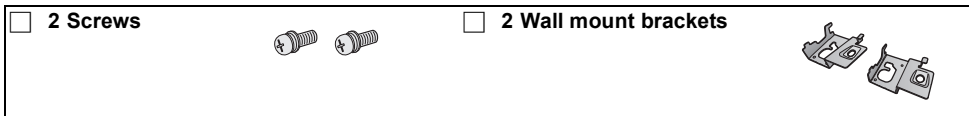

Additionally required accessories (commercially available)

- | | |
|--|-----|
| • Screws for wall mounting..... | × 2 |
| • Fall prevention cord | × 2 |
| • Screw eyes (to attach the fall prevention cord)..... | × 2 |



- Use a cord that is capable of supporting over 26 kg (57.3 lbs) (with a diameter of about 1.5 mm (1/16")).

1 Attach the cord to the main unit.

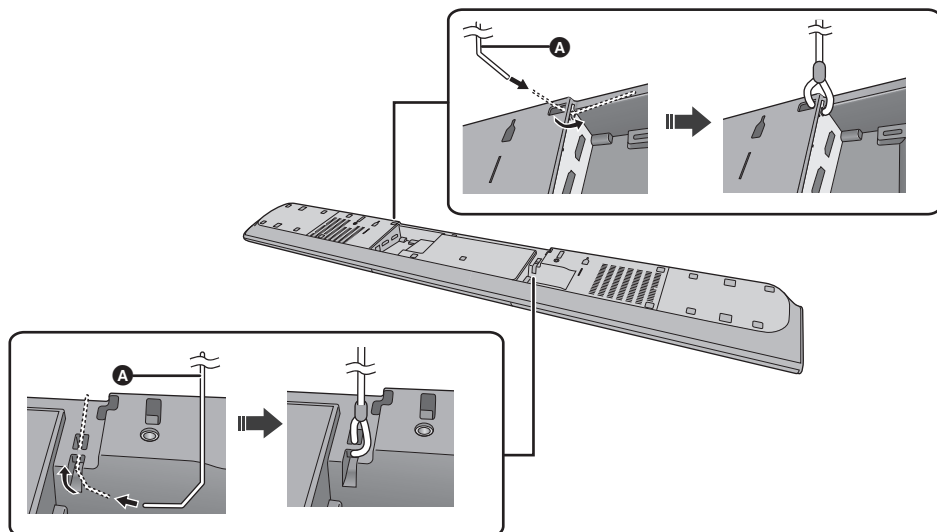

A Cord*

- ※ If the cord cannot be threaded through the holes, try bending the cord in 2 locations, about 5 mm (3/16") apart from the tip, at an angle of 45° (as illustrated above).

2 Attach the wall mount brackets to the main unit.

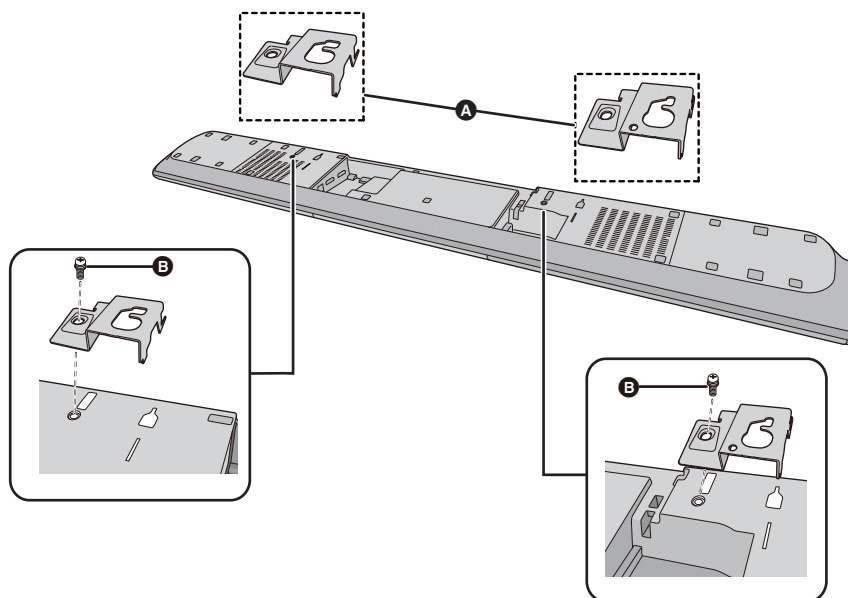

- A** Wall mount bracket (supplied)
- B** Screw (supplied)

3 Drive a screw into the wall.

- Use the measurements indicated below to identify the screwing positions on the wall.
- Leave at least 100 mm (3 15/16") of space above of the main unit to allow enough space for fitting the main unit.
- Position the main unit with at least 50 mm (2") of free space to its right. If not, it may not be possible to access the buttons.
- Be sure to use a level to insure that both mounting holes are level to each other.

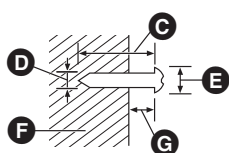

- C** At least 30 mm (1 3/16")
- D** $\varnothing 4.0$ mm (5/32")
- E** $\varnothing 7.0$ mm to $\varnothing 9.4$ mm (9/32" to 3/8")
- F** Wall or pillar
- G** 1.6 mm to 2.5 mm (1/16" to 3/32")



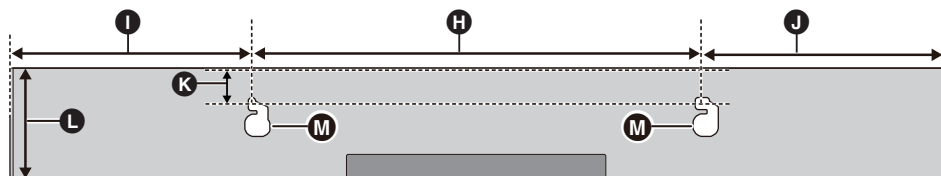

Front view (semi-transparent image)

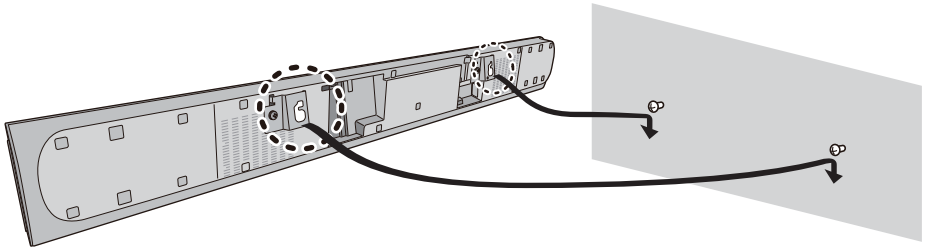

- H** 400 mm (15 3/4")
- I** 275 mm (10 13/16")
- J** 275 mm (10 13/16")
- K** 27 mm (1 1/16")
- L** 110 mm (4 11/32")
- M** Wall mounting hole

4 Fit the main unit securely onto the screw(s).



DO		DO NOT	
			
<ul style="list-style-type: none">• Move the speaker so that the screw is in this position.		<ul style="list-style-type: none">• In this position, the speaker will likely fall if moved to the left or right.	

5 Secure the cord to the wall.

- Make sure that the slack of the cord is minimal.

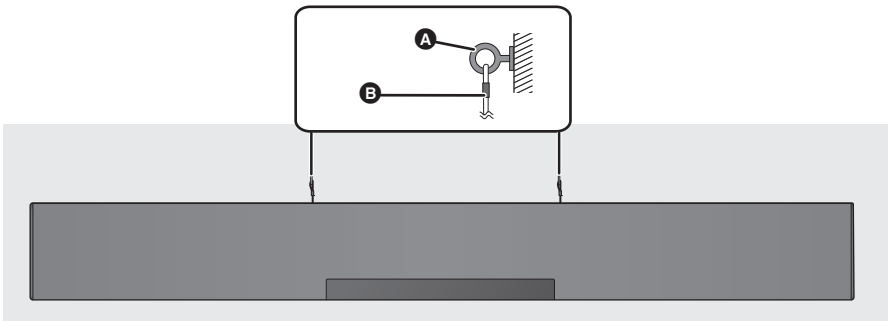

- A** Screw eye
- B** Cord

Step 3 Wireless connections

Active subwoofer wireless connection

Preparation

- Turn on the main unit.

1 Press [].

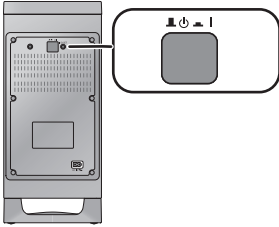

Active subwoofer on/off button []



Use this button to turn the active subwoofer on and off.

■  :

The active subwoofer is on.

■  :

The active subwoofer is off.

The active subwoofer will still consume a small amount of power even when it is turned off ( , ).

2 Check that the wireless link is activated.

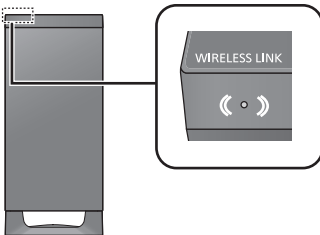

WIRELESS LINK indicator

Lights red:

The wireless link is not activated.

Lights green:

The wireless link is activated.

Blinks green:

The active subwoofer is trying to activate the wireless link with the main unit.



The wireless link will be activated when the main unit and the active subwoofer are both turned on.

Bluetooth® connection

By using the Bluetooth® connection, you can listen to the sound from the Bluetooth® audio device from this system wirelessly.

- Refer to the operating instructions of the Bluetooth® device for further instruction on how to connect a Bluetooth® device.

Preparation

- Turn on the Bluetooth® feature of the device and place the device near the main unit.

Bluetooth® pairing

1 Press [] to select “BLUETOOTH”.

- If “PAIRING” is indicated on the display, go to step 3.

2 Press and hold [] until “PAIRING” is indicated on the display.

3 Select “SC-HTB580” from the Bluetooth® device’s Bluetooth® menu.

- If prompted for the passkey on the Bluetooth® device, enter “0000”.
- Once the Bluetooth® device is connected, the name of the connected device will be indicated on the display for a few seconds.



- You can register up to 8 devices with this system. If a 9th device is paired, the device that has not been used the longest will be replaced.

Connecting a paired Bluetooth® device

1 Press [] to enter Bluetooth® mode.

“BLUETOOTH READY” is indicated on the display.

2 Select “SC-HTB580” from the Bluetooth® device’s Bluetooth® menu.

■ Disconnecting a Bluetooth® device

Press and hold [] until the “BLUETOOTH READY” is indicated on the display.



- When “BLUETOOTH” is selected as the source, this system will automatically try and connect to the last connected Bluetooth® device.
- The Bluetooth® device will be disconnected if a different audio source (e.g. “TV”) is selected.
- This system can only be connected to one device at a time.
- To change the sound quality, refer to page 24 “LINK MODE”.

One-Touch Connection (Connecting by NFC)

For NFC-compatible Bluetooth® devices (Android™ devices) only

Simply by touching an NFC (Near Field Communication)-compatible Bluetooth® device on the main unit, you can complete all preparations, from registering a Bluetooth® device to establishing a connection.

Preparation

- Turn on the NFC feature of the device.
- An Android device lower than version 4.1 requires the installation of the App “Panasonic Music Streaming” (free of charge).
 - 1 Enter “Panasonic Music Streaming” in the search box of Google Play™ to search, and then select “Panasonic Music Streaming”.
 - 2 Start the App “Panasonic Music Streaming” on the device.
 - Follow on-screen instructions on your device.
 - Always use the latest version of the App.

1 Press [] to select “BLUETOOTH”.

2 Touch and hold your device on the NFC touch area of the main unit [].
(⇒ p. 6)

Do not move the Bluetooth® device until it beeps, displays a message or reacts in some way. Once the Bluetooth® device has reacted, move the device away from the main unit.

- When the registration and connection of the Bluetooth® device is complete, the name of the connected device is indicated on the display for a few seconds.
- The location of the NFC touch area differs depending on the device. When a connection cannot be established even if your Bluetooth® device has touched the NFC touch area of the main unit, change the position of the device. The condition may also improve if you download the dedicated App “Panasonic Music Streaming” and start it up.

3 Start playback on the Bluetooth® device.



- If you touch another device to the main unit, you can update the Bluetooth® connection. The previously connected device will be disconnected automatically.
- When the connection is established, playback may start automatically depending on the type of device being used.
- The One-Touch Connection may not work properly depending on the type of device being used.

Remote control code

When other Panasonic devices respond to this system's remote control, change the remote control code on this system and the remote control.

Preparation

- Turn off all other Panasonic products.
- Turn on the main unit.

■ To set the code to “REMOTE 2”
Press and hold [MUTE] and [OK] for more than 4 sec.

“REMOTE 2” is indicated on the display.

■ To set the code to “REMOTE 1”
Press and hold [MUTE] and [▼] for more than 4 sec.

“REMOTE 1” is indicated on the display.

Using this system

Preparation

- Turn on the active subwoofer.
- Turn on the TV and/or connected device.

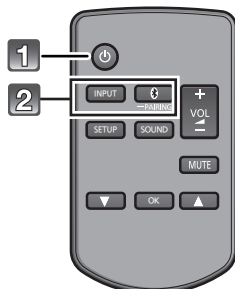

■ To adjust the volume of this system

Press [+ VOL -].

- Volume range: 0 to 100

■ To mute the sound

Press [MUTE].

- While muting, "MUTE" is indicated on the display.
- To cancel, press the button again or adjust the volume.
- Muting is canceled if the main unit is turned off.



If this system does not operate as expected or sound is unusual, returning the settings to the factory defaults may solve the problem. (⇒ p. 26)

- If there is sound coming out of the TV's speakers, reduce the volume of the TV to the minimum level.

1 Press [⏻] to turn on the main unit.

2 Select the source.

Press	To select
[INPUT]	"TV" → "BD/DVD" ↑ "BLUETOOTH" ↓
[🔊]	"BLUETOOTH"

- This remote control cannot be used to control the operations of the connected devices.

■ When "BLUETOOTH" is selected as the source

On the Bluetooth® device:

Select this system as the output source of the connected Bluetooth® device and start the playback.

■ When "BD/DVD" is selected as the source

On the TV and the connected device:

Select the TV's input for this system and start the playback on the connected device.

3D sound

This system provides a feeling that the sound and the image are as one.

- To change the applied effect, refer to "Sound menu". (⇒ right)

e.g., Image of 3D sound field

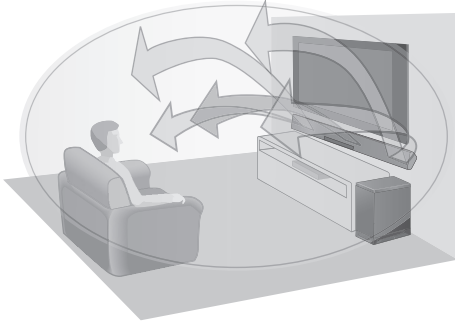

3D sound	
Dolby®Virtual Speaker	With this effect you can enjoy a Surround Sound effect similar to 5.1ch.
3D surround effect	Adding to the Dolby Virtual Speaker effect, Panasonic has applied its own sound field controlling technology to expand the sound field forwards, backwards, upwards, and downwards, providing a sound with depth and force that better matches 3D images.
Clear-mode dialog	Sports commentary and dialogs from TV dramas are heard as if the sound is coming from the TV, giving the feeling that the sound and the image are one. Also, the dialog will stand out from the other sounds during normal volume playback and when the volume is lowered for night time viewing.



- Dolby Virtual Speaker effect is ON except in STEREO mode.
- To turn off Dolby Virtual Speaker and the 3D surround effects, select "STEREO" as the sound mode. (⇒ right)
- To turn off the 3D surround and the Clear-mode dialog effects, refer to "3D CLR DIALOG". (⇒ p. 23)

Sound menu

- Press [SOUND] repeatedly to select the sound effect.
- Press [▲, ▼] repeatedly to select the desired setting and then press [OK].

SOUND MODE	<p>STANDARD: Best suited for dramas and comedy shows.</p> <p>STADIUM: Produces a realistic sound for live sports broadcasts.</p> <p>MUSIC: Enhances the sound of musical instruments and songs.</p> <p>CINEMA: Produces three-dimensional sound unique to movies.</p> <p>NEWS: Enhances the voice of news and sports commentaries.</p> <p>STEREO: Plays any source of sound in stereo.</p>
SUBWOOFER	<p>You can adjust the amount of bass. This system automatically selects the most suitable setting according to the type of playback source.</p> <p>LEVEL 1</p> <p>LEVEL 2: Default for 2 channel audio source</p> <p>LEVEL 3: Default for multi-channel audio source</p> <p>LEVEL 4</p> <p>The setting you make is retained and recalled every time you play the same type of source.</p>
DIALOG	<p>Adjusts the dialog level.</p> <p>LEVEL 1</p> <p>LEVEL 2</p> <p>LEVEL 3</p> <p>LEVEL 4</p> <p>"DIALOG" is not indicated on the display when "3D CLR DIALOG" is set to "OFF".</p>

H.BASS	Enhances the harmonic bass effect. <u>ON</u> OFF
3D CLR DIALOG	The 3D Clear Mode Dialog feature creates a sound field similar to the sound coming from a TV screen and makes dialogues clearer. <u>ON</u> : 3D Surround, Clear Mode Dialog and Dolby Virtual Speaker effect OFF : Dolby Virtual Speaker effect The setting is set back to “ON” every time you turn the main unit on.
DUAL AUDIO	Sets the preferred audio channel mode when there are two audio modes received by this system. <u>MAIN</u> : Main SAP : Secondary MAIN + SAP : Main + Secondary This effect only works if the audio output of the TV or player is set to “Bitstream” and “Dolby Dual Mono” is available in the sound source.
AGC	Auto gain control prevents sudden loud sound by reducing the sound level automatically when the input is too high. This function is suitable for a TV broadcast that has sound level difference. <u>ON</u> OFF If the sound becomes unnatural, select “OFF”.
LOW VOL MODE	Enhances the dialogue in low volume condition. <u>ON</u> OFF Select “OFF” to cancel this effect if the dialogue does not sound natural in low volume condition.

Audio format

You can view the current audio format.

Press and hold [SOUND] for more than 4 sec.

DOLBY DIGITAL	Dolby Digital is the audio source.
DTS	DTS is the audio source.
PCM MULTI	Linear pulse-code modulation is the audio source.
PCM	2 channel pulse-code modulation is the audio source.



- The default setting is underlined. Changed settings will be kept until it is changed again, unless otherwise indicated.

Setup menu

- 1 Press [SETUP] repeatedly to select the setup item.
- 2 Press [▲, ▼] repeatedly to select the desired setting and then press [OK].

DIMMER	Dims the display after 5 seconds of inactivity. ON <u>OFF</u>
AUTO POWER DOWN	The main unit is automatically turned off if there is no audio input and when you do not use it for approximately 20 minutes. ON <u>OFF</u>
VOL LIMITATION	Sets the volume limit to 50 when you turn on the main unit although the volume is set to above 50 before it is turned off. ON <u>OFF</u>
BLUETOOTH STANDBY	This function allows you to connect a paired Bluetooth® device when the main unit is in standby mode. ON <u>OFF</u> The main unit will be turned on automatically when you connect a paired Bluetooth® device.

LINK MODE	Change the Bluetooth® connection link mode to suit the connection type. Make sure to disconnect the current connected device (“BLUETOOTH READY” is indicated on the display). MODE 1: Emphasis on connectivity. <u>MODE 2:</u> Emphasis on sound quality.
VIERA LINK	Turn on the VIERA Link function. ON <u>OFF</u> Select “OFF” when your HDAVI Control device does not work correctly with this system. ARC will be disabled. Connect an optical digital audio cable. Turn off all connected devices and then turn them on again after changing the setting.



- The default setting is underlined. Changed settings will be kept until it is changed again, unless otherwise indicated.

Linked operations with the TV (VIERA Link™ “HDAVI Control™”)

What is VIERA Link “HDAVI Control”?

VIERA Link™ is a new name for EZ Sync™. VIERA Link “HDAVI Control” is a convenient function that offers linked operations of this system, and a Panasonic TV (VIERA) under “HDAVI Control”.

You can use this function by connecting the equipment with an HDMI cable. See the operating instructions for connected equipment for operational details.

Preparation

- ① Confirm that the HDMI connection has been made. (⇒ p. 9, 10)
- ② Set the “HDAVI Control” operations on the connected equipment (e.g., TV).
- ③ For the optimal “HDAVI Control” operations change the following settings on the connected TV*1.
 - Set the default speaker settings to this system.*2
 - Set the speaker selection settings to this system.
- ④ Turn on all “HDAVI Control” compatible equipment and select the TV’s input for this system so that the “HDAVI Control” function works properly.
- ⑤ If a device is connected to the HDMI AV IN terminal, start play to check that the picture is displayed on the TV correctly.

When the connection or settings are changed, repeat this procedure.

- *1 The availability and function of the settings may vary depending on the TV. Refer to the operating instructions for the TV for details.
- *2 If the TV has a default speaker setting within the VIERA Link setting items, choosing this system as the default speaker will automatically change the speaker selection to this system.



- VIERA Link “HDAVI Control”, based on the control functions provided by HDMI which is an industry standard known as HDMI CEC (Consumer Electronics Control), is a unique function that we have developed and added. As such, its operation with other manufacturers’ equipment that supports HDMI CEC cannot be guaranteed.
- This unit supports “HDAVI Control 5” function. “HDAVI Control 5” is the standard for Panasonic’s HDAVI Control compatible equipment. This standard is compatible with Panasonic’s conventional HDAVI equipment.
- Please refer to individual manuals for other manufacturers’ equipment supporting VIERA Link function.

What you can do with VIERA Link “HDAVI Control”

To make sure that the audio is output from this system, turn the main unit on by using the TV’s remote control and selecting home theater from the speaker menu of VIERA Link menu.

The availability and function of the settings may vary depending on the TV. Refer to the operating instructions for the TV for details.

■ Speaker control

You can select whether audio output is from this system or the TV speakers by using the TV menu settings.

Home theater

This system is active.

- When the main unit is in standby mode, changing the TV speakers to this system in the VIERA Link menu will automatically turn the main unit on.
- You can control the volume setting of this system using the volume or mute button on the TV remote control.
- If you turn off the main unit, TV speakers will be automatically activated.
- Audio will automatically be output from this system if the TV is compatible to VIERA Link “HDAVI Control 4” or later.

TV

TV speakers are active.

- The volume of this system is set to its minimum.

■ Automatic input switching

When the following operations are performed, the main unit will automatically change the input to the corresponding source.

- When play starts on an HDMI connected device.*3
- When the TV input or the TV channel is changed.

- *3 If the speaker output setting on the TV is set to this system, the TV and the main unit turn on automatically (Power on link).

■ Power off link

When the TV is turned off, the main unit also turns off automatically. (This function does not work when Bluetooth® is the source.)

■ Automatic lip-sync function

(for HDAVI Control 3 or later)

Delay between audio and video is automatically adjusted by adding time-lag to the audio output, enabling you to enjoy smooth audio for the picture.



The delay information is automatically set if the TV is compatible to VIERA Link “HDAVI Control 3” or later and the VIERA Link is set to on.

Troubleshooting

Before requesting service, make the following checks. If you are in doubt about some of the check points, or if the solutions indicated in the following guide do not solve the problem, refer to "Customer Services Directory (United States)" on page 32 if you reside in the U.S.A. or refer to "Limited Warranty (ONLY FOR CANADA)" on page 33 if you reside in Canada.

To return to the factory defaults.

While the main unit is on, press and hold [⏮/I] on the main unit for more than 4 sec. ("RESET" is indicated on the display when this system is reset.)

If this system does not operate as expected, returning the settings to the factory defaults may solve the problem.

- The remote control code will return to "REMOTE 1" when this system is returned to the factory preset. To change the remote control code, refer to page 20.

General operation

No power.

- Unplug the AC power supply cord for 10 sec before plug in again.
- After turning the main unit on, if the main unit immediately turns off, unplug the AC power supply cord and consult your dealer.
- If the main unit does not turn on by turning on TV (HDAVI control), manually turn on the main unit. If the problem persists, refer to "HDMI" in "Troubleshooting".

The remote control does not work properly.

- The battery is dead. Replace the battery with a new one. (⇒ p. 8)
- It is possible that the insulation sheet has not been removed. Remove the insulation sheet. (⇒ p. 8)
- It may be necessary to set the code of the remote control again after changing the battery of the remote control. (⇒ p. 20)
- Use the remote control within the correct operation range. (⇒ p. 8)
- Check which remote control signal sensor is working by the following operation.
 - Press and hold [INPUT] on the main unit for more than 4 sec. "ON TABLE" or "ON WALL" is indicated on the display for 4 sec.

– Refer to page 8 "About remote control signal sensor" for the remote control signal sensor location.

The main unit is automatically switched to standby mode.

"AUTO POWER DOWN" function is on.

The main unit will automatically switch to standby mode when no signal is input and no operation is performed for approximately 20 minutes. Refer to page 24 to turn this function off.

The main unit is turned off when the TV's speakers are selected in the speaker control.

This is a normal feature when using VIERA Link (HDAVI Control 4 or later). Please read the operating instructions for the TV for details about its power save feature. (⇒ p. 25)

HDMI

This system does not operate correctly.

If the HDMI cable is connected to the wrong terminal (HDMI AV IN or HDMI AV OUT), this system will not operate correctly. Turn the main unit off, disconnect the AC power supply cord and reconnect the HDMI cable(s). (⇒ p. 9, 10)

VIERA Link related operations no longer function properly.

- Check the VIERA Link setting on the connected devices.
 - Turn on VIERA Link function on the connected devices.
 - Select this system as the speaker in the TV's VIERA Link menu.
- Check if the VIERA Link settings are off. (⇒ p. 24)
- When the HDMI connections are changed, after a power failure or after the AC power supply cord has been removed, VIERA Link operations may not function properly.
 - Turn on all the devices that are connected to the TV with an HDMI cable and then turn the TV on.
 - Turn off the VIERA Link settings of the TV and turn it on again. For details refer to the operating instructions for the TV.
 - While the main unit and the TV are connected with the HDMI cable, turn on the TV and then remove the main unit's AC power supply cord and reconnect it again.

The first few seconds of audio cannot be heard when using the HDMI connection.

This may occur during DVD-Video chapter playback. Change the digital audio output setting on the connected device from "Bitstream" to "PCM".

When operating an HDMI compatible device of a different brand, the main unit reacts in an unwanted manner.

HDAVI Control commands may use a different signal depending on the brand of the device. In this case, turn VIERA Link off. (⇒ p. 24)

When the main unit is turned on or off, audio and video are temporarily disabled

When the main unit is turned on or off it is normal for the audio and video to be temporarily disabled. This is not a malfunction. This can occur when the device it is connected to, via HDMI, does not support Panasonic's VIERA Link feature (HDAVI Control 3 or later).

Bluetooth®

Pairing cannot be done.

Check the Bluetooth® device condition.

The device cannot be connected.

- The pairing of the device was unsuccessful or the registration has been replaced. Try pairing the device again. (⇒ p. 19)
 - This system might be connected to a different device. Disconnect the other device and try pairing the device again.
-

The device is connected but audio cannot be heard through this system.

For some built-in Bluetooth® devices, you have to set the audio output to "SC-HTB580" manually. Read the operating instructions for the device for details.

The sound is interrupted.

- The device is out of the 10 m (33 ft) communication range. Bring the Bluetooth® device closer to the main unit.
 - Remove any obstacle between the main unit and the device.
 - Other devices that use the 2.4 GHz frequency band (wireless router, microwaves, cordless phones, etc.) are interfering. Bring the Bluetooth® device closer to the main unit and distance it from the other devices.
 - Select "MODE1" for stable communication. (⇒ p. 24)
-

The One-Touch Connection (NFC feature) is not working.

Make sure the main unit and the NFC feature of the device are turned on. (⇒ p. 20)

Sound

No sound (or image).

- Turn mute off. (⇒ p. 21)
 - Check the connections to the other devices. (⇒ p. 9, 10)
 - Make sure that the received audio signal is compatible with this system. (⇒ p. 30)
 - Turn this system off and then on again.
 - If the main unit is connected to the TV with only an HDMI cable, make sure that the TV's HDMI terminal is labeled "HDMI (ARC)". If not, connect using the optical digital audio cable. (⇒ p. 9, 10)
 - If the main unit is connected to a Panasonic TV and turned on using the button on the main unit or the remote control, sound might not be output from this system. In this case, turn the main unit on using the TV's remote control. (⇒ p. 25)
 - If the connections are correct, there might be a problem with the cables. Redo the connections with different cables.
 - Check the audio output settings on the connected device.
-

The dual audio cannot be changed from main to secondary.

If the audio received from the connected device is not "Dolby Dual Mono" or the output setting is not "Bitstream", the setting cannot be changed from this system. Change the setting on the connected device.

The volume is lowered when the main unit is turned on.

"VOL LIMITATION" is on.

If the main unit is turned off with the volume setting in the greater half (above 50), the main unit will automatically lower the volume to the middle (50) when the main unit is turned on. (⇒ p. 24)

The dialogue is too persistent or the dialogue does not sound natural.

This system has a function to make the dialogue stand out when the volume is low. (⇒ p. 23)

There is no audio.

The power of the main unit turns off automatically.

(When the main unit detects a problem, a safety measure is activated and the main unit automatically switches to standby mode.)

- There is a problem with the amplifier.
- Check to see if the volume is really loud.
If so, lower the volume.
- Check to see if this system is placed in an extremely hot area.
If so, move this system to a cooler place and wait a few moments and then try to turn it on again.

If the problem persists, confirm the display, turn this system off, remove the AC power supply cord and consult your dealer. Please be sure to remember the display that was indicated and inform the dealer.

Main unit displays

“F61”

- There is a problem with the amplifier of the system.
- Disconnect the AC power supply cord and consult the dealer.

“F70 HDMI”

- Check HDMI connection.
- Turn off the main unit and then switch it on again.
- Disconnect the HDMI cable.

“F76”

- There is a problem with the power supply.
- Disconnect the AC power supply cord and consult the dealer.

Active Subwoofer

No power.

Ensure the AC power supply cord of the active subwoofer is connected properly.

After turning the subwoofer on, it immediately turns off.

Unplug the AC power supply cord and consult your dealer.

No sound from the subwoofer.

- Check that the active subwoofer is turned on.
- Check that the WIRELESS LINK indicator lights green. (⇒ p. 19)

The WIRELESS LINK indicator lights red.

- There is no link between the main unit and the active subwoofer.
 - Check that the main unit is turned on.
 - Turn the active subwoofer off and then back on. Alternatively, turn the active subwoofer off, disconnect the AC power supply cord and then reconnect it.
- The active subwoofer and the main unit may not be paired correctly. Try the following operation. (Wireless pairing)
 - ① Turn on the main unit and active subwoofer.
 - ② Press and hold [ID SET] on the rear of the active subwoofer for more than 3 sec. (The WIRELESS LINK indicator will blink in red.)
 - ③ While pressing and holding [INPUT] on remote control, press and hold [VOL +] on the main unit for more than 4 sec. (“SUBWOOFER PAIRING” will be indicated on the display.)
 - When the wireless pairing is successful, “PAIRED” will be indicated on the display for 2 sec and WIRELESS LINK indicator lights green.
 - ④ Turn the main unit off and on.
- Consult your dealer if the problem persists.

About Bluetooth®

Panasonic bears no responsibility for data and/or information that is compromised during a wireless transmission.

■ Frequency band used

This system uses the 2.4 GHz frequency band.

■ Certification of this device

- This system conforms to frequency restrictions and has received certification based on frequency laws. Thus, a wireless permit is not necessary.
- The action below are punishable by law in some countries:
 - Taking apart or modifying the unit.
 - Removing specification indications.

■ Restrictions of use

- Wireless transmission and/or usage with all Bluetooth® equipped devices is not guaranteed.
- All devices must conform to standards set by Bluetooth SIG, Inc.
- Depending on the specifications and settings of a device, it can fail to connect or some operations can be different.
- This system supports Bluetooth® security features. But depending on the operating environment and/or settings, this security is possibly not sufficient. Transmit data wirelessly to this system with caution.
- This system cannot transmit data to a Bluetooth® device.

■ Range of use

Use this device at a maximum range of 10 m (33 ft). The range can decrease depending on the environment, obstacles or interference.

■ Interference from other devices

- This system may not function properly and troubles such as noise and sound jumps may arise due to radio wave interference if the main unit is located too close to other Bluetooth® devices or the devices that use the 2.4 GHz band.
- This system may not function properly if radio waves from a nearby broadcasting station, etc. are too strong.

■ Intended usage

- This system is for normal, general use only.
- Do not use this system near equipment or in an environment that is sensitive to radio frequency interference (example: airports, hospitals, laboratories, etc.).

Unit care

■ Clean this system with a soft, dry cloth

- When dirt is heavy, wring a cloth moistened in water tightly to wipe the dirt, and then wipe it with a dry cloth.
- When cleaning the speakers, use a fine cloth. Do not use tissues or other materials (towels, etc.) that can fall apart. Small grains may get stuck inside the speaker cover.
- Never use alcohol, paint thinner or benzine to clean this system.
- Before using chemically-treated cloth, carefully read the instructions that came with the cloth.

■ To dispose or transfer this system

This system may keep the user settings information in the main unit. If you discard the main unit either by disposal or transfer, then follow the procedure to return all the settings to the factory defaults to delete the user settings. (⇒ p. 26, "To return to the factory defaults.")

- The operation history may be recorded in the memory of the main unit.

Licenses

Manufactured under license from Dolby Laboratories. Dolby, Pro Logic, and the double-D symbol are trademarks of Dolby Laboratories.

Manufactured under license under U.S. Patent Nos: 5,956,674; 5,974,380; 6,487,535 & other U.S. and worldwide patents issued & pending. DTS, the Symbol, & DTS and the Symbol together are registered trademarks & DTS Digital Surround and the DTS logos are trademarks of DTS, Inc. Product includes software.
© DTS, Inc. All Rights Reserved.

HDMI, the HDMI Logo, and High-Definition Multimedia Interface are trademarks or registered trademarks of HDMI Licensing LLC in the United States and other countries.

HDAVI Control™ is a trademark of Panasonic Corporation.

VIERA Link™ is a trademark of Panasonic Corporation.

EZ Sync™ is a trademark of Panasonic Corporation.

The Bluetooth® word mark and logos are owned by the Bluetooth SIG, Inc. and any use of such marks by Panasonic Corporation is under license. Other trademarks and trade names are those of their respective owners.

Google Play and Android are trademarks of Google Inc.

Specifications

AMPLIFIER SECTION

RMS output power: Dolby Digital Mode

Front ch (L, R ch)

60 W per channel (6 Ω), 1 kHz, 10 % THD

Center ch (C ch)

60 W per channel (6 Ω), 1 kHz, 10 % THD

Subwoofer ch

130 W per channel (8 Ω), 100 Hz, 10 % THD

Total RMS Dolby Digital mode power

310 W

FTC output power: Dolby Digital Mode

Front ch (L, R ch)

30 W per channel (6 Ω),
170 Hz to 20 kHz, 1 % THD

Center ch (C ch)

30 W per channel (6 Ω),
170 Hz to 20 kHz, 1 % THD

Subwoofer ch

80 W per channel (8 Ω),
40 Hz to 200 Hz, 1 % THD

Total FTC Dolby Digital mode power

170 W

TERMINAL SECTION

HDAVI Control

This unit supports "HDAVI Control 5" function.

HDMI AV input (BD/DVD)

1

Input connector

Type A (19 pin)

HDMI AV output (TV (ARC))

1

Output connector

Type A (19 pin)

Digital audio input (TV)

Optical digital input

Optical terminal

Sampling frequency

32 kHz, 44.1 kHz, 48 kHz
88.2 kHz, 96 kHz (only LPCM)

Audio format

LPCM, Dolby Digital, DTS Digital Surround

IR Blaster

Terminal Type

3.5 mm (1/8") jack

USB Port

For service use only.

GENERAL

Power consumption

Main unit

31 W

Active subwoofer

21 W

In standby condition

Main unit (When the other connected devices
are turned off)

Approx. 0.4 W

Active subwoofer (Power switch release)

Approx. 0.2 W

Power supply

AC 120 V, 60 Hz

Dimensions (W×H×D)

Main unit

For table top layout

950 mm×53 mm×110 mm
(37 13/32"×2 3/32"×4 11/32")

For wall mounting layout

950 mm×110 mm×57 mm
(37 13/32"×4 11/32"×2 1/4")

Active subwoofer

180 mm×408 mm×306 mm
(7 3/32"×16 1/16"×12 1/16")

Mass (Weight)

Main unit

For table top layout

Approx. 2.6 kg (5.7 lbs)

For wall mounting layout

Approx. 2.7 kg (5.8 lbs)

Active subwoofer

Approx. 5.0 kg (11.0 lbs)

Operating temperature range

0 °C to +40 °C (+32 °F to +104 °F)

Operating humidity range

20 % to 80 % RH (no condensation)

SPEAKER SECTION

Front speakers (Built-in)

Full range

6.5 cm (2 1/2") cone type × 1 /ch

Center speaker (Built-in)

Full range

6.5 cm (2 1/2") cone type × 1

Active subwoofer

Woofer

16 cm (6 1/2") cone type × 1

WIRELESS SECTION

Wireless module

Frequency Range

2.40335 GHz to 2.47735 GHz

No. of channels

38

Bluetooth® SECTION

Bluetooth® system specification

Bluetooth® Ver.3.0

Wireless equipment classification

Class 2

Supported profiles

A2DP

Operating frequency

2.4 GHz band FH-SS

Operating distance

10 m (33 ft) Line of Sight



- Specifications are subject to change without notice.
- Mass and dimensions are approximate.
- Total harmonic distortion is measured by a digital spectrum analyzer.

Limited Warranty (ONLY FOR U.S.A.)

Panasonic Products Limited Warranty

Limited Warranty Coverage (For USA Only)

If your product does not work properly because of a defect in materials or workmanship, Panasonic Corporation of North America (referred to as "the warrantor") will, for the length of the period indicated on the chart below, which starts with the date of original purchase ("warranty period"), at its option either (a) repair your product with new or refurbished parts, (b) replace it with a new or a refurbished equivalent value product, or (c) refund your purchase price. The decision to repair, replace or refund will be made by the warrantor.

Product or Part Name	Parts	Labor
Home Theater Audio System	1 Year	1 Year
All included Accessories (Except Non-Rechargeable Batteries)	90 Days	Not Applicable
Only Non-Rechargeable Batteries	10 Days	Not Applicable

During the "Labor" warranty period there will be no charge for labor. During the "Parts" warranty period, there will be no charge for parts. This Limited Warranty excludes both parts and labor for non-rechargeable batteries, antennas, and cosmetic parts (cabinet). This warranty only applies to products purchased and serviced in the United States. This warranty is extended only to the original purchaser of a new product which was not sold "as is".

Mail-In Service--Online Repair Request

Online Repair Request

To submit a new repair request and for quick repair status visit our Web Site at www.panasonic.com/repair.

When shipping the unit, carefully pack, include all supplied accessories listed in the Owner's Manual, and send it prepaid, adequately insured and packed well in a carton box. When shipping Lithium Ion batteries please visit our Web Site at www.panasonic.com/BatteryHandling as Panasonic is committed to providing the most up to date information. Include a letter detailing the complaint, a return address and provide a daytime phone number where you can be reached. A valid registered receipt is required under the Limited Warranty.

IF REPAIR IS NEEDED DURING THE WARRANTY PERIOD, THE PURCHASER WILL BE REQUIRED TO FURNISH A SALES RECEIPT/ PROOF OF PURCHASE INDICATING DATE OF PURCHASE, AMOUNT PAID AND PLACE OF PURCHASE. CUSTOMER WILL BE CHARGED FOR THE REPAIR OF ANY UNIT RECEIVED WITHOUT SUCH PROOF OF PURCHASE.

Limited Warranty Limits And Exclusions

This warranty ONLY COVERS failures due to defects in materials or workmanship, and DOES NOT COVER normal wear and tear or cosmetic damage. The warranty ALSO DOES NOT COVER damages which occurred in shipment, or failures which are caused by products not supplied by the warrantor, or failures which result from accidents, misuse, abuse, neglect, mishandling, misapplication, alteration, faulty installation, set-up adjustments, misadjustment of consumer controls, improper maintenance, power line surge, lightning damage, modification, introduction

of sand, humidity or liquids, commercial use such as hotel, office, restaurant, or other business or rental use of the product, or service by anyone other than a Factory Service Center or other Authorized Servicer, or damage that is attributable to acts of God.

THERE ARE NO EXPRESS WARRANTIES EXCEPT AS LISTED UNDER "LIMITED WARRANTY COVERAGE". THE WARRANTOR IS NOT LIABLE FOR INCIDENTAL OR CONSEQUENTIAL DAMAGES RESULTING FROM THE USE OF THIS PRODUCT, OR ARISING OUT OF ANY BREACH OF THIS WARRANTY.

(As examples, this excludes damages for lost time, travel to and from the servicer, loss of or damage to media or images, data or other memory or recorded content. The items listed are not exclusive, but for illustration only.)

ALL EXPRESS AND IMPLIED WARRANTIES, INCLUDING THE WARRANTY OF MERCHANTABILITY, ARE LIMITED TO THE PERIOD OF THE LIMITED WARRANTY.

Some states do not allow the exclusion or limitation of incidental or consequential damages, or limitations on how long an implied warranty lasts, so the exclusions may not apply to you. This warranty gives you specific legal rights and you may also have other rights which vary from state to state. If a problem with this product develops during or after the warranty period, you may contact your dealer or Service Center. If the problem is not handled to your satisfaction, then write to the warrantor's Consumer Affairs Department at the addresses listed for the warrantor.

PARTS AND SERVICE, WHICH ARE NOT COVERED BY THIS LIMITED WARRANTY, ARE YOUR RESPONSIBILITY.

Customer Services Directory (United States)

Obtain Product Information and Operating Assistance; locate your nearest Dealer or Service Center; purchase Parts and Accessories; or make Customer Service and Literature requests by visiting our Web Site at: <http://www.panasonic.com/support> or, contact us via the web at: <http://www.panasonic.com/contactinfo>

For hearing or speech impaired TTY users, TTY: 1-877-833-8855

Accessory Purchases (United States)

Purchase Parts, Accessories and Owner's Manual online for all Panasonic Products by visiting our Web Site at: <http://www.pstc.panasonic.com>
Or, send your request by E-mail to: nppcparts@us.panasonic.com
You may also contact us directly at: 1-800-237-9080 (Fax Only)
(Monday-Friday 9am-9pm EST)
Panasonic National Parts Center
20421 84th Avenue South, Kent, WA 98032
(We accept Visa, MasterCard, Discover Card, American Express)

For hearing or speech impaired TTY users, TTY: 1-866-605-1277

As of April 2014

The model number and serial number of this product can be found on either the back or the bottom of the unit. Please note them in the space provided below and keep for future reference.

MODEL NUMBER SC-HTB580

SERIAL NUMBER _____

User memo:

DATE OF PURCHASE _____

DEALER NAME _____

DEALER ADDRESS _____

TELEPHONE NUMBER _____

Limited Warranty (ONLY FOR CANADA)

Panasonic Canada Inc.

5770 Ambler Drive, Mississauga, Ontario L4W 2T3

PANASONIC PRODUCT - LIMITED WARRANTY

Panasonic Canada Inc. warrants this product to be free from defects in material and workmanship under normal use and for a period as stated below from the date of original purchase agrees to, at its option either (a) repair your product with new or refurbished parts, (b) replace it with a new or a refurbished equivalent value product, or (c) refund your purchase price. The decision to repair, replace or refund will be made by Panasonic Canada Inc.

Technics Audio Product - One (1) year, parts and labour
Panasonic BD/DVD Product - One (1) year, parts and labour
Panasonic Audio Receivers - One (1) year, parts and labour
Home Theater Systems Product - One (1) year, parts and labour

This warranty is given only to the original purchaser, or the person for whom it was purchased as a gift, of a Panasonic brand product mentioned above sold by an authorized Panasonic dealer in Canada and purchased and used in Canada, which product was not sold "as is", and which product was delivered to you in new condition in the original packaging.

IN ORDER TO BE ELIGIBLE TO RECEIVE WARRANTY SERVICE HEREUNDER, A PURCHASE RECEIPT OR OTHER PROOF OF DATE OF ORIGINAL PURCHASE, SHOWING AMOUNT PAID AND PLACE OF PURCHASE IS REQUIRED

LIMITATIONS AND EXCLUSIONS

This warranty **ONLY COVERS** failures due to defects in materials or workmanship, and **DOES NOT COVER** normal wear and tear or cosmetic damage. The warranty **ALSO DOES NOT COVER** damages which occurred in shipment, or failures which are caused by products not supplied by Panasonic Canada Inc., or failures which result from accidents, misuse, abuse, neglect, mishandling, misapplication, alteration, faulty installation, set-up adjustments, misadjustment of consumer controls, improper maintenance, power line surge, lightning damage, modification, introduction of sand, humidity or liquids, commercial use such as hotel, office, restaurant, or other business or rental use of the product, or service by anyone other than an Authorized Servicer, or damage that is attributable to acts of God.

Dry cell batteries are also excluded from coverage under this warranty.

THIS EXPRESS, LIMITED WARRANTY IS IN LIEU OF ALL OTHER WARRANTIES, EXPRESS OR IMPLIED, INCLUDING ANY IMPLIED WARRANTIES OF MERCHANTABILITY AND FITNESS FOR A PARTICULAR PURPOSE. IN NO EVENT WILL PANASONIC CANADA INC. BE LIABLE FOR ANY SPECIAL, INDIRECT OR CONSEQUENTIAL DAMAGES RESULTING FROM THE USE OF THIS PRODUCT OR ARISING OUT OF ANY BREACH OF ANY EXPRESS OR IMPLIED WARRANTY. (As examples, this warranty excludes damages for lost time, travel to and from the Authorized Servicer, loss of or damage to media or images, data or other memory or recorded content. This list of items is not exhaustive, but for illustration only.)

In certain instances, some jurisdictions do not allow the exclusion or limitation of incidental or consequential damages, or the exclusion of implied warranties, so the above limitations and exclusions may not be applicable. This warranty gives you specific legal rights and you may have other rights which vary depending on your province or territory.

WARRANTY SERVICE

For product operation, repairs and information assistance, please visit our Support page:

www.panasonic.ca/english/support

IF YOU SHIP THE PRODUCT TO A SERVICENTRE

Carefully pack and send prepaid, adequately insured and preferably in the original carton.
Include details of the defect claimed, and proof of date of original purchase.

-If you see this symbol-

Information on Disposal in other Countries outside the European Union



This symbol is only valid in the European Union. If you wish to discard this product, please contact your local authorities or dealer and ask for the correct method of disposal.

Panasonic Corporation of North America

Two Riverfront Plaza, Newark, NJ 07102-5490

<http://www.panasonic.com>

Panasonic Canada Inc.

5770 Ambler Drive,
Mississauga, Ontario,
L4W 2T3

www.panasonic.com

En