

# Panasonic®

## Owner's Manual Wireless Speaker System

---

Model No. SC-NT10



Thank you for purchasing this product.

Please read these instructions carefully before using this product, and save this manual for future use.

Register online at [www.panasonic.com/register](http://www.panasonic.com/register) (U.S. customers only)

If you have any questions, contact:

U.S.A. and Puerto Rico : 1-800-211-PANA (7262)

Canada : 1-800-561-5505

# IMPORTANT SAFETY INSTRUCTIONS

Read these operating instructions carefully before using the unit. Follow the safety instructions on the unit and the applicable safety instructions listed below. Keep these operating instructions handy for future reference.

- 1 Read these instructions.
- 2 Keep these instructions.
- 3 Heed all warnings.
- 4 Follow all instructions.
- 5 Do not use this apparatus near water.
- 6 Clean only with dry cloth.
- 7 Do not block any ventilation openings. Install in accordance with the manufacturer's instructions.
- 8 Do not install near any heat sources such as radiators, heat registers, stoves, or other apparatus (including amplifiers) that produce heat.
- 9 Do not defeat the safety purpose of the polarized or grounding-type plug. A polarized plug has two blades with one wider than the other. A grounding-type plug has two blades and a third grounding prong. The wide blade or the third prong are provided for your safety. If the provided plug does not fit into your outlet, consult an electrician for replacement of the obsolete outlet.
- 10 Protect the power cord from being walked on or pinched particularly at plugs, convenience receptacles, and the point where they exit from the apparatus.
- 11 Only use attachments/accessories specified by the manufacturer.
- 12 Use only with the cart, stand, tripod, bracket, or table specified by the manufacturer, or sold with the apparatus. When a cart is used, use caution when moving the cart/apparatus combination to avoid injury from tip-over.
- 13 Unplug this apparatus during lightning storms or when unused for long periods of time.
- 14 Refer all servicing to qualified service personnel. Servicing is required when the apparatus has been damaged in any way, such as power-supply cord or plug is damaged, liquid has been spilled or objects have fallen into the apparatus, the apparatus has been exposed to rain or moisture, does not operate normally, or has been dropped.



## Precautions

### ■ WARNING

#### Unit

- To reduce the risk of fire, electric shock or product damage,
- Do not let water or other liquids drip or splash inside the unit.
  - Do not expose accessory to rain, moisture, dripping or splashing.
  - Do not place objects filled with liquids, such as vases, on accessory.
  - Use only the recommended accessory.
  - Do not remove the cover except disassembling for discarding.
  - Do not repair this unit by yourself. Refer servicing to qualified service personnel.

#### USB cable

The cable is the disconnecting device. Install this unit so that the cable can be unplugged from the USB terminal of PC immediately.

### ■ CAUTION

#### Unit

- Product identification marking is located on the bottom of the unit.
- Do not throw.
- Do not hit this unit to anything. Do not apply strong pressure to this unit. External case may break when strong impact is applied, causing to damage or malfunction.
- Do not leave the unit in a car exposed to direct sunlight for a long period of time with doors and windows closed.

#### Batteries

This unit has a built-in battery.

- In order to secure splashproof performance, battery replacement by the customer is not guaranteed. If you desire battery replacement, please contact our service department.

The following is the caution for removing the battery when disposing of this unit (⇒ 16).

- Do not heat or expose to flame.
- Do not short circuit.
- Do not disassemble, crush.
- Do not re-use.
- Do not place in microwave ovens.

## THE FOLLOWING APPLIES ONLY IN THE U.S.A.

### FCC Note:

This equipment has been tested and found to comply with the limits for a Class B digital device, pursuant to Part 15 of the FCC Rules.

These limits are designed to provide reasonable protection against harmful interference in a residential installation. This equipment generates, uses and can radiate radio frequency energy and, if not installed and used in accordance with the instructions, may cause harmful interference to radio or television reception, which can be determined by turning the equipment off and on, the user is encouraged to try to correct the interference by one or more of the following measures:

- Reorient or relocate the receiving antenna.
- Increase the separation between the equipment and receiver.
- Connect the equipment into an outlet on a circuit different from that to which the receiver is connected.
- Consult the dealer or an experienced radio/TV technician for help.

**FCC Caution:** To assure continued compliance, follow the attached installation instructions and use only shielded interface cables when connecting to peripheral devices.

Any changes or modifications not expressly approved by the party responsible for compliance could void the user's authority to operate this equipment.

This device complies with Part 15 of the FCC Rules. Operation is subject to the following two conditions:

- (1) This device may not cause harmful interference, and
- (2) this device must accept any interference received, including interference that may cause undesired operation.

Declaration of Conformity

Trade Name: Panasonic

Model No.: SC-NT10

Responsible Party:

Panasonic Corporation of North America  
One Panasonic Way, Secaucus, NJ 07094

Support Contact:

Panasonic Consumer Marketing Company of  
North America

Telephone No.: 1-800-211-PANA (7262)

## THE FOLLOWING APPLIES ONLY IN CANADA.

CAN ICES-3(B)/NMB-3(B)

## THE FOLLOWING APPLIES IN THE U.S.A. AND CANADA

This device complies with Part 15 of FCC Rules and Industry Canada licence-exempt RSS standard(s). Operation is subject to the following two conditions:

- (1) This device may not cause interference, and
- (2) this device must accept any interference, including interference that may cause undesired operation of this device.

FCC ID:ACJ-SC-NT10

IC: 216A-SCNT10

This transmitter must not be co-located or operated in conjunction with any other antenna or transmitter.

This equipment complies with FCC/IC radiation exposure limits set forth for an uncontrolled environment and meets the FCC radio frequency (RF) Exposure Guidelines in Supplement C to OET65 and RSS-102 of the IC radio frequency (RF) Exposure rules. This equipment has very low levels of RF energy that is deemed to comply without maximum permissive exposure evaluation (MPE). But it is desirable that it should be installed and operated keeping the radiator at least 20 cm ( $7\frac{1}{8}$ " ) or more away from person's body (excluding extremities: hands, wrists, feet and ankles).



A nickel metal hydride battery that is recyclable powers the product you have purchased. Please call 1-800-8-BATTERY for information on how to recycle this battery.

## Maintenance

Turn off the power of this unit and wipe with dry soft cloth. Disconnect the USB cable when the USB cable is used.

- When it get very dirty, wipe off dirt with a cloth immersed in water and wrung strongly, and then wipe with dry soft cloth.
- Solvents such as benzene, thinner, alcohol, oil, detergents, etc., may cause the external case to be altered or the coating may come off, so do not use them.
- Before using chemically treated cloth, read the instructions that came with the cloth carefully.

# Table of contents

IMPORTANT SAFETY INSTRUCTIONS.....	2
Precautions.....	2
Maintenance.....	3
Accessories.....	4
Control reference guide.....	5
(Important) About the splashproof, dustproof, shockproof and freezeproof/heatproof.....	6
About the power of this unit.....	7
Listening to audio from a Bluetooth® device.....	8
Connecting via Bluetooth® menu.....	8
One-Touch Connection (Connecting by NFC).....	9
Selecting Transmission mode setting.....	10
Disconnecting Bluetooth®.....	10
Using Boost Mode.....	11
Using the AUX input.....	11
Auto Power Off.....	11
Receiving a call with Hands-Free.....	12
To return to the factory preset state.....	12
Troubleshooting.....	13
Specifications.....	14
About Bluetooth®.....	15
Licenses.....	15
To remove the battery when disposing of this unit.....	16
Limited Warranty (ONLY FOR U.S.A. AND PUERTO RICO).....	17
Limited Warranty (ONLY FOR CANADA).....	19

## Accessories

Check the supplied accessories before using this unit.

### 1 USB cable (K1HY04YY0074)

- The USB cable is dedicated for this unit, so do not use with other devices. Also, do not use the USB cable for other devices with this unit.

### Note

- Product numbers provided in this Owner's Manual correct as of June 2013. These may be subject to change.
- (ONLY FOR CANADA) The enclosed Canadian French label sheet corresponds to the English display on the unit.

## Control reference guide

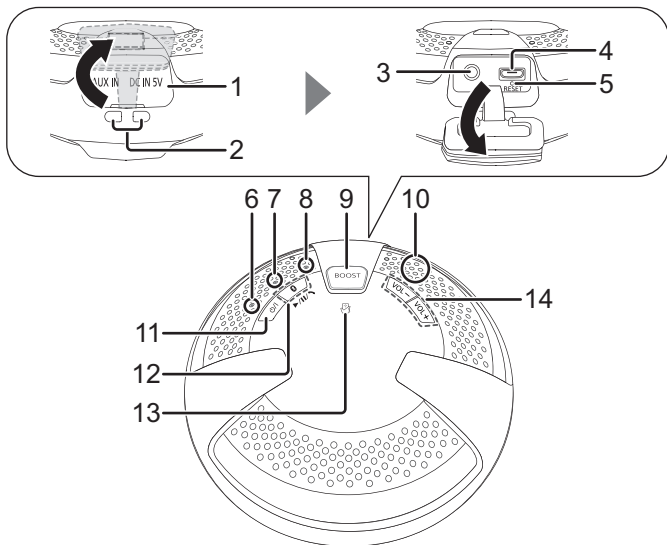

- 1 Terminal cover
- 2 Strap hole
- 3 AUX IN jack (⇒ 11)
- 4 DC IN terminal
- 5 RESET
  - Use a paper clip, etc., to press the switch if this unit does not operate correctly, like when you cannot turn off/on the power.
- 6 Battery indicator (red) (⇒ 7)
  - Indicates the battery status.
- 7 Bluetooth® indicator (blue)
- 8 Boost Mode indicator (orange)
- 9 Boost button (⇒ 11)
- 10 Microphone (⇒ 12)
- 11 Power on/off button [⏻/⏻]
  - Press to switch the unit from on to standby mode or vice versa. In standby mode, the unit is still consuming a small amount of power.
- 12 Bluetooth® pairing button (⇒ 8)/ Play button (below)/Pause button (below)/Receiver button (⇒ 12)
  - Play / Pause: Press this button to switch between play and pause while playing music with the paired device.
- 13 NFC touch area (⇒ 9)
- 14 Volume buttons

# (Important) About the splashproof, dustproof, shockproof and freezeproof/heatproof

## ■ Splashproof performance\*

Specifications for this unit are equivalent of IPX4 of IEC 60529.

### About the IPX4 (liquid ingress protection level against splashing water)

This unit is compatible to operate after splashing from nozzles approximately 1.8 L/min (0.5 gallon/min) of room temperature tap water from every direction approximately 20 cm (8") from this unit for 10 minutes. Supplied USB cable is not splashproof.

## ■ Dustproof performance\*

Dustproof performance test established by company has been passed. (Corresponds to the fact that this unit operates. Does not apply to items concerning change in appearance such as paint peeling, deformation, contamination, etc.)

## ■ Shockproof performance\*

This unit has passed the test where product is dropped from height of 76 cm (30") in the downward direction (2 surfaces, 8 side surfaces) on a piece of plywood that is 3 cm ( $1\frac{3}{16}$ " ) thick. (Corresponds to the fact that the device operates. Does not apply to items concerning change in appearance such as paint peeling and deformation of parts where collision occurred.)

## ■ Freezeproof/Heatproof performance\*

Performance is guaranteed under -10 °C to +50 °C (+14 °F to +122 °F) ambient temperature.

- For safety reasons, this device will automatically shutdown when it reaches a certain temperature level.

\* **Non-destruction, non-failure or splashproof is not guaranteed under all conditions.**

## ■ Cautions for using around water

Conform to following. Improper use may result in a malfunction.

- Securely close the terminal cover.
- Do not open or close the terminal cover with wet hands or when water droplets are on this unit. Doing so may cause malfunction such as terminal rusting with the water droplets.
- Do not connect and use a USB cable or an audio cable (not supplied).
- Do not pour soap water or detergent, or immerse in water.
- Remove any hair, lint, sand, dust, etc., that may be attached to the rubber seal on the terminal cover before closing.
- Leaving the device with water droplets in a cold region may result to malfunction such as the covers stuck closed.
- The sound may become smaller or warped when water is accumulated in the speaker or microphone of this unit. Wipe this unit with dry soft cloth.

- Water may accumulate inside the speaker of this unit. Tilt the set toward the water drain hole to drain water.

### The bottom of the unit

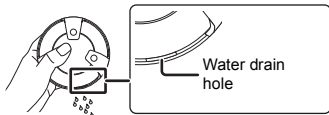

- If this product is routinely used outdoors, in a very humid environment, or in a manner that relies on the splash-proof durability of this product, the splash proof performance of the product is maintained for 2 years. Please contact Panasonic's service department for more information.
- When water enters inside this unit, stop using this unit, and contact the nearest Dealer or Service Center. Malfunction due to exposure to water by improper handling by the customer will not be covered by the warranty. Supplied accessories are not splashproof.

## About the power of this unit

This unit has a built-in battery. Please charge the battery before using this unit for the first time.

- If the battery level is low when this unit is turned on, the Battery indicator (red) (⇒ 5) blinks slowly.

### ■ Charging the battery

Connect this unit with the power turned off and the PC with the power turned on using the USB cable (supplied).

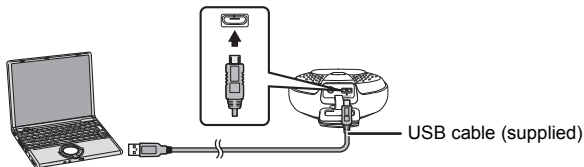

If charging is necessary, the Battery indicator (red) lights. When charging is complete, the Battery indicator goes off.

Battery life in use	Approx. 8 hours* <sup>1</sup>
Battery Charge time	Approx. 5 hours* <sup>2</sup>
Rechargeable times	About 500 times

\*<sup>1</sup> Calculated by the test method established by the company [while connecting with Bluetooth<sup>®</sup>, turning off Boost Mode (⇒ 11), using at the surrounding temperature of 25 °C (+77 °F)]

\*<sup>2</sup> When charging at the surrounding temperature of 25 °C (+77 °F) after the battery is depleted.

### ■ Using and charging with connecting to a PC turned on

Press [⏻/|] for turning on this unit. The Bluetooth<sup>®</sup> indicator (blue) blinks or lights, and it is possible to operate this unit with the supplied power from a PC.

- The volume may become smaller depending on the supplier performance when operating with USB connection. It is recommended to connect to a device with supply performance of 1.6 A or larger when full power playback with USB connection is required.
- It takes longer to charge while this unit is turned on.

### Note

- You may need to charge the battery before using this unit.
- Do not use any other USB cables except the supplied one. (Operation is not guaranteed.)
- Charge the battery at least once every 6 months.
- Communication is not possible when this unit is connected to a PC with the USB cable.
- Charging will not start if the battery level is sufficiently high even if it is not full.
- It is recommended to charge the battery in the temperature of between 5 °C and 35 °C (+41 °F and +95 °F). The Battery indicator (red) may flash and charging may not be possible when it is out of recommended temperature range.
- The battery may not charge when the temperature surrounding the battery is high during the operation or right after the operation even when it is within the recommended temperature range. In such case, stop the usage and let it cool down.
- To ensure safety, in the case of an excessive input signal, the system may be automatically interrupted and power is turned off.

# Listening to audio from a Bluetooth® device

## Preparation

While charging this unit or after charging this unit, turn on the Bluetooth® feature of the device and place the device near this unit.

If you intend to use an NFC (Near Field Communication)-compatible Bluetooth® device, proceed to “One-Touch Connection (Connecting by NFC)” (⇒ 9).

## Connecting via Bluetooth® menu

For each Bluetooth® device you want to connect to via Bluetooth®, perform pairing first.

### ■ Pairing with Bluetooth® device

#### 1 Press [⏻/⏻] to turn this unit on.

- The Bluetooth® indicator (blue) blinks slowly.
- If this unit is being used for the first time (factory preset state):  
The Bluetooth® indicator (blue) blinks fast. → The unit will enter pairing standby.  
→ Skip to step 3.

#### 2 Press and hold [ ] until the Bluetooth® indicator (blue) blinks fast.

- The unit will enter pairing standby.

#### 3 Select “SC-NT10” from the Bluetooth® device’s Bluetooth® menu.

- When the Bluetooth® device is paired and connected, the Bluetooth® indicator (blue) on the unit lights up.
- If prompted for a passkey, input “0000”.
- If the Bluetooth® device need to operate the Bluetooth® pairing setting and the Bluetooth® connecting setting, operate both settings.

#### 4 Start playing back music, a movie, etc. on your Bluetooth® device.

- Adjust the volume using the [VOL -/VOL +] buttons on the unit.  
When the maximum or minimum volume is reached, you will be notified by a beep sound.

### ■ Listening to audio from a paired device

When this unit is turned on, the Bluetooth® indicator (blue) will blink slowly indicating that the unit is in connection standby mode. Please perform Steps 3 and 4.

- When the power is turned on, this unit is connected to the last-used Bluetooth® device. At this point, please perform Step 4.



## One-Touch Connection (Connecting by NFC)

---

### For NFC-compatible Android™ devices only

By simply touching this unit to an NFC (Near Field Communication)-compatible Bluetooth® device, this unit automatically turns on, and performs the starting operation, from pairing the Bluetooth® device to establishing a connection. Designed to skip the starting operation, this feature is very convenient.

#### About NFC (Near Field Communication)

It is a short range wireless technology that makes use of interacting radio communications.

### Preparation

Turn on the NFC feature of the device. And connect the device to the internet to install a dedicated app. Separate data charges apply for the internet use.

- 1 Download the app “Panasonic Music Streaming” (free of charge) to your Bluetooth® device from Google Play™.**
    - Enter “Panasonic Music Streaming” in the search box of Google Play™ and search  
→ select “Panasonic Music Streaming” to download the app
  - 2 Start the app “Panasonic Music Streaming” on your Bluetooth® device.**
    - Follow on-screen instructions on your device.
    - Always use the latest version of the app.
  - 3 Touch and hold your device on the NFC touch area of this unit. (Until a pop-up window on your device indicates that the connection is established.)**
    - When this unit turns on and a connection is established, the Bluetooth® indicator (blue) lights up.
    - When the Bluetooth® indicator (blue) does not light up even if you have touched the NFC touch area, change the touching position.
  - 4 Start playing back music, a movie, etc. on your Bluetooth® device.**
- **Connecting to another device**  
If you touch another device to this unit, you can update the Bluetooth® connection. The previously connected device will be disconnected automatically.

## Selecting Transmission mode setting

---

You can change the transmission speed to prioritize sound quality or connectivity.

- The default setting is "Sound Quality Priority MODE". When the sound is interrupted, select "Connectivity Priority MODE".

### 1 Set either of the following modes.

- Sound Quality Priority MODE:  
**While pressing and holding [  ], press and hold [VOL -] until the Bluetooth® indicator (blue) and the Boost Mode indicator (orange) blink once.**
- Connectivity Priority MODE:  
**While pressing and holding [BOOST], press and hold [VOL -] until the Bluetooth® indicator (blue) and the Boost Mode indicator (orange) blink once.**

### 2 Press [/I] to turn this unit off, and press [/I] again to turn on.

- The Bluetooth® connection is automatically established, and the Bluetooth® indicator (blue) lights up.

## Disconnecting Bluetooth®

---

- Turn off this unit or the device.
- Stop / disable the Bluetooth® transmission of the device.
- (For NFC-compatible devices only)  
Touch and hold your device to NFC touch area of this unit again.

---

### Note

- This unit can only be connected to one device at a time.
- This unit can register up to 8 devices. If a 9th device is paired, the device that has not been used for the longest time will be replaced.
- Even when this unit is turned off, if this unit is connected to the PC that is powered on with an USB cable and this unit is selected on the device that is paired with this unit, power of this unit will be turned on and connected via Bluetooth® automatically.
- If the image and sound are out of sync during playback, restart the playback app you are using. If the problem persists, connect the Bluetooth® device and this unit with an audio cable.
- The One-Touch Connection may not work properly depending on the type of device being used.

## Using Boost Mode

It will make the sound played back on this unit easier to hear by boosting the level of specific frequency band.

**Press [BOOST] of this unit to switch the effect on/off.**

- The Boost Mode indicator (orange) lights up.

---

### Note



- If sound is distorted during playback, switch off the "Boost Mode".
- When saving the power consumption, set "Boost Mode" to "off".
- Location of this unit may move due to vibration.

## Using the AUX input

You can listen to the audio via AUX IN jack (⇒ 5) when this unit is connected to the device with the audio cable (not supplied).

---

### Note

- When using the AUX input, the Bluetooth® audio, NFC features, and [  ] are not available. (It will be possible to receive a call hands-free by pressing [  ] when there is a call coming in on the device connected with Bluetooth®. ⇒ 12)
- The setting of the Bluetooth® is not changed even if inserting the audio cable (not supplied) from AUX IN jack.
- When using the AUX input, the volume may seem low depending on the connected device. In that case, check if the volume limit can be changed on the device. For details, refer to the manual of the device.

## Auto Power Off

This unit automatically turns off if there is no audio input and no operation is performed for approximately 10 minutes.

---

### Note

- This function will not operate when the AUX input is used while connected with the USB cable.
- This function may operate even when the music is being played back if the volume of the connected device is low.
- This function may not operate depending on the connected device.

## Receiving a call with Hands-Free

If receiving a call on the mobile phone connected to this unit with Bluetooth<sup>®</sup>, you can make a hands-free call through this unit.

### Preparation

For connecting Bluetooth<sup>®</sup>, refer to “Connecting via Bluetooth<sup>®</sup> menu” (⇒ 8) or “One-Touch Connection (Connecting by NFC)” (⇒ 9).

### ■ Receiving a call

Press [  ] when this unit rings.

- When receiving the call, the Bluetooth<sup>®</sup> indicator (blue) on the unit blinks.
- Talk into the microphone (⇒ 5) on this unit.

### ■ Ending the call

Press [  ].



---

### Note

- Adjust the volume during a call with [VOL +] and [VOL -] on this unit.
- During a hands-free call, if you want to switch from this unit to the hands-free device, operate the hands-free device.
- If this unit receives a call while playing audio with Bluetooth<sup>®</sup>, it changes the audio to a ringtone automatically. In addition, during playback with the AUX IN jack, the audio of this unit automatically changes to a ringtone of the pairing device.
- If you touch other devices to the NFC touch area of this unit when receiving a call, Bluetooth<sup>®</sup> connection will not switch.
- To mute the ringtone of this unit, press [VOL -] until the volume reaches minimum.
- Some apps for the mobile phone may not be available for hands-free.

## To return to the factory preset state

Perform the following when you want to delete pairing device information, etc.

- 1 Press [] to turn the power on.
- 2 Press and hold [] for 10 seconds until Bluetooth<sup>®</sup> indicator (blue) and Boost Mode indicator (orange) blink twice.

The pairing device information will be deleted by the reset, so it will be necessary to perform pairing again. Delete the pairing information for this unit from the Bluetooth<sup>®</sup> device, then perform the pairing operation again. (See “Pairing with Bluetooth<sup>®</sup> device” ⇒ 8)

## Troubleshooting

Before requesting service, make the following checks.

If you are in doubt about some of the check points, or if the solutions indicated in the following guide do not solve the problem, refer to “Customer Services Directory (United States and Puerto Rico)” (⇒ 18) if you reside in the U.S.A. or Puerto Rico, or refer to “Limited Warranty (ONLY FOR CANADA)” (⇒ 19) if you reside in Canada.

---

### **Sound from the device is cut off.**

- The device is out of the 10 m (33 ft.) communication range. Move the device nearer to this unit. (See “About Bluetooth®” ⇒ 15)
  - Remove any obstacle between this unit and the device.
  - Switch off any wireless LAN device.
  - Select “Connectivity Priority MODE” for stable communication. (See “Selecting Transmission mode setting” ⇒ 10)
- 

### **The device cannot be connected.**

- Refer to the operating instructions of the device, and perform the pairing operation again. (See “Pairing with Bluetooth® device” ⇒ 8)
  - Make sure that this unit is not connected to a different device.
- 

### **The device is connected but audio cannot be heard from this unit.**

- For some built-in Bluetooth® devices, you have to set the audio output to “SC-NT10” manually. Read the operating instructions of the device for details.
- 

### **This unit is not operating correctly. For example, this unit turns off all of a sudden or all indicator blink.**

- A problem has occurred. Turn off this unit, disconnect USB cable and press [RESET] (⇒ 5).
- 

### **The One-Touch Connection (NFC feature) is not working.**

- Turn on the NFC feature of the device.
- 

### **Volume is low when this unit is connected to a TV via Bluetooth®.**

- Adjust the volume on the TV. The volume of headphone output may be coupled with the volume of the Bluetooth® output depending on the TV. In such case, adjust the volume of the headphone output on the TV.
-

# Specifications

## Amplifier section

### Output power

#### RMS Output Power

10 % total harmonic distortion

Front ch (both ch driven):

2 W per channel (1 kHz, 6 Ω, Boost Mode)

Total RMS power:

4 W

#### FTC Output Power

1.0 % total harmonic distortion

Front ch (both ch driven):

110 Hz – 20 kHz 1.4 W per channel  
(6 Ω, Boost Mode)

Total FTC power:

2.8 W

## Speaker section

### Front Speaker (L/R)

Type:

1 way 1 speaker system

Unit(s):

φ 34 mm (1 3/8")

Impedance:

6 Ω

### Passive Radiator:

φ 50 mm (2")

## Bluetooth® section

Bluetooth® system specification:

Bluetooth® Ver. 3.0

Wireless equipment classification:

Class 2 (2.5 mW)

Supported profiles:

A2DP/AVRCP/HFP

Supported codec:

SBC

Frequency band:

2.4 GHz band FH-SS

Operating distance:

Approx. 10 m (33 ft.) Line of Sight

Prospective communication distance.

Measurement environment:

Height 1.0 m (3.3 ft.)

## Microphone section

Type:

Mono

## Terminals section

DC IN:

USB Micro Type B

AUX input:

Stereo 3.5 mm (1/8") jack

## General

Power supply:

DC IN 5 V 0.6 A

Internal Battery 3.6 V (NiMH 1500 mAh)

Battery Life in Use:

Approx. 8 h (Normal Mode, Bluetooth®)

Approx. 1.5 h (Boost Mode, Bluetooth®)

Battery Charge Time:

Approx. 5 h

Dimensions (W × H × D):

120 mm × 53.8 mm × 120 mm  
(4 23/32" × 2 1/8" × 4 23/32")

Mass (Weight):

Approx. 330 g (0.73 lbs)

Operating temperature range:

-10 °C to +50 °C (+14 °F to +122 °F)

Operating humidity range:

35% to 80% RH (no condensation)

Splash Proof:

IPX4 equivalent

Shock Proof:

76 cm (30") Drop

## Note

- Specifications are subject to change without notice. Mass and dimensions are approximate.
- Total harmonic distortion is measured by a digital spectrum analyzer.

## Notes on Speakers

- Decrease the volume when the audio is distorted.

## About Bluetooth®

Panasonic bears no responsibility for data and/or information that is compromised during a wireless transmission.

### Frequency band used

This unit uses the 2.4 GHz frequency band.

### Certification of this device

- This unit conforms to frequency restrictions and has received certification based on frequency laws. Thus, a wireless permit is not necessary.
- The actions below are punishable by law in some countries:
  - Taking apart/modifying the unit.
  - Removing specification indications.

### Restrictions of use

- Wireless transmission and/or usage with all Bluetooth® equipped devices is not guaranteed.
- All devices must conform to standards set by Bluetooth SIG, Inc.
- Depending on the specifications and settings of a device, it can fail to connect or some operations can be different.
- This system supports Bluetooth® security features. But depending on the operating environment and/or settings, this security is possibly not sufficient. Transmit data wirelessly to this system with caution.
- This system cannot transmit data to a Bluetooth® device.

### Range of use

Use this device at a maximum range of 10 m (33 ft). The range can decrease depending on the environment, obstacles or interference.

### Interference from other devices

- This unit may not function properly and troubles such as noise and sound jumps may arise due to radio wave interference if this unit is located too close to other Bluetooth® devices or the devices that use the 2.4 GHz band.
- This unit may not function properly if radio waves from a nearby broadcasting station, etc. is too strong.

### Intended usage

- This unit is for normal, general use only.
- Do not use this system near an equipment or in an environment that is sensitive to radio frequency interference (example: airports, hospitals, laboratories, etc).

## Licenses

- Android and Google Play are trademarks of Google Inc.
- The Bluetooth® word mark and logos are owned by the Bluetooth SIG, Inc. and any use of such marks by Panasonic Corporation is under license. Other trademarks and trade names are those of their respective owners.

### -If you see this symbol-

#### Information on Disposal in other Countries outside the European Union



This symbol is only valid in the European Union.

If you wish to discard this product, please

contact your local authorities or dealer and ask for the correct method of disposal.

## To remove the battery when disposing of this unit

The following instructions are not intended for repairing purposes but for the disposal of this unit. This unit is not restorable once disassembled.

When disposing of this unit, take out the battery installed in this unit and recycle it.

- Use up the battery before disassembling. (For Cautions of the battery ⇒ 2)
- Keep the rubber sheets and the screws out of reach of children to prevent swallowing.

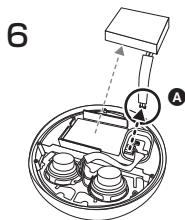
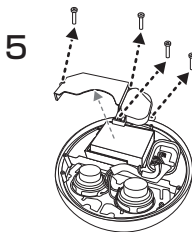
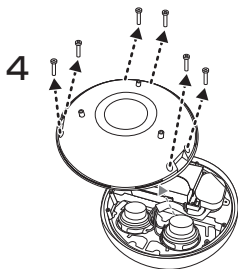
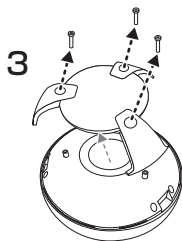
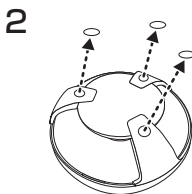
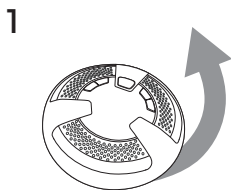

- Insulate the **A** with cellophane tape or similar.
- Do not disassemble the battery.



# Limited Warranty (ONLY FOR U.S.A. AND PUERTO RICO)

## Panasonic Products Limited Warranty

### Limited Warranty Coverage (For USA and Puerto Rico Only)

If your product does not work properly because of a defect in materials or workmanship, Panasonic Consumer Marketing Company of North America (referred to as "the warrantor") will, for the length of the period indicated on the chart below, which starts with the date of original purchase ("warranty period"), at its option either (a) repair your product with new or refurbished parts, (b) replace it with a new or a refurbished equivalent value product, or (c) refund your purchase price. The decision to repair, replace or refund will be made by the warrantor.

Product or Part Name	Parts	Labor
Wireless Speaker System	1 Year	1 Year
All included Accessories (Except Non-Rechargeable Batteries)	90 Days	Not Applicable
Only Non-Rechargeable Batteries	10 Days	Not Applicable

During the "Labor" warranty period there will be no charge for labor. During the "Parts" warranty period, there will be no charge for parts. This Limited Warranty excludes both parts and labor for non-rechargeable batteries, antennas, and cosmetic parts (cabinet). This warranty only applies to products purchased and serviced in the United States or Puerto Rico. This warranty is extended only to the original purchaser of a new product which was not sold "as is".

### Mail-In Service--Online or Telephone Repair Request

#### Online Repair Request

To submit a new repair request and for quick repair status visit our Web Site at [www.panasonic.com/repair](http://www.panasonic.com/repair).

#### Telephone Repair Request

You may contact us at : 1-800-211-PANA (7262)

When shipping the unit, carefully pack, include all supplied accessories listed in the Owner's Manual, and send it prepaid, adequately insured and packed well in a carton box. When shipping Lithium Ion batteries please visit our Web Site at [www.panasonic.com/BatteryHandling](http://www.panasonic.com/BatteryHandling) as Panasonic is committed to providing the most up to date information. Include a letter detailing the complaint, a return address and provide a daytime phone number where you can be reached. A valid registered receipt is required under the Limited Warranty.

**IF REPAIR IS NEEDED DURING THE WARRANTY PERIOD, THE PURCHASER WILL BE REQUIRED TO FURNISH A SALES RECEIPT/PROOF OF PURCHASE INDICATING DATE OF PURCHASE, AMOUNT PAID AND PLACE OF PURCHASE. CUSTOMER WILL BE CHARGED FOR THE REPAIR OF ANY UNIT RECEIVED WITHOUT SUCH PROOF OF PURCHASE.**

### Limited Warranty Limits And Exclusions

This warranty ONLY COVERS failures due to defects in materials or workmanship, and DOES NOT COVER normal wear and tear or cosmetic damage. The warranty ALSO DOES NOT COVER damages which occurred in shipment, or failures which are caused by products not supplied by the warrantor, or failures which result from accidents, misuse, abuse, neglect, mishandling, misapplication, alteration, faulty installation, set-up adjustments, misadjustment of consumer controls, improper maintenance, power line surge, lightning damage, modification, introduction of sand, humidity or liquids, commercial use such as hotel, office, restaurant, or other business or rental use of the product, or service by anyone other than a Factory Service Center or other Authorized Servicer, or damage that is attributable to acts of God.

**THERE ARE NO EXPRESS WARRANTIES EXCEPT AS LISTED UNDER "LIMITED WARRANTY COVERAGE". THE WARRANTOR IS NOT LIABLE FOR INCIDENTAL OR CONSEQUENTIAL DAMAGES RESULTING FROM THE USE OF THIS PRODUCT, OR ARISING OUT OF ANY BREACH OF THIS WARRANTY.**

(As examples, this excludes damages for lost time, travel to and from the servicer, loss of or damage to media or images, data or other memory or recorded content. The items listed are not exclusive, but for illustration only.)

**ALL EXPRESS AND IMPLIED WARRANTIES, INCLUDING THE WARRANTY OF MERCHANTABILITY, ARE LIMITED TO THE PERIOD OF THE LIMITED WARRANTY.**

Some states do not allow the exclusion or limitation of incidental or consequential damages, or limitations on how long an implied warranty lasts, so the exclusions may not apply to you.

This warranty gives you specific legal rights and you may also have other rights which vary from state to state. If a problem with this product develops during or after the warranty period, you may contact your dealer or Service Center. If the problem is not handled to your satisfaction, then write to the warrantor's Consumer Affairs Department at the addresses listed for the warrantor.

**PARTS AND SERVICE, WHICH ARE NOT COVERED BY THIS LIMITED WARRANTY, ARE YOUR RESPONSIBILITY.**

**Customer Services Directory (United States and Puerto Rico)**

**Obtain Product Information and Operating Assistance; locate your nearest Dealer or Service Center; purchase Parts and Accessories; or make Customer Service and Literature requests by visiting our Web Site at:**  
<http://www.panasonic.com/help>  
**or, contact us via the web at:**

<http://www.panasonic.com/contactinfo>

You may also contact us directly at:  
1-800-211-PANA (7262)  
Monday-Friday 9am-9pm,  
Saturday-Sunday 10am-7pm EST

**For hearing or speech impaired TTY users,  
TTY: 1-877-833-8855**

**Accessory Purchases (United States and Puerto Rico)**

Purchase Parts, Accessories and Instruction Books online for all Panasonic Products by visiting our Web Site at:

<http://www.pstc.panasonic.com>

Or, send your request by E-mail to:  
[nccparts@us.panasonic.com](mailto:nccparts@us.panasonic.com)

You may also contact us directly at:  
1-800-332-5368 (Phone) 1-800-237-9080  
(Fax Only)

(Monday-Friday 9am-9pm EST)  
Panasonic National Parts Center  
20421 84th Ave S., Kent, WA 98032  
(We accept Visa, MasterCard, Discover Card, American Express)

**For hearing or speech impaired TTY users,  
TTY: 1-866-605-1277**

As of May 2013

The model number and serial number of this product can be found on either the back or the bottom of the unit.

Please note them in the space provided below and keep for future reference.

MODEL NUMBER SC-NT10

SERIAL NUMBER \_\_\_\_\_

User memo:

DATE OF PURCHASE \_\_\_\_\_

DEALER NAME \_\_\_\_\_

DEALER ADDRESS \_\_\_\_\_

TELEPHONE NUMBER \_\_\_\_\_

# Limited Warranty (ONLY FOR CANADA)

Panasonic Canada Inc.  
5770 Ambler Drive, Mississauga, Ontario L4W 2T3

## PANASONIC PRODUCT - LIMITED WARRANTY EXCHANGE PROGRAM

Panasonic Canada Inc. warrants this product to be free from defects in material and workmanship under normal use and for a period as stated below from the date of original purchase agrees to, at its option either (a) repair your product with new or refurbished parts, (b) replace it with a new or a refurbished equivalent value product, or (c) refund your purchase price. The decision to repair, replace or refund will be made by Panasonic Canada Inc.

Panasonic Portable / Clock Radio (without Tape, CD, MD)	One (1) year
Panasonic Audio Product	One (1) year
Panasonic DVD Product	One (1) year
Accessories including rechargeable batteries	Ninety (90) days

This warranty is given only to the original purchaser, or the person for whom it was purchased as a gift, of a Panasonic brand product mentioned above sold by an authorized Panasonic dealer in Canada and purchased and used in Canada, which product was not sold "as is", and which product was delivered to you in new condition in the original packaging.

**IN ORDER TO BE ELIGIBLE TO RECEIVE WARRANTY SERVICE HEREUNDER, A PURCHASE RECEIPT OR OTHER PROOF OF DATE OF ORIGINAL PURCHASE, SHOWING AMOUNT PAID AND PLACE OF PURCHASE IS REQUIRED**

### LIMITATIONS AND EXCLUSIONS

This warranty ONLY COVERS failures due to defects in materials or workmanship, and DOES NOT COVER normal wear and tear or cosmetic damage. The warranty ALSO DOES NOT COVER damages which occurred in shipment, or failures which are caused by products not supplied by Panasonic Canada Inc., or failures which result from accidents, misuse, abuse, neglect, mishandling, misapplication, alteration, faulty installation, set-up adjustments, misadjustment of consumer controls, improper maintenance, power line surge, lightning damage, modification, introduction of sand, humidity or liquids, commercial use such as hotel, office, restaurant, or other business or rental use of the product, or service by anyone other than an Authorized Servicer, or damage that is attributable to acts of God.

Dry cell batteries are also excluded from coverage under this warranty.

THIS EXPRESS, LIMITED WARRANTY IS IN LIEU OF ALL OTHER WARRANTIES, EXPRESS OR IMPLIED, INCLUDING ANY IMPLIED WARRANTIES OF MERCHANTABILITY AND FITNESS FOR A PARTICULAR PURPOSE. IN NO EVENT WILL PANASONIC CANADA INC. BE LIABLE FOR ANY SPECIAL, INDIRECT OR CONSEQUENTIAL DAMAGES RESULTING FROM THE USE OF THIS PRODUCT OR ARISING OUT OF ANY BREACH OF ANY EXPRESS OR IMPLIED WARRANTY. (As examples, this warranty excludes damages for lost time, travel to and from the Authorized Servicer, loss of or damage to media or images, data or other memory or recorded content. This list of items is not exhaustive, but for illustration only.)

In certain instances, some jurisdictions do not allow the exclusion or limitation of incidental or consequential damages, or the exclusion of implied warranties, so the above limitations and exclusions may not be applicable. This warranty gives you specific legal rights and you may have other rights which vary depending on your province or territory.

### CONTACT INFORMATION

For product information and operation assistance, please contact:

Our Customer Care Centre: Telephone #: 1-800-561-5505  
Fax #: (905) 238-2360

For defective product exchange within the warranty period, please contact the original dealer or our Customer Care Centre.

USA Only: Disposal may be regulated in your community due to environmental considerations. For disposal or recycling information, please visit Panasonic website:

<http://www.panasonic.com/environmental/>  
or call 1-888-769-0149.

---

Panasonic Consumer Marketing  
Company of North America,  
Division of Panasonic Corporation  
of North America

One Panasonic Way, Secaucus,  
New Jersey 07094

<http://www.panasonic.com>

© Panasonic Corporation 2013  
Printed in Malaysia

Panasonic Canada Inc.

5770 Ambler Drive  
Mississauga, Ontario  
L4W 2T3

[www.panasonic.ca](http://www.panasonic.ca)



VQT5A86  
F0613HA0