

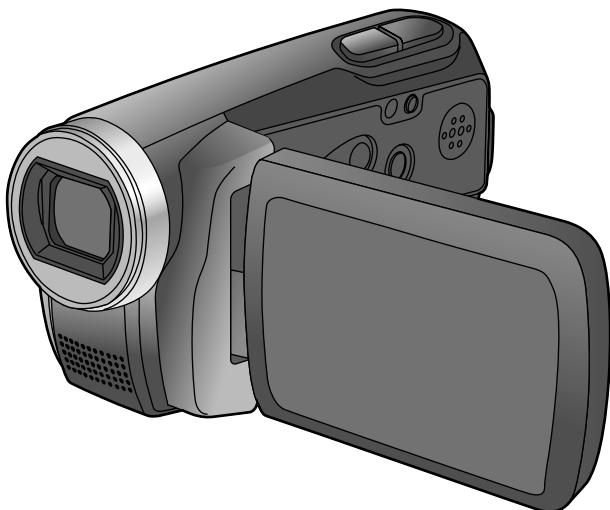

Panasonic[®]

Operating Instructions
SD Video Camera

Model No. **SDR-S7P/PC**



Before connecting, operating or adjusting this product, please read the instructions completely.
Spanish Quick Use Guide is included.
Guía para rápida consulta en español está incluida.

For USA assistance, please call: 1-800-211-PANA(7262) or, contact us via the web at:
<http://www.panasonic.com/contactinfo>

For Canadian assistance, please call: 1-800-561-5505 or visit us at www.panasonic.ca

VQT1R00-1

Things You Should Know

Thank you for choosing Panasonic!

You have purchased one of the most sophisticated and reliable products on the market today. Used properly, we're sure it will bring you and your family years of enjoyment. Please take time to fill in the information on the right. Be sure to **retain this manual** as your convenient camera information source.

Date of Purchase _____

Dealer Purchased From _____

Dealer Address _____

Dealer Phone No. _____

Model No. _____

Serial No. _____

Safety Precautions

WARNING:

TO REDUCE THE RISK OF FIRE, ELECTRIC SHOCK OR PRODUCT DAMAGE,

- DO NOT EXPOSE THIS APPARATUS TO RAIN, MOISTURE, DRIPPING OR SPLASHING AND THAT NO OBJECTS FILLED WITH LIQUIDS, SUCH AS VASES, SHALL BE PLACED ON THE APPARATUS.
- USE ONLY THE RECOMMENDED ACCESSORIES.
- DO NOT REMOVE THE COVER (OR BACK); THERE ARE NO USER SERVICEABLE PARTS INSIDE. REFER SERVICING TO QUALIFIED SERVICE PERSONNEL.

CAUTION!

DO NOT INSTALL OR PLACE THIS UNIT IN A BOOKCASE, BUILT-IN CABINET OR IN ANOTHER CONFINED SPACE. ENSURE THE UNIT IS WELL VENTILATED. TO PREVENT RISK OF ELECTRIC SHOCK OR FIRE HAZARD DUE TO OVERHEATING, ENSURE THAT CURTAINS AND ANY OTHER MATERIALS DO NOT OBSTRUCT THE VENTILATION VENTS.

WARNING

- AS WITH ANY SMALL OBJECT, SD CARDS CAN BE SWALLOWED BY YOUNG CHILDREN. DO NOT ALLOW CHILDREN TO HANDLE THE SD CARD.

THE FOLLOWING APPLIES ONLY IN THE U.S.A.

FCC Note: This equipment has been tested and found to comply with the limits for a Class B digital device, pursuant to Part 15 of the FCC Rules. These limits are designed to provide reasonable protection against harmful interference in a residential installation. This equipment generates, uses, and can radiate radio frequency energy and, if not installed and used in accordance with the instructions, may cause harmful interference to radio communications. However, there is no guarantee that interference will not occur in a particular installation. If this equipment does cause harmful interference to radio or television reception, which can be determined by turning the equipment off and on, the user is encouraged to try to correct the interference by one or more of the following measures:

- Reorient or relocate the receiving antenna.
- Increase the separation between the equipment and receiver.
- Connect the equipment into an outlet on a circuit different from that to which the receiver is connected.
- Consult the dealer or an experienced radio/TV technician for help.

FCC Caution: To assure continued compliance, follow the attached installation instructions and use only shielded interface cables with ferrite core when connecting to computer or peripheral devices.

Any changes or modifications not expressly approved by the party responsible for compliance could void the user's authority to operate this equipment.

Declaration of Conformity

Trade Name: Panasonic

Model No.: SDR-S7P

Responsible party: Panasonic Corporation of North America
One Panasonic Way, Secaucus, NJ 07094

Support Contact: Panasonic Consumer Electronics Company
1-800-211-PANA (7262)

This device complies with Part 15 of the FCC Rules. Operation is subject to the following two conditions: (1) This device may not cause harmful interference, and (2) this device must accept any interference received, including interference that may cause undesired operation.



THE FOLLOWING APPLIES ONLY IN CANADA

This Class B digital apparatus complies with Canadian ICES-003.

IMPORTANT SAFETY INSTRUCTIONS

Read these operating instructions carefully before using the unit. Follow the safety instructions on the unit and the applicable safety instructions listed below. Keep these operating instructions handy for future reference.

- 1) Read these instructions.
- 2) Keep these instructions.
- 3) Heed all warnings.
- 4) Follow all instructions.
- 5) Do not use this apparatus near water.
- 6) Clean only with dry cloth.
- 7) Do not block any ventilation openings. Install in accordance with the manufacturer's instructions.
- 8) Do not install near any heat sources such as radiators, heat registers, stoves, or other apparatus (including amplifiers) that produce heat.
- 9) Do not defeat the safety purpose of the polarized or grounding-type plug. A polarized plug has two blades with one wider than the other. A grounding-type plug has two blades and a third grounding prong. The wide blade or the third prong are provided for your safety. If the provided plug does not fit into your outlet, consult an electrician for replacement of the obsolete outlet.
- 10) Protect the power cord from being walked on or pinched particularly at plugs, convenience receptacles, and the point where they exit from the apparatus.
- 11) Only use attachments/accessories specified by the manufacturer.
- 12) Use only with the cart, stand, tripod, bracket, or the table specified by the manufacturer, or sold with the apparatus. When a cart is used, use caution when moving the cart/apparatus combination to avoid injury from tip-over.
- 13) Unplug this apparatus during lightning storms or when unused for long periods of time.
- 14) Refer all servicing to qualified service personnel.
Servicing is required when the apparatus has been damaged in any way, such as power-supply cord or plug is damaged, liquid has been spilled or objects have fallen into the apparatus, the apparatus has been exposed to rain or moisture, does not operate normally, or has been dropped.



Battery

Battery pack (Lithium ion battery pack)

- Use the specified unit to recharge the battery pack.
- Do not use the battery pack with equipment other than the specified unit.
- Do not get dirt, sand, liquids, or other foreign matter on the terminals.
- Do not touch the plug terminals (+ and -) with metal objects.
- Do not disassemble, remodel, heat or throw into fire.

If any electrolyte should come into contact with your hands or clothes, wash it off thoroughly with water.

If any electrolyte should come into contact with your eyes, never rub the eyes. Rinse eyes thoroughly with water, and then consult a doctor.

Warning

Risk of fire, explosion and burns. Do not disassemble, heat above 60 °C (140 °F) or incinerate.

AC adaptor

This AC adaptor operates on AC between 110 V and 240 V.

But

- In the U.S.A. and Canada, the AC adaptor must be connected to a 120 V AC power supply only.
- When connecting to an AC supply outside of the U.S.A. or Canada, use a plug adaptor to suit the AC outlet configuration.
- When connecting to a supply of greater than AC 125 V, ensure the cord you use is suited to the voltage of the AC supply and the rated current of the AC adaptor.
- Contact an electrical parts distributor for assistance in selecting a suitable AC plug adaptor or AC cord set.

The socket outlet shall be installed near the equipment and easily accessible. The mains plug of the power supply cord shall remain readily operable. To completely disconnect this apparatus from the AC Mains, disconnect the power supply cord plug from AC receptacle.

U.S.A./CANADA CONSUMERS: ATTENTION:



A lithium ion/polymer battery that is recyclable powers the product you have purchased. Please call 1-800-8-BATTERY for information on how to recycle this battery.

PRECAUTIONS

■ USE & LOCATION

WARNING

● TO AVOID SHOCK HAZARD...

Your camera and power supply should not be exposed to rain or moisture. Your camera has been designed for outdoor use, however accessories are not designed to sustain direct exposure to water, rain, sleet, snow, sand, dust, or a direct splashing from a pool or even a cup of coffee. This action could permanently damage the internal parts. Do not attempt to disassemble this unit. There are no user serviceable parts inside. Unplug your camera from the power supply before cleaning.

CAUTION

- DO NOT AIM YOUR CAMERA AT THE SUN OR OTHER BRIGHT OBJECTS
- DO NOT EXPOSE YOUR CAMERA TO EXTENDED HIGH TEMPERATURE...

Such as, in direct sunlight, inside a closed car, next to a heater, etc... This action could permanently damage the internal parts of your camera.

- AVOID SUDDEN CHANGES IN TEMPERATURE...

If the unit is suddenly moved from a cold place to a warm place, moisture may form on the SD card and inside the unit.

- DO NOT LEAVE YOUR CAMERA OR THE POWER SUPPLY TURNED ON WHEN NOT IN USE.
- STORAGE OF YOUR CAMERA...

Store and handle your camera in a manner that will not subject it to unnecessary movement (avoid shaking and striking). Your camera contains a sensitive pick-up device which could be damaged by improper handling or storage.

■ CARE

- TO CLEAN YOUR CAMERA...

Do not use strong or abrasive detergents when cleaning your camera body.

- TO PROTECT THE LENS...

Do not touch the surface of the lens with your hand. Use a commercial camera lens solution and lens paper when cleaning the lens. Improper cleaning can scratch the lens coating.

- TO PROTECT THE FINISH OF YOUR CAMERA...

Before handling your camera, make sure your hands and face are free from any chemical products, such as suntan lotion, as it may damage the finish.

■ Camera and SD card (sold separately) temperature

After use and battery charging, the battery will be hot. Also, during use, although the unit's body and SD card become hot, there is nothing wrong with the unit.

■ IMPORTANT

● Carefully observe copyright laws

Whatever you have recorded and created can be used for your personal entertainment only. Under copyright laws, other materials cannot be used without obtaining permission from the holders of the copyrights.

● Indemnity concerning recording content

The manufacturer shall in no event be liable for the loss of recordings due to malfunction or defect of this unit, its accessories or recordable media.

■ For the purposes of these operating instructions

SD Memory Card and SDHC Memory Card are referred to as the "SD card".

■ LCD monitor

Due to limitations in LCD production technology, there may be some tiny bright or dark spots on the LCD monitor screen. However, this is not a malfunction and does not affect the recorded picture.

-If you see this symbol-



Information on Disposal in other Countries outside the European Union

This symbol is only valid in the European Union.
If you wish to discard this product, please contact your local authorities or dealer and ask for the correct method of disposal.

- SDHC Logo is a trademark.
- miniSD Logo is a trademark.
- Manufactured under license from Dolby Laboratories.
Dolby and the double-D symbol are trademarks of Dolby Laboratories.
- Microsoft®, Windows® and DirectX® are either registered trademarks or trademarks of the Microsoft Corporation in the United States and/or other countries.
- IBM and PC/AT are registered trademarks of International Business Machines Corporation of the U.S.
- Celeron®, Intel®, Intel® Core™ Solo and Pentium® are the registered trademarks or trademarks of the Intel Corporation in the United States and other countries.
- Apple and MacOS are trademarks of Apple Inc.
- Microsoft product screen shot(s) reprinted with permission from Microsoft Corporation.
- Other names of systems and products mentioned in these instructions are usually the registered trademarks or trademarks of the manufacturers who developed the system or product concerned.

Contents

Before using

PRECAUTIONS	6
Quick guide	10
Accessories	14
Parts identification and handling	14
Using the hand strap (supplied)	16
Using the LCD monitor	17
How to use the lens cover open lever	17
Applicable SD cards (sold separately)	18

Setup

Charging	20
Charging time, recordable time and Remaining battery capacity indication	22
Inserting/Removing SD cards (sold separately)	23
Turning power ON/OFF (Selecting modes)	24
Quick starts	25
Setting from the menu, changing the display language	26
Setting the date and time and adjusting the LCD monitor	28

Recording

Before recording	30
Basic stance	30
Automatic recording (motion pictures)	32
Recording mode and recording times.....	33
Automatic recording (still pictures)	34
Picture quality.....	35

Zoom/avoid jitter/maintain picture brightness in dark locations	36
Other recording options	38
Fade-in/Fade-out.....	39
Backlight compensation function.....	40
Self-timer	40
Soft skin mode	41
MagicPix function	41
PRE-REC function	42
Self-portrait recording function.....	43
Recording manually (motion/still pictures)	44
Adjusting focus manually (manual focus adjustment).....	44
Using situation-specific settings (scene mode)	45
Achieve natural colors (white balance).....	46
Adjusting shutter speed (shutter speed)	48
Adjusting brightness (iris/gain)	49
Useful functions	50
Recording dates and times at travel destinations (set world time).....	50
View slants and composition (guide lines).....	51
Avoid wind noise (wind noise reduction function)..	51

Playback

Viewing motion pictures	52
Displaying thumbnails by date ..	53
Fast forward/rewind playback ..	54
Slow-motion playback	54
Frame-by-frame playback	54
Resuming the previous playback	54
Viewing still pictures	55

Editing

Deleting motion/still pictures ..	56
Deleting one picture at a time ..	56
Deleting all pictures	57
Selecting and deleting multiple pictures	57
Preventing accidental deletion of motion/still pictures	
Formatting cards	58
Setting DPOF for still pictures ..	59

With other products

Playback on TV	60
Copying to video recorders or DVD recorders	61
Printing pictures from PictBridge printers	62
Using DVD burners (sold separately)	64

With a computer

Software on the CD-ROM	70
End User License Agreement ..	71
Operating environment	72
Installing MotionSD STUDIO ...	74
Using MotionSD STUDIO	76
Using this unit as an external drive (Mass storage)	78
Checking the connections	80
Connecting to a Macintosh computer	81

Others

Menus	82
Recording menu	82
Playback menu	82
SETUP menu	85
LCD monitor displays	86
When recording	86
During playback	87
Messages	88
Troubleshooting	90
Cautions for use	96
Specifications	100
Optional accessories	102
Accessory Order Form (For USA Customers)	103
Request for Service Notice (USA Only)	104
Customer Services Directory (For USA only)	105
Limited Warranty (For USA Customers)	106
Warranty (For Canadian Customers)	108
Index	109
Spanish Quick Use Guide/ Guía española para el uso rápido	110

Quick guide

Charging

- 1 Set the mode dial to [OFF].

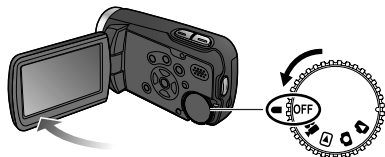

- 2 Open the card/battery door.
Open the door by sliding the card/battery door lever to the "OPEN" position.

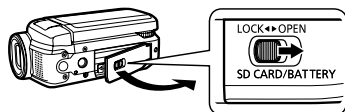

- 3 Insert the battery.

Inserting SD cards (sold separately)

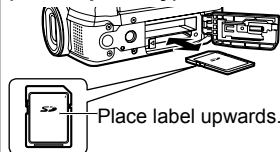

Place label upwards.

Slide straight in until hearing card catch.

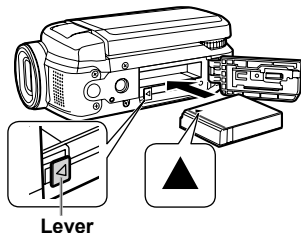

Lever

Press until hearing lever lock.

- 4 Close the card/battery door.
Close the card/battery door and slide the card/battery door lever to the "LOCK" position.

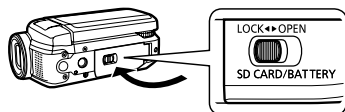

- 5 Connect the AC adaptor
(supplied).

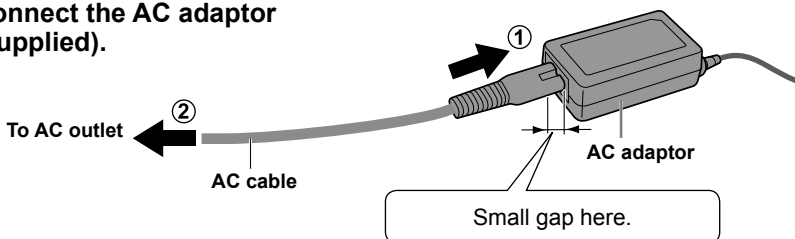

6 Open the terminal cover.



7 Plug the DC plug into the DC input terminal on the unit.

Status indicator
Flashing red: Charging in progress
Off: Charging complete

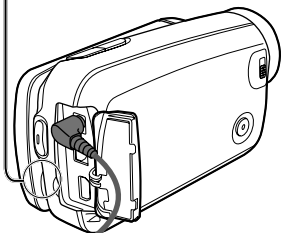

Setting the date and time

1 Set the mode dial to a position other than [OFF].

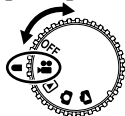

2 Select [YES].

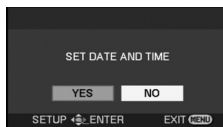
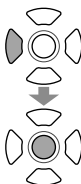

3 Set the date and time.



To select settings



To change numerical values



4 Enter the date and time.



- This procedure is for setting the date and the time the very first time. For the setting procedure for the second and subsequent times (P.28).

Quick guide (cont.)

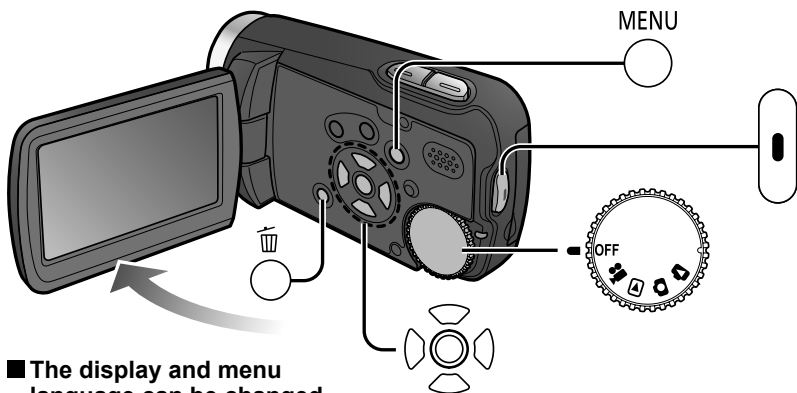

■ The display and menu language can be changed

➔ MENU → [LANGUAGE]

Recording

Motion pictures

1 Set to [🎥].

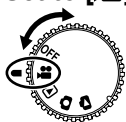

2 Start recording.



3 Stop recording.



Still pictures

1 Set to [📷].

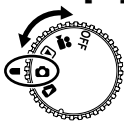

2 Take picture.



Playback

▶ Motion pictures

- 1 Set to [▶].

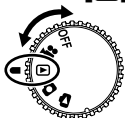

- 2 Select and enter the picture to view.



Play/Pause

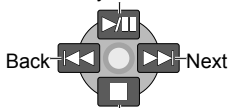

Return to step 2

▶ Still pictures

- 1 Set to [▶].

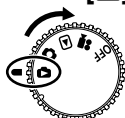

- 2 Select and enter the picture to view.

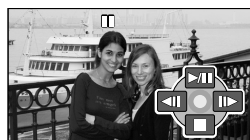

Slideshow start/pause

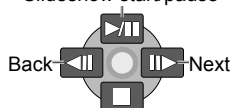

Return to step 2

Deleting pictures

- 1 During playback



(LCD monitor display in motion picture viewing)

- 2 Select [YES].

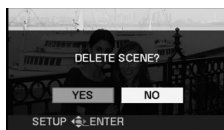
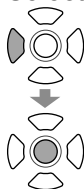

Accessories

Make sure all of the following accessories were included in the product package.

- Battery pack
VW-VBJ10

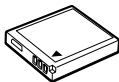

- AC adaptor
VSK0694



- AC cable
K2CA2CA00025



- AV cable
K2KZ9CB00002

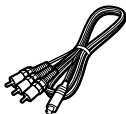

- Hand strap
VFC4308



- USB cable
K2KZ4CB00011



- CD-ROM



Parts identification

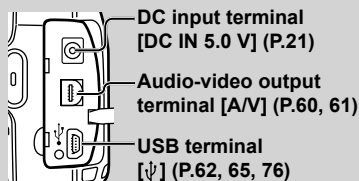

- Do not use any other AC adaptors except the supplied one.

Card access lamp [ACCESS] (P.23, 31)

Card/battery door lever
[LOCK ◀ ▶ OPEN] (P.20, 23)

Card/Battery door
(P.20, 23)

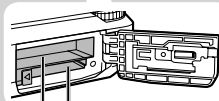
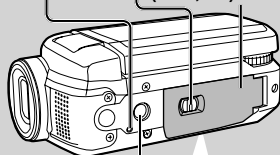

Card slot
[SD CARD]
(P.23)

Battery slot
[BATTERY] (P.20)

Tripod mounting hole

For tripod (sold separately) mounting instructions, see the user's guide of the tripod. (With some tripods, the card/battery door cannot be opened when the unit is mounted on the tripod. In such case, insert the SD card and battery before mounting the unit on the tripod.)

and handling

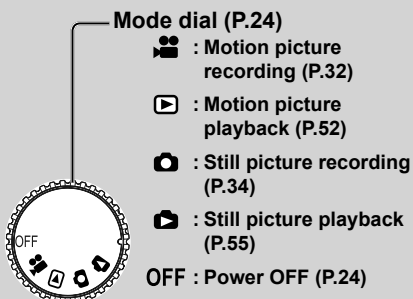
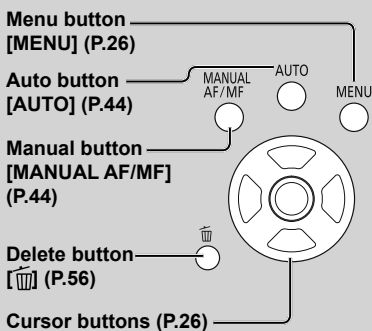
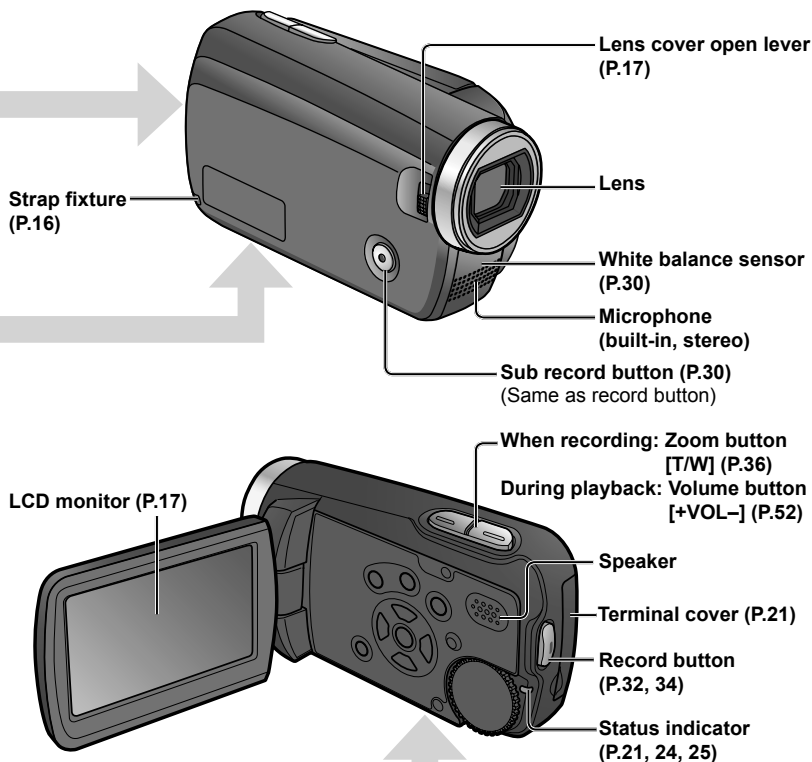

Parts identification and handling (cont.)

Using the hand strap (supplied)

■ Using as strap

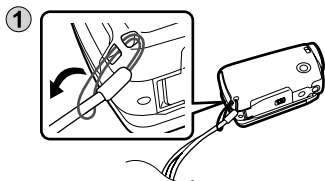

- ② Fit over your wrist and adjust the length of the strap.

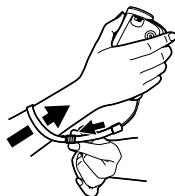

Using the LCD monitor

Images can be checked on the LCD monitor when recording.

① Open the LCD monitor.

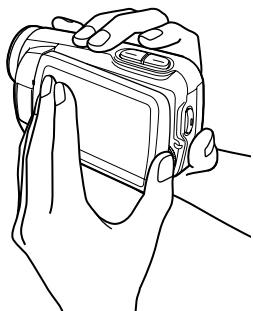

② Adjust the angle.

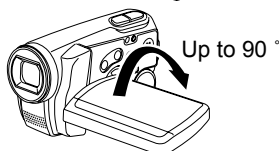
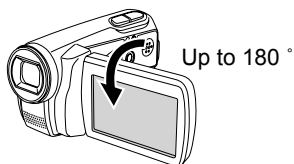

- Forcing the LCD monitor open or rotating it past the angle to which it can be rotated will cause trouble or malfunctioning.
- Brightness and color density can be adjusted. (P.29)

How to use the lens cover open lever

Before recording, open the lens cover.

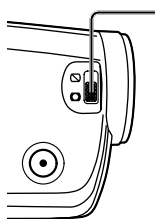

Open the lens cover by sliding the lens cover open lever to the [O] position.

- In order to protect the lens, slide the lens cover open lever to the [L] position when the unit is not in use, and close the lens cover.

Applicable SD cards (sold separately)

The following SD and SDHC Memory Cards can be used.

Type of card	Capacity
SD Memory Card (SD speed Class 2 or higher recommended)	256 MB
	512 MB
	1 GB
	2 GB
SDHC Memory Card (Use cards bearing the  logo.)	4 GB
	8 GB
	16 GB

- 8 MB and 16 MB SD Memory Cards are for still picture recording only.
- With 32 MB, 64 MB and 128 MB SD Memory Cards, still pictures can be recorded, but motion picture recording may stop during use.
- Multimedia cards cannot be used.

■ Recommended Panasonic SD/SDHC Memory Cards (as of February 2008)

The following Panasonic SD/SDHC Memory Cards and SD speed Class 2 or higher Memory Cards are recommended for this unit. With other types of SD cards, motion picture recording may stop during use.

	SD Memory Card	SD/SDHC Memory Card		
	High Speed	Class 2	Class 4	Class 6
256 MB	RP-SDH256	RP-SDR256	—	—
512 MB	RP-SDK512	RP-SDR512	—	—
1 GB	RP-SDH01G	RP-SDR01G	—	RP-SDV01G
2 GB	RP-SDK02G	RP-SDR02G	RP-SDM02G	RP-SDV02G
4 GB	—	RP-SDR04G	RP-SDM04G	RP-SDV04G
8 GB	—	—	—	RP-SDV08G
16 GB	—	—	—	RP-SDV16G

Precautions in handling

- Do not touch the terminals on the back of the card. Also, prevent dirt, water and foreign matter from adhering to terminals.
- Do not leave cards in the following areas:
 - Where exposed to direct sunlight
 - Humid or dusty places
 - Near heaters and sources of heat
 - Where subjected to sharp temperature changes (condensation can occur)
 - Where exposed to static electricity or electromagnetic waves
- After use, return cards to their pouch or case.
- SD card data may be corrupted or lost due to electrical noise, static electricity, damage to the unit or card, etc. Save important data on a PC using the supplied USB cable, MotionSD STUDIO, etc. (P.76)

■ Write-protecting cards

When the write-protect switch on the SD card is set to the LOCK position, data cannot be written onto or deleted from the card, and the card cannot be formatted.

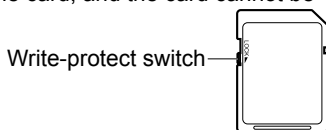

● SDHC Memory Cards can be used only with SDHC devices.

Be careful when sharing cards between devices.

● Be sure to format SD cards with this unit only.

If cards are formatted on a PC or other device, recording may take time and the card may become unusable with the unit.

- Before using an SD card from another device, copy the data onto a PC or other storage device and then format the card with this unit.
- Keep the Memory Card out of reach of children to prevent swallowing.
- This unit supports SD Memory Cards formatted to FAT12 or FAT16 file systems and SDHC Memory Cards formatted to a FAT32 file system.
- SD speed Class 2 **CLASS 2**

Class 2 speed standard for SD cards. This and higher types of SD cards operate stably in devices for which Class 2 or higher SD cards are recommended such as this unit.

Insert the battery into the unit and charge it.

- 1 Set the mode dial to [OFF].**
The unit runs on AC power (status indicator lit red) and the battery cannot be charged when the mode dial is set to any position other than [OFF].

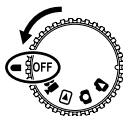

- 2 Open the card/battery door.**

Open the door by sliding the card/battery door lever to the "OPEN" position.

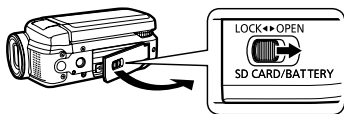

- 3 Insert the battery.**

Ensure that battery is oriented correctly, and push it into the compartment in the direction of the [▲] until it snaps into place and it is locked by the lever.

(To remove the battery, press the lever in the direction of the [◁].)

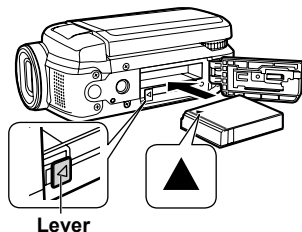

- 4 Close the card/battery door.**

Close the card/battery door and slide the card/battery door lever to the "LOCK" position.

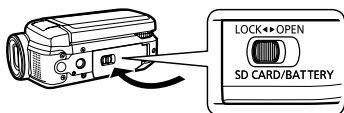

- 5 Connect the AC adaptor (supplied).**

Connect the AC cable to the AC adaptor and then to an AC outlet.

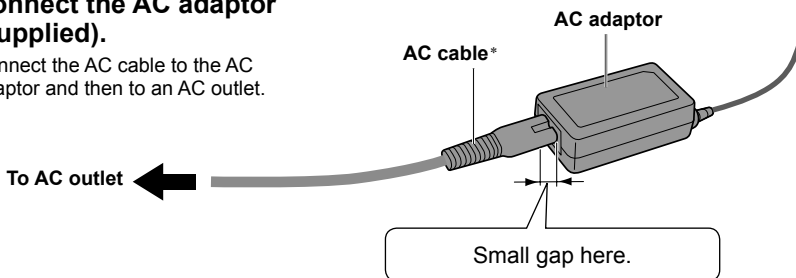

* Do not use the AC cable and AC adaptor of this unit with other devices. Also, do not use the AC cables and AC adaptors of other devices with this unit.

The battery is not charged at the time of purchase. Be sure to charge it before use.

For charging time (P.22)

We recommend using Panasonic batteries. (VW-VBJ10)

If you use other batteries, we cannot guarantee the quality of this product.

CAUTION

Danger of explosion if battery is incorrectly replaced. Replace only with the same or equivalent type recommended by the manufacturer. Dispose of used batteries according to the manufacturer's instructions.

- Do not heat or expose to flame.
- Do not leave the battery in an automobile exposed to direct sunlight for a long period of time with doors and windows closed.

6 Open the terminal cover.

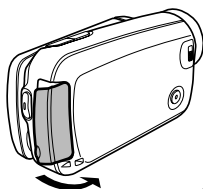

7 Plug the DC plug into the DC input terminal on the unit.

Status indicator

Flashing red at approx. 1 second

intervals: Charging in progress

Off: Charging complete

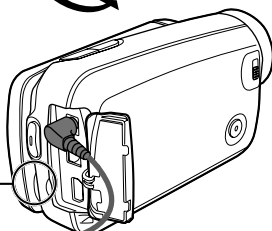

If the status indicator does the following:

Does not flash:

Remove and reinsert the battery, and disconnect and reconnect the AC adaptor.

If the status indicator still does not flash, contact your dealer.

Flashes rapidly at approx. 0.25 seconds intervals:

The battery cannot be charged. Try doing the following.

- Remove and reinsert the battery, and try recharging the battery.
- The battery temperature or surrounding temperature is too high/low, therefore wait until the unit and the battery are at suitable temperatures and try recharging the battery.

If battery charging still does not commence, contact your dealer.

Flashes slowly at approx. 3 seconds intervals:

Charging requires time for the following reasons:

- The battery has been excessively discharged.
- The battery temperature or ambient temperature is too high/low.

- If power to the unit is activated while the battery is charging, the AC power supply will be used and charging interrupted.

Charging time and recordable time

Times are given for a temperature of 25 °C (77 °F) and humidity of 60 %. The charging time shown in the table are approximations. In high or low temperatures, charging requires more time.

- Supplied battery VW-VBJ10 (3.6 V, 1000 mAh)

Charging time	Approx. 2 h 15 min	
Recordable time	Maximum continuously recordable time	Actual recordable time
	Approx. 1 h 10 min	Approx. 40 min

- Actual recordable time includes recording and stopping, power ON/OFF switching, zooming and other operations.
- Recordable time varies according to conditions of use. For example, the recordable time shortens when the [POWER LCD] setting is on while recording.
- The recordable time shortens in some environments (i.e., low temperatures, etc.), therefore it is recommended to charge a spare battery.

Remaining battery capacity indication

The battery indication changes, as the remaining battery power decreases.

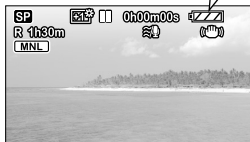
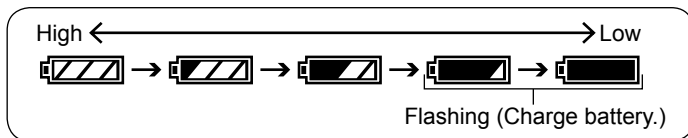

It has been found that counterfeit battery packs which look very similar to genuine product are made available to purchase in some markets. Some of these battery packs are not adequately protected with internal protection to meet the requirements of appropriate safety standards. There is a possibility that these battery packs may lead to fire or explosion. Please be advised that we are not liable for any accident or failure occurring as a result of use of a counterfeit battery pack. To ensure that safe products are used we would recommend that the genuine Panasonic battery pack is used.

- Be aware that many batteries sold at extremely cheap prices or in situations where it is difficult to verify the actual products before purchase have proven to be counterfeit.

3 Inserting/Removing SD cards (sold separately)

SD cards are sold separately.

Preparations: Set the mode dial to [OFF].

(Check that the status indicator is out.)

Inserting or removing an SD card with the power ON may damage the unit and destroy data on the card.

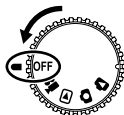

1 Open the card/battery door.

Open the door by sliding the card/battery door lever to the "OPEN" position.

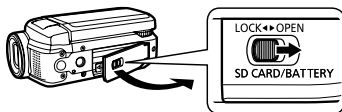

2 Insert/Remove the SD card.

•To insert:

Face the label upwards and slide the card in straight until hearing it catch.

•To remove:

Press the center of the SD card and pull the card out straight.

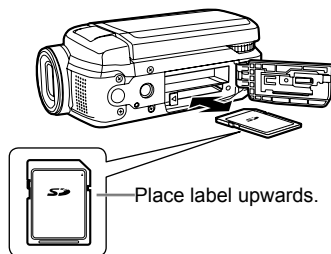

3 Close the card/battery door.

•Close the card/battery door and slide the card/battery door lever to the "LOCK" position.

•If the door does not close completely, remove the SD card, check its orientation and reinsert it into the slot.

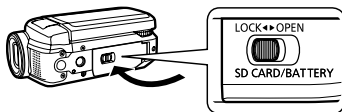

•While the card access lamp is lit, reading, recording, playback, deletion or other processing is being executed. Performing the following operations while the lamp is lit may damage the SD card and its content and the unit may not function properly.

- Switching off power
- Removing battery or AC adaptor
- Opening card/battery door and removing SD card
- Rotating the mode dial
- Shaking or impacting the unit



Turning power ON/OFF (Selecting modes)

Rotate the mode dial slowly but surely to the desired position.

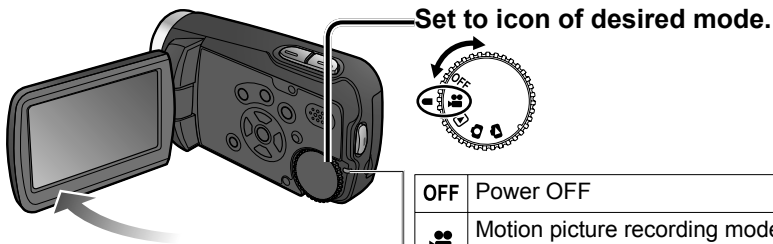

Status indicator

- When power is ON: Lit red
(When selecting)
- When power is OFF: Off

OFF	Power OFF
	Motion picture recording mode (P.32)
	Motion picture playback mode (P.52)
	Still picture recording mode (P.34)
	Still picture playback mode (P.55)

- The very first time that power is turned ON, a message appears prompting you to set the date and time. (P.28)



Turning power ON/OFF from the LCD monitor

When or is selected, power turns ON when the LCD monitor is opened and OFF when it is closed. (During motion picture recording, power does not turn OFF when the LCD monitor is closed.)

- When [QUICK START] (next page) is [ON], the unit goes on quick start standby when the LCD monitor is closed.
- **When not in use, set the mode dial to [OFF].**

Rotate the mode dial to motion picture recording/playback, still picture recording/playback or power OFF.

Quick starts

Quick starts are available when the mode is set to  and . When [QUICK START] is [ON], the unit responds as follows to LCD monitor operations:

LCD monitor operation	Unit response	Status indicator
When opened	Shooting can start in approx. 0.6 second.	Lit red
When closed	The unit goes on quick start standby*.	Flashing green

* The unit consumes about half as much power as when recording is stopped.

■ Setting [QUICK START]

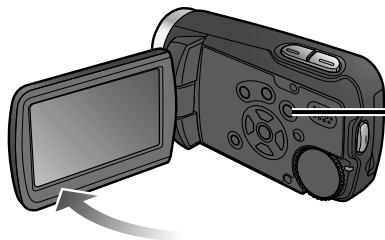

Make settings from the menus. (P.26)

MENU
 → [SETUP] →

[QUICK START] → [ON]
(To turn OFF, select [OFF].)

- [QUICK START] is [ON] at the time of purchase.

- The quick start standby is canceled and power shuts OFF (status indicator out) in the following situations.
 - When quick start standby mode continues for more than about 5 minutes
 - When the mode dial is rotated
- When white balance is set to **[AWB]**, quick starts require more time if the light source differs from that prior to quick starting, because automatic adjustments are performed. (However, automatic adjustments are not performed when using the MagicPix function.)
- Starting may require more time than usual if the unit is impacted.
- Zoom magnification becomes 1x after quick starts.
- If [POWER SAVE] (P.84) is set to [5 MINUTES] and the unit automatically goes on quick start standby, close and reopen the LCD monitor.

Setting from the menu, changing the display language

The menu cannot be displayed during recording or playback.
For menu items (P.82 "Menu List")

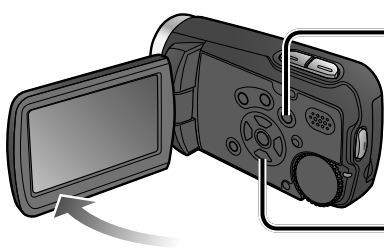

1 Display the menu.



The menu displayed differs according to mode.

2 Select the top menu.

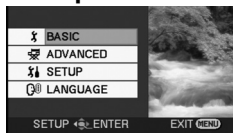

(Top menu for [CAMERA] and [CAMERA] modes)

■ To return to the previous screen

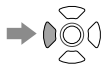

■ To quit an operation halfway through



3 Enter the top menu.



or



4 Select a submenu.

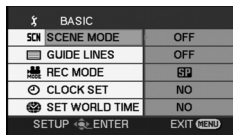

5 Enter the selected submenu.



or



The cursor buttons are used to select functions, execute operations and make menu settings.

6 Select an item.

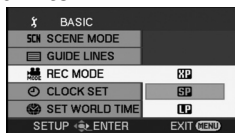

8 Close the menu.





7 Enter the selected item.

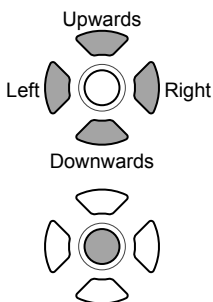

Using the cursor buttons

The cursor buttons are used to select and enter items on menus or thumbnail displays.



- To move the cursor
The cursor moves in the direction of the respective cursor buttons  when pressed.
- Pressing the center enters the selection.

- Do not rotate the mode dial while menus appear on the LCD monitor.
- You cannot record or perform other operations while menus appear on the LCD monitor.

Changing the display language

The display and menu language can be changed.

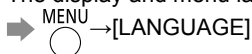

⌚ Setting the date and time

Before recording, check that the date and time have been set.

The very first time that power is turned ON, a message appears prompting you to set the date and time. Select [YES], press the center of the cursor buttons and proceed to step 3.

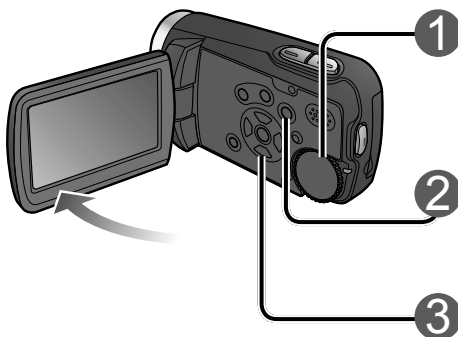

1 Set to [] or [].

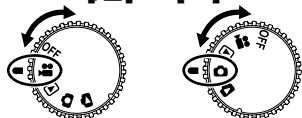

2 Select the desired menu.

MENU
 ➔ ○ → [BASIC] →
 [CLOCK SET] → [YES]

3 Set the date and time.



To select settings

To change numerical values

■ To change the date and time display

- To change an item

MENU
 ➔ ○ → [SETUP] →
 [DATE/TIME]

[OFF] : Date and time are not displayed.

[D/T] : Date and time are displayed.

[DATE] : Only the date is displayed.

- To change the date format

MENU
 ➔ ○ → [SETUP] →
 [DATE FORMAT]

Format indication	Appearance on LCD monitor
[Y/M/D]	2008.DEC.15
[M/D/Y]	DEC.15.2008
[D/M/Y]	15.DEC.2008

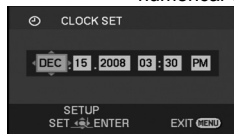

The year is displayed up to 2099 and the 12-hour system is used to display the time.

4 Enter the date and time.



- The clock function starts at [00] seconds.
- After pressing the [MENU] button and closing the menu, check the date and time displays.

and adjusting the LCD monitor

- After setting the date and time, summer time can be set as in “Setting home city and region” of the world time function (P.50).
- If [- -] is displayed for the date and time, the built-in lithium battery has run down. Charge the battery and set the time as follows. The built-in lithium battery is charged when the AC adaptor is connected to the unit or when a battery is inserted into the unit. If charged for about 24 hours, the date and time can be saved in memory for about 6 months. (The battery is charged even if the power is turned OFF.)

Adjusting the LCD monitor

LCD monitor color and brightness can be adjusted. (Settings do not affect recorded images.) For settings from the menu (P.26)

The LCD monitor cannot be adjusted for self-portrait recording (P.43).

1 Select the desired menu.

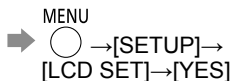

2 Select and adjust the item.

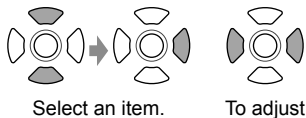

The bar moves.

[BRIGHTNESS]:

Adjusts brightness.

[COLOR]:

Adjusts color density.

■ If the LCD monitor is hard to see in bright places (POWER LCD)

Brighten the entire LCD monitor.

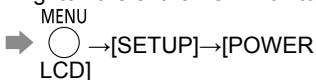

: Normal brightness

: The LCD monitor brightens.

: The LCD monitor brightens more.

-  is automatically selected when the AC adaptor is used.

Basic stance

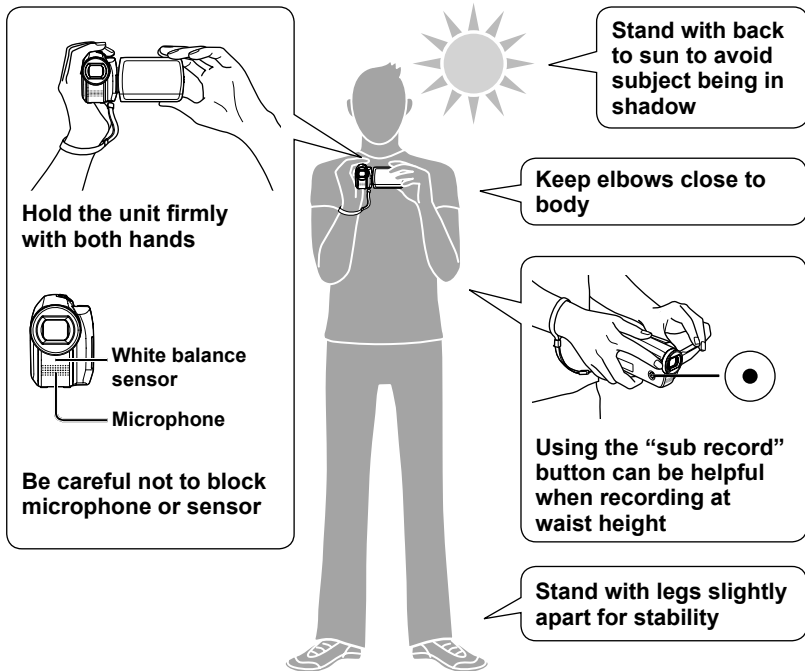

- Before recording, open the lens cover.

Record motion and still pictures onto the SD card.
Recorded motion and still pictures are referred to as “scenes” with this unit.

Recording can be done in two ways: “Automatic recording” or “Manual recording”.

Automatic recording (motion/still pictures)

(This is the default setting at the time of purchase)

- To have coloring, focus, and brightness settings made automatically

See
P.32-35

Manual recording (motion/still pictures)

(Manually adjust settings such as focus, white balance, shutter speed, iris/gain, etc.)

- To record with your own settings
- When automatic recording is unsatisfactory
- To use settings for particular scenes (scene mode)

See
P.44-49

Note

Do not perform any of the following operations while the SD card is being accessed (card access lamp illuminated). Performing these actions may damage the card and its data.

- Switching off power
- Removing battery or AC adaptor
- Opening card/battery door and removing SD card
- Rotating the mode dial
- Shaking or impacting the unit

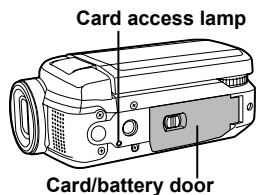

- For SD cards applicable with this unit (P.18)

Automatic recording (motion pictures)

Before recording, open the lens cover.

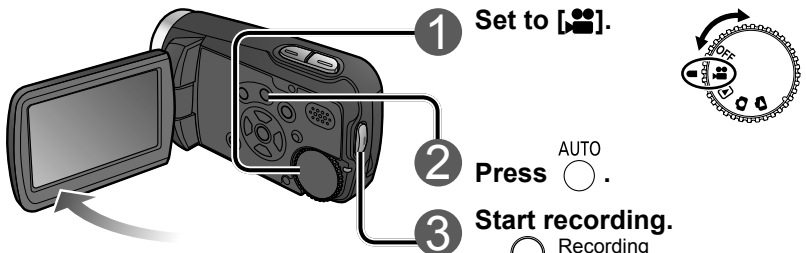

■ To change aspect ratio to 4:3

MENU
 ➔ → [ADVANCED] →
 [ASPECT] → [4:3]

Default aspect ratio at the time of purchase is set to 16:9 (widescreen).

■ To remove sound when record button is pressed

MENU
 ➔ → [SETUP] →
 [BEEP SOUND] → [OFF]

■ To remove on-screen display

MENU
 ➔ → [SETUP] →
 [DISPLAY] → [OFF]

■ To ensure that you won't pass up any recording opportunities

PRE-REC function (P.42)

1 Set to .

2 Press .

3 Start recording.

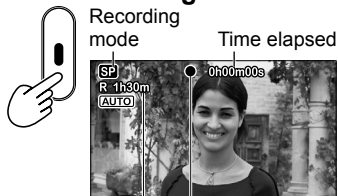

Time remaining (flashes red when under 1 minute)

Recording continues even if the LCD monitor is closed.

4 Stop recording.



Paused (green)

The unit is still recording if is red. Do not move the unit.

- When the unit is running on battery power, power is automatically shut OFF to conserve battery life if no operations are performed for about 5 minutes. To reuse the unit, set the mode dial to [OFF] and then reselect a mode. To prevent power from shutting OFF automatically: (P.84 [POWER SAVE])
- The interval between starting and stopping recording is recorded as one single scene. The counter is reset to "0h00m00s" after each scene.
- At the time when the unit is purchased, the audio recording mode is set to [DOLBY]. For playback in a device which does not support Dolby Digital, set [AUDIO REC] to [MPEG]. (P.84)

Record motion picture with settings such as focus and coloring made automatically.

For maximum recording times with battery, see (P.22)



Recording mode and recording times

Recording times depend on the recording mode selected.

Recording times for Panasonic SD cards (approximate)

SD card capacity	Recording mode		
	XP (Highest picture quality)	SP (Standard)	LP (Longest recording time)
256 MB	3 min	6 min	12 min
512 MB	6 min	12 min	25 min
1 GB	12 min	25 min	50 min
2 GB	25 min	50 min	1 h 40 min
4 GB	50 min	1 h 40 min	3 h 20 min
8 GB	1 h 40 min	3 h 20 min	6 h 40 min
16 GB	3 h 20 min	6 h 40 min	13 h 20 min

- If a single scene exceeds 4 GB during motion picture recording, recording continues as a separate scene.
- Recording fast-moving objects or repeatedly writing on the same SD card numerous times shortens recording time.
- Mosaic-like interference may be generated on playback screens in the following circumstances:
 - Complicated pictures in background
 - The unit is moved greatly or quickly
 - Recording is of a rapidly moving object (particularly if recording mode is set to **[LP]**)

■ To change recording mode



If recording stops

- Recording may stop suddenly if an incompatible SD card has been inserted. (P.18)
- Even with usable SD cards, recording may stop if you repeatedly write on the same SD card. Copy data onto a PC using MotionSD STUDIO, then format the SD card with this unit. (When formatted, all data on the SD card is erased.)

Automatic recording (still pictures)

Before recording, open the lens cover.

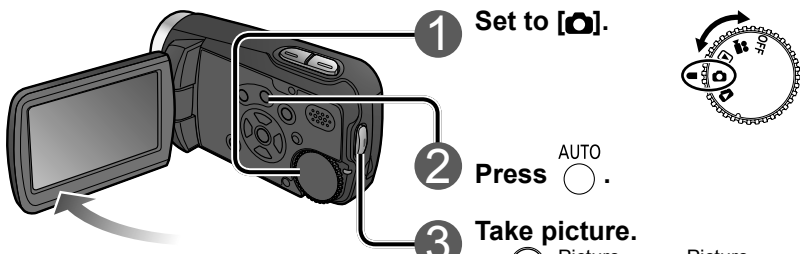

1 Set to [A].

2 Press AUTO.

3 Take picture.

Picture resolution Picture quality



Pictures remaining
(flashes red when zero)

Focus is aligned to object in center of shot.

■ To remove shutter sound
 MENU
 → → [ADVANCED] → [SHTR EFFECT] → [OFF]

■ To remove on-screen display
 MENU
 → → [SETUP] → [DISPLAY] → [OFF]

- Sound is not recorded.
- Recorded still pictures are referred to as “scenes” with this unit.



Take still pictures with settings such as focus and coloring made automatically.

For maximum recording times with battery see (P.22)



Picture quality

Picture size is 640×480 (0.3 M). The number of pictures that may be recorded depends on the picture quality selected.



Picture quality and number of pictures for Panasonic SD cards (approximate)

SD card capacity	Picture quality	
	 High (highest picture quality)	 Standard (largest number of pictures)
8 MB	37	75
16 MB	92	185
32 MB	200	410
64 MB	430	850
128 MB	820	1640
256 MB	1710	3410
512 MB	3390	6780
1 GB	6790	13580
2 GB	13820	27640
4 GB	27150	54290
8 GB	55260	99999*
16 GB	99999*	99999*

* This unit can record only up to 99,999 still pictures in these SD cards.

- Pictures taken with the [] setting may suffer a mosaic-like effect for certain objects.
- Depending on the object, the number of pictures that may be recorded may vary if a mixture of [] and [] settings have been used.



■ To change picture quality

MENU
➔  → [BASIC] → [PICT.QUALITY] → [] / []

To avoid jitter

(The image stabilizer function (P.37) cannot be used during still picture recording.)

- Hold the unit firmly with both hands, and keep elbows close to your body.
- Jitter becomes particularly difficult to avoid with zoom ratios of 4x and above. It is recommended that you reduce the zoom ratio and move closer to the object.
- Try using a tripod.

 indicates functions used with motion pictures and  functions used with still pictures.

Enlarging (zoom)

Optical zoom can be used to enlarge objects by up to 10 times without degradation.

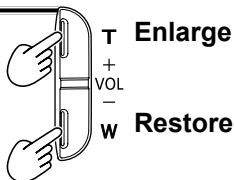
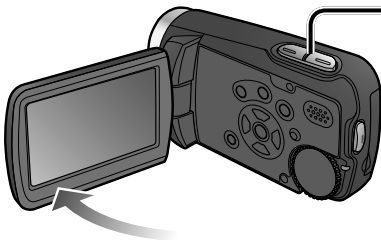

Zoom ratio: 1x

This unit can focus on a subject approx. 4 cm (1.6") away from the lens.



After enlarging the image, the subject is brought into focus at 1.0 m (3.3 feet) or greater distance.

■ To enlarge further

Digital zoom can be used to enlarge objects by a maximum of 700 times. (Cannot be used during still picture recording.)

MENU

➔  → [ADVANCED] → [D.ZOOM]

[OFF] : No digital zoom

[25x] : Up to maximum of 25x

[700x] : Up to maximum of 700x

- Picture quality will be reduced by the same factor as the zoom ratio is increased by.

- The digital zoom range is displayed in blue in the zoom bar on the LCD monitor.

- Release zoom button quietly (any sounds may be recorded).
- The image stabilizer function is recommended for motion picture recording at high zoom rates.
- Focus may not be aligned if zooming in too quickly.
- Zooming has two speeds. When the buttons are pressed lightly, zooming is done at slow speed. When pressed strongly, zooming is done at high speed.

picture brightness in dark locations

■ Apply zoom effect to sounds (zoom microphone)

Synched with zooming operations, distance sounds are recorded when enlarging and peripheral sounds are recorded at wide angles.

MENU

➔  → [ADVANCED] → [ZOOM MIC] → [ON]

■ Avoid jitter (image stabilizer function)

MENU

➔  → [ADVANCED] → [EIS] → [ON]



- Default setting at the time of purchase is [ON].
- The image stabilizer function cannot be used in shooting still pictures or with MagicPix.
- Brightness may change and coloring may appear unnatural when using beneath fluorescent lighting.
- The image stabilizer function may not perform successfully in the following circumstances:
 - Using digital zoom
 - Location is extremely dark
 - Jitter is significant
 - When following moving object

■ Maintain brightness in dark locations (auto slow shutter)

Shutter speed is automatically slowed in dark places in order to brighten captured images.

MENU

➔  → [ADVANCED] → [AUTO SLW SHTR] → [ON]

- Default setting at the time of purchase is [ON].
 - : (When [ON], shutter speed is automatically adjusted between 1/30 and 1/350. When [OFF], shutter speed is automatically adjusted between 1/60 and 1/350.)
 - : (When [ON], shutter speed is automatically adjusted between 1/30 and 1/500. When [OFF], shutter speed is automatically adjusted between 1/60 and 1/500.)
- Focus may not be aligned perfectly in extremely dark locations or where there is little contrast.
- When shutter speed is 1/30 - 1/59:
 - Images may appear as if frames were skipped and ghost images may appear.
 - The image stabilizer function does not work even when  appears.
- During manual recording, shutter speed can be adjusted manually. The range in which shutter speed may be adjusted depends on the auto slow shutter setting. (P.48)

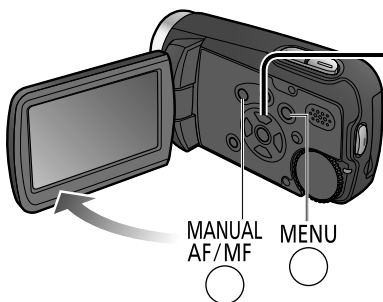

While recording is paused
1 Display operation icons.



Operation icons

2 Change operation icons.
 Icons change with each press, as displayed below.



For manual focus mode (Press [MANUAL AF/MF] two times).

For manual mode (Press [MANUAL AF/MF] one time).

In automatic recording

During motion picture recording

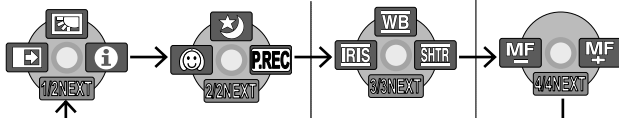

During still picture recording

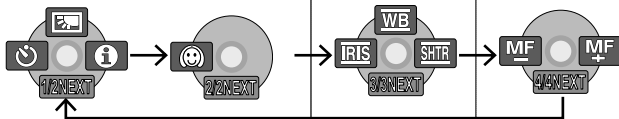



Icon	Function	Page	Icon	Function	Page
	Backlight compensation function	40		PRE-REC function ([] only)	42
	Fade in/fade out function ([] only)	39		White balance	46
	Self-timer recording ([] only)	40		Brightness (iris/gain)	49
	Help mode	39		Shutter speed	48
	MagicPix function ([] only)	41		Manual focus adjustment	44
	Soft skin mode	41			

■ To hide operation icons →



Operation icons can be used to set effects, compensate brightness or perform other operations in one easy step.

 indicates functions used with motion pictures and  functions used with still pictures.

View explanations of functions during automatic recording (help mode)

① Select  in step ① on the previous page.



② Select function to be explained.



Next

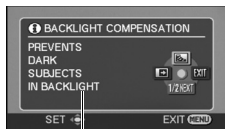

Explanation is displayed

- To close, select [EXIT] in step ②, or press the [MENU] button.
- Functions cannot be set nor can pictures be taken in the help mode.

Fade-in/Fade-out

This function gradually fades images and audio in and out at the very beginning and very end of recording.

① Display operation icons.



② Select .

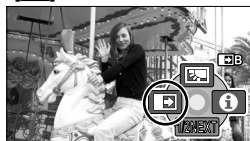

Selecting again cancels setting.

③ Start recording.



④ Stop recording.

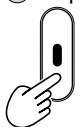

- Cannot be used during still picture recording.
- Thumbnail can be either black or white.
- Setting is canceled after recording is stopped or power is switched off.

■ To change the fade-in and fade-out image color to black or white

MENU
  → [ADVANCED] → [FADE COLOR] → [WHITE] / [BLACK]

Recording 5 Other recording options (cont.)

Backlight compensation function

Brightens objects that appear dark against backlighting.

① Display operation icons.

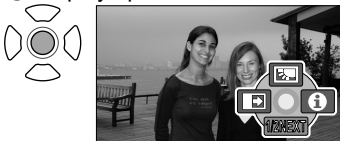

② Select [].

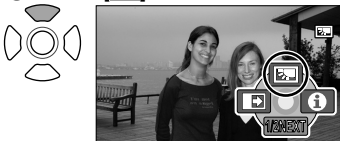

Selecting again cancels setting.

- Shutting off the power or rotating the mode dial cancels the setting.

Self-timer

Still pictures may be taken using the self-timer.

① Display operation icons.



② Select [].



Selecting again cancels setting.

③ Take picture.





Picture is taken approx. 10 seconds after [] begins to flash.

■ To quit halfway through → 

- Cannot be used during motion recording.
- Setting is canceled once picture is taken or power is switched off.

Operation icons can be used to set effects, compensate brightness or perform other operations in one easy step.

 indicates functions used with motion pictures and  functions used with still pictures.

Soft skin mode

Softens skin colors when people's faces are prominent in picture.

① Display operation icons.



② Select [].



Selecting again cancels setting.

- Background colors that are close to skin colors may also be softened.
- Faces may be blurred if people in picture are distant.
- Function may not be effective in locations with insufficient brightness.
- The setting is not canceled even when power is shut OFF or the mode dial is rotated.

MagicPix function

Colors can be brought out even in dark locations (brightness of at least 2 lx).
(Recorded scene is seen as if frames were missed.)

① Display operation icons.



② Select [].

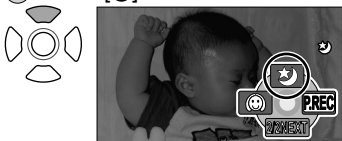

Selecting again cancels setting.

- Cannot be used during still picture recording.
- Normally invisible spots of light may become visible.
- Using a tripod is recommended.
- If focus does not successfully align automatically, adjust using manual focus (P.44).
- The screen may appear white momentarily if using in bright locations.
- Shutting OFF the power or rotating the mode dial cancels the setting.

Recording 5 Other recording options (cont.)

PREC PRE-REC function

To ensure that you won't pass up any recording opportunities, the picture and sound are recorded starting about 3 seconds before the record button is pressed.

① Display operation icons.

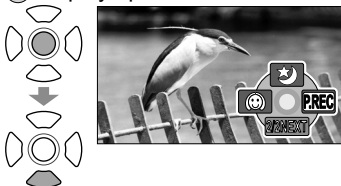

② Select [PREC].





- “PRE-REC” is displayed on the LCD monitor screen.
- The picture and sound are recorded starting about 3 seconds before the record button is pressed.
- **Aim this unit at the subject and position it securely.**
- The power save function does not work.
- When the function is selected again while it has been set, it will be released.
- The function is released if recording is not started within 3 hours after the function was set.

③ Start recording.



- The beep sound does not sound.
 - The PRE-REC function setting is released when recording is started. To use the function again, set it again.
-
- Cannot be used during still picture recording.
 - The PRE-REC function setting is released in the following situations.
 - When the mode dial is rotated
 - When the power is turned off
 - When the card/battery door is opened
 - When the MENU button is pressed
 - When the unit has been connected to another device using the USB connecting cable



Operation icons can be used to set effects, compensate brightness or perform other operations in one easy step.

 indicates functions used with motion pictures and  functions used with still pictures.

- It is not possible to set the PRE-REC function when less than one minute is left for recording pictures.
- When recording has been started within 3 seconds after the PRE-REC function was set, the scenes starting from the moment when this function was set will be recorded.
- The camera shake which occurs when the record button is pressed or the sound of the button being operated may be recorded.
- It is not possible to add any fade effects (P.39).

Self-portrait recording function

If you turn the LCD monitor toward the lens side, you can record pictures of yourself as you look at the LCD monitor.

① Set the mode dial to  or .

② Turn the LCD monitor toward you (toward the lens side).

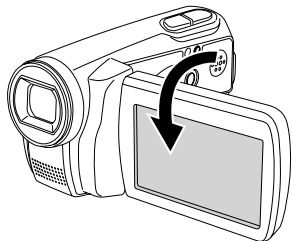

- The picture you will see displayed on the LCD monitor is an image of yourself with the left and right sides reversed just like when you look at your reflection in a mirror. (The image which is recorded is the normal image of yourself.)
- Only part of the screen display appears. When  is displayed, turn the LCD monitor back in the direction of normal recording, and check what the message says.

③ Start recording.



-
- No operation icons are displayed during self-portrait recording even when the cursor buttons are pressed.

Recording 6 Recording manually (motion/still pictures)

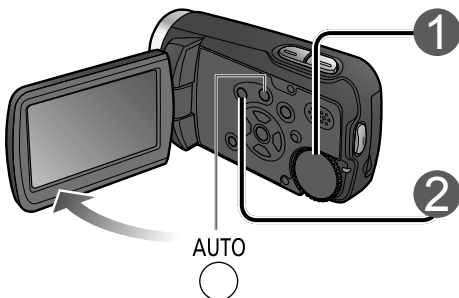

1 Set to [M] or [M].

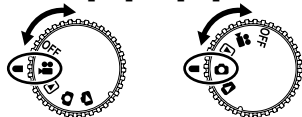

2 Select manual recording.

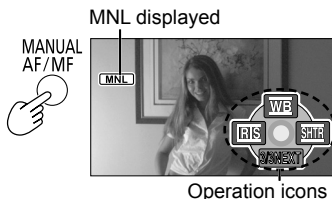

■ To return to automatic recording



■ To hide operation icons



Adjusting focus manually (manual focus adjustment) [M] [M]

Manually focus the subject if it cannot be brought into focus by automatic focus. For example, focusing is hard in the following situations:

- Mixture of close and distant objects
- Objects beyond unclear glass
- Bright peripheral lights
- Dark locations
- Fast-moving objects
- Objects with little contrast

After steps 1 and 2

1 Display MF.





MF displayed

2 Adjust focus.



- Focuses adjusted on wide-angle settings may become unaligned when subsequently zooming in. Focuses adjusted when zoomed in will be unaffected when subsequently zooming back out.

■ To return to automatic focus → MANUAL AF/MF or AUTO

Focus, coloring, shutter speed and brightness can be manually adjusted.
 indicates functions used with motion pictures and  functions used with still pictures.







Using situation-specific settings (scene mode)

Already prearranged settings can be used.

➔ After steps ① and ② (previous page)

MENU

 → [BASIC] → [SCENE MODE] → select from the five modes below:

 Sports	For fast-moving scenes
<ul style="list-style-type: none"> • Avoids blurring during slow-motion playback or playback pause. (In normal playback, image movement may not look smooth.) • Avoid fluorescent, mercury, and sodium lighting. Such lighting conditions may affect coloring and brightness. • Vertical bands of light may appear during playback on shining or highly reflective objects. • This function may not work if lighting is insufficient ( flashes). • Screen may flicker if using indoors. 	
 Portrait	Blurs background to make people stand out
<ul style="list-style-type: none"> • Screen may flicker if using indoors. 	
 Low light	Brightens dark scenes such as evening skies
<ul style="list-style-type: none"> • May not function successfully in extremely dark scenes. 	
 Spotlight	For people beneath spotlights, etc.
<ul style="list-style-type: none"> • Pictures may appear white when object is extremely bright. Peripheries may also appear extremely dark. 	
 Surf & snow	For bright locations such as beaches and ski slopes
<ul style="list-style-type: none"> • Pictures may appear white when object is extremely bright. 	

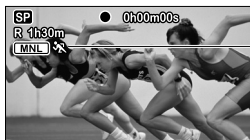

The icon of the selected scene mode appears on the LCD monitor.

■ To cancel the setting

MENU

➔  → [BASIC] → [SCENE MODE] → [OFF] or  AUTO

Recording 6 Recording manually (motion/still pictures) (cont.)

Achieve natural colors (white balance)

Restore natural colors according to the light source when coloring has become unnatural.

After steps ① and ② (P.44)

① Select **[WB]**.







② Set the mode.



Mode displayed

The mode is changed by one setting in the following sequence each time any cursor button is pressed.



[AWB]	Automatic	Adjusted automatically
	Indoor (incandescent lighting)	In locations with incandescent or halogen lighting
	Outdoor	In bright, outdoor conditions
	Set manually (see below)	When ideal results cannot be produced with [AWB] ,  ,  modes (Mercury lighting, sodium lighting, fluorescent lighting, hotel lighting, spotlights, sunsets, sunrises, etc.)

Setting manually

Set colors based on white objects within the required lighting environment.

① Set to **[MNL]**.

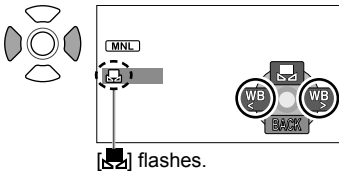

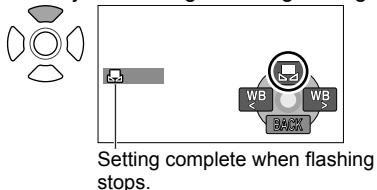

② Fill the entire display with white subject and begin making setting.



- If the **[MNL]** continues flashing after setting begins, the setting cannot be made. (Because the range is too dark, etc.)
- If the **[MNL]** flashes during recording, adjustments cannot be completed for the current subject. Remake the setting until matching the subject.

Focus, coloring, shutter speed and brightness can be manually adjusted.

 indicates functions used with motion pictures and  functions used with still pictures.

■ **To return to automatic adjustment** ➔ Set to **[AWB]** or  .

● Please adjust white balance first if using in conjunction with iris/gain setting.

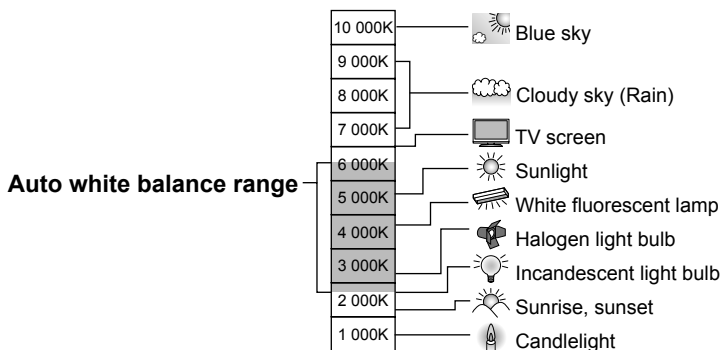

When out of range, images become reddish or bluish. Moreover, the mode does not work properly even when within range if multiple light sources are used. In such cases, adjust images manually.

Recording 6 Recording manually (motion/still pictures) (cont.)

Adjusting shutter speed (shutter speed)

Adjust shutter speed to record fast-moving objects, etc.

After steps ① and ② (P.44)

① Select [SHTR].

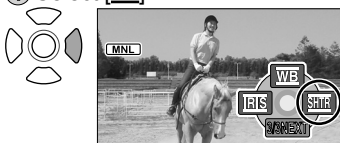

② Adjust shutter speed.

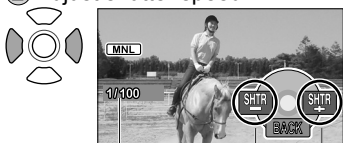

Shutter speed
SHTR-: Slower
SHTR+: Faster

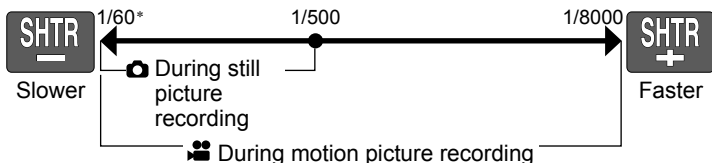

Shutter speed adjustment range



* Slower extreme becomes 1/30 when auto slow shutter (P.37) is set to [ON].

- When adjusting both shutter speed and brightness (iris and gain), adjust the shutter speed first.
- Interference may increase with faster shutter speeds (as sensitivity becomes lower and gain value rises automatically).
- Vertical bands of light may appear during playback on shining or highly reflective objects.
- Avoid fluorescent, mercury, and sodium lighting. Such lighting conditions may affect coloring and brightness.
- In normal playback, image movement may not look smooth.
- Colors may change and flicker when recording in extremely bright locations. Set the shutter speed between 1/60 and 1/100.

■ To return to automatic adjustment ➡ 

Focus, coloring, shutter speed and brightness can be manually adjusted.
 indicates functions used with motion pictures and  functions used with still pictures.

Adjusting brightness (iris/gain)

Adjust iris/gain (sensitivity) settings if location is too bright or too dark.

After steps ① and ② (P.44)

① Select **IRIS**.



② Adjust brightness.



IRIS-: Darker

IRIS+: Brighter

Iris/gain value adjustment range

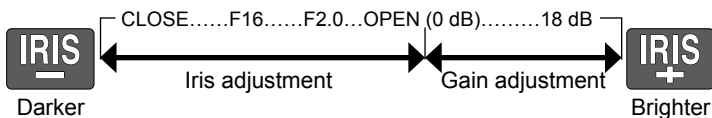



- Depending on the zoom magnification, some iris values (F number) may not be displayed.
- Interference will increase as gain value is raised.

■ To return to automatic adjustment ➔ 

Recording dates and times at travel destinations (set world time)

By setting your travel destination, the time difference is automatically calculated and displayed accordingly. Time settings (P.28) must be made first.

MENU
  → [BASIC] → [SET WORLD TIME] → [YES]

When making the setting the very first time, press the center of the cursor buttons after [SET HOME LOCATION.] appears on the LCD monitor and proceed to step ② in “Setting home city and region”.

Setting home city and region

① Select [HOME].

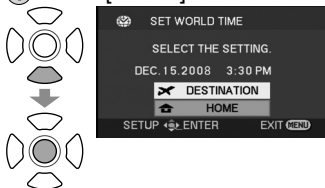



③ Close the menu.

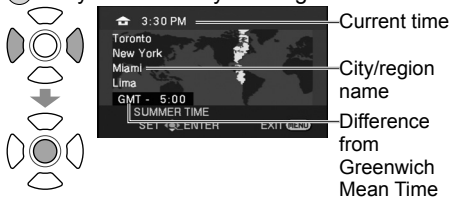

② Set your home city and region.



To set summer time 
 (The clock advances by 1 hour.)

 (Press again to cancel.)

Setting the city and region of your travel destination

① Select [DESTINATION].





③ Close the menu.

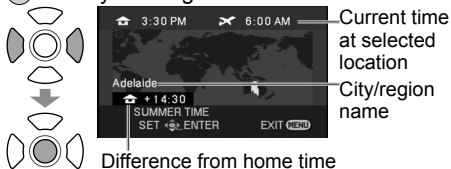

② Set city and region.





To set summer time 
 (The clock advances by 1 hour.)

 (Press again to cancel.)

■ To cancel  

The date and time of travel destinations can be recorded, guidelines displayed and the sound of the wind reduced.

 indicates functions used with motion pictures and  functions used with still pictures.

- When setting the travel destination, if the city and region of your travel destination do not appear, select another city and region in the same time zone.
- After the destination has been set, a  appears before the recording date/time indication.

Restoring local date and time after returning home

① Perform step ① in “Setting home city and region” (P.50).

② Close the map and menu.



View slants and composition (guide lines)

Guide lines are displayed so you can check for image tilting and balance composition.

MENU
➔  → [BASIC] → [GUIDE LINES] → [ON]

- Default setting at the time of purchase is [OFF].
- Guide lines will not be recorded.
- The guide lines are not displayed during self-portrait recording (P.43).



Avoid wind noise (wind noise reduction function)

Reduces the sound of wind hitting the microphone.

MENU
➔  → [ADVANCED] → [WIND CUT] → [ON]

- Default setting at the time of purchase is [ON].
- Stereo effects may be reduced in strong winds as sound of wind is automatically reduced according to wind strength.

▶ Viewing motion pictures

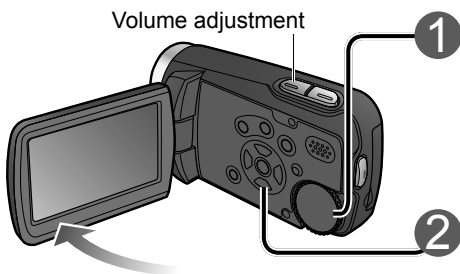

Volume adjustment

1 Set to [▶].

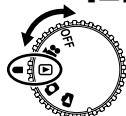

Thumbnails are displayed.

2 Select the desired scene.



A yellow frame appears around the selected scene.



Scene No.

■ To fast-forward/rewind



While pressed and held, only the scene No. changes rapidly.

Release the cursor button when the desired scene No. appears.

■ To adjust the volume

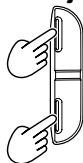

T (+) side:
+ Increases the volume.

W (-) side:
- Decreases the volume.

- Audio is output only during normal playback.
- The volume display appears on the LCD monitor while adjusting the volume.

To move to the next page:
either press the left and right cursor button or select or and press the center of the cursor button.

3 Enter the picture to view.

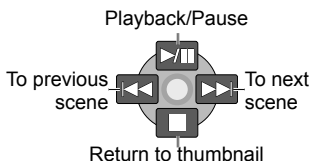

Recorded motion pictures (scenes) can be played back on the unit.
Do not remove the SD card while it is being accessed (card access lamp lit).

Displaying thumbnails by date

1 Select **[DATE]** in step **2** (P.52).

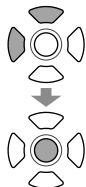

2 Select the date to display.

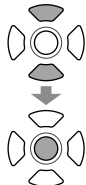

3 Only thumbnails of motion pictures recorded that day appear.

Display **[DATE]**.

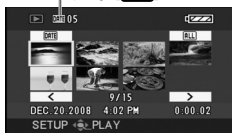

If more than 99 motion pictures are recorded on the same day, they are divided into separate displays.

■ **To quit displaying thumbnails by date (To display all thumbnails)**

➔ Select **[ALL]** in step **3** above and press the center of the cursor button.

- This unit complies with the SD-Video standard and can play back MPEG2 movies.
“MPEG” is the acronym for the “Moving Pictures Experts Group” and is a compressed movie format of 30 fps.
- Some motion pictures recorded on other devices may not play back correctly. Similarly, motion pictures recorded on this unit may not play back correctly on other devices.
- Thumbnails in which **[?!]** appears cannot be played back.
- Some motion pictures of short recording time cannot be played back.
- If the unit is running on battery power, **[POWER SAVE]** (P.84) is set to **[5 MINUTES]** and play pause is continued for 5 minutes, the power shuts off.
- The power does not shut off when the LCD monitor is closed.
- The time and date is recorded when the record button is pressed. When using the **PRE-REC** function, the displayed time and date for thumbnail images or playback images will be a few seconds later from the time of recording.

▶ Viewing motion pictures (cont.)

▶▶ Fast forward/rewind playback

During playback

Returns to normal playback.

Press and hold
to fast-rewind.



Press and hold
to fast-forward.



- Pressing the buttons again changes to fast-forward (fast-rewind) speed. The [▶▶] and [◀◀] buttons appearing on the LCD monitor change to [▶▶▶] and [◀◀◀].

▶ Slow-motion playback

While playback is paused

Returns to normal playback.

Press and hold for
slow-motion playback
in reverse



Press and hold for
slow-motion playback
in the forward direction



||▶ Frame-by-frame playback

While playback is paused

Returns to normal playback.

Press to
return one frame.



Press to
advance one frame.



Resuming the previous playback

If playback was stopped halfway through a motion picture, it can be resumed from the point where it was stopped.

MENU
➔ ○ → [SETUP] → [RESUME PLAY] → [ON]

- An “R” appears in the thumbnail of the scene that was stopped halfway through.
- The memory of the resume position is erased by rotating the mode dial or performing other operations. (Menu settings do not change.)
- When an SD card is write-protected, [RESUME PLAY] is automatically set to [OFF].

Recorded still pictures (scenes) can be played back on the unit.

Do not remove the SD card while it is being accessed (card access lamp lit).

1 Set to [P].

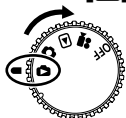

Thumbnails are displayed.

2 Select the desired scene.



A yellow frame appears around the selected scene.

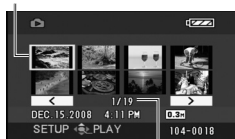

Scene No.

To move to the next page:
either press the left and right
cursor button or select or
 and press the center of
the cursor button.

3 Enter the picture to view.

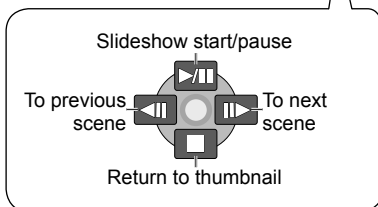

■ To fast-forward/rewind



While pressed and held,
only the scene No.
changes rapidly.

**Release the cursor button when
the desired scene No. appears.**

- This unit complies with the unified standard DCF (Design rule for Camera File system) established by JEITA (Japan Electronics and Information Technology Industries Association) and can play back JPEG pictures. (Some JPEG pictures cannot be played back.)
- Some still pictures recorded on other devices may not play back correctly. Similarly, still pictures recorded on this unit may not play back correctly on other devices.
- Thumbnails in which [!] appears cannot be played back.
- Time may be required to play back some still pictures depending on the number of recorded pixels.
- If the unit is running on battery power, [POWER SAVE] (P.84) is set to [5 MINUTES] and play pause is continued for 5 minutes, the power shuts off.
- The power does not shut off when the LCD monitor is closed.
- Do not rotate the mode dial during slideshows.

Deleting motion/still pictures

Use a sufficiently charged battery or the AC adaptor.

Do not shut off power or open the card/battery door while the unit is deleting pictures.

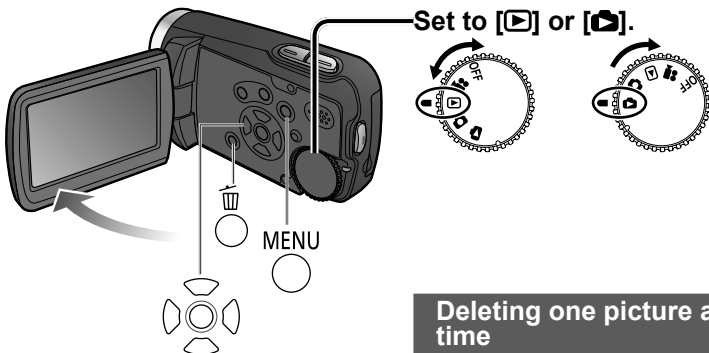

■ To cancel deletion halfway through



Pictures that were already deleted before the deletion operation was canceled cannot be restored.

Deleting one picture at a time

- 1 While playing back the picture to be deleted



- 2 Select [YES].

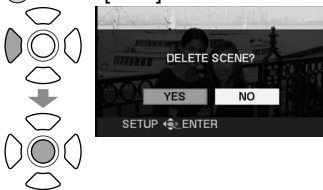

- Only motion pictures can be deleted from the menu. ([DELETE] under [EDIT SCENE] P.82)
- Pictures that cannot be played back such as thumbnails appearing with a [L/], cannot be deleted.
(Non-JPEG still pictures recorded with other devices may be deleted.)
- When pictures recorded on other devices are deleted, related information, such as management information, may be deleted as well.
- When DCF pictures are deleted, all related information, such as management information, is deleted as well.

Deleted pictures cannot be restored.

Locking pictures (P.58) you do not want to delete prevents them from being deleted accidentally.

Deleting all pictures

- ① With thumbnails displayed



- ② Select [ALL].

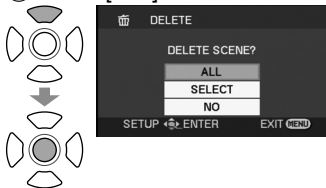

- ③ Select [YES].

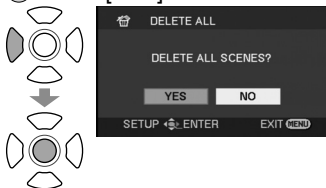

- ④ End deleting.
MENU



Deletion may take time depending on the number of pictures to delete.

Selecting and deleting multiple pictures

- ① With thumbnails displayed



- ② Select [SELECT].



- ③ Select the pictures to delete.

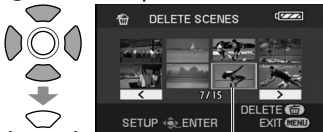

A red frame appears around the selected pictures.

- Selecting a picture a second time deselects it from deletion.
- Up to 50 pictures can be selected at a time.

- ④ Delete the selected pictures.



- ⑤ When the message appears, select [YES].



To delete other pictures, repeat steps ③ - ⑤.

- ⑥ End deleting.



Preventing accidental deletion of motion/still pictures

Formatting cards

Preventing accidental deletion

Locking important pictures prevents them from being deleted accidentally. **Even locked pictures are deleted when SD cards are formatted.**

- 1 Set the mode dial to [] or [].
- 2 Make settings from the menus.
(P.26)
MENU
○ → [EDIT SCENE]
(For still pictures,
[PICT. SETUP]) → [LOCK SET] → [YES]

- 3 Select the picture to lock.

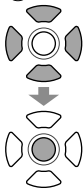

A [] appears on selected pictures.

- Selecting a picture a second time deselects it from locking.
- Multiple pictures can be selected at a time.

- 4 End locking.



Formatting cards

All data, including locked pictures, are deleted and cannot be restored when SD cards are formatted.

Save important data on a PC ahead of time using the MotionSD STUDIO, etc.

- 1 Make settings from the menus.
(P.26)
MENU
○ → [SETUP] → [FORMAT CARD] → [YES]

- 2 When the message appears, select [YES].

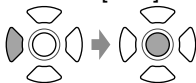

- 3 End formatting.



- Use a sufficiently charged battery or the AC adaptor. Do not shut off power or open the card/battery door while formatting cards.
- Format SD cards with this unit. If cards are formatted on a PC or other device, recording may take time and the cards may be unusable with the unit.
- Some SD cards require time to format.

Setting DPOF for still pictures

DPOF is the acronym for Digital Print Order Format and designates which still pictures are to be printed and how many copies are to be made on SD cards. This information can be used by DPOF printers and stores.

① Set to [▶].

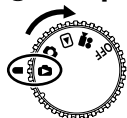

② Make settings from the menus.

(P.26)

MENU

○ → [PICT. SETUP] →
[DPOF SET] → [SET]

③ Select the still pictures to print.

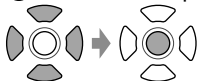

④ Set the number of copies.

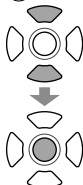

Number of copies (Up to 999)

Set "0" to not print the picture.

⑤ End setting.

MENU



■ To cancel the setting

MENU

➡ ○ → [PICT. SETUP] →
[DPOF SET] → [CANCEL ALL]

When the message appears,
select [YES].

- Up to 999 still pictures can be selected by repeating steps ③ and ④.
- You cannot add the recording date to pictures for printing.
- DPOF settings made on other devices may not be recognized. Make settings with this unit.

Playback on TV

Motion pictures and still pictures recorded with this unit can be viewed on TV. For TV settings, see the operating instructions of the TV.

- ① Connect the unit and AC adaptor (P.20) and set the mode dial to [▶] or [📷].
- ② Connect the unit and TV with the AV cable (supplied).

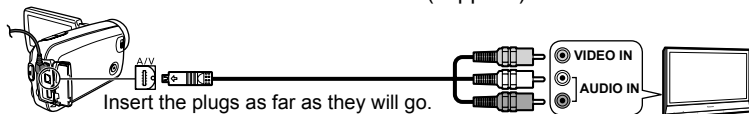

- ③ Change the input mode on the TV.
- ④ Play back motion pictures or still pictures from the unit. (P.52, 55)

■ To display LCD monitor information on TV

MENU
 ➔ ○ → [SETUP] → [EXT. DISPLAY] → [ON]

- To not display the date, time and icons (P.28, 32)

-
- Do not use any other AV cables except the supplied one.
 - If images or audio are not output, check the following:
 - That the plugs on the AV cable are inserted into terminal as far as they can go
 - That the plugs on the AV cable are connected to the correct terminals
 - That input settings and the selected input channel of the TV are correct
 - If pictures are not displayed correctly on a wide-screen TV, adjust the display settings of the TV.
 - If the image stretched in the vertical direction on TVs of a 4:3 aspect ratio

MENU
 ➔ ○ → [SETUP] → [TV ASPECT] → [4:3]

Copying to video recorders or DVD recorders

Motion pictures recorded with this unit can be copied to TV video recorders and DVD recorders (hereinafter referred to as "recorder"). For recorders settings, see the operating instructions of the recorders.

Copying pictures using the AV cable (supplied)

- 1 Connect the unit and AC adaptor (P.20) and set the mode dial to [▶].
- 2 Connect the unit and recorder with the AV cable (supplied).

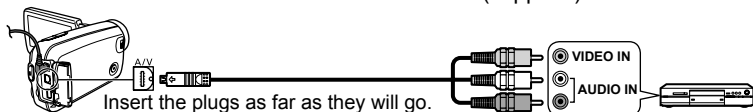

- 3 Change the input mode on the TV and recorder.
- 4 Play back motion pictures from the unit (P.52) and start recording on the recorder.
- 5 After ending recording on the recorder, stop playback from the unit.

- Do not use any other AV cables except the supplied one.
- When copied motion pictures are played back on a wide-screen TV, the image may be stretched in the vertical direction. In such case, see the operating instructions of the recorder. Also, see the operating instructions of the wide-screen TV and set aspect ratio to 16:9 (full).

Copying (dubbing) pictures using DVD recorders with SD card slot

By inserting SD cards recorded on this unit into DVD recorders with an SD card slot, pictures can be copied onto hard disk drives and DVDs.

- 1 After shutting off power to the unit, eject the recorded SD card. (P.23)
- 2 Insert the SD card into the SD card slot of the DVD recorder.

- For details, see the operating instructions of the DVD recorder.
- The video format is converted when motion pictures recorded with this unit are copied onto hard disk drives or DVDs. The converted motion picture cannot be copied at high speed onto DVD-R discs. Moreover, motion pictures that are copied back onto SD cards using a computer or other device do not play back on this unit.

Printing pictures from PictBridge printers

- ① Connect the unit and AC adaptor (P.20), and set the mode dial to a setting other than [OFF].
- ② Connect the unit and printer with the USB cable (supplied).

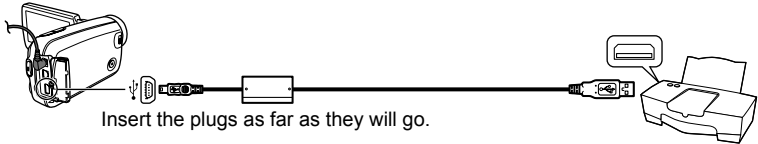

- ③

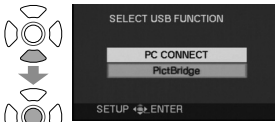

Select [PictBridge].

- ④



Select the still pictures to print.

- ⑤



Set the number of copies.

- To not print the picture, set "0".
- Repeat steps ④ and ⑤ to select up to 8 still pictures for printing.

Number of copies (Max. 9)

- Do not use any other USB connection cables except the supplied one. (Operation is not guaranteed with any other USB cables.)
- Connect the unit directly to the printer without going through a USB hub.
- For paper size and print quality, etc., check printer settings.
- Avoid the following operations during printing. Otherwise, pictures will not print correctly:
 - Disconnecting the USB cable
 - Opening the card/battery door
 - Rotating the mode dial
 - Shutting off power

Still pictures recorded with this unit can be printed by connecting the unit directly to a printer that supports PictBridge.

⑥ MENU



Display the PictBridge menu.
Make print settings.

■ Print settings

Item	Available settings
DATE PRINT	OFF/ON
PAPER SIZE	STANDARD: Prioritize printer setting. 4×5 INCH: L size 5×7 INCH: 2L size 4×6 INCH: Postcard size A4: A4 size
PAGE LAYOUT	STANDARD: Prioritize printer setting. : No frame print : Frame print

● Settings not supported by the printer cannot be selected.

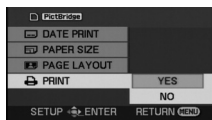
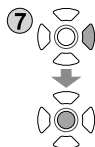

[PRINT]→[YES]
When printing is complete, disconnect the USB cable (supplied) and exit [PictBridge].

■ To cancel printing →



A confirmation message appears.

[YES]: Cancels print settings and returns to step ④.

[NO]: Saves print settings made in steps ④ - ⑦ and returns to step ④.

- Still pictures recorded with other devices may not be printed.
- DPOF settings (P.59) cannot be used while this unit is directly connected to a PictBridge printer.

Using DVD burners (sold separately)

■ Required equipment (as of February 2008)

- DVD burner (VW-BN1*)
- Mini AB USB connection cable (included with DVD burner)
- * Use with the VW-BN1 DVD burner is recommended. No guarantees are given for operations involving the use of any other DVD burner.

■ Supported discs: 12 cm disc

Motion pictures and still pictures	DVD-RAM	New or previously used discs
	DVD-R, DVD-R DL	New discs only
Motion pictures only	DVD-RW*	New or previously used discs
Still pictures only	CD-RW	New or previously used discs
	CD-R	New discs only

* The recording mode used for the DVD-RW is "video mode."

- +RW/+R/+R DL discs or 8 cm discs cannot be used for copying.
- All content written on discs is erased before copying begins. Check whether data is needed or not before using the disc.
- When copying is finished, finalizing is initiated automatically. Finalized discs can be played back only. No further motion pictures or still pictures can then be added to these discs.
- For the following, see the operating instructions of the DVD burner:
 - Recommended discs and disc handling
 - Connections to DVD burners using the mini AB USB connection cable
 - Operation of the DVD burner itself

■ Time required for copying (Reference)

(When a 4 GB motion picture has been copied to a disc using the VW-BN1 drive)

Disc type	DVD-RAM	DVD-RW	DVD-R
Copying time	Approx. 40 to 90 min	Approx. 30 to 60 min	Approx. 15 to 60 min

- The time taken to copy a disc differs depending on the number of scenes recorded, the types of discs used, the number of discs needed for copying and the ambient temperature.
- Copying to DVD-R DL discs may take 1.5 to 2 times longer than for DVD-R discs.
- In order for the copied data to be verified, the copying process may take longer than the recording time. Wait until the data copied message appears.

Motion pictures and still pictures recorded with this unit can be copied to discs using DVD burners (sold separately).

Connecting this unit and a DVD burner

- 1 Connect the AC adaptor provided with the DVD burner to the DVD burner.
- 2 Connect the unit and AC adaptor (P.20) and set the mode dial to a position other than [OFF].
- 3 Connect this unit and the DVD burner with the mini AB USB connection cable.

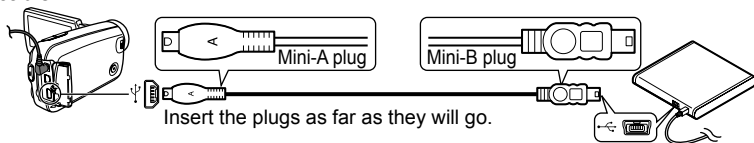

- 4 Insert a disc into the DVD burner.



[DVD BURNER] display

- Once connected, the [DVD BURNER] display appears on the LCD monitor of the unit. If it does not appear, reconnect the mini AB USB connection cable.
- First connect the DVD burner to the unit, and then insert the disc.

- Use the mini AB USB connection cable that comes with the DVD burner (sold separately). Operation is not guaranteed with other cables.
- Connect the unit directory to the DVD burner without going through a USB hub.
- Ensure without fail that only the AC adaptors designed solely to be used with the unit and DVD burner are connected. Power cannot be supplied from the unit to the DVD burner using a USB connection. While powered by the battery, the unit and DVD burner cannot be connected for use.
- If the DVD burner is connected to this unit with a disc already inserted, the message "CANNOT CHECK CONNECTED DEVICE. DISCONNECT THE USB CABLE FROM THIS UNIT." may be displayed after "Please Wait." is displayed for over a minute. When this happens, disconnect the Mini AB USB Connection Cable from the unit and remove the disc from the DVD burner to make sure the disc is usable and was not inserted upside down.
- If "READING DISC..." is displayed on the screen for more than 2 minutes, remove the disc from the DVD burner and make sure the disc is usable and was not inserted upside down.

With still pictures, all scenes are copied at once. With motion pictures, either all scenes can be copied or specific scenes or scenes on specific dates can be selected and copied.

Copying still pictures to discs

① Select [BURN DISC] on the [DVD BURNER] display (P.65).

② Select [PICTURE].

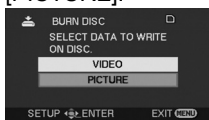

Copying begins. Hereafter, operate the unit as instructed by the displayed messages.

■ To cancel copying

MENU

Press . The [DVD BURNER] display now returns.

- After copying the still pictures, another disc with the same pictures can be created.

Copying all motion pictures to discs

① Select [BURN DISC] on the [DVD BURNER] display (P.65).

② Select [VIDEO] → [DVD COPY] → [ALL SCENES] or [ADDED SCENES].

[ALL SCENES]: All the motion pictures are copied.

[ADDED SCENES]: Motion pictures additionally recorded after copying using [DVD COPY] (ones for which is not indicated) are copied onto another disc.

③ Select [YES].

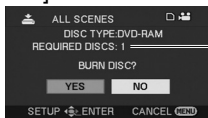
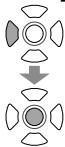

The number of discs required for the copying is displayed. If two or more discs are required, change over the discs as instructed by the displayed messages.

Hereafter, operate the unit as instructed by the displayed messages.

■ To cancel copying

MENU

Press . The [DVD BURNER] display now returns.

- is displayed for the thumbnails of motion pictures which have already been copied using [DVD COPY]. All motion pictures for which is indicated can be deleted together. (P.69)
- After copying the motion pictures, another disc with the same pictures can be created.

Motion pictures and still pictures recorded with this unit can be copied to discs using DVD burners (sold separately).

Copying selected motion pictures to discs

- 1 Select [BURN DISC] on the [DVD BURNER] display (P.65).
- 2 Select [VIDEO] → [FAVOURITE SCENES] → [SELECT SCENES] or [SELECT DATE].

■ SELECT SCENES

- 3 Select thumbnails.



The selected thumbnail is enclosed in a red frame. The frame is released when the center of the cursor button is pressed again.

- 4 Enter selections.

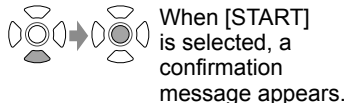

- 5 Copying begins.

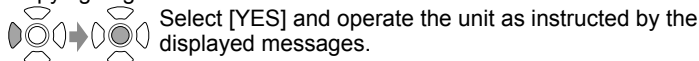

■ To cancel copying

Press . The [DVD BURNER] display now returns.

■ SELECT DATE

- 3 Select a date.

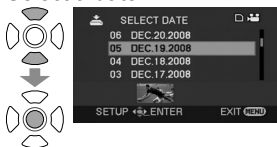

The selected date is enclosed in a red frame. The frame is released when the center of the cursor button is pressed again.

- 4 Enter selections.

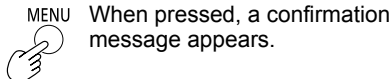

- Repeat step 3 to select multiple motion pictures. Up to 50 motion picture scenes can be selected at a time when “SELECT SCENES” is selected and up to 50 days of motion pictures when “SELECT DATE” is selected.
- With [SELECT SCENES], the scenes are copied onto one disc. If the total size of the motion picture exceeds the disc capacity, “Remaining disc space” appears in red, and the exceeded capacity is displayed. Select the scenes that will fit onto one disc.
- With [SELECT DATE], the number of discs required for copying is displayed. If two or more discs are required, change over the discs as instructed by the displayed messages.
- After copying the motion pictures, another disc with the same pictures can be created.

■ Copying using a DVD burner

- After copying is complete but before erasing the data on the SD card, check that the disc plays back and that data was copied correctly. (P.69)
- While copying is underway, do not turn off the power of the unit or DVD burner or disconnect the mini AB USB connection cable. Also, do not subject the unit or DVD burner to impact.
- While copying is underway, the disc cannot be removed.
- Pictures are copied in the order in which they were recorded. Copying sequence cannot be changed.
- Pictures from multiple SD cards cannot be copied onto the same disc.
- Motion pictures and still pictures cannot be copied onto the same disc.
- A maximum of 9,999 pictures can be copied onto a single disc.
- If two or more discs are required for copying, the motion picture which will be copied last on each disc will be automatically split up.
- The recording date for scenes or files copied to a disc using the DVD burner with this unit is the date that the scene or file was copied. This date may not be displayed properly depending on the software used.
- Motion pictures that are copied back to an SD card using the software packaged with the unit cannot be copied to discs on a DVD burner.
- It may not be possible to copy data which has been recorded by another unit. Such data may not be played back even if it is copied successfully.
- When still pictures have been copied onto an SD card using a computer, for instance, whatever is not displayed by the unit cannot be copied onto a disc.
- Depending on the playback device, it may not be possible to play back discs which have been created by connecting the DVD burner and the unit.
- When a disc that was created with this unit and the DVD burner is inserted into the DVD recorder, a message may be displayed prompting you to format the disc. Do not format the disc because all data will be erased and cannot be recovered.
Refer to the operating instructions of the DVD recorder for details.

Motion pictures and still pictures recorded with this unit can be copied to discs using DVD burners (sold separately).

Playing back discs

- 1 Select [PLAY DISC] on the [DVD BURNER] display (P.65).
- 2 Select a thumbnail and play back the picture.

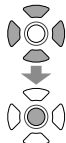

For details, see the pages below:

- Viewing motion pictures (P.52)
- Viewing still pictures (P.55)

■ To cancel

MENU

Press . The [DVD BURNER] display now returns.

- When discs containing motion pictures and still pictures copied from other devices are played back from the unit, only the motion pictures are played back. It may not be possible to play back the discs which have been recorded by other units.

Exiting

- 1 Display the [DVD BURNER] display. (P.65)

MENU



- 2 Remove the disc from the DVD burner.
- 3 Disconnect the mini AB USB connection cable.

Deleting copied motion pictures

Motion pictures with a  can be deleted all at once.

- 1 Set the unit's mode dial to .
- 2 Make menu selections. (P.26)

MENU

 → [EDIT SCENE] → [DELETE] → [COPIED] → [YES]

- 3 End deleting.

MENU



The supplied CD-ROM contains the software below:
This CD-ROM can only be used on Windows computers.

■ Video editing software MotionSD STUDIO 1.3E

This software allows motion pictures and still pictures to be acquired from this unit, edited and output.

The acquired motion pictures and still pictures can also be attached to e-mail or edited and saved on DVD.

For information about how to use MotionSD STUDIO, read the PDF operating instructions.

■ DirectX (For Windows 2000)

To use MotionSD STUDIO, you must have Microsoft DirectX 9.0b or 9.0c.

If it is not installed on your computer, install it as follows:

- Install DirectX when installing MotionSD STUDIO.
- Click [DirectX] in the Setup Menu to install.
- Depending on the operating environment, software applications supporting older versions of DirectX may not run properly after installing DirectX 9.0b or 9.0c. If this happens, contact the manufacturer of these applications. (Your computer must support DirectX 9.0b or 9.0c.)

• We cannot guarantee proper operation of this unit if you use software other than that supplied.

Before opening the CD-ROM package, please read the following.

End User License Agreement

You ("Licensee") are granted a license for the Software defined in this End User License Agreement ("Agreement") on condition that you agree to the terms and conditions of this Agreement. If Licensee does not agree to the terms and conditions of this Agreement, promptly return the Software to Matsushita Electric Industrial Co., Ltd. ("Matsushita"), its distributors or dealers from which you made the purchase.

Article 1 License

Licensee is granted the right to use the Software, including the information recorded or described on the CD-ROM, instruction manuals, and any other media provided to Licensee (collectively "Software"), but all applicable rights to patents, copyrights, trademarks and trade secrets in the Software are not transferred to Licensee.

Article 2 Use by a Third Party

Licensee may not use, copy, modify, transfer or allow any third party, whether free of charge or not, to use, copy or modify the Software, except as expressly provided for in this Agreement.

Article 3 Restrictions on Copying the Software

Licensee may make a single copy of the Software in whole or in part solely for back-up purpose.

Article 4 Computer

Licensee may use the Software only on one computer, and may not use it on more than one computer.

Article 5 Reverse Engineering, Decompiling or Disassembly

Licensee may not reverse engineer, decompile, or disassemble the Software, except to the extent either of them is permitted under law or regulation of the country where Licensee resides.

Matsushita, or its distributors will not be responsible for any defects in the Software or damage to Licensee caused by Licensee's reverse engineering, decompiling, or disassembly of the Software.

Article 6 Indemnification

The Software is provided "AS-IS" without warranty of any kind, either expressed or implied, including, but not limited to, warranties of non-infringement, merchantability and/or fitness for a particular purpose. Further, Matsushita does not warrant that the operation of the Software will be uninterrupted or error free. Matsushita or any of its distributors will not be liable for any damage suffered by Licensee arising from or in connection with Licensee's use of the Software.

Article 7 Export Control

Licensee agrees not to export or re-export to any country the Software in any form without the appropriate export licenses under regulations of the country where Licensee resides, if necessary.

Article 8 Termination of License

The right granted to Licensee hereunder will be automatically terminated if Licensee contravenes any of the terms and conditions of this Agreement. Upon termination hereof, Licensee must destroy the Software and related documentation together with all the copies thereof at Licensee's own expense.

- Even if the system requirements mentioned in these operating instructions are fulfilled, some personal computers cannot be used.
- This software is not compatible with Microsoft Windows 3.1, Windows 95, Windows 98/98SE, Windows Me and Windows NT.
- Operation on an upgraded OS is not guaranteed.
- Operation on an OS other than the one pre-installed is not guaranteed.

■ Operating environment required for MotionSD STUDIO

Supported computers	IBM PC/AT or compatible preinstalled with the OS below
OS	Microsoft® Windows® 2000 Professional SP4 Microsoft® Windows® XP Professional/Home Edition SP2 Microsoft® Windows Vista® Home Basic/Home Premium
CPU	Intel® Pentium® III 800 MHz or higher (including compatible CPUs. Intel® Pentium® 4 1.6 GHz or higher recommended)
RAM	Windows 2000 / XP : 256 MB or more (512 MB or more recommended) Windows Vista : 512 MB or more (1 GB or more recommended)
Free hard disk space	Ultra DMA-33 or more (100 or more is recommended) 640MB or more (When writing to DVD, the same amount of free space as the disc is necessary.)
Display	High Color (16 bit) or more (32 bit recommended) Desktop resolution of 1024 x 768 pixels or more (1280x1024 pixels or more recommended) Graphic accelerator supporting DirectX 9.0b or 9.0c, and DirectDraw overlay
Sound	Sound device compatible with Windows (DirectSound® support)
Drive	CD-ROM drive (for installation) When writing to DVD, a compatible drive and media are necessary.
Interface	USB port (Hi-Speed USB (USB 2.0) recommended)
Other requirements	Mouse or equivalent pointing device
Necessary software	Windows 2000 / XP : DirectX® 9.0b or 9.0c (9.0c is already installed with Windows® XP SP2) Windows Vista : DirectX® 10 (already installed with Windows Vista®) <ul style="list-style-type: none"> • If this software is installed on a PC that does not support DirectX® versions above, the PC may not operate properly. If you are unsure if your personal computer is compatible, contact the maker. Microsoft® Windows Media® Player 6.4 to 11

A computer with the specifications below is required to use this software.

- Supplied CD-ROM is available for Windows only.
- When two or more USB devices are connected to one PC, or when devices are connected through USB hub or by using USB extension cable, operation is not guaranteed.
- This software is not compatible with a multi-CPU environment.
- This software is not compatible with a multi-boot environment.
- Operation is not guaranteed on Microsoft Windows XP Media Center Edition, Tablet PC Edition and not compatible with 64 bit operation systems.

■ Operating environment required for external drives (Mass storage)

Supported computers	IBM PC/AT or compatible preinstalled with the OS below
OS	Microsoft® Windows® 2000 Professional SP4 Microsoft® Windows® XP Home Edition/Professional Microsoft® Windows® Vista® Home Basic/Home Premium/ Ultimate/Business/Enterprise
CPU	Windows 2000 / XP : Intel® Pentium® III 450 MHz or higher or Intel® Celeron® 400 MHz or higher Windows Vista : Including compatible CPUs. Intel® Pentium® 4 1.6 GHz or higher recommended
RAM	Windows 2000 / XP : 128 MB or more (256MB or more recommended) Windows Vista Home Basic : 512 MB or more Windows Vista Ultimate, Business, Home Premium, Enterprise : 1 GB or more
Interface	USB port
Other requirements	Mouse or equivalent pointing device

- USB connection: Data can be written to a computer.

-
- Microsoft®, Windows®, Windows Vista®, Windows Media®, DirectX®, DirectDraw® and DirectSound® are either registered trademarks or trademarks of Microsoft Corporation in the United States and/or other countries.
 - IBM® and PC/AT are registered trademarks of International Business Machines Corporation of the U.S.
 - Intel® and Pentium® and Celeron® are registered trademarks or trademarks of Intel Corporation in the United States and other countries.
 - Other names of systems and products mentioned in these instructions are usually the registered trademarks or trademarks of the manufacturers who developed the system or product concerned.

- Before installing the software, check your operating environment (P.72) and close any other software applications which are running.
- Do not perform other computer operations while installing the software.
- Do not connect this unit to the computer until installation is complete.
- Install MotionSD STUDIO only from the supplied CD-ROM.

- ① Insert the supplied CD-ROM into your computer.
The Setup Menu starts automatically.



- ② Click [MotionSD STUDIO 1.3E].
If installation is stopped halfway through, the software may not run properly.



- ③ Click [Next].
Continue to follow the on-screen messages to install it.
- Depending on the operating environment, you may be required to install DirectX.
If so, click [Yes] and install it.

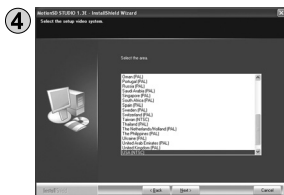

- ④ Select a video system and click [Next].
[Readme.txt] is displayed when installation is complete. Be sure to check the contents.

- ⑤ Click [Finish].
Selecting "Yes, I want to restart my computer now." automatically restarts the computer and completes installation.
Eject the CD-ROM from the computer.

After the installation is finished, the icon  is displayed in the task tray.
When this unit and the computer are connected with the USB cable, the [SD Browser auto start] dialog box appears. (P.76)

After installation is complete, clicking on [MotionSD STUDIO 1.3E] in the Setup menu starts up the Uninstaller. Click [EXIT] in the Setup menu to close the menu.

- MotionSD STUDIO only runs on Windows computers.
- Install and uninstall the software with administrator authorization.

■ If the Setup Menu does not start up automatically

Double-click the CD-ROM icon [] containing the CD-ROM drive in [My Computer].

■ Uninstalling the software

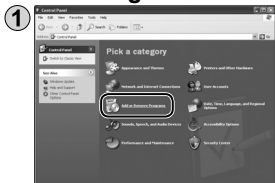

- For Windows 2000 or XP
Click [Start] → ([Settings] →) [Add or Remove Programs (Applications)] in the [Control Panel].

- For Windows Vista
From the Start menu, select [Control Panel] → [Programs] → [Uninstall Program].



- Select [MotionSD STUDIO 1.3E] and click [Remove] or [Uninstall/Remove].
Continue to follow the on-screen messages to uninstall it.
After uninstalling the software, restart the computer.

■ Reading the MotionSD STUDIO operating instructions (PDF file)

Click [All Programs (or [Programs])] → [Panasonic] → [MotionSD STUDIO 1.3E] → [Manual] from the Start menu in Windows.

Or, select [Manual] from the [Help] menu at the top of the [Edit Screen] windows in MotionSD STUDIO.

- Adobe Acrobat Reader 5.0 or later or Adobe Reader 7.0 or later is required to read the PDF operating instructions.

Importing motion pictures and still pictures

When this unit is connected to the computer, MotionSD STUDIO starts up automatically.

- To use the application with Windows Vista, log on with administrator authorization or via a standard user account. Guest accounts cannot be used. To use the application with Windows XP or 2000, log on with administrator authorization.
 - Before using MotionSD STUDIO, please read [Readme First] by selecting from the start menu. This file contains additional instructions or updated information.
 - The very first time that the software is started up, the End User License Agreement is displayed. Read it carefully and click [I agree].
- ① Connect the unit and AC adaptor (P.20) and set the mode dial to a position other than [OFF].
 - ② Connect this unit and a computer with the USB cable (supplied).

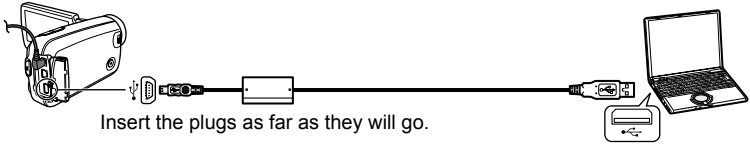

Insert the plugs as far as they will go.

- ③ Select [PC CONNECT] on the [SELECT USB FUNCTION] screen of the unit. The [SD Browser auto start] dialog box appears.
 - ④
- Click [Yes].
The [SD Browser] window appears, therefore do as instructed by displayed messages.



- Do not use any other USB connection cables except the supplied one. (Operation is not guaranteed with any other USB cables.)
- **Do not disconnect the USB cable or shut off the power while the card access lamp is lit.**
- The first time the unit is connected to the computer, the computer may have to be restarted.
- To output motion pictures edited with MotionSD STUDIO to SD cards, use an applicable SD card. (P.18)
- When outputting a large number of scenes to an SD card, DVD-R/RW or DVD-RAM, it may take time to display thumbnails or to output.

For a detailed explanation on how to use the software, see the MotionSD STUDIO operating instructions (PDF file). (P.75)

Editing motion pictures and still pictures

1



Double-click the **MotionSD STUDIO** icon on the desktop. The window at left appears.

• If the icon does not appear on the desktop, select [All Programs (or [Programs])] → [Panasonic] → [MotionSD STUDIO 1.3E] → [MotionSD STUDIO] from the start menu.

2



Click [EXIT this screen]. The startup window appears.

Closing MotionSD STUDIO

■ From the [SD Browser] screen



Click **Exit** in the lower right-hand corner of the screen.

■ From the [Edit Screen] screen



Click **Exit** in the lower left-hand corner of the screen.

Or, select [Exit] from the [File] menu.

Connecting the unit to a computer

Use the AC adaptor to supply power to this unit and connected devices.

- 1 Connect the unit and AC adaptor (P.20) and set the mode dial to a position other than [OFF].
- 2 Connect this unit and a computer with the USB cable (supplied). (P.76)
- 3 Select [PC CONNECT].

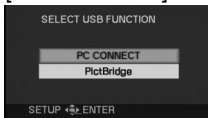
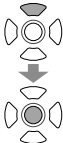

- The SD card in the unit appears on the computer as an external drive.

- When this unit is connected to the computer, [Removable Disk] appears in [My Computer].
- The SD card appears as an external drive (E drive, etc.) in Windows Explorer.
- While the computer is accessing the SD card of this unit, [↔] appears at the bottom right of the unit's LCD monitor.

Disconnecting the unit

- 1 Click the [🔌] or [🖨️] icon on the task bar.
- 2 Click "Safely remove USB Mass Storage Device."
- 3 When the disconnection confirmation message appears, click [OK].
- 4 Disconnect the USB cable (supplied) from the computer.

This unit can be used as an external drive.

SD card folder structure

The content of the SD card in the unit can be checked from the computer. Motion pictures and still pictures recorded with the unit are saved in the folder tree below.

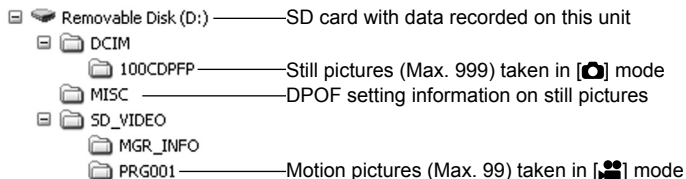

- Do not move, rename, delete, compress, format or perform other operations to the motion pictures or folders using Windows Explorer or the Macintosh Finder. Motion pictures will no longer play back.
- To edit motion pictures, use software capable of editing SD-Video files, such as MotionSD STUDIO.

• Data not supported by this unit cannot be played back on this unit even if copied onto an SD card.

- ① Connect this unit and a computer with the USB cable (supplied). (P.76)
- ② Display the Device Manager.
 - For Windows 2000
Click [Start] → [Settings] → [Control Panel] → [System] → [Hardware] tab → [Device Manager] button.
 - For Windows XP
Click [Start] → [Control Panel] → [Performance and Maintenance] → [System] → [Hardware] tab in the [System Properties] window → [Device Manager] button.
 - For Windows Vista
From the Start menu, select [Control Panel] → [System and Maintenance] → [System] → [Device Manager] (from the [Task] window).
If a confirmation window appears halfway through, click the [Continue] button.

■ When the driver is recognized

[USB Mass Storage Device] appears in [Universal Serial Bus controllers].
(The display differs according to the type of computer.)

■ When the driver is not recognized

[!] or [Unknown device] appears in [Universal Serial Bus controllers] or [Other devices].

Try the following.

- Method [1] : Turn off the unit and your computer once and turn on again to reconnect.
- Method [2] : Remove the SD card from the unit and insert it back into the unit.
- Method [3] : Connect the USB cable to another USB port on the computer.
- If the driver cannot be recognized by any of the methods above, contact the computer manufacturer.

Operating environment required for external drives

Supported computers	Macintosh
OS	Mac OS X 10.4 "Tiger" (Don't have to install USB Driver.)
CPU	PowerPC G5 1.8 GHz or higher Intel® Core™ Duo, Intel® Core™ Solo
RAM	64 MB or more
Interface	USB port

- Even if the system requirements mentioned in these operating instructions are fulfilled, some personal computers cannot be used.

Connecting the unit to a computer

Connect this unit and a computer with the USB cable (supplied). (P.76)

An icon labeled [NO_NAME] or [Untitled] appears on the desktop.

Copying still pictures to computers

- ① Double click the [NO_NAME] or [Untitled] icon on the desktop.
The still pictures are in the [100CDPFP] folder inside the [DCIM] folder.
- ② Drag and drop the still pictures to copy onto the computer.



















Disconnecting the unit

- ① Drag and drop the [NO_NAME] or [Untitled] icon to the Trash.
- ② Disconnect the USB cable (supplied) from the computer.

-
- Apple, Mac OS is either registered trademarks or trademarks of Apple Inc. in the United States and/or other countries.
 - PowerPC® is a trademark of International Business Machines Corporation.
 - Intel® Core™ is registered trademarks or trademarks of Intel Corporation in the United States and/or other countries.
 - Other names of systems and products mentioned in these instructions are usually the registered trademarks or trademarks of the manufacturers who developed the system or product concerned.









Recording menu

Set the mode dial to  or .

Top menu	Submenus	Purpose
 BASIC	 SCN SCENE MODE	Use settings tailored to specific scenes.
	 GUIDE LINES	Check composition for tilting.
	 REC MODE	Set the motion picture recording mode.
	 PICT.QUALITY	Set still picture quality.
	 CLOCK SET	Set the date/time.
	 SET WORLD TIME	Set the local date/time of travel destinations.
 ADVANCED	 D.ZOOM	Use the digital zoom.
	 EIS	Avoid jitter.
	 WIND CUT	Reduce the wind noise.
	 ZOOM MIC	Apply zoom effect to sounds.
	 AUTO SLW SHTR	Adjust shutter speed automatically.
	 SHTR EFFECT	Cancel out shutter sound.
	 ASPECT	Set aspect ratio for recording.
 FADE COLOR	Change the fade color.	
 SETUP		Make basic settings.
 LANGUAGE		Select the menu and display language.

Playback menu

Set the mode dial to  or .

Top menu	Submenus	Purpose
 EDIT SCENE	 LOCK SET	Prevent accidental deleting.
	 DELETE	Delete scenes.
 PICT. SETUP	 LOCK SET	Prevent accidental deleting.
	 DPOF SET	Write print information onto SD cards.
 SETUP		Make basic settings.
 LANGUAGE		Select the menu and display language.















Recording and playback functions can be used and basic settings made.
(For setting procedures, see P.26.)

- Settings enclosed in are active at the time of purchase.

	Settings/Notices	Mode	Page
<input type="checkbox"/>	OFF / / / / /		45
<input type="checkbox"/>	OFF / ON		51
<input checked="" type="checkbox"/>	XP / <input checked="" type="checkbox"/> SP / <input checked="" type="checkbox"/> LP		33
<input checked="" type="checkbox"/>	/		35
	YES / NO		28
	YES / NO		50
<input type="checkbox"/>	OFF / 25x / 700x		36
	OFF / <input checked="" type="checkbox"/> ON		37
	OFF / <input checked="" type="checkbox"/> ON		51
	<input type="checkbox"/> OFF / ON		37
	OFF / <input checked="" type="checkbox"/> ON		37
	OFF / <input checked="" type="checkbox"/> ON		34
	4:3 / <input checked="" type="checkbox"/> 16:9		32
	WHITE / <input checked="" type="checkbox"/> BLACK		39
	For details on the SETUP menu (P.84)		—
	<input checked="" type="checkbox"/> English / Français / Español		27















































	Settings/Notices	Mode	Page
	YES / <input checked="" type="checkbox"/> NO		58
	ALL / SELECT / COPIED / NO		56, 69
	YES / <input checked="" type="checkbox"/> NO		58
	CANCEL ALL / SET / NO		59
	For details on the SETUP menu (P.84)		—
	<input checked="" type="checkbox"/> English / Français / Español		27

 SETUP menu

Item	Purpose
 DISPLAY	Display current information or settings on the LCD monitor. •Even when this item is set to [OFF], the operating status, date and world time will remain displayed.
 DATE/TIME	Select the date and time display mode.
 DATE FORMAT	Select the date display format.
 FORMAT CARD	Format SD cards.
 QUICK START	Start recording instantly.
 POWER SAVE	Shut off power if the unit is not being operated. This function does not work in the following cases. •While using the AC adaptor •While connected to a computer or printer via USB
 AUDIO REC	Set the audio recording mode. In this unit, the audio mode cannot be changed after recording, but if MotionSD STUDIO provided with the unit is used, sound can be recorded on DVD discs using [DOLBY] or on SD cards using [MPEG].
 BEEP SOUND	Allow operations such as starting and ending recording to be signaled by a beep. When [ON] Beep: •When recording starts or power is turned on •When a computer or printer is recognized Beep-Beep: •When recording stops or power is shut off Beep-Beep, Beep-Beep ... (4 times consecutively): •If an error that prevents recording occurs, etc. Check the message (P.88) that appears on the LCD monitor.
 POWER LCD	Brighten the LCD monitor more than usual.
 LCD SET	Adjust brightness or color density of the LCD monitor.
 TV ASPECT	Display images at the aspect ratio of a connected TV.
 EXT. DISPLAY	Display information on a connected TV.
 RESUME PLAY	Continue playback from the point it was stopped.
 INITIAL SET	Return all settings except for [LANGUAGE] and [CLOCK SET] to their defaults at the time of purchase.
 DEMO MODE	Display an introduction to the unit (demonstration mode). The demonstration stops when any operation except pressing the [AUTO] or [MANUAL AF/MF] button is performed, but it will resume if no operations are performed for approx. 10 or more minutes.

Recording and playback functions can be used and basic settings made.
(For setting procedures, see P.26.)

- Settings enclosed in are active at the time of purchase.

Settings/Notices	Mode	Page
OFF / <input type="checkbox"/> ON	   	32
OFF / D/T / <input type="checkbox"/> DATE	   	28
Y/M/D / <input type="checkbox"/> M/D/Y / D/M/Y	   	28
YES / NO	   	58
OFF / <input type="checkbox"/> ON	 	25
OFF / <input type="checkbox"/> 5 MINUTES : Power shuts off if the unit is not operated for about 5 minutes. To resume the unit use, set the mode dial to [OFF] and then the desired mode position.	   	—
<input type="checkbox"/> DOLBY : This audio system setting is suited to saving the data which has been recorded on SD cards, onto DVD discs using a DVD burner. MPEG : This audio system setting is suited to playing back sound on a device which meets the SD-Video standard.		32, 94
OFF / <input type="checkbox"/> ON	   	—
<input type="checkbox"/> * / <input type="checkbox"/> +1* / <input type="checkbox"/> +2* • <input type="checkbox"/> +1* is automatically selected when the AC adaptor is used.	   	29
YES / <input type="checkbox"/> NO	   	29
4:3 / <input type="checkbox"/> 16:9	 	60
<input type="checkbox"/> OFF / ON	   	60
<input type="checkbox"/> OFF / ON		54
YES / NO	 	—
OFF : [OFF] is normally set. <input type="checkbox"/> ON : When the AC adaptor is connected without an SD card having been inserted, the demonstration starts, and it stops when an SD card is inserted.	 	—

When recording

Motion picture recording display

XP/SP/LP	Recording mode (P.33)	0h00m00s	Elapsed recording time (P.32)
+1*/+2*	Power LCD (P.29)		Remaining battery power (P.22)
●/ 	(Red) Recording/Writing to SD card		Soft skin mode (P.41)
 	(Green) Recording pause	ZOOM	Zoom microphone (P.37)
R 1h30m	Remaining time for recording (P.32)		Wind noise reduction (P.51)
AUTO/	Auto mode (P.32)/	16:9	Aspect ratio (P.32)
MNL	Manual mode (P.44)		Image stabilizer (P.37)
	Scene mode (P.45)		Backlight compensation (P.40)
		10x W	Zoom magnification indication (P.36)
			No SD card is inserted/ unusable card
		PRE-REC	PRE-REC function (P.42)
			MagicPix (P.41)
		W/	Fade color (P.39)
		B	
			World time (P.50)
MF	Manual focus (P.44)	DEC.15.2008	Date (P.28)
AWB/	White balance (P.46)	3:30 PM	Time (P.28)
1/30 - 1/8000	Shutter speed (P.48)		
CLOSE / F16	F number (P.49)		
- F2.0 / OPEN			
0dB - 18dB	Gain value (P.49)		

Still picture recording display

0.3M	Number of recording pixels
	Picture quality (P.35)
R 1000	Remaining number of still pictures (P.34)
	Self-timer (P.40)

During playback

Motion picture playback display

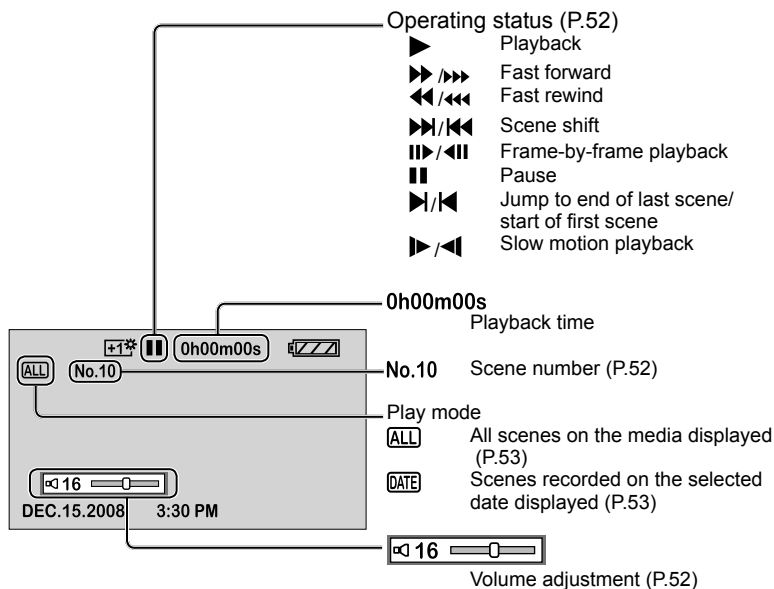

Still picture playback display

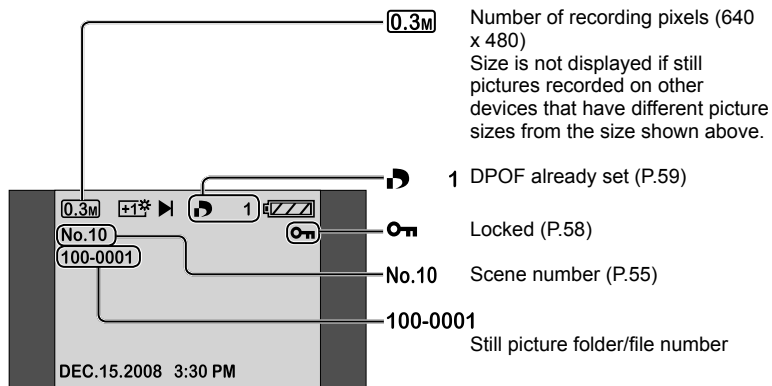

Message	What to check
CANNOT RECORD.	Writing on the SD card failed.
NO DATA.	Neither motion pictures nor still pictures are recorded on the SD card. Data is recorded on the SD card, but if this message appears, the card may be unstable. Shut power off and turn back on.
THIS CARD CANNOT RECORD IN VIDEO MODE.	An 8 MB or 16 MB SD card cannot be used in video recording mode.
CHECK CARD.	The SD card is not supported or cannot be recognized by the unit.
CARD LOCKED.	The SD card is write-protected. (P.19)
CARD FULL.	
SCENE NUMBER IS FULL	The SD card cannot be recorded on because it is full or the numbers of scenes or numbers of scenes for the date has reached the maximum. Either delete unnecessary scenes or insert a new card. (P.56)
CANNOT RECORD. THE NUMBER OF PROGRAM IS FULL.	
CARD DOOR OPENED.	Close the card/battery door.
ERROR OCCURRED. RECORDING IS STOPPED.	<ul style="list-style-type: none"> ● Use a Panasonic SD card or other SD card applicable for motion picture recording. (P.18) ● If this message appears when an applicable card is used, it is recommended to format the card. Formatting deletes all data on the SD card. Therefore, save data on a computer or other device before formatting the card.
EXIT THE MENU THEN CHANGE TO MANUAL MODE.	
CANCEL MAGICPIX MODE.	Functions that cannot be used simultaneously were selected. (P.95)



This section explains the main messages appearing on the LCD monitor and how to deal with them.

Message	What to check
PLEASE CONNECT AC ADAPTOR	You tried connecting the unit to a computer without connecting the AC adaptor.
ERROR OCCURRED. PLEASE TURN UNIT OFF, THEN TURN ON AGAIN.	The unit detected an error. Eject the SD card and shut power off and turn back on.
DISCONNECT USB CABLE.	The unit is not properly connected to a computer or printer. Disconnect and reconnect the USB cable.
CANNOT OPERATE WHILE CONNECTED TO COMPUTER.	Power to the unit cannot be shut off while it is connected to a computer. Disconnect USB cable.
CARD ERROR DETECTED.	The data on the SD card contains errors. To repair the data, either use a battery of sufficient life or connect the AC adaptor. Depending on the error, it may take time to repair the data.
NOW REPAIRING DATA.	The data has been repaired. <ul style="list-style-type: none">• Depending on the situation, the data may not be completely repaired.• If power is shut off without repairing data, data can be repaired the next time that power is turned on.• If repairing fails, the data cannot be played back. Format the SD card with this unit.• Do not repair SD cards recorded on other devices on this unit.
CANNOT CHECK CONNECTED DEVICE. DISCONNECT THE USB CABLE FROM THIS UNIT.	A device that cannot be used with this unit is connected to the unit.
ENVIRONMENT TOO DARK, OR LENS COVER CLOSED.	<ul style="list-style-type: none">• Before recording, open the lens cover.• This message may appear if you try to record in extremely dark place• After the power was turned on, the message is displayed when the initial recording mode is established, but it is not displayed when manual recording is performed.

Problem	What to check
<p>The power does not turn on. The status indicator is flashing while using the battery.</p>	<p>Is the battery sufficiently charged?</p>
<p>Power shuts off on its own.</p>	<p>To conserve the battery, power automatically shuts off if the unit is not operated for about 5 minutes. To resume unit use, set the mode dial to [OFF] and then the desired mode position. When [POWER SAVE] is set to [OFF], power does not shut off automatically. (P.84)</p>
<p>Power shuts off as soon as it is turned on.</p>	<p>Is the battery run down? Charge the battery if the remaining battery life indication is flashing or the [LOW BATTERY] message appears on the LCD monitor. (P.22)</p>
<p>The battery runs down quickly.</p>	<ul style="list-style-type: none"> ● Is the battery sufficiently charged? ● Is the unit being used in low temperatures? The battery is affected by ambient temperature. In cold places, battery availability shortens. ● Is the battery at the end of its service-life? If the battery lasts only a short while when fully charged, it has reached the end of its service-life.
<p>The battery is swollen.</p>	<p>The lithium ion battery used with this unit may swell if charged/discharged often, but this is no risk to safety.</p>
<p>The unit cannot be operated though it is turned on. The unit does not operate normally.</p>	<ul style="list-style-type: none"> ● Is the LCD monitor open? ● Check that the card access lamp is out, then eject the SD card, remove the battery or disconnect the AC adaptor, wait about 1 minute, then reinsert the battery or reconnect the AC adaptor. Then about 1 minute later, shut power off and turn back on. (Performing the above operation while the SD card is being accessed can damage data.)

Problem	What to check
The display changes suddenly.	If the demo (camera introduction) video starts, set [DEMO MODE] to [OFF]. (P.84)
Indications (remaining pictures, elapsed time, etc.) do not appear on the LCD monitor.	When [DISPLAY] of the [SETUP] menu is set to [OFF], indications other than warnings and the date do not appear.
Pictures cannot be recorded even though the SD card is properly inserted.	<ul style="list-style-type: none"> ● Is the SD card write-protected? (P.19) ● Is the SD card full? Either delete unnecessary scenes or insert a new card. (P.56) ● Is the unit in a recording mode? ● Is the card/battery door open?
Motion picture recording stops on its own.	<ul style="list-style-type: none"> ● Are you using an applicable SD card? (P.18) ● Even with applicable SD cards, recording may stop when using an SD card on which data has been written many times. Copy the data to a computer, then format the SD card on this unit. (Formatting deletes all data on the SD card.)
Still pictures come out like mosaics.	When [PICT. QUALITY] is set to [] and detailed subjects are recorded, pictures come out like mosaics. Set to [] when recording. (P.35)
The unit does not focus automatically.	<ul style="list-style-type: none"> ● Is the unit set to manual focus? Press the [AUTO] button to set auto focus. ● Are you recording a scene that is hard to focus automatically? Focus the subject manually. (P.44)
Audio is not output.	Is the volume set low? (P.52)

Problem	What to check
The sound of the motor is being recorded.	This is an operating sound of the unit; there is nothing wrong with the unit.
Images do not appear on TV or appear stretched in the vertical direction.	<ul style="list-style-type: none"> ● Does the input mode on the TV match the connected terminals? Set input to the connected terminals as explained in the TV's operating instructions. ● Set [TV ASPECT] to match the connected TV. (P.60)
Data cannot be deleted.	<ul style="list-style-type: none"> ● Is the scene locked? Unlock the scene. (P.58) ● Scenes whose thumbnails have a [!] cannot be deleted. If the data is unnecessary, format the SD card (P.58). Formatting deletes all data on the SD card. ● Is the SD card write-protected? (P.19)
Images on the SD card do not look normal.	The scene may be damaged. Scenes can be damaged by static electricity and electromagnetic waves. Save important data on a computer, etc.
The SD card cannot be used even after formatting with this unit.	This unit or the SD card may be broken. Consult the dealer from which you purchased the unit. For SD cards applicable with this unit (P.18)
The unit does not recognize the SD card when inserted.	Was the SD card formatted on the computer? Format SD cards with the unit. Formatting deletes all data on the SD card. Data cannot be restored afterwards. (P.58)

Problem	What to check
<p>The indication disappears, the display does not work or cannot be operated.</p>	<ul style="list-style-type: none"> ● Is the unit connected to a computer? When connected to a computer, the unit cannot be operated from the unit itself. ● Shut the power off. If power does not shut off, eject the SD card, remove and then reinsert the battery (disconnect and reconnect the AC adaptor), and turn back on. If the unit still does not work right, disconnect the power supply and consult the dealer from which you purchased the unit.
<p>The SD card is not recognized when inserted into other devices.</p>	<p>Check the supported SD cards in the device's operating instructions.</p>
<p>The computer does not recognize the unit even when connected with USB cable.</p>	<ul style="list-style-type: none"> ● While the menu appears on the LCD monitor, the USB function screen does not appear even if the USB cable is connected. Close the menu, then connect the USB cable. ● Is the AC adaptor connected? ● If the computer has multiple USB terminals, try using another terminal. ● Check the operating environment. (P.72) ● Disconnect the USB cable, shut the power off and turn back on, then reconnect the cable.
<p>After disconnecting the USB cable, an error message appears on the computer.</p>	<ul style="list-style-type: none"> ● For Windows To safely disconnect the USB cable, click the  or  icons in the task tray, and do as instructed by displayed messages. ● For Macintosh Drag the unit icon to the Trash, then disconnect the USB cable.

Problem	What to check
[ERROR OCCURRED. PLEASE TURN UNIT OFF, THEN TURN ON AGAIN.] appears on the LCD monitor.	<ul style="list-style-type: none">• The unit detected an error. To protect data, eject the SD card and set the mode dial to [OFF]. Power shuts off about 1 minute later.• If the same message is displayed repeatedly after turning power back on, the unit needs servicing. Disconnect the power supply and consult the dealer from which you purchased the unit. Do not attempt to repair the appliance by yourself.
The audio does not output for a motion picture copied with a DVD burner.	If [AUDIO REC] (P.84) is set to [MPEG] for recording, audio may not be output with some playback devices. Set to [DOLBY] when recording.
The PDF file of the MotionSD STUDIO operating instructions does not open.	Is Adobe Acrobat Reader 5.0 or later, or Adobe Reader 7.0 or later installed in the computer? Adobe Acrobat Reader 5.0 or later, or Adobe Reader 7.0 or later is required to view the PDF file of the MotionSD STUDIO operating instructions.
[DISC IS UNUSABLE. CHECK DISC.] appears on the LCD monitor.	A disc which cannot be used or a disc which cannot be written on has been inserted into the DVD burner. Use a new disc.

Problem

A function cannot be used or selected.

What to check

Because of specifications, this unit has functions that cannot be used simultaneously.

Examples:

Function	Condition
Digital zoom	<ul style="list-style-type: none"> • When in still picture recording mode
Fade	<ul style="list-style-type: none"> • When in still picture recording mode • While the PRE-REC function is being set
MagicPix	<ul style="list-style-type: none"> • When in still picture recording mode • During recording (Cannot set nor cancel) • While the PRE-REC function is being set (Cannot set nor cancel)
Backlight compensation	<ul style="list-style-type: none"> • While setting iris or gain • While using MagicPix
Soft skin mode (Set and cancel)	<ul style="list-style-type: none"> • During recording • While the PRE-REC function is being set
Help mode	
Image stabilizer	<ul style="list-style-type: none"> • When in still picture recording mode • While using MagicPix
Scene mode	<ul style="list-style-type: none"> • When in auto recording mode • While using MagicPix
Changes to white balance mode	<ul style="list-style-type: none"> • When using digital zoom • While using MagicPix
Changes to shutter speed/iris or gain	<ul style="list-style-type: none"> • When using scene mode • While using MagicPix

When [INITIAL SET] is executed from the SETUP menu, all the settings except for [LANGUAGE] and [CLOCK SET] will be restored to the defaults established at the time of purchase, and it will then become possible to select functions. (P. 84)

When using the unit

- **Keep the SD Video Camera as far away as possible from electromagnetic equipment (such as microwave ovens, TVs, video games etc.).**
 - If you use the SD Video Camera on top of or near a TV, the pictures and sound on the SD Video Camera may be disrupted by electromagnetic wave radiation.
 - Do not use the SD Video Camera near cell phones because doing so may result in noise adversely affecting the pictures and sound.
 - Recorded data may be damaged, or pictures may be distorted, by strong magnetic fields created by speakers or large motors.
 - Electromagnetic wave radiation generated by microprocessors may adversely affect the SD Video Camera, disturbing the pictures and sound.
 - If the SD Video Camera is adversely affected by electromagnetic equipment and stops functioning properly, turn the SD Video Camera off and remove the battery or disconnect AC adaptor.
Then reinsert the battery or reconnect AC adaptor and turn the SD Video Camera on.
- **Do not use the SD Video Camera near radio transmitters or high-voltage lines.**
 - If you record near radio transmitters or high-voltage lines, the recorded pictures and sound may be adversely affected.
- Use the cord or cable supplied with the unit or other devices. Do not extend the cords and the cables.
- Do not expose the unit to insecticide or volatile substances, or allow prolonged contact with rubber or vinyl products. (This can cause deformation and peeling.)
- Do not drop or impact the unit while carrying.
 - Strong impacts may damage the outer casing, causing it to malfunction.
- Do not use the unit for business purposes such as surveillance.
 - This unit is not of professional grade, and can build up heat internally over extended use, resulting in trouble.
- Before long periods of disuse:
 - Wipe away moisture and dirt with a soft dry cloth, dry naturally and store with desiccant (silica gel).

SD cards

- The memory capacity indicated on the SD card label is the total of the capacity for copyright protection and management, and that ordinarily used by the unit, computers, etc.
- MiniSD cards require a purpose-specific adaptor. Do not insert just the miniSD card or just the adaptor. Also, do not insert and remove a miniSD card while keeping the adaptor inserted into the unit. (This can cause damage.)

Battery

- The rechargeable lithium ion battery used with this unit is readily affected by temperature and humidity. In cold places, the full battery indication may not appear and a low battery warning may appear approx. 5 minutes after starting use. In high temperatures, a protective function may be triggered, preventing use.
- After use, always remove and store the battery.
 - If left inside the unit, the battery may over-discharge because of small amounts of current flow, ultimately damaging the battery.
 - Place the battery in a plastic bag so as to prevent metal from contacting terminals and store in a cool (15 - 25 °C (59 - 77 °F) dry (40 - 60 % RH) place subject to minimal temperature changes.
 - Storing the battery in extreme cold or high heat may shorten the battery's service-life. Moreover, places that are hot, humid or oily can rust terminals and cause damage to the battery.
 - During long-term storage, charge the battery once a year, then use it until depleted and store it again.
 - Clean battery terminals of adhering dust, etc.
- Bring a spare battery with you when going out.
 - Bring 3 - 4x more battery power than you plan to use. In cold places such as ski resorts, recording time becomes shorter.
 - Do not forget the AC adaptor when traveling so that you can recharge batteries.
- Do not use batteries if damaged or deformed (especially terminals) from dropping, etc.
 - This can cause damage to the unit.
- Do not throw batteries into fire.
 - The battery may burst if heated or thrown into fire.
- If the battery does not last long immediately after charging, it has reached the end of its service-life. Purchase a new battery.

AC adaptor

- Use the supplied AC adaptor.
- If the battery itself is too hot or too cold, it may take time to charge or may not charge at all.
- Keep the AC adaptor at least 1 m (3.3 feet) away from the radio. (Interference may affect the radio.)
- During use, the AC adaptor may make noises internally; however, this is normal.
- After use, unplug the AC adaptor from its AC outlet. (Leaving it connected consumes 0.3 W [max.] of power.)
- Keep the terminals of the AC adaptor clean.

Keep the AC adaptor near an AC outlet and yourself within arm's reach of a breaker (AC plug).

LCD monitor

- If the LCD monitor fogs up or becomes dirty, wipe it clean with a soft dry cloth.
- When the unit is extremely cold in cold places or in other such conditions, although the LCD monitor may be slightly dark immediately after turning power on, the normal brightness is restored when internal temperature rises.

The LCD monitor is made with high-precision technology; however, black spots may appear in displays or stuck lighting (red, blue or green) may occur. There is nothing wrong with the monitor.

The LCD monitor pixels are controlled to a 99.99 % degree of accuracy; however, dead or stuck pixels may occur in the remaining 0.01 %. These pixel defects are not recorded in SD card images, therefore do not worry.

Condensation

- If condensation adheres to the unit, the lens may fog and the unit and SD card may not function properly. Avoid sharp changes in temperature and humidity.
- Condensation may adhere in the following cases:
 - After summer rain showers or in humid places where the air is thick with steam
 - When heaters are turned on in cold rooms
 - When moving from cold places to warm places
 - When the unit is directly exposed to cold drafts (i.e., air conditioners, etc.)
- In the event of differences in temperature or humidity, place the unit in a plastic bag, remove as much air as possible, seal and let it sit for about 1 hour to adjust to the ambient temperature.
- If the lens fogs up, remove the battery and disconnect the AC adaptor, open the card/battery door and let it sit for about 1 hour to adjust to the ambient temperature.

Cleaning

- Remove the battery and disconnect the AC adaptor.
- Do not use benzene, thinner, alcohol, etc. (These substances can cause deformation and peeling.)
- Wipe off fingerprints and dust with a soft dry cloth. For stubborn dirt, soak a cloth in water, wring it out well, and use it to wipe the dirty surfaces. Then wipe the surfaces with a dry cloth.
- Use chemically impregnated tissues in accordance with warnings and indications.

SD Video Camera : Information for your safety

Power source:	DC 5.0 V (When using AC adaptor), DC 3.6 V (When using battery)
Power consumption:	Recording: 2.9 W, Charging: 4.5 W

Signal system	EIA Standard: 525 lines, 60 fields NTSC color signal
Image sensor	1/6" CCD image sensor Total: 680 K Effective pixels: Moving picture: 340 K (4:3), 300 K (16:9) Still picture: 350 K (4:3)
Lens	Auto Iris, F1.8 to F2.4 Focal length: 2.3 mm to 23.0 mm Macro (Full range AF)
Zoom	10x optical zoom, 25/700x digital zoom
Monitor	2.7" wide LCD monitor (approx. 123 K pixels)
Microphone	Stereo (with a zoom function)
Speaker	1 round speaker
White balance adjustment	Auto tracking white balance system
Standard illumination	1,400 lx
Minimum required illumination	Approx. 6 lx (Low light mode, 1/30) [Approx. 2 lx with the MagicPix function]
Video output level	1.0 Vp-p, 75 Ω
Audio output level	316 mV, 600 Ω
USB	Card reader/writer function (No copyright protection support) Hi-Speed USB (USB 2.0), USB terminal Type miniAB, PictBridge-compliant
Dimensions (excluding the projecting parts)	41.0 mm (W) x 59.0 mm (H) x 102.0 mm (D) [1.60" (W) x 2.30" (H) x 4.00" (D)]
Mass (Weight)	Approx. 160 g (0.35 lbs.) without an SD card and supplied battery
Mass (Weight) in operation	Approx. 182 g (0.40 lbs.) with an SD card and supplied battery
Operating temperature	0 °C to 40 °C (32 °F to 104 °F)
Operating humidity	10 % to 80 %
Battery operation time	Refer to page 22.

Motion pictures

Recording media	SD Memory Card: 256 MB/512 MB/1 GB/2 GB (FAT12 and FAT16 format corresponding) SDHC Memory Card: 4 GB/8 GB/16 GB (FAT32 format corresponding)
Picture size	704 x 480
Recordable time	Refer to page 33.
Compression	MPEG2 (SD-Video standard compliant)
Recording mode and transfer rate	XP: 10 Mbps (VBR), SP: 5 Mbps (VBR), LP: 2.5 Mbps (VBR)
Audio compression	MPEG1-Layer2 compliant (stereo), Dolby Digital compliant (Dolby AC3) (stereo)

Still pictures

Recording media	SD Memory Card: 8 MB/16 MB/32 MB/64 MB/128 MB/256 MB/ 512 MB/1 GB/2 GB (FAT12 and FAT16 format corresponding) SDHC Memory Card: 4 GB/8 GB/16 GB (FAT32 format corresponding)
Number of recordable pictures	Refer to page 35.
Compression	JPEG (Design rule for Camera File system, based on Exif 2.2 standard), DPOF corresponding
Picture size	640 x 480 (4:3)

AC adaptor : Information for your safety



Power source:	AC 110 V to 240 V, 50/60 Hz
Power consumption:	12 W
DC output:	DC 5.0 V, 1.6 A

Dimensions	76 mm (W) x 22 mm (H) x 46 mm (D) [2.99" (W) x 0.87" (H) x 1.81" (D)]
Mass (Weight)	Approx. 100 g (0.22 lbs.)

Battery pack : Information for your safety

Maximum voltage:	DC 4.2 V
Nominal voltage:	DC 3.6 V
Rated capacitance:	1000 mAh

Specifications may change without prior notice.

Figure	Accessory No.	Description
	VW-VBJ10*	1000 mAh/Rechargeable Lithium Ion Battery Pack
	RP-SDK02GU1A RP-SDH01GU1A RP-SDK512U1A RP-SDH256U1A	High Speed 2 GB SD Memory Card High Speed 1 GB SD Memory Card High Speed 512 MB SD Memory Card High Speed 256 MB SD Memory Card
	RP-SDR04GU1K RP-SDR02GU1A RP-SDR01GU1A RP-SDR512U1A RP-SDR256U1A	Class 2 4 GB SDHC Memory Card Class 2 2 GB SD Memory Card Class 2 1 GB SD Memory Card Class 2 512 MB SD Memory Card Class 2 256 MB SD Memory Card
	RP-SDM04GU1K RP-SDM02GU1A	Class 4 4 GB SDHC Memory Card Class 4 2 GB SD Memory Card
	RP-SDV16GU1K RP-SDV08GU1K RP-SDV04GU1K RP-SDV02GU1A RP-SDV01GU1A	Class 6 16 GB SDHC Memory Card Class 6 8 GB SDHC Memory Card Class 6 4 GB SDHC Memory Card Class 6 2 GB SD Memory Card Class 6 1 GB SD Memory Card
	VW-BN1	DVD burner

* Please refer to page 22 concerning the battery charging time and available recording time.

NOTE: Accessories and/or model numbers may vary by country. Please consult your local dealer.

Accessory Order Form (For USA Customers)

Please photocopy this form when placing an order.

1. Model # _____

2. Items Ordered

Accessory #	Description	Price Each	Quantity	Total Price
Subtotal				
Your State & Local Sales Tax				
Shipping & Handling				6.95
Total Enclosed				

3. Method of payment (check one)

- Check of Money Order enclosed (NO C.O.D. SHIPMENTS)
- VISA Credit Card # _____
- MasterCard Expiration Date _____
- Discover Customer Signature _____

Make Check or Money Order Payable to: PANASONIC ACCESSORIES

(Please do not send cash)

4. Shipping information (UPS delivery requires complete street address)

Ship To:

Mr.

Mrs.

Ms.

First

Last

Phone#:

Day () _____

Street Address

Night () _____

City

State

Zip

TO OBTAIN ANY OF OUR ACCESSORIES YOU CAN DO ANY OF
THE FOLLOWING:

VISIT YOUR LOCAL PANASONIC DEALER

OR

CALL PANASONIC'S ACCESSORY ORDER LINE AT 1-800-332-5368

[6 AM-6 PM M-F, PACIFIC TIME]

OR

MAIL THIS ORDER TO: PANASONIC SERVICE AND TECHNOLOGY COMPANY

ACCESSORY ORDER OFFICE

20421 84th Avenue South Kent, WA. 98032

In CANADA, please contact your local Panasonic dealer for more information on Accessories.

Request for Service Notice (USA Only)

Please photocopy this form when making a request for service notice, in the unlikely event this product needs service.

- Request for Service Notice:**
- Please include your **proof of purchase**.
(Failure to do so will delay your repair.)
 - To further speed your repair, please provide an explanation of what is wrong with the unit and any symptom it is exhibiting.

Mail this completed form and your Proof of Purchase along with your unit to:
Panasonic Camera and Digital Service Center
1590 Touhy Ave.
Elk Grove Village, IL 60007

Customer Services Directory (For USA only)

Service in Canada: As per Service Center listed in Canadian warranty information (P.108)

Obtain Product Information and Operating Assistance; locate your nearest Dealer or Service Center; purchase Parts and Accessories; or make Customer Service and Literature requests by visiting our Web Site at:

<http://www.panasonic.com/consumersupport>

or, contact us via the web at:

<http://www.panasonic.com/contactinfo>

You may also contact us directly at:

1-800-211-PANA (7262),

Monday-Friday 9 am-9 pm; Saturday-Sunday 10 am-7 pm, EST

For hearing or speech impaired TTY users, TTY : 1-877-833-8855

Accessory Purchases

Purchase Parts, Accessories and Instruction Books online for all Panasonic Products by visiting our Web Site at:

<http://www.pstc.panasonic.com>

or, send your request by E-mail to:

npcparts@us.panasonic.com

You may also contact us directly at:

1-800-332-5368 (Phone) 1-800-237-9080 (Fax Only) (Monday – Friday 9 am to 9 pm, EST.)

Panasonic Service and Technology Company

20421 84th Avenue South,

Kent, WA 98032

(We Accept Visa, MasterCard, Discover Card, American Express, and Personal Checks)

For hearing or speech impaired TTY users, TTY : 1-866-605-1277

Product Repairs

Centralized Factory Service Center

MAIL TO:

Panasonic Camera and Digital Service Center

1590 Touhy Ave.

Elk Grove Village, IL 60007

Please carefully pack and ship, prepaid and insured, to the Elk Grove Village Centralized Factory Service Center

Customer's in Puerto Rico, please ship or carry in to location below ("Service in Puerto Rico").

Service in Puerto Rico

Panasonic Puerto Rico, Inc.

Ave. 65 de Infantería, Km. 9.5, San Gabriel Industrial Park,

Carolina, Puerto Rico 00985

Phone (787)750-4300, Fax (787)768-2910

As of January 2007

Limited Warranty (For USA Customers)

PANASONIC CONSUMER ELECTRONICS COMPANY, DIVISION OF PANASONIC CORPORATION OF NORTH AMERICA
One Panasonic Way, Secaucus,
New Jersey 07094

PANASONIC PUERTO RICO, INC.
Ave. 65 de Infantería, Km. 9.5,
San Gabriel Industrial Park, Carolina,
Puerto Rico 00985

Panasonic Video Products Limited Warranty

Limited Warranty Coverage

If your product does not work properly because of a defect in materials or workmanship, Panasonic Consumer Electronics Company or Panasonic Puerto Rico, Inc. (collectively referred to as "the warrantor") will, for the length of the period indicated on the chart below, which starts with the date of original purchase ("warranty period"), at its option either (a) repair your product with new or refurbished parts, or (b) replace it with a new or refurbished product. The decision to repair or replace will be made by the warrantor.

Product	Parts	Labor	Service	Contact Number
Camcorder	One (1) Year (except CCD Image Sensor) CCD Image Sensor - 6 (Six) Months	Ninety (90) Days Ninety (90) Days	Carry-In or Mail-In	1-800-211-PANA(7262)
DVD/VCR Deck, A/V Mixer	One (1) Year	Ninety (90) Days	Carry-In or Mail-In	1-800-211-PANA(7262)
TV/VCR, TV/DVD, TV/DVD/VCR Combination	One (1) Year (except CRT) CRT - Two (2) Years	Ninety (90) Days Ninety (90) Days	Carry-In: 21" CRT and Smaller In-Home or Carry-In: 22" CRT and Larger	1-800-211-PANA(7262)
TV/HDR Combination	One (1) Year (except CRT) CRT - Two (2) Years	Ninety (90) Days Ninety (90) Days	In-Home or Carry-In	1-888-843-9788
Rechargeable Batteries (in exchange for defective item)	Ten (10) Days	Not Applicable	Carry-In or Mail-In	1-800-211-PANA(7262)
Tape (in exchange for defective item)	Five (5) Days	Not Applicable	Carry-In or Mail-In	1-800-211-PANA(7262)
Memory Cards (in exchange for defective item)	Ninety (90) Days	Not Applicable	Carry-In or Mail-In	1-800-211-PANA(7262)

During the "Labor" warranty period there will be no charge for labor. During the "Parts" warranty period, there will be no charge for parts. You must carry-in or mail-in (prepaid) your product or arrange for in-home service, as applicable, during the warranty period. If non-rechargeable batteries are included, they are not warranted. This warranty only applies to products purchased and serviced in the United States or Puerto Rico. This warranty is extended only to the original purchaser of a new product which was not sold "as is". A purchase receipt or other proof of the original purchase date is required for warranty service.

Carry-In, Mail-in (Prepaid) or In-Home Service

For Carry-In, Mail-In (prepaid) or In-Home Service (as applicable) in the United States call toll free contact number listed above or visit Panasonic Web Site: <http://www.panasonic.com>
For assistance in Puerto Rico call Panasonic Puerto Rico, Inc. (787)-750-4300 or fax (787)-768-2910. In-Home service, if applicable, requires clear, complete and easy access to the product by the authorized servicer and does not include removal or re-installation of an installed product. It is possible that certain in-home repairs will not be completed in-home, but will require that the product, or parts of the product, be removed for shop diagnosis and/or repair and then returned.

Limited Warranty Limits And Exclusions

This warranty ONLY COVERS failures due to defects in materials or workmanship, and DOES NOT COVER normal wear and tear or cosmetic damage, nor does it cover markings or retained images on the picture tube resulting from viewing fixed images (including, among other things, letterbox pictures on standard 4:3 screen TV's, or non-expanded standard 4:3 pictures on wide screen TV's, or onscreen data in a stationary and fixed location). The warranty ALSO DOES NOT COVER damages which occurred in shipment, or failures which are caused by products not supplied by the warrantor, or failures which result from accidents, misuse, abuse, neglect, bug infestation, mishandling, misapplication, alteration, faulty installation, set-up adjustments, misadjustment of consumer controls, improper maintenance, power line surge, lightning damage, modification, or commercial use (such as in a hotel, office, restaurant, or other business), rental use of the product, service by anyone other than a Factory Service Center or other Authorized Servicer, or damage that is attributable to acts of God.

THERE ARE NO EXPRESS WARRANTIES EXCEPT AS LISTED UNDER "LIMITED WARRANTY COVERAGE". THE WARRANTOR IS NOT LIABLE FOR INCIDENTAL OR CONSEQUENTIAL DAMAGES RESULTING FROM THE USE OF THIS PRODUCT, OR ARISING OUT OF ANY BREACH OF THIS WARRANTY.

(As examples, this excludes damages for lost time, cost of having someone remove or re-install an installed unit if applicable, or travel to and from the servicer, loss of media or images, data or other memory or recorded content. The items listed are not exclusive, but are for illustration only.)

ALL EXPRESS AND IMPLIED WARRANTIES, INCLUDING THE WARRANTY OF MERCHANTABILITY, ARE LIMITED TO THE PERIOD OF THE LIMITED WARRANTY.

Some states do not allow the exclusion or limitation of incidental or consequential damages, or limitations on how long an implied warranty lasts, so the exclusions may not apply to you. This warranty gives you specific legal rights and you may also have other rights which vary from state to state. If a problem with this product develops during or after the warranty period, you may contact your dealer or Service Center. If the problem is not handled to your satisfaction, then write to the warrantor's Consumer Affairs Department at the addresses listed for the warrantor.

PARTS AND SERVICE (INCLUDING COST OF AN IN-HOME SERVICE CALL, WHERE APPLICABLE) WHICH ARE NOT COVERED BY THIS LIMITED WARRANTY ARE YOUR RESPONSIBILITY.

Warranty (For Canadian Customers)

Panasonic Canada Inc.

5770 Ambler Drive, Mississauga, Ontario L4W 2T3

PANASONIC PRODUCT – LIMITED WARRANTY

Panasonic Canada Inc. warrants this product to be free from defects in material and workmanship and agrees to remedy any such defect for a period as stated below from the date of original purchase.

Camcorder Product – One (1) year, parts and labour

LIMITATIONS AND EXCLUSIONS

This warranty does not apply to products purchased outside Canada or to any product which has been improperly installed, subjected to usage for which the product was not designed, misused or abused, damaged during shipping, or which has been altered or repaired in any way that affects the reliability or detracts from the performance, nor does it cover any product which is used commercially. Dry cell batteries are also excluded from coverage under this warranty.

This warranty is extended to the original end user purchaser only. A purchase receipt or other proof of date of original purchase is required before warranty service is performed.

THIS EXPRESS, LIMITED WARRANTY IS IN LIEU OF ALL OTHER WARRANTIES, EXPRESS OR IMPLIED, INCLUDING ANY IMPLIED WARRANTIES OF MERCHANTABILITY AND FITNESS FOR A PARTICULAR PURPOSE.

IN NO EVENT WILL PANASONIC CANADA INC. BE LIABLE FOR ANY SPECIAL, INDIRECT OR CONSEQUENTIAL DAMAGES.

In certain instances, some jurisdictions do not allow the exclusion or limitation of incidental or consequential damages, or the exclusion of implied warranties, so the above limitations and exclusions may not be applicable.

WARRANTY SERVICE

FOR PRODUCT OPERATION ASSISTANCE, please contact:

Our Customer Care Centre:	Telephone #:	(905) 624-5505
	1-800 #:	1-800-561-5505
	Fax #:	(905) 238-2360
	Email link:	"Customer support" on www.panasonic.ca

FOR PRODUCT REPAIRS, please locate your nearest Authorized Servicentre at www.panasonic.ca :

Link: "Servicentres™ locator" under "Customer support"

IF YOU SHIP THE PRODUCT TO A SERVICENTRE

Carefully pack and send prepaid, adequately insured and preferably in the original carton.

Include details of the defect claimed, and proof of date of original purchase.

Index

- A**
 - Aperture 49
 - Audio rec 32, 84, 94
 - Auto focus 31, 44
 - Auto slow shutter 37
- B**
 - Backlight compensation 40
 - Battery 20
 - Beep sound 32
- C**
 - Charging time 22
 - Cursor button 27
- D**
 - Date and time display 28
 - Delete Scene 56
 - Demo mode 84
 - Digital zoom 36
 - DirectX 70
 - DPOF setting 59
 - Dubbing 61, 64
 - DVD burner 64-69
- F**
 - Fade 39
 - Format Card 58
 - Frame-by-frame playback 54
- G**
 - Gain 49
 - Guideline 51
- H**
 - Hand strap 16
 - Help mode 39
- I**
 - Image stabilizer function 37
 - Initial setting 84
 - Iris 49
- L**
 - Language 27
 - LCD monitor 17, 29
 - Locking scenes 58
- M**
 - MagicPix function 41
 - Manual focus 44
 - Menu 26, 82
 - Mode dial 24
 - Motion picture playback 52
 - Motion picture recording 32
 - MotionSD STUDIO 70
- N**
 - Number of recordable pictures 35
- O**
 - Operation icons 38
- P**
 - PictBridge 62
 - Picture quality 35
 - Power LCD 29
 - Power save 84
 - PRE-REC function 42
- Q**
 - Quick start 25
- R**
 - Recordable time 22
 - Recording modes 33
 - Recording time elapsed 32
 - Remaining number of still pictures 34
 - Remaining time 32
 - Resume playback 54
- S**
 - Scene mode 45
 - SD/SDHC Memory Card 18, 19, 23
 - Self-timer recording 40
 - Self-portrait recording function 43
 - Shutter effect 34
 - Shutter speed 48
 - Skip playback 54
 - Slide show 55
 - Slow-motion playback 54
 - Soft skin mode 41
 - Still picture playback 55
 - Still picture recording 34
- T**
 - Thumbnails by date 53
 - Tripod 14
 - TV aspect 60
- V**
 - Volume adjustment 52
- W**
 - White balance 46
 - Wind noise reduction function 51
 - World time 50
- Z**
 - Zoom 36
 - Zoom microphone 37

Spanish Quick Use Guide/Guía española

Carga

- 1 Ponga el selector de modo en [OFF].**

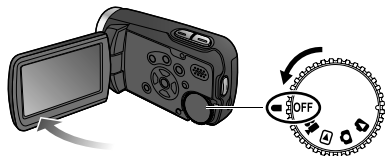

- 2 Abra la tapa de la tarjeta/batería.**

Abra la tapa deslizando la palanca de la tapa de la tarjeta/batería a la posición "OPEN".

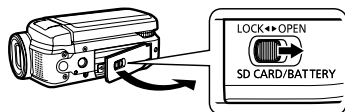

- 3 Inserte la batería.**

**Inserción de tarjetas SD
(vendidas separadamente)**

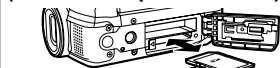

Ponga la etiqueta hacia arriba.

Deslícela derecha hacia adentro hasta que oiga que la tarjeta queda fijada.

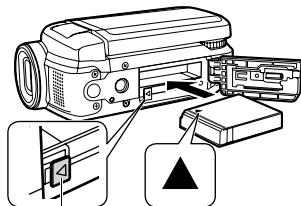

Palanca

Presione hasta que oiga la palanca se cierra.

- 4 Cierre la tapa de la tarjeta/batería.**

Cierre la tapa de la tarjeta/batería y deslice la palanca de la misma a la posición "LOCK".

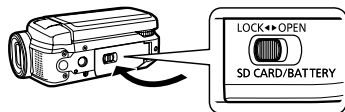

- 5 Conecte el adaptador de CA (suministrado).**

A una toma de CA ← ②
Cable de CA

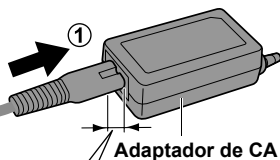

Adaptador de CA

Pequeña abertura aquí.

para el uso rápido

- 6** Abra la cubierta del terminal.

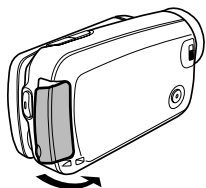

- 7** Enchufe la clavija de CC en el terminal de entrada de CC de la unidad.

Indicador de estado
Parpadeando en rojo :
Cargándose
Apagado : La carga ha terminado

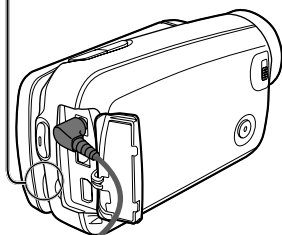

Ajuste de la fecha y la hora

- 1** Ponga el selector de modo en otra posición que no sea [OFF].

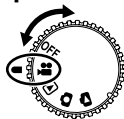

- 2** Seleccione [Sí].

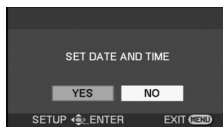
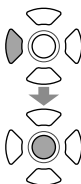

- 3** Ponga la fecha y la hora.



Selección de ajustes



Cambio de valores numéricos



- 4** Introduzca la fecha y la hora.



- Este procedimiento es para poner la fecha y la hora por primera vez. Para ponerlas por segunda vez y otras posteriores, consulte la página 28.

Spanish Quick Use Guide/Guía española

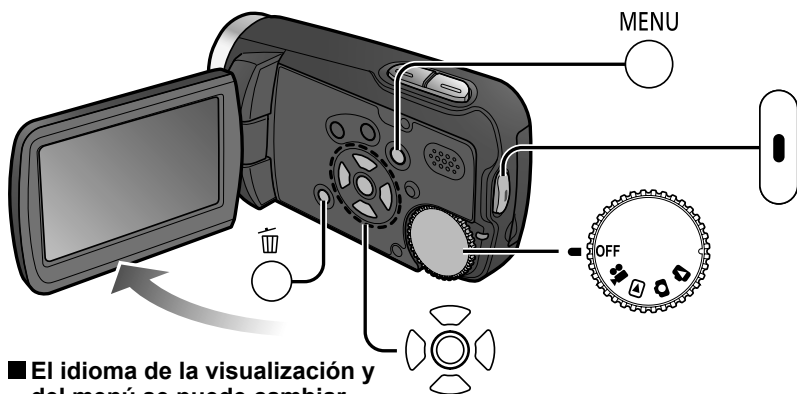

■ El idioma de la visualización y del menú se puede cambiar

➔ MENU → [LANGUAGE]

Grabación

Imágenes en movimiento

1 Póngalo en [MOV].

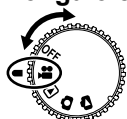

2 Inicio de grabación.



3 Parada de grabación.



Imágenes fijas

1 Póngalo en [CAM].

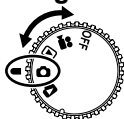

2 Toma de imagen.



Reproducción

▶ Imágenes en movimiento

- 1 Póngalo en [▶].



- 2 Seleccione la escena deseada.



Reproducción/Pausa

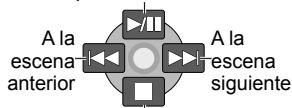

Vuelve al paso 2

▶ Imágenes fijas

- 1 Póngalo en [▶].

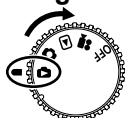

- 2 Seleccione la escena deseada.

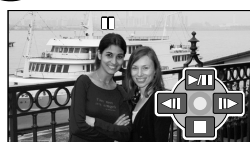

Inicio/Pausa de diaporamas

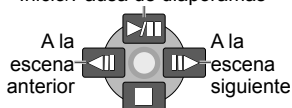

Vuelve al paso 2

Borrado de imágenes

- 1 Durante la reproducción



(Visualización en el modo de reproducción de Imágenes en movimiento)

- 2 Seleccione [Sí].

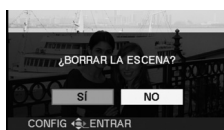
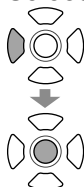

**Panasonic Consumer Electronics Company,
Division of Panasonic Corporation of North America**

One Panasonic Way, Secaucus, NJ 07094

Panasonic Puerto Rico, Inc.

Ave. 65 de Infantería, Km. 9.5, San Gabriel Industrial Park,
Carolina, Puerto Rico 00985

Panasonic Canada Inc.

5770 Ambler Drive, Mississauga, Ontario, L4W 2T3



VQT1R00-1
F0208UN1038 (16000 Ⓑ)

