

# Technics<sup>®</sup>



SU-C550  
CD Stereo Amplifier  
Operating Instructions



Music is borderless and timeless, touching people's hearts across cultures and generations. Each day the discovery of a truly emotive experience from an unencountered sound awaits. Let us take you on your journey to rediscover music.

Rediscover Music™

**Technics**



# Delivering the Ultimate Emotive Musical Experience to All

At Technics we understand that the listening experience is not purely about technology but the magical and emotional relationship between people and music.

We want people to experience music as it was originally intended and enable them to feel the emotional impact that enthuses and delights them.

Through delivering this experience we want to support the development and enjoyment of the world's many musical cultures. This is our philosophy.

With a combination of our love of music and the vast high-end audio experience of the Technics team, we stand committed to building a brand that provides the ultimate emotive musical experience by music lovers, for music lovers.

Director  
Michiko Ogawa

A handwritten signature in black ink that reads "Michiko Ogawa". The signature is written in a cursive, flowing style with a long horizontal line extending from the end of the name.

Thank you for purchasing this product.

Please read these instructions carefully before using this product, and save this manual for future use.

- About descriptions in these operating instructions
  - Pages to be referred to are indicated as "⇒ ○○".
  - The illustrations shown may differ from your unit.

## Sales and Support Information

### **Customer Communications Centre**

- For customers within the UK: 0333 222 8777
- For customers within Ireland: 01 447 5229
- Monday–Friday 9:00 am – 5:00 pm, (Excluding public holidays).
- For further support on your product, please visit our website: [www.technics.com/uk/](http://www.technics.com/uk/)

# Features

## LAPC (Load Adaptive Phase Calibration)

Adaptive processing of speaker impedance flattens frequency amplitude and phase characteristics. The result is the reproduction of sound with rich spatial expression.

## Full-digital amplifier

This unit is a full-digital amplifier. Its specially-designed jitter reduction circuit and high-precision PWM conversion circuit eliminate distortion, noise, and jitter.

## Various music sources

This unit supports a wide range of inputs, such as iOS device, Bluetooth® device, etc. as well as CD.

High-resolution sound sources stored in your smartphone, PC, etc. can also be played back using wired LAN connection/wireless LAN connection. Also you can download "Technics Music App" into your smartphone for easy operation.

# Table of contents

Safety precautions	08	Please carefully read the "Safety precautions" of this manual before use.
Installation	11	Installation
Control reference guide	12	Main unit, Remote control
Connections	16	Speaker connection, AC mains lead connection, Network settings
Operations	24	Playing back CDs, etc.
Settings	38	Other settings, Using output correction function (LAPC)
Troubleshooting	42	Before requesting service, read the troubleshooting.
Others	47	Playable media, Specifications, etc.

## Accessories

AC mains lead (1)  
K2CT3YY00081

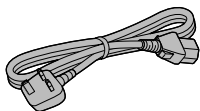

Remote control (1)  
N2QAYA000114

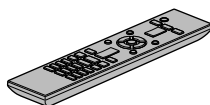

Batteries for  
remote control (2)



- Product numbers provided in these operating instructions are correct as of December 2015.
- These may be subject to change.
- Do not use AC mains lead with other equipment.

## Warning

### Unit

- To reduce the risk of fire, electric shock or product damage,
  - Do not expose this unit to rain, moisture, dripping or splashing.
  - Do not place objects filled with liquids, such as vases, on this unit.
  - Use only the recommended accessories.
  - Do not remove covers.
  - Do not repair this unit by yourself. Refer servicing to qualified service personnel.
  - Do not let metal objects fall inside this unit.
  - Do not place heavy items on this unit.

### AC mains lead

- To reduce the risk of fire, electric shock or product damage,
  - Ensure that the power supply voltage corresponds to the voltage printed on this unit.
  - Insert the mains plug fully into the socket outlet.
  - Do not pull, bend, or place heavy items on the lead.
  - Do not handle the plug with wet hands.
  - Hold onto the mains plug body when disconnecting the plug.
  - Do not use a damaged mains plug or socket outlet.
- The mains plug is the disconnecting device. Install this unit so that the mains plug can be unplugged from the socket outlet immediately.
- Ensure the earth pin on the mains plug is securely connected to prevent electrical shock.
  - An apparatus with CLASS I construction shall be connected to a mains socket outlet with a protective earth connection.

## Caution

### Unit

- Do not place sources of naked flames, such as lighted candles, on this unit.
- This unit may receive radio interference caused by mobile telephones during use. If such interference occurs, please increase separation between this unit and the mobile telephone.
- This unit is intended for use in moderate and tropical climates.
- Do not put any objects on this unit. This unit becomes hot while it is on.
- This unit utilizes a laser. Use of controls or adjustments or performance of procedures other than those specified herein may result in hazardous radiation exposure.
- Do not look at the laser with an observation optical system like magnifying glass, however it does not affect the human health.

### Placement

- Place this unit on an even surface.
- To reduce the risk of fire, electric shock or product damage,
  - Do not install or place this unit in a bookcase, built-in cabinet or in another confined space. Ensure this unit is well ventilated.
  - Do not obstruct this unit's ventilation openings with newspapers, tablecloths, curtains, and similar items.
  - Do not expose this unit to direct sunlight, high temperatures, high humidity, and excessive vibration.
- Do not lift or carry this unit by holding the top cover or antenna. Doing so may cause this unit to fall, resulting in personal injury or malfunction of this unit.



## Battery

- Danger of explosion if battery is incorrectly replaced. Replace only with the type recommended by the manufacturer.
- Mishandling of batteries can cause electrolyte leakage and may cause a fire.
  - Remove the battery if you do not intend to use the remote control for a long period of time. Store in a cool, dark place.
  - Do not heat or expose to flame.
  - Do not leave the battery(ies) in a car exposed to direct sunlight for a long period of time with doors and windows closed.
  - Do not take apart or short circuit.
  - Do not recharge alkaline or manganese batteries.
  - Do not use batteries if the covering has been peeled off.
  - Do not mix old and new batteries or different types at the same time.
- When disposing of the batteries, please contact your local authorities or dealer and ask for the correct method of disposal.

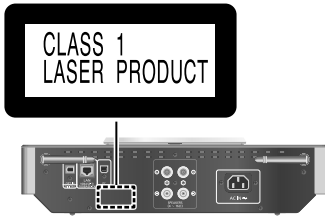



(Back of product)

## Caution for AC Mains Lead

(For the AC mains plug of three pins)  
For your safety, please read the following text carefully.

This appliance is supplied with a moulded three pin mains plug for your safety and convenience. A 10-ampere fuse is fitted in this plug. Should the fuse need to be replaced please ensure that the replacement fuse has a rating of 10-ampere and that it is approved by ASTA or BSI to BS1362.

Check for the ASTA mark  or the BSI mark  on the body of the fuse.

If the plug contains a removable fuse cover you must ensure that it is refitted when the fuse is replaced.

If you lose the fuse cover the plug must not be used until a replacement cover is obtained.

A replacement fuse cover can be purchased from your local dealer.

### Before use

Remove the connector cover.

### How to replace the fuse

The location of the fuse differ according to the type of AC mains plug (figures A and B). Confirm the AC mains plug fitted and follow the instructions below. Illustrations may differ from actual AC mains plug.

1. Open the fuse cover with a screwdriver.

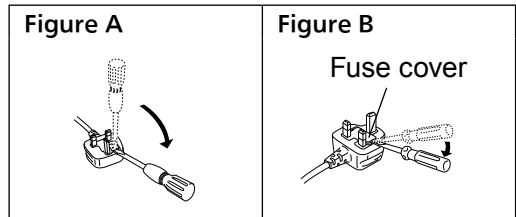

2. Replace the fuse and close or attach the fuse cover.

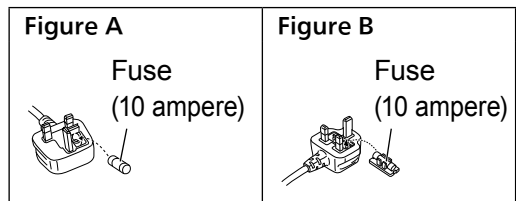

## Disposal of Old Equipment and Batteries

### Only for European Union and countries with recycling systems



These symbols on the products, packaging, and/or accompanying documents mean that used electrical and electronic products and batteries must not be mixed with general household waste.

For proper treatment, recovery and recycling of old products and used batteries, please take them to applicable collection points in accordance with your national legislation.

By disposing of them correctly, you will help to save valuable resources and prevent any potential negative effects on human health and the environment.

For more information about collection and recycling, please contact your local municipality.

Penalties may be applicable for incorrect disposal of this waste, in accordance with national legislation.



#### Note for the battery symbol (bottom symbol):

This symbol might be used in combination with a chemical symbol. In this case it complies with the requirement set by the Directive for the chemical involved.

# CE 0560 ⚠

## Declaration of Conformity (DoC)

Hereby, "Panasonic Corporation" declares that this product is in compliance with the essential requirements and other relevant provisions of Directive 1999/5/EC.

Customers can download a copy of the original DoC to our R&TTE products from our DoC server:  
<http://www.doc.panasonic.de>

Contact to Authorised Representative:

Panasonic Marketing Europe GmbH, Panasonic Testing Centre, Winsbergring 11, 22525 Hamburg, Germany

This product is in compliance with the radio standards of the following countries.

**GB, DE, AT, BE, DK, SE, FR, IT, ES, NL, FI, GR, PT, PL, HU, CZ, SK, EE, LV, LT, SI, BG, RO, MT, CY, IE, LU, HR, NO, CH, IS, LI**

This product is intended for general consumer. (Category 3)

This WLAN feature of this product shall exclusively be used inside buildings.

This product on purpose to connect to access point of 2.4 GHz or 5 GHz WLAN.

## Installation

- Turn off all equipment before connection and read the appropriate operating instructions.

## Unit care

- Pull out the AC mains lead from the outlet before maintenance. Clean this unit with a soft cloth.
- When dirt is heavy, wring a wet cloth tightly to wipe the dirt, and then wipe it with a soft cloth.
- Do not use solvents including benzine, thinner, alcohol, kitchen detergent, a chemical wiper, etc. This might cause the exterior case to be deformed or the coating to come off.

## To dispose or transfer this unit

This unit may contain private information. Before disposing of or transferring this unit, perform the following to delete the data, including personal or secret information.

- “To return all settings to the factory defaults”  
(⇒ 42)

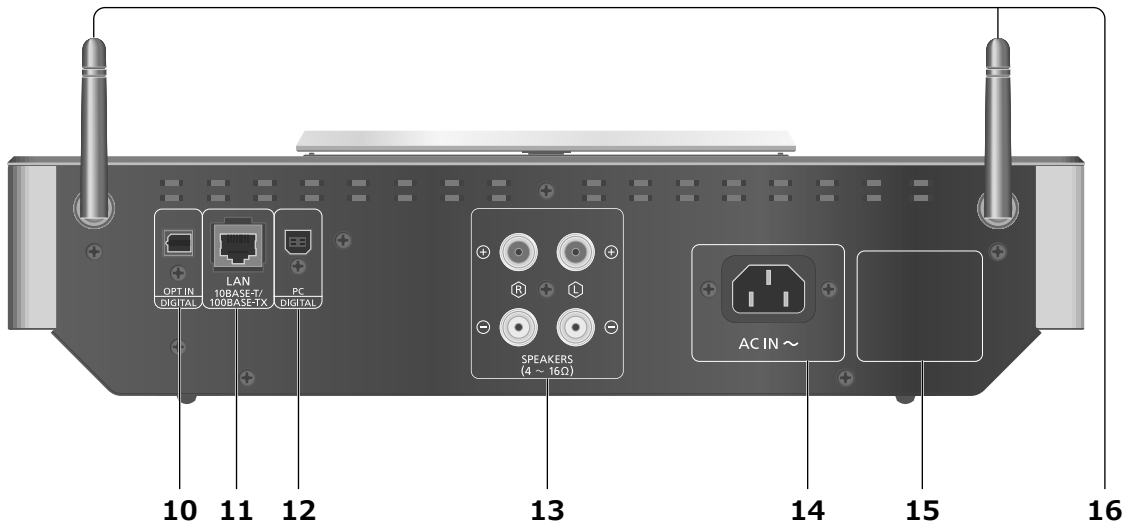
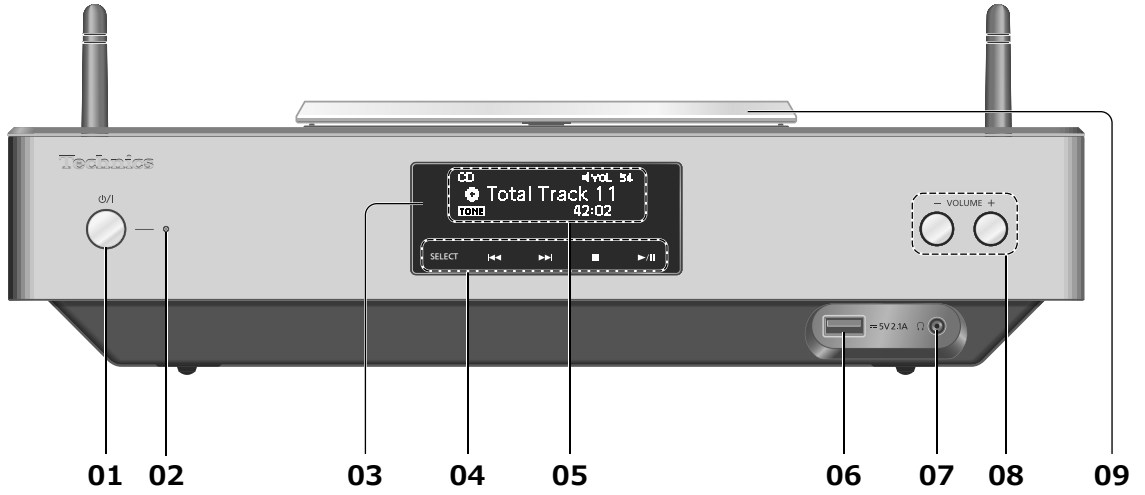

### 01 Standby/on switch (⏻/⏻)

- Press to switch the unit from on to standby mode or vice versa. In standby mode, the unit is still consuming a small amount of power.

### 02 Power indicator

- Blue: The unit is on.
- Red: The unit is in standby mode with the following status.
  - Network standby function is available. (⇒ 39)
  - Charging an iPhone/iPad/iPod (⇒ 27)
- Off: The unit is in standby mode with no function available.

### 03 Remote control signal sensor

- Distance: Within approx. 7 m directly in front
- Angle: Approx. 30° left and right

### 04 [SELECT]/[◀◀], [▶▶], [■], [▶/II]:

Switch the input source (⇒ 30, 31, 32, 34)/

Basic control buttons (⇒ 24)

- These switches work just by touching the marks. Each time you touch the switch, there will be a beep sound. (⇒ 38)

### 05 Display

- Input source, playback status, etc. are displayed. For details, visit: [www.technics.com/support/](http://www.technics.com/support/)

### 06 USB-A terminal DC 5 V 2.1 A

- Port for iPhone/iPad/iPod and USB devices (⇒ 26, 27)

### 07 Headphones jack

- When a plug is connected, the speakers do not output sound.
- Excessive sound pressure from earphones and headphones can cause hearing loss.
- Listening at full volume for long periods may damage the user's ears.

### 08 Adjust volume

- 0 (min) to 100 (max)

### 09 Top cover (⇒ 24)

### 10 Optical digital input terminal (⇒ 30)

### 11 LAN terminal (⇒ 18)

### 12 USB-B terminal

- For connecting to a PC, etc. (⇒ 31)

### 13 Speaker output terminals (⇒ 16)

### 14 AC IN terminal (⎓) (⇒ 17)

### 15 Product identification marking

- The model number is indicated.

### 16 Wireless LAN antenna (⇒ 19)

Using the remote control

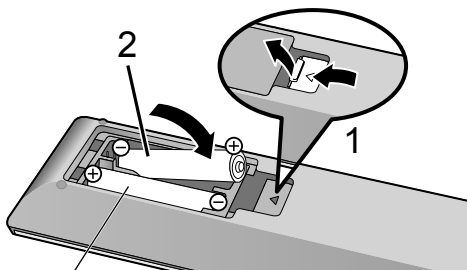

R03/LR03, AAA  
(Alkaline or manganese batteries)

**Note**

- Insert the battery so the terminals (⊕ and ⊖) match those in the remote control.
- Point it at the remote control signal sensor on this unit. (⇒ 12)
- Keep the batteries out of reach of children to prevent swallowing.

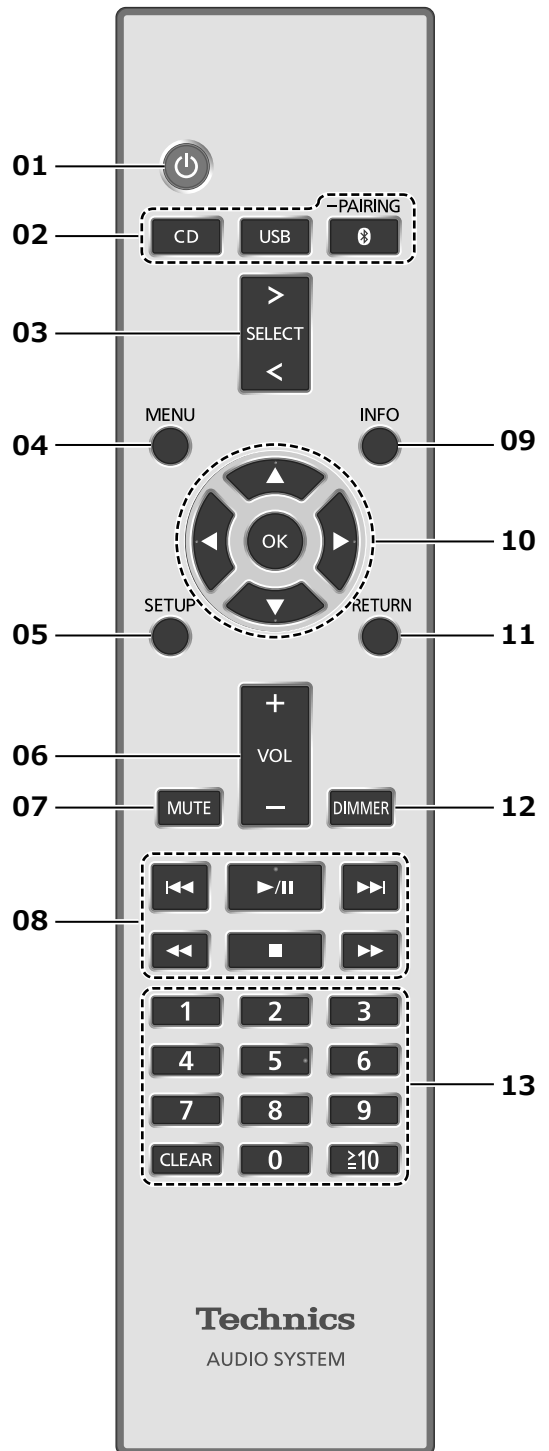

- 01 [⏻]: Standby/on switch**
- Press to switch the unit from on to standby mode or vice versa. In standby mode, the unit is still consuming a small amount of power.
- 02 [CD]/[USB]/[⊗-PAIRING]: Select the device to be operated**  
(⇒ 24, 26, 27, 28, 29)
- 03 [>SELECT<]: Switch the input source**  
(⇒ 30, 31, 32, 34)
- 04 [MENU]: Enter menu**  
(⇒ 24, 26, 28, 32, 36)
- 05 [SETUP]: Enter setup menu** (⇒ 38)
- 06 [+VOL-]: Adjust the volume**
- 0 (min) to 100 (max)
- 07 [MUTE]: Mute the sound**
- Press [MUTE] again to cancel. "MUTE" is also cancelled when you adjust the volume or when you turn the unit to standby.
- 08 Basic playback control buttons**
- 09 [INFO]: View content information**
- Press this button to display the track, artist, and album names, file type, sampling frequency, and other information. (The information varies depending on the input source.)
- 10 [▲], [▼], [◀], [▶]/[OK]: Selection/OK**
- 11 [RETURN]: Return to the previous display**
- 12 [DIMMER]: Adjust the brightness of the display, etc.**
- When the display is turned off, it will light up only when you operate this unit. Before the display turns off again, "Display Off" will be displayed for a few seconds. (Basic control buttons on this unit are not turned off.)
  - Press repeatedly to switch the brightness.
- 13 Numeric buttons, etc.**
- To select a 2-digit number  
Example:  
16: [≥10] > [1] > [6]
  - To select a 4-digit number  
Example:  
1234: [≥10] > [≥10] > [≥10] > [1] > [2] > [3] > [4]
  - [CLEAR]: Clear the entered value.

## Remote control code

When other equipment responds to the supplied remote control, change the remote control code.

- The factory default is "Mode 1".

- 1 Press [SETUP].**
- 2 Press [▲], [▼] to select "Remote Control" and then press [OK].**
  - The current remote control code of this unit is displayed.
- 3 When "Set Mode 1/2" is displayed, set the remote control code of the remote control.**  
To set "Mode 1":  
Press and hold [OK] and [1] for at least 4 seconds.  
To set "Mode 2":  
Press and hold [OK] and [2] for at least 4 seconds.
- 4 Point the remote control at this unit, and press and hold [OK] for at least 4 seconds.**
  - When the remote control code is changed, the new code will appear on the display for a few seconds.

### ■ When "Remote 1" or "Remote 2" is displayed

When "Remote 1" or "Remote 2" is displayed, the remote control codes of this unit and remote control are different. Perform step 3 above.

## Speakers/AC mains lead

- Use only the supplied AC mains lead.
- Do not connect the AC mains lead until all other connections are complete.
- Insert the plugs of the cables to be connected all the way in.
- Do not bend cables at sharp angles.
- To optimise the audio output, you can measure the amplifier output signal and correct its output when it is connected to the speakers. (⇒ 41)

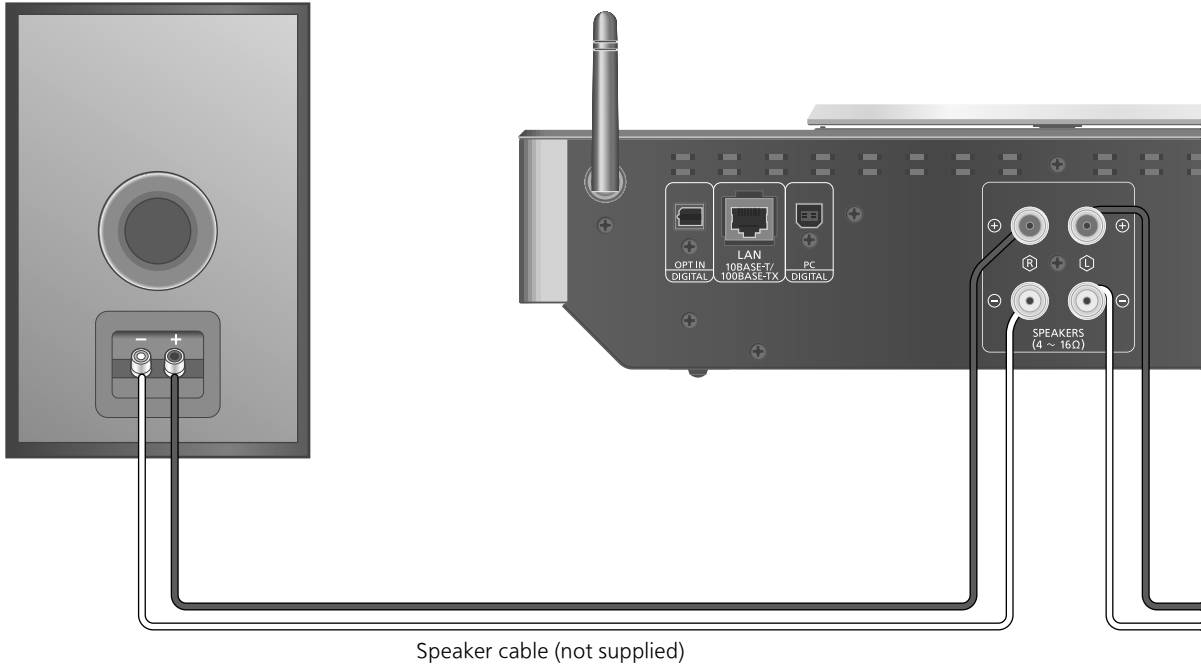

Speaker cable (not supplied)

### Speaker connection

- 1 Turn the knobs to loosen them, and insert the core wires into the holes.

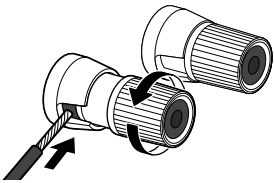

- 2 Tighten the knobs.

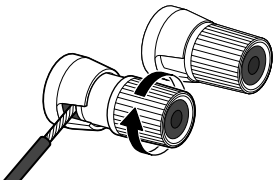

#### Note

- When the connections are completed, pull the speaker cables lightly to check that they are connected firmly.
- Be careful not to cross (short-circuit) or reverse the polarity of the speaker wires as doing so may damage the amplifier.

#### DO NOT

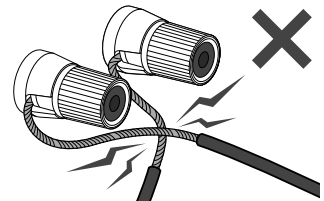

- Wire the polarity (+/-) of the terminals correctly. Not doing so may adversely affect stereo effects or cause malfunction.
- For details, refer to the operating instructions of the speakers.



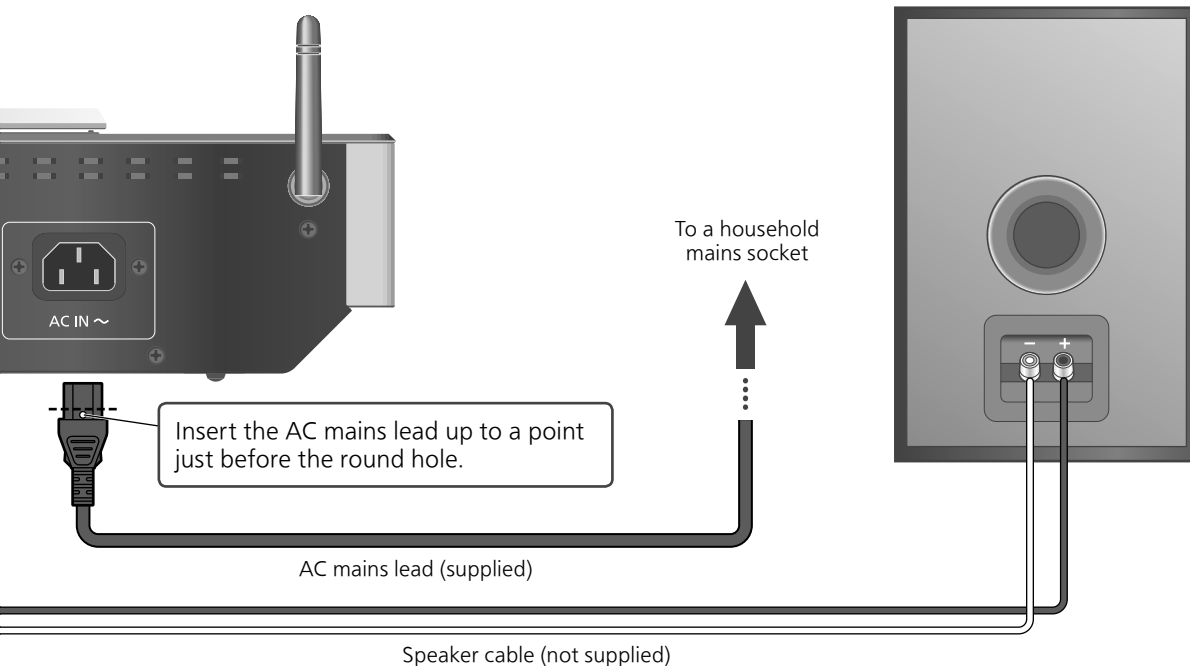

## AC mains lead connection

**Connect only after all other connections are completed.**

- Wireless LAN (Wi-Fi®) setting may start when this unit is turned on. If you stop the Wi-Fi setting, select "Off" in "Wi-Fi Setup" screen. Select "On" to keep the Wi-Fi setting. (⇒ 19)

### Note

- This unit consumes a small amount of AC power (⇒ 50) even when the unit is in standby mode. Remove the plug from the main electrical outlet if you will not be using the unit for an extended period of time. Place the unit so the plug can be easily removed.

## Output correction function (LAPC)

**You can make the optimum adjustment according to your own speakers.**

- When you select "Off" in "Wi-Fi Setup", you can set LAPC function (⇒ 41).
- When you select "On" in "Wi-Fi Setup", set the wireless LAN connection first, and you can set LAPC function (⇒ 41).

## Network settings

You can stream music from an iOS device (iPhone/iPad/iPod), an Android™ device or a PC (Mac/Windows) to this unit by using the AirPlay or DLNA feature. (⇒ 32, 36)  
To use these features, this unit must join the same network as the AirPlay compatible device or the DLNA compatible device.

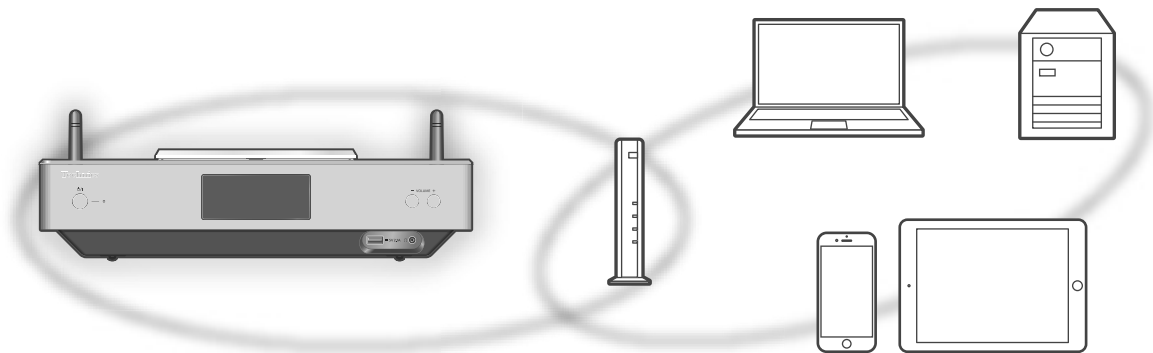

This system can be connected to a router using a LAN cable or built-in Wi-Fi®.  
For a stable connection to the network, a wired LAN connection is recommended.

### Note

- If you try to change the network settings immediately after turning on this unit, it may take some time until the network setup screen is displayed.
- If "Firmware update is available" is displayed after the network connection is set up, the firmware for this unit is available.
  - Refer to "Firmware updates" (⇒ 40) for details on update.
  - For the update information, refer to the following website.  
[www.technics.com/support/firmware/](http://www.technics.com/support/firmware/)

## Wired LAN connection

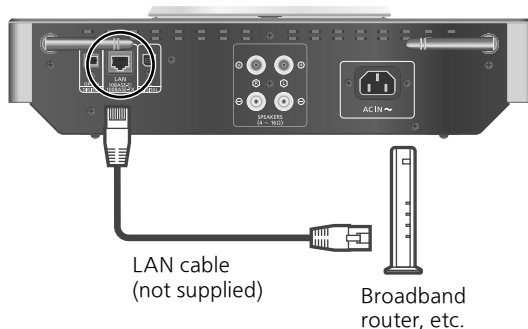

- 1 Disconnect the AC mains lead.**
- 2 Connect this unit to a broadband router, etc. using a LAN cable.**

### 3 Connect the AC mains lead to this unit, and press [⏻]. (⇒ 17)

- When the connection is established, "📶" is displayed.

### Note

- While the AC mains lead is disconnected, the LAN cable must be connected or disconnected.
- Use category 7 or above straight LAN cables (STP) when connecting to peripheral devices.
- Inserting any cable other than a LAN cable in the LAN port can damage the unit.
- If the LAN cable is disconnected, the network-related settings return to default. Make the settings again.
- When a LAN cable is connected, the Wi-Fi function may be disabled.

## Wireless LAN connection

### ■ Preparation

- ① Disconnect the AC mains lead.
- ② Disconnect the LAN cable.
- ③ Place this unit as close to the wireless router as possible.
- ④ Point up the antenna on the rear of this unit as shown in the figure.



- ⑤ Connect the AC mains lead to this unit. (⇒ 17)

#### Note

- Do not perform the following:
  - Applying too much force to the antenna
  - Carrying this unit by holding the antenna
- The setting will be cancelled after the set time limit. In that case, try the setting again.
- To cancel this setting in the middle, press [■] or turn the unit to standby mode.

### ■ Settings for the first time

- 1 Press [⏻] to turn this unit on.
  - “Wi-Fi Setup” is displayed.
- 2 Press [▲], [▼] to select “On” and then press [OK].
  - “WAC Mode for iOS” automatically starts.
- 3 (For “WAC Mode for iOS”)  
**Proceed to step 2 of “Using the WAC (Wireless Accessory Configuration)” (⇒ 20).**  
(For other network setting method)  
**Choose a network setting method.**

#### Note

- When this unit is switched to standby mode and turned on before the Wi-Fi setting is complete, “Wi-Fi Setup” is displayed. Perform the Wi-Fi setting or select “Off”.

### ■ Choose a network setting method

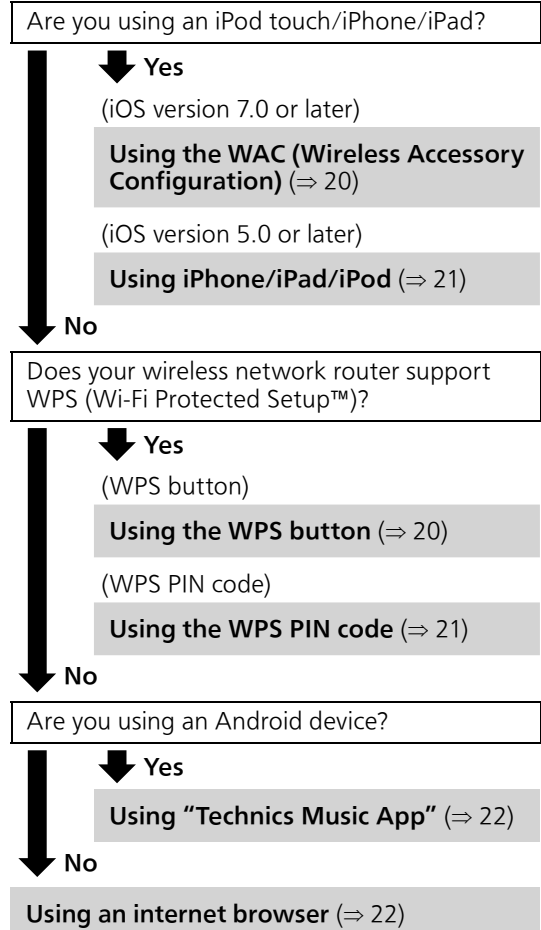

### ■ Settings using [SETUP] menu

- 1 Press [SETUP].
- 2 Press [▲], [▼] repeatedly to select “Network” and then press [OK].
  - When “Wi-Fi” screen is displayed, press [OK].
- 3 Press [▲], [▼] to select “On” and then press [OK]. (The wireless LAN function is enabled.)
- 4 Choose a network setting method.

## Network settings (Continued)

### Using the WAC (Wireless Accessory Configuration)

“WAC Mode for iOS”

You can send its Wi-Fi configuration to this system using an iPhone/iPad/iPod touch.

- Supported device:  
iPhone/iPad/iPod touch (iOS version 7.0 or later), or Mac (OS X 10.9 or later, with AirPort Utility 6.3.1. or later)
- The following explanations are based on an iPhone.
- Make sure your iPhone is connected to your home wireless network beforehand.

**1 Press [▲], [▼] on the remote control to select “WAC Mode for iOS” and then press [OK].**

- “Setting” is displayed.

**2 Go to Wi-Fi settings on your iPhone.**

**3 Select “Technics SU-C550 \*\*\*\*\*” under the “SET UP NEW AIRPLAY SPEAKER...” on your iPhone.**

- “\*\*\*\*\*” stands for a character that is unique to each set.

**4 The “AirPlay Setup” screen appears on your iPhone.**

- This system will be displayed as “Technics SU-C550 \*\*\*\*\*”. To change the name, enter a new name to replace the existing one. You can also do the renaming after the network connection is set up. (⇒ 23)
- You can set a password for this system under “SPEAKER PASSWORD”. (You will need this password if you make network settings by internet browser next time.)

**5 Select “Next” to apply the settings.**

- “Linking” is displayed.
- When the connection is established, “Success” is displayed.
  - “Fail” may be displayed if the connection was not complete. Try this method again from [SETUP] menu. If “Fail” is still displayed, try other methods (⇒ 19).

**6 Press [OK] on the remote control to exit the setting.**

- “

### Using the WPS button

“WPS Push”

If your wireless router supports WPS, you can set up a connection by pressing the WPS button.

- A compatible wireless router may have the WPS identifier mark.

**1 Press [▲], [▼] on the remote control to select “WPS Push” and then press [OK].**

- “WPS” is displayed. Complete step 2 within 2 minutes.

**2 After “WPS” is displayed, press the WPS button on the wireless router.**

Example:

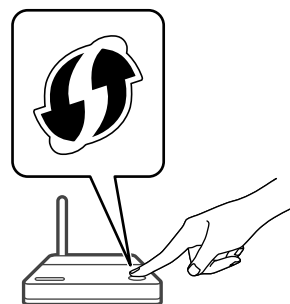

- “Linking” is displayed.
- When the connection is established, “Success” is displayed.
  - “Fail” may be displayed if the connection was not complete. Try this method again from [SETUP] menu. If “Fail” is still displayed, try other methods (⇒ 19).

**3 Press [OK] on the remote control to exit the setting.**

- “

20

## Using the WPS PIN code “WPS PIN”

If your wireless router supports WPS, you can set up a connection by entering the WPS PIN code.

- For details on how to enter the PIN code, refer to the operating instructions of the wireless router.

### 1 Press [▲], [▼] on the remote control to select “WPS PIN” and then press [OK].

- The PIN code is displayed. Complete step 2 within 2 minutes.

### 2 Enter the PIN code into the wireless router from PC, etc.

- “Linking” is displayed.
- When the connection is established, “Success” is displayed.
  - “Fail” may be displayed if the connection was not complete. Try this method again from [SETUP] menu. If “Fail” is still displayed, try other methods (⇒ 19).

### 3 Press [OK] on the remote control to exit the setting.

- “” is displayed.

#### Note

- Depending on a router, other connected devices may temporarily lose their connection.
- For details, refer to the operating instructions of the wireless router.

## Using iPhone/iPad/iPod “With iPod”

With this method you will share the wireless network settings of your iPod/iPhone/iPad with this system.

- Supported device:  
iPhone/iPad/iPod touch (iOS version 5.0 or later)
- The following explanations are based on an iPhone.
- Make sure your iPhone is connected to your home wireless network beforehand.

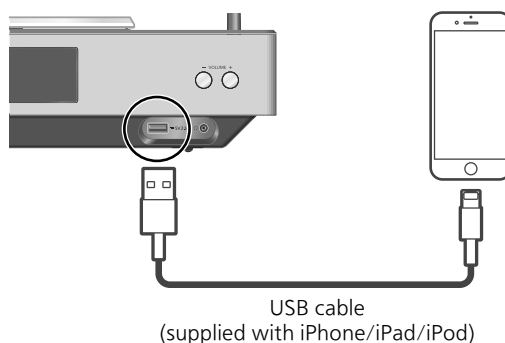

### 1 Connect the iPhone to this unit with the USB cable.

- Use the USB cable supplied with iPhone/iPad/iPod.
- Unlock your iPhone before connecting.

### 2 Press [▲], [▼] on the remote control to select “With iPod” and then press [OK].

- “Connecting Wi-Fi” is displayed.

### 3 Allow the iPhone to share the wireless network settings.

- When the connection is established, “Success” is displayed.
  - “Fail” may be displayed if the connection was not complete. Try this method again from [SETUP] menu. If “Fail” is still displayed, try other methods (⇒ 19).

### 4 Press [OK] on the remote control to exit the setting.

- “” is displayed.

## Network settings (Continued)

### Using "Technics Music App" "Setup from Browser"

If you install the dedicated app "Technics Music App" (free of charge) on your Android device, you can set up a connection using the application.

- If you're using an Android device, download the app at Google Play™.
- Check the password for your home wireless network.
- Make sure your Android device is connected to your home wireless network beforehand.

**1 Press [▲], [▼] on the remote control to select "Setup from Browser" and then press [OK].**

- "Setting" is displayed.

**2 Start "Technics Music App" on the Android device.**

**3 Select  and go to Wi-Fi settings.**

**4 Enter the password for your home wireless network.**

**5 Select "Next" to apply the settings.**

- "Linking" is displayed.
- When the connection is established, "Success" is displayed.
  - "Fail" may be displayed if the connection was not complete. Try this method again from [SETUP] menu. If "Fail" is still displayed, try other methods (⇒ 19).
- Depending on the device, the connection complete screen may not be displayed.

**6 Make sure to connect your compatible device back to your home wireless network.**

**7 Press [OK] on the remote control to exit the setting.**

-  is displayed.

### Using an internet browser "Setup from Browser"

You can access this unit's network settings from the internet browser on iOS device (iOS version 6.1.6 or earlier), Android device, PC, etc.

- The following explanations are based on an Android device.

**1 Press [▲], [▼] on the remote control to select "Setup from Browser" and then press [OK].**

- "Setting" is displayed.

**2 Go to Wi-Fi settings on your compatible device and select "00 Setup \*\*\*\*\*" to connect to this system.**

- "\*\*\*\*\*" stands for a character that is unique to each set.

**3 Start the internet browser and type "http://192.168.1.12/" into the URL address field and display the page.**

- Examples of internet browsers
  - iOS device/Mac: Safari
  - Android device: Google Chrome™
  - PC: Windows Internet Explorer

**4 Select "Search wireless network".**

**5 Select your home wireless network name (Network name (SSID)) and type the password for this network.**

**6 Select "JOIN" to apply the settings.**

- "Linking" is displayed.
- When the connection is established, "Success" is displayed.
  - "Fail" may be displayed if the connection was not complete. Try this method again from [SETUP] menu. If "Fail" is still displayed, try other methods (⇒ 19).
- Depending on the device, the connection complete screen may not be displayed.

**7 Make sure to connect your compatible device back to your home wireless network.**

**8 Press [OK] on the remote control to exit the setting.**

-  is displayed.

#### Note

- Enable JavaScript and Cookies in your browser settings.

## This unit's name on the network "Friendly Name"

You can change this unit's name on the network (e.g. "Room 1" or "Living Room" etc.).

- 1 Press [SETUP].
- 2 Press [▲], [▼] repeatedly to select "Network" and then press [OK].
- 3 Press [▲], [▼] repeatedly to select "Friendly Name" and then press [OK].
  - The current name of this unit is displayed. Press [OK] to edit.
- 4 Press [▲], [▼], [◀], [▶] to input the friendly name.
  - Only ASCII characters can be used.
  - "A" can be added when you press the [▶] at the time of the last letter of the Friendly Name is selected.
  - Press [CLEAR] to delete a letter.
  - Press [≥10] to insert a letter "A".
  - Default name is "Technics SU-C550 \*\*\*\*\*". "\*\*\*\*\*" stands for a digit that is unique to each set.
- 5 Press [OK] to apply the settings.
- 6 Press [RETURN] repeatedly to exit the settings.

## To check the MAC address of this unit "MAC Address"

- 1 Press [SETUP].
- 2 Press [▲], [▼] repeatedly to select "Network" and then press [OK].
- 3 Press [▲], [▼] repeatedly to select "MAC Address" and then press [OK].
  - The MAC address of this unit is displayed.

## To make network-related settings

You can set specific IP address, subnet mask, default gateway, primary DNS, etc. (If your network requires specific settings, disable DHCP.)

- Do not play back music while changing these settings.

- 1 Press [SETUP].
- 2 Press [▲], [▼] repeatedly to select "Network" and then press [OK].
- 3 Select and input the details.
- 4 Press [OK] to apply the settings.
- 5 Press [RETURN] repeatedly to exit the settings.
- 6 Press [⏻] to switch the unit to standby.
  - Wait until "Please Wait" disappears.
- 7 Perform the network setting. (⇒ 18)

## Playing back CDs

Insert the CD for music playback.

- Refer to “Notes on CDs” (⇒ 47) for information about the discs this unit can play back.

- 1 Press [⏻] to turn this unit on.
- 2 Press [CD].
- 3 Open the top cover with a sliding motion and then insert a CD.
  - Place label up and push the centre of a CD until a click is heard.
- 4 Close the top cover with a sliding motion.
  - This unit cannot play back a CD while the top cover is open.
- 5 Press [▶/⏸].

### Note

- Be careful not to get your finger caught in the top cover when opening/closing it.
- Do not apply too much force to the top cover when sliding it. Doing so may cause malfunction.
- Do not leave the top cover open for prolonged periods of time. This will cause the lens to get dirty.
- Be careful not to touch the lens with your fingers.
- The lens lights when the following operations are performed with no CD inserted. This is not a malfunction.
  - Turn the power on
  - Select “CD” as the input source
  - Open or close the top cover

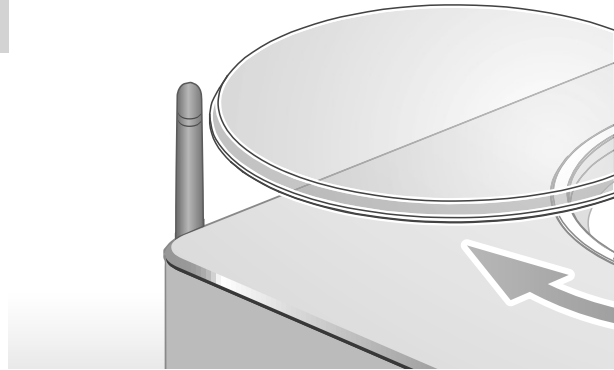
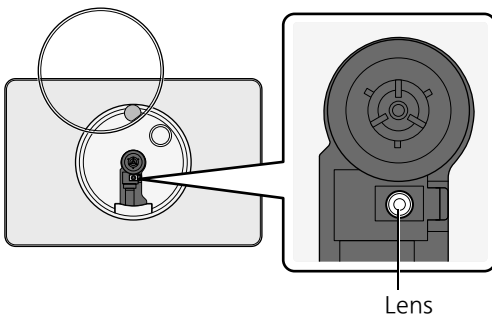

## Operations during playback

Stop	■
Pause	▶/⏸ • Press again to restart play.
Skip	⏮ ⏭
Search	⏪ ⏩ • On the unit: touch and hold [⏮] or [⏩].
Viewing available information	[INFO]

## Repeat playback “Repeat”

- 1 Press [MENU].
- 2 Press [▲], [▼] repeatedly to select “Repeat” and then press [OK].
- 3 Press [▲], [▼] to select an item and then press [OK].

### 1-Track:

Only plays the selected track. (“1↻” is displayed.)

### All:

All tracks are repeated. (“↻” is displayed.)

- Setting is available even when the input source is switched to “USB” (⇒ 26) or “DMP” (⇒ 32).



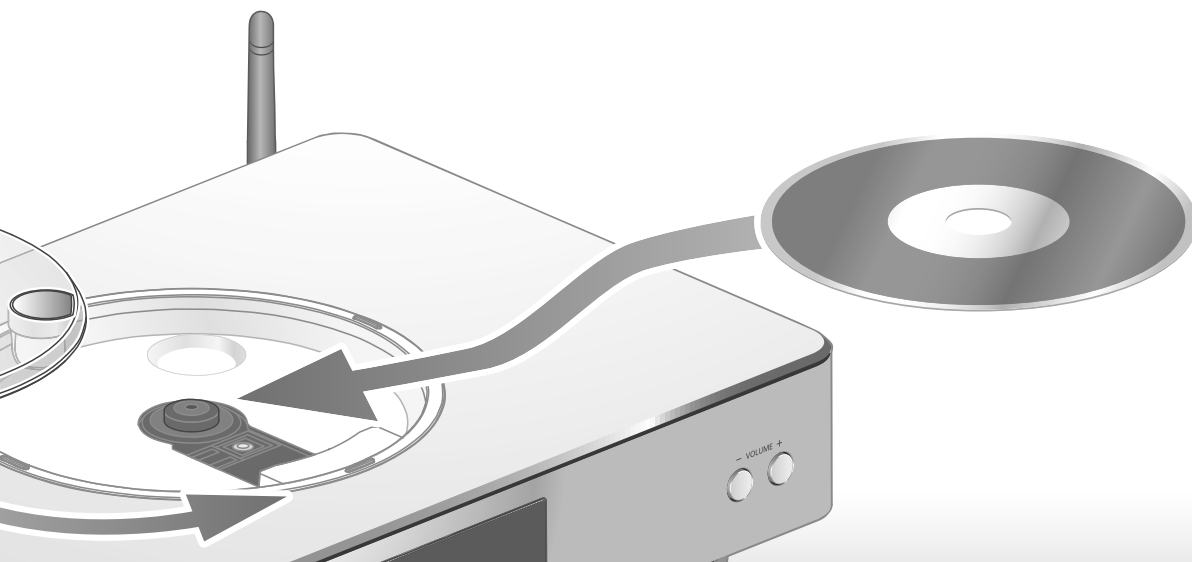

## Random repeat playback "Random"

- 1 Press [MENU].
- 2 Press [▲], [▼] repeatedly to select "Random" and then press [OK].
- 3 Press [▲], [▼] to select "On" and then press [OK].

- All tracks are repeated randomly. ("RND" and "🔄" are displayed.)
- Setting is available even when the input source is switched to "USB" (⇒ 26) or "DMP" (⇒ 33).

## Programme playback "Program"

- 1 Press [MENU].
- 2 Press [▲], [▼] repeatedly to select "Program" and then press [OK].
- 3 Press [▲], [▼] to select "On" and then press [OK].
  - "Program Mode" screen is displayed.
- 4 Press the numeric buttons to select tracks.
  - Repeat this step to make further selections.
- 5 Press [▶/||] to start playback.

<b>Stop</b>	Press [■]. • Programmed content is maintained.
<b>Check the programmed order</b>	Press [◀] or [▶] in the stop mode.
<b>Add tracks</b>	Do step 4 in the stop mode.
<b>Clear the last track</b>	Press [CLEAR] in the stop mode. • It is not possible to select and clear the desired programmed track.

- To cancel programme mode (The programme memory will be cleared.)
  - ① Press [■] in the stop mode.
  - ② Press [▲], [▼] to select "Yes" and then press [OK].
- To cancel programme mode (The programme memory won't be cleared.)
  - ① Press [MENU].
  - ② Press [▲], [▼] repeatedly to select "Program" and then press [OK].
  - ③ Press [▲], [▼] to select "Off" and then press [OK].

### Note

- The programme memory is cleared when replacing a CD.
- The programme mode is cancelled when random repeat playback is set.

## Using USB device

Connect a USB device to the unit, and you can play back music stored on the USB device.

- Refer to "USB" (⇒ 47) for information about the USB device this unit can play back.

### 1 Connect a USB device to the unit.

### 2 Press [USB].

- The folder/content selection screen will be displayed.

### 3 Press [▲], [▼] to select an item and then press [OK].

- Repeat this step to make further selections.
- Press [RETURN] to return to the previous folder.

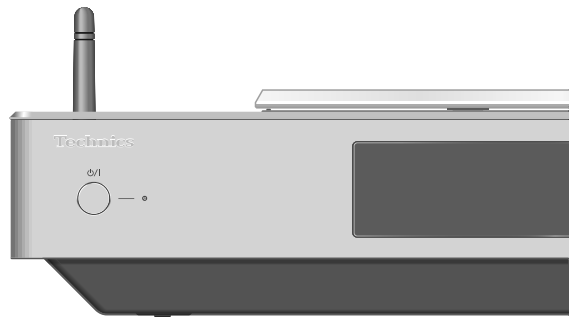

USB device

## Operations during playback

Stop	■
Pause	▶/   • Press again to restart play.
Skip	◀◀ ▶▶
Search	◀◀ ▶▶ • On the unit: touch and hold [◀◀] or [▶▶].
Viewing available information	[INFO]

- This operation may not be available for some formats.

## Repeat playback "Repeat"

### 1 Press [MENU].

### 2 Press [▲], [▼] repeatedly to select "Repeat" and then press [OK].

### 3 Press [▲], [▼] to select an item and then press [OK].

#### 1-Track:

Only plays the selected track. ("1↻" is displayed.)

#### All:

All tracks in the folder are repeated. ("↻" is displayed.)

- Setting is available even when the input source is switched to "CD" (⇒ 24) or "DMP" (⇒ 32).

## Random repeat playback "Random"

### 1 Press [MENU].

### 2 Press [▲], [▼] repeatedly to select "Random" and then press [OK].

### 3 Press [▲], [▼] to select "On" and then press [OK].

- All tracks in the folder are repeated randomly. ("RND" and "↻" are displayed.)
- During random playback, you cannot skip to the previous track.
- During random playback, tracks may be played more than once.
- Setting is available even when the input source is switched to "CD" (⇒ 25) or "DMP" (⇒ 33).

Connect an iPhone/iPad/iPod to the unit using USB cable\*, and you can play back music stored on iPhone/iPad/iPod or charge iPhone/iPad/iPod.

- Refer to “iPhone/iPad/iPod” (⇒ 47) for information about the iOS device this unit can play back.

\*: Use the USB cable supplied with iPhone/iPad/iPod.

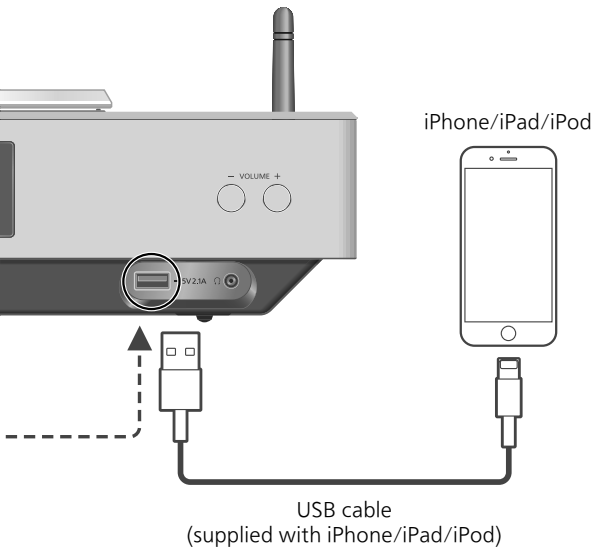

## 1 Connect an iPhone/iPad/iPod to the unit.

## 2 Press [USB].

- The display will automatically change to “iPod\_Port” when a compatible iPhone/iPad/iPod is connected to the USB-A terminal.

## 3 Start playback on the iPhone/iPad/iPod.

## Operations during playback

<b>Stop</b>	■
<b>Pause</b>	▶/   • Press again to restart play.
<b>Skip</b>	◀◀ ▶▶
<b>Search</b>	◀◀ ▶▶ • On the unit: touch and hold [◀◀] or [▶▶].

- For “Repeat” and “Shuffle”. (⇒ 36)

### Note

- Compatibility depends on the software version. Update your iPhone/iPad/iPod to the latest software before using it with this unit.
- Operation results may vary depending on the iPhone/iPad/iPod models or the iOS version.

## Charging an iPhone/iPad/iPod

During unit on, charging starts when an iPhone/iPad/iPod is connected to this unit.

- To continue charging from the USB cable connection during standby mode, make sure the iPhone/iPad/iPod has started charging before turning the unit to standby mode.
- Check the iPhone/iPad/iPod to see if the battery is fully charged. Once fully charged, remove the iPhone/iPad/iPod.

### Note

- When this unit is in standby mode, “iPod Charging” is displayed and the power indicator lights red.
- Charging stops when the battery is fully charged. The battery will deplete naturally.
- When charging an iPhone/iPad/iPod whose battery is depleted, do not turn this unit to standby mode until the iPhone/iPad/iPod becomes operational.

## Using Bluetooth®

You can listen to the sound from the Bluetooth® audio device from this unit wirelessly.

- Refer to the operating instructions of the Bluetooth® device for details.



### ■ Pairing a Bluetooth® device

- Turn on the Bluetooth® feature of the device and place the device near this unit.
- If a Bluetooth® device is already connected, disconnect it. (⇒ 29)

#### 1 Press [Ⓚ-PAIRING].

#### 2 Press [MENU].

#### 3 Press [▲], [▼] repeatedly to select "Pairing" and then press [OK].

#### 4 Press [▲], [▼] to select "Yes" and then press [OK].

- "Pairing" is displayed, and this unit waits for registering.

#### 5 Select "SU-C550" from the Bluetooth® device's menu.

- The name of the connected device is indicated on the display.
- MAC address may be displayed before "SU-C550" appears. (e.g. 6C:5A:B5:B3:1D:0F)

#### Note

- You can also enter pairing mode by pressing and holding [Ⓚ-PAIRING] when the input source is "Bluetooth".
- If prompted for the passkey, input "0000".
- You can register up to 8 devices with this unit. If a 9th device is paired, the device that has not been used the longest will be replaced.

### ■ Listening to music stored on a Bluetooth® device

#### 1 Press [Ⓚ-PAIRING].

- "Ready" is indicated on the display.

#### 2 Select "SU-C550" from the Bluetooth® device's menu.

- The name of the connected device is indicated on the display.

#### 3 Start playback on the Bluetooth® device.

#### Note

- This unit can only be connected to one device at a time.
- When "Bluetooth" is selected as the input source, this unit will automatically try and connect to the last connected Bluetooth® device. ("Linking" is displayed during this process.)



Bluetooth® device

## Bluetooth® transmission mode

You can change the transmission mode to prioritise transmission quality or sound quality.

### 1 Press [PAIRING].

- If a Bluetooth® device is already connected, disconnect it.

### 2 Press [MENU].

### 3 Press [▲], [▼] repeatedly to select “Link Mode” and then press [OK].

### 4 Press [▲], [▼] to select the mode and then press [OK].

#### Mode1:

Emphasis on connectivity

#### Mode2:

Emphasis on sound quality (default)

#### Note

- Select “Mode1” if the sound is interrupted.

## Operations during playback

Stop	■
Pause	▶/   • Press again to restart play.
Skip	◀◀ ▶▶
Search	◀◀ ▶▶ • On the unit: touch and hold [◀◀] or [▶▶].

#### Note

- To use this unit’s remote control/basic control buttons with a Bluetooth® device, the Bluetooth® device must support AVRCP (Audio Video Remote Control Profile). Depending on the status of the device, some controls may not work.
- When enjoying video contents with this function, the video and audio output may not be synchronised.

## Disconnecting a Bluetooth® device

### 1 Press [MENU].

### 2 Press [▲], [▼] repeatedly to select “Disconnect?” and then press [OK].

### 3 Press [▲], [▼] to select “Yes” and then press [OK].

#### Note

- The Bluetooth® device will be disconnected if a different audio source is selected.

## Using digital audio output device

You can input digital audio signals to this unit and play back music.

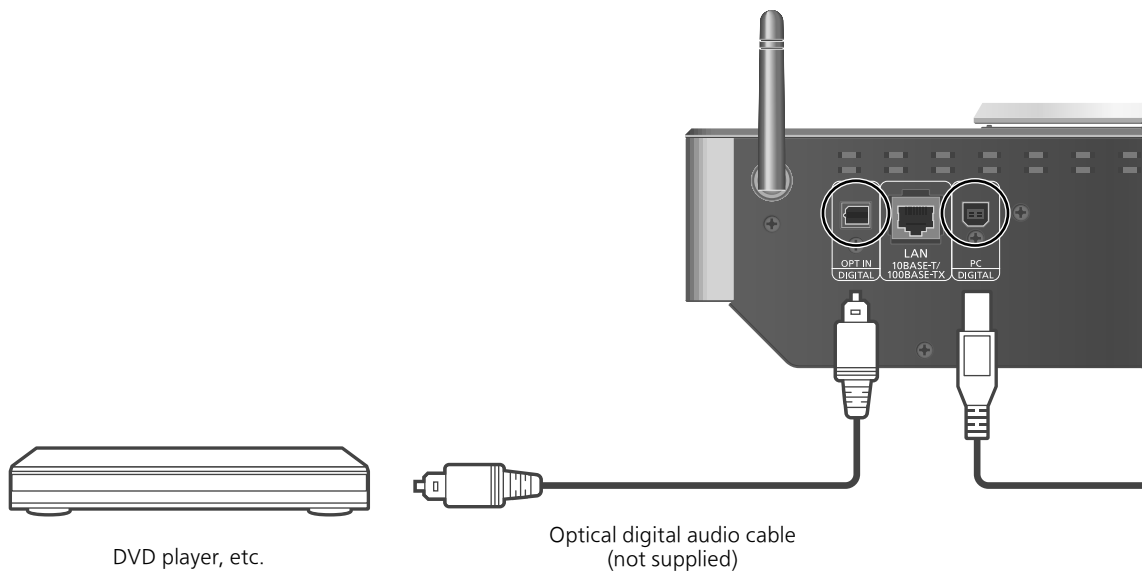

- 1 Disconnect the AC mains lead.
- 2 Connect this unit and a DVD player etc.
- 3 Connect the AC mains lead to this unit. (⇒ 17)
- 4 Press [⏻] to turn this unit on.
- 5 Press [➤SELECT<] repeatedly to select "OPT".
- 6 Start playback on the connected device.

### Note

- The digital audio input terminals of this unit can only detect linear PCM signals. For details, refer to the operating instructions of the device.
  - Sampling frequency:  
32/44.1/48/88.2/96 kHz
  - Number of quantisation bits:  
16/24 bit

You can connect the USB-B terminal and a PC, etc. with a USB cable and play back music on the PC, etc. with this unit.

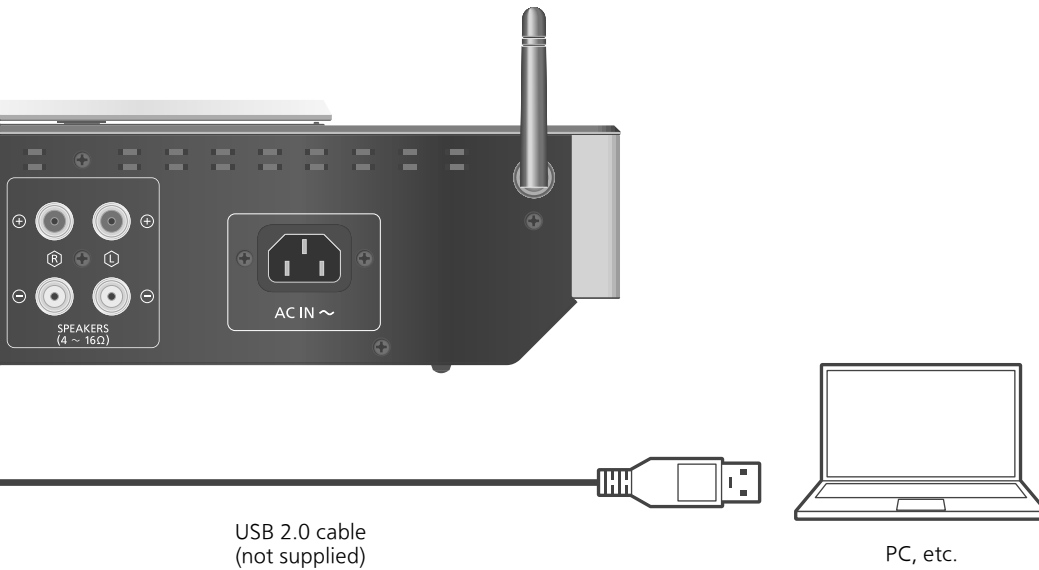

## ■ Preparation

### Connecting to a PC

- Before connecting to a PC, follow the steps below.
  - Refer to the following for the recommend OS versions for your PC (as of December 2015):
    - Windows 7, Windows 8, Windows 8.1, Windows 10
    - OS X 10.7, 10.8, 10.9, 10.10, 10.11
- ① Download and install the dedicated USB driver to the PC. (Only for Windows OS)
    - Download and install the driver from the website below.  
[www.technics.com/support/](http://www.technics.com/support/)
  - ② Download and install the dedicated app "Technics Audio Player" (free of charge) on your PC.
    - Download and install the app from the website below.  
[www.technics.com/support/](http://www.technics.com/support/)

**1 Disconnect the AC mains lead.**

**2 Connect this unit and a PC, etc.**

**3 Connect the AC mains lead to this unit. (⇒ 17)**

**4 Press [⏻] to turn this unit on.**

**5 Press [>SELECT<] repeatedly to select "PC".**

**6 Start playback using the dedicated app "Technics Audio Player" on the connected PC.**

### Note

- About supported format, refer to "File format" (⇒ 53)

## Playing back music files on the DLNA server

You can share music files stored in the DLNA Certified media server (PC, Network Attached Storage, etc.) connected to your home network, and enjoy the contents with this unit.

### ■ Preparation

- Complete the network settings. (⇒ 18)
- Connect the device to be used to the same network as this unit.
- To use Windows Media® Player
  - Add the contents and folder to the libraries of the Windows Media® Player 11 or 12, or a smartphone, etc.
  - Playlist of Windows Media® Player can play back only the contents that are stored in the libraries.
  - To use Windows Media® Player for streaming, you need to configure it in advance.



Playing back content stored on the DLNA server by controlling it from this unit

- 1 Press [ >SELECT< ] repeatedly to select "DMP".**
  - The server selection screen will be displayed.
- 2 Press [▲], [▼] to select a DLNA server on the network, and then press [OK].**
  - The folder/content selection screen will be displayed. Repeat this step to make further selections.
  - Folders/content may be displayed in different order from the order on the server, depending on its specifications.
- 3 Press [▲], [▼] to select an item and then press [OK].**

#### Note

- The connected server and its contents may not be displayed properly depending on its condition. (e.g. soon after adding the contents to the server, etc.) Please try again later. For details, refer to the operating instructions of the device.

### Operations during playback

Stop	■
Pause	▶/   • Press again to restart play.
Skip	◀◀ ▶▶
Search	◀◀ ▶▶ • On the unit: touch and hold [◀◀] or [▶▶].
Viewing available information	[INFO]

### Repeat playback "Repeat"

- 1 Press [MENU].**
- 2 Press [▲], [▼] repeatedly to select "Repeat" and then press [OK].**
- 3 Press [▲], [▼] to select an item and then press [OK].**



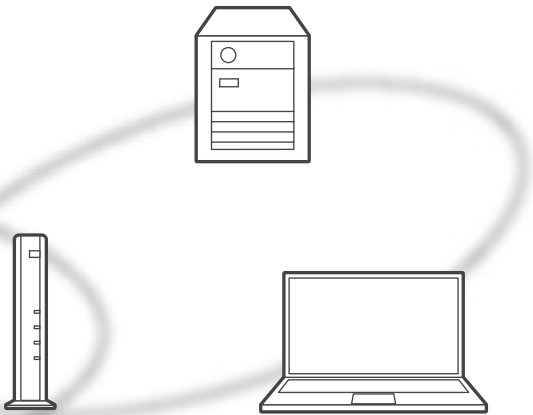

## Operations using the dedicated app “Technics Music App”

If you install the dedicated app “Technics Music App” (free of charge) on your tablet/ smartphone, you can control this unit using a wide variety of functions.  
For details, visit:  
[www.technics.com/support/](http://www.technics.com/support/)

## Playing back content stored on the DLNA server by controlling it from a DMC

By controlling a DMC (Digital Media Controller) compatible device, you can play back music stored on the DLNA server on this unit (DMR—Digital Media Renderer).

- 1 Press [⏻] to turn this unit on.
- 2 Operate the DMC compatible device and connect to this unit.

- The device name of this unit will be displayed as “Technics SU-C550 \*\*\*\*\*”<sup>\*1, 2</sup>.
- For details on how to use DMC compatible devices, refer to the operating instructions of the devices or the software.

### Note

- When you operate DMC, playback of other audio sources will stop and DLNA output will have priority.
  - Depending on the contents and the connected equipment, operations or playback may not be possible.
  - This unit does not guarantee connection with all DMC applications. Use the dedicated app “Technics Music App”.
- \*1: “\*\*\*\*\*” stands for a digit that is unique to each set.  
\*2: The device name can be changed from “This unit’s name on the network”. (⇒ 23)

### 1-Track:

Only plays the selected track. (“1↻” is displayed.)

### All:

All tracks are repeated. (“↻” is displayed.)

- Setting is available even when the input source is switched to “CD” (⇒ 24) or “USB” (⇒ 26).

## Random repeat playback “Random”

- 1 Press [MENU].
- 2 Press [▲], [▼] repeatedly to select “Random” and then press [OK].
- 3 Press [▲], [▼] to select “On” and then press [OK].

- All tracks in the folder are repeated randomly. (“RND” and “↻” are displayed.)
- During random playback, you cannot skip to the previous track.
- During random playback, tracks may be played more than once.
- Setting is available even when the input source is switched to “CD” (⇒ 25) or “USB” (⇒ 26).

## Playing back Internet Radio (vTuner)

Internet Radio is an audio broadcasting service transmitted via the Internet. vTuner is a free online content service to listen to the many Internet Radio stations over the world.

### ■ Preparation

- Complete the network settings. (⇒ 18)
  - Make sure that the network is connected to the Internet.

### 1 Press [>SELECT<] repeatedly to select “Internet Radio”.

- When “Internet Radio” is selected as the source, this unit will automatically try and connect to the last selected Internet Radio station.

### 2 Press [▲], [▼] to select a station and then press [OK].

- The buffering status is displayed as □ %. (□ stands for a number.)
- Repeat this step to make further selections according to the genre, region, etc.
- Press [RETURN] to return to the previous screen.
- The Internet Radio stations, genre, region, etc. on this unit are edited and managed by vTuner.
- The podcasts on the list of vTuner can also be played back.
- The station that does not broadcast cannot be played back. (It will be skipped or return to the list.)

#### Note

- The Internet Radio service may be suspended or be otherwise unavailable without notice.
- Internet Radio may not be played back properly depending on the network condition.



### Operations during playback

<b>Stop</b>	■ (Returns to the list.)
<b>Pause</b>	▶/   • Press again to restart play. (While playing back the podcasts)
<b>Skip</b>	◀◀ ▶▶
<b>Viewing available information</b>	[INFO]

### Adding a station to favourite list

#### “Add Favourites”

### 1 Press [▲], [▼] to select a station to add and then press [OK].

### 2 Press [MENU].

### 3 Press [▲], [▼] repeatedly to select “Add Favourites” and then press [OK].

- “Added” is displayed after registering.
- You can register up to 50 stations with this unit. If a 51st station is added, “Favourites Full” is displayed. Delete the stations from the favourite list. (⇒ 35)
- You cannot add the already registered station. (“Already Exists” is displayed.)

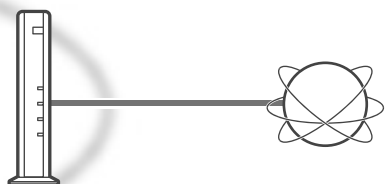

## Calling up the favourite list "Call Favourites"

- 1 Press [MENU].
  - 2 Press [▲], [▼] repeatedly to select "Call Favourites" and then press [OK].
  - 3 Press [▲], [▼] to select "On" and then press [OK].
- "★" is displayed.
  - If no station is registered to the favourite list, "Empty" is displayed. Add a station to the list. (⇒ 34)

## Deleting the favourite station "Delete Favourites"

- 1 Press [MENU].
  - 2 Press [▲], [▼] repeatedly to select "Delete Favourites" and then press [OK].
  - 3 Press [▲], [▼] to select a station to delete from the favourite list.
  - 4 Press [▲], [▼] to select "Yes" and then press [OK].
- "Deleted" is displayed after deleting.
  - "Empty" is displayed if no station is registered to the favourite list.

## Operations using the dedicated app "Technics Music App"

If you install the dedicated app "Technics Music App" (free of charge) on your tablet/smartphone, you can control this unit and edit the station list with the vTuner function. Download and install the app from the website below.

[www.technics.com/support/](http://www.technics.com/support/)

## Creating the Internet Radio station list with PC

- 1 Press [>SELECT<] repeatedly to select "Internet Radio".
  - 2 Check the MAC address of this unit. (⇒ 23)
  - 3 Use your PC to access the vTuner website.  
[www.technics.com/radio/](http://www.technics.com/radio/)
- You can select the language on the website.
- 4 Follow the on-screen instructions and enter the necessary information for registration.
  - 5 Search by category (genre, region, language, etc.) or edit the list.

■ **Playback of the stations listed by your PC**  
You can play back the stations listed by your PC separately from the favourite list of this unit.

- 1 Press [>SELECT<] repeatedly to select "Internet Radio".
  - 2 Press [▲], [▼] repeatedly to select "technics.com/radio/" and then press [OK].
- Before disposing of or transferring this unit, delete the personal information on the website.

## Using AirPlay

You can play back music stored on iOS device, etc. using AirPlay.

- AirPlay works with iPhone, iPad, and iPod touch with iOS 4.3.3 or later, Mac with OS X Mountain Lion or later, and PC with iTunes 10.2.2 or later.

### ■ Preparation

- Complete the network settings. (⇒ 18)
- Connect the iOS device or PC to the same network as this unit.

#### 1 (iOS device)

Start the “Music” (or iPod) app.

(PC)

Start “iTunes”.

#### 2 Select “Technics SU-C550 \*\*\*\*\*”<sup>\*1, 2</sup> from the AirPlay icon .

#### 3 Start play.

- Check the volume settings before starting the playback.
- When AirPlay is used for the first time, the volume may be output at the maximum setting.
- The playback will start with a slight delay.
- \*1: “\*\*\*\*\*” stands for a digit that is unique to each set.
- \*2: The device name can be changed from “This unit’s name on the network”. (⇒ 23)

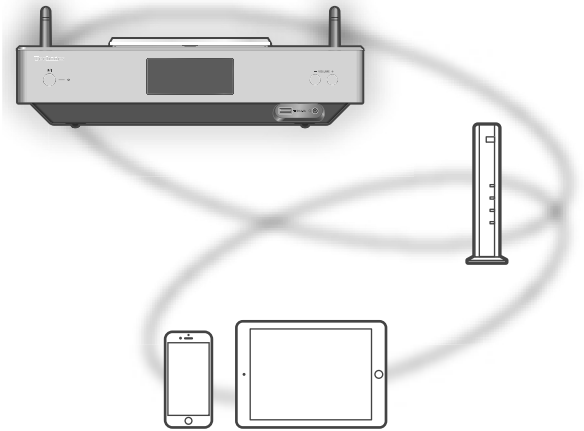

## Operations during playback

Stop	■
Pause	▶/   • Press again to restart play.
Skip	◀◀ ▶▶

### Note

- Playback of other audio sources will stop and AirPlay output will have priority.
- Volume changes on the iOS device or iTunes will apply to this unit. (Refer to the iTunes Help for the required settings in iTunes.)
- With some iOS and iTunes versions, it may not be possible to restart the AirPlay playback if the selector is changed or the unit is turned to standby mode, during the AirPlay playback. In this case, select a different device from the AirPlay icon of the Music app or iTunes and then re-select this unit as the output speakers.
- AirPlay will not work when playing back videos on iTunes.

## Repeat playback “Repeat”

- 1 Press [MENU].
  - 2 Press [▲], [▼] repeatedly to select “Repeat” and then press [OK].
  - 3 Press [▲], [▼] to set, and press [OK].
- Refer to the connected device to verify the selected setting.
  - You can also set on the connected iOS device/PC.

## Random repeat playback “Shuffle”

- 1 Press [MENU].
  - 2 Press [▲], [▼] repeatedly to select “Shuffle” and then press [OK].
  - 3 Press [▲], [▼] to set, and press [OK].
- Refer to the connected device to verify the selected setting.
  - You can also set on the connected iOS device/PC.

This unit is compatible with the online music service (Spotify).

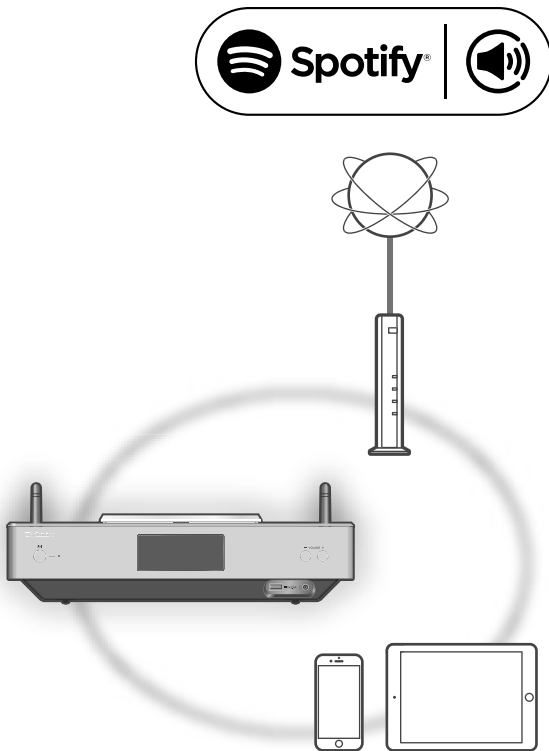

## ■ Preparation

- You will need Spotify Premium. For details, visit the following website.  
[www.spotify.com/connect/](http://www.spotify.com/connect/)
- Complete the network settings. (⇒ 18)
  - Make sure that the network is connected to the Internet.
- Connect the device to be used to the same network as this unit.

- 1 Start the Spotify app on your device, and select a song to play back.**
- 2 Select the square image of the song's cover art in the bottom left of the playback screen.**
- 3 Select the icon "🔊".**
- 4 Select this unit as the output speakers.**

## Note

- The device name of this unit will be displayed as "Technics SU-C550 \*\*\*\*\*"\*1, 2.
- Registration/subscription is required.
- Fees may apply.
- Services, icons, and specifications are subject to change.
- \*1: "\*\*\*\*\*" stands for a digit that is unique to each set.
- \*2: The device name can be changed from "This unit's name on the network". (⇒ 23)

## Sound adjustment, Other settings

The sound effects and other settings can be set up.

- 1 Press [SETUP].
- 2 Press [▲], [▼] repeatedly to select the menu and then press [OK].
- 3 Press [▲], [▼], [◀], [▶] to set, and press [OK].

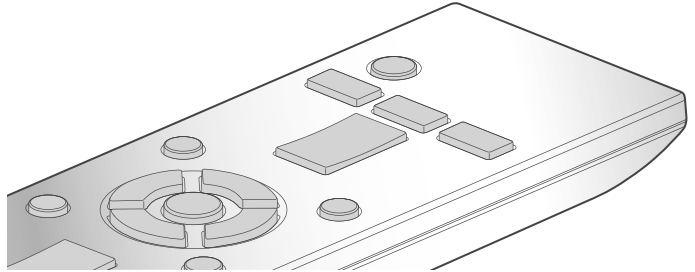

### Adjusting Bass/Middle/Treble "Tone Control"

You can adjust the tone of this unit. Each tonal range (Bass/Middle/Treble) can be adjusted.

- To enable this function, select "On (adjustment)".
- Each level can be adjusted between "- 10" and "+ 10".
- "TONE" is displayed after setting.

### Sleep timer "SLEEP"

The sleep timer can turn the unit to standby mode after a set time. (30 minutes/60 minutes/90 minutes/120 minutes/Off)

### Auto off function "AUTO OFF"

This unit is designed to conserve its power consumption and save energy. The unit has been left unused for about 20 minutes and will enter standby mode within a minute. Press any button to cancel it.

- The factory default is "On". To disable this function, select "Off".

#### Note

- The auto off function works unless you turn it off, even if you turn this unit to standby mode and on.

### Illumination on the top cover and bottom of the unit "ILLUMINATION"

The top cover and bottom of the unit illuminate when this unit is turned on. (Lights of the top cover turns off when the top cover is opened.)

- The factory default is "Mode2". To disable this function, select "Off".

#### Mode1:

The top cover and bottom of the unit always illuminate.

#### Mode2:

The top cover illuminates only when a playable CD is inserted and the input source is "CD".  
The bottom of this unit always illuminates.

#### Off:

The top cover and bottom of the unit do not illuminate.

### Operation sound setting "Beep"

You can turn the beep sound on/off.

- The factory default is "On". To disable this function, select "Off".

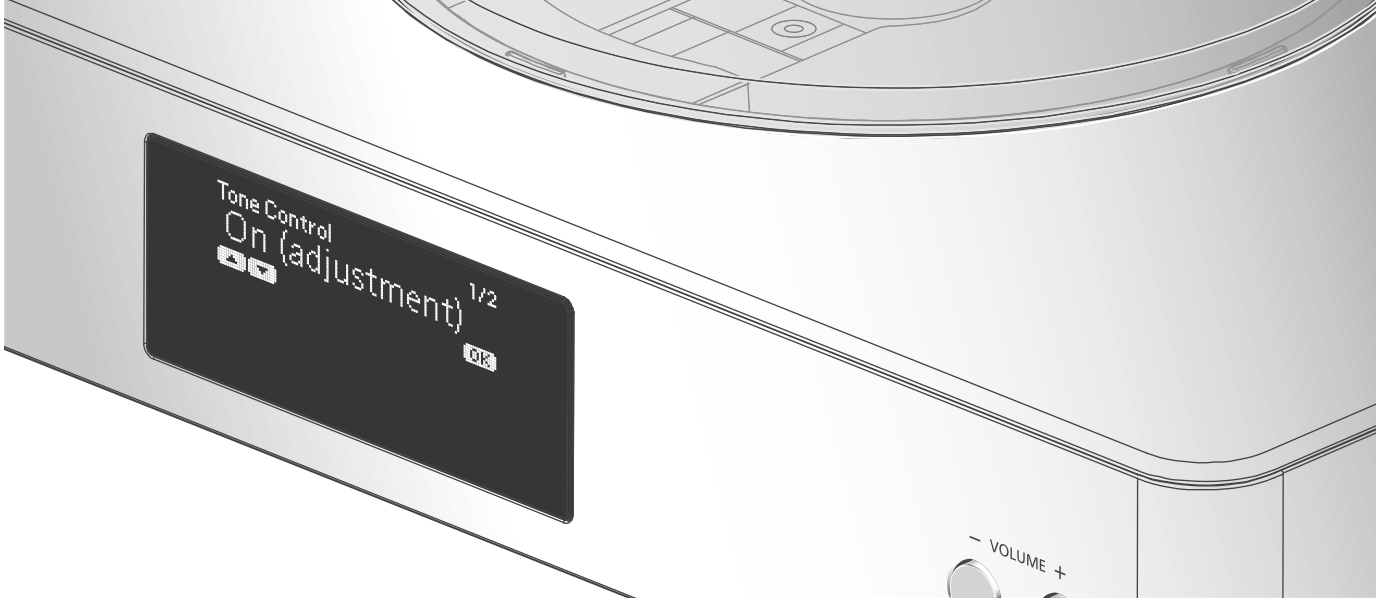

## Network settings “Network”

### Network standby “Network Standby”

This unit can turn on automatically from standby mode when this unit is selected as the Spotify/AirPlay/DLNA player.

- The factory default is “Auto”.

#### Auto:

Enables the network standby function when the network connection is available.

#### On:

Always enables the network standby function.

#### Note

- If this function is set to “On” or “Auto”, the standby power consumption will increase.
- Power indicator lights red when the network standby function is available.

### Wireless LAN setting “Wi-Fi”

The wireless LAN function can be enabled or disabled.

- The factory default is “Off”.

### Wi-Fi signal strength “Signal Level”

To check the Wi-Fi signal strength where this system is located.

- It is recommended to have a signal strength of “3”. Change the position or angle of your wireless router or this system if the indicator is “2” or “1” and see if the connection improves.
- If “0” is displayed, this system cannot establish a link with the wireless router.

### Changing the character encoding “E Asian Character”

You can change the character encoding of track names, artist names and other information when they are not displayed as they should be.

#### Type 1(日本):

Priority is given to Japanese. (default)

#### Type 2(简体字):

Priority is given to Chinese (Simplified).

### Checking the firmware version “F/W Version”

The version of the installed firmware is displayed.

## Sound adjustment, Other settings (Continued)

## Firmware updates

## "F/W Update"

Occasionally, Panasonic may release updated firmware for this unit that may add or improve the way a feature operates. These updates are available free of charge.

- For the update information, refer to the following website.  
[www.technics.com/support/firmware/](http://www.technics.com/support/firmware/)

**Downloading takes approx. 15 minutes. Do not disconnect the AC mains lead or turn this unit to standby while updating.**

- The progress is displayed as "Updating □ %" while updating. (□ stands for a number.)

**Note**

- During the update process, no other operations can be performed.
- If there are no updates, "Firmware is Up To Date" is displayed. (No need to update it.)
- Updating the firmware may reset the settings.

## Update via Internet

## ■ Preparation

- Connect this unit to the network. (⇒ 18)
  - Make sure that the network is connected to the Internet.

**1 Press [SETUP].****2 Press [▲], [▼] repeatedly to select "F/W Update" and then press [OK].****3 Press [▲], [▼] to select "Internet" and then press [OK].****4 Press [▲], [▼] to select "Yes" and then press [OK].**

- The progress is displayed as "Updating □ %" while updating. (□ stands for a number.)
- When the update has finished successfully, "Success" is displayed.

**5 Disconnect the AC mains lead and reconnect it after 3 minutes.****Note**

- Downloading may take longer or may not work properly depending on the connection environment.

## Update via USB flash memory

## ■ Preparation

- Download the latest firmware on the USB flash memory. For details, refer to the following website.

[www.technics.com/support/firmware/](http://www.technics.com/support/firmware/)

**1 Connect the USB flash memory with new firmware.****2 Press [SETUP].****3 Press [▲], [▼] repeatedly to select "F/W Update" and then press [OK].****4 Press [▲], [▼] to select "USB" and then press [OK].****5 Press [▲], [▼] to select "Yes" and then press [OK].**

- The progress is displayed as "Updating □ %" while updating. (□ stands for a number.)
- When the update has finished successfully, "Success" is displayed.

**6 Disconnect the AC mains lead and reconnect it after 3 minutes.****Note**

- Downloading may take longer depending on the USB flash memory.



You can make the optimum adjustment according to your own speakers.

## Measuring the output signal of the amplifier and correcting its output (LAPC)

### ■ Preparation

- Disconnect the headphones.

### Test tone emitted during measurement

To ensure the measurement accuracy, the speakers output a test tone at regular intervals. (For approximately 3 minutes)

It is not possible to change the volume of the audio being output while the measurement is in progress.

- 1 Press [⏻] to turn this unit on.
- 2 Press [SETUP].
- 3 Press [▲], [▼] repeatedly to select "LAPC" and then press [OK].
- 4 Press [▲], [▼] to select "Measurement Start" and then press [OK].
- 5 Press [▲], [▼] to select "Yes" and then press [OK].
  - "LAPC Measuring" is displayed.

This unit will start measuring the output signal of the amplifier. Check that a test tone is output from both the left and right speakers. (A test tone will output after several seconds of starting the measurement.)

When the measurement is complete, amplifier output correction will be automatically turned on.

- If you press [■] while the measurement is in progress, it will be cancelled.
- If you connect the headphones during amplifier signal measurement or amplifier output correction, it will be cancelled.

### ■ Turning on/off the output correction function

- 1 Press [SETUP].
- 2 Press [▲], [▼] repeatedly to select "LAPC" and then press [OK].
- 3 Press [▲], [▼] to select "Setting" and then press [OK].
- 4 Press [▲], [▼] to select "On"/"Off" and then press [OK].

#### Note

- Depending on the type of the connected speakers, the effect of the output correction function may be minimal.
- The corrected output remains in effect until you measure the output signal again. When you use other speakers, redo the measurement.

Before requesting service, make the following checks. If you are uncertain about some of the check points, or if the solutions indicated in the following guide does not resolve the issue, then consult your dealer for instructions.

## Heat buildup of this unit

This unit becomes warm when used for a long time. This is not a malfunction.

## Do you have the latest firmware installed?

Panasonic is constantly improving the unit's firmware to ensure that our customers are enjoying the latest technology. (⇒ 40)

## To return all settings to the factory defaults

When the following situations occur, reset the memory:

- There is no response when buttons are pressed.
- You want to clear and reset the memory contents.

### 1 Press [SETUP].

### 2 Press [▲], [▼] repeatedly to select "Initialization" and then press [OK].

### 3 Press [▲], [▼] to select "Yes" and then press [OK].

- All the settings are set back to the factory defaults. It is necessary to set the memory items again.

### 4 Press [▲], [▼] to select "Yes" and then press [OK] again.

## General

### The unit does not work.

#### Operations are not done properly.

- One of the unit's safety devices may have been activated.
  - ① Press [⏻/⏪] on the unit to switch the unit to standby.
    - If the unit does not switch to standby, press [⏻/⏪] on the unit for at least 5 seconds. The unit is forcibly switched to standby.  
Alternatively, disconnect the AC mains lead, wait for at least 3 minutes, then reconnect it.
  - ② Press [⏻/⏪] on the unit to switch on. If the unit still cannot be operated, consult the dealer.

#### A "humming" sound can be heard during playback.

- An AC mains lead or fluorescent light is near the cables. Keep other appliances and cords away from the cables of this unit.
- A strong magnetic field near a TV or other device may adversely affect the audio quality. Keep this unit away from such devices.
- The speakers may output noise when a device nearby is emitting powerful radio waves, such as when a mobile phone is on a call.

#### No sound.

- Check the volume of this unit.
- Check connections to speakers and other equipment. After checking the connections, measure the output signal of the amplifier. (⇒ 41)
- Check to see if the correct input source is selected.
- Insert the plugs of the cables to be connected all the way in.
- Playback of multi-channel content is not supported.
- The digital audio input terminals of this unit can only detect linear PCM signals. For details, refer to the operating instructions of the device.

#### Playback does not start.

- Depending on your environment or connected devices, it may take some time.
- Check to see if the format of the file is supported. About supported format, refer to "File format". (⇒ 53)

### **The unit turns to standby mode automatically.**

- Is the auto off function turned on? (⇒ 38)
- This unit incorporates a protection circuit to prevent damage caused by heat buildup. When you use this unit at a high volume level for a long period of time, it may turn off automatically. Wait for this unit to cool down before turning on this unit again. (For approximately 3 minutes)

### **The settings are reset to the factory defaults.**

- Updating the firmware may reset the settings.

## Disc

### **Incorrect display or play does not start.**

- Make sure that the disc is compatible with this unit. (⇒ 47)
- There is moisture on the lens. Wait for about an hour and then try again.
- Unfinalised CD-R and CD-RW cannot be played back.
- WMA/MP3 is not supported. Refer to “Notes on CDs” (⇒ 47) for information about the discs this unit can play back.

### **Playback takes time to start.**

- It may take some time for the disc to load if there are a lot of tracks on it.

## USB

### **The USB drive or its contents cannot be read.**

- The USB drive format or its contents is/are not compatible with the unit. (⇒ 47)

### **No response when [▶/||] is pressed.**

- Disconnect the USB device and then reconnect it. Alternatively, turn the unit to standby and on again.

### **Slow operation of the USB flash drive.**

- Large file size or high memory USB flash drive takes longer time to read.
- It may take some time if there are a lot of files or folders on it.

## iPhone/iPad/iPod

### **Cannot operate.**

- Select “USB” as the input source. (⇒ 27)
- Check that the iPhone/iPad/iPod is connected properly. (⇒ 27)
- The battery of the iPhone/iPad/iPod is depleted. Charge the iPhone/iPad/iPod, and then operate again. (⇒ 27)
- Connect the iPhone/iPad/iPod again or try to restart the iPhone/iPad/iPod.

### **iPhone/iPad/iPod does not charge.**

- Only when unit is ON will charging begin from USB cable connection.
- Make sure the unit is turned on when you start charging.
  - When charging an iPhone/iPad/iPod whose battery is depleted, do not turn this unit to standby mode until the iPhone/iPad/iPod becomes operational.

## Bluetooth®

### **Pairing cannot be completed.**

- Check the Bluetooth® device condition.

### **The device cannot be connected.**

- The pairing of the device was unsuccessful or the registration has been replaced. Try re-pairing the device. (⇒ 28)
- This unit might be connected to a different device. Disconnect the other device and try re-pairing the device.

### **The device is connected, but audio cannot be heard through this unit.**

- For some built-in Bluetooth® devices, you have to set the audio output to “SU-C550” manually. Read the operating instructions for the device for details.

### **The sound is interrupted.**

- The device is out of the 10 m communication range. Bring the Bluetooth® device closer to this system.
- Remove any obstacle between this system and the device.
- Other devices that use the 2.4 GHz frequency band (wireless router, microwaves, cordless phones, etc.) are interfering. Bring the Bluetooth® device closer to this system and distance it from the other devices.
- Select “Mode1” for stable communication. (⇒ 29)

## PC

### The PC does not recognise this unit.

- Check your operating environment. (⇒ 31)
- Restart the PC, turn this unit to standby and on, and then reconnect the USB cable.
- Use another USB port of the connected PC.
- Install the dedicated USB driver if using a PC with Windows.

## Network

### Cannot connect to the network.

- Confirm the network connection and settings. (⇒ 18)
- If the network is set to be invisible, make the network visible while you set up the network for this unit or make a wired LAN connection.
- This system's Wi-Fi security supports WPA2™. Your wireless router must therefore be WPA2™ compatible. For details on the security supported by your router and how to change the settings, please refer to the operating instructions or contact your internet service provider.
- Make sure that the multicast function on the wireless router is enabled.
- Depending on the router, WPS button may not work. Try another connection method. (⇒ 18)
- The wireless LAN environment or radio interference in your area may cause connection problem. In this case, try another connection method. If the problem persists, make a wired LAN connection. (⇒ 18)
- While the AC mains lead is disconnected, the LAN cable must be connected or disconnected.

### Cannot select this system as the output speakers.

- Make sure that the devices are connected to the same network as this system.
- Reconnect the devices to the network.
- Turn the wireless router off and then on.
- Turn this unit to standby and on, and then select this system as the output speakers again.

### Playback does not start.

### The sound is interrupted.

- Try to place the speakers further away from this unit.
- If using the 2.4 GHz band on the wireless router, simultaneous use with other 2.4 GHz devices, such as microwaves, cordless telephones, etc., may result in connection interruptions. Increase the distance between this unit and these devices.
  - If your wireless router supports 5 GHz band, try using the 5 GHz band.  
To change to the 5 GHz band, redo the network settings using an internet browser (⇒ 22). On the step 5, make sure to select your network name (SSID) for the 5 GHz band.
- Do not place this system inside a metal cabinet, for it might block the Wi-Fi signal.
- If the playback stops, check the playback status on the device.
- Place this system closer to the wireless router.
- Check the Wi-Fi signal strength using "Signal Level" and adjust location of this unit and the wireless router. (⇒ 39)
- If several wireless devices are simultaneously using the same wireless network as this unit, try turning off the other devices or reducing their wireless network usage.
- Reconnect the devices to the network.
- Turn the wireless router off and then on.
- With some iOS and iTunes versions, it may not be possible to restart the AirPlay playback if the selector is changed (e.g. "CD") or this unit is in standby mode, during the AirPlay playback. In this case, select a different device from the AirPlay icon of the Music App or iTunes and then re-select this system as the output speakers. (⇒ 36)
- If the above solutions do not solve the problem, make a wired LAN connection for all connected DLNA compatible devices which have LAN terminal (this unit, Network Attached Storage, DLNA server, etc.). (⇒ 18)

### The DLNA server and its contents are not displayed.

- The connected DLNA server and its contents may not be displayed properly depending on its condition (e.g. soon after adding the contents to the server, etc.). Try again later. For details, refer to the operating instructions of the DLNA server.

### Cannot find music files stored on the PC.

- When you play back music files over a network, those that are not registered to its network server are not displayed. For details, refer to the operating instructions for your server.

## vTuner/Spotify

### **Playback does not start.**

#### **The sound is interrupted.**

- The station that does not broadcast cannot be played back. (It will be skipped or return to the list.)
- Internet Radio may not be played back properly depending on the network condition.
- Depending on the internet connection environment, the sound may be interrupted or it may take some time to play back.
- Internet Radio is an audio broadcasting service transmitted via the Internet. Depending on the broadcaster or condition of the transmitting, the sound quality may vary.

#### **Cannot display the information properly.**

- Track names, station names, etc. which are managed by vTuner/Spotify may not be displayed properly.

## Remote control

### **The remote control does not work properly.**

- The batteries are depleted or inserted incorrectly. (⇒ 14)
- To avoid interference, please do not put any objects in front of signal sensor. (⇒ 12)
- Change the remote control code if other products react to this remote control. (⇒ 15)

## Messages



- The selected file cannot be played back.
- Select the playable file.
  - About supported format, refer to “File format” (⇒ 53)

### **AUTO OFF**

- The unit has been left unused for about 20 minutes and will shut down within a minute. Press any button to cancel it.

### **Checking Device**

- The unit is checking the connected iPhone/iPad/iPod or a USB device. After this display has disappeared, start operating.

### **Connect to Network**

- Connect this unit to the network and then wait for the start of the Firmware Update via Internet. (⇒ 40)

### **Connect USB Device**

- Download the latest firmware on the USB flash memory and connect it. (⇒ 40)

### **Download Fail**

- The firmware download has failed. Press any button to exit. Please try again later.
- The server cannot be found. Press any button to exit. Make sure that the network is connected to the internet.

### **Empty**

- The selected folder is empty. Move tracks into the folder and retry the operation.
- The server is not found on the network. Check to see if the server is connected to the same network as this unit, and retry the connection to this unit. (⇒ 18)
- No Internet Radio station is registered to the favourite list. Add a station to the list. (⇒ 34)

### **Error**

- Incorrect operation is performed. Read the instructions and try again.

### **Fail**

- Network connection is not complete. Try the setting again. (⇒ 18)

### **Firmware update is available**

- The firmware (free of charge) for this unit is available.
  - ① Press [OK].
  - ② Press [▲], [▼] to select “Yes” and then press [OK].
    - The progress is displayed as “Updating □ %” while updating. (□ stands for a number.)
    - Do not disconnect the AC mains lead or turn this unit to standby while updating. (⇒ 40)
    - When the update has finished successfully, “Success” is displayed.
  - ③ Disconnect the AC mains lead and reconnect it after 3 minutes.
- For the update information, refer to the following website.  
[www.technics.com/support/firmware/](http://www.technics.com/support/firmware/)

## “F□□” (“□” stands for a number.)

- There is a problem with this unit.
  - Is the volume extremely high?  
If so, lower the volume.
  - Is this unit placed in an extremely hot place?  
If so, move this unit to a cooler place and wait a few moments and then try to turn it on again.

If the problem persists, write down the displayed number, disconnect the AC mains lead and consult your dealer.

## Load Fail

- The firmware on the USB flash memory cannot be found.
- Download the latest firmware on the USB flash memory and try again. (⇒ 40)

## No Device

- No USB device is connected.
- Connect the USB device to be played. (⇒ 26)

## No Disc

- No CD is inserted.
- Insert the disc to be played (⇒ 24).

## No Network Available

- This unit is not connected to the network.
- Check the network connection. (⇒ 18)

## No Play

- The disc cannot be played back.
- Insert the disc to be played (⇒ 47).

## Not Measured

- Measuring the output signal has not been done yet.
- Measure the output signal. (⇒ 41)

## Not Valid

- The function you have tried to use is not available with the current settings. Check the steps and settings.

## PGM Full

- The number of programmed tracks is more than 24.

## Please Wait

- This is displayed, for example, when this unit is turned to standby/on. (For up to approx. 1 minute and 30 seconds)

## Reading

- The unit is checking the CD information. After this display has disappeared, start operating.

## “Remote □” (“□” stands for a number.)

- The remote control and this unit are using different codes.  
Change the code on the remote control. (⇒ 15)

## Remote Mode

- Basic playback control buttons on the touch panel/remote control are not available. (While playing back music stored on the DLNA server with this unit (DMR), etc.)
- Use the connected device for basic playback control.

## Searching

- The unit is checking the DLNA server on the network.

## Unlocked

- “PC” is selected, but a PC is not connected. Check the connection with the PC. (⇒ 31)
- The sampling frequency components, etc. of the audio signals are not input correctly.
  - About supported format, refer to “File format” (⇒ 53)

## USB Over Current Error

- The iPhone/iPad/iPod or USB device is drawing too much power. Disconnect the iPhone/iPad/iPod or USB device and turn the unit to standby and on again.

## Wi-Fi Setup

- Select “On” and press [OK] to enter the network setting. (⇒ 19)
  - To exit the network setting, select “Off” and press [OK].

## Hub Device Not Supported/Not Supported/Device Not Recognized/USB Device Not Supported

- You have connected an iPhone/iPad/iPod or USB device that is not supported.
  - If the iPhone/iPad/iPod is compatible, turn it on and connect it correctly.
- The format of the file on the iPhone/iPad/iPod or USB device is not supported.
  - About supported format, refer to “File format” (⇒ 53)

## Notes on CDs

### ■ Compatible CD

- A disc with the CD Logo. 
- This unit can play back discs that conform to the CD-DA format.
- The unit may not be able to play some discs due to the condition of the recording.
- Before playback, finalise the disc on the device it was recorded on.

### ■ CDs that cannot be used

- CDs with irregular shapes, such as heart shapes (Use of such CDs may cause malfunction.)

### ■ CDs that are not guaranteed to operate with this unit

- Discs with illegally copied data and those that do not conform to industry standards
- DualDiscs (Discs that record data such as music and images on both sides)

### ■ Disc formats supported by this unit

Commercially available CDs (CD-DA)	DO
CD-R/CD-RW(CD-DA)	DO
CD-R/CD-RW(MP3)	DO NOT
CD-R/CD-RW(WMA)	DO NOT

### ■ This unit's lens

Use the lens cleaner (not supplied) to clean the unit's lens.

### ■ Clean discs

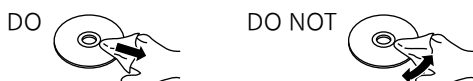

Wipe with a damp cloth and then wipe dry with a dry cloth.

### ■ Disc handling precautions

- Handle discs by the edges to avoid inadvertent scratches or fingerprints on the disc.
- Do not attach labels or stickers to discs.
- Do not use disc cleaning sprays, benzene, thinner, static electricity prevention liquids or any other solvent.
- Do not use the following discs:
  - Discs with exposed adhesive from removed stickers or labels (rented discs, etc.).
  - Discs that are badly warped or cracked.
  - Irregularly shaped discs, such as heart shapes.

## USB

- This unit does not guarantee connection with all USB devices.
- FAT16 and FAT32 file systems are supported.
- This unit supports USB 2.0 high speed.
- USB devices may not be recognised by this unit when connected using the following:
  - a USB hub
  - a USB extension cable
- It is not possible to use USB card reader/writers.
- This unit cannot record music to a USB device.
- Not all files on the USB device may be read if there are some files not supported.
- About supported format, refer to "File format" (⇒ 53)

## iPhone/iPad/iPod

- Please be aware that Panasonic accepts no responsibility for the loss of data and/or information.
- Compatible iPhone/iPad/iPod (as of June 2015)
  - iPhone 6 Plus / iPhone 6 / iPhone 5s / iPhone 5c / iPhone 5 / iPhone 4s / iPad Air 2 / iPad Air / iPad (3rd and 4th generation) / iPad 2 / iPad mini 3 / iPad mini 2 / iPad mini / iPod touch (5th generation) / iPod nano (7th generation)

### Note

- Do not connect the following models to the port:
  - iPod classic, iPod [4th (colour display), and 5th (video) generation], iPod nano (1st generation)
 Unexpected behaviour may occur.

# About Bluetooth®

**Panasonic bears no responsibility for data and/or information that is compromised during a wireless transmission.**

### Frequency band used

- This system uses the 2.4 GHz frequency band.

### Certification of this device

- This system conforms to frequency restrictions and has received certification based on frequency laws. Thus, a wireless permit is not necessary.
- The actions below are punishable by law in some countries:
  - Taking apart or modifying the system.
  - Removing specification indications.

### Restrictions of use

- Wireless transmission and/or usage with all Bluetooth® equipped devices is not guaranteed.
- All devices must conform to standards set by Bluetooth SIG, Inc.
- Depending on the specifications and settings of a device, it can fail to connect or some operations can be different.
- This system supports Bluetooth® security features. But depending on the operating environment and/or settings, this security is possibly not sufficient. Transmit data wirelessly to this system with caution.
- This system cannot transmit data to a Bluetooth® device.

### Range of use

- Use this device at a maximum range of 10 m. The range can decrease depending on the environment, obstacles or interference.

### Interference from other devices

- This system may not function properly and troubles such as noise and sound jumps may arise due to radio wave interference if this system is located too close to other Bluetooth® devices or the devices that use the 2.4 GHz band.
- This system may not function properly if radio waves from a nearby broadcasting station, etc. is too strong.

### Intended usage

- This system is for normal, general use only.
- Do not use this system near an equipment or in an environment that is sensitive to radio frequency interference (example: airports, hospitals, laboratories, etc.).





The Wi-Fi CERTIFIED™ Logo is a certification mark of Wi-Fi Alliance®.

The Wi-Fi Protected Setup™ Identifier mark is a certification mark of Wi-Fi Alliance®.

“Wi-Fi®” is a registered trademark of Wi-Fi Alliance®.

“Wi-Fi Protected Setup™”, “WPA™”, and “WPA2™” are trademarks of Wi-Fi Alliance®.



“Made for iPod”, “Made for iPhone”, and “Made for iPad” mean that an electronic accessory has been designed to connect specifically to iPod, iPhone, or iPad, respectively, and has been certified by the developer to meet Apple performance standards.

Apple is not responsible for the operation of this device or its compliance with safety and regulatory standards.

Please note that the use of this accessory with iPod, iPhone, or iPad may affect wireless performance.

AirPlay, iPad, iPhone, iPod, iPod nano, and iPod touch are trademarks of Apple Inc., registered in the U.S. and other countries. iPad Air and iPad mini are trademarks of Apple Inc.

Google Play and Android are trademarks of Google Inc.

Windows is a trademark or a registered trademark of Microsoft Corporation in the United States and other countries.

Mac and OS X are trademarks of Apple Inc., registered in the U.S. and other countries.

The Bluetooth® word mark and logos are registered trademarks owned by Bluetooth SIG, Inc. and any use of such marks by Panasonic Corporation is under license. Other trademarks and trade names are those of their respective owners.

DLNA, the DLNA Logo and DLNA CERTIFIED are trademarks, service marks, or certification marks of the Digital Living Network Alliance.

MPEG Layer-3 audio coding technology licensed from Fraunhofer IIS and Thomson.

Windows Media and the Windows logo are trademarks or registered trademarks of Microsoft Corporation in the United States and/or other countries. This product is protected by certain intellectual property rights of Microsoft Corporation and third parties. Use or distribution of such technology outside of this product is prohibited without a license from Microsoft or an authorized Microsoft subsidiary and third parties.

FLAC Decoder

Copyright (C) 2000, 2001, 2002, 2003, 2004, 2005, 2006, 2007, 2008, 2009 Josh Coalson

Redistribution and use in source and binary forms, with or without modification, are permitted provided that the following conditions are met:

- Redistributions of source code must retain the above copyright notice, this list of conditions and the following disclaimer.
- Redistributions in binary form must reproduce the above copyright notice, this list of conditions and the following disclaimer in the documentation and/or other materials provided with the distribution.
- Neither the name of the Xiph.org Foundation nor the names of its contributors may be used to endorse or promote products derived from this software without specific prior written permission.

THIS SOFTWARE IS PROVIDED BY THE COPYRIGHT HOLDERS AND CONTRIBUTORS “AS IS” AND ANY EXPRESS OR IMPLIED WARRANTIES, INCLUDING, BUT NOT LIMITED TO, THE IMPLIED WARRANTIES OF MERCHANTABILITY AND FITNESS FOR A PARTICULAR PURPOSE ARE DISCLAIMED. IN NO EVENT SHALL THE FOUNDATION OR CONTRIBUTORS BE LIABLE FOR ANY DIRECT, INDIRECT, INCIDENTAL, SPECIAL, EXEMPLARY, OR CONSEQUENTIAL DAMAGES (INCLUDING, BUT NOT LIMITED TO, PROCUREMENT OF SUBSTITUTE GOODS OR SERVICES; LOSS OF USE, DATA, OR PROFITS; OR BUSINESS INTERRUPTION) HOWEVER CAUSED AND ON ANY THEORY OF LIABILITY, WHETHER IN CONTRACT, STRICT LIABILITY, OR TORT (INCLUDING NEGLIGENCE OR OTHERWISE) ARISING IN ANY WAY OUT OF THE USE OF THIS SOFTWARE, EVEN IF ADVISED OF THE POSSIBILITY OF SUCH DAMAGE.

The Spotify software is subject to third party licenses found here:  
[www.spotify.com/connect/third-party-licenses](http://www.spotify.com/connect/third-party-licenses)

# Specifications

## ■ GENERAL

Power supply	AC 220 V to 240 V, 50/60 Hz
Power consumption	50 W
Power consumption in standby mode (Network Standby Off)*	Approx. 0.3 W
Power consumption in standby mode (Network Standby On)*	Approx. 2.6 W
Dimensions (main unit) (W×H×D)	360 mm × 91 mm × 258 mm
Mass (main unit)	Approx. 3.9 kg
Operating temperature range	0 °C to 40 °C
Operating humidity range	35 % to 80 % RH (no condensation)

\*: At the time of iPod/iPhone/iPad non-charging.

## ■ AMPLIFIER SECTION

Output power	20 W + 20 W (1 kHz, T.H.D. 0.5 %, 8 Ω, 20 kHz LPF) 40 W + 40 W (1 kHz, T.H.D. 0.5 %, 4 Ω, 20 kHz LPF)
Load impedance	4 Ω – 16 Ω
Frequency Response	20 Hz - 90 kHz (-3 dB, 8 Ω)

## ■ DISC SECTION

Playable Disc (8 cm or 12 cm)	CD, CD-R, CD-RW
Pickup	
Wavelength	790 nm (CD)
Laser power	CLASS 1
Format	CD-DA

## ■ Bluetooth® SECTION

Bluetooth® system specification	Bluetooth® Ver.2.1+EDR
Wireless equipment classification	Class 2 (2.5 mW)
Supported profiles	A2DP, AVRCP
Supported codec	AAC, SBC
Frequency band	2.4 GHz band FH-SS
Operating distance	Approx. 10 m Line of sight*

\*: Prospective communication distance  
 Measurement environment:  
 Temperature 25 °C/ Height 1.0 m  
 Measure in "Mode1"

## ■ TERMINALS SECTION

Headphones Jack	Stereo, $\phi$ 3.5 mm
USB	FRONT USB Type A Connector
Support Memory Capacity	2 TB (max)
Maximum number of folders (albums)	800
Maximum number of files (songs)	8000
File system	FAT16, FAT32
USB port power	DC OUT 5 V 2.1 A (max)
PC	REAR USB Type B Connector
Ethernet interface	LAN (100BASE-TX/10BASE-T)
Digital Input	Optical digital input (Optical terminal)
Format support	LPCM

Specifications (Continued)

■ **FORMAT SECTION**

**USB-A**

USB Standard	USB 2.0 high-speed USB Mass Storage class
--------------	--

**USB-B**

USB Standard	USB 2.0 high-speed USB Audio Class 2.0, Asynchronous mode
--------------	---

DSD control mode	ASIO Native mode, DoP mode
------------------	-------------------------------

■ **Wi-Fi SECTION**

WLAN Standard	IEEE802.11a / b / g / n
Frequency Band	2.4 GHz band (1 - 13 ch) / 5 GHz band (36, 40, 44, 48 ch)
Security	WPA2™, Mixed mode WPA2™/WPA™
Encryption Type	TKIP / AES
Authentication type	PSK WEP (64 bit/128 bit)
WPS version	Version 2.0

## ■ File format

This unit supports the following file formats.

- This unit does not support the playback of copy-protected music files.
- Playback of all files in formats supported by this unit is not guaranteed.
- Playback of a file in a format not supported by this unit may cause choppy audio or noise. In such cases, check to see if this unit supports the file format.
- This unit does not support VBR (Variable Bit Rate) playback.
- Some of the connected devices (servers) may be capable of converting files in formats not supported by this unit and output them. For details, refer to the operating instructions for your server.
- File information (sampling frequency, etc.) shown by this unit and playback software may differ from each other.

## USB-A

File format	Extension	Sampling frequency	Bit rate / Number of quantisation bits
MP3	.mp3	32/44.1/48 kHz	16 to 320 kbps
AAC	.m4a/.aac	32/44.1/48/88.2/96 kHz	16 to 320 kbps
WMA	.wma	32/44.1/48 kHz	16 to 320 kbps
WAV	.wav	32/44.1/48/88.2/96/176.4/192 kHz	16/24 bit
FLAC	.flac	32/44.1/48/88.2/96/176.4/192 kHz	16/24 bit
AIFF	.aiff	32/44.1/48/88.2/96/176.4/192 kHz	16/24 bit
ALAC	.m4a	32/44.1/48/88.2/96/176.4/192 kHz	16/24 bit
DSD	.dff/.dsf	2.8224 MHz/5.6448 MHz	

## Specifications (Continued)

**PC (USB-B)\*1**

File format	Extension	Sampling frequency	Bit rate / Number of quantisation bits
LPCM		32/44.1/48/88.2/96/176.4/192 kHz	16/24/32 bit
DSD	.dff/.dsf	2.8224 MHz/5.6448 MHz	

**LAN (DLNA)\*2**

File format	Extension	Sampling frequency	Bit rate / Number of quantisation bits
MP3	.mp3	32/44.1/48 kHz	16 to 320 kbps
AAC	.m4a/.aac	32/44.1/48/88.2/96 kHz	16 to 320 kbps
WMA	.wma	32/44.1/48 kHz	16 to 320 kbps
WAV	.wav	32/44.1/48/88.2/96/176.4/192 kHz	16/24 bit
FLAC	.flac	32/44.1/48/88.2/96/176.4/192 kHz	16/24 bit
AIFF	.aiff	32/44.1/48/88.2/96/176.4/192 kHz	16/24 bit
ALAC	.m4a	32/44.1/48/88.2/96/176.4/192 kHz	16/24 bit
DSD	.dff/.dsf	2.8224 MHz/5.6448 MHz	

\*1: If you download and install the dedicated app, you can play back files in wide-ranging formats. (⇒ 31)  
For details, refer to the operating instructions of the app.

\*2: Whether or not each music file can be played back over your network is determined by the network server even if the format of the file is listed above. For example, if you are using Windows Media Player 11, not all music files on the PC are playable. You can play back only those added to the library of Windows Media Player 11.

**Note**

- Specifications are subject to change without notice.
- Mass and dimensions are approximate.



Headquarter Address:  
Panasonic Corporation  
Kadoma, Osaka, Japan

Importer for Europe:  
Panasonic Marketing Europe GmbH  
Panasonic Testing Centre  
Winsbergring 11, 22525 Hamburg, Germany

EU



---

**Panasonic Corporation**

Web Site: <http://www.panasonic.com>

