

**Customer's Record**

The model number and serial number of this product can be found on its back cover. You should note this serial number in the space provided below and retain this book, plus your purchase receipt, as a permanent record of your purchase to aid in identification in the event of theft or loss, and for Warranty Service purposes.

Model Number \_\_\_\_\_

Serial Number \_\_\_\_\_

---

**Panasonic Corporation**Web Site: <http://panasonic.net/>

# Panasonic<sup>®</sup>

Model No.

**TC-42PX34X**  
**TC-50PX34X**

## Owner's Manual

42"/50" Class 720p Plasma HDTV

(41.6/49.9 inches measured diagonally)

# VIERA



**English**

Thank you for purchasing this Panasonic product.  
Please read these instructions before operating your set and retain them for future reference. The images shown in this manual are for illustrative purposes only.



TQB2AC0035

# Experience an amazing level of multimedia excitement

## Enjoy rich multimedia

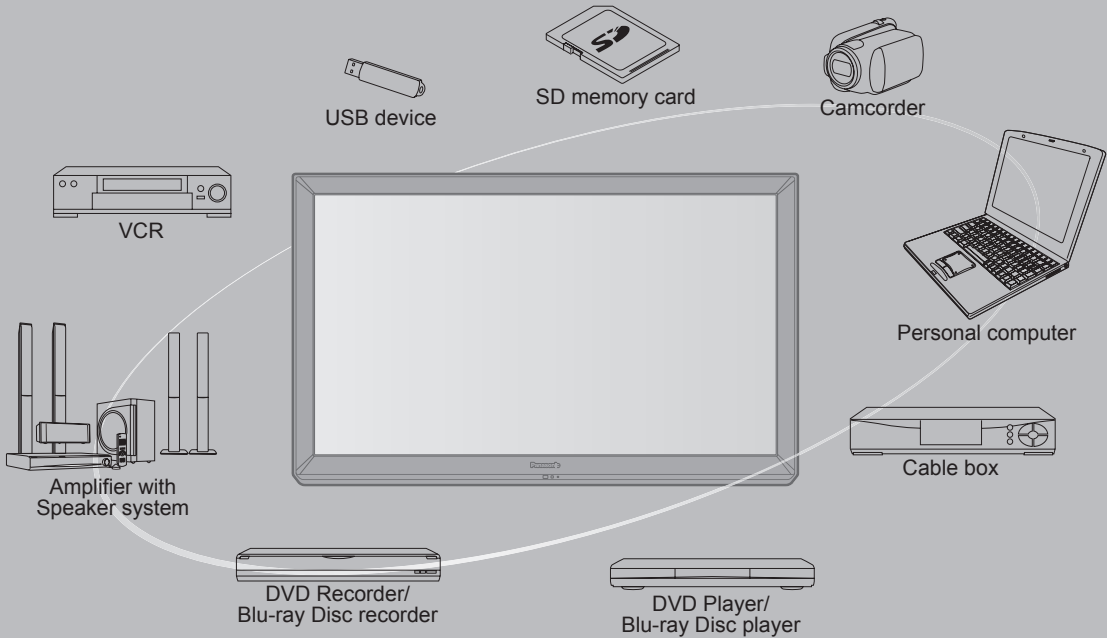

### ■ Do not display a still picture for a long time

This causes the image to remain on the plasma screen ("Image retention"). This is not considered a malfunction and is not covered by the warranty.



To prevent the "Image retention", the screen saver is automatically activated after a few minutes if no signals are sent or no operations are performed.

### Typical still images

- Channel number and other logos
- Image displayed in 4:3 mode
- SD Card photo
- Video game
- Computer image

### ■ Set up

- Do not place the unit where it's exposed to sunlight or other bright light (including reflections).
- Use of some types of fluorescent lighting may reduce the remote control's transmission range.

**VIERA Link™** VIERA Link™ is a trademark of Panasonic Corporation.

**HDMI** HDMI, the HDMI logo and High-Definition Multimedia Interface are trademarks or registered trademarks of HDMI Licensing LLC in the United States and other countries.

**SDXC** SDXC Logo is a trademark of SD-3C, LLC.

**AVCHD™** “AVCHD” and the “AVCHD” logo are trademarks of Panasonic Corporation and Sony Corporation.

**DLNA CERTIFIED** DLNA®, the DLNA Logo and DLNA CERTIFIED™ are trademarks, service marks, or certification marks of the Digital Living Network Alliance.

Manufactured under license from Dolby Laboratories. Dolby and the double-D symbol are trademarks of Dolby Laboratories.

HDAVI Control™ is a trademark of Panasonic Corporation.



This product is licensed under the AVC patent portfolio license for the personal and non-commercial use of a consumer to (i) encode video in compliance with the AVC Standard (“AVC Video”) and/or (ii) decode AVC Video that was encoded by a consumer engaged in a personal and non-commercial activity and/or was obtained from a video provider licensed to provide AVC Video. No license is granted or shall be implied for any other use. Additional information may be obtained from MPEG LA, LLC. See <http://www.mpegla.com>.

# Contents

## Please read before using the unit

- Safety Precautions..... 4

## Getting started

- Accessories/Optional Accessory..... 7
- Connections..... 10
- Identifying Controls..... 12
- First Time Setup..... 13

## Basic Features

- Watching TV ..... 17
- Using VIERA TOOLS..... 20
- Watching content from external devices..... 21
- Using Media player..... 22

## Advanced Features

- VIERA Link™ “HDAVI Control™”..... 28
- Using Network services ..... 34
  - Network Connections..... 35
  - Network settings ..... 36
  - Using EASY IPTV ..... 39
  - Using DLNA feature ..... 40
  - Network Camera..... 41
- Editing and Setting Channels ..... 42
- How to Use Menu Functions..... 44
  - Picture settings ..... 45
  - Audio settings ..... 46
  - Timer settings ..... 46
  - Lock ..... 47
  - Closed caption ..... 47
  - Setup ..... 48

## Support Information

- Ratings List for parental control ..... 49
- Technical Information ..... 50
- Frequently Asked Questions (FAQ) ..... 54
- Care and Cleaning..... 56
- Specifications..... 57
- Index..... 58

Getting started



Basic

Advanced

Support Information



# Safety Precautions

	<b>CAUTION</b> <b>RISK OF ELECTRIC SHOCK</b> <b>DO NOT OPEN</b>	
<b>WARNING:</b> To reduce the risk of electric shock, do not remove cover or back. No user-serviceable parts inside. Refer servicing to qualified service personnel.		



The lightning flash with arrowhead within a triangle is intended to tell the user that parts inside the product are a risk of electric shock to persons.



The exclamation point within a triangle is intended to tell the user that important operating and servicing instructions are in the papers with the appliance.

**WARNING:** To reduce the risk of fire or electric shock, do not expose this apparatus to rain or moisture. Do not place liquid containers (flower vase, cups, cosmetics, etc.) above the set (including on shelves above, etc.).

## Important Safety Instructions

- 1) Read these instructions.
- 2) Keep these instructions.
- 3) Heed all warnings.
- 4) Follow all instructions.
- 5) Do not use this apparatus near water.
- 6) Clean only with dry cloth.
- 7) Do not block any ventilation openings. Install in accordance with the manufacturer's instructions.
- 8) Do not install near any heat sources such as radiators, heat registers, stoves, or other apparatus (including amplifiers) that produce heat.
- 9) Do not defeat the safety purpose of the polarized or grounding-type plug. A polarized plug has two blades with one wider than the other. A grounding type plug has two blades and a third grounding prong. The wide blade or the third prong are provided for your safety. If the provided plug does not fit into your outlet, consult an electrician for replacement of the obsolete outlet.
- 10) Protect the power cord from being walked on or pinched particularly at plugs, convenience receptacles, and the point where they exit from the apparatus.
- 11) Only use attachments / accessories specified by the manufacturer.
- 12) Use only with the cart, stand, tripod, bracket, or table specified by the manufacturer, or sold with the apparatus. When a cart is used, use caution when moving the cart / apparatus combination to avoid injury from tip-over.
- 13) Unplug this apparatus during lightning storms or when unused for long periods of time.
- 14) Refer all servicing to qualified service personnel. Servicing is required when the apparatus has been damaged in any way, such as power-supply cord or plug is damaged, liquid has been spilled or objects have fallen into the apparatus, the apparatus has been exposed to rain or moisture, does not operate normally, or has been dropped.
- 15) To prevent electric shock, ensure the grounding pin on the AC cord power plug is securely connected.



## WARNING/CAUTION (TV set)

### **WARNING**

**Small parts can present choking hazard if accidentally swallowed.**  
**Keep small parts away from young children.**  
**Discard unneeded small parts and other objects, including packaging materials and plastic bags/sheets to prevent them from being played with by young children, creating the potential risk of suffocation.**

#### ■ Set up

- This Plasma TV may fall and can cause personal injury or even death if not installed correctly. To prevent personal injury or death, follow these warnings:
- **Install the Plasma TV in accordance with the manufacturer's recommended pedestal or stand, corresponding hardware and installation instructions.** This Plasma TV is for use only with the following optional accessories. Use with any other type of optional accessories may cause instability. The following accessories are manufactured by Panasonic Corporation.
    - Wall-hanging bracket (Angled)  
TY-WK4P1RW

- **Be sure to ask a qualified technician to carry out the installation and set-up.**  
Two or more people are required to install or remove the television.
- **Some wall mounts (wall-hanging brackets) are not designed to be mounted to walls with steel studs or old cinder block constructions.**  
Ask your dealer or licensed contractor to properly secure the wall-hanging bracket.
- **Do not route the TV's power cord inside the wall.**  
The power cord was not designed for in-wall mounting. Doing so can lead to fire hazard.
- **Do not place the Plasma TV or its stand on a sloped or unstable surface.**  
The Plasma TV may fall or tip over.
- **Do not support the Plasma TV on a non-specified pedestal.**
- **Do not place the Plasma TV on furniture that can easily be used as steps, such as a chest of drawers.**
- **Do not climb or allow children to climb on the Plasma TV**
- **Place or install the Plasma TV where it cannot be pushed, pulled over or knocked down.**
- **Route all cords and cables such that they cannot be tripped over or pulled by curious children.**

- **Do not place any objects on top of the Plasma TV.** If water spills onto the Plasma TV or foreign objects get inside it, a short-circuit may occur which could result in fire or electric shock. If any foreign objects get inside the Plasma TV, please consult an Authorized Service Center. In the unlikely event that you receive a shock from this product it is possible that your household outlet may be wired improperly. Have an electrician verify that the TV's outlet is properly wired. If the symptom persists, have the TV serviced by a qualified authorized technician.

- **To prevent the spread of fire, keep candles or other open flames away from this product at all times**



## ■ AC Power Supply Cord

To prevent fire or electric shock:

- **The Plasma TV is designed to operate on a 110-127 V AC, 60 Hz service. Insert the power cord plug as far as it will go into the wall socket.** If the plug is not fully inserted, heat may generate, which could cause a fire.
- **The included power cord is for use with this unit only.**
- **Do not use any power cord other than that provided with this TV.**
- **Do not handle the power cord plug with wet hands.**
- **Do not do anything that might damage the power supply cord.**
- **When disconnecting the power supply cord, hold the plug, not the cord.**
- **Do not use the power supply cord if the plug or cord is damaged.** Replace the cord or contact your Authorized Service Center.
- **Do not use a 3-prong to 2-prong AC plug adapters to connect your TV's plug to the wall outlet.** Doing so will defeat the TV plug's safety feature, which can lead to a shock hazard. If the wall outlet does not accommodate a 3-prong plug, have a qualified electrician replace your outlet and check the associated wiring.

## ■ Handling the power supply cord

- **Insert the power plug fully into the socket outlet. (If the power plug is loose, it could generate heat and cause fire.)**
- **Ensure that the power plug is easily accessible.**
- **Ensure the earth pin on the power plug is securely connected to prevent electrical shock.**
  - An apparatus with CLASS I construction shall be connected to a power socket outlet with a protective earthing connection.
- **Do not touch the power plug with a wet hand. (This may cause electrical shock.)**
- **Do not use any power cord other than that provided with this TV. (This may cause fire or electrical shock.)**
- **Do not damage the power cord. (A damaged cord may cause fire or electrical shock.)**
  - Do not move the TV with the cord plugged in the socket outlet.
  - Do not place a heavy object on the cord or place the cord near a high-temperature object.
  - Do not twist the cord, bend it excessively, or stretch it.
  - Do not pull on the cord. Hold onto the power plug body when disconnecting cord.
  - Do not use a damaged power plug or socket outlet.
- **If a problem occurs (such as no picture or no sound), or if smoke or an abnormal odor is detected from the Plasma TV, unplug the power supply cord immediately.** Continued use of the TV under these conditions might cause a fire or permanent damage to the TV. Have the TV evaluated by an Authorized Service Center. Servicing of the TV by unauthorized personnel is strongly discouraged due to its high voltage.

- **If water or an object gets inside the Plasma TV, if the Plasma TV is dropped, or if the enclosure becomes damaged, unplug the power supply cord immediately.** A short-circuit may occur, which could cause a fire. Contact an Authorized Service Center for an evaluation.



- **Do not cover the ventilation holes.** Doing so may cause the Plasma TV to overheat, which can cause a fire or damage to the Plasma TV.
- **Leave a space of 3 15/16" (10 cm) or more at the top, left and right, and 2 3/4" (7 cm) or more at the rear.**
- **When using the pedestal, keep the space between the bottom of the TV and the pedestal or stand surface clear from objects that may obstruct ventilation.**

## ■ When Moving the Plasma TV

- **Be sure to disconnect all cables before moving the Plasma TV.** Moving the TV with its cables attached might damage the cables which, in turn, can cause fire or electric shock.
- **To prevent an electric shock, disconnect the power plug from the wall outlet as a safety precaution before carrying out any cleaning.**
- **Transport only in upright position.** Transporting the unit with its display panel facing upright or downward may cause damage to the internal circuitry.
- **Using a dry cloth, clean any dust from the power supply cord and plug regularly.** Build-up of dust on the power cord plug can increase humidity, which might damage the insulation and cause a fire.

**This Plasma TV radiates infrared rays;**

therefore, it may affect other infrared communication equipment. Install your infrared sensor in a place away from direct or reflected light from your Plasma TV.

**The TV will still consume some power as long as the power supply cord is connected to the wall outlet.**

- **Display panel is made of glass. Do not apply strong force or impact to the display panel.** This may cause damage resulting in injury.
- **The TV is heavy. TV should be handled by 2 or more people. Support as shown to avoid injury by the TV tipping or falling.**

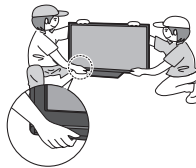

## FCC STATEMENT

This equipment has been tested and found to comply with the limits for a Class B digital device, pursuant to Part 15 of the FCC Rules. These limits are designed to provide reasonable protection against harmful interference in a residential installation. This equipment generates, uses and can radiate radio frequency energy and, if not installed and used in accordance with the instructions, may cause harmful interference to radio communications. However, there is no guarantee that interference will not occur in a particular installation. If this equipment does cause harmful interference to radio or television reception, which can be determined by turning the equipment off and on, the user is encouraged to try to correct the interference by one or more of the following measures:

- Reorient or relocate the receiving antenna.
- Increase the separation between the equipment and receiver.
- Connect the equipment into an outlet on a circuit different from that to which the receiver is connected.
- Consult the dealer or an experienced radio/TV technician for help.

This device complies with Part 15 of the FCC Rules. Operation is subject to the following two conditions: (1) This device may not cause harmful interference, and (2) this device must accept any interference received, including interference that may cause undesired operation.

### **FCC Caution:**

**To assure continued compliance, follow the attached installation instructions and use only shielded interface cables when connecting to computer or peripheral devices. Any changes or modifications not expressly approved by Panasonic Corp. of North America could void the user's authority to operate this device.**

### **FCC Declaration of Conformity Model No. TC-42PX34X, TC-50PX34X**

Responsible Party: Panasonic Corporation of North America  
One Panasonic Way, Secaucus, NJ 07094  
Contact Source: Panasonic Consumer Electronics Company  
1-877-95-VIERA (958-4372)  
email: [consumerproducts@panasonic.com](mailto:consumerproducts@panasonic.com)

# Accessories/Optional Accessory

## Accessories

Check you have all the items shown.

### Accessories

- Remote Control Transmitter
  - N2QAYB000570



- Batteries for the Remote Control Transmitter (2)
  - AA Battery



- AC cord

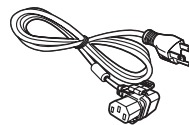

- Owner's Manual
- Warranty card (Mexico)

- Pedestal
  - TBLX0134 (42PX34X)
  - TBLX0135 (50PX34X)

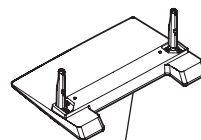

How to assemble (p. 8)

### Optional Accessory Wall-hanging bracket (angle)

- TY-WK4P1RW

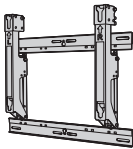

- a: 15.7" (400 mm)
- b: 11.8" (300 mm)

Please contact your nearest Panasonic dealer to purchase the recommended wall-hanging bracket. For additional details, please refer to the wall-hanging bracket installation manual.

Rear of the TV

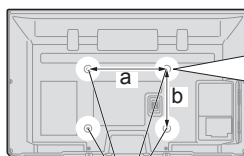

Holes for wall-hanging bracket installation

Screw for fixing the TV onto the wall-hanging bracket (not supplied with the TV)

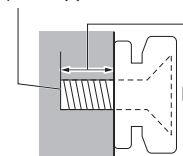

(View from the side)

Depth of screw:  
minimum 0.59" (15.0 mm),  
maximum 1.18" (30.0 mm)

M8

#### Warning

- In order to maintain the TV's performance and safety, be absolutely sure to ask your dealer or a licensed contractor to secure the wall-hanging brackets.
- Carefully read the instructions accompanying optional accessories, and be absolutely sure to take steps to prevent the TV from tipping over.
- Handle the TV carefully during installation since subjecting it to impact or other forces may cause product damage.
- Take care when fixing wall brackets to the wall. Always ensure that there are no electrical cables or pipes in the wall before hanging bracket.
- When using the angled-type wall hanging bracket, please ensure that there is sufficient space for the connecting cables not to press against the wall when the TV is tilted forward.
- For safety reasons, remove units no longer being used from their wall-mounted locations.



## Assembling the pedestal

- Fix securely with assembly screws (A) (Total 4 screws).
- Tighten screws firmly.

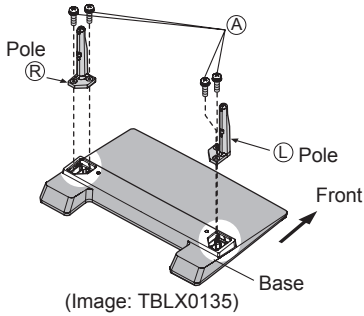

## Set-up

- Carry out work on a horizontal and level surface.
- Tighten screws firmly.

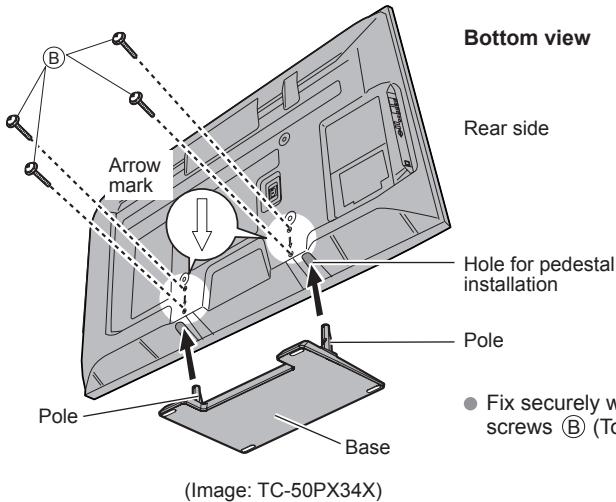

## Accessories

Assembly screws  
(4 of each)



Poles (2)

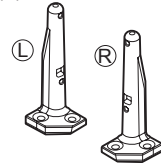

- (L) or (R) is printed at the bottom of the poles.

Base (1)

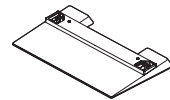

### Warning

**Do not disassemble or modify the pedestal.**

- Otherwise the TV may fall over and become damaged, and personal injury may result.

### Caution

**Do not use any pedestal other than that provided with this TV.**

- Otherwise the TV may fall over and become damaged, and personal injury may result.

**Do not use the pedestal if it becomes warped or physically damaged.**

- If you use the pedestal when it is physically damaged, personal injury may result. Contact your nearest Panasonic Dealer immediately.

**During set-up, make sure that all screws are securely tightened.**

- If sufficient care is not taken to ensure screws are properly tightened during assembly, the pedestal will not be strong enough to support the TV, and it might fall over and become damaged, and personal injury may result.

## Installing the remote's batteries

1

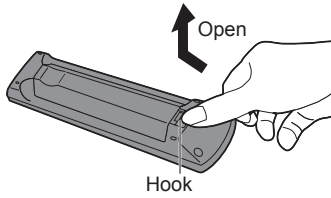

2

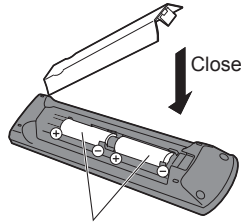

Note the correct polarity (+ or -).

### Caution

- Incorrect installation may cause battery leakage and corrosion, resulting in damage to the remote control.
- Do not mix old and new batteries.
- Do not mix different battery types (such as alkaline and manganese batteries).
- Do not use rechargeable (Ni-Cd) batteries.
- Do not burn or break batteries.

## Power cord connection

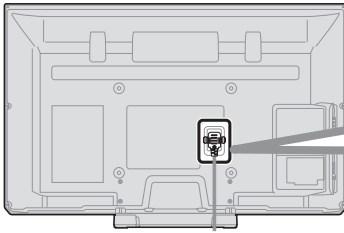

### To attach

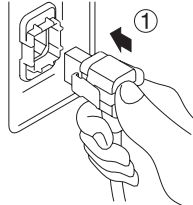

Insert it firmly until the tabs on both sides click into place.

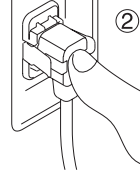

### To remove

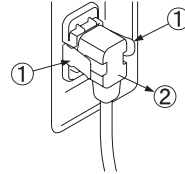

Keep pushing both sides until they snap and pull.

# Connections

## Connection Panels

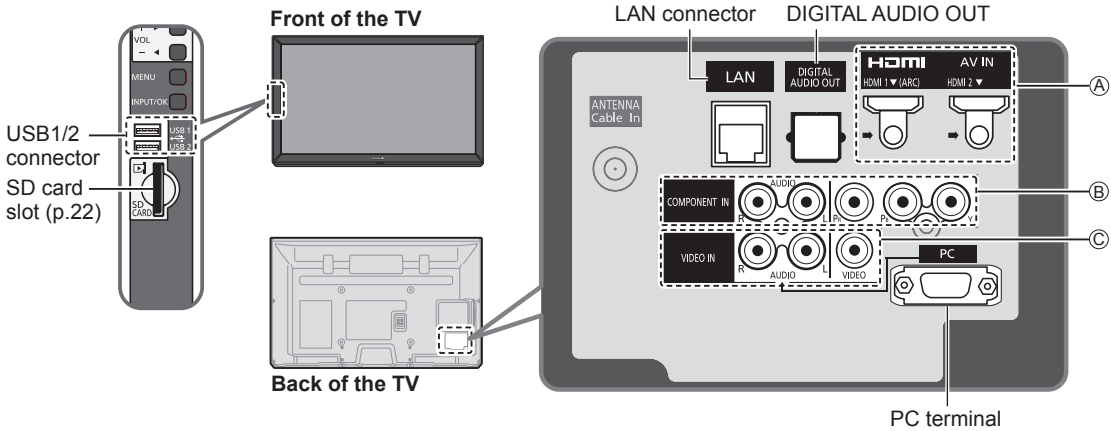

## Antenna or Cable connection

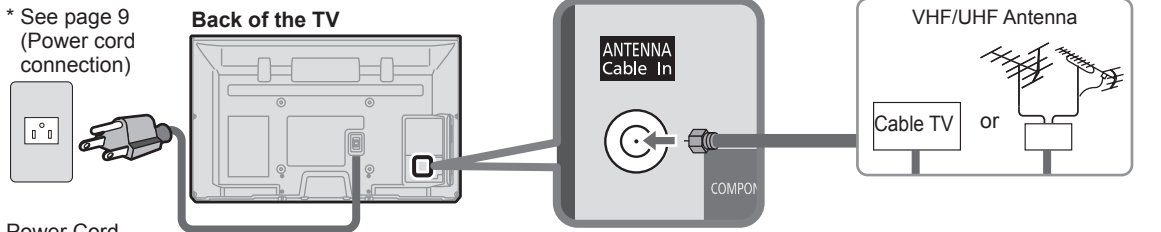

\* See page 9 (Power cord connection)

**Power Cord**  
(Connect after all the other connections have been made.)

### VHF/UHF Antenna

- NTSC (National Television System Committee):
  - ATSC (Advanced Television Systems Committee):
- Digital TV Standards include digital high-definition television (HDTV), standard-definition television (SDTV), data broadcasting, multichannel surround-sound audio and interactive television.

### Cable

- You need to subscribe to a cable TV service to enjoy viewing their programming.
  - You may need to subscribe to a high-definition (HD) cable service to enjoy HD programming.
- The connection for high-definition can be done with the use of an HDMI or Component Video cable. (p. 11)

### Note

- When using a Cable box, external equipment and video cables shown in this manual are not supplied with the TV.
- When disconnecting the power cord, be absolutely sure to disconnect the power cord plug from the wall outlet first.
- ATSC is not available except in U.S.A., Canada, and/or Mexico.

## Connection references

### ■ Antenna terminal

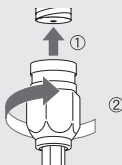

- Firmly tighten by hand.

### ■ Pin terminals

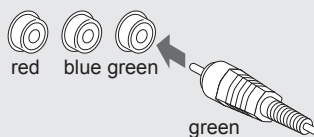

- Match colors of plugs and terminals.
- Insert firmly.

### ■ HDMI terminal

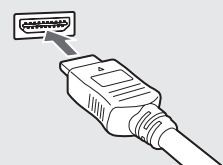

- Insert firmly.

## AV cable connection

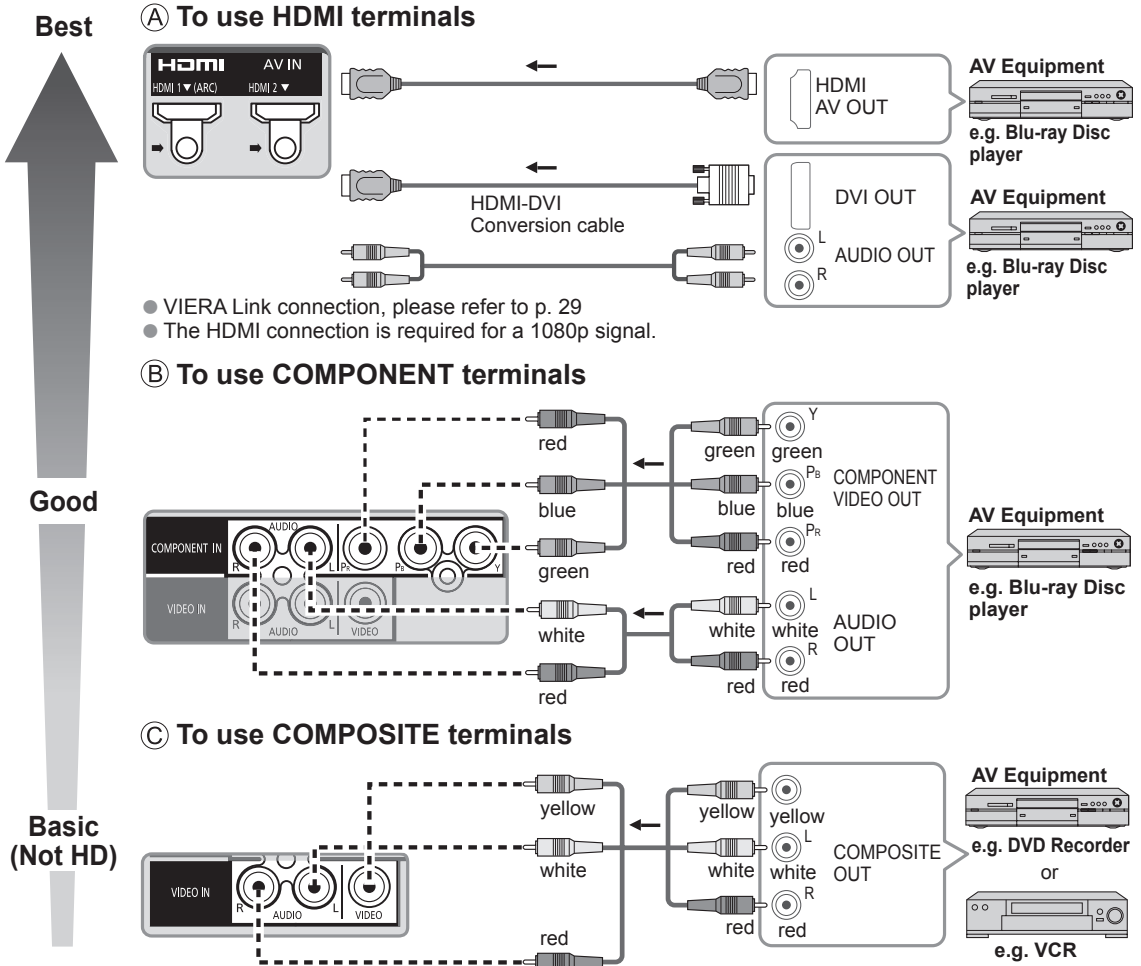

## Audio connection

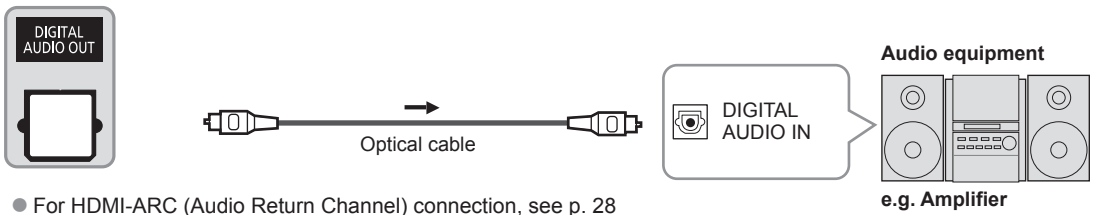

## PC / Computer connection (VGA)

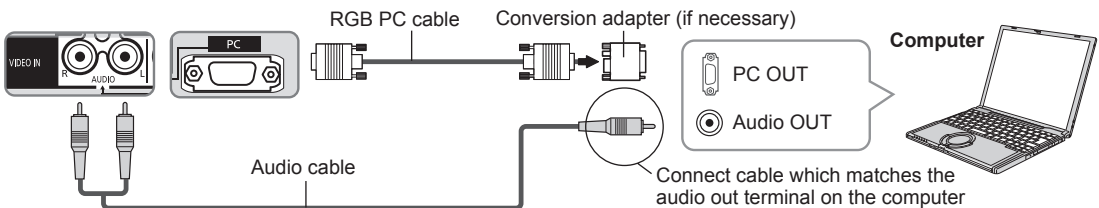

# Identifying Controls

## TV controls/indicators

### Front of the TV

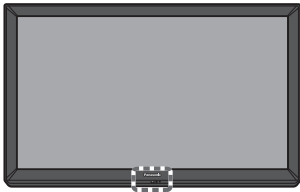

Remote control sensor  
Within about 23 feet  
(7 meters) in front of  
the TV set

Power indicator  
(on: red, off: no light)

C.A.T.S. sensor  
Plasma C.A.T.S. (Contrast Automatic  
Tracking System) (p. 45)

### Back of the TV

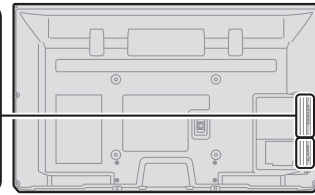

Selects channels  
in sequence

Volume up/down

Displays the Main  
Menu

Changes the input  
mode

Chooses Menu and  
Submenu entries

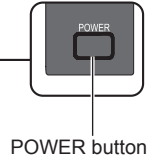

### Note

- The TV consumes a small amount of electric energy even when turned off.
- Do not place any objects between the TV remote control sensor and remote control.

## Remote control

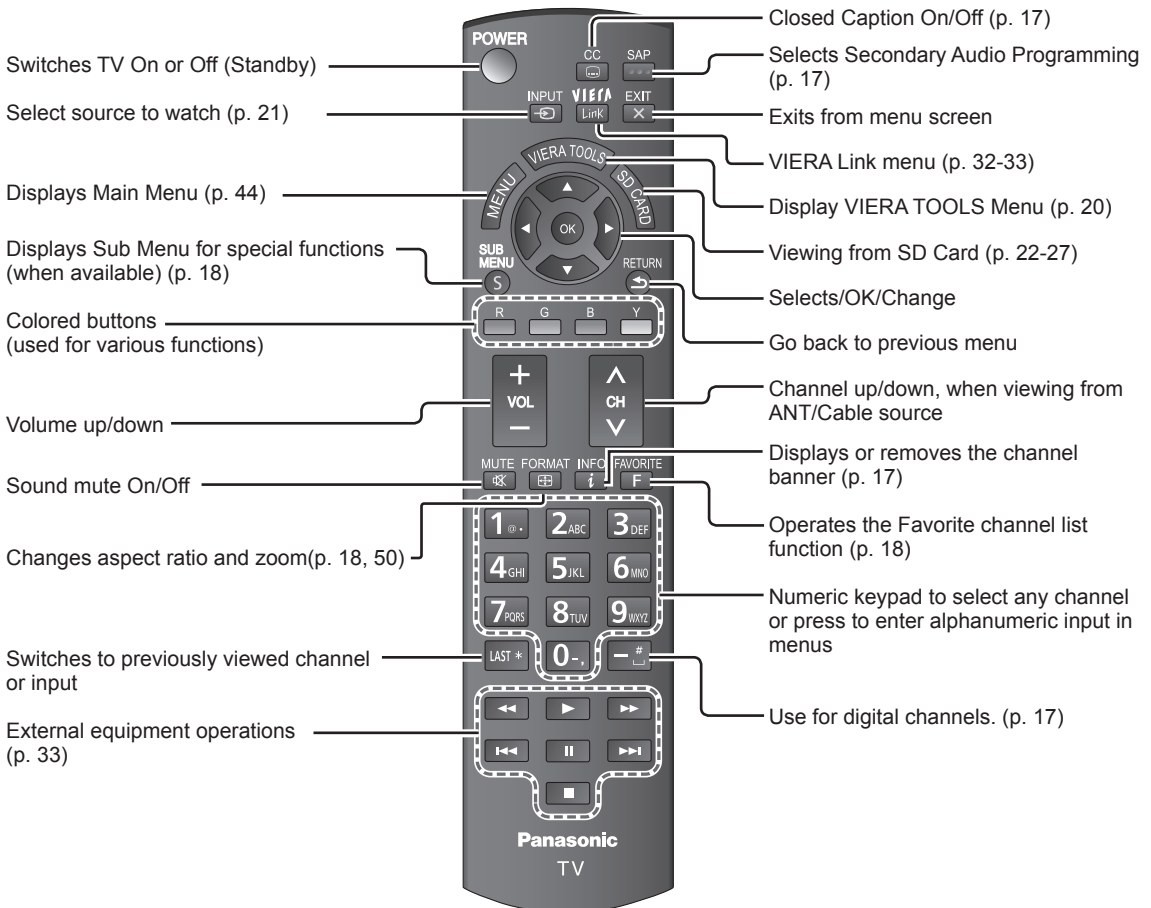

# First Time Setup

The first time setup screen is displayed only when the TV is turned on for the first time after the power cord is inserted into a wall outlet and when “Auto power on” (p. 48) is set to “No”.

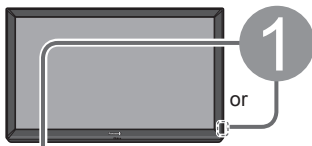

## 1 Turn the TV On with the POWER button

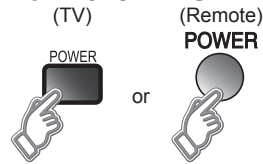

## 2 Configure your viewing mode

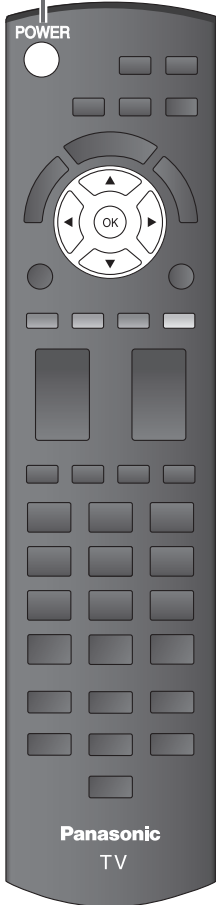

### ① Select your language

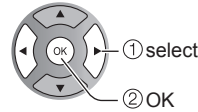
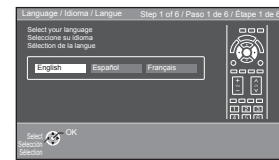

### ② Select your viewing mode (Be sure to select “Home use”)

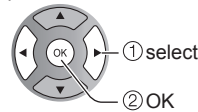
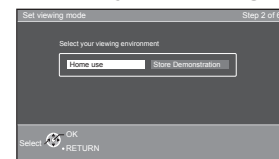

- Please confirm your selection (Home Use) before pressing the OK button.

### ■ If you select “Store Demonstration” by mistake in ②, confirmation screen will be displayed.

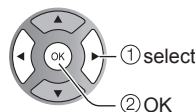
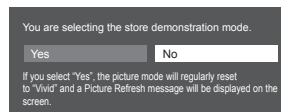

- Select “No” and return to previous screen ②.
- If you select “Yes”, Screen enters the store demonstration mode.

To display the “Set viewing mode” screen again as shown above and select “Home Use”, do one of the following:

- Press and hold down the side POWER button for at least five seconds.
- Unplug power cord for 30 seconds and plug it again.

### Note

- If you use any other step other than ② then turn the TV off, or if you used the EXIT button to quit before completing the settings, the next time you turn the TV on, “First time setup” will not be automatically displayed.
  - The settings up to that point are saved.
  - You can start “First time setup”. (p. 48)
- Language, ANT/Cable setup, Input labels, Clock can also be changed from the Settings Menu. (p. 48)



3

## ANT/Cable setup

① Do you use a Cable, Satellite or Fiber Optic box with this TV?

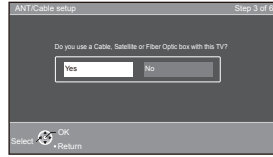

No

②a Select signal type (Cable/Antenna)

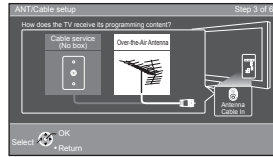

Yes

②b Select connection type for Cable or Satellite box and go to ④ (Input labels)

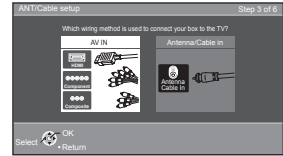
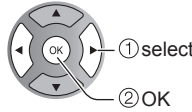

③ Select scan type

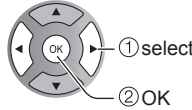
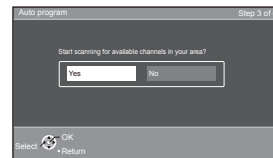

Yes

④ Start scanning

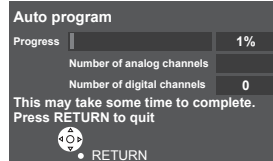

⑤ Complete scanning

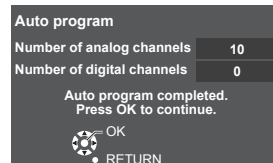

■ Press to exit from a menu screen



■ Press to go back to the previous screen



### Note

● About broadcasting systems

**Analog (NTSC):**  
Conventional broadcasting

**Digital (ATSC):**  
New programming that allows you to view more channels featuring high-quality video and sound

4

## Label the inputs for easy identification (Label inputs)

To name each input, follow the instructions on screen.

When done, select NEXT and press OK to go to the next step.

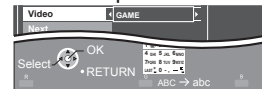
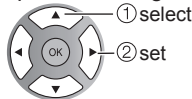
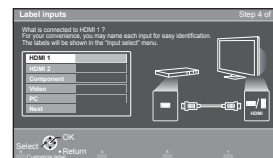

Follow the instructions on screen to complete the following operations.

R --> To edit the labels to match your connected devices.

Label: [BLANK] Blu-ray/CABLE/SATELLITE/DVD/DVD REC/DVR/GAME/HOME THTR/RECEIVER/COMPUTER/MEDIA CTR/MEDIA EXT/VCR/CAMERA/MONITOR/AUX/OTHER/Not used

- Select "Not used" for any back-panel input that has no device connected to it. Afterward, the input will be skipped when pressing INPUT, for your convenience.
- The input labels can be changed at any time from the TV's setup menu



## Configure Network settings

### ① Select the Network type

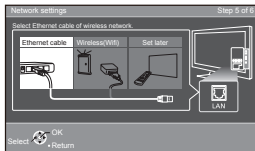

Set later: Go to ⑥  
 You can set in "Setup" menu later.  
 Wireless (WiFi): Start "Wireless network" (p. 16)

### ② Select the setting mode

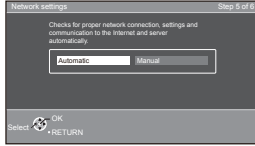

Automatic: Press OK to start setup automatically.  
 Error screen is displayed when Network connection has failed.  
 Manual: Go to Manual setting.

### Start connection test

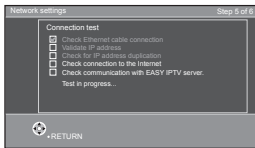

Manual

### Manual setting

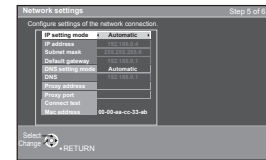

Connection test

Connection error

### ③ Complete "Network settings"

Helpful information is displayed when you successfully complete "Network settings".

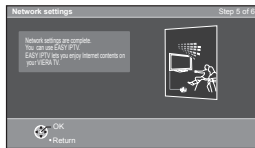

### Error screen

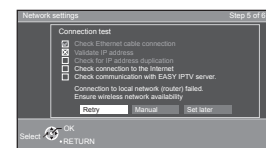

Retry: Go to "Start connection test"  
 Set later: Go to ⑥

Press to exit from a menu screen



Press to go back to the previous screen



## ⑥ Adjust the Clock (Set clock)

When done, select NEXT and press OK to go to the next step.

### Manual setting

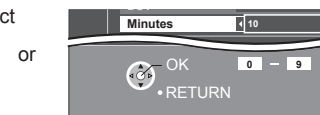
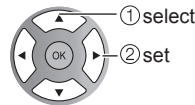
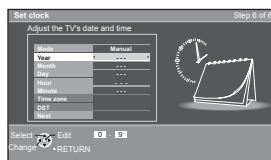

Follow the instructions on screen to complete the following operations.

### Auto setting

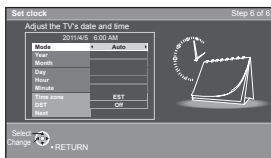

Mode

Manual: Adjust the clock manually (Year/Month/Day/Hour/Minute)  
 Auto: The clock is adjusted automatically via Internet service. Only available when the TV is on a network. -->Set "Network settings" first.

Time zone

Select your time zone. (EST/CST/MST/PST/AKST/HST/NST/AST)

DST

Set DST (Daylight Saving Time) setting. (On/Off)

On: Advances the clock one hour from the time it is set according to the time zone.



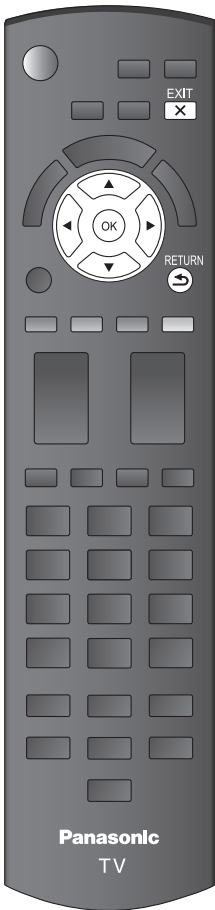

# 7

## Complete First time setup

Congratulations! You are done.

The First time setup can be repeated at any time.  
Press MENU and select SETUP; then “First time setup”.



To watch TV via a Cable box, Satellite receiver, or any other source (DVD, DVR, gaming device, etc.), press the INPUT button and select the appropriate input.

### ■ About wireless LAN

- Wireless LAN adapter and Access point need to be obtained separately. For the latest information on applicable LAN adapters, check the following website: <http://Panasonic.com/NetConnect>
- Check that the Access point supports WPS\*. (If it does not support WPS, the encryption key of the Access point is required when configuring settings.)
- Follow the instructions on the Access point setup screen and configure the appropriate security settings. For more details on setting of Access point, please refer to operating manual for the Access point.
- We recommend using 11n (5 GHz) for the wireless system between the wireless LAN adapter and Access point. Communication is also possible with 11a, 11b, and 11g (2.4 GHz), but the communication speed may be slower.
- If the wireless system of the Access point is changed, devices that could connect by wireless LAN may no longer be able to connect.
- When EASY IPTV, Network camera, DLNA, or other device is using the network, do not disconnect the wireless LAN adapter.
- Keep the TV away from the following devices as much as possible: Wireless LAN, microwaves, and other devices that use 2.4 GHz and 5 GHz signals. Otherwise, the TV failures such as malfunction may occur due to the radio wave interference.

\* WPS: Wi-Fi Protected Setup

### ■ Press to exit from a menu screen



### ■ Press to go back to the previous screen



### ■ Wireless network (First time setup) in 5

- ① Display “Wireless network”
- ② Select the connection method

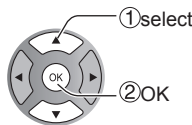
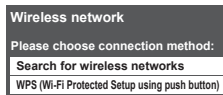

- Follow the directions on screen to complete the setting.
- See page 37 for more information.

# Watching TV



**1** Turn power on  
(Remote) POWER (TV) POWER

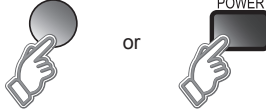

**Note**

- Please select correct input --> (p. 21)

**2** Select a channel number

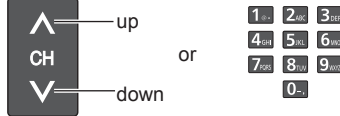

- Also available side CH button on the unit.

**[For Cable/Satellite box connection]**  
- Use your connected box's remote control.

**Note**

- Reselect "Cable" or "Antenna" in "ANT in" of "ANT/Cable setup" to switch the signal reception between cable TV and antenna. (p. 14, 42)
- The channel number and volume level remain the same even after the TV is turned off.

■ To directly enter the digital channel number

# When tuning to a digital channel, press the button to enter the minor number in a compound channel number.

example: CH15-1:

■ Other Useful Functions

**Listen with SAP (Secondary Audio Programming)**

■ Select the Audio mode for watching TV



**Digital mode**

Press SAP to select next Audio track (if available) when receiving a digital channel.

**Audio track 1 of 2  
(English)**

**Analog mode**

Press SAP to select the desired Audio mode.

- Each press of SAP will change the Audio mode. (Stereo/SAP/Mono)
- SAP is not available when watching TV with a Cable or Satellite box connected via HDMI.
- Contact your Cable or Satellite operator for instructions on enabling SAP with their box.

**Closed Caption**

■ Switches the Closed Caption mode On or Off



- Closed Caption is not available when watching TV with a Cable or Satellite box connected via HDMI.
- Contact your Cable or Satellite operator for instructions on enabling CC with their box.

**Displaying Information**

■ Displays and removes information. When watching programming via the Antenna/Cable input, shows the channel banner.



Channel	15-2	THE NEWS					Clock
Station identifier	ABC-HD	CC SAP	TV-G	1080i	Standard	4:3	12:30 PM
Closed caption		Rating Level	Signal resolution	Picture mode	Aspect ratio		Sleep timer remaining time
							30

## Change aspect ratio and Zoom the picture

### ■ Press **FORMAT** to cycle through the aspect modes (p. 50)

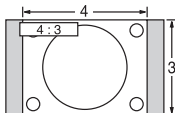

- 480i, 480p: FULL/JUST/4:3/ZOOM
- 1080p, 1080i, 720p: FULL/H-FILL/JUST/4:3/ZOOM

Use when the picture does not fill the whole screen (bars appear on either side of the image) or portions of the picture is trimmed.

#### Note

1. Some content, such as film-based movies, are available in extra-wide format. Top and bottom bars are unavailable.
2. Connected devices, such as Cable/Satellite box, DVD/Blu-ray players and game consoles have their own aspect (format) settings. Adjust the device's aspect settings.

## Display the SUB MENU

### ■ Press **SUB MENU** to show the Sub Menu screen

This menu consists of shortcuts to convenient functions.

Sub menu is only available when the TV is using the Antenna/Cable input, not when using Cable or Satellite box.

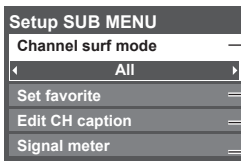

- Channel surf mode — Specify favorites or type of channels to view when pressing the channel up/down button.
- Set favorite — Set favorite channel (below)
- Edit CH caption — Edit the channel identifier (p. 43)
- Signal meter — Check the signal strength (p. 43)

## Call up a favorite channel

### ■ FAVORITE

Channel numbers registered in Favorite are displayed on the favorite tune screen. Select the desired broadcast station with the cursor or use the number buttons. (p. 17)

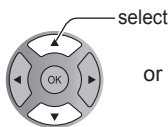
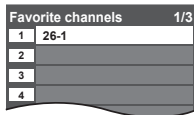

or



### ■ Set the Favorite channel

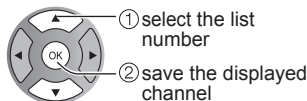
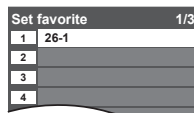
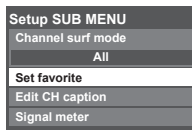

or

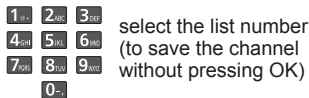

select the list number (to save the channel without pressing OK)

### ■ Delete a favorite channel

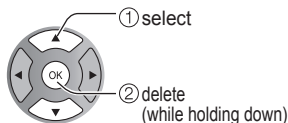
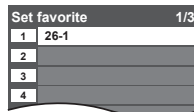

delete (while holding down)

### ■ To change the page



Press repeatedly to change between pages (1/3, 2/3, 3/3 or exit)



Changes the page forward/backward

- Favorite channels cannot be set when using Cable or Satellite box.

## Other Useful operations

### Entering characters

You can use the remote control keys to enter the alphanumeric characters.

#### Switches input mode

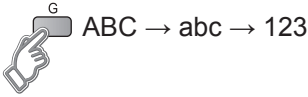

#### Press each number key to cycle through the alphanumeric character

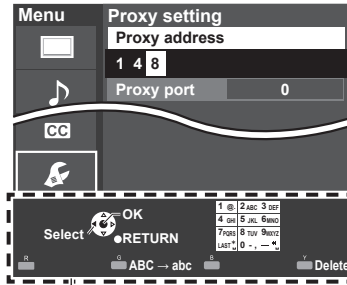

Navigation area

- You can also use a USB keyboard (not supplied) to enter the alphanumeric characters.
- Keyboard type (p. 48)

### Password setting/entering

You need to enter the password when you access locked channel or inputs.

#### Input your 4-digit password

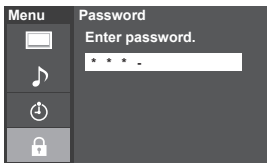

- If it is your first time entering the password, enter the password twice in order to register it.
- Make a note of your password. Do not forget it. (If you have forgotten your password, consult your local dealer.)
- When you select a locked channel, a message will be displayed that allows you to view the channel after you input your password.
- Change password (p. 47)

### Operate USB keyboard

You can operate non-character keys as remote control keys.

#### Key chart

Keyboard key	Remote key	Keyboard key	Remote key
UP/DOWN/LEFT/RIGHT	Cursor key	F4	Input
Enter	OK	F5	Channel Down(-)
BackSpace	Return (when you do not input character)	F6	Channel up(+)
0-9	0-9	F7	Volume Down(-)
F1	Menu	F8	Volume up(+)
F2	VIERA Tools	F9(Red)/F10(Green)/	Color key
F3	Submenu	F11(Blue)/F12(Yellow)	(Red/Blue/Yellow/Green)

- For more details on setting and operation of the USB keyboard, please also read the operating manuals for the USB keyboard.
- Some keyboards do not have these keys.

# Using VIERA TOOLS

VIERA TOOLS is the easy way to access the TV's special features. They are displayed as shortcut icons on the TV screen.

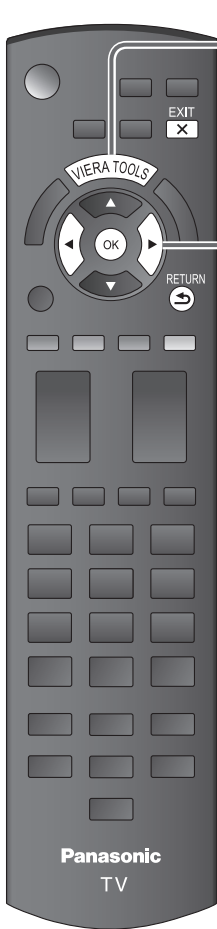

## 1 Display VIERA TOOLS



## 2 Select the item

- The icons displayed differ depending on your country or area you select. (p. 13)

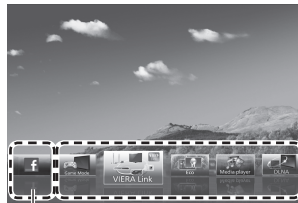

EASY IPTV (example)

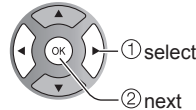

## 3 Set each item

- Using EASY IPTV ➔ p. 39  
Part of Icons on VIERA TOOLS screen above provide you usable Internet service such as Music distributor or social networking service etc.

- Game mode



➔ Change to "Game" mode.  
Picture mode (p. 45)

- VIERA Link



➔ VIERA Link (p. 32-33)

- Eco mode



➔ ECO/energy saving (p. 48)

- Media player



➔ Media player (p. 22-27)

- DLNA



➔ Using DLNA feature (p. 40)

### ■ Press to exit from a menu screen



### ■ Press to go back to the previous screen



Panasonic  
TV

# Watching content from external devices

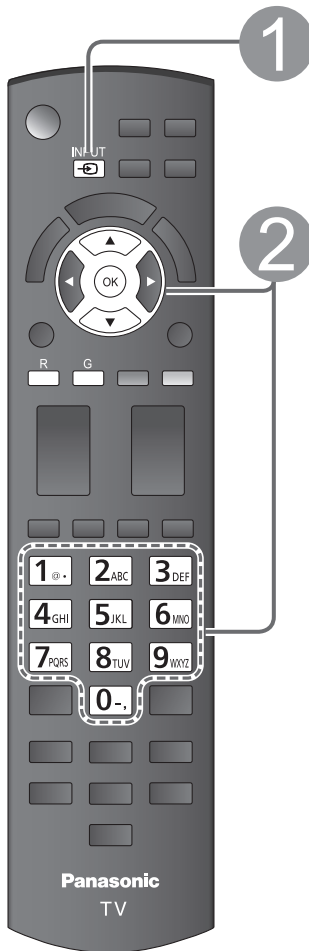

With the connected equipment turned On  
**1 Display the Input select menu**



**2 Select the input mode**

Input select		
1	ANT/Cable In	Not used
2	HDMI 1	GAME
3	HDMI 2	
4	Component	AUX
5	Video	
6	PC	

(example)



or

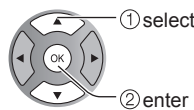

Input label

Setup ANT/Cable (p. 42)

Edit Device labels

➔ Input labels (p. 48)

(shortcut) press the corresponding NUMBER button on the remote control to select the input of your choice. Or, press the INPUT button repeatedly, to cycle through the available inputs.

\* set unused input to "Not used" (below) for quick skipping.

Select the input of your choice, then press OK.



Terminal Label

(example)

- During the selection, if no action is taken for several seconds, the "Input select" menu disappears.

- The terminal and label (names) of the connected equipment are displayed.

### Note

- The input label will be displayed on the "Input select" screen if the Input label was customized.

**3 Operate the connected equipment directly or using the remote control supplied with the equipment**

### Note

- For details, see the manual for the connected equipment.
- PC adjustments (p. 45)

# Using Media player

You can view still and motion images and play music saved on a USB flash memory and an SD card.

## Basic features for Media player

### Available contents and features

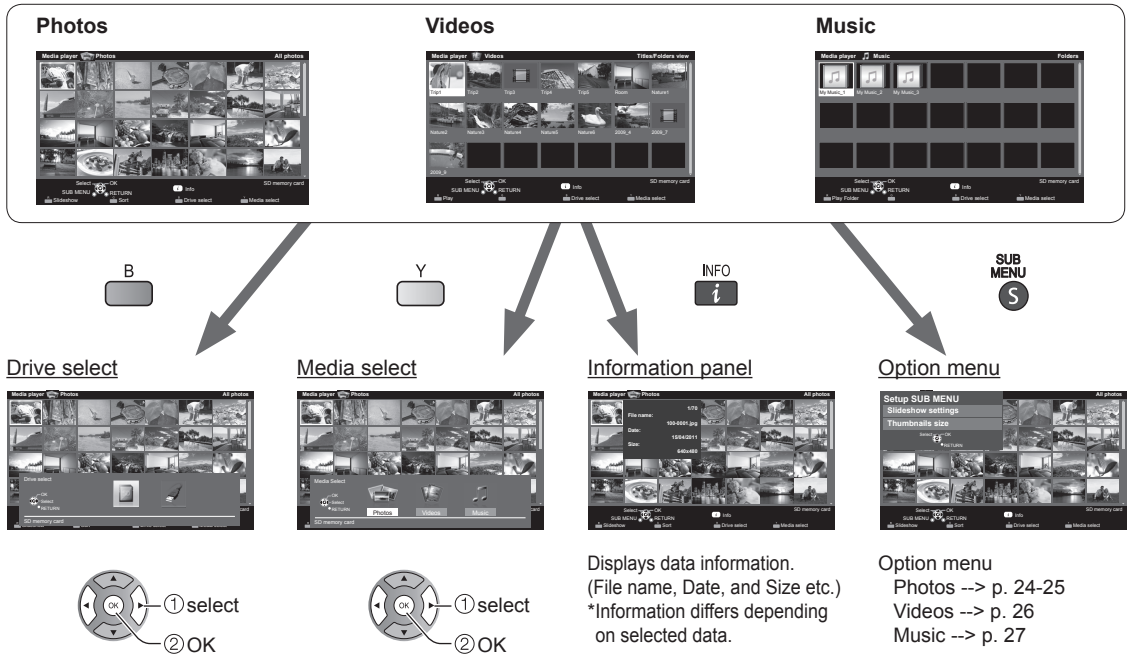

## Media information

### Inserting or removing an SD card/USB flash memory

#### SD card

- Insert the card

Gently insert the SD Card label surface facing front.

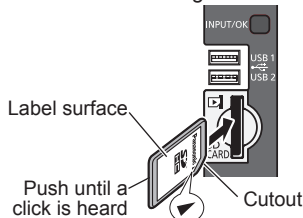

- Remove the card

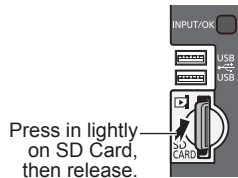

- Compliant card type (maximum capacity): SDXC Card (64 GB), SDHC Card (32 GB), microSDHC Card (32 GB), SD Card (2 GB), miniSD Card (2 GB), microSD Card (2 GB) (requiring microSDHC Card/miniSD Card/microSD Card/adaptor)
- If a microSDHC Card, miniSD Card or microSD Card is used, insert / remove it together with the adaptor.

#### USB flash memory

- Insert the device

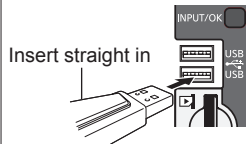

- Remove the device

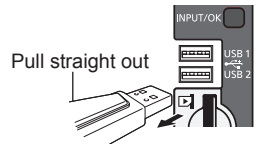

- Media player only supports USB Mass storage class devices.

- For more information and cautions on SD card and USB flash memory (p. 51)



## 1 Insert a Media (SD card or USB flash memory)

- Auto play setting → Image viewer auto play (p. 48)

## 2 Display Media player



or



(example)

## 3 Select Drive (Display connected drive)

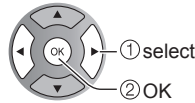

## 4 Select the Media

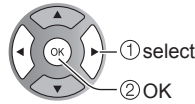
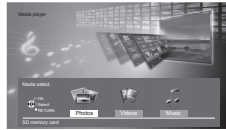

## 5 Select the data (Photos/Videos/Music)

How to view the data differs depending on data storage conditions.

### ① Select Title/Folder



(e.g. Photos)

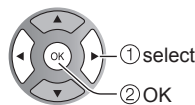

### ② Select file



(e.g. Photos)

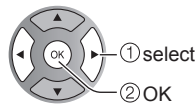

## 6 View or Play



(e.g. Photos)

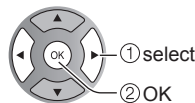

Thumbnail / Playback view image and operation are differ depending on selected contents.

- Photos view --> p. 24-25
- Videos view --> p. 26
- Music view --> p. 27



■ Press to exit from a menu screen



■ Press to go back to the previous screen

RETURN





# Photos view

## [Photos thumbnail]



## [Features]

- Slideshow setting → R
- Sort → G
- Drive select → B
- Media select → Y

## [Photos playback screen]

**Photo status**

- ▶ Slideshow
- || Single view

**Navigation Guide**

- ▶ Slideshow
- ▶ Single view

● To display/hide Guide and Banner → INFO

## Sort

### ① Display "Sort select" menu and select item

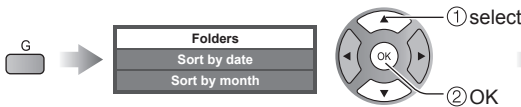

### ② Displayed each view



- Folders (ascending order of numeric/alphabetical)
- Sort by month (ascending order of the month)
- Sort by date

## Photo options

### ① Display "Setup SUB MENU" and select item

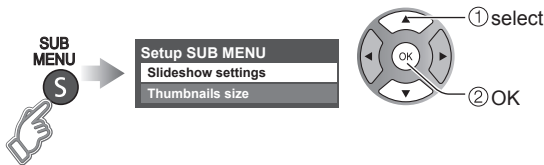

### ■ Slideshow settings (p. 25)

### ■ Thumbnails size

To change the number of photos on a thumbnail screen at a time  
 ▶ (7 × 4 ⇄ 10 × 6)

# Slideshow

## ① Display “Slideshow settings”

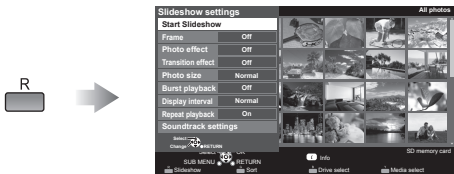

(example)

## ② Adjust items and select “Slideshow start”

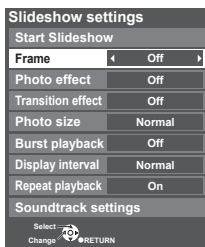

(example)

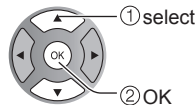

● To stop in mid-cycle Press → RETURN

### ■ Slideshow settings

Settings	Item Description
Frame*	Select the Frame (Off/Array/Collage/Drift(with calendar)/Drift/Gallery(with calendar)/Gallery/Cinema)
Photo effect*	Select the display effect (Off/Sepia/Gray scale)
Transition effect	Select the Transition effect shown between photos (Off /Fade in/Wipe ↓/Wipe ↑/Wipe →/Wipe ←/Slide in ↓/Slide in ↑/Slide in →/Slide in ←/Zoom in/Comb ↑↓/Comb →←/Dissolve/Checker wipe/Motion/Random)
Photo size*	Removes the black borders that are added according to the size of the photo being displayed. (Normal/Zoom)
Burst playback*	Continuously plays photos that were shot continuously. (On/Off)
Display interval	Set “Display interval” each image is displayed in the Slideshow mode. (Short/Fast/Normal/Slow/Very slow)
Repeat playback	Turn the Slideshow Repeat (cycle) function on or off (Off/On).
Soundtrack settings	Select the music (Off/Music 1/Music 2/Music 3/Music 4/Music 5/User selected*/Auto*) User selected: Plays the soundtrack registered in the “Soundtrack settings”. (below) Auto: Plays the songs on the SD card or USB flash memory.

- Picture quality may become lower depending on the slideshow settings.
- Picture setting may not work depending on the slideshow settings.

\* When using DLNA (DMP mode) feature these menus are not displayed.  
DMP: Digital media player → p. 34

### ■ Soundtrack settings

#### ① Select “Soundtrack settings”

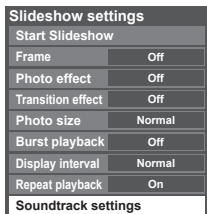

(example)

#### ② Select “User select”

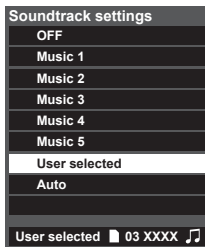

#### ③ Select the song and register

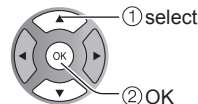
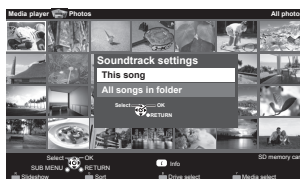

This song: Register current music.  
All songs in folder : Register the music in a folder.

# Videos view

## [Videos thumbnail]

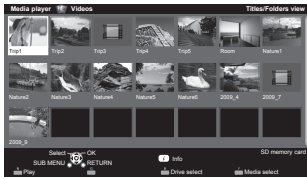

## [Features]

- Play → R
- Drive select → B
- Media select → Y
- Aspect change → FORMAT

## [Videos playback screen]



Movie banner

Drive type (SD/USB/DLNA)



Date and time or File name

Elapsed time of current movie  
\* Counter may not work correctly with DLNA feature. In this case "--:--:--" is displayed.

- To display/hide Guide and Banner → INFO

- Subtitles are not supported in MKV file.

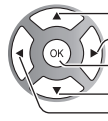

- 30 seconds skip (In DLNA mode only (depends on content))
- Forward
- Play/Pause
- Stop
- Reverse
- Forward/Reverse Five level of 1 to 5 (x2, x5, x,30, x70, x100) are available.

## Video options

Displayed menu will differ depending on contents.

- ① Select "Video options" in "Setup SUB MENU"

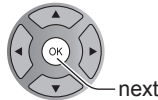

### Repeat playback

Set play repeat function (On/Off)

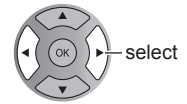

## Compatible Data format for Media player (SD card/USB flash memory)/DLNA

Media	Compatible format
Photo	<ul style="list-style-type: none"> <li>• JPEG files (DCF and EXIF standards)</li> <li>Sub-sampling - 4:4:4, 4:2:2 and 4:2:0</li> <li>Image resolution - 8 × 8 to 30,712 × 17,272 pixels</li> </ul>
Videos	<ul style="list-style-type: none"> <li>• SD-Video Files (SD-Video Standard Ver.1.3) Modified data with a PC may not be displayed correctly.</li> <li>• AVCHD Standard compatible files Modified data with a PC may not be displayed correctly.</li> <li>• MP4 files (Video codec H.264   Audio codec MP3/AC-3/LPCM)</li> <li>• MKV files (Video codec H.264   Audio codec MP3/AC-3/LPCM)</li> <li>• WMV files (Video codec WMV9   Audio codec WMA9)</li> <li>• MPEG-2 PS files*</li> <li>• MPEG-2 TS files*</li> </ul>
Music	<ul style="list-style-type: none"> <li>• MP3 files (MPEG Audio Layer-3)</li> <li>• AAC files (MPEG2-AAC / MPEG4-AAC)</li> <li>• WMA files (WMA9)</li> <li>• LPCM files*</li> </ul>

● For more data format information. (p. 51)

\* For DLNA only.

# Music view

[Music thumbnail]

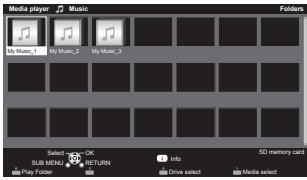

[Features]

- Play folder → R
- Drive select → B
- Media select → Y

[Music playback screen]

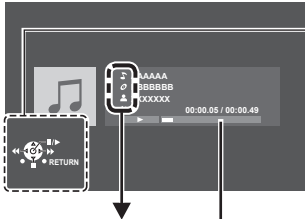

Navigation area



- Forward
- Play/Pause
- Stop
- Reverse

- Forward/Reverse Five level of 1 to 5 (x2, x5, x, x30, x70, x100) are available.

- Artist name
- Album name
- Song name

Elapsed time of current song  
\* Counter may not work correctly with DLNA feature.  
In this case "--:--:--" is displayed.

- To display/hide Guide and Banner → INFO

## Music options

① Select "Music options" in "Setup SUB MENU"

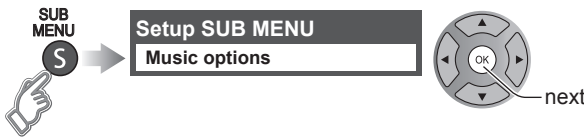

■ Repeat playback

Set play repeat function (Off/Repeat Folder/One song)



## Other settings in Media player

① Display "Menu"



② Select the item

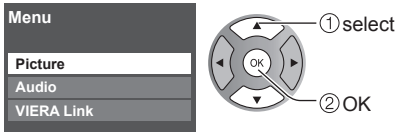

③ Set \_\_\_\_\_

■ Adjust the Picture and Audio

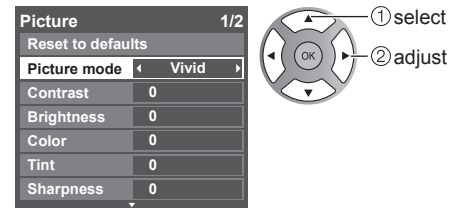

example: Picture menu  
Picture menu/Audio menu  
(p. 45-46)

■ Use VIERA Link function

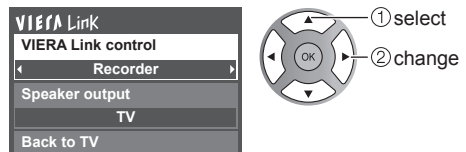

VIERA Link menu (p. 32)

# VIERA Link™ “HDAVI Control™”\*

Simultaneously control all Panasonic “HDAVI Control” equipped components using one button on the TV remote. Enjoy additional HDMI Inter-Operability with compatible Panasonic products.

This TV supports “HDAVI Control 5” function.

Connections to equipment (DVD recorder DIGA, HD Camcorder, Home theater system, Amplifier, etc.) with HDMI cables enables VIERA Link controls.

Equipment with the “HDAVI Control” function enables the following operations:

Version	Operations (See p. 30-33, for more information)
HDAVI Control or later	<ul style="list-style-type: none"><li>● Automatic Input Switching</li><li>● Power on link</li><li>● Power off link</li><li>● Default speakers</li><li>● Speaker control</li></ul>
HDAVI Control 2 or later	<ul style="list-style-type: none"><li>● VIERA Link control only with the TV's remote control</li><li>● Unselected device energy save (for available equipment only)</li></ul>
HDAVI Control 3 or later	<ul style="list-style-type: none"><li>● Provides setting information (Language, time, etc.)</li><li>● Automatic lip-sync function</li></ul>
HDAVI Control 4 or later	<ul style="list-style-type: none"><li>● Energy saving mode (with Quick Start mode)</li></ul>
HDAVI Control 5	<ul style="list-style-type: none"><li>● Audio Return Channel Audio Return Channel (ARC) is a function that enables digital sound signals to be sent via an HDMI cable back from the TV to a connected audio device.</li></ul>

■ **When adding new equipment, reconnecting equipment or changing the setup after the connection, turn the equipment on and then switch the TV on. Set the input mode to HDMI1 or HDMI2 (p. 21), and make sure that the image is displayed correctly.**

VIERA Link “HDAVI Control”, is based on the control functions provided by HDMI and industry standard known as HDMI CEC (Consumer Electronics Control), with unique function that we have developed and added. As such, its operation with other manufacturers' equipment that supports HDMI CEC cannot be guaranteed.

Please refer to the individual manuals for other manufacturers' equipment supporting the VIERA Link function.

## ■ HDMI cable

This function needs an HDMI compliant (fully wired) cable. Non-HDMI-compliant cables cannot be utilized.

It is recommended that you use Panasonic's HDMI cable. Recommended part number:

RP-CDHS15 (4.9 ft/1.5 m), RP-CDHS30 (9.8 ft/3.0 m), RP-CDHS50 (16.4 ft/5.0 m)

\* For more details on the external equipment's connections, please refer to the operating manual for the equipment.

# VIERA Link™ Connections (with VIERA Link function)

## ■ Terminal overview

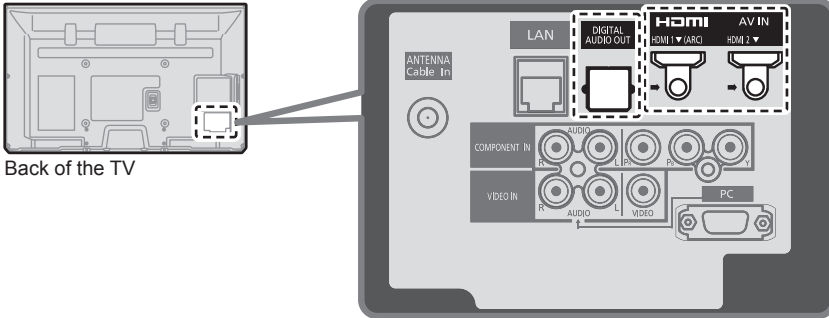

Back of the TV

## ■ Connecting DVD Recorder (DIGA)

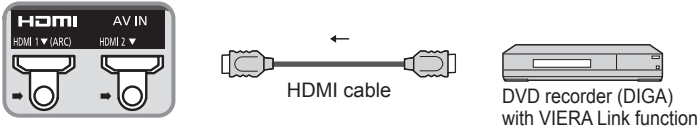

## ■ Connecting Home theater system/AV amp

HDMI 1 is recommended.

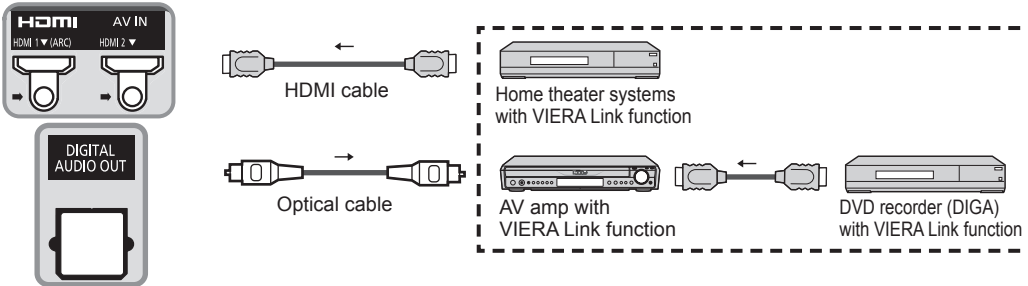

No optical cable is necessary when connecting a Home Theater supporting “HDAVI control 5” with an HDMI cable. Audio will be supported via ARC (Audio Return Channel) (p. 28)

- One AV amp and one DVD recorder (DIGA) can be operated with this unit.

## ■ Connecting HD Camcorder/Digital camera

Press INPUT and select an available HDMI terminal, then connect the camcorder to this input. After connection, confirm the HDAVI control functions. (p. 30-33)

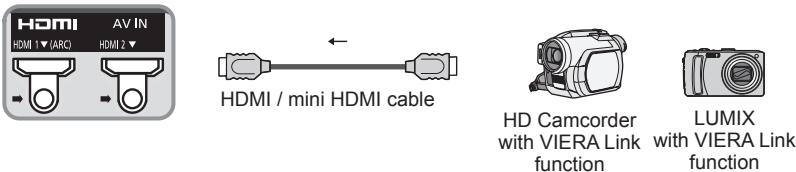

If connection (or setting) of equipment compatible with HDAVI control is changed, switch the power of this unit Off and On again while the power of all equipment is On (so that the unit can correctly recognize the connected equipment) and check that the connected equipment playback operates.

### Note

- Individual HDMI equipment may require additional menu settings specific to each model. Please refer to their respective manuals.
- When audio from other equipment connected to this unit via HDMI is output using “DIGITAL AUDIO OUT” of this unit, the system switches to 2CH audio.  
(When connecting to an AV amp via HDMI, you can enjoy higher sound quality.)
- Some devices use Mini-HDMI terminal. HDMI (type A) to Mini-HDMI (type C) cable or adapter should be used.

## VIERA Link settings and Available features

To use all VIERA Link functions: After everything is connected, in VIERA Link settings menu, set "VIERA Link" to "On". Some features are disabled depending on the "HDAVI Control" version of the equipment. Please check the list (p. 28)

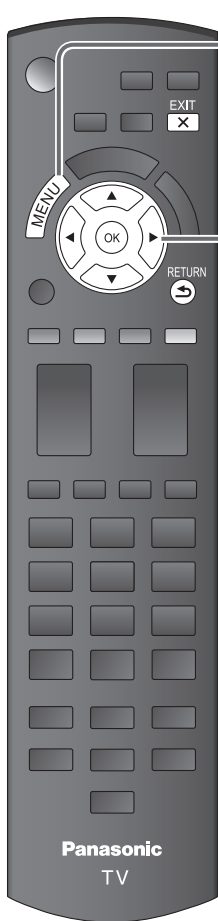

### 1 Display the menu



### 2 Select "VIERA Link settings" in "Setup"

Menu	Setup	1/2
	Channel surf mode	All
	Language	
	Clock	
	ANT/Cable setup	
	Input labels	
	Anti image retention	
	Network settings	
	<b>VIERA Link settings</b>	

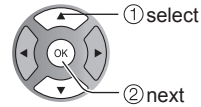

### 3 Select "VIERA Link"

Menu	VIERA Link settings	
	VIERA Link	On
	Power on link	No
	Power off link	Yes
	Energy saving mode	Quick start
	Unselected device energy save	No (stay on)
	Default speakers	TV

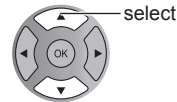

### 4 Select "On"

(default is On)

■ Press to exit from a menu screen



■ Press to go back to the previous screen

RETURN

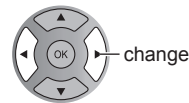

### 5 Select and make other settings

Menu	VIERA Link settings	
	VIERA Link	On
	Power on link	No
	Power off link	Yes
	Energy saving mode	Quick start
	Unselected device energy save	No (stay on)
	Default speakers	TV

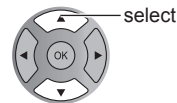

## Automatic Input Switching

When using a Blu-ray Disc player, DVD player/recorder or Home theater system, the TV will automatically change to the appropriate input, when playback begins on one of those devices.

- For a Home theater system the speakers automatically switch to the theater system.

## Power on link

Yes: The TV is turned on automatically and switches to the appropriate HDMI input whenever VIERA Link compatible equipment is initially turned on and the Play mode is selected.

## Power off link

When “Yes” is selected and the TV is turned off, all connected VIERA Link compatible equipment is also automatically turned off.

- A Panasonic DVD Recorder will not turn off if it is still in Rec mode.
- The TV remains on even if the VIERA Link compatible equipment is turned off.

## Energy saving mode

Quick Start: When TV is turned off, all connected VIERA Link compatible equipment is moved to ECO Standby mode\* automatically under these conditions.

- Power off link:(Yes), The connected equipment has “HDAVI Control 4 or later (with Quick Start mode)”
- \* Minimum power consumption of Standby condition for the equipment.

## Unselected device energy save

Yes: The connected VIERA Link compatible equipment will be turned off automatically when not in use under these conditions.

- The connected equipment has “HDAVI Control 2 or later” (for available equipment only)

[ Example of timing for operation ]

- When the input is switched from the HDMI.

## Default speakers

“TV” is the default setting. To set the Home theater system as Default speakers, change the Default speakers setting from “TV” to “Theater”. Sound will be output from the Home theater whenever the TV is powered on.

## Automatic lip-sync function

Minimizes lip-sync delays between the picture and audio when you connect to a Panasonic theater system or Amplifier.

## TV provided setting information

The following information about the TV settings can be transmitted to each piece of equipment (Recorder/Home theater/Player) that has “HDAVI Control 3 or later” function connected to a TV with an HDMI cable.

Transmittable data	Recorder	Home theater	Player
① On Screen Display Language setting (English/Español/Français)	○	○	○
② Panel Aspect Ratio (16:9 fixed)	○	○	○
③ Closed caption information (Mode/CC type/Digital setting)	○	---	---

### Note

- There is a possibility that all the GUI language information might be set from equipment that has an HDMI CEC function connected to the TV with an HDMI cable. Depending on the operating conditions or the specification for each piece of equipment the setting may or may not be applied.
- For more details on the external equipment’s operation, please refer to the operating manual for the equipment.



## VIERA Link menu and Available features

Some features are disabled depending on the "HDAVI Control" version of the equipment.  
Please check the list (p. 28)



### 1 Display the VIERA Link menu



This function is not available depending on your country or area you select. (p. 13)

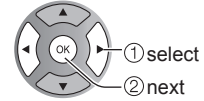

(example)

### 2 Select the item

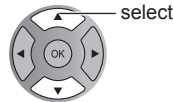
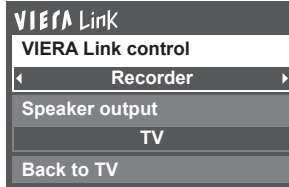

- Items in the VIERA Link menu may be grayed out if no compatible equipment is connected (must be HDAVI Control 2 or later) or if the equipment has not initiated a connection with the TV. In that case, switch the equipment's power Off and On while the TV is On.

For further details, see "VIERA Link" on page 30.

### 3 Select

- Press to exit from a menu screen



- Press to go back to the previous screen

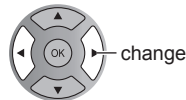
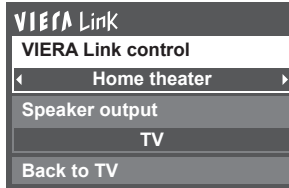

### 4 Set

## Speaker control

You can select the Home theater or TV speakers for audio output.  
Control the theater speakers with the TV remote control.  
This function is available only when a Panasonic Amplifier or Player theater is connected.

- ① Select “Speaker output”
- ② Select “Home theater” or “TV”

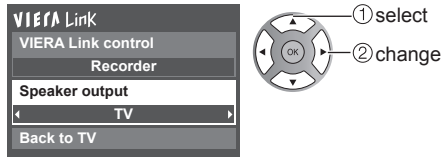

■ **Home theater:** Adjustment for the equipment

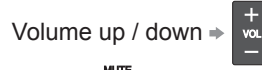

- The sound of the TV is muted.
- When the equipment is turned off, the TV speakers take over.
- Selecting “Home theater” turns the equipment on automatically if it is in Standby mode.

■ **TV:** The TV speakers are on.

## VIERA Link control only with the TV's remote control

In the VIERA Link menu, you can select HDMI connected equipment and access it quickly. Continue using your TV remote control to operate the equipment, pointing it at the TV.

- ① Select “VIERA Link control”
  - ② Select the equipment you want to access  
(Recorder/Home theater/Player/Camcorder/LUMIX/  
Digital camera/Network camera)
- Using VIERA TOOLS (p. 20)

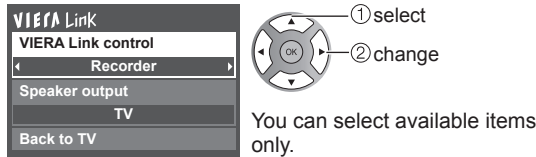

- If there is more than one equipment item, a number after the name indicates the number of items. (e.g. Recorder 1/Recorder 2/Recorder 3...)
- The number of equipment items that can be connected is three for recorders, and a total of three for Home theater/Player/Camcorder/LUMIX/Digital camera/Network camera.

**Note**

- There is a limit to the number of HDMI connectors.
- ③ **Operate the equipment with the TV remote control, pointing it at the TV**
  - To operate the equipment, read the manual of the equipment.

### ■ Available TV remote control buttons

Whether an operation is available differs depending on the connected equipment.

	Move the cursor/Select		Play
	Set/Access		Stop
	Return to previous menu		Reverse/Forward
	Display the functions menu on the equipment		Skip Reverse/Forward
	Available when the purpose of the keys is displayed on screen		Pause
	Exit		Closed caption
	Channel Up/Down		SAP (Select Audio Mode)
	0-9		Select digital subchannel

## Back to TV

Returns the input selection of the device selected with the VIERA Link Control to the TV input.

### Select “Back to TV”

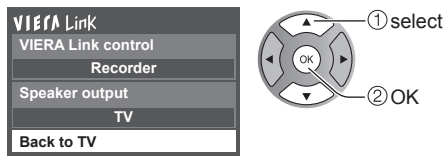

# Using Network services

## Available Network service and features

### ■ Using EASY IPTV → p. 39

### ■ Using DLNA feature (Home network) → p. 40

This TV is a DLNA Certified™ product.

DLNA (Digital Living Network Alliance) is a standard that makes DLNA Certified digital electronics easier and more convenient to use on a home network. To learn more, visit [www.dlna.org](http://www.dlna.org).

It allows you to share photos, videos and music stored in the DMS (for example, PC with windows 7 installed, etc.) connected to your home network, and enjoy watching them on the TV screen as DMP.

#### **DMS (Digital Media Server)**

Ensure the connected equipment has a DLNA Certified media server.

Store photos, videos or music into the media server, and then you can watch them on the TV.

“Windows 7” is the server software that has been tested for the performance with this TV (current as of January, 2011).

For installing, read the manual of the server software.

- The DLNA control function of Windows 7 is not supported with this TV.
- When a server software for the media server is installed on the PC, the data may be at risk of being accessed by other people. Please take care of the settings and connections under the network circumstances at the office, hotel or even at home when not using a router.

#### **DMP (Digital Media Player)**

Finds the content on DMS and provides playback.

### ■ Using Network camera → p. 41

## 1 Contact your Broadband service provider

**NOTICE:** If you don't have Internet service by your local provider, please order a high-speed Internet service at no less than the following connection speed. If you already have such service, make sure that the connection speed exceeds the following.

- Required speed (effective): at least 1.5 Mbps for SD and 6 Mbps for HD picture quality, respectively.
- Dial-up Internet service cannot be used for EASY IPTV.

## 2 Select wired or wireless connection

If the Cable/DSL modem is close to the TV and you have only one TV set, you may choose a wired connection. If the Cable/DSL modem is far from the TV and/or you have more TVs in the house, you may want to use a wireless network.

## 3 Connecting to the Internet

### A Wired connection (Directly connected)

If you are not using the network for connecting anything else but the TV, you could just connect the TV directly to the Cable/DSL Ethernet connection.

### B Wired connection (Using Router)

If you are using the network for connecting various equipments and want to connect the TV, you should use a router to connect the TV to the Internet

### C Wireless connection

If you are using the network for connecting various equipments and want to connect the TV, you could also use a wireless LAN adapter and Access point to connect the TV to the Internet

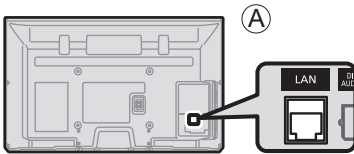

Back of the TV

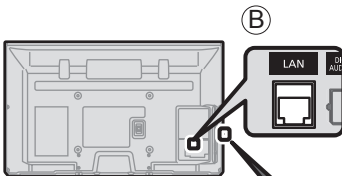
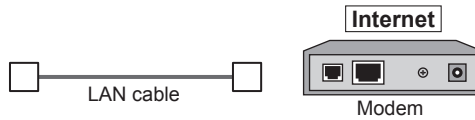

Back of the TV

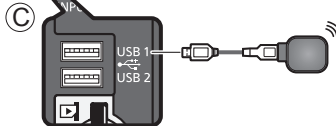
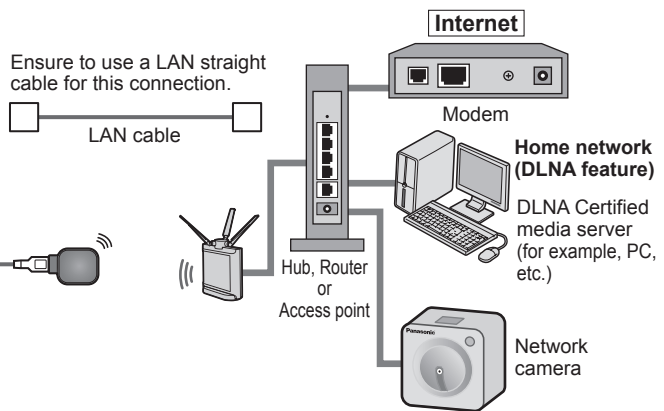

- To use only DLNA features or Network camera, you can operate the features without Broadband network environment.

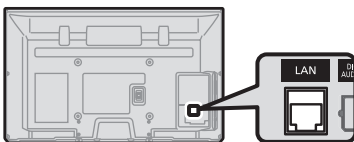

Back of the TV

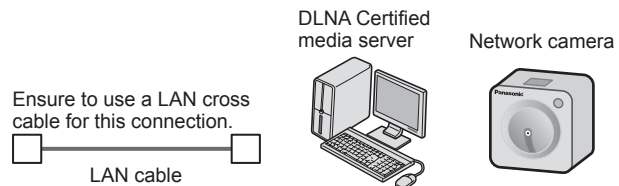

## Network settings

This is a setting for connecting to a broadband environment.

**1 Display the menu**

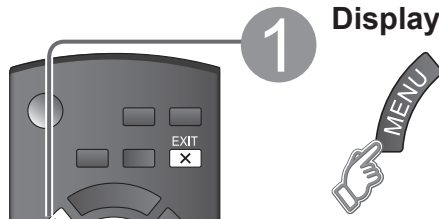

**2 Select "Network settings"**

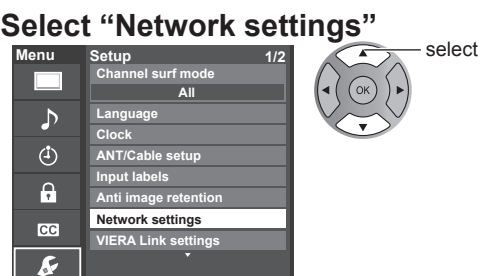

**3 Select the settings and set**

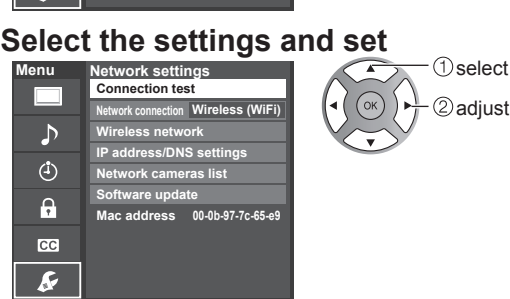

■ Press to exit from a menu screen  
EXIT

■ Press to go back to the previous screen  
RETURN

### Connection test

Check that the Network settings are as shown below, and then start "Connection test".

- 1 Select "Connection test" and press OK**  
(It takes a while to cancel the test.)
- 2 Displayed Connection test screen**

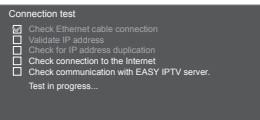

- 3 Complete Connection test**

Success-->Completion screen is displayed.  
Error-->Follow the directions on screen to complete the setting.  
If you perform the Proxy settings, check the Proxy address and the Proxy port number.

### Network connection

Select Network type (Ethernet cable/Wireless (WiFi))

#### Wireless network (Confirm Current settings and status)

This setting is performed only when "Wireless (WiFi)" is selected in "Network connection" above.

#### ■ Displayed "Current settings and status" screen (If connected with wireless LAN adapter)

You can confirm the AP connection status.

(SSID/Wireless type/Security type/Encryption type/Connection status /Signal strength)

- 1 Press "Wireless network"**

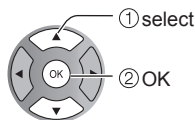
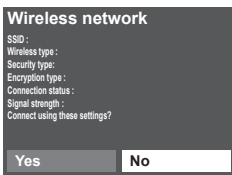

- 2 When you change "Wireless network" -->Press "No"**  
See "Sets / Changes wireless network setting" on p. 37 and follow the directions on screen to complete the setting.

You need to be "Connected" to use network devices.  
Please set Access point settings to "Connected".

(example)

## Wireless network (Wireless network setting)

### ■ Sets / Changes wireless network setting

- ① Press “Wireless network” and display setting screen
- ② Follow the directions on screen to complete the setting

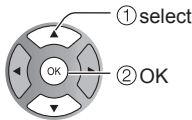
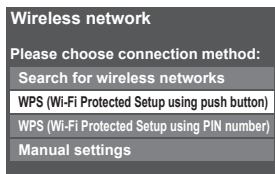

### Search for Wireless networks:

Select an Access point from the ones searched for automatically, and configure the settings as instructed on the screen.

### WPS (Wi-Fi Protected Setup\* using push button):

You can connect the Access point to press the buttons.

### WPS (Wi-Fi Protected Setup using PIN number):

Set the PIN code that is displayed on the TV on the Access point.

### Manual settings:

Manually set SSID, Security type, and Encryption type to match the settings of the Access point to which to connect.

- When connecting by 11n (5 GHz), select “AES” as the Encryption type for the wireless LAN.

- \* Wi-Fi Protected Setup is an easy setting of the Wi-Fi Alliance’s certification
- For more details on setting of an Access point, please refer to operating manual for the Access point.

## IP address/DNS settings

- ① Select “IP/DNS setting mode” and set to “Automatic”

(When IP/DNS automatic acquisition in DHCP can be used)

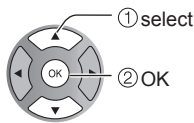
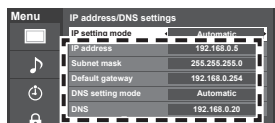

The acquired address is displayed.

### ■ Manual setting

- ① Select “IP/DNS setting mode” and set to “Manual”
- ② Select the item and press OK
- ③ Check the specifications of the broadband router and enter each IP address.  
Or Enter each IP address as was specified by the provider



- ② Each IP address is acquired automatically

If you are using a broadband router, IP automatic acquisition in DHCP can be used under normal circumstances. If you are not sure, check with the person who installed the equipment, or check the instructions for each device.

## Proxy setting

Set only if specified by the provider. It is not required for normal household use.

- ① Select “Proxy setting”

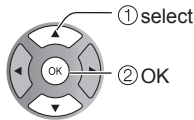
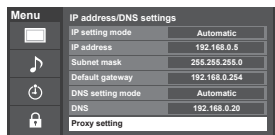

### ■ Proxy address

This is the address of the relay server that is connected to the target server instead of the browser and sends data to the browser. Setting is only required if specified by the provider.

### ■ Proxy port

This number is specified by the provider together with the Proxy address.

- ② Select item and press OK

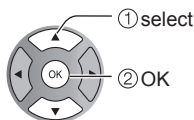

- ③ Enter address or port number and press OK

- Entering characters (p. 19)

## Network cameras list

Before using a Network camera, you need to register the camera as shown below. You can also set to Default camera or Disconnect/Delete the registered cameras.

### ① Press “Network cameras list” and display screen

### ② Set Network camera setting

Network cameras list			
Camera name	Model	Status	Default
Camera 1	BL-C210A	Connected	
...	...	...	
...	...	...	
...	...	...	
...	...	...	
...	...	...	
...	...	...	
...	...	...	
...	...	...	
...	...	...	

Select → OK

Find cameras      Delete  
Disconnect      Default camera

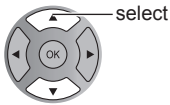

- For this operation, please refer to the operating manual for the Network camera.



➔ Start camera search.

- Before you start to search for a camera, switch the camera to registration mode.
- Search condition also depends on “Network settings”



➔ Delete camera information.



➔ Disconnect to camera.

“Disconnected” will be displayed in “Status”.



➔ Set to default use.

Displayed “(Default)” next to camera name.



(Available only when reconnecting)

➔ Connect to Camera. “Connect” will be displayed in “Status”.

## Software update

### ① Select “Software update”

Menu	Network settings
	Connection test
	Network connection Wireless (WiFi)
	Wireless network
	IP address/DNS settings
	Network cameras list
	<b>Software update</b>
	Mac address 00-0b-97-7c-65-e9

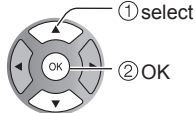

### ② Press OK to start the Software update screen

### ③ Follow directions on the screen

- Set “Clock” first. (p. 15)

This function allows you to access Internet services, such as music distribution or social networking service etc, easily with selecting the VIERA TOOLS icon.

- You need broadband environment to use this service.

### Preparations

- Network connections (p. 35)
- Network settings (p. 36-38)

## Display VIERA TOOLS

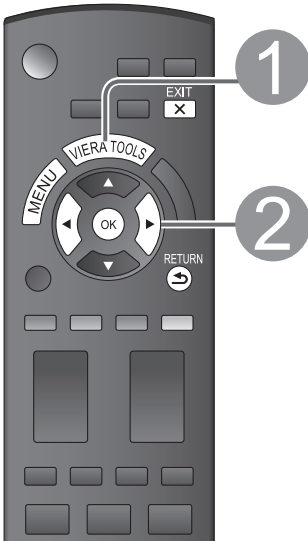

## Select the item



(example)

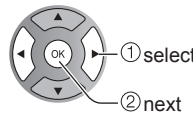

Services contents
Music distribution/Radio service
SNS (Social Network Service)

### Press to exit from a menu screen



### Press to go back to the previous



- Not all EASY IPTV services are available depending on your country or area you select. (p. 13)
- Available EASY IPTV services are subject to change without notice.

### Using USB keyboard

- USB connections (p. 51)
- Keyboard type (p. 48)
- Operate USB keyboard/Entering characters (p. 19)

## Other settings

### In 2

#### 1 Display "Menu"



#### 2 Select the item

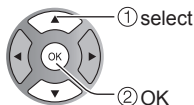
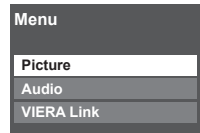

#### 3 Set

### Adjust the Picture and Audio

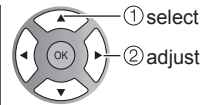
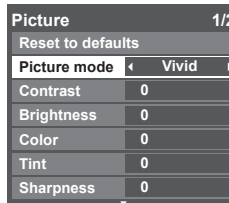

example: Picture menu  
Picture menu/Audio menu  
(p. 45-46)

### Use VIERA Link function

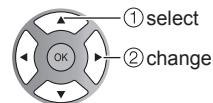
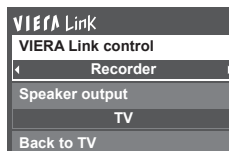

VIERA Link menu (p. 32)



# Using DLNA feature

You can share the contents (Photo, Video, Music etc.) stored in DLNA Certified media server with your home network system.

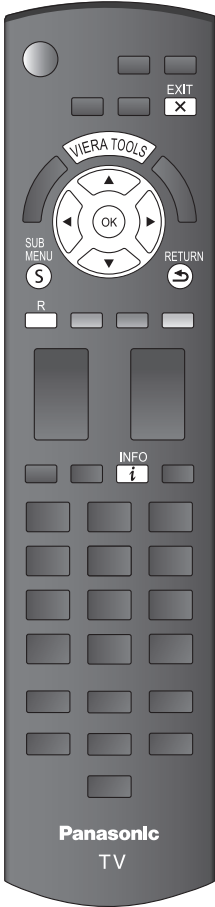

■ Press to exit from a menu screen



■ Press to go back to the previous screen



## Preparations

- Network connections (p. 35)
- Network settings (p. 36-38)

### 1 Display VIERA TOOLS



### 2 Select the "DLNA"



(example)

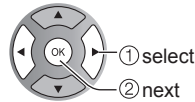

### 3 Select server Display available server.

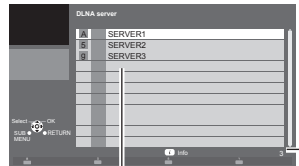

(DLNA server list)

Available DLNA servers

Total listed number

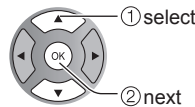

- To display Information



### 4 Select contents Display contents of selected server.

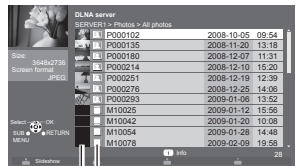

Contents type (File list)

Thumbnail

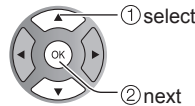

- To display Information



- To display "Slideshow settings" (p. 25) (photo only)



- To display Optional menu



### 5 View/Play See "Using Media player" to operate. (p. 22-27)

# Network Camera

You can operate the Network camera from the TV remote and also check the images from the Network camera on your TV.

- VIERA Link control only with the TV's remote control (p. 33)



■ Press to exit from a menu screen



■ Press to go back to the previous screen



## Preparations

- Network connections (p. 35)
- Network settings (p. 36-38)
  - Before connecting the Network camera to the TV, please complete "IP setting" and run "Connection test"

### 1 Display "VIERA Link" menu



- If there is no registered camera displayed, please set it in Network Camera settings. (p. 38)
- There is also an option to start with sensor detection.

### 2 Select "Network camera"

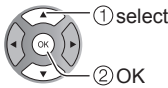
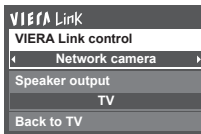

### 3 View

#### 4 split screen



- Default camera setting (p. 38)



#### 9 split screen

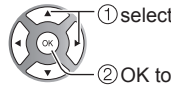

#### Single screen



#### Navigation area

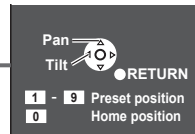

### Note

- A number of VIERA-compatible network cameras can be found at the following sites:  
<http://www.panasonic.com/>  
<http://panasonic.net/pcc/products/netwkcsm/>
- For more details on setting and operation of the Network camera, please also read the operating manuals for the Network camera.

# Editing and Setting Channels

The current channel settings can be changed according to your needs and reception conditions.

## ANT/Cable setup and operation

**1 Display the menu**



**2 Select "Setup"**

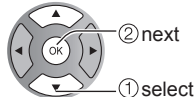

Menu	Setup	1/2
	Channel surf mode	All
	Language	
	Clock	
	ANT/Cable setup	
	Input labels	
	Anti image retention	
	Network settings	
	VIERA Link settings	

**3 Select "ANT/Cable setup"**

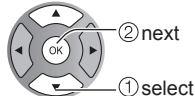

Menu	Setup	1/2
	Channel surf mode	All
	Language	
	Clock	
	<b>ANT/Cable setup</b>	
	Input labels	
	Anti image retention	
	Network settings	
	VIERA Link settings	

■ Press to exit from a menu screen



### Auto program (Set automatically)

Automatically searches and adds available channels to the memory.

**1 Select "ANT in"**  
 ➔ Select "Cable" or "Antenna"  
 Or select "Not used".

**2 Select "Auto program"**

Menu	ANT/Cable setup
	ANT in Cable
	<b>Auto program</b>
	Manual program
	Signal meter

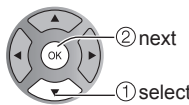

**3 Select a scanning mode (p. 14)**

Menu	Auto program
	All channels
	Analog only
	Digital only

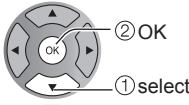

- After the scanning is completed, select "Apply". (see p. 43 ⑤).
- All previously saved channels are erased.

## Manual program (Set manually)

Use this procedure when changing the channel setup or changing the channel display. Also, use this to add or skip channels from the channel list manually.

You can select a channel tuning mode (Digital only/Analog only) in "Channel surf mode" (p. 48)

### ① Select "Edit"

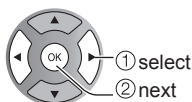
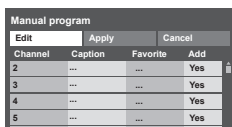

### ② Select the item to edit

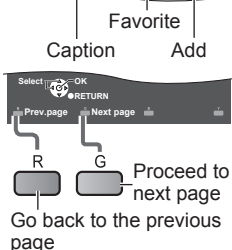
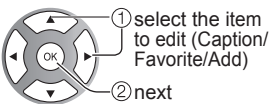
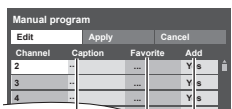

- **Caption:**  
Changes the station identifier
- **Favorite:**  
Registers channels to the Favorite List
- **Add:**  
Adds or skips channels

### ③ Edit

#### ● Caption

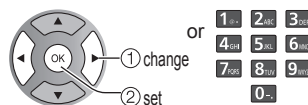

#### Caption

Select or edit the station identifier. (maximum 7 characters available)



#### ● Favorite

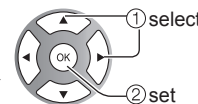

**Set favorite** Select the number

#### ● Add

Press OK to select "Yes (add)" or "No (skip)"



### ④ Move the cursor to a channel number

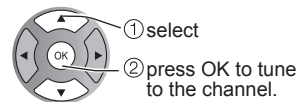
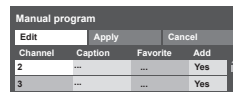

### ⑤ Select "Apply"

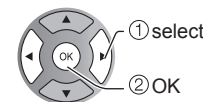

## To cancel the Edit

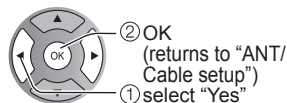
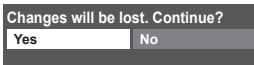
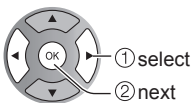
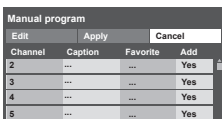

## Signal meter (Check signal strength)

Check the signal strength if interference is found or freezing occurs on a digital image.

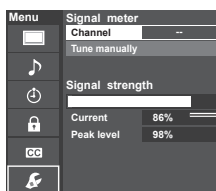

Signal intensity

- If the signal is weak, check the antenna. If no problem is found, consult your local dealer.

#### Note

- Not available if "Cable" is selected in "ANT in" (see p. 42).
- Available only for digital antenna channels.

# How to Use Menu Functions

Various menus allow you to set the picture, sound, and other functions so that you can enjoy watching TV best suited for you.

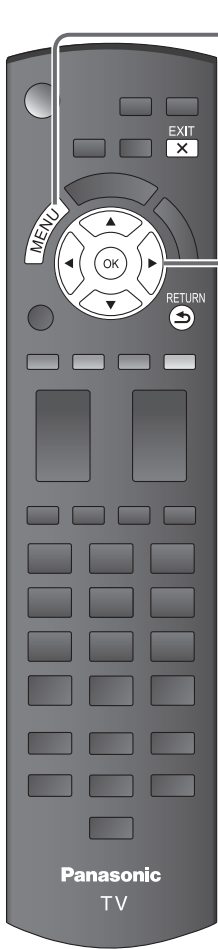

## 1 Display the menu



- Shows the functions that can be adjusted.
- Some functions will be disabled depending on the type of input signal.

### Menu structure



- Menu bar  
Press OK to move to the Menu items.
- Menu items  
Press OK to proceed to the next screen if available.
- Help information  
Select or enter the name of the device connected to the HDMI 1 terminal.
- Operation guide  
Select Change RETURN

(example: Input labels)

## 2 Select the menu



- Picture settings
- Audio settings
- Timer (Sleep, On/Off timer)
- Lock (Channel, Game, Program etc.)
- Closed Caption setting
- Setup (other settings)

## 3 Select the item and adjust

■ Press to exit from a menu screen



■ Press to go back to the previous screen

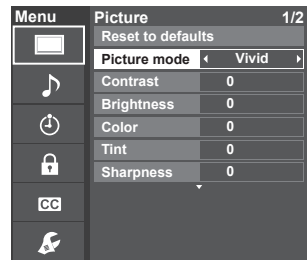

adjust or select

(example: Picture menu)

- “Reset to default” will be grayed out if no changes are made in the following menus: “Picture”, “PC adjustments”, “Audio” and “Closed caption”.

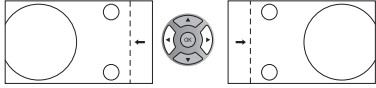
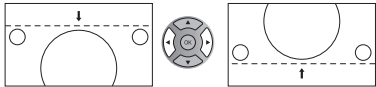
Picture settings		Adjust the image or picture quality	
Settings	Items	Item Description	
<b>Reset to defaults</b>		Resets all picture adjustments to factory default settings except for “Advanced picture”.	
<b>Picture mode</b>	<b>Vivid</b>	Provides enhanced picture contrast and sharpness for viewing in a well-lit room.	
	<b>Standard</b>	Recommended for normal viewing conditions with subdued room lighting.	
	<b>Cinema</b>	For watching movies in a darkened room. It provides a soft, film-like picture.	
	<b>Game</b>	For playing video games.	
	<b>Custom (Photo)</b>	Customizes each item according to your taste. Photo is displayed in JPEG menu.	
<b>Contrast, Brightness, Color, Tint, Sharpness</b>		Adjusts the color, brightness, etc. for each picture mode to suit your taste <ul style="list-style-type: none"> <li>• Display range Contrast/Brightness/Color/Sharpness : 0 - 100</li> <li>Tint : -50 - +50</li> </ul>	
<b>Color temp.</b>	<b>Cool 2/1/Normal/ Warm 1/2</b>	Selects a choice of Cool (blue), Normal, or Warm (red) color.	
<b>Color mgmt.</b>	<b>Off/On</b>	On: Enhances green and blue color reproduction, especially outdoor scenes.	
<b>C.A.T.S.</b>	<b>Off/On</b>	Automatically adjusts the screen brightness according to the ambient lighting condition.	
<b>Video NR</b>	<b>Off/Weak/ Medium/Strong</b>	Reduces noise, commonly called snow. Leave it off when receiving a strong signal.	
<ul style="list-style-type: none"> <li>• Some menus are grayed out depending on the input signal or condition. (e.g. “Zoom adjustments” will be grayed out if the aspect is not set to Zoom.)</li> </ul>			
<b>Aspect adjustments</b>	<b>Screen format</b>	<b>FULL/H-FILL/ JUST/4:3/ZOOM</b>	Changes the format (aspect ratio). Lets you choose the aspect depending on the format of received signal. (p. 50)
	<b>H size</b>	<b>Size 1/Size 2</b>	Adjusts the horizontal display range to reduce noise of both side edges of an image. Size 2: Adjusts the image size according to the aspect mode to reduce noise. (p. 50)
	<b>Zoom adjustments</b>		Adjusts vertical alignment and size when aspect setting is “ZOOM”.
<b>PC adjustments</b>	<b>Reset to defaults</b>	Resets PC adjustments.	
	<b>Sync</b>	<b>H &amp; V</b>	The H and V sync signals are input from the HD/VD connector. (p. 53)
		<b>On green</b>	Uses a synchronized signal on the Video G signal, which is input from the G connector. (p. 53)
	<b>Dot clock</b>	Alleviates the problem if a picture appears to be vertically-striped, flickers partially or is blurred.	
	<b>H-position</b>	Adjusts the horizontal position.	
	<b>V-position</b>	Adjusts the vertical position.	
	<b>Clock phase</b>	Alleviates the problem if the whole picture appears to flicker or is blurred. First adjust the Dot Clock to get the best possible picture, then adjust the clock Phase so that a clear picture appears. ● It may not be possible to display a clear picture due to poor input signals.	
<b>Input resolution</b>	Switches to wide display. <ul style="list-style-type: none"> <li>● VGA (640×480 pixels), WVGA (852×480 pixels), XGA (1,024×768 pixels), WXGA (1,280×768 pixels)</li> <li>● Options change depending on signals</li> </ul>		
<b>H-frequency</b>	Displays the H (Horizontal)/V (Vertical) frequencies.		
<b>V-frequency</b>	Display range Horizontal: 15 - 110 kHz Vertical: 48 - 120 Hz		

Settings	Items	Item Description
<b>HDMI settings</b>	<b>HDMI/DVI RGB range (HDMI 1-2)</b>	<b>Auto/Standard (16-235)/Nonstandard</b> Prevents the blown out highlights and blocked up shadows when a wide-range signal is received. Selects between standard RGB range (16-235 bits) or non-compliance (0-255 bits). Auto: Switches the RGB range (Standard (16-235)/Nonstandard) depending on the HDMI signal information.
	<b>Contents type (HDMI 1-2)</b>	<b>Off/Auto/Photo/Graphics</b> Sets content type to each HDMI input.  Auto: Switches content type automatically depending on the HDMI signal information. Photo: Best setting for JPEG viewing. Graphics: Best setting for On-Screen display of connected equipment.

- Some menus are grayed out depending on the input signal or condition.  
(e.g. "3:2 pulldown" will be grayed out if the input signal is high definition or you are viewing photos, etc.)

<b>Advanced picture</b>	<b>3D Y/C filter</b>	<b>Off/On</b>	Minimizes noise and cross-color in the picture.
	<b>Color matrix</b>	<b>SD/HD</b>	Selects image resolution of component-connected devices. SD: Standard Definition HD: High Definition Only used with 480p video signal.
	<b>Block NR</b>	<b>Off/On</b>	Reduces noise of specific digital signals of DVD, Cable box, etc.
	<b>Mosquito NR</b>	<b>Off/On</b>	Reduces HDTV flicker noise in the contoured sections of an image
	<b>Black level</b>	<b>Dark/Light</b>	Selects Dark or Light. Valid only for external input signals.
	<b>3:2 pulldown</b>	<b>Off/On/Auto</b>	Adjusts the picture recorded in 24 fps for optimum quality.
	<b>24p Direct in</b>	<b>60Hz/48Hz</b>	48Hz: Achieves more cinematic playback by reproducing the movie contents at twice the speed of 24 frames per second.

## 🎵 Audio settings Adjust Audio quality

Settings	Items	Item Description	
<b>Reset to defaults</b>		Resets Bass, Treble, and Balance adjustments to factory default settings.	
<b>Bass</b>		Increases or decreases the bass response.	
<b>Treble</b>		Increases or decreases the treble response.	
<b>Balance</b>		Emphasizes the left / right speaker volume.	
<b>Advanced audio</b>	<b>A.I. sound</b>	<b>Off/On</b>	Equalizes overall volume levels across all channels and external inputs.
	<b>Surround</b>	<b>Off/On</b>	Enhances audio L/R response when listening to stereo.
	<b>Bass boost</b>	<b>Off/On</b>	Enhances bass sound and provides powerful sound.
	<b>Volume leveler</b>		Minimizes volume disparity after switching to external inputs.
	<b>TV speakers</b>	<b>Off/On</b>	Switches to "Off" when using external speakers. Off: "A.I. sound", "Surround", "Bass boost" and "Volume leveler" do not work if "Off" is selected.
	<b>HDMI 1-2 in</b>	<b>Digital/Component/Video</b>	The default setting is "Digital" for the HDMI connection. (Digital input signal) Select audio input terminal when DVI cable is connected. (Analog audio input signal)

## 🕒 Timer settings The TV can automatically turn On/Off at the designated date and time.

If the Timer settings are grayed out, first set the clock (see p. 48) and make sure "Auto power on" is set to "No" (see p. 48)

Settings	Items	Item Description
<b>Sleep (Off timer)</b>	<b>Sleep (minutes)</b>	<b>Off/15/30/60/90</b> Select how long for the TV to automatically turn off.
<b>Timer 1-5 (On/Off timer)</b>	<b>Timer set</b>	Enables or disables this timer. (Off/On)
	<b>Inputs</b>	Sets the input to select when the TV turns on.
	<b>Channel</b>	Sets the channel to select when the TV turns on.
	<b>Day</b>	Sets the day when the TV turns on. [SUN/MON/TUE/WED/THU/FRI/SAT (displays the nearest future date) MON-FRI/SAT-SUN/DAILY/Every SUN/Every MON/Every TUE/Every WED/Every THU/Every FRI/ Every SAT]
	<b>On time</b>	Sets the time when the TV turns on. The TV will turn off after 90 minutes or as specified.
	<b>Off time</b>	Sets the time when the TV turns off within 24 hours.

## **Lock** Locks specified channels or shows to prevent children from watching objectionable content.

You will be asked to enter your password each time you display the Lock menu.

- Password setting/entering (p. 19)

Set "Custom" in "Mode" to specify "Channel", "Game", "Program" and "EASY IPTV" settings.

Settings	Items	Item Description
<b>Mode</b>	<b>Off</b>	Unlocks all the Lock settings of "Channel", "Game", "Program" and "EASY IPTV".
	<b>All</b>	Locks all the inputs regardless of the Lock settings of "Channel", "Game", "Program" and "EASY IPTV".
	<b>Custom</b>	Locks specified inputs of "Channel", "Game", "Program" and "EASY IPTV".
<b>Channel</b> (These channels will be blocked regardless of the program rating.)	<b>Mode</b>	Set channel lock status. (Off/All/Custom) All: Locks all channels Off: Unlocks all channels Custom: Locks specified channels. Set "Channel 1" - "Channel 7"
	<b>Channel 1-7</b>	Select a channel to lock. (Select up to 7 (1-7) channels to block.)
<b>Game</b>	<b>On/Off</b>	Locks Channel 3, Channel 4, and external inputs.
<b>Program</b> (To set a rating level)	<b>Mode</b>	Set program lock status. (Off/On) "V-chip" technology enables restricted shows to lock according to TV ratings. On: Set each rating level (MPAA, U.S.TV, C.E.L.R., C.F.L.R.)
	<b>MPAA</b>	Select U.S. movie ratings to lock.
	<b>U.S.TV</b>	U.S. TV program ratings. <span style="float: right;">For more information (p. 49)</span>
	<b>C.E.L.R.</b>	Canadian English ratings.
<b>(EASY IPTV)*</b>	<b>C.F.L.R.</b>	Canadian French ratings.
	<b>On/Off</b>	On: Locks EASY IPTV. When you select EASY IPTV icon on VIERA TOOLS screen, the EASY IPTV Lock screen is displayed. Type the correct password to enter the screen. * The menus displayed differ depending on your county or area you select (p. 13)
<b>Change password</b>		Change the password. Input the new 4-digit password twice.

- This television is designed to support the "Downloadable U.S. Region Rating System" when available. (Available only in U.S.A.)
- The Off rating is independent of other ratings.
- When placing a lock on a specific-age-based-rating level, the Off rating and any other more restrictive ratings will also be blocked.

## **Closed caption** Display closed caption

The television includes a built-in decoder that is capable of providing a text display of the audio.

The program being viewed must be transmitting the Closed caption (CC) information. (p. 52)

Settings	Items	Item Description
<b>Reset to defaults</b>		Resets all Closed caption settings to factory default settings.
<b>Mode</b>	<b>On/Off/</b>	On: To display Closed captions.
	<b>CC on mute</b>	CC on mute: To display Closed captions when the audio is muted. (When not using, select "Off").
<b>Analog</b>	<b>CC1-4/T1-4</b>	Choose the Closed caption service of Analog broadcasting. CC1-4: Information related to pictures (Appears at the bottom of the screen) T1-4: Textual information (Appears over the entire screen)
<b>Digital</b>	<b>Primary/Second./</b>	The Digital Closed caption menu lets you configure the way you choose to view the digital captioning.
<b>Digital setting</b> (Set display settings in digital program)	<b>Service 3/4/5/6</b>	
	<b>Size</b>	Text size
	<b>Font</b>	Text font
	<b>Style</b>	Text style (Raised, Depressed, etc.)
	<b>Foreground</b>	Color of text
	<b>Fore. opacity</b>	Opacity of text
	<b>Background</b>	Color of text box
<b>Back. opacity</b>	Opacity of text box	
	<b>Outline</b>	Outline color of text (Identify the setting options on the screen)

- The settings in "Analog" or "Digital" depend on the broadcaster.



## Setup Other function settings

Settings	Items	Item Description
<b>Channel surf mode</b>	<b>All/Favorite/Digital only/Analog only</b>	Sets the mode to select the channel with the Channel up/down button. Favorite: Only channels registered as FAVORITE. (p. 18)
<b>Language</b>	<b>English/Español/Français</b>	Selects the screen menu language.
<b>Clock</b>		Adjusts the clock. (p. 15)
<b>ANT/Cable setup</b>	See p. 42-43 for more detail.	
<b>Input labels</b> (Display labels of connected devices)	Selects the terminal and label of the external equipment. Devices connected to external input terminals can be labeled for easier identification during the input selection. (Input select (p. 21)) Terminals: HDMI 1-2/Component/Video/PC Label: [BLANK] Blu-ray/CABLE/SATELLITE/DVD/DVD REC/DVR/GAME/HOME THTR/RECEIVER/COMPUTER/MEDIA CTR/MEDIA EXT/VCR/CAMERA/MONITOR/AUX/OTHER/Not used • You can also enter the label name directly. (Entering characters (p. 19))	
<b>Anti Image retention</b> (Prevent Image retention)	<b>Pixel orbiter</b> (Wobbling)	<b>Enable/Disable</b> Enable: Shifts the display image automatically.
	<b>4:3 side bars</b> (4:3 mode only)	<b>Off/Dark/Mid/Bright</b> Changes the brightness of the side bar The recommended setting is "Bright" to prevent the panel "Image retention". (p. 53)
	<b>Scrolling bar</b>	Press "OK" to start the horizontal "Scrolling" on the screen. • Press any key except the POWER key to return to previous screen. • You will return to the previous screen if no key operation has been performed for 15 minutes.
		<div style="text-align: right;">[Scrolling bar]</div> 
<b>Network settings</b>	See p. 36-38 for more detail.	
<b>VIERA Link settings</b>	See p. 30-31 for more detail.	
<b>ECO/energy saving</b>	<b>No signal for 10 minutes</b> (Stay on/ Power TV off)	To conserve energy, the TV automatically turns off when NO SIGNAL and NO OPERATION continue for more than 10 minutes. • Not in use when "Auto power on" is set to "Yes", or "On/Off Timer" is set. • "No signal for 10 minutes was activated" will be displayed for about 10 seconds when the TV is turned on for the first time after the power was turned off by "No signal for 10 minutes". • The on-screen display will flash 3, 2 and 1 to indicate the last three (3) remaining minutes prior to the shut-off.
	<b>No activity for 3 hours</b> (Stay on/ Power TV off)	To conserve energy, the TV automatically turns off when no operation of remote and side panel key continues for more than 3 hours. • Not in use when "Auto power on" is set to "Yes", or "On/Off Timer" is set, or while "PC input" is selected. • "No activity for 3 hours was activated" will be displayed for about 10 seconds when the TV is turned on for the first time after the power was turned off by "No activity for 3 hours". • The on-screen display will flash 3, 2 and 1 to indicate the last three (3) remaining minutes prior to the shut-off.
<b>Keyboard type</b>	Select keyboard type. Operate USB keyboard (p. 19) <b>(U.S./Canadian French/Canadian Multilingual Standard/Spanish (Latin America)/Spanish (Spain))</b>	
<b>Advanced setup</b>	<b>Auto power on</b> (No/Yes)	Turns TV On automatically when the cable box or connected device is turned On. TV AC cord must be plugged into this device. TV turns on every time the power is restored.
	<b>Image viewer auto play</b>	<b>Slideshow/Photos/Videos/Music/ Set later/Off</b> Sets the media contents or playback type to play back SD cards automatically. Set later: "Image viewer settings" menu will be displayed repeatedly. "Using Media player" (p. 22)
<b>First time setup</b>	Restarts the first time setup from "Language" setting. (p. 13)	
<b>About</b>	Displays TV version and software license.	
<b>Reset to defaults</b>	Performing Reset will clear all settings made with Setup, such as channel settings. • Password setting/entering (p. 19)	

# Ratings List for parental control

“V-chip” technology enables you to lock channels or shows according to standard ratings set by the entertainment industry.

## ■ U.S. MOVIE RATINGS (MPAA)

NR	NO RATING (NOT RATED) AND NA (NOT APPLICABLE) PROGRAMS. Movie which has not been rated or where rating does not apply.
G	GENERAL AUDIENCES. All ages admitted.
PG	PARENTAL GUIDANCE SUGGESTED. Some material may not be suitable for children.
PG-13	PARENTS STRONGLY CAUTIONED. Some material may be inappropriate for children under 13.
R	RESTRICTED. Under 17 requires accompanying parent or adult guardian.
NC-17	NO ONE 17 AND UNDER ADMITTED.
X	ADULTS ONLY.

## ■ U.S. TV PROGRAMS RATINGS (U. S. TV)

Age-based Group	Age-based Ratings	Possible Content Selections	Description
NR (Not Rated)	TV-NR	<ul style="list-style-type: none"> <li>Viewable</li> <li>Blocked</li> </ul>	Not Rated.
Youth	TV-Y	<ul style="list-style-type: none"> <li>Viewable</li> <li>Blocked</li> </ul>	All children. The themes and elements in this program are specifically designed for a very young audience, including children from ages 2-6.
	TV-Y7	<ul style="list-style-type: none"> <li>FV Blocked</li> <li>Viewable</li> <li>Blocked</li> </ul>	Directed to older children. Themes and elements in this program may include mild physical or comedic violence, or may frighten children under the age of 7.
Guidance	TV-G	<ul style="list-style-type: none"> <li>Viewable</li> <li>Blocked</li> </ul>	General audience. It contains little or no violence, no strong language, and little or no sexual dialogue or situations.
	TV-PG	<ul style="list-style-type: none"> <li>D,L,S,V (all selected)</li> <li>Any combination of D, L, S, V</li> </ul>	Parental guidance suggested. The program may contain infrequent coarse language, limited violence, some suggestive sexual dialogue and situations.
	TV-14	<ul style="list-style-type: none"> <li>D,L,S,V (all selected)</li> <li>Any combination of D, L, S, V</li> </ul>	Parents strongly cautioned. This program may contain sophisticated themes, sexual content, strong language and more intense violence.
	TV-MA	<ul style="list-style-type: none"> <li>L,S,V (all selected)</li> <li>Any combination of L, S, V</li> </ul>	Mature audiences only. This program may contain mature themes, profane language, graphic violence, and explicit sexual content.

FV: Fantasy/Cartoon Violence. V: Violence S: Sex L: Offensive Language D: Dialogue with sexual content.

## ■ CANADIAN ENGLISH RATINGS (C. E. L. R.)

E	Exempt - Exempt programming includes: news, sports, documentaries and other information programming, talk shows, music videos, and variety programming.
C	Programming intended for children under age 8. No offensive language, nudity or sexual content.
C8+	Programming generally considered acceptable for children 8 years and over. No profanity, nudity or sexual content.
G	General programming, suitable for all audiences.
PG	Parental Guidance suggested. Some material may not be suitable for children.
14+	Programming contains themes or content which may not be suitable for viewers under the age of 14. Parents are strongly cautioned to exercise discretion in permitting viewing by pre-teens and early teens.
18+	18+ years old. Programming restricted to adults. Contains constant violence or scenes of extreme violence.

## ■ CANADIAN FRENCH RATINGS (C. F. L. R.)

E	Exempt - Exempt programming.
G	General - Programming intended for audience of all ages. Contains no violence, or the violence content is minimal or is depicted appropriately.
8 ans+	8+ General - Not recommended for young children. Programming intended for a broad audience but contains light or occasional violence. Adult supervision recommended.
13 ans+	Programming may not be suitable for children under the age of 13. Contains either a few violent scenes or one or more sufficiently violent scenes to affect them. Adult supervision strongly suggested.
16 ans+	Programming may not be suitable for children under the age of 16. Contains frequent scenes of violence or intense violence.
18 ans+	Programming restricted to adults. Contains constant violence or scenes of extreme violence.

### Caution

- The V-Chip system that is used in this set is capable of blocking “NR” programs (non rated, not applicable and none) as per FCC Rules Section 15.120(e)(2). If the option of blocking “NR” programs is chosen “unexpected and possibly confusing results may occur, and you may not receive emergency bulletins or any of the following types of programming.”
  - Emergency Bulletins (Such as EAS messages, weather warnings and others)
  - Locally originated programming • News • Political • Public Service Announcements • Religious • Sports • Weather

# Technical Information

## Aspect Ratio (FORMAT)

Press the **FORMAT** button to cycle through the aspect modes. This lets you choose the aspect depending on the format of the received signal and your preference. (p. 18)

(e.g.: in case of 4:3 image)

### ● FULL

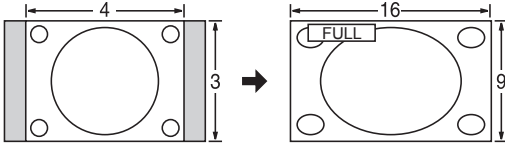

Enlarges the 4:3 image horizontally to the screen's side edges. (Recommended for anamorphic picture)

### ● JUST

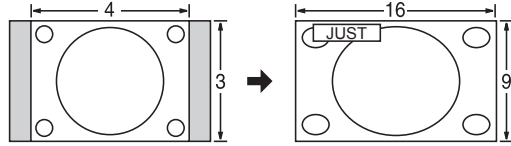

Stretches to justify the 4:3 image to the four corners of the screen.

(Recommended for normal TV broadcast)

### ● H-FILL

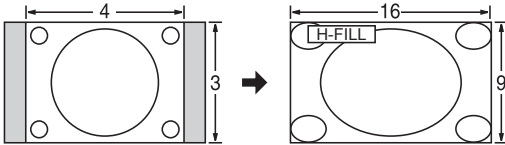

Enlarges the 4:3 image horizontally to the screen's side edges. The side edges of the image are cut off.

### ● 4:3

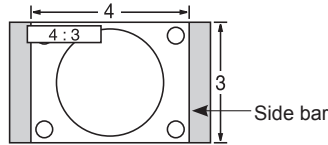

Standard

(Note that "Image retention" of the side bar may occur from displaying it for a long time.)

### ● ZOOM

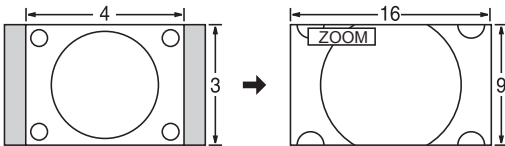

Enlarges the 4:3 image to the entire screen. (Recommended for Letter Box)

### Note

- 480i (4:3), 480i (16:9), 480p (4:3), 480p (16:9):  
FULL, JUST, 4:3 or ZOOM
- 1080p / 1080i / 720p:  
FULL, H-FILL, JUST, 4:3 or ZOOM

### ● Zoom adjustments

Vertical image position and size can be adjusted in "ZOOM".

① Select "Zoom adjustments" on the "Picture" menu. (p. 45)

② V-position: Vertical position adjustment

③ V-size: Vertical size adjustment

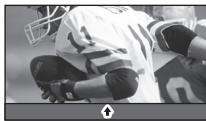

● To reset the aspect ratio →  (OK)

## H size

### ● Aspect Ratio: 4:3

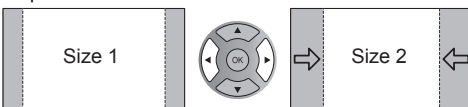

● The width will be decreased on both sides to reduce noise.

### ● Aspect Ratio: FULL/JUST(H-FILL/ZOOM)

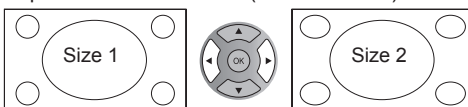

● The width will be increased on both sides to reduce noise.

See page 45 for more information

## Data format information

- Compatible Data format for Media player (SD card/USB flash memory)/DLNA → p. 26
- DCF (Design rule for camera file system): A Japan Electronics and Information Technology Industries Association's standard
- EXIF: Exchangeable Image File Format
- WMV9: Windows Media Video version 9
- WMA9: Windows Media Audio version 9

### Note

- Format the card with the recording equipment.
- The picture may not appear correctly on this TV depending on the recording equipment used.
- Display may take some time when there are many files and folders.
- The function (VIERA Image Viewer/Media player) cannot display Motion JPEG and still image not DCF formatted (i.e. TIFF, BMP).
- Data modified with a PC may not be displayed.
- Images imported from a PC must be compatible with EXIF 2.0, 2.1 and 2.2.
- Partly degraded files might be displayed at a reduced resolution.
- All ".JPG" extension data in the card and USB flash memory will be read in Photo viewer Mode.
- The folder and file names may be different depending on the digital camera used.
- Do not use two-byte characters or other special codes.
- The card may become unusable with this TV if file or folder names are changed.
- For the suitable SD Memory Cards, please confirm the latest information on the following website.  
<http://panasonic.jp/support/global/cs> (This site is in English only)

## Cautions when handling SD Cards

- Use an SD Card which meets SD standards. If not, it may cause the TV to malfunction.
- Do not remove the card while the unit is accessing data (this can damage card or unit).
- Do not touch the terminals on the back of the card.
- Do not subject the card to high pressure or impact.
- Insert the card in the correct direction (otherwise, card or unit may be damaged).
- Electrical interference, static electricity or erroneous operation may damage the data or card.
- Back up the recorded data at regular intervals in case of deteriorated or damaged data or erratic operation of the unit. (Panasonic is not liable for any deterioration or damage of recorded data.)

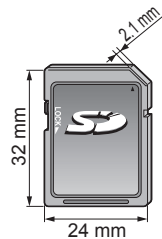

## SD Card/USB flash memory warning messages

Message	Meaning
No media. Please insert an SD memory card or USB storage device.	● The device is not inserted.
No media. Device removed.	● The device is removed.
No photos/ No movies/No music files to play/ No playable media	● The device has no data or this type of data is not supported.
Cannot read file	<ul style="list-style-type: none"> <li>● The file is broken or unreadable.</li> <li>● The TV does not support the format.</li> </ul>

## Recommended USB device connections

Number of USB device	Connections (Recommended)	Memory	A/B: each USB terminal	
			Wireless LAN adapter	Keyboard
1	A: Flash memory	A		
	A: Wireless LAN adapter		A	
	A: Keyboard			A
2	A: Flash memory B: Keyboard	A		B
	A: Wireless LAN adapter B:Keyboard		A	B
	A: Flash memory B:Wireless LAN adapter	A	B	

## VIERA Link™ “HDAVI Control™”

HDMI connections to some Panasonic equipment allow you to interface automatically. (p. 29)

- This function may not work normally depending on the equipment condition.
- The equipment can be operated by other remote controls with this function on even if the TV is in Standby mode.
- Image or sound may not be available for the first few seconds when playback starts.
- Image or sound may not be available for the first few seconds when input mode is switched.
- Volume function will be displayed when adjusting the volume of the equipment.
- If you connect equipment that has “HDAVI Control 2 or later” function to the TV with an HDMI cable, the sound from the DIGITAL AUDIO OUT terminal can be output as multi-channel surround.
- “HDAVI Control 5” is the newest standard (current as of December, 2010) for the HDAVI Control compatible equipment. This standard is compatible with the conventional HDAVI equipment.

## HDMI connection

HDMI (high-definition multimedia interface) allows you to enjoy high-definition digital images and high-quality sound by connecting the TV unit and HD devices.

HDMI-compatible equipment (\*1) with an HDMI or DVI output terminal, such as a Cable or Satellite box or a DVD player, can be connected to the HDMI connector using an HDMI compliant (fully wired) cable.

- HDMI is the world's first complete digital consumer AV interface complying with a non-compression standard.
  - If the external equipment has only a DVI output, connect to the HDMI terminal via a DVI to HDMI adapter cable (\*2).
  - When the DVI to HDMI adapter cable is used, connect the audio cable to the audio input terminal.
  - Audio settings can be made on the “HDMI 1 in” or “HDMI 2 in” menu screen. (p. 46)  
Applicable audio signal sampling frequencies (L.PCM): 48 kHz, 44.1 kHz, 32 kHz
- (\*1): The HDMI logo is displayed on an HDMI-compliant device.  
(\*2): Enquire at your local digital equipment retailer shop.

### Caution

- Use with a PC is not assumed.
- All signals are reformatted before being displayed on the screen.
- If the connected device has an aspect adjustment function, set the aspect ratio to “16:9”.
- These HDMI connectors are “type A”.
- These HDMI connectors are compatible with HDCP (High-Bandwidth Digital Content Protection) copyright protection.
- A device having no digital output terminal may be connected to the input terminal of either “COMPONENT”, or “VIDEO” to receive analog signals.
- The HDMI input terminal can be used with only the following image signals: 480i, 480p, 720p, 1080i and 1080p. Match the output setting of the digital device.
- For details of the applicable HDMI signals, see p. 53.

## DIGITAL AUDIO OUT terminal

You can enjoy your Home theater by connecting a Dolby Digital (5.1 channel) decoder and “Multi Channel” amplifier to the DIGITAL AUDIO OUT terminals.

### Caution

- Depending on your DVD player and DVD-Audio software the copyright protection function may operate and disable optical output.
- When an ATSC channel is selected, the output from the DIGITAL AUDIO OUT jack will be Dolby Digital. When an NTSC channel is selected, the output will be PCM.
- When playing a movie on SD Card Movie player, when the sound has been recorded in Dolby Digital, the output from the DIGITAL AUDIO OUT terminal will be Dolby Digital. When the sound is recorded in other formats, the output will be PCM.

## Closed Caption (CC)

- For viewing the CC of digital broadcasting, set the aspect to FULL (If viewing with H-FILL, JUST, ZOOM or 4:3; characters might be cut off).
- The CC can be displayed on the TV only when the receiver (such as a Cable box or satellite receiver) has the CC set to ON within the device itself. Check with your Cable or Satellite provider for instructions. The TV's CC button does not operate the Satellite or Cable box's CC function.
- If the CC is set to On on both the receiver and TV when the signal is 480i (except for the HDMI connection), the CC may overlap on the TV.
- If a digital program is being output in analog format, the CC data will also be output in analog format.
- If the recorder or output monitor is connected to the TV, the CC needs to be set up on the recorder or output monitor.

## 4:3 side bars

Do not display a picture in 4:3 mode for an extended period, as this can cause "Image retention" to remain on either or both sides of the display field. To reduce the risk of such "Image retention", change the brightness of the side bars.

See page 48 for more information

- The side bar may flash (alternate black/white) depending on the picture.

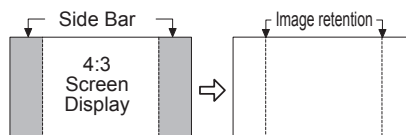

## PC Input Terminals

- Signal Names for D-sub 15P Connector

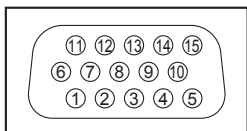

Pin Layout for PC Input Terminal

Pin No.	Signal Name	Pin No.	Signal Name	Pin No.	Signal Name
①	R	⑥	GND (Ground)	⑪	NC (not connected)
②	G	⑦	GND (Ground)	⑫	NC
③	B	⑧	GND (Ground)	⑬	HD/SYNC
④	NC (not connected)	⑨	NC (not connected)	⑭	VD
⑤	GND (Ground)	⑩	GND (Ground)	⑮	NC

## Input signal that can be displayed

\* Mark: Applicable input signal for Component (Y, P<sub>B</sub>, P<sub>R</sub>), HDMI and PC

	horizontal frequency (kHz)	vertical frequency (Hz)	COMPONENT	HDMI	PC
525 (480) / 60i	15.73	59.94	*	*	
525 (480) /60p	31.47	59.94	*	*	
750 (720) /60p	45.00	59.94	*	*	
1,125 (1,080) /60i	33.75	59.94	*	*	
1,125 (1,080)/60p	67.43	59.94		*	
1,125 (1,080)/60p	67.50	60.00		*	
1,125(1,080)/24p	26.97	23.98		*	
1,125(1,080)/24p	27.00	24.00		*	
640 × 400 @70	31.47	70.08			*
640 × 480 @60	31.47	59.94			*
Macintosh13" (640 × 480)	35.00	66.67			*
640 × 480 @75	37.50	75.00			*
852 × 480 @60	31.44	59.89			*
800 × 600 @60	37.88	60.32			*
800 × 600 @75	46.88	75.00			*
800 × 600 @85	53.67	85.08			*
Macintosh16" (832 × 624)	49.73	74.55			*
1,024 × 768 @60	48.36	60.00			*
1,024 × 768 @70	56.48	70.07			*
1,024 × 768 @75	60.02	75.03			*
1,024 × 768 @85	68.68	85.00			*
Macintosh 21" (1,152 × 870)	68.68	75.06			*
1,280 × 768 @60	47.78	59.87			*
1,280 × 1,024 @60	63.98	60.02			*
1,366 × 768 @60	48.39	60.04			*

### Note

- Signals other than above may not be displayed properly.
- The above signals are reformatted for optimal viewing on your display.
- Computer signals which can be input are those with a horizontal scanning frequency of 15 to 110 kHz and vertical scanning frequency of 48 to 120 Hz. (However, the image will not be displayed properly if the signals exceed 1,200 lines.)

# Frequently Asked Questions (FAQ)

If there is a problem with your TV, please refer to the table below to determine the symptoms, then carry out the suggested check. If this does not solve the problem, visit the Panasonic web site for further assistance. (see cover)

Questions	Answers
<b>How do I view the picture from devices such as a: Cable/Satellite box, game console, Blu-ray or DVD player?</b>	<ul style="list-style-type: none"><li>● Press the INPUT button on the remote to select the correct input source.</li><li>● Check that the device is turned on and functioning correctly.</li></ul>
<b>Why is there no picture or just a blue, black or snowy screen being displayed?</b>	<ul style="list-style-type: none"><li>● Check if the power cord is plugged in and the TV is turned on (front red LED light should be on; not blinking)</li><li>● Press the INPUT button on the remote to select the correct input source.</li><li>● Ensure all connections are correct and secure.</li><li>● When using external video source, such as a Cable/Satellite box or DVD player, check that the device is on and functioning correctly.</li><li>● Press MENU on the TV's remote control. If the menu is displayed, then the TV is working; recheck above steps.</li></ul>
<b>Why doesn't the picture look like it is in High Definition?</b>	<ul style="list-style-type: none"><li>● Press the INFO button on the remote to confirm the type of signal being received (p. 17). HD signal should be 720P, 1080i or 1080p.</li><li>● Select a High Definition channel from your HD source (Cable, Satellite or fiber optic service). HD channels sometimes broadcast non-HD content.</li><li>● Ensure that your HD source (HD box, Blu-ray player, etc.) is connected to the TV with an HDMI or Component cable and set to output an HD video signal.</li></ul>
<b>Why do black bars appear on the top and bottom and/or sides of the screen?</b>	<ul style="list-style-type: none"><li>● Change the format (aspect ratio) of the picture by pressing the FORMAT button on the remote control. (p. 18)</li><li>● Check the aspect settings on your external video source, such as Cable/Satellite box, DVD/Blu-ray Disc player, etc. Note: Some content, such as film-based movies, are available in extra-wide format. Top and bottom bars are unavoidable.</li></ul>
<b>Why is the picture snowy when "ANT/Cable in" is selected?</b>	<ul style="list-style-type: none"><li>● When using a cable service (without a box), check that all connections are secure.</li><li>● When using a cable or satellite box, change the connection (wiring) to Composite, Component or HDMI. (p. 11)</li><li>● If you're using an antenna, then check that connections are secure. Change the position or direction of the antenna and check the "Signal meter". (p. 43)</li></ul>
<b>Why is the picture chaotic and/or torn and/or with a buzz in the speakers?</b>	<ul style="list-style-type: none"><li>● Check if electrical products such as kitchen appliances, fluorescent lights or light dimmers are nearby. They may interfere with the TV's picture.</li><li>● Try viewing a picture from another device, such as a DVD player or a game console, to narrow down the source of the problem.</li></ul>
<b>Why is there a black box on the screen?</b>	<ul style="list-style-type: none"><li>● Change settings of Closed Caption (CC). (p. 17, 47)</li></ul>
<b>Why is the screen blank and the power indicator blinking?</b>	<ul style="list-style-type: none"><li>● The TV has gone into shutdown mode to protect itself. Try unplugging it for a few minutes and connecting it again. If there was a temporary power surge on the AC line it may now be OK. If the blinking returns, please contact your local Panasonic dealer or Panasonic Service Center for assistance. (p. 59)</li></ul>
<b>Why do some small spots on the screen remain bright or dark?</b>	<ul style="list-style-type: none"><li>● The Plasma panel is made up of a few million pixels and is produced with advanced technology through an intricate process. Sometimes a few pixels may be bright or dark. These pixels do not indicate a defective panel and will have no impact on the performance of the TV.</li></ul>

Picture



## Questions

## Answers

### Sound

**Why is there no sound coming from the TV?**

- Make sure the volume is up and MUTE is off.
- Confirm the TV speakers are set to ON by pressing MENU and selecting "Audio" --> "Advanced audio". (p. 46)
- Check that the correct SAP (Secondary Audio Program) is selected by pressing the SAP button on the remote control. (p. 17)
- If the TV is connected to a Panasonic Home Theater via HDMI cable, then check VIERA Link controls. (p. 33)
- If the TV is connected to a Home Theater via optical cable, then: Check the connection, the audio system is on, the correct input is selected.
- Check "HDMI 1 in" or "HDMI 2 in" analog/digital audio settings. (p. 46)

**Why is the sound unusual, distorted, low volume or in another language?**

- Check that the correct SAP (Secondary Audio Program) is selected by pressing the SAP button on the remote control.
- Check that all connections of external equipment connected to the TV are secure.
- When using Cable or Satellite box, check the device's audio settings. (example: try changing the box's Audio Range to 'narrow')

**Why is there a clicking, ticking or buzzing sound coming from the TV unit?**

- When TV power is turned on or shut off there are electrical components that make a click sound. This is normal operation.
- Changes in the temperature and humidity of the room may cause thermal expansion and contraction that can produce sounds. This is not a sign of faulty operation or a malfunction.

**What is the easiest and best way to connect a High-Definition Cable or Satellite box to the TV?**

- Use an HDMI cable. It carries both digital video and audio signal in HD. HDMI cable is the only cable needed to connect an HD device to the TV.

**Why does the CC button not display Closed Caption?**

- When viewing TV via an HDMI connected device, such as a Cable or Satellite box, CC must be enabled at the device.
- Closed Caption is available only at supported TV programming.

**Why does the screen and back cover of the TV get warm?**

- The main unit radiates heat and some of the parts may become hot. This is normal operation and does not affect the performance of the set.
- Ensure good ventilation.
- Do not block the ventilation holes of the TV and do not place the TV on top of other equipment.

**Why doesn't the Remote Control work?**

- Check that the batteries are fresh, are of the same type and are installed with the correct polarity (+ & -).
- To operate other devices, such as changing channels when using Cable or Satellite boxes or operating non-Panasonic Blu-ray players, use the remote supplied with the device.

**Why is the "ANT/Cable" option at the top of the "Input select" menu gray-out and cannot be selected?**

- During "First time setup", you indicated in step ③-① that you are using Cable or Satellite box and in step ③-②b that the box is connected to one of the TV's AV inputs. In this case, the Antenna/Cable input is deactivated to prevent unintentional switching into unused tuner. To re-activate, press MENU, select SETUP and repeat "First time setup".

**Some menu items are grayed-out and cannot be selected. Why?**

- Depending on certain modes or the selected input, some options are not available. For example, Zoom adjustments are only available when the FORMAT is changed to zoom mode.

### Other



	Questions	Answers
<b>Networking</b>	<b>How do I get EASY IPTV to work on my TV?</b>	<ol style="list-style-type: none"> <li>1. You need a broadband (high speed) Internet service with a speed of no less than 1.5 Mbps (p. 35).</li> <li>2. Connect the TV to the Internet through your router by an Ethernet cable or a compatible Panasonic USB wireless adapter.</li> <li>3. Run the "Connections Test", under the Network Settings menu. If Connection test fails, then check with your Internet service provider or router/modem manufacturer if there are firewall, content filter or proxy settings that may block the TV from accessing the Internet.</li> </ol>
	<b>How do I check for the latest software (firmware) version for my TV?</b>	<ul style="list-style-type: none"> <li>● In the main menu, select "Setup". Highlight "Network Settings" and press OK. Select "Software Update". The current version and latest version software will be shown. If software update is "grayed out", the TV is not connected to the Internet. If newer version is available, update your TV. Follow the on-screen instructions, do not power off the TV until the update is complete. Be patient; firmware update may take a while.</li> </ul>
	<b>Can I use any USB WiFi adapter to connect the TV to my wireless network?</b>	<ul style="list-style-type: none"> <li>● The TV's internal software was designed to work with Panasonic's wireless adapter model DY-WL10*. Check <a href="http://www.panasonic.com/NetConnect">www.panasonic.com/NetConnect</a> for updated information.</li> </ul>
	<b>How do I reset my TV to all factory defaults and settings?</b>	<ul style="list-style-type: none"> <li>● In the main menu, select "Setup". Highlight "Reset to Defaults" and press OK. Enter your password (if created earlier) or create a temporary new password. Select Yes to reset the TV.</li> </ul>

\* Model number is subject to change without notice.

# Care and Cleaning

**First, unplug the Power cord plug from the wall outlet.**

## Display panel

The front of the display panel has been specially treated. Wipe the panel surface gently using only a cleaning cloth or a soft, lint-free cloth.

- If the surface is particularly dirty, soak a soft, lint-free cloth in diluted mild liquid dish soap (1 part mild liquid dish soap diluted by 100 times the amount of water) and then wring the cloth to remove excess liquid. Use this cloth to wipe the surface of the display panel, then wipe it evenly with a dry cloth of the same type until the surface is dry.
- Do not scratch or hit the surface of the panel with fingernails or other hard objects. Furthermore, avoid contact with volatile substances such as insect sprays, solvents, and thinner; otherwise, the quality of the surface may be adversely affected.

## Cabinet

If the cabinet becomes dirty, wipe it with a soft, dry cloth.

- If the cabinet is particularly dirty, soak the cloth in a weak mild liquid dish soap and then wring the cloth dry. Use this cloth to wipe the cabinet and then wipe it dry with a dry cloth.
- Do not allow any mild liquid dish soap to come into direct contact with the surface of the Plasma TV. If water droplets get inside the unit, operating problems may result.
- Avoid contact with volatile substances such as insect sprays, solvents, and thinner; otherwise, the quality of the cabinet surface may be adversely affected or the coating may peel off.
- Do not let articles made from rubber or PVC be in contact with the TV for long periods of time.

## Pedestal

### ● Cleaning

- Wipe the surfaces with a soft, dry cloth. If the unit is particularly dirty, clean it using a cloth soaked with water to which a small amount of mild liquid dish soap has been added and then wipe with a dry cloth.  
Do not use products such as solvents, thinner, or household wax for cleaning, as they can damage the surface coating. (If using a chemically-treated cloth, follow the instructions supplied with the cloth.)
- Do not attach sticky tape or labels, as they can make the surface of the pedestal dirty. Do not allow long-term contact with rubber, vinyl products, or the like. (Doing so will cause deterioration.)

# Specifications

		TC-42PX34X	TC-50PX34X
<b>Power Source</b>		AC 110-127 V, 60 Hz	
<b>Power Consumption</b>	<b>Rated Power Consumption</b>	199 W	262 W
	<b>Standby condition</b>	0.2 W	0.2 W
<b>Plasma Display panel</b>	<b>Drive method</b>	AC type	
	<b>Aspect Ratio</b>	16:9	
	<b>Visible screen size (W × H × Diagonal)</b>	42" class (41.6 inches measured diagonally)	50" class (49.9 inches measured diagonally)
	<b>(No. of pixels)</b>	36.2" × 20.4" × 41.6" (921 mm × 518 mm × 1,057 mm)	43.5" × 24.4" × 49.9" (1,105 mm × 622 mm × 1,268 mm)
<b>Sound</b>	<b>Audio Output</b>	20 W [10 W + 10 W] (10 % THD)	
	<b>PC signals</b>	VGA, SVGA, XGA, WXGA, SXGA Horizontal scanning frequency 31 - 69 kHz Vertical scanning frequency 59 - 86 Hz	
<b>Channel Capability (Digital/Analog)</b>		VHF/ UHF: 2 - 69, CATV: 1 - 135	
<b>Operating Conditions</b>		Temperature: 32 °F – 104 °F (0 °C – 40 °C) Humidity: 20 % – 80 % RH (non-condensing)	
<b>Connection Terminals</b>	<b>VIDEO IN</b>	VIDEO: RCA PIN Type × 1 1.0 V [p-p] (75 Ω) AUDIO L-R: RCA PIN Type × 2 0.5 V [rms]	
	<b>COMPONENT IN</b>	Y: 1.0 V [p-p] (including synchronization) P <sub>B</sub> , P <sub>R</sub> : ±0.35 V [p-p] AUDIO L-R: RCA PIN Type × 2 0.5 V [rms]	
	<b>HDMI 1-2</b>	TYPE A Connector × 2 ● This TV supports "HDAVI Control 5" function.	
	<b>PC</b>	D-SUB 15PIN: R,G,B / 0.7 V [p-p] (75 Ω) HD, VD / 1.0 - 5.0 V [p-p] (high impedance)	
	<b>USB 1-2</b>	USB 2.0 Type A connector x 2 (DC5V MAX500mA)	
	<b>LAN (for IPTV)</b>	RJ45 (10BASE-T/100BASE-TX)	
	<b>Card slot</b>	SD CARD slot × 1	
	<b>DIGITAL AUDIO OUT</b>	PCM / Dolby Digital, Fiber Optic	
<b>FEATURES</b>		3D Y/C FILTER V-Chip VIERA IMAGE VIEWER	CLOSED CAPTION EASY IPTV Media player HDAVI Control 5
<b>Dimensions (W × H × D)</b>	<b>Including pedestal</b>	40.3" × 26.8" × 12.1" (1,023 mm × 679 mm × 307 mm)	47.8" × 31.3" × 14.1" (1,212 mm × 793 mm × 357 mm)
	<b>TV Set only</b>	40.3" × 25.1" × 3.4" (3.7") (1,023 mm × 637 mm × 85 mm (93 mm))	47.8" × 29.5" × 3.4" (3.7") (1,212 mm × 747 mm × 85 mm (93 mm))
<b>Mass</b>	<b>Including pedestal</b>	51.9 lb. (23.5 kg)	69.5 lb. (31.5 kg)
	<b>TV Set only</b>	49.7 lb. (22.5 kg)	66.2 lb. (30.0 kg)

[TC-42PX34X]

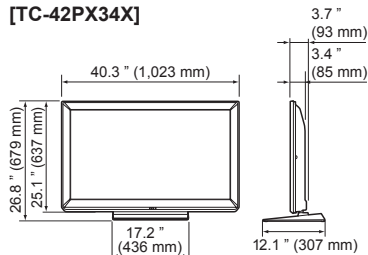

[TC-50PX34X]

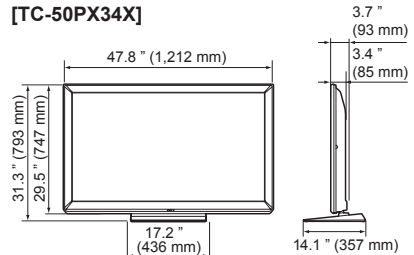

**Note**

● Design and Specifications are subject to change without notice. Mass and Dimensions shown are approximate.

● Frequently Asked Questions (FAQ) / ● Care and Cleaning ● Specifications

Support Information

# Index

<b>A</b>	Accessories .....	7
	Ant/Cable .....	14,42
	Antenna .....	10,14
	Audio.....	46
	Audio, Advanced .....	46
	Auto Power ON.....	48
	Auto Program.....	42
<b>B</b>	Battery .....	9
<b>C</b>	Cable .....	10,11
	Care & Cleaning .....	56
	CC Closed Caption .....	17,47,52
	Channel .....	14,17-18,42-43
	Channel Surf Mode.....	18,48
	Clock.....	15,48
	Colored Buttons .....	12
	Component .....	11,57
	Composite.....	11
	Connections.....	10-11
	Customer Service Directory.....	59
<b>D</b>	DLNA .....	20,34,40
<b>E</b>	EASY IPTV .....	34,39
	ECO/energy .....	20,48
	Exit.....	12
<b>F</b>	FAQ's .....	54-56
	Favorite.....	18
	First Time Setup.....	13-16,48
	Format .....	18,50
<b>H</b>	HDAVI Control.....	28
	HDMI.....	11,52,57
	Home Use.....	13
<b>I</b>	Image Viewer Auto.....	48
	Info.....	17
	Input.....	21,48
<b>L</b>	Language.....	13,48
	Last.....	12
	Lock / Parental control .....	47,49
<b>M</b>	Media player .....	20,22-27
	Menu .....	44
	Movies/Video .....	26
	Music .....	27
	Mute.....	12
<b>N</b>	Network camera.....	33-35,38,41
	Network services .....	15,34-38,48
<b>P</b>	Pedestal.....	7,8
	Photo .....	24-25
	Picture, Advanced.....	46
	Picture settings .....	45
	Power.....	12
<b>R</b>	Remote Control.....	12
	Reset .....	48
<b>S</b>	Safety.....	4
	SAP.....	17
	Scan.....	14,42
	SD Card .....	22,51
	Signal Meter.....	43
	Sleep.....	46
	Specifications.....	57
	Store Demonstration.....	13
	Sub menu .....	18
<b>T</b>	Technical Information.....	50-53
	Timer.....	46
<b>U</b>	USB .....	22,51,57
<b>V</b>	VIERA Link.....	20,28-33
	VIERA TOOLS .....	20
	Viewing contents.....	23
	Volume.....	12
<b>W</b>	Watching TV, DVD, Blu-ray, etc. ....	17,21
	Wireless LAN Adapter.....	16,35
<b>Z</b>	Zoom.....	18,50

## Customer Service

### Customer Service Directory

Obtain products information and operative assistant; localize the closer distributor or Service Center; buy spare parts and accessories by our web site to Latin American:

**<http://www.lar.panasonic.com>**

Also you may contact us directly by our Contact Center:

<b>Panama</b>	<b>800-PANA (800-7262)</b>
<b>Colombia</b>	<b>01-8000-94PANA (01-8000-947262)</b>
<b>Ecuador</b>	<b>1800-PANASONIC (1800-726276)</b>
<b>Costa Rica</b>	<b>800-PANA737 (800-7262737)</b>
<b>El Salvador</b>	<b>800-PANA (800-7262)</b>
<b>Guatemala</b>	<b>1-801-811-PANA (1-801-811-7262)</b>
<b>Chile</b>	<b>800-390-602</b> <b>From a cell phone: 797-5000</b>
<b>Venezuela</b>	<b>800-PANA-800 (800-7262-800)</b>
<b>Uruguay</b>	<b>0-800-PANA (0-800-7262)</b>
<b>Peru</b>	<b>0800-00726</b>
<b>Argentina</b>	<b>0800-333-PANA (0800-333-7262)</b> <b>0810-321-PANA (0810-321-7262)</b>

### Mexico Service

To obtain information in the Republic of Mexico contact us at:

**[email: atencion.clientes@mx.panasonic.com](mailto:atencion.clientes@mx.panasonic.com)**

Or you may contact us in the next following phones numbers:

**01800-VIP-PANA (01800-847-7262) - Interior**  
**(55) 5000-1200 - Mexico D.F. and Metropolitan Area**