



The terms HDMI and HDMI High-Definition Multimedia Interface, and the HDMI logo are trademarks or registered trademarks of HDMI Licensing LLC in the United States and other countries.



Manufactured under license from Dolby Laboratories. Dolby and the double-D symbol are trademarks of Dolby Laboratories.

Contents

- Contents1
- Safety Precautions2
- Accessories/Optional Accessories6
- Connections9
- Identifying Controls13
- First Time Setup15
- Customizing TV Settings16
- Frequently Asked Questions (FAQ)25
- Care and Cleaning26
- Specifications27
- TERMS AND CONDITIONS OF USE and PRIVACY POLICY29

Safety Precautions

Note to CATV System Installer

This reminder is provided to direct the CATV system installer's attention to Article 820-40 of the NEC that provides guidelines for proper grounding and, in particular, specifies that the cable ground shall be connected to the grounding system of the building, as close to the point of cable entry as practical.

Secure Ventilation

Slots and openings in the cabinet and the back or bottom are provided for ventilation, and to ensure reliable operation of the LCD TV and to protect it from overheating. These openings must not be blocked or covered. There should be at least 4 inches (10 cm) of space around the TV. The openings should never be blocked by placing the LCD TV on a bed, sofa, rug or other similar surface. This LCD TV should not be placed in a built-in installation such as a bookcase unless proper ventilation is provided.

Important Safety Instructions (TV set)

1. Read these instructions.
2. Keep these instructions.
3. Heed all warnings.
4. Follow all instructions.
5. Do not use this apparatus near water.
6. Clean only with dry cloth.
7. Do not block any ventilation openings. Install in accordance with the manufacturer's instructions.
8. Do not install near any heat sources such as radiators, heat registers, stoves or other apparatus (including amplifiers) that produce heat.
9. Do not defeat the safety purpose of the polarized or grounding-type plug. A polarized plug has two blades with one wider than the other. A grounding type plug has two blades and a third grounding prong. The wide blade or the third prong are provided for your safety. If the provided plug does not fit into your outlet, consult an electrician for replacement of the obsolete outlet.
10. Protect the power cord from being walked on or pinched particularly at plugs, convenience receptacles, and the point where they exit from the apparatus.
11. Only use attachments / accessories specified by the manufacturer.
12. Use only with the cart, stand, tripod, bracket or table specified by the manufacturer, or sold with the apparatus. When a cart is used, use caution when moving the cart / apparatus combination to avoid injury from tip-over.
13. Unplug this apparatus during lightning storms or when unused for long periods of time.
14. Refer all servicing to qualified service personnel. Servicing is required when the apparatus has been damaged in any way, such as power-supply cord or plug is damaged, liquid has been spilled or objects have fallen into the apparatus, the apparatus has been exposed to rain or moisture, does not operate normally, or has been dropped.
15. Please keep the unit in a well-ventilated environment.
16. **WARNING:** To reduce the risk of fire or electric shock, do not expose this apparatus to rain or moisture. The apparatus should not be exposed to dripping or splashing. Objects filled with liquids, such as vases should not be placed on apparatus.
17. **WARNING:** The batteries shall not be exposed to excessive heat such as sunshine, fire or the like.
18. **CAUTION:** The Power switch on this unit will not completely shut off all power from AC outlet. Since the power cord serves as the main disconnect device for the unit, you will need to unplug it from the AC outlet to shut down all power. Therefore, make sure the unit has been installed so that the power cord can be easily unplugged from AC outlet in case of an accident. To avoid fire hazard, the power cord should also be unplugged from the AC outlet when left unused for a long period of time (for example, when on vacation).
19. **WARNING:** To reduce the risk of electric shock, do not remove cover (or back) as there are no user-serviceable parts inside. Refer servicing to qualified personnel.



This lightning flash with arrowhead symbol within an equilateral triangle is intended to alert the user to the presence of non-insulated "dangerous voltage" within the product's enclosure that may be of sufficient magnitude to constitute a risk of electric shock.



The exclamation point within an equilateral triangle is intended to alert the user to the presence of important operating and maintenance instructions in the literature accompanying the appliance.



This equipment is a Class II or double insulated electrical appliance. It has been designed in such a way that it does not require a safety connection to electrical earth.



This product contains electrical or electronic materials. The presence of these materials may, if not disposed of properly, have potential adverse effects on the environment and human health. Presence of this label on the product means it should not be disposed of as unsorted waste and must be collected separately. As a consumer, you are responsible for ensuring that this product is disposed of properly.

20. Operate only from the type of power source indicated on the marking label. If you are not sure of the type of power supplied to your home, consult your television dealer or local power company.
21. Follow all warnings and instructions marked on the LCD TV.
22. Never push objects of any kind into this LCD TV through cabinet slots as they may touch dangerous voltage points or short out parts that could result in a fire or electric shock. Never spill liquid of any kind on the LCD TV.

23. If an outside antenna is connected to the television equipment, be sure the antenna system is grounded so as to provide some protection against voltage surges and built up static charges. In the U.S. Section 810-21 of the National Electrical Code provides information with respect to proper grounding of the mast and supporting structure, grounding of the lead-in wire to an antenna discharge unit, size of grounding conductors, location of antenna discharge unit, connection to grounding electrodes, and requirements for the grounding electrode.

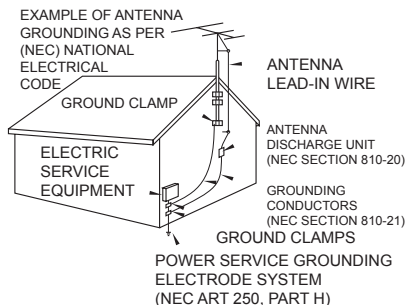

24. An outside antenna system should not be located in the vicinity of overhead power lines, other electric light, power circuits, or where it can fall into such power lines or circuits. When installing an outside antenna system, extreme care should be taken to keep from touching such power lines or circuits as contact with them might be fatal.
25. Unplug this LCD TV from the wall outlet and refer servicing to qualified service personnel under the following conditions:
 - a. When the power cord or plug is damaged or frayed.
 - b. If liquid has been spilled into the LCD TV.
 - c. If the LCD TV has been exposed to rain or water.
 - d. If the LCD TV does not operate normally by following the operating instructions.

Adjust only those controls that are covered by the operating instructions as improper adjustment of other controls may result in damage and will often require extensive work by a qualified technician to restore the LCD TV to normal operation.

- e. If the LCD TV has been dropped or the cabinet has been damaged.
- f. When the LCD TV exhibits a distinct change in performance - this indicates a need for service.
26. When replacement parts are required, be sure the service technician uses replacement parts specified by the manufacturer that have the same characteristics as the original parts. Unauthorized substitutions may result in fire, electric shock, or other hazards.

27. **WARNING: SMALL PARTS CAN PRESENT CHOKING HAZARD IF ACCIDENTALLY SWALLOWED. KEEP SMALL PARTS AWAY FROM YOUNG CHILDREN.**

DISCARD UNNEEDED SMALL PARTS AND OTHER OBJECTS, INCLUDING PACKAGING MATERIALS AND PLASTIC BAGS/SHEETS TO PREVENT THEM FROM BEING PLAYED WITH BY YOUNG CHILDREN, CREATING THE POTENTIAL RISK OF SUFFOCATION.

28. **WARNING: DO NOT USE THIS TV NEAR ANY AUTOMATIC CONTROL DEVICES SUCH AS AUTOMATIC DOORS OR FIRE ALARMS. RADIO WAVES FROM THIS TV MAY INTERFERE WITH THE AUTOMATIC CONTROL DEVICES AND CAUSE ACCIDENTS DUE TO THE MALFUNCTION.**

29. **WARNING: KEEP THIS TV AWAY AT LEAST 9 INCHES (22 CM) FROM THE LOCATION WHERE A CARDIAC PACEMAKER IS IMPLANTED. RADIO WAVES FROM THIS TV MAY INTERFERE WITH THE OPERATION OF THE PACEMAKER**

30. **CAUTION: TO PREVENT ELECTRIC SHOCK, DO NOT USE THIS PLUG WITH A RECEPTACLE OR OTHER OUTLET UNLESS THE BLADES CAN BE FULLY INSERTED TO PREVENT BLADE EXPOSURE.**

31. **CAUTION: USE WITH OTHER STAND MAY RESULT IN INSTABILITY POSSIBLY CAUSING INJURY.**

32. **CAUTION: DANGER OF EXPLOSION IF BATTERY IS INCORRECTLY REPLACED. REPLACE ONLY WITH THE SAME OR EQUIVALENT TYPE.**

33. **WARNING: To prevent fire ignition, keep candles or other open flames away from this product at all times.**

34. **WARNING: Do not place this TV in any medical institutions or locations with medical devices. Radio waves from this TV may interfere with medical devices and cause accidents due to the malfunction.**

FCC and IC STATEMENT

FCC Caution:

To assure continued compliance, follow the attached installation instructions and use only shielded interface cables when connecting to peripheral devices. Any changes or modifications not expressly approved by Panasonic Corp. of North America could void the user's authority to operate this device.

<Only for wireless LAN if capable of transmission in the 2.400 ~ 2.4835 GHz frequency band>
This product is restricted to indoor use due to its operation in the 2.400 to 2.4835 GHz frequency range. FCC and IC require this product to be used indoors for the frequency range 2.400 to 2.4835 GHz to reduce the potential for harmful interference to co-channel Mobile Satellite systems. These radar stations can cause interference with and/or damage this product.

Responsible Party:	Panasonic Corporation of North America Two Riverfront Plaza, Newark, NJ 07102-5490
Contact Source:	Panasonic Consumer Electronics Company 1-844-246-0582 www.panasonic.com/support

FCC STATEMENT

This device complies with Part 15 of the FCC Rules. Operation is subject to the following two conditions:

- (1) This device may not cause harmful interference, and
- (2) This device must accept any interference received, including interference that may cause undesired operation.

Changes or modifications not expressly approved by the party responsible for compliance could void the user's authority to operate the equipment.

NOTE: This equipment has been tested and found to comply with the limits for a Class B digital device, pursuant to Part 15 of the FCC Rules. These limits are designed to provide reasonable protection against harmful interference in a residential installation.

This equipment generates uses and can radiate radio frequency energy and, if not installed and used in accordance with the instructions, may cause harmful interference to radio communications. However, there is no guarantee that interference will not occur in a particular installation. If this equipment does cause harmful interference to radio or television reception, which can be determined by turning the equipment off and on, the user is encouraged to try to correct the interference by one or more of the following measures:

Reorient or relocate the receiving antenna.

Increase the separation between the equipment and receiver.

Connect the equipment into an outlet on a circuit different from that to which the receiver is connected.

Consult the dealer or an experienced radio/TV technician for help.

FCC Radiation Exposure Statement

This equipment complies with FCC radiation exposure limits set forth for an uncontrolled environment. This equipment should be installed and operated with minimum distance 20cm between the radiator & your body.

CEA CHILD SAFETY NOTICES

WARNING

Flat panel displays are not always supported on the proper stands or installed according to the manufacturer's recommendations. Flat panel displays that are inappropriately situated on dressers, bookcases, shelves, desks, speakers, chests, or carts may fall over and may cause personal injury or even death.

The consumer electronics industry (of which Panasonic is a member) is committed to making home entertainment enjoyable and safe. To prevent personal injury or death, be sure to follow the following safety guidelines:

TUNE INTO SAFETY:

- One size does NOT fit all. Follow the manufacturer's recommendations for the safe installation and use of your flat panel display.
- Carefully read and understand all enclosed instructions for proper use of this product.
- Don't allow children to climb on or play with furniture and television sets.
- Don't place flat panel displays on furniture that can easily be used as steps, such as a chest of drawers.
- Remember that children can become excited while watching a program, especially on "larger than life" flat panel displays. Care should be taken to install the display where it cannot be pushed, pulled over, or knocked down.
- Care should be taken to route all cords and cables connected to the flat panel display so that they cannot be pulled or grabbed by curious children.

WALL MOUNTING: IF YOU DECIDE TO WALL MOUNT YOUR FLAT PANEL DISPLAY, ALWAYS:

- Use a mount that has been recommended by the display manufacturer and/or listed by an independent laboratory (such as UL, CSA, ETL).
- Follow all instructions supplied by the display and wall mount manufacturers.
- If you have any doubts about your ability to safely install your flat panel display, contact your retailer about professional installation.
- Make sure the wall where you are mounting the display is appropriate. Some wall mounts are not designed to be mounted to walls with steel studs or old cinder block construction. If you are unsure, contact a professional installer.
- A minimum of two people are required for installation. Flat panel displays can be heavy.

Panasonic recommends that a qualified installer perform the wall-mount installation. See page 8.

The American Academy of Pediatrics discourages media viewing for children younger than two years. For more details, see www.aap.org.



■ About built-in wireless LAN

- To use the built-in wireless LAN, using an access point is recommended.
- To use the built-in wireless LAN in the access point mode, up to 7 devices are connectable. But the transfer rate will vary according to communication environment or connected equipments.
- Do not use the built-in wireless LAN to connect to any wireless network (SSID*) for which you do not have usage rights. Such networks may be listed as a result of searches. However, using them may be regarded as illegal access. (If it does not support WPS, the encryption key of the Access point is required when configuring settings.)
- Follow the instructions on the Access point setup screen and configure the appropriate security settings. For more details on setting of Access point, please refer to operating manual for the Access point.
- We recommend using 11n (2.4 GHz) for the wireless system between the built-in wireless LAN and Access point. Communication is also possible with 11a, 11b, and 11g, but the communication speed may be slower.
- If the wireless system of the Access point is changed, devices that could connect by wireless LAN may no longer be able to connect.
- Data transmitted and received over radio waves may be intercepted and monitored.
- Keep the TV away from the following devices as much as possible: Wireless LAN, microwaves, and other devices that use 2.400 GHz and 2.4835 GHz signals. Otherwise, the TV failures such as malfunction may occur due to the radio wave interference.
- When noises occur due to the electricity, etc., the TV might stop operating for the protection of the devices. In this case, turn the TV Off with power On / Off switch, then turn it On again.

*1 SSID is a name for identifying a particular wireless network for transmission.

Accessories/Optional Accessories

Accessories

Check that all the following items have been included with your TV

Remote Control
● NZQAYB001013



Owner's Manual

Batteries (2)
● AAA Battery



Quick Start Guide

Pedestals
● Assembly

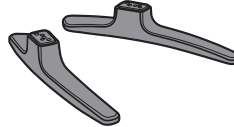

Warranty Card

Screws
● M4 x 35



Optional Accessories

Please contact your nearest Panasonic dealer to purchase the recommended optional accessories. For additional details, please refer to the optional accessories installation manual.

Wall-hanging bracket Please contact a professional installer to purchase the recommended UL qualified wall-hanging bracket. For additional details, please refer to the wall-hanging bracket installation manual.

Back of the TV

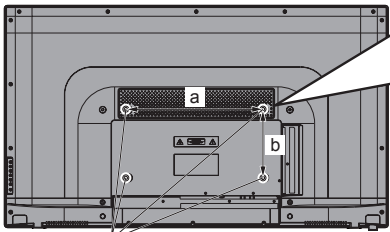

Holes for wall-hanging bracket installation
(for 50")
a: 15.7 " (400 mm)
b: 7.9 " (200 mm)

Screws for attaching the TV to the wall-hanging bracket
(not supplied with the TV)

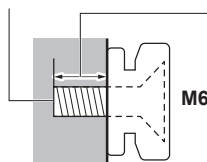

(View from the side)

Depth of screw:
(for 50")
Minimum: 0.24 " (6.0 mm)
Maximum: 0.31 " (8.0 mm)

Warning

- Always be sure to ask a qualified technician to carry out set-up.
- Do not mount the unit directly below ceiling lights (such as spotlights, floodlights or halogen lights) that typically give off high heat. Doing so may warp or damage plastic cabinet parts.
- Take care when fixing wall brackets to the wall. Always ensure that there are no electrical cables or pipes in the wall before hanging bracket.
- To prevent fall and injury, remove the TV from its fixed wall position when it is no longer in use.
- Incorrect wall-hanging bracket or incorrect fitting may cause equipment to fall, resulting in injury and product damage.
- Panasonic disclaims liability for any damage or injury arising from incorrect wall-hanging bracket, incorrect fitting or otherwise failure to follow the above instructions.

Attaching the Pedestals to TV

A Assembly screws

(bottom) (4)



M4 x 35

B Pedestal (R)

(50")

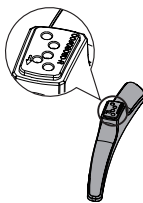

C Pedestal (L)

(50")

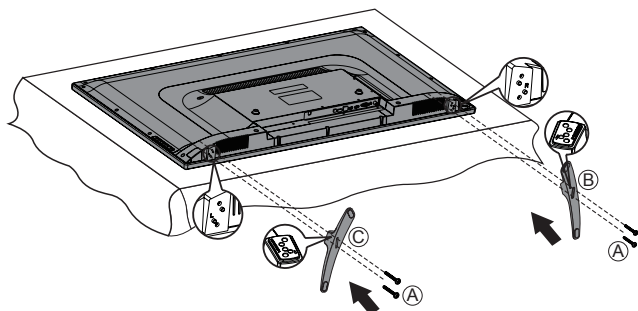
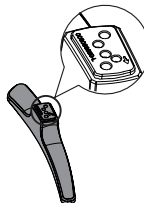

Attaching the pedestals(For 50")

Be sure to attach the pedestals in the following way.

1. Lay the TV face down on a flat, cushioned surface to avoid damaging or scratching.
2. Attach the pedestals (B) (C) to the TV with four assembly screws (A) provided.

Removing the pedestals from the TV

1. Remove the assembly screws (A) from the TV.
2. Lift the TV from the pedestals (B) (C) .

Warning

Do not disassemble or modify the pedestal.

- Otherwise, the TV may fall over and become damaged, and personal injury may result.

Caution

Do not use any pedestal other than that provided with this TV.

- Otherwise, the TV may fall over and become damaged, and personal injury may result.

Do not use the pedestal if it becomes warped or physically damaged.

- If you use the pedestal when it is physically damaged, personal injury may result. Contact your nearest Panasonic Dealer immediately.

During set-up, make sure that all screws are securely tightened.

- If sufficient care is not taken to ensure screws are properly tightened during assembly, the pedestal will not be strong enough to support the TV, and it might fall over and become damaged, and personal injury may result.

When removing the pedestal, do not remove the pedestal by any methods other than the specified procedure.

- Otherwise, the TV and/or pedestal may fall over and become damaged, and personal injury may result.

Installing the Remote's Batteries

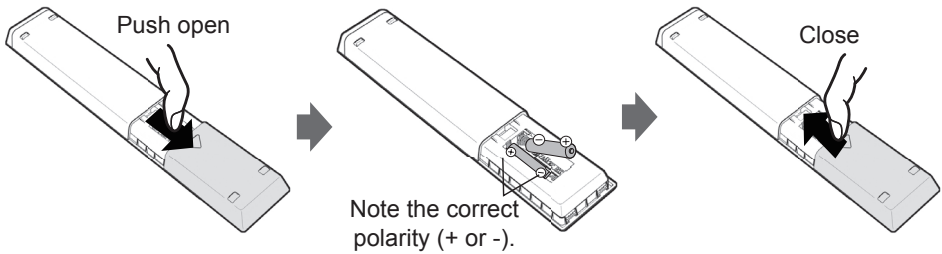

- 1 Open the battery cover.
- 2 Insert two "AAA" size batteries (supplied with the product).
 - Place the batteries with their terminals corresponding to the (+) and (-) indications in the battery compartment.
- 3 Close the battery cover

Caution

- Incorrect installation may cause battery leakage and corrosion, resulting in damage to the remote control.
 - Do not mix old and new batteries.
 - Do not mix different battery types (such as alkaline and manganese batteries).
 - Do not use rechargeable batteries.
- Do not burn or break batteries.

Connections

Connection Panels

Back of the TV

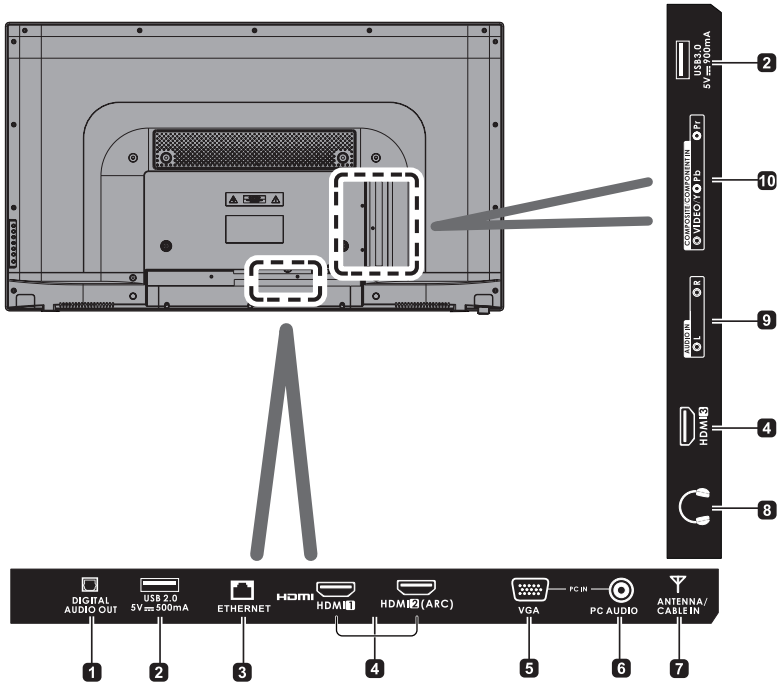

- 1. DIGITAL AUDIO OUT**
Connect to the audio socket on the digital audio system.
- 2. USB Port**
Connect to a USB storage device to play compatible audio and photo files. (USB mode)
- 3. ETHERNET**
Wired Network connection port.
- 4. HDMI Inputs**
Connect to a High-Definition (HD) signal output device.
- 5. VGA Input**
Connect to a computer or other devices with a VGA interface.
- 6. PC AUDIO Input**
Connect to a computer audio output.
- 7. ANTENNA/CABLE IN**
Connect to the antenna.
- 8. Headphone Socket**
Connect to the Headphones.
- 9. AUDIO IN**
Connect to the composite VIDEO and AUDIO (L/R) input sockets on external video devices.
- 10. YPbPr/VIDEO**
Connect to AV devices with component (Y/Pb/Pr) video and audio input sockets. COMPONENT&VIDEO share with AUDIO IN(L/R).
Composite video broadcast signal input (Video is shared with Y)

Antenna or Cable Connection

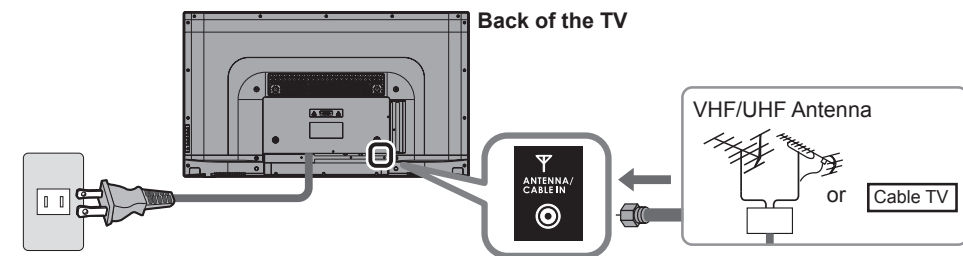

Power Cord

Connect after all other connections have been made.

VHF/UHF Antenna

- NTSC (National Television System Committee): Analog television system
- ATSC (Advanced Television Systems Committee): Digital TV Standards include digital high-definition television (HDTV), standard-definition television (SDTV), data broadcasting, multi-channel surround sound audio and interactive television.

Cable

- You need to subscribe to a cable TV service to enjoy viewing their programming.
- You may need to connect the TV to a Cable box to receive all available channels. Check with your Cable service provider.
- A high-definition connection can be made using an HDMI or Component Video cable to a Cable box. (p. 13)

Note

- When using a Cable box, external equipments and video cables shown in this manual are not supplied with the TV.
- For additional assistance, visit us at: www.panasonic.com/help

AV Cable Connection

Best

Good

Basic (Not HD)

(A) To use HDMI terminals
(Set-top-box / DVD recorder / Blu-ray Disc player / Camcorder / etc.)

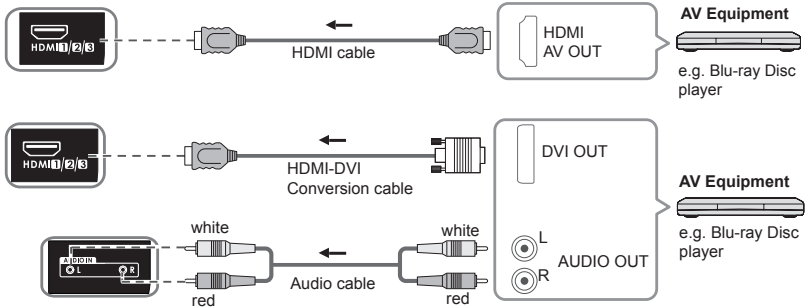

(B) To use COMPONENT terminals
(DVD recorder / Blu-ray Disc player / etc.)

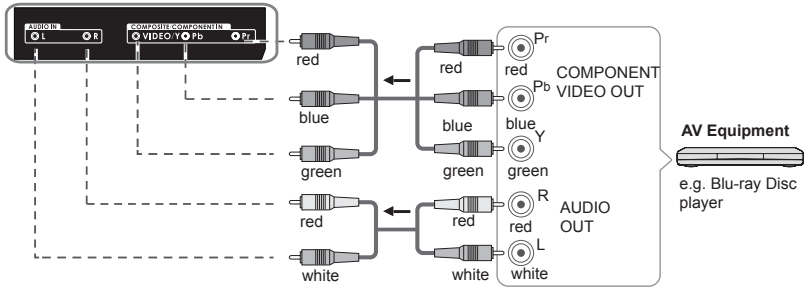

(C) To use COMPOSITE terminals
(Camcorder / Game system / DVD recorder / etc.)

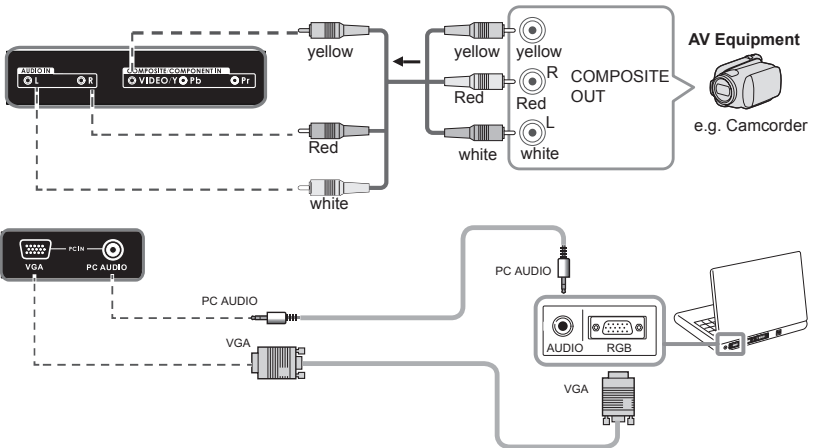

Note

- The Green terminal is shared for both the COMPONENT and COMPOSITE (VIDEO IN) connection. When using COMPOSITE (VIDEO IN) connection, the Yellow connector (Video) should be inserted into Green connection.

Audio Connection

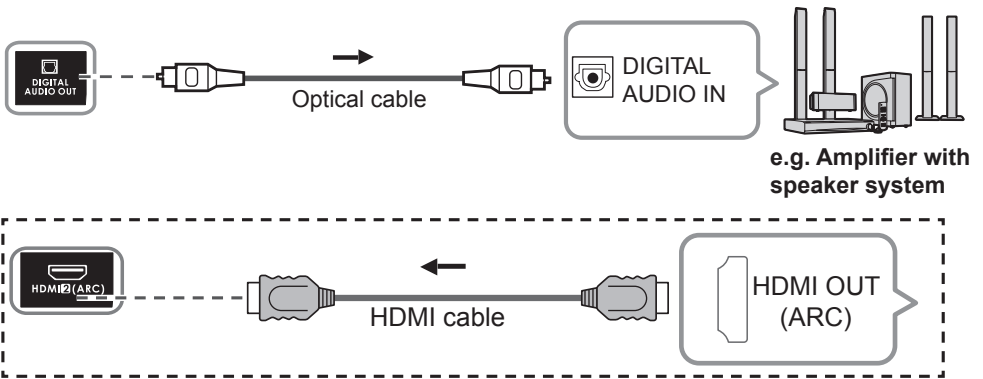

HDMI connection is available if connected audio equipment has ARC (Audio Return Channel) function.

Panasonic does not guarantee operation and performance of peripheral devices made by other manufacturers; and we disclaim any liability or damage arising from operation and/or performance from usage of such other maker's peripheral devices.

Identifying Controls

TV Controls/ Indicators

Front of the TV

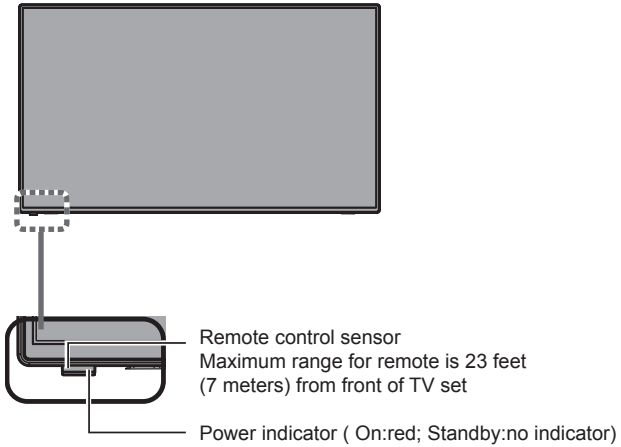

Back of the TV

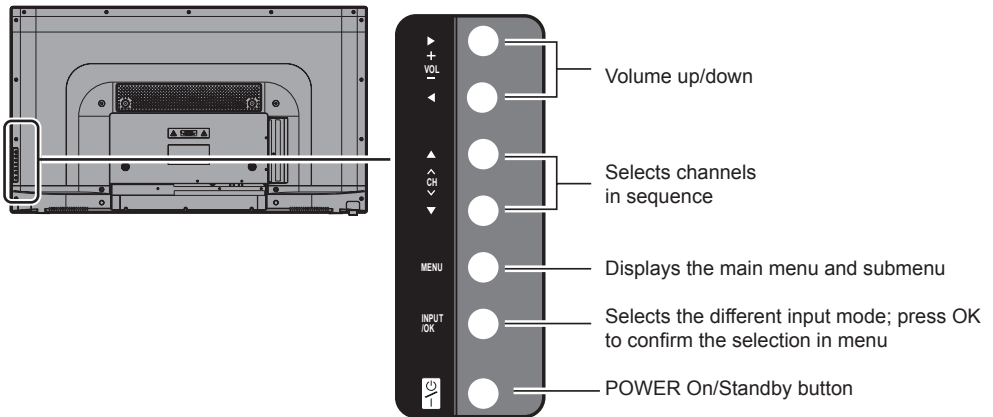

Note

- The TV consumes a small amount of electric energy even when turned off.
- Do not place any objects between the remote control and sensor.

Remote Control

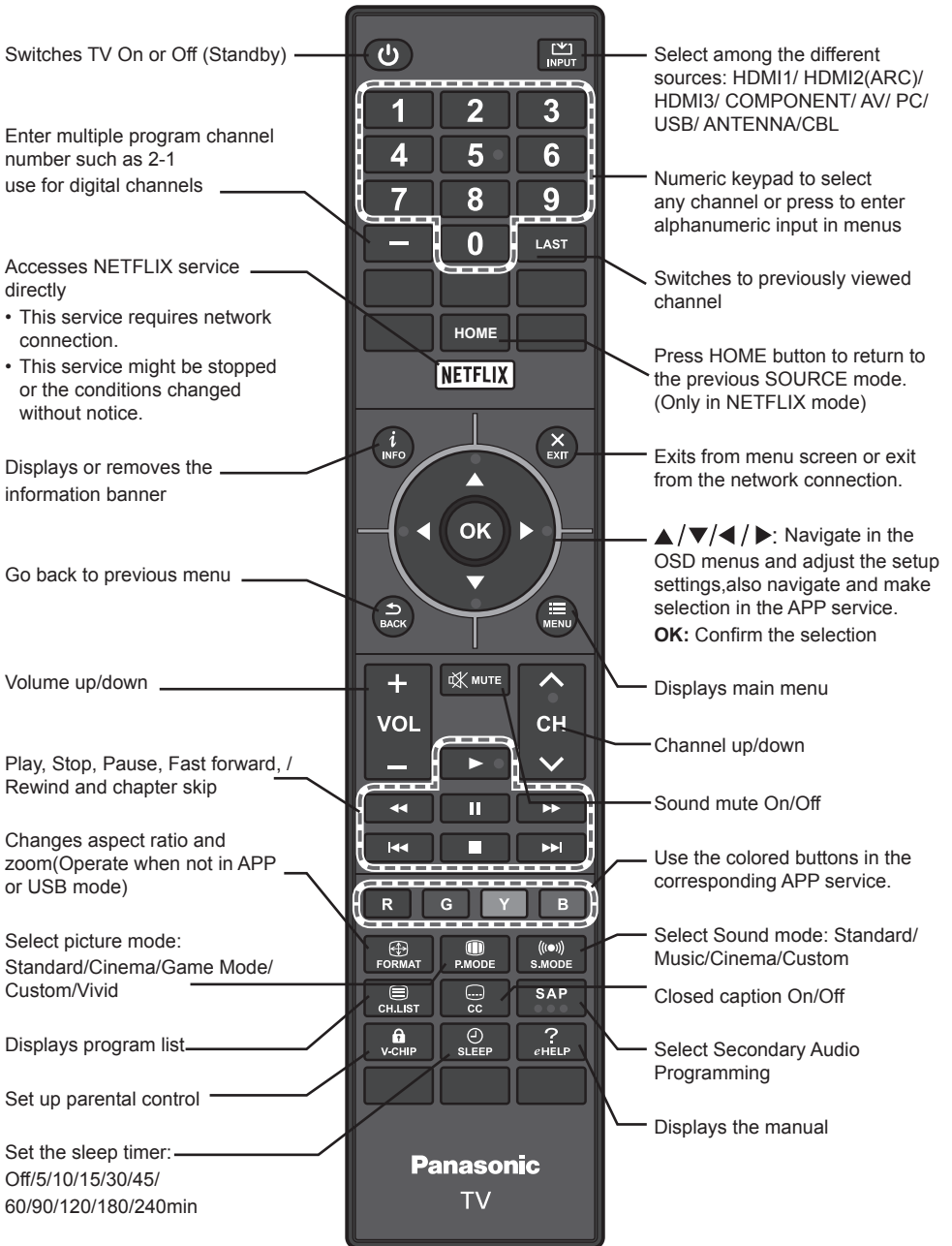

First Time Setup

Connect the power cord to the power socket after you have completed all the physical connections. Turn the TV on with the **POWER** button on the right back of TV or on the remote, then the red LED indicator will illuminate.

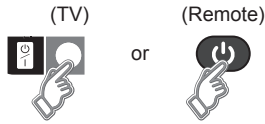

The first time you turn the TV on, it will start the Setup Wizard. Use the **▲/▼/◀/▶** navigation buttons to make a selection. Press **OK** to confirm and continue. Select **↶** to go back to the previous step. To repeat the First Time Setup, Initialize the TV by doing Factory Reset (p. 25).

Input Source

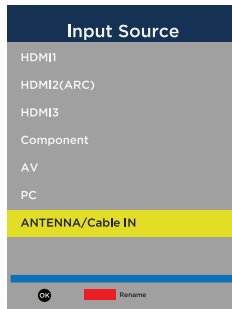

For your convenience, you can rename the inputs to easily remember the connected devices. To rename: select the input source that you want to rename, then press RED button on the remote control, a new screen will pop up on the left. Use **▲/▼** buttons to select the desired one and press **OK** to rename.

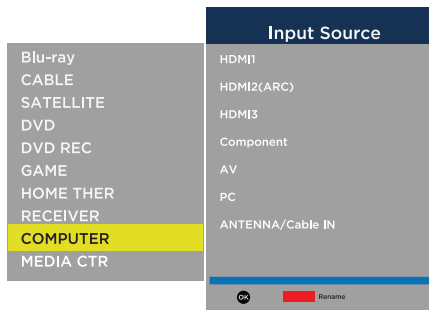

Customizing TV Settings

STREAMING

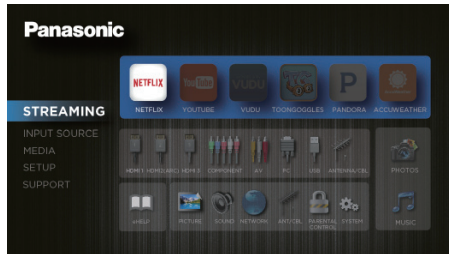

Press the **MENU** button to directly enter the main interface. The default setting is **STREAMING**. Press **OK** or **▶** button to enter APP section. Use **◀/▶** buttons to navigate and select the desired App, and press **OK** button to enter. Press **BACK** button to exit **STREAMING**.

NETFLIX	Enjoy TV shows & movies streamed instantly over the Internet.
YouTube	YouTube your way on the best screen in your house.
VUDU	Discover, watch and collect the latest movies and TV shows in high quality 1080p. Free to sign up. No subscriptions, late fees or commitments.
Toongoggles	A subscription video on-demand platform that offers animated, fun and educational cartoons, engaging games and songs from all over the world and in many different languages to children.
Pandora	Free personalized radio that offers effortless and endless music enjoyment and discovery. Just start with the name of one of your favorite artists, songs, genres or composers and Pandora will do the rest. It's easy to create personalized stations that play only music you'll love.
AccuWeather	Displays the current weather conditions and the temperature anywhere in the world in centigrade or Fahrenheit.

INPUT SOURCE

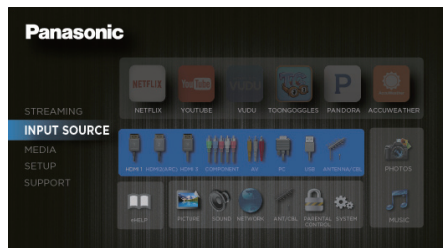

Press **▲/▼** buttons to select **INPUT SOURCE**, and use **OK** or **▶** button to enter. Then press **◀/▶** buttons to navigate and select the different input source among: **HDMI1/ HDMI2(ARC)/ HDMI3/ COMPONENT/ AV/ PC/ USB/ ANTENNA/CBL** and press **OK** button to confirm. Press **BACK** button to exit **INPUT SOURCE**.

MEDIA

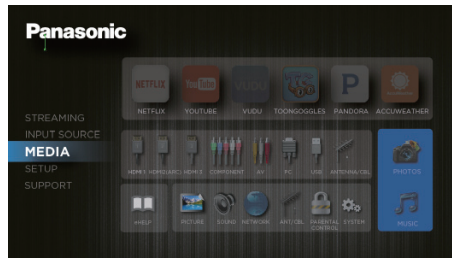

Press ▲/▼ buttons to select **MEDIA**, and use **OK** or ► button to enter. Then press ▲/▼ button to navigate and select the desired **PHOTOS** or **MUSIC** option and press **OK** button to confirm. Press **BACK** button to exit **MEDIA**.

VIEWING PHOTOS

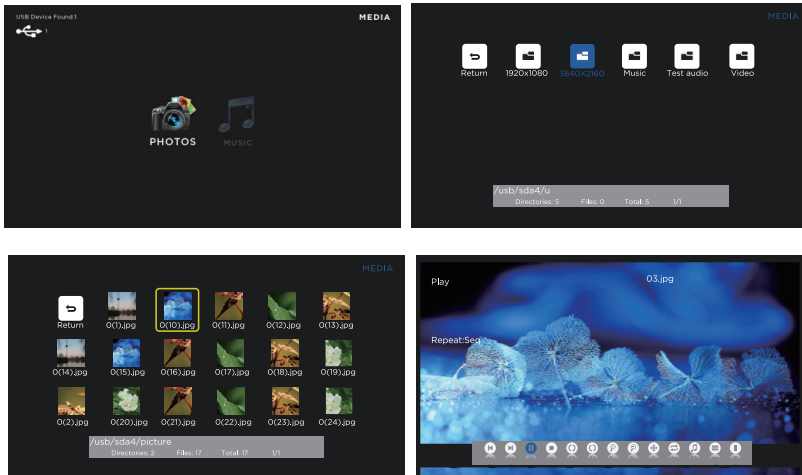

When selecting **PHOTOS**, press **OK** button to select the disk type to enter. Then use ▲/▼/◀/▶ buttons to navigate in the picture folder and select the desired photo, press ► button to display the photo. Press **MENU** button to display the function bar to set the picture playing.

Note: File format supported: **JPEG**.

LISTENING TO MUSIC

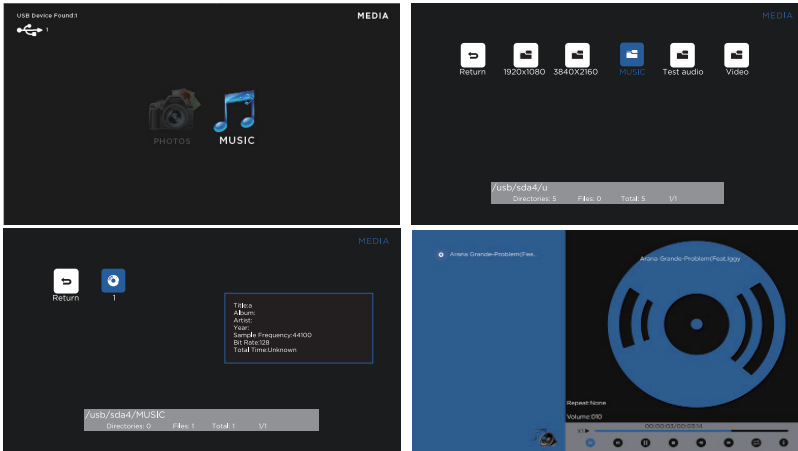

When selecting **MUSIC**, press **OK** button to select the disk type to enter. Then press **▲/▼/◀/▶** buttons to navigate in the music folder and select the desired music, then a subscreen will pop up. Press **▶** button to display the photo. Press **MENU** button to display the function bar to set the music playing.
Note: File format supported: **MP3**.

SETUP

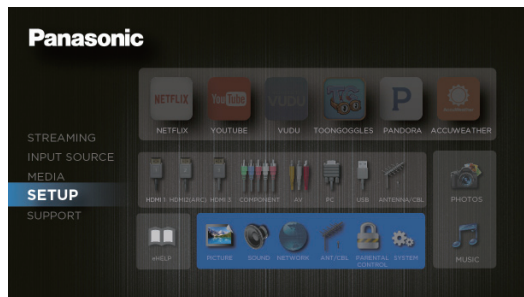

Press **▲/▼** buttons to select **SETUP**, and then use **OK** or **▶** button to enter. Then press **◀/▶** button to navigate and select the desired setting among **PICTURE**, **SOUND**, **NETWORK**, **ANT/CBL**, **PARENTAL CONTROL** and **SYSTEM**, and press **OK** button to confirm. Press **BACK** button to exit **SETUP**.

PICTURE

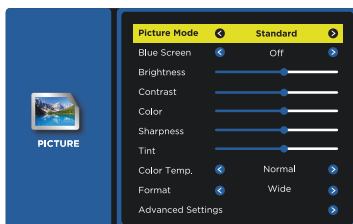

Press ◀/▶ buttons to select **PICTURE** menu and then press **OK** button to enter. Use ▲/▼ buttons to select the following picture options and then use ◀/▶ buttons to set each option's setting.

Picture Mode	Cycle among picture mode: Standard/Cinema/Game Mode(in HDMI or VGA mode)/Custom/Vivid. Alternative: you may press the P.MODE button to select the picture mode directly.
Blue Screen	Allow the blue background to turn On/Off during weak or no signal conditions.
Brightness	Increase or decrease the amount of white in the picture.
Contrast	Adjust the difference between light and dark levels in the pictures.
Color	Control the color intensity.
Sharpness	Adjust the level of crispness in the edges between light and dark areas of the picture.
Tint	Adjust the balance between red and green levels.
Color Temp.	Cycle among color temperatures: Cool/Normal/Warm.
Format	Adjust the Standard/Wide/Wide Zoom/Zoom/Just Scan(only HDMI).
Advanced Settings	Adjust the following advanced settings: Color Space: Color Mode: Standard/Dynamic/Custom. Color: In Custom mode, cycle among Cyan/Magenta/Yellow/Red/Green/Blue. Hue/Saturation/Brightness: Adjust the settings in Custom mode. Reset: Reset the settings in color space. White Balance: Adjust Red Gain/Green Gain/Blue Gain/Red Offset/ Green Offset/Blue Offset/Reset. MEMC: An algorithm employing motion estimation and motion compensation, for reducing motion blur in fast moving videos.For best response time in Game mode, MEMC should be OFF. Dynamic Luminance: Turn On/Off the dynamic luminance. Noise Reduction: Set the noise reduction among Medium/Strong/Off/Weak.

SOUND

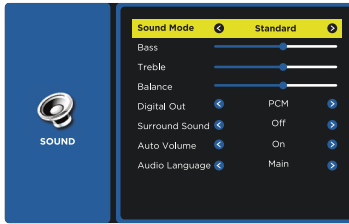

Press ◀/▶ buttons to select **SOUND** menu and then press **OK** button to enter. Use ▲/▼ buttons to select the following sound options and then use ◀/▶ buttons to set each option's setting.

Sound Mode	Allow the selection of an audio-enhancement technique: Standard/Music/Cinema/Custom. Alternative: you may press the S.MODE button to select the sound mode directly.
Bass	Control the relative intensity of lower-pitched sounds.
Treble	Control the relative intensity of higher-pitched sounds.
Balance	Adjust the relative volume of the speaker in a multiple speaker system.
Digital Out	Select the digital audio output mode between RAW/PCM.
Surround Sound	Select surround sound between Virtual or Off.
Auto Volume	Volume levels are automatically controlled by turning On/Off.
Audio Language	Select audio language among: Main/1/2.

NETWORK

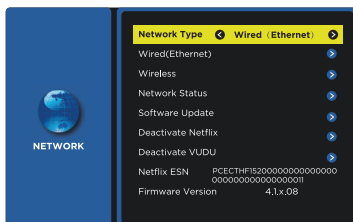

Press ◀/▶ buttons to select **NETWORK** menu and then press **OK** button to enter. Use ▲/▼ buttons to select the following network options and then set each option's setting.

Network Type	Select two types of network: Wired(Ethernet) or Wireless.
Wired(Ethernet)	Connect the Ethernet to the TV: Auto Get IP/Manual Get IP.
Wireless	Connect the TV to the wireless network through searching the available Wi-Fi.
Network Status	Display the current information of network status: Subnet Mask/ Gateway/DNS Server IP address /MAC ADDR.
Software Update	Upgrade the TV software through the network.
Deactivate Netflix	Deactivate Netflix and clear the account information.
Deactivate Vudu	Deactivate Vudu and clear the account information.
Netflix ESN	Electronic Serial Number
Firmware Version	display the firmware version.

ANTENNA / CABLE

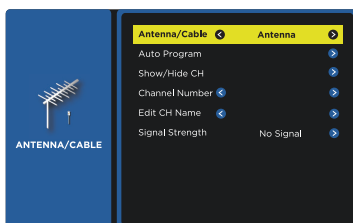

Press ◀/▶ buttons to select **ANTENNA / CABLE** menu and then press **OK** button to enter. Use ▲/▼ buttons to select the following antenna options and set each option's setting.

Note: The ANTENNA / CABLE is available only when you choose the ANTENNA/CBL mode in Input source firstly.

Antenna/Cable	Select antenna type between Antenna and Cable.
Auto Program	select to search the available channels automatically.
Show/Hide CH	Show/Hide the selected channel.
Channel Number	Display the current channel number.
Edit CH Name	Edit the selected channel number.
Signal Strength	Display the current signal strength.

Note: Some Cable service providers require the use of a Cable box to receive all available channels. Check with your Cable service provider.

PARENTAL CONTROL

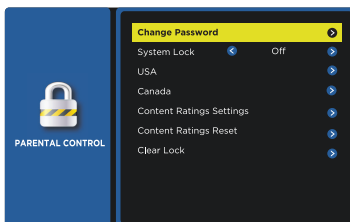

Press ◀/▶ buttons to select **PARENTAL CONTROL** menu and then press **OK** button to enter. Use the 0-9 buttons to input 4-digit password to enter the **LOCK** menu. (Note: the default password is "0000".) Use ▲/▼ buttons to select the following lock options and set each option's setting.

Note: The **PARENTAL CONTROL** is available only when you choose the **ANTENNA/CBL** mode in Input source firstly.

Change Password	Use 0-9 buttons to input the old password and then input the new 4-digit password. Re-enter new password for confirmation.	
System Lock	Select to turn On/Off system lock. The following options (USA, Canada, Content Ratings Settings and Content Ratings Reset) will only be accessible when you turn the system lock on.	
USA	TV	Set the TV Rating: TV-Y, TV-Y7, TV-G, TV-PG, TV-14 and TV-MA.
	MPAA	Select MPAA rating : N/A,G, PG, PG-13, R, NC-17,or X.
Canada	Canada English	Select MPAA rating for English-speaking Canada : E, C, C8+, G, PG, 14+, 18+.
	Canada French	Select MPAA rating for Quebec Canada : E, G, 8 ans+, 13 ans+, 16 ans+, 18 ans+.
Content Ratings Settings	Set the content ratings.	
Content Ratings Reset	Reset the content ratings.	
Clear Lock	Clear all lock settings.	

SYSTEM

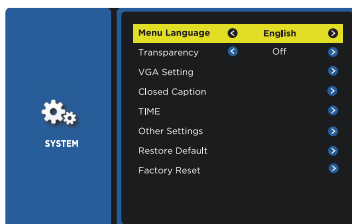

Press ◀/▶ buttons to select **SYSTEM** menu and then press **OK** button to enter. Use ▲/▼ buttons to select the following system options and set each option's setting.

Transparency	Select to turn On/Off menu transparency function.
VGA Setting	Set the VGA setting: H-POS, V-POS, Clock, Phase or Auto. (VGA source mode only)
Closed Caption	CC Mode Select CC mode : Off, On or CC on Mute.
	Basic Selection Basic Selection: CC1, CC2, CC3, CC4, Text1, Text2, Text3, Text4.
	Advanced Selection Advanced Selection: Service1, Service2, Service3, Service4, Service5, and Service6.
	Option Options: Mode, Font, Size, Edge Effect, Edge Color, Text Color, Background Color, Text Opacity, Background Opacity.
TIME	Adjust the time settings: Sleep Timer: Select a period of time after which the TV automatically switches to standby mode: Off/5/10/.../180/240 min. Alternative: Press the SLEEP button repeatedly to select the number of minutes directly. Time Zone: Eastern/ Central/ Mountain/ Pacific/ Alaska/ Hawaii/ Newfoundland/ Atlantic. Daylight Saving Time: Select to turn On/Off daylight saving time.
Other Settings	Set other settings: HDMI EDID: select the HDMI version: HDMI 2.0/HDMI 1.4. HDMI Link: set the following settings: HDMI Link Control : Turn On/Off the HDMI Link Control (HDMI-CEC), When the HDMI Link Control is set to On, the following options can be adjusted: Device Power Off : On/Off TV Power On : On/Off Audio Receiver: On/Off HDMI Link Device List: Displays a list of connected HDMI devices that can be controlled via HDMI Link.
Restore Default	Restore the TV to the default settings before the user's adjusting.
Factory Reset	Initialize to the factory default settings.

SUPPORT

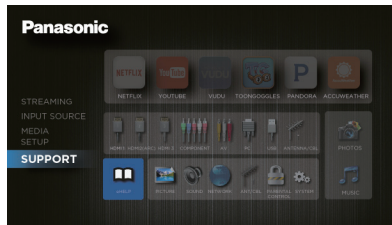

Press ▲/▼ buttons to select **SUPPORT**, and then use **OK** or ► button to jump to eHELP, then press **OK** button to enter. Use ▲/▼ buttons to select eHELP or Open Source Notices and press **OK** to access.

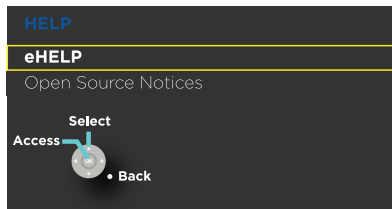

eHELP: Select eHELP and press **OK** button to enter, and then use ▲/▼/◀/▶ buttons to view the built-in user manual.

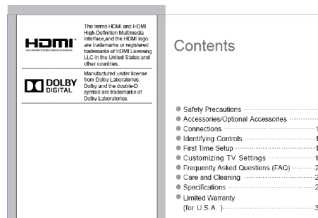

Open Source Notices: displays the notices of open source.

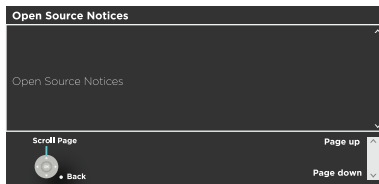

Frequently Asked Questions (FAQ)

Questions	Answers
Why doesn't the remote control work?	<ul style="list-style-type: none">● Check that the batteries are fresh, are of the same type and are installed with the correct polarity (+ & -).● To operate other devices, such as changing channels when using Cable or Satellite boxes, or operating non-Panasonic Blu-ray players, use the remote supplied with the device.
Why is there no picture or just a blue, black or snowy screen being displayed?	<ul style="list-style-type: none">● Ensure that the power cord is plugged in and the TV is turned on (front red LED light should be on, not blinking)● Press the INPUT button on the remote to select the correct input source.● Ensure all connections are correct and secure.● When using external video source, such as a Cable/Satellite box or DVD player, ensure that the device is on and functioning correctly.● Press MENU on the TV's remote control. If the menu is displayed, then the TV is working; recheck above steps.
Why does my picture quality not look like it is in High Definition?	<ul style="list-style-type: none">● Press INFO button on remote to confirm type of signal being received. HD signal should be 720p, 1080i or 1080p.● Select a High Definition channel from HD source (Cable, Satellite, Fiber optic or antenna).● HD channels sometimes broadcast non-HD content.● Ensure that HD source (HD box, Blu-ray player, etc.) is connected to TV via either HDMI or Component cable and set to output HD video signal.
Why did the network connection fail?	<ul style="list-style-type: none">● If connection fails, contact your Internet service provider or router/modem manufacturer to check for firewall, content filter or proxy settings that may block TV from accessing the Internet.
How can I hear the TV's sound through my Home Theater?	<ul style="list-style-type: none">● If your Home Theater has an HDMI-ARC Out, then connect it to the TV's HDMI 2 (ARC) input using an HDMI cable.● If HDMI-ARC is not available, then connect the TV's DIGITAL AUDIO OUT to the Home Theater using an optical cable or connect to the headphone jack.
What are the options to enjoy 4K (Ultra HD) content on this TV?	<ul style="list-style-type: none">● Look for 4K videos on YouTube. Check with Netflix if your subscription plan supports Ultra HD. Check with your service provider for Ultra HD/4K support and connect 4K capable devices using any High-speed HDMI cable.

Care and Cleaning

First, unplug the power cord plug from the wall outlet.

Display panel

The front of the display panel has been specially treated. Wipe the panel surface gently using only a cleaning cloth or a soft, lint-free cloth.

- If the surface is particularly dirty after cleaning up the dust, soak a soft, lint-free cloth in diluted, mild liquid dish soap (1 part mild liquid dish soap diluted by 100 times the amount of water), and then wring the cloth to remove excess liquid. Use this cloth to wipe the surface of the display panel, then wipe it evenly with a dry cloth of the same type until the surface is dry.
- Do not scratch or hit the surface of the panel with fingernails or other hard objects. Furthermore, avoid contact with volatile substances such as insect sprays, solvents, and thinner; otherwise, the quality of the surface may be adversely affected.

Cabinet

If the cabinet becomes dirty, wipe it with a soft, dry cloth.

- If the cabinet is particularly dirty, soak the cloth in diluted, mild liquid dish soap and then wring the cloth dry. Use this cloth to wipe the cabinet and then wipe it dry with a dry cloth.
- Do not allow any mild liquid dish soap to come into direct contact with the surface of the TV. If water droplets get inside the unit, operating problems may result.
- Avoid contact with volatile substances such as insect sprays, solvents, and thinner; otherwise, the quality of the cabinet surface may be adversely affected or the coating may peel off.
- Do not let articles made from rubber or PVC be in contact with the TV for long periods of time.

Pedestal

Cleaning

- Wipe the surfaces with a soft, dry cloth. If the unit is particularly dirty, clean it using a cloth soaked with water to which a small amount of mild liquid dish soap has been added and then wipe with a dry cloth. Do not use products such as solvents, thinner, or household wax for cleaning, as they can damage the surface coating.
Note: If using a chemically-treated cloth, follow the instructions supplied with the cloth.
- Do not attach sticky tape or labels, as they can make the surface of the pedestal dirty. Do not allow long-term contact with rubber, vinyl products, or the like. (Doing so will cause deterioration.)

Power cord plug

Wipe the plug with a dry cloth at regular intervals.

Note: Moisture and dust can lead to fire or electrical shock.

Specifications

		TC-50CX400U	
Power Source		AC 120 V, 60 Hz	
Power Consumption (Rated power / Standby power)		150 W / 0.5 W	
Display Panel	Panel System	LCD panel (LED backlight)	
	Screen size	50 " class (49.5 inches measured diagonally)	
	W × H × Diagonal	43.1 " × 24.2 " × 49.5 " (1096.01 mm × 616.68 mm × 1257 mm)	
	Number of pixels	3840 × 2160	
Speaker Output		16 W [8 W + 8W] (10 % THD)	
Channel Capability (Digital/Analog)		VHF/ UHF: 2 - 69, CATV: 1 - 135	
Operating Conditions		Temperature: 32 °F - 95 °F (0 °C - 35 °C) Humidity: 20 % - 80 % RH (non-condensing)	
Connection Terminal	VIDEO IN	RCA PIN (VIDEO, AUDIO-L, AUDIO-R)	
	COMPONENT IN	RCA PIN (VIDEO/Y, Pb, Pr, AUDIO-L, AUDIO-R)	
	HDMI IN 1/2/3	TYPE A Connector	
	USB 2.0	USB2.0 Type A connector DC 5V, Max. 500mA	
	USB 3.0	USB3.0 Type A connector DC 5V, Max. 900mA	
	DIGITAL AUDIO OUT	PCM / Dolby Digital, Fiber Optic	
	OTHERS	ETHERNET (10BASE-T/100BASE-TX)	
Dimensions	Including pedestal (W × H × D)	44.4 " × 27.56 " × 11.14 " (1,128 mm × 700 mm × 283 mm)	
	TV Set only (W × H × D)	44.4 " × 25.98 " × 3.31 " (1,128 mm × 660 mm × 84 mm)	
Mass	Including pedestal	27.78 lb. (12.6 kg) NET	
	TV Set only	26.90 lb. (12.2 kg) NET	

		Wireless LAN	
Standard Compliance and Frequency Range *1, *2		IEEE 802.11b/g/n : 2.400 GHz - 2.4835 GHz	
Security		WPA2-PSK (TKIP/AES) WPA-PSK (TKIP/AES) WEP (64bit/128bit)	

*1 The frequency and channel differ depending on the country.

*2 802.11b/g/n CH1 ~ CH11 only use for United States and Canada.

Note

- Design and Specifications are subject to change without notice. Mass and Dimensions shown are approximate.

USA Only: Disposal may be regulated in your community due to environmental considerations. For disposal or recycling information, please visit Panasonic website:
<http://www.panasonic.com/environmental>
or call 1-888-769-0149.

Sólo Estados Unidos: La disposición puede estar regulada en su comunidad debido a consideraciones ambientales. Para información sobre la disposición o reciclaje, por favor visite la página web de
Panasonic: <http://www.panasonic.com/environmental>
o llame al 1-888-769-0149.

Panasonic Corporation of North America

Two Riverfront Plaza
Newark, NJ 07102-5490 U.S.A.

© 2015 Panasonic Corporation of North America. All Rights Reserved.

© 2015 Panasonic Corporation of North America. Todos los Derechos Reservados.

TERMS AND CONDITIONS OF USE

The User's attention is particularly drawn to the provisions of Article 8.

Article 1

These TERMS AND CONDITIONS OF USE (as amended from time to time), including the PRIVACY POLICY available at the end of the eHELP (on screen Owner's Manual), (collectively, "Terms") define the terms and conditions applicable to any individual that uses or accesses the web-based services (each a "User") through Panasonic-branded smart televisions (the "Services") sold by Panasonic Corporation of North America and its affiliates (together, "Panasonic", "we", "us"). By using the Services Users accept and agree to observe the Terms. Each User shall be deemed to accept the Terms each time that User accesses and/or uses the Service.

Article 2 Modification to the Terms

Panasonic may modify these Terms from time to time, in its sole discretion, for one or more of the reasons set out in Article 2A. When we modify these Terms as part of a software update for your television, the User will need to click to accept the amended Terms prior to continuing to use the Services. A User always has the option not to accept Terms which have been amended, without penalty; however, if a User chooses not to accept amended Terms that User will be unable to continue using the Services.

Article 2A

We may modify these Terms under Article 2 for any one or more of the following reasons:

- (a) if the modification is favorable to Users;
- (b) if Panasonic needs to make the modification for legal or regulatory purposes;
- (c) to reflect changes that Panasonic or its unaffiliated manufacturers or service providers make to the systems and infrastructure that are used in connection with the Services;
- (d) to improve the Services or to offer Users new Services, or to remove one or more Services (although the provisions of Article 7 will override this Article 2A where the Articles conflict with each other)
- (e) to increase the security of the Services, which may require Users to observe new or amended procedures;
- (f) to reflect organizational changes within Panasonic Corporation or its affiliates; or
- (g) for any other reason we consider is valid and necessary.

Article 3 Use of Services

1. Users are, at the Users' own cost and expense, responsible for setting-up, installing and maintaining the television, internet environment and/or other devices and terminals necessary for using the Services.
2. Users agree that there may be cases where Users have to agree with separate provisions for their usage of the whole or a part of the Service ("Rules"), in such case, Users may use such Service only after Users have agreed to those separate provisions. If there is any conflict between the Terms and such separate provisions, the Rules will prevail unless otherwise agreed by the User and Panasonic.
3. When Users upload, share, or make public any content, the Users will be responsible for all the content and will make sure that the Users have the right to do so.

Article 4 Third Party Applications

Third party applications provided by a third party ("Third Party"), including, but not limited to, application, contents, advertisement or any other materials provided by third parties, ("Third Party Applications") are available through the Service but are not the responsibility of Panasonic. These Third Party Applications are operated by third party companies other than Panasonic and are not under the control of Panasonic. The inclusion of Third Party Applications on the Service does not imply endorsement or sponsorship of the application by Panasonic.

When Users use Third Party Applications, Users do so at their own risk. Any dealings that Users have with Third Party Applications, including the delivery of and the payment for goods and services, and any other terms, conditions, warranties or representations associated with such dealings are solely governed by the terms agreed between a User and the relevant Third Party.

Panasonic shall not control and not be responsible or liable for any Third Party Applications or any content, advertising or other materials on or available from or provided by Third Party Applications. Third Party Applications are governed by their own terms and conditions and privacy policies, which should be carefully reviewed by Users. Panasonic makes no warranty or representation regarding any Third Party Applications, the information appearing on any Third Party Applications, any of the products or services described on any Third Party Applications or the security of any User's personal information collected by any Third Party Applications. Panasonic will have no liability arising out of or related to Third Party Applications and/or their content, or for any damages or loss caused or alleged to be caused by or in connection with any purchase, use of or reliance on any such content, goods, or services available on or through any Third Party Applications.

Article 5 Age Requirement

The Service is available for Users aged 13 years of age or older. If Users are 13 or older but under the age of majority in your country of residence (a "minor"), this agreement shall be reviewed with their parent or guardian to make sure that both the minor and their parent or guardian understand it. The parent or guardian shall accept these Terms on behalf of a minor before allowing a minor to access the Services and shall supervise the use of the Services by the minor to ensure that these Terms are being complied with.

Certain Third Party Applications available through the Service may be intended for individuals under the age of 13. In such case the Users' parent or guardian shall supervise the use of such Third Party Applications by any persons under the age of 13 at all times. The privacy policies and terms and conditions of such Third Party Applications shall apply and the parent or guardian of Users under the age of 13 should carefully review such Third Party Applications' privacy policies and terms and conditions prior to using such Third Party Applications.

Article 6 Suspension of the Service

Panasonic may temporarily suspend the Service without prior notice to the Users in the event that:

(1) it is necessary to conduct regular or emergency maintenance of equipment etc. related to the provision of the Service;

(2) the provision of the Service is prevented by a fire, outage, natural disaster, or other event outside of Panasonic's control;

(3) the service of the network service provider is suspended for any reason;

(4) Panasonic deems it necessary to temporarily suspend the Service for managerial, operational, or technical reasons; or

(5) Panasonic has amended these Terms in accordance with Article 2 and a User has not clicked to accept the amended Terms.

Article 7 Service change, discontinuation and transfer

1. Panasonic may change, add, suspend or terminate the whole or a part of the Service and its contents, and make changes, additions, etc., to usage conditions (including, those for the purpose of Service-related maintenance or construction work etc.) without prior notice to the Users. However, Panasonic must follow the provisions of Article 2 if such changes etc. involve changes in the Terms.

2. Panasonic may discontinue the whole or a part of the Service without prior notice to the Users, to make changes or perform maintenance to the Service.

3. Panasonic may assign or hand over the whole or a part of its rights and obligations under the Terms to a third party by making a reasonable prior announcement on the Service screen and giving reasonable prior notice to the Users. However, in these circumstances a User has the right to no longer be bound by these Terms provided that the User lets us know. However, if a User chooses to no longer be bound by these Terms, that User will be unable to continue using the Services.

4. Panasonic may discontinue the whole of the Services in the event that a User does not accept Terms which have been modified in accordance with Article 2 .

Article 8 No Warranty, limitation of liability and Indemnity

1. THE SERVICE IS PROVIDED "AS IS" WITHOUT WARRANTIES OF ANY KIND, EXPRESS OR IMPLIED, AS TO THE OPERATION OF THE SERVICE OR THE INFORMATION, CONTENT, MATERIALS, OR SERVICES INCLUDED IN OR OTHERWISE AVAILABLE THROUGH THE SERVICE EXCEPT AS SET OUT IN THESE TERMS OR OTHERWISE REQUIRED BY LAW.

2. THE SERVICE IS PROVIDED WITHOUT ANY WARRANTIES, EITHER EXPRESS OR IMPLIED EXCEPT AS REQUIRED BY LAW, INCLUDING, BUT NOT LIMITED TO, IMPLIED WARRANTIES OF MERCHANTABILITY OR FITNESS FOR A PARTICULAR PURPOSE, NON-INFRINGEMENT, OR ANY OTHER IMPLIED WARRANTIES ARISING OUT OF COURSE OF PERFORMANCE, DEALING AND/OR TRADE USAGE.

3. PANASONIC DOES NOT GUARANTEE OR WARRANT CONTINUOUS, UNINTERRUPTED OR ERROR-FREE ACCESS OR USAGE, OR THAT DEFECTS WILL BE CORRECTED, OR THAT THIS SERVICE OR THE SERVER THAT MAKES IT AVAILABLE ARE FREE OF VIRUSES OR OTHER HARMFUL COMPONENTS. YOU SHOULD REGULARLY BACK UP THE CONTENT THAT YOU STORE USING THE SERVICES.

4. NEITHER PANASONIC NOR ITS AFFILIATES, THIRD PARTY INFORMATION PROVIDERS, THIRD PARTY MANUFACTURERS, THIRD PARTY SERVICE PROVIDERS, NOR OTHER CONTENT PARTNERS MAKE ANY GUARANTEE REGARDING THE

COMPLETENESS OF ANY INFORMATION OR CONTENT PROVIDED BY OR THROUGH THE SERVICE. ADDITIONALLY, THERE ARE NO WARRANTIES AS TO THE RESULTS OBTAINED FROM THE USE OF SUCH INFORMATION.

5. NEITHER PANASONIC NOR ITS AFFILIATES IS RESPONSIBLE FOR THE ACTIONS, CONTENT, INFORMATION, OR DATA OF THIRD PARTIES.

6. UNDER NO CIRCUMSTANCES AND IN NO EVENT SHALL PANASONIC, OR ITS AFFILIATES, BE LIABLE, REGARDLESS OF THE CAUSE OR DURATION, FOR ANY ERRORS, INACCURACIES, OMISSIONS, OR OTHER DEFECTS IN, OR UNTIMELINESS OR ABSENCE OF AUTHENTICITY OF, THE INFORMATION CONTAINED WITHIN THE SERVICE, OR FOR ANY DELAY OR INTERRUPTION IN THE TRANSMISSION THEREOF TO USERS, OR FOR ANY CLAIMS OR LOSSES ARISING THEREFROM OR OCCASIONED THEREBY.

7. UNDER NO CIRCUMSTANCES AND IN NO EVENT SHALL PANASONIC OR ITS AFFILIATES BE LIABLE FOR DIRECT LOSSES WITH THE EXCEPTION OF DIRECT LOSSES ARISING OUT OF A DELIBERATE BREACH OF THESE TERMS BY PANASONIC OR A SERIOUS ACT OF NEGLIGENCE BY PANASONIC WHICH IS NOT OTHERWISE EXCLUDED BY THESE TERMS OR FOR INDIRECT, INCIDENTAL, SPECIAL, CONSEQUENTIAL, PUNITIVE, OR EXEMPLARY DAMAGES (INCLUDING ATTORNEY'S FEES AND COSTS) ARISING OUT OF OR RELATING TO THESE TERMS, USE OF, OR INABILITY TO USE, THE SERVICE, OR THE CLAIMS OF THIRD PARTIES, INCLUDING USERS, HOWEVER CAUSED, UNDER ANY LEGAL THEORY, REGARDLESS OF WHETHER PANASONIC OR ITS AFFILIATES IS AWARE OF OR SHOULD HAVE BEEN AWARE OF THE POSSIBILITY OF SUCH DAMAGES. IN ADDITION, UNDER NO CIRCUMSTANCES AND IN NO EVENT WILL THE AGGREGATE LIABILITY OF PANASONIC AND ITS AFFILIATES ARISING OUT OF OR RELATING TO THESE TERMS AND/OR RELATING TO USE OF, OR INABILITY TO USE, THE SERVICE, UNDER ANY LEGAL THEORY, EXCEED US\$500 EXCEPT THAT NOTHING SHALL AFFECT OR LIMIT PANASONIC'S LIABILITY FOR DEATH OR PERSONAL INJURY ARISING FROM PANASONIC'S NEGLIGENCE, NOR PANASONIC'S LIABILITY FOR FRAUD OR FRAUDULENT MISREPRESENTATION NOR ANY OTHER LIABILITY WHICH CANNOT BE EXCLUDED OR LIMITED UNDER APPLICABLE LAW.

8. IF A USER LIVES IN FRANCE, ARTICLE 8(7) DOES NOT APPLY TO THE USER AND THIS ARTICLE 8(8) APPLIES INSTEAD. UNDER NO CIRCUMSTANCES AND IN NO EVENT SHALL PANASONIC OR ITS AFFILIATES BE LIABLE FOR DIRECT LOSSES (WITH THE EXCEPTION OF DIRECT LOSSES ARISING OUT OF A DELIBERATE BREACH BY PANASONIC OF THESE TERMS OR SERIOUS ACT OF NEGLIGENCE BY PANASONIC), OR FOR ANY LOSS OF PROFIT, IN ANY CIRCUMSTANCES ARISING OUT OF OR RELATING TO THESE TERMS, USE OF, OR INABILITY TO USE, THE SERVICE, OR THE CLAIMS OF THIRD PARTIES, INCLUDING USERS, HOWEVER CAUSED, UNDER ANY LEGAL THEORY, REGARDLESS OF WHETHER PANASONIC OR ITS AFFILIATES IS AWARE OF OR SHOULD HAVE BEEN AWARE OF THE POSSIBILITY OF SUCH DAMAGES. IN ADDITION, UNDER NO CIRCUMSTANCES AND IN NO EVENT WILL THE AGGREGATE LIABILITY OF PANASONIC AND ITS AFFILIATES ARISING OUT OF OR RELATING TO THESE TERMS AND/OR RELATING TO USE OF, OR INABILITY TO USE, THE SERVICE, UNDER ANY LEGAL THEORY, EXCEED US\$500 EXCEPT

THAT NOTHING SHALL AFFECT OR LIMIT PANASONIC'S LIABILITY FOR DEATH OR PERSONAL INJURY ARISING FROM PANASONIC'S NEGLIGENCE, NOR PANASONIC'S LIABILITY FOR FRAUD OR FRAUDULENT MISREPRESENTATION OR FAUTE LOURDE NOR ANY OTHER LIABILITY WHICH CANNOT BE EXCLUDED OR LIMITED UNDER APPLICABLE LAW.

Article 10 Intellectual Property

Copyright, trademark rights, and other intellectual property rights in the Services and information provided by Panasonic in connection with the Service are vested in Panasonic or other rights holders from which Panasonic has obtained licenses to use such information in connection with the Service. In order to provide or enable access to the Services and the Panasonic-branded smart television, Panasonic needs to use content, data and information (including personal information) that Users upload, provide, generate by using the Services or the Panasonic-branded smart television or otherwise submit to Panasonic ("User Data"). Each User hereby grants Panasonic a worldwide, assignable, transferable, irrevocable, royalty-free license, with the ability to sub-license, to use all User Data for the purposes of providing or enabling access to the Services and the Panasonic-branded smart television, subject to applicable law and the Privacy Policy.

Article 11 Prohibition

1. Users shall not do the following acts in connection with the use of the Service or Panasonic-branded smart television:

- (1) Acts that infringe or may infringe upon the intellectual property (copyright, design right, trademark right, etc.) or other rights of any other persons.
- (2) Acts that infringe or may infringe upon another person's privacy or right of publicity.
- (3) Slander of another person, or acts that harm the honor or credibility of another person.
- (4) Criminal acts (such as fraud, interference with another person's duty, etc.), or acts that encourage or lead to such acts.
- (5) The transmission or posting of pictures or documents that are indecent or constitute child pornography or abuse.
- (6) Other acts that Panasonic deems against public order and morals or that infringe substantially upon the rights of another person.
- (7) Acts that interfere with the smooth operation of the Service or the Panasonic-branded television
- (8) Using the Service for profit-making purposes.
- (9) Other acts that are deemed improper by Panasonic.

Article 12 Prohibition of assignment of rights

The Users may not assign, loan or sell to, buy from, transfer to, or pledge or otherwise provide as security for the benefit of a third party all or part of their right to use the Service, or other rights and obligations under these Terms.

Article 13 Service removal by Panasonic

Panasonic may immediately stop the provision of the Service to the Users if they meet any of the conditions below .

- (1) Users have done any of the acts prohibited in the Article 11.
- (2) Users are in breach of these Terms.
- (3) Panasonic on reasonable grounds otherwise determines that Service usage by the Users is not appropriate .

Article 14 Governing law

The laws of the State of New York shall apply to the formation, validity, and interpretation of the Terms.

Article 15 Jurisdiction

The Users and Panasonic agree that the Supreme Court of the State of New York will be the court of first instance with respect to any lawsuits under the Terms in connection with the Service between the Users and Panasonic.

Article 16 Translation

Where Panasonic has provided the Users with a translation of the English language version of the Terms, to the extent permitted by applicable law, the Users agree that the translation is provided for the User's convenience only and that the English language versions of the Terms will govern the Users' relationship with Panasonic. If there is any contradiction between the English language version of the Terms and the translation, to the extent permitted by applicable law, the English language version shall take precedence.

PRIVACY POLICY

This Privacy Policy applies to any data relating to you that identifies you personally (referred to in this Privacy Policy as “Personal Information”) provided in connection with any web-based interactive applications, services and products (each, a “Service”, and collectively, the “Services”) that are accessed by means of a Panasonic-branded smart television. Together, “Panasonic”, “we”, “us” or “our” means Panasonic Corporation of North America with the address at Two Riverfront Plaza, Newark, NJ 07102-5490 and its affiliates.

This Privacy Policy explains how we use the Personal Information that you provide to us or that we collect through your use of the Services through your Panasonic-branded smart television. This Privacy Policy does not apply to information that may be collected by or through third party applications that are available through the Services, nor to services offered by us which are not accessed through your Panasonic-branded smart television. Please read this Privacy Policy carefully. By clicking to accept this Privacy Policy and by using any of the Services you indicate that you have read, accepted and agreed to the Panasonic privacy practices, as outlined in this Privacy Policy, and any other applicable terms.

We may update this Privacy Policy over time. We will notify you of these changes as part of a software update for your television. The Privacy Policy is also available at the end of the eHELP (on screen Owner's Manual), and at www.panasonic.com. Continued use of any of the Services will signify that you agree to any such changes and the updated Privacy Policy.

Where we have provided you with a translation of the English language version of this Privacy Policy, to the extent permitted by applicable law, you agree that the translation is provided for your convenience only and that the English language versions of this Privacy Policy will govern your relationship with us. If there is any contradiction between the English language version of this Privacy Policy and the translation, to the extent permitted by applicable law, the English language version shall take precedence.

What information do we collect about you?

Information you provide

You can use many of our Services without providing any Personal Information, but for some Services, and certain features within some Services, we will request Personal Information from you. You can choose whether or not to provide this information, but you may not be able to access our full Services if you choose not to submit it. Here are some examples of circumstances where we collect Personal Information that you provide:

- If you contact us to troubleshoot problems you are having with the Services, we may ask you to provide certain additional information, including your name, mailing address, phone number, email address, and unique device identifier.
- If you choose use an application provided through the Services or purchase or utilize a third party product(s) through such applications, such transactions may be processed by a third party company that may ask you to provide

certain information. Any information the third party company gathers will be governed by its own privacy policy. The third party company may provide us with the information you provide in connection with the transaction, including your name, email address, and mailing address.

Information we obtain from your use of the Services

Beyond the information that you provide, we or our unaffiliated third party manufacturers or service providers may automatically collect information about the Services that you use and how you use them via your Panasonic-branded smart television. For example, when you use the Services, we or our unaffiliated third party manufacturers or service providers may automatically collect certain information from you such as IP address, user identifier, unique device identifier, device configurations, firmware version, and device, service and application usage data. We or our unaffiliated third party manufacturers or service providers may also collect information about what third party apps you access, but we or our unaffiliated third party manufacturers or service providers (excluding providers of third party Applications) do not collect data on what you do on such apps. In all cases we retain your Personal Information for a duration which is permitted by applicable law and in our agreements with our unaffiliated third party manufacturers or service providers (excluding providers of third party Applications) we have asked such third parties to do the same. With respect to third party applications and providers of such applications, please see the "**Linking to third party applications**" section of this Privacy Policy, Article 4 of the Terms and Conditions of Use, and other applicable sections of this Privacy Policy and the Terms and Conditions of Use related to third party applications.

We do not knowingly collect Personal Information from children

The Service is available for individuals 13 years of age or older. We do not solicit or knowingly collect Personal Information from children under the age of 13. If we nevertheless receive Personal Information from an individual who indicates that he or she is, or whom we otherwise have reason to believe is, under the age of 13, we will delete such information from our systems as quickly as possible. We do not, however, distinguish between users of the TV, so if an individual under the age of 13 years of age is viewing a program, that viewing information may be collected.

What do we do with your Personal Information?

We may use your Personal Information for any of the following purposes:

- To provide the Services;
- To support you in your use of the Services and your use of your Panasonic-branded smart television;
- To maintain the security and integrity of our systems;
- To send promotional communications to you, including about: 1) other services we provide or other websites we own and operate and 2) third party products and services we may choose to recommend or promote;
- To protect Us and others. We reserve the right to access, read, preserve and disclose any information that we reasonably believe is necessary to comply with the law, subpoena or court order; enforce or apply our Terms of Use and other agreements; investigate, prevent or take action regarding illegal activities or suspected fraud; or protect the rights, property or safety of Panasonic, our employees, our users or others.

We retain your Personal Information for as long as is necessary for the purposes above.

To what third parties do we disclose your Personal Information?

We may disclose your Personal Information to third parties for any of the purposes written in the section “**What do we do with your personal information?**” We require these third parties to take steps to maintain the confidentiality of any Personal Information they may receive from us to perform their functions, consistent with our Privacy Policy, and they may not use this information for any other purpose. We may also disclose your information as follows:

- We may disclose your Personal Information in connection with legal requirements, such as in response to an authorized subpoena, governmental request or investigation, or as otherwise required by law.
- We may disclose your Personal Information, or your Personal Information may be accessed by, our unaffiliated manufacturing partners and service providers in connection with such manufacturing partners’ and service providers’ provision of services to you and Panasonic.
- As our business develops, we may sell, buy, or transfer corporate assets, and in such transactions customer information, including your Personal Information, may be one of the transferred business assets to the extent permitted by applicable law. Also, in the event that we, the Service, or substantially all of our assets are acquired, your Personal Information may be one of the assets transferred in such acquisition. By agreeing to this Privacy Policy, you agree to the transfer of your Personal Information in connection with the foregoing situations, subject to applicable law.

Where do we store your Personal Information?

Your country of residence, including, in respect of residents of a country within the European Economic Area (the “**EEA**”), to a country outside the EEA. Your information may also be processed by staff operating inside or outside your country of residence, including staff located outside of the EEA, who work for us or for one of our suppliers.

How do we keep your Personal Information secure?

We maintain physical, technical, and procedural safeguards to help guard your information. To the extent we have your Personal Information, we restrict access to such information to those persons who need to know that information to provide products or services to you and any persons you have authorized to have access to such information. We may keep and archive your information at our discretion subject to applicable laws and regulations.

Transmission of your Personal Information

The Internet is a global environment. By using the Service you will be sending information to us electronically and such data may be transferred internationally over the internet depending upon your location. Note that the internet is not a secure environment and this Privacy Policy applies to our use and disclosure of your Personal Information once it is under our possession or control only. Given the inherent nature of the Internet, all Internet transmissions are done at your own risk.

In addition, third party applications available through the Service may use cookies or similar technologies. These cookies or similar technologies are not under our control and are subject to the terms and privacy notices provided by the relevant third parties.

Linking to third party applications

The Service includes links to applications from third party developers. We are not responsible for the privacy practices of these applications and we encourage you to read the privacy policies provided by these developers before you provide personal information to them.

<Panasonic TV Customer Support>

You may also update or modify your Personal Information on your television or by contacting us at <Panasonic TV Customer Support>

Contact

If you have any questions about this Privacy Policy, you may contact us at:

<Panasonic TV Customer Support>

Special clause for residents in certain country/region/

<California/USA >

California residents are entitled to request and obtain certain information regarding our disclosure, if any, of Personal Information to third parties for their direct marketing purposes in the preceding calendar year once a year, free of charge. To make such a request, please contact us at <Panasonic TV Customer Support>

Last Updated: October 1, 2015