

USA Only: Disposal may be regulated in your community due to Environmental considerations. For disposal or recycling information, please visit Panasonic website: <http://www.panasonic.com/environmental> or call 1-888-769-0149.

#### Customer's Record

The model number and serial number of this product can be found on its back cover. You should note this serial number in the space provided below and retain this book, plus your purchase receipt, as a permanent record of your purchase to aid in identification in the event of theft or loss, and for Warranty Service purposes.

Model Number \_\_\_\_\_

Serial Number \_\_\_\_\_

#### Anotación del cliente

El modelo y el número de serie de este producto se encuentran en su panel posterior. Deberá anotarlos en el espacio provisto a continuación y guardar este manual, más el recibo de su compra, como prueba permanente de su adquisición, para que le sirva de ayuda al identificarlo en el caso de que le sea sustraído o lo pierda, y también para disponer de los servicios que le ofrece la garantía.

Modelo \_\_\_\_\_

Número de serie \_\_\_\_\_

**Panasonic Consumer Electronics Company,**  
**Division of Panasonic Corporation of North America**  
One Panasonic Way, Secaucus  
New Jersey 07094 U.S.A.

**Panasonic Canada Inc.**  
5770 Ambler Drive  
Mississauga, Ontario  
L4W 2T3 CANADA

# Panasonic®

Model No.  
Número de modelo  
**TC-L19C30**

## Owner's Manual

19" Class 720p LCD HDTV  
(18.5 inches measured diagonally)

## Manual de usuario

Televisión de alta definición de 720p y  
clase 19" de LCD  
(18,5 pulgadas medidas diagonalmente)

# VIERA

For assistance (U.S.A./Puerto Rico), please call:

**1-877-95-VIERA (958-4372)**

[www.panasonic.com/help](http://www.panasonic.com/help)

For assistance (Canada), please call:

**1-866-330-0014**

[www.vieraconcierge.ca](http://www.vieraconcierge.ca)

Para solicitar ayuda (EE.UU./Puerto Rico), llame al:

**1-877-95-VIERA (958-4372)**

[www.panasonic.com/help](http://www.panasonic.com/help)

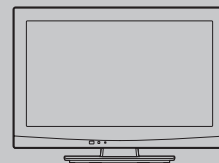

### English

Thank you for purchasing this Panasonic product.  
Please read these instructions before operating your set and retain them for future reference. The images shown in this manual are for illustrative purposes only.

### Español

Gracias por su decisión de comprar este producto marca Panasonic.  
Lea estas instrucciones antes de utilizar su televisor y guárdelas para consultarlas en el futuro. Las imágenes mostradas en este manual tienen solamente fines ilustrativos.

# Experience an amazing level of multimedia excitement

## Enjoy rich multimedia

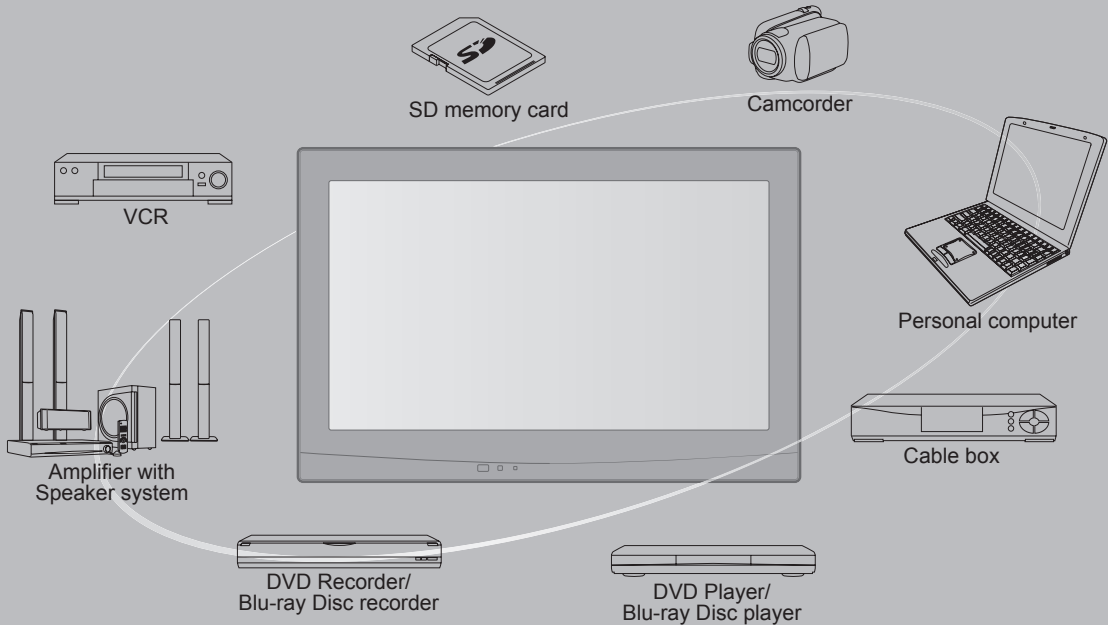

### This product incorporates the following software:

- (1) software developed independently by or for Panasonic Corporation,
- (2) software owned by a third party and licensed to Panasonic Corporation,
- (3) software licensed under the GNU General Public License, Version 2 (GPL v2),
- (4) software licensed under the GNU LESSER General Public License (LGPL) and/or,
- (5) open source software other than software licensed under the GPL and/or LGPL

For the software categorized as (3) or (4), please refer to the terms and conditions of GPL v2 and LGPL, as the case may be at <http://www.gnu.org/licenses/old-licenses/gpl-2.0.html> and <http://www.gnu.org/licenses/old-licenses/lgpl-2.1.html> In addition, software categorized as (3) or (4) is copyrighted by several individuals and/or entities. Please refer to the copyright notice of those individuals at <http://www.am-linux.jp/dl/DTV11UT/>.

GPL/LGPL SOFTWARE IS DISTRIBUTED IN THE HOPE THAT IT WILL BE USEFUL, BUT WITHOUT ANY WARRANTY, EXPRESS, IMPLIED OR STATUTORY, INCLUDING THE IMPLIED WARRANTIES OF MERCHANTABILITY OR FITNESS FOR A PARTICULAR PURPOSE.

For at least three (3) years from delivery of products, Panasonic will give to anyone who contacts us at the address provided below, for a charge of no more than our cost of physically performing source code distribution, a complete machine-readable copy of the corresponding source code covered under GPL v2/LGPL.

Contact Information  
[cdrequest@am-linux.jp](mailto:cdrequest@am-linux.jp)

Source code is also freely available to you and any other member of the public via our website below.  
<http://www.am-linux.jp/dl/DTV11UT/>



VIERA Link™ is a trademark of Panasonic Corporation.



HDMI, the HDMI logo and High-Definition Multimedia Interface are trademarks or registered trademarks of HDMI Licensing LLC in the United States and other countries.



SDHC Logo is a trademark of SD-3C, LLC.



This product qualifies for ENERGY STAR in the "Home Use" setting and this is the setting in which energy savings will be achieved. Any modifications to the "Home Use" setting or other factory default settings could result in greater energy consumption beyond levels that meet ENERGY STAR qualifications.

Manufactured under license from Dolby Laboratories. Dolby and the double-D symbol are trademarks of Dolby Laboratories.

HDAVI Control™ is a trademark of Panasonic Corporation.



# Contents

## Please read before using the unit

- Safety Precautions ..... 4

## Getting started

- Accessories/Optional Accessory ..... 7
- Connections ..... 9
- Identifying Controls ..... 11
- First Time Setup ..... 12

## Basic Features

- Watching TV ..... 15
- Using VIERA TOOLS ..... 18
- Watching content from external devices ..... 19
- Viewing photos with VIERA IMAGE VIEWER ..... 20

## Advanced Features

- VIERA Link™ "HDAVI Control™" ..... 22
- Editing and Setting Channels ..... 28
- How to Use Menu Functions ..... 30
  - Picture settings ..... 31
  - Audio settings ..... 32
  - Timer settings ..... 32
  - Lock ..... 33
  - Closed caption ..... 33
  - Setup ..... 34

## Support Information

- Ratings List for parental control ..... 35
- Technical Information ..... 36
- Care and Cleaning ..... 40
- Specifications ..... 41
- Frequently Asked Questions (FAQ) ..... 42
- Index ..... 44
- Limited Warranty (for U.S.A. and Puerto Rico only) ..... 45
- Customer Services Directory (for U. S. A. and Puerto Rico) ..... 46
- Limited Warranty (for Canada) ..... 47

Getting started

Basic

Advanced

Support Information

# Safety Precautions

	<b>CAUTION</b> <b>RISK OF ELECTRIC SHOCK</b> <b>DO NOT OPEN</b>	
<b>WARNING: To reduce the risk of electric shock, do not remove cover or back. No user-serviceable parts inside. Refer servicing to qualified service personnel.</b>		



The lightning flash with arrowhead within a triangle is intended to tell the user that parts inside the product are a risk of electric shock to persons.



The exclamation point within a triangle is intended to tell the user that important operating and servicing instructions are in the papers with the appliance.

## Note to CATV System Installer

This reminder is provided to direct the CATV system installer's attention to Article 820-40 of the NEC that provides guidelines for proper grounding and, in particular, specifies that the cable ground shall be connected to the grounding system of the building, as close to the point of cable entry as practical.

## Secure Ventilation

Slots and openings in the cabinet and the back or bottom are provided for ventilation, and to ensure reliable operation of the LCD TV and to protect it from overheating. These openings must not be blocked or covered. There should be at least 10 cm of space around the TV. The openings should never be blocked by placing the LCD TV on a bed, sofa, rug or other similar surface. This LCD TV should not be placed in a built-in installation such as a bookcase unless proper ventilation is provided.

## Important Safety Instructions

- 1) Read these instructions.
- 2) Keep these instructions.
- 3) Heed all warnings.
- 4) Follow all instructions.
- 5) Do not use this apparatus near water.
- 6) Clean only with dry cloth.
- 7) Do not block any ventilation openings. Install in accordance with the manufacturer's instructions.
- 8) Do not install near any heat sources such as radiators, heat registers, stoves or other apparatus (including amplifiers) that produce heat.
- 9) Do not defeat the safety purpose of the polarized or grounding-type plug. A polarized plug has two blades with one wider than the other. A grounding type plug has two blades and a third grounding prong. The wide blade or the third prong are provided for your safety. If the provided plug does not fit into your outlet, consult an electrician for replacement of the obsolete outlet.
- 10) Protect the power cord from being walked on or pinched particularly at plugs, convenience receptacles, and the point where they exit from the apparatus.
- 11) Only use attachments / accessories specified by the manufacturer.
- 12) Use only with the cart, stand, tripod, bracket or table specified by the manufacturer, or sold with the apparatus. When a cart is used, use caution when moving the cart / apparatus combination to avoid injury from tip-over.
- 13) Unplug this apparatus during lightning storms or when unused for long periods of time.
- 14) Refer all servicing to qualified service personnel. Servicing is required when the apparatus has been damaged in any way, such as power-supply cord or plug is damaged, liquid has been spilled or objects have fallen into the apparatus, the apparatus has been exposed to rain or moisture, does not operate normally, or has been dropped.
- 15) Operate only from the type of power source indicated on the marking label. If you are not sure of the type of power supplied to your home consult your television dealer or local power company.
- 16) Follow all warnings and instructions marked on the LCD TV.
- 17) Never push objects of any kind into this LCD TV through cabinet slots as they may touch dangerous voltage points or short out parts that could result in a fire or electric shock. Never spill liquid of any kind on the LCD TV.
- 18) If an outside antenna is connected to the television equipment, be sure the antenna system is grounded so as to provide some protection against voltage surges and built up static charges. In the U.S. Section 810-21 of the National Electrical Code provides information with respect to proper grounding of the mast and supporting structure, grounding of the lead-in wire to an antenna discharge unit, size of grounding conductors, location of antenna discharge unit, connection to grounding electrodes, and requirements for the grounding electrode.

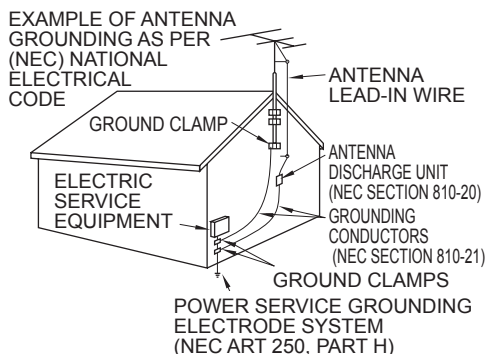

- 19) An outside antenna system should not be located in the vicinity of overhead power lines, other electric light, power circuits, or where it can fall into such power lines or circuits. When installing an outside antenna system, extreme care should be taken to keep from touching such power lines or circuits as contact with them might be fatal.
- 20) Unplug this LCD TV from the wall outlet and refer servicing to qualified service personnel under the following conditions:
  - a. When the power cord or plug is damaged or frayed.
  - b. If liquid has been spilled into the LCD TV.
  - c. If the LCD TV has been exposed to rain or water.
  - d. If the LCD TV does not operate normally by following the operating instructions.

Adjust only those controls that are covered by the operating instructions as improper adjustment of other controls may result in damage and will often require extensive work by a qualified technician to restore the LCD TV to normal operation.
  - e. If the LCD TV has been dropped or the cabinet has been damaged.
  - f. When the LCD TV exhibits a distinct change in performance - this indicates a need for service.
- 21) When replacement parts are required, be sure the service technician uses replacement parts specified by the manufacturer that have the same characteristics as the original parts. Unauthorized substitutions may result in fire, electric shock, or other hazards.
- 22) **WARNING: TO REDUCE THE RISK OF FIRE OR ELECTRIC SHOCK, DO NOT EXPOSE THIS APPARATUS TO RAIN, MOISTURE, DRIPPING OR SPLASHING. DO NOT PLACE LIQUID CONTAINERS (FLOWER VASES, CUPS, COSMETICS, ETC.) ABOVE THE SET (INCLUDING ON SHELVES ABOVE, ETC.).**
- 23) **WARNING: SMALL PARTS CAN PRESENT CHOKING HAZARD IF ACCIDENTALLY SWALLOWED. KEEP SMALL PARTS AWAY FROM YOUNG CHILDREN. DISCARD UNNEEDED SMALL PARTS AND OTHER OBJECTS, INCLUDING PACKAGING MATERIALS AND PLASTIC BAGS/SHEETS TO PREVENT THEM FROM BEING PLAYED WITH BY YOUNG CHILDREN, CREATING THE POTENTIAL RISK OF SUFFOCATION.**
- 24) **WARNING: To prevent the spread of fire, keep candles or other open flames away from this product at all times.**
- 25) **CAUTION:** The Power switch on this unit will not completely shut off all power from AC outlet. Since the power cord serves as the main disconnect device for the unit, you will need to unplug it from the AC outlet to shut down all power.

Therefore, make sure the unit has been installed so that the power cord can be easily unplugged from AC outlet in case of an accident. To avoid fire hazard, the power cord should also be unplugged from the AC outlet when left unused for a long period of time (for example, when on vacation).
- 26) **CAUTION:** TO PREVENT ELECTRIC SHOCK, DO NOT USE THIS PLUG WITH A RECEPTACLE OR OTHER OUTLET UNLESS THE BLADES CAN BE FULLY INSERTED TO PREVENT BLADE EXPOSURE.
- 27) **CAUTION:** USE WITH OTHER STAND MAY RESULT IN INSTABILITY POSSIBLY CAUSING INJURY.
- 28) **CAUTION:** DANGER OF EXPLOSION IF BATTERY IS INCORRECTLY REPLACED. REPLACE ONLY WITH THE SAME OR EQUIVALENT TYPE.
- 29) **CAUTION: This LCD TV is for use only with the following optional accessory. Use with any other type of optional accessories may cause instability which could result in the possibility of injury.**

(All of the following accessories are manufactured by Panasonic Corporation)

  - Wall-hanging bracket: TY-WK23LR2W

Always be sure to ask a qualified technician to carry out set-up.



**NOTE:** This equipment is designed to operate in North America and other countries where the broadcasting system and AC house current are exactly the same as in North America.

## FCC STATEMENT

This equipment has been tested and found to comply with the limits for a Class B digital device, pursuant to Part 15 of the FCC Rules. These limits are designed to provide reasonable protection against harmful interference in a residential installation. This equipment generates, uses and can radiate radio frequency energy and, if not installed and used in accordance with the instructions, may cause harmful interference to radio communications. However, there is no guarantee that interference will not occur in a particular installation. If this equipment does cause harmful interference to radio or television reception, which can be determined by turning the equipment off and on, the user is encouraged to try to correct the interference by one or more of the following measures:

- Reorient or relocate the receiving antenna.
- Increase the separation between the equipment and receiver.
- Connect the equipment into an outlet on a circuit different from that to which the receiver is connected.
- Consult the dealer or an experienced radio/TV technician for help.

This device complies with Part 15 of the FCC Rules. Operation is subject to the following two conditions: (1) This device may not cause harmful interference, and (2) this device must accept any interference received, including interference that may cause undesired operation.

### FCC Caution:

**To assure continued compliance, follow the attached installation instructions and use only shielded interface cables when connecting to computer or peripheral devices. Any changes or modifications not expressly approved by Panasonic Corp. of North America could void the user's authority to operate this device.**

### FCC Declaration of Conformity Model No. TC-L19C30

Responsible Party: Panasonic Corporation of North America  
One Panasonic Way, Secaucus, NJ 07094  
Contact Source: Panasonic Consumer Electronics Company  
1-877-95-VIERA (958-4372)  
email: consumerproducts@panasonic.com

## CEA CHILD SAFETY NOTICES

### WARNING

Flat panel displays are not always supported on the proper stands or installed according to the manufacturer's recommendations. Flat panel displays that are inappropriately situated on dressers, bookcases, shelves, desks, speakers, chests or carts may fall over and may cause personal injury or even death.

The consumer electronics industry (of which Panasonic is a member) is committed to making home entertainment enjoyable and safe. To prevent personal injury or death, be sure to follow the following safety guidelines:

### TUNE INTO SAFETY:

- One size does NOT fit all. Follow the manufacturer's recommendations for the safe installation and use of your flat panel display.
- Carefully read and understand all enclosed instructions for proper use of this product.
- Don't allow children to climb on or play with furniture and television sets.
- Don't place flat panel displays on furniture that can easily be used as steps, such as a chest of drawers.
- Remember that children can become excited while watching a program, especially on "larger than life" flat panel displays. Care should be taken to install the display where it cannot be pushed, pulled over, or knocked down.
- Care should be taken to route all cords and cables connected to the flat panel display so that they cannot be pulled or grabbed by curious children.

### WALL MOUNTING: IF YOU DECIDE TO WALL MOUNT YOUR FLAT PANEL DISPLAY, ALWAYS:

- Use a mount that has been recommended by the display manufacturer and/or listed by an independent laboratory (such as UL, CSA, ETL).
- Follow all instructions supplied by the display and wall mount manufacturers.
- If you have any doubts about your ability to safely install your flat panel display, contact your retailer about professional installation.
- Make sure the wall where you are mounting the display is appropriate. Some wall mounts are not designed to be mounted to walls with steel studs or old cinder block construction. If you are unsure, contact a professional installer.
- A minimum of two people are required for installation. Flat panel displays can be heavy.

**Panasonic recommends that a qualified installer perform the wall-mount installation. See page 5.**

**The American Academy of Pediatrics discourages television viewing for children younger than two years of age.**

 **CEA**  
Consumer Electronics Association  
[www.CE.org/safety](http://www.CE.org/safety)

# Accessories/Optional Accessory

## Accessories

✓ Check you have all the items shown.

### Accessories

- Remote Control Transmitter
- N2QAYB000570



- Batteries for the Remote Control Transmitter (2)
- AA Battery

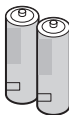

- Pedestal
- TBLX0218

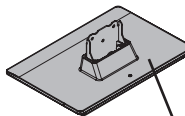

How to assemble (p. 8)

**Accessories**  
Assembly screws (3)  
XYN4+F12FJK



M4 x 12

- Owner's Manual
- Child safety
- Quick Start Guide
- Product Registration Card (U.S.A)

### Optional Accessory

- Wall-hanging bracket**
- TY-WK23LR2W

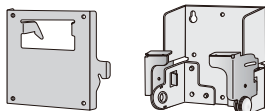

The angle of wall-hanging bracket can be adjusted from “-5-degree tilting” to “10-degree tilting” for this TV.

Please contact your nearest Panasonic dealer to purchase the recommended wall-hanging bracket. For additional details, please refer to the wall-hanging bracket installation manual.

#### Back of the TV

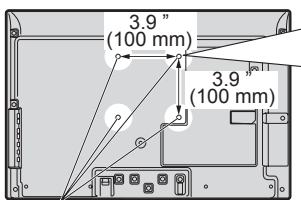

Holes for wall-hanging bracket installation

Screw for fixing the TV onto the wall-hanging bracket (not supplied with the TV)

**Depth of screw:**  
Minimum: 0.24" (6.0 mm)  
Maximum: 0.31" (8.0 mm)

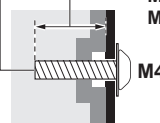

(View from the side)

#### WARNING

- Customer assumes liability if mounting the unit themselves or if a Panasonic bracket is not used. Any damage resulting from not having a professional installer mount your unit will void your warranty.
- Always be sure to ask a qualified technician to perform any necessary set-up. Incorrect fitting may cause equipment to fall, resulting in injury and product damage.
- Do not mount the unit directly below ceiling lights (such as spotlights, floodlights or halogen lights) which typically give off high heat. Doing so may warp or damage plastic cabinet parts.
- Take care when fixing wall brackets to the wall. Always ensure that there are no electrical cables or pipes in the wall before hanging the bracket.
- When using an angled-type wall hanging bracket, please ensure that there is sufficient space for the connecting cables so that they do not press against the wall when the TV is tilted forward.
- For safety reasons, remove units no longer being used from their wall-mounted locations.



## Attaching the pedestal to TV

### ■ Set-up

- Fix securely with assembly screws (A). (Total 3 screws)
- Tighten screws firmly.

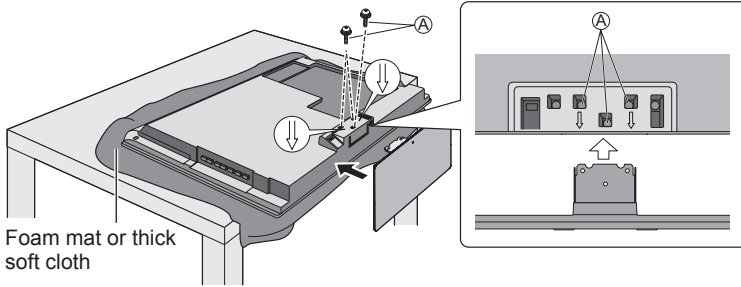

Foam mat or thick soft cloth

### WARNING

**Do not disassemble or modify the pedestal.**

- Otherwise the TV may fall over and become damaged, and personal injury may result.

### Caution

**Do not use any pedestal other than that provided with this TV.**

- Otherwise the TV may fall over and become damaged, and personal injury may result.

**Do not use the pedestal if it becomes warped or physically damaged.**

- If you use the pedestal when it is physically damaged, personal injury may result. Contact your nearest Panasonic Dealer immediately.

**During set-up, make sure that all screws are securely tightened.**

- If sufficient care is not taken to ensure screws are properly tightened during assembly, the pedestal will not be strong enough to support the TV, and it might fall over and become damaged, and personal injury may result.

## Adjust the panel to your desired angle

- Ensure that the pedestal does not wobble and the TV does not fall over when adjusting the panel.

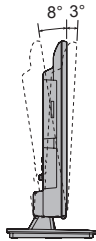
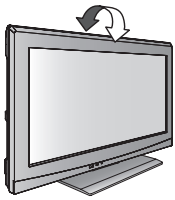

(View from the side)

## Installing the remote's batteries

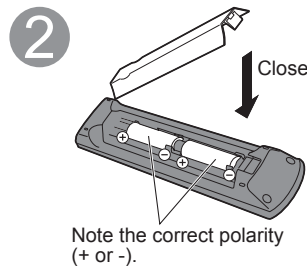
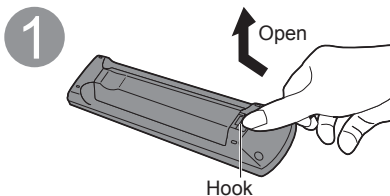

### Caution

- Incorrect installation may cause battery leakage and corrosion, resulting in damage to the remote control.
  - Do not mix old and new batteries.
  - Do not mix different battery types (such as alkaline and manganese batteries).
  - Do not use rechargeable (Ni-Cd) batteries.
- Do not burn or break batteries.

# Connections

## Connection Panels

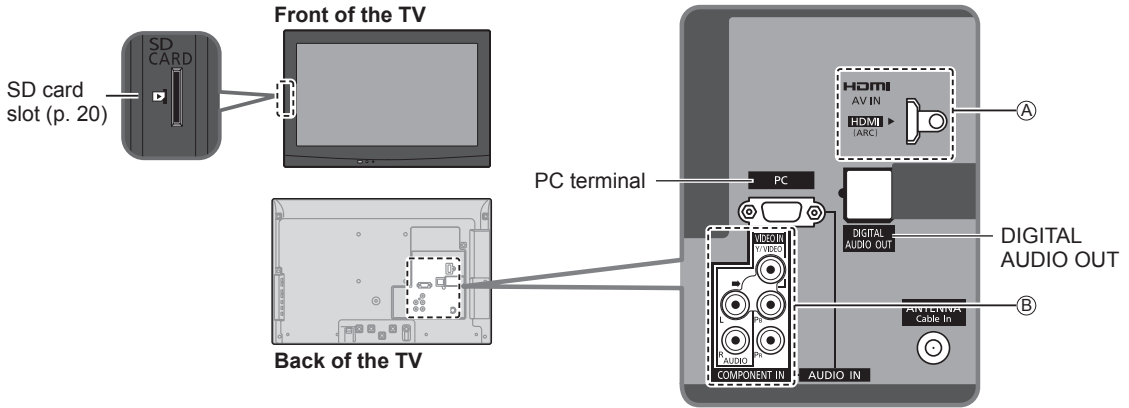

## Antenna or Cable connection

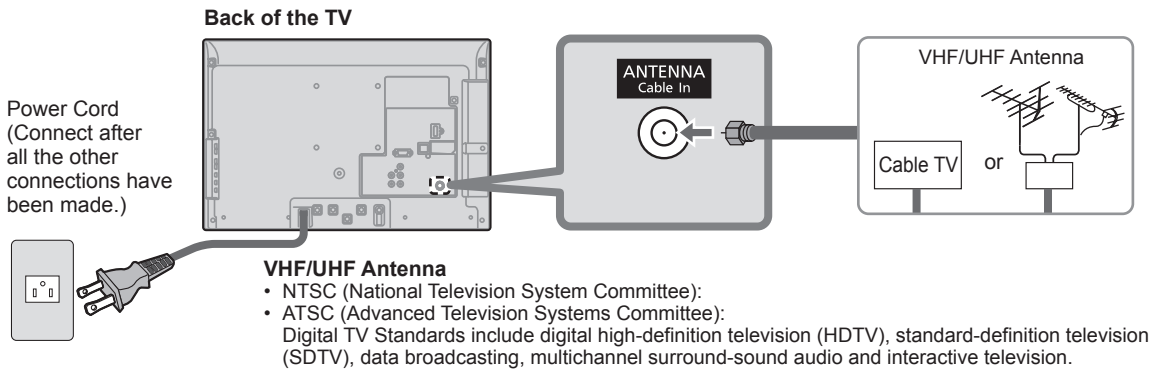

### Cable

- You need to subscribe to a cable TV service to enjoy viewing their programming.
  - You may need to subscribe to a high-definition (HD) cable service to enjoy HD programming.
- The connection for high-definition can be done with the use of an HDMI or Component Video cable. (p. 10)

### Note

- When using a Cable box, external equipment and video cables shown in this manual are not supplied with the TV.
- For additional assistance, visit us at: [www.panasonic.com/help](http://www.panasonic.com/help)  
[www.panasonic.ca](http://www.panasonic.ca)

## Connection references

### ■ Antenna terminal

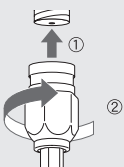

- Firmly tighten by hand.

### ■ Pin terminals

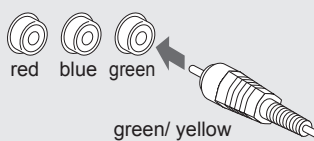

- Insert firmly.

### ■ HDMI terminal

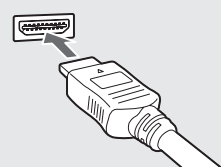

- Insert firmly.

## AV cable connection

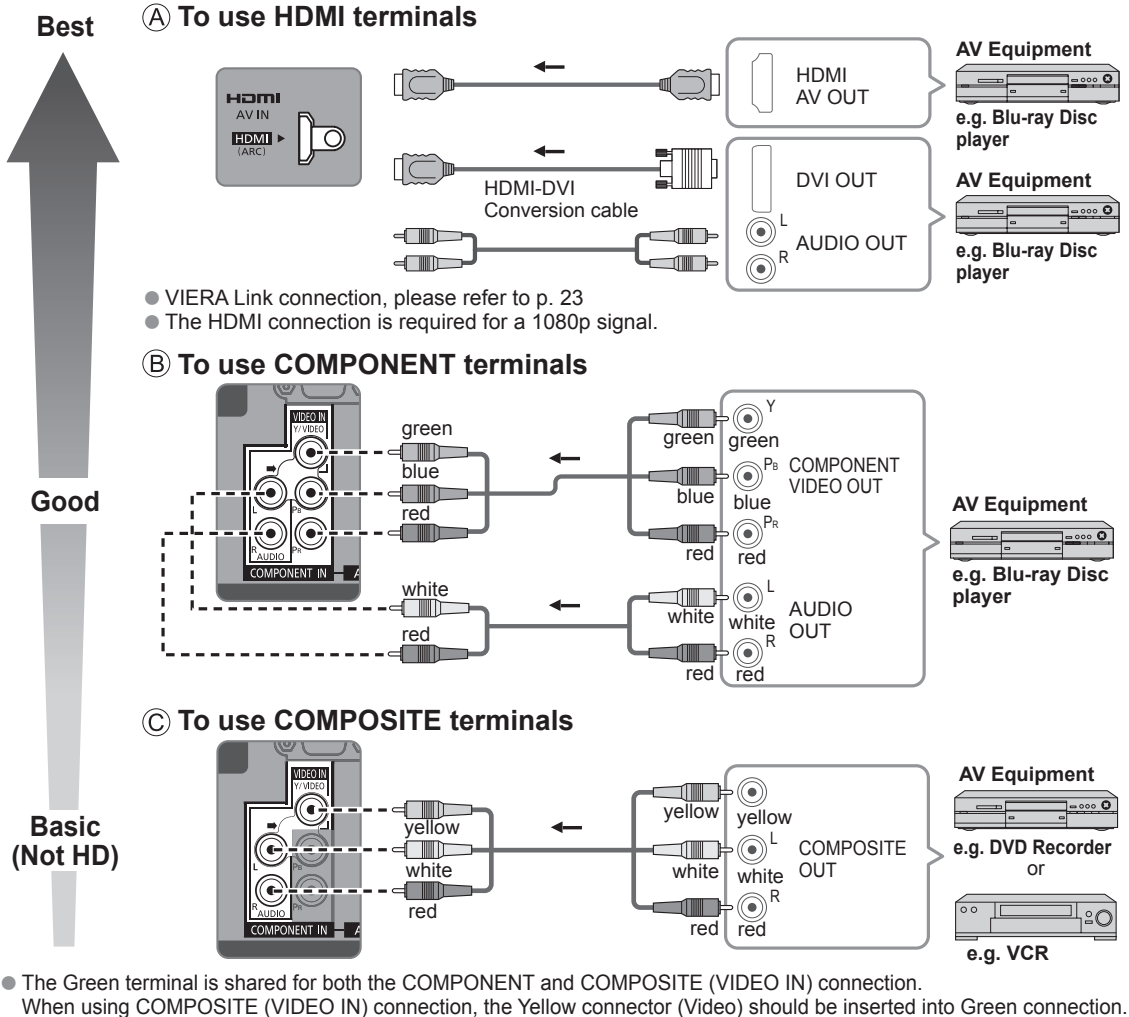

## Audio connection

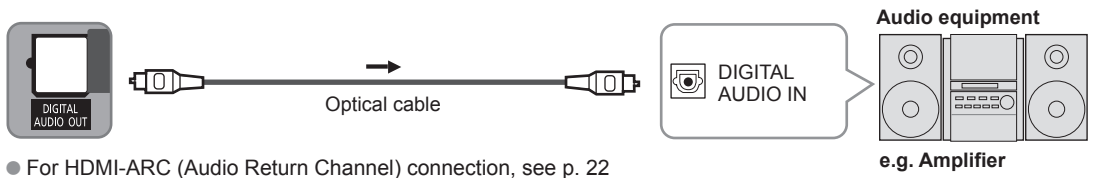

## PC / Computer connection (VGA)

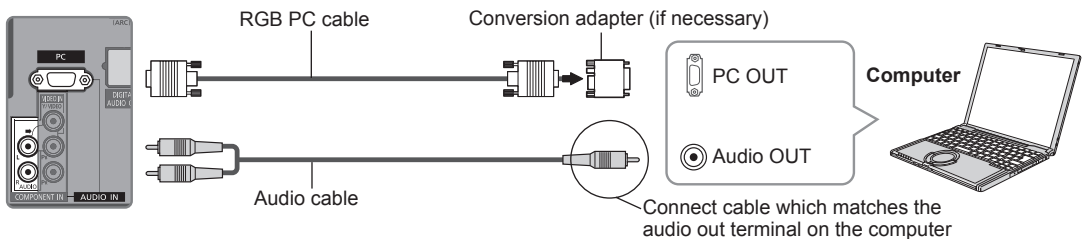

# Identifying Controls

## TV controls/indicators

### Front of the TV

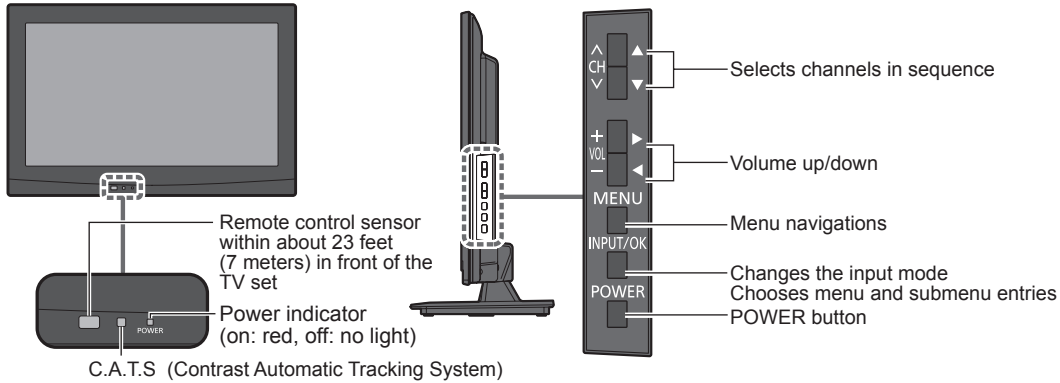

### Note

- The TV consumes a small amount of electric energy even when turned off.
- Do not place any objects between the TV remote control sensor and remote control.

## Remote control

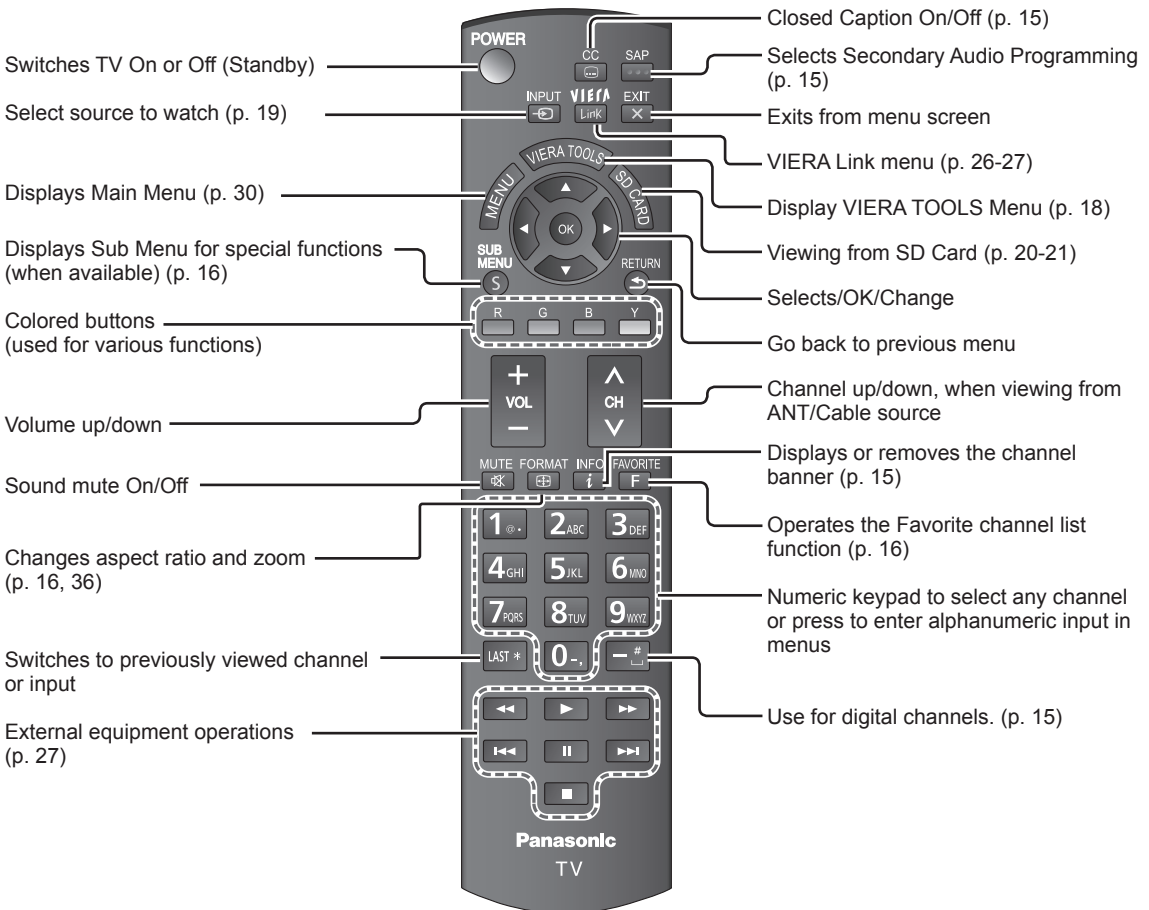

# First Time Setup

First time setup screen is displayed only when the TV is turned on for the first time after the power cord is inserted into a wall outlet and when “Auto power on” (p. 34) is set to “No”.

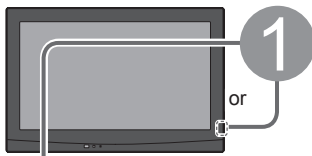

## Turn the TV On with the POWER button

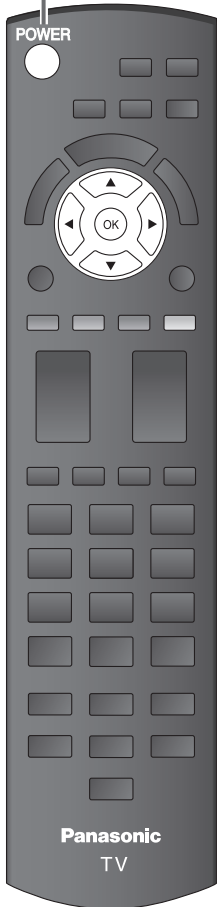
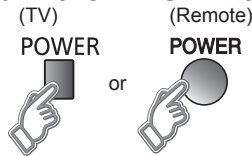

## 2 Configure your viewing mode

### ① Select your language

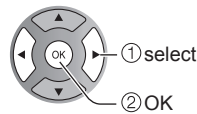
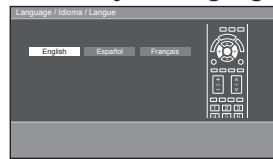

### ② Select your viewing mode (Be sure to select “Home use”)

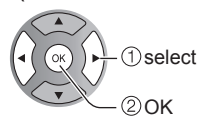
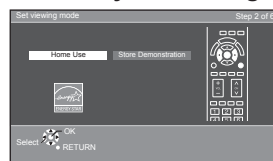

- Please confirm your selection (Home Use) before pressing OK button.

### ■ If you select “Store Demonstration” by mistake in ②, confirmation screen will be displayed.

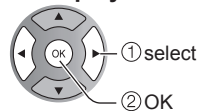
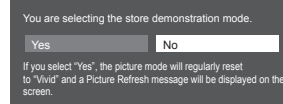

- Select “No” and return to previous screen ②.
- If you select “Yes”, Screen enters the store demonstration mode.

To display the “Set viewing mode” screen again as shown above and select “Home Use”, do one of the following:

- Press and hold down the side POWER button for at least five seconds.
- Unplug power cord for 30 seconds and plug it again.

### Note

- If you use any other step other than ② then turn the TV off, or if you used the EXIT button to quit before completing the settings, the next time you turn the TV on, “First time setup” will not be automatically displayed.
  - The settings up to that point are saved.
  - You can start “First time setup” at any time. (p. 34)
- Language, ANT/Cable setup, Input labels, and Clock can also be changed in the Settings Menu. (p. 34)

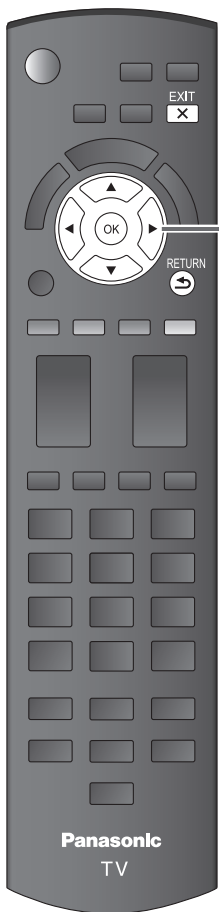

### 3 Auto channel setup (ANT/Cable setup)

#### ① Select the connected Antenna in terminal

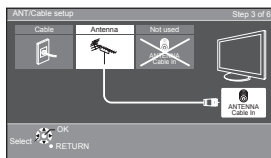

Not used: Go to ④  
(Label inputs)

Select "**Not used**" when no wire is connected to the "Antenna/Cable" terminal.

- Typical when a Cable/Satellite box is connected to a TV AV input.
- Prevents accidental tuning to an unavailable signal, when Cable or Satellite box is used.

#### ② Select "Start"

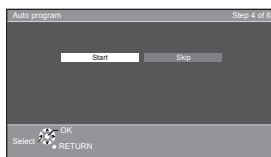

Skip: Go to ④  
(Label inputs)

#### Start scanning the channels

(Available channels are automatically set.)

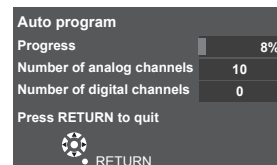

This process may take up to 20 minutes.

- This step is not needed when a Cable or Satellite box is connected to an AV input.

#### ③ Complete the Auto program setup

Completion message is displayed when the Auto program scan is successfully completed.

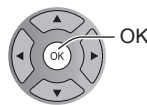
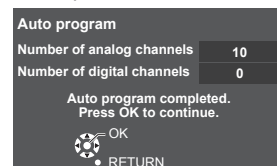

If there is no available channel, return to ③ - ① (ANT/ Cable setup). "Not used" will be selected.

#### ■ Press to go back to the previous screen

RETURN



#### Note

- About broadcasting systems

#### Analog (NTSC):

Conventional broadcasting

#### Digital (ATSC):

New programming that allows you to view more channels featuring high-quality video and sound

#### ■ Operation of the EXIT button during "First time setup"

Press the button once to display confirmation screen. Press again to close confirmation screen.

#### [EXIT confirmation screen]

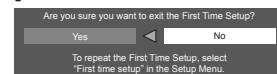

Yes ➔ Exit "First time setup"  
No ➔ Return to the original screen.



4

### Give names to the TV's inputs (Label inputs)

When done, select NEXT and press OK to go to the next step.

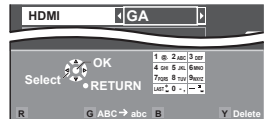
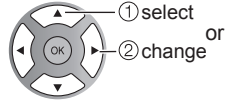
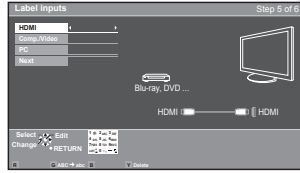

Follow the instructions on screen to complete the following operations.

Label: [BLANK] Not used/Blu-ray/DVD/DVD REC/HOME THTR/GAME/COMPUTER/VCR/CABLE/SATELLITE/DVR/CAMERA/MONITOR/AUX/RECEIVER/MEDIA CTR/MEDIA EXT/OTHER

- Select "Not used" for any back-panel input that has no device connected to it. Afterward, the input will be skipped when pressing INPUT, for your convenience.
- The input labels can be changed at any time from the TV's setup menu.

5

### Adjust the Clock (Set clock)

When done, select NEXT and press OK to go to the next step.

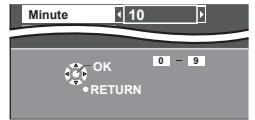
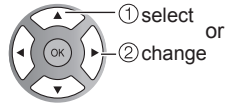
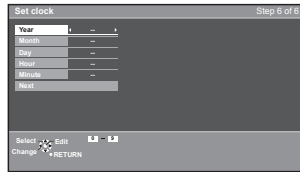

Follow the instructions on screen to complete the following operations.

6

### Complete the First time setup

Congratulations! You are done.

The First time setup can be repeated at any time. Press MENU and select SETUP; then "First time setup".

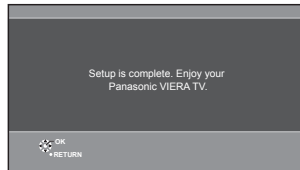

■ Press to go back to the previous screen



To watch TV via a Cable box, Satellite receiver, or any other source (DVD, DVR, gaming device, etc.), press the INPUT button and select the appropriate input.

# Watching TV



**1** Turn power on  
(Remote) (TV)

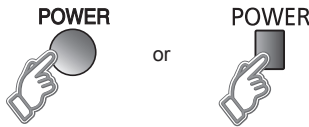

**Note**

● Please select correct input --> (p. 19)

**2** Select a channel number

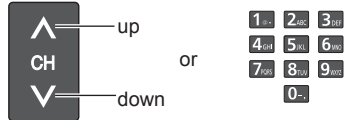

● Also available side CH button on the unit.  
**[For Cable/Satellite box connection]**  
 - Use your connected box's remote control.

■ To directly enter the digital channel number

# When tuning to a digital channel, press the button to enter the minor number in a compound channel number.

example: CH15-1:

**Note**

- Reselect "Cable" or "Antenna" in "ANT in" of "ANT/Cable setup" to switch the signal reception between cable TV and antenna. (p. 13, 28)
- The channel number and volume level remain the same even after the TV is turned off.

■ Other Useful Functions

**Listen with SAP (Secondary Audio Programming)**

■ Select the Audio mode for watching TV



**Digital mode**

Press SAP to select next Audio track (if available) when receiving a digital channel.

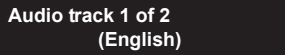

**Analog mode**

Press SAP to select the desired Audio mode.

- Each press of SAP will change the Audio mode. (Stereo/SAP/Mono)
- SAP is not available when watching TV with a Cable or Satellite box connected via HDMI.
- Contact your Cable or Satellite operator for instructions on enabling SAP with their box.

**Closed Caption**

■ Switches the Closed Caption mode On or Off

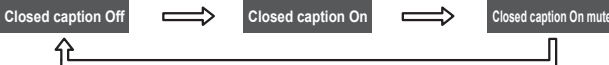

- Closed Caption is not available when watching TV with a Cable or Satellite box connected via HDMI.
- Contact your Cable or Satellite operator for instructions on enabling CC with their box.

**Displaying Information**

■ Displays and removes information. When watching programming via the Antenna/Cable input, shows the channel banner.

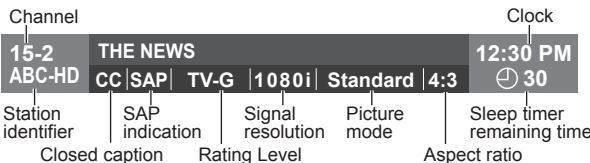



## Change aspect ratio and Zoom the picture

### ■ Press **FORMAT** to cycle through the aspect modes (p. 36)

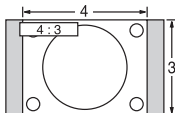

- 480i, 480p: FULL/JUST/4:3/ZOOM
- 1080p, 1080i, 720p: FULL/H-FILL/JUST/4:3/ZOOM

Use when the picture does not fill the whole screen (bars appear on either side of the image) or portions of the picture is trimmed.

#### Note

1. Some content, such as film-based movies, are available in extra-wide format. Top and bottom bars are unavailable.
2. Connected devices, such as Cable/Satellite box, DVD/Blu-ray players and game consoles have their own aspect (format) settings. Adjust the device's aspect settings.

## Display the SUB MENU

### ■ Press **SUB MENU** to show the Sub Menu screen

This menu consists of shortcuts to convenient functions.

Sub menu is only available when the TV is using the Antenna/Cable input, not when using Cable or Satellite box.

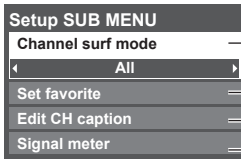

- Channel surf mode — Specify favorites or type of channels to view when pressing the channel up/down button.
- Set favorite — Set favorite channel (below)
- Edit CH caption — Edit the channel identifier (p. 29)
- Signal meter — Check the signal strength (p. 29)

## Call up a favorite channel

### ■ FAVORITE

Channel numbers registered in Favorite are displayed on the favorite tune screen. Select the desired broadcast station with the cursor or use the number buttons. (p. 15)

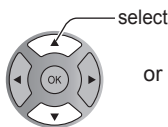
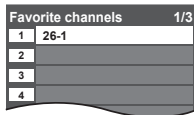

or



### ■ Set the Favorite channel

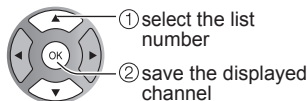
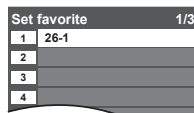
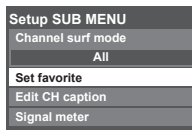

or

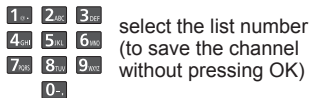

### ■ Delete a favorite channel

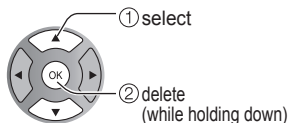
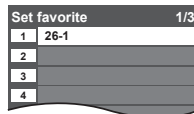

### ■ To change the page



Press repeatedly to change between pages (1/3, 2/3, 3/3 or exit)



Changes the page forward/backward

- Favorite channels cannot be set when using Cable or Satellite box.

## Other Useful Operations

### Entering characters

You can use the remote control keys to enter the alphanumeric characters.

#### Switches input mode.



ABC → abc → 123

#### Press each number key to cycle through the alphanumeric character.

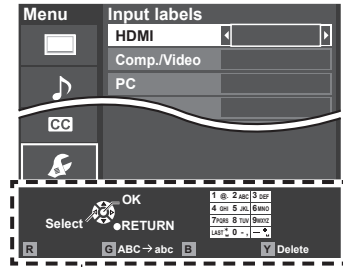

Navigation area

### Password setting/entering

You need to enter the password when you access locked channel or inputs.

#### Input your 4-digit password

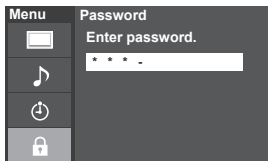

- If it is your first time entering the password, enter the password twice in order to register it.
- Make a note of your password. Do not forget it. (If you have forgotten your password, consult your local dealer.)
- When you select a locked channel, a message will be displayed that allows you to view the channel after you input your password.
- Change password (p. 33)

# Using VIERA TOOLS

VIERA TOOLS is the easy way to access the TV's special features. They are displayed as shortcut icons on the TV screen.

**1 Display VIERA TOOLS**



**2 Select the item**

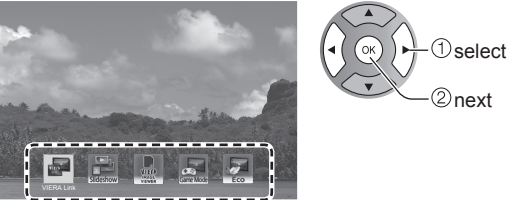

**3 Set each item**

- VIERA Link



➔ VIERA Link (p. 26-27)

- Slideshow



➔ Slideshow (p. 20-21)

- VIERA IMAGE VIEWER



➔ VIERA IMAGE VIEWER (p. 20-21)

- Game mode



➔ Game mode setting (Game/Standard) (p. 31)

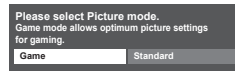

- Eco mode



➔ ECO/energy saving (p. 34)

■ Press to exit from a menu screen



■ Press to go back to the previous screen

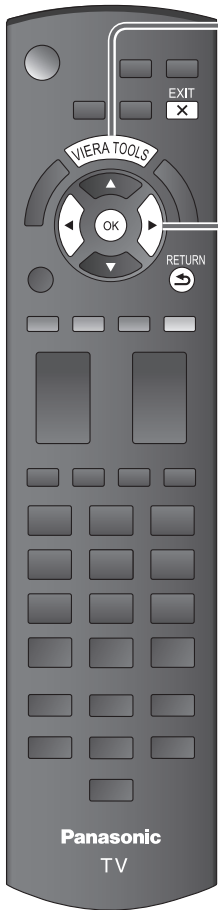

# Watching content from external devices

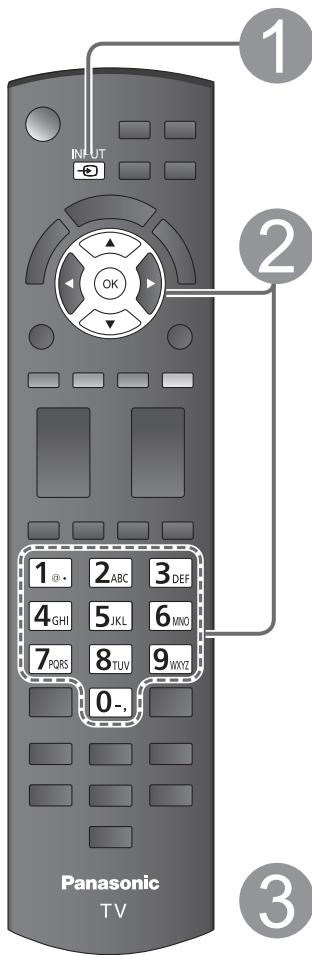

1 With the connected equipment turned On  
**Display the Input select menu**



2 **Select the input mode**

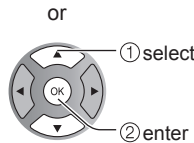
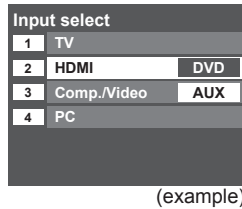

(shortcut) press the corresponding NUMBER button on the remote control to select the input of your choice. Or, press the INPUT button repeatedly, to cycle through the available inputs.  
 \* set unused input to "Not used" (below) for quick skipping.

Select the input of your choice, then press OK.

- During the selection, if no action is taken for several seconds, the "Input select" menu disappears.
- The terminal and label (names) of the connected equipment are displayed. To label each of the inputs, see below.



**Note**

- The input label will be displayed on the "Input select" screen if the Input label was customized.

3 **Operate the connected device directly by using its own remote control.**

**Note**

- PC adjustments (p. 31)

■ **Label each input**

① Select "Input labels" in "Setup"

② For each input, press to select a label or to edit

• Labeling each input with names of connected devices such as DVD Player, Cable box, etc. will help you to identify and switch between them.

- See p. 34 for list of available label names.
- You can also enter the label name directly. (Entering characters (p. 17))

# Viewing photos with VIERA IMAGE VIEWER

The VIERA Image Viewer lets you easily view still images on the television by simply inserting an SD card into the VIERA SD card slot.



1

## Insert the SD card

- Insert the card
- Remove the card
- Compliant card type (maximum capacity): SDHC Card (32 GB), microSDHC Card (32 GB), SD Card (2 GB), miniSD Card (2 GB), microSD Card (2 GB) (requiring microSDHC Card/miniSD Card/microSD Card adapter)
- If a microSDHC Card, miniSD Card or microSD Card is used, insert / remove it together with the adapter.
- For cautions and details on SD Cards (p. 37)

Gently insert the SD Card label surface facing front.

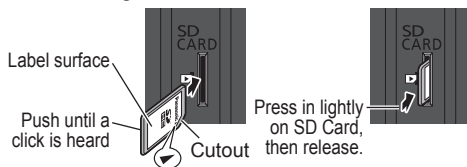

2

## Display "VIERA IMAGE VIEWER"



- Auto play setting  
➔ Image viewer auto play (p. 34)

### ■ Using VIERA TOOLS (p. 18)



Select the item

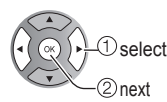

VIERA IMAGE VIEWER ➔ Displayed Thumbnail screen.  
Slideshow ➔ Start slideshow.

3

## Select the data to be viewed

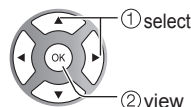
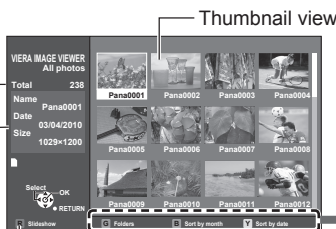

To start Slideshow  
Selected picture information is displayed.  
Total number of images.

### Note

- Depending on the JPEG file format, "Information" contents may not be displayed correctly. Refer to p. 37 (Data format for SD card browsing) for details.

4

## View

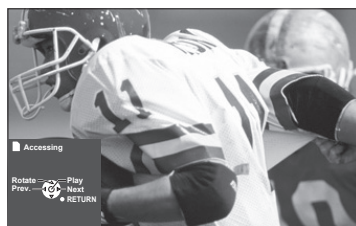

Displays one at a time

Navigation area

Present status  
(While reading the data)

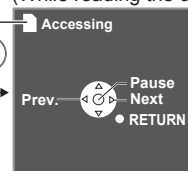
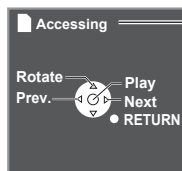

Single photo view

Slideshow

- To display/hide the Navigation area  
➔ INFO
- Return to the Thumbnail view RETURN

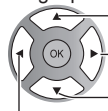

Rotate 90 degrees (counter-clockwise)

To next photo

Rotate 90 degrees (clockwise)

To previous photo

- Press to exit from a menu screen



- Press to go back to the previous screen



## Sort

■ To sort by Folder, month or date

In ②

① Select the sort type

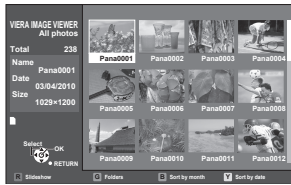

- G Folders (ascending order of numeric/alphabetical)
- B Sort by month (ascending order of the month)
- Y Sort by date (ascending order of the date)

② Select the directory.

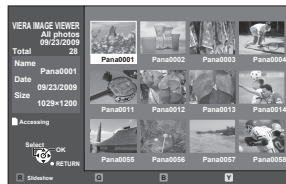
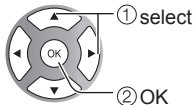
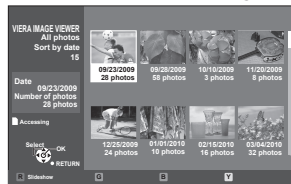

RETURN



Go back to previous screen

## Photo settings

In ② or ③

① Display "Photo settings"



② Select the item

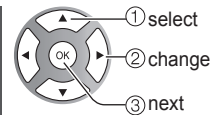
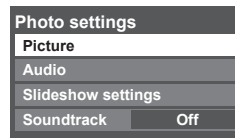

■ Adjust the picture/Audio

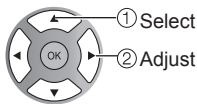
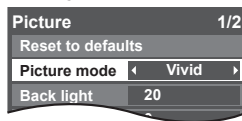

example :Picture menu  
Picture menu/Audio menu (p. 31-32)

■ Set the Soundtrack

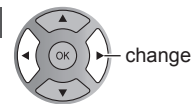

Select the music from 5 options.  
(Off/Music 1/Music 2/Music 3/Music 4/Music 5)

■ Slideshow settings

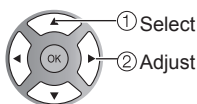
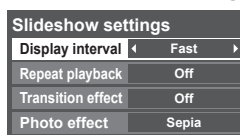

**Note**

● To stop in mid-cycle → Press RETURN



<b>Display interval</b>	Set how many seconds each image is displayed in the Slideshow mode. (Short/Fast/Normal/Slow/Very slow)
<b>Repeat playback</b>	Turn the slideshow Repeat (cycle) function on or off (Off/On).
<b>Transition effect</b>	Select the transition effect shown between photos (Off/Wipe ↓/Wipe ↑/Wipe →/Wipe ←/Comb ↑/Comb ↓/Comb →/Comb ←/Dissolve/Checker wipe/Random/Array/Collage)
<b>Photo effect</b>	Select the display effect (Off/Sepia/Gray scale)

# VIERA Link™ “HDAVI Control™”\*

Simultaneously control all Panasonic “HDAVI Control” equipped components using one button on the TV remote. Enjoy additional HDMI Inter-Operability with compatible Panasonic products.

This TV supports “HDAVI Control 5” function.

Connections to equipment (DVD recorder DIGA, HD Camcorder, Home theater system, Amplifier, etc.) with HDMI cables enables VIERA Link controls.

Equipment with the “HDAVI Control” function enables the following operations:

Version	Operations (See p. 24-27, for more information)
HDAVI Control or later	<ul style="list-style-type: none"><li>● Automatic Input Switching</li><li>● Power on link</li><li>● Power off link</li><li>● Default speakers</li><li>● Speaker control</li></ul>
HDAVI Control 2 or later	<ul style="list-style-type: none"><li>● VIERA Link control only with the TV's remote control</li><li>● Unselected device energy save (for available equipment only)</li></ul>
HDAVI Control 3 or later	<ul style="list-style-type: none"><li>● Provides setting information (Language, time, etc.)</li><li>● Automatic lip-sync function</li></ul>
HDAVI Control 4 or later	<ul style="list-style-type: none"><li>● Energy saving mode (with Quick Start mode)</li></ul>
HDAVI Control 5	<ul style="list-style-type: none"><li>● Audio Return Channel Audio Return Channel (ARC) is a function that enables digital sound signals to be sent via an HDMI cable back from the TV to a connected audio device.</li></ul>

■ **When adding new equipment, reconnecting equipment or changing the setup after the connection, turn the equipment on and then switch the TV on. Set the input mode to HDMI (p. 19), and make sure that the image is displayed correctly.**

VIERA Link “HDAVI Control”, is based on the control functions provided by HDMI and industry standard known as HDMI CEC (Consumer Electronics Control), with unique function that we have developed and added. As such, its operation with other manufacturers' equipment that supports HDMI CEC cannot be guaranteed.

Please refer to the individual manuals for other manufacturers' equipment supporting the VIERA Link function.

## ■ HDMI cable

This function needs an HDMI compliant (fully wired) cable. Non-HDMI-compliant cables cannot be utilized.

It is recommended that you use Panasonic's HDMI cable. Recommended part number:

RP-CDHS15 (4.9 ft/1.5 m), RP-CDHS30 (9.8 ft/3.0 m), RP-CDHS50 (16.4 ft/5.0 m)

\* For more details on the external equipment's connections, please refer to the operating manual for the equipment.

# VIERA Link™ Connections (with VIERA Link function)

## ■ Terminal overview

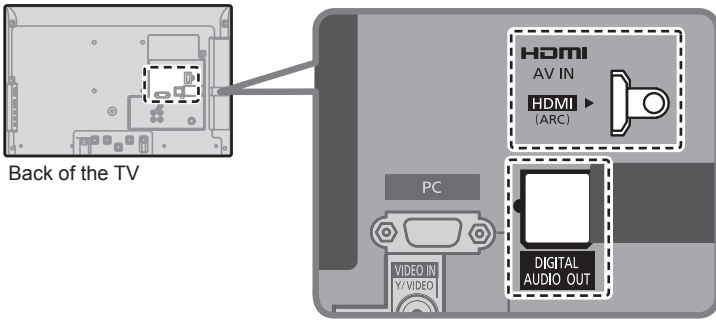

Back of the TV

## ■ Connecting DVD Recorder (DIGA)

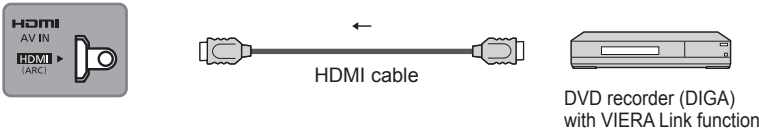

## ■ Connecting Home theater system/AV amp

HDMI 1 is recommended.

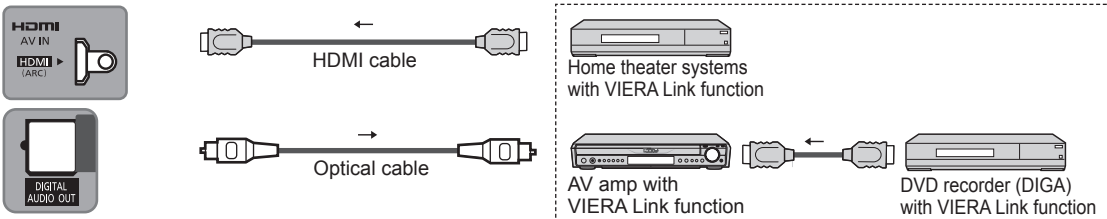

No optical cable is necessary when connecting a Home Theater supporting "HDAVI control 5" with an HDMI cable. Audio will be supported via ARC (Audio Return Channel) (p. 22)

- One AV amp and one DVD recorder (DIGA) can be operated with this unit.

## ■ Connecting HD Camcorder/Digital camera

Press INPUT and select an available HDMI terminal, then connect the camcorder to this input. After connection, confirm the HDAVI control functions. (p. 24-27)

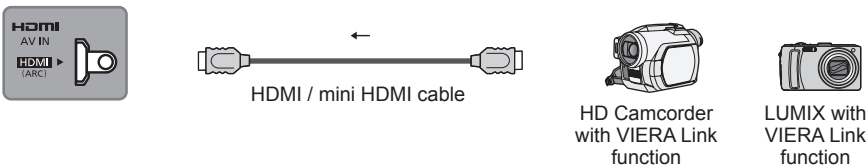

If connection (or setting) of equipment compatible with HDAVI control is changed, switch the power of this unit Off and On again while the power of all equipment is On (so that the unit can correctly recognize the connected equipment) and check that the connected equipment playback operates.

### Note

- Individual HDMI equipment may require additional menu settings specific to each model. Please refer to their respective manuals.
- When audio from other equipment connected to this unit via HDMI is output using "DIGITAL AUDIO OUT" of this unit, the system switches to 2CH audio.  
(When connecting to an AV amp via HDMI, you can enjoy higher sound quality.)
- Some devices use Mini-HDMI terminal. HDMI (type A) to Mini-HDMI (type C) cable or adapter should be used.



## VIERA Link settings and Available features

To use all VIERA Link functions: After everything is connected, in VIERA Link settings menu, set "VIERA Link" to "On". Some features are disabled depending on the "HDAVI Control" version of the equipment. Please check the list (p. 22)

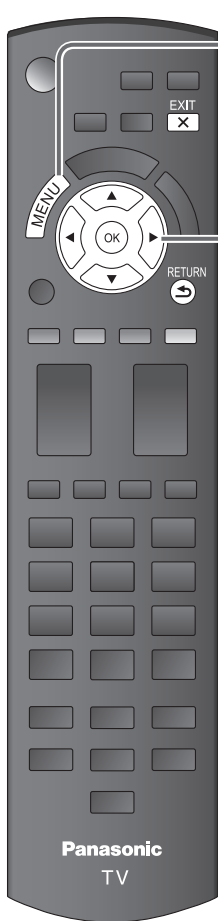

### 1 Display the menu



### 2 Select "VIERA Link settings" in "Setup"

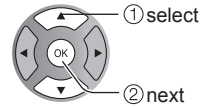
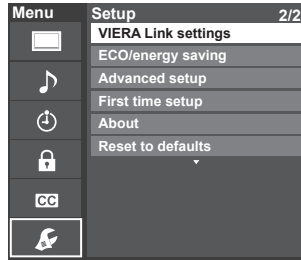

### 3 Select "VIERA Link"

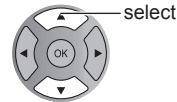
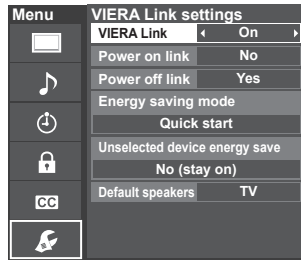

### 4 Select "On"

(default is On)

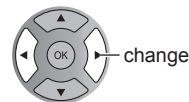

■ Press to exit from a menu screen



■ Press to go back to the previous screen



### 5 Select and make other settings

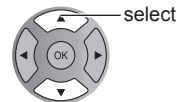
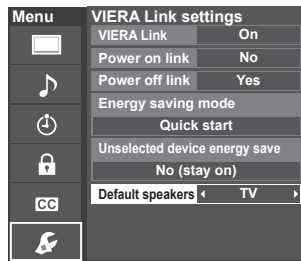

## Automatic Input Switching

When using a Blu-ray Disc player, DVD player/recorder or Home theater system, the TV will automatically change to the appropriate input, when playback begins on one of those devices.

- For a Home theater system the speakers automatically switch to the theater system.

## Power on link

Yes: The TV is turned on automatically and switches to the appropriate HDMI input whenever VIERA Link compatible equipment is initially turned on and the Play mode is selected.

## Power off link

When “Yes” is selected and the TV is turned off, all connected VIERA Link compatible equipment is also automatically turned off.

- A Panasonic DVD Recorder will not turn off if it is still in Rec mode.
- The TV remains on even if the VIERA Link compatible equipment is turned off.

## Energy saving mode

Quick Start: When TV is turned off, all connected VIERA Link compatible equipment is moved to ECO Standby mode\* automatically under these conditions.

- Power off link:(Yes), The connected equipment has “HDMI Control 4 or later (with Quick Start mode)”
- \* Minimum power consumption of Standby condition for the equipment.

## Unselected device energy save

Yes: The connected VIERA Link compatible equipment will be turned off automatically when not in use under these conditions.

- The connected equipment has “HDMI Control 2 or later” (for available equipment only)

[ Example of timing for operation ]

- When the input is switched from the HDMI.

## Default speakers

“TV” is the default setting. To set the Home theater system as Default speakers, change the Default speakers setting from “TV” to “Theater”. Sound will be output from the Home theater whenever the TV is powered on.

## Automatic lip-sync function

Minimizes lip-sync delays between the picture and audio when you connect to a Panasonic theater system or Amplifier.

## TV provided setting information

The following information about the TV settings can be transmitted to each piece of equipment (Recorder/Home theater/Player) that has “HDMI Control 3 or later” function connected to a TV with an HDMI cable.

Transmittable data	Recorder	Home theater	Player
① On Screen Display Language setting (English/Español/Français)	○	○	○
② Panel Aspect Ratio (16:9 fixed)	○	○	○
③ Closed caption information (Mode/CC type/Digital setting)	○	---	---

### Note

- There is a possibility that all the GUI language information might be set from equipment that has an HDMI CEC function connected to the TV with an HDMI cable. Depending on the operating conditions or the specification for each piece of equipment the setting may or may not be applied.
- For more details on the external equipment’s operation, please refer to the operating manual for the equipment.

## VIERA Link menu and Available features

Some features are disabled depending on the "HDAVI Control" version of the equipment. Please check the list (p. 22)



### 1 Display the VIERA Link menu



or

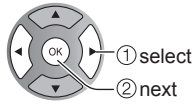

### 2 Select the item

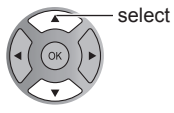
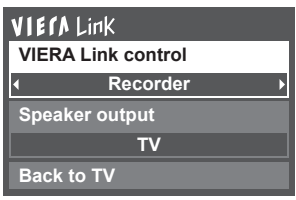

Items in the VIERA Link menu may be grayed out if no compatible equipment is connected (must be HDAVI Control 2 or later) or if the equipment has not initiated a connection with the TV. In that case, switch the equipment's power Off and On while the TV is On. For further details, see "VIERA Link" on page 24.

### 3 Select

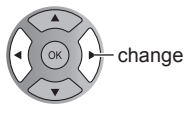
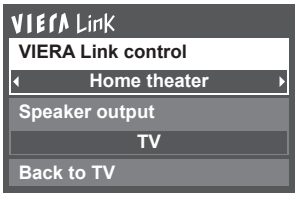

### 4 Set

- Press to exit from a menu screen  
EXIT  
EXIT
- Press to go back to the previous screen  
RETURN  
RETURN

## Speaker control

You can select the Home theater or TV speakers for audio output.

Control the theater speakers with the TV remote control. This function is available only when a Panasonic Amplifier or Player theater is connected.

### ① Select “Speaker output”

### ② Select “Home theater” or “TV”

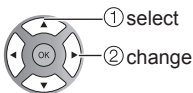
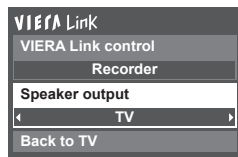

### ■ Home theater: Adjustment for the equipment

Volume up / down →

Mute →

- The sound of the TV is muted.
- When the equipment is turned off, the TV speakers take over.
- Selecting “Home theater” turns the equipment on automatically if it is in Standby mode.

### ■ TV: The TV speakers are on.

## VIERA Link control only with the TV’s remote control

In the VIERA Link menu, you can select HDMI connected equipment and access it quickly. Continue using your TV remote control to operate the equipment, pointing it at the TV.

### ① Select “VIERA Link control”

### ② Select the equipment you want to access (Recorder/Home theater/Player/Camcorder/LUMIX/ Digital camera)

- Using VIERA TOOLS (p. 18)

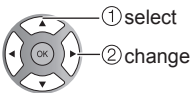
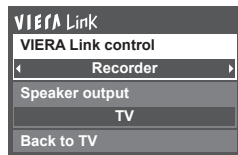

You can select available items only.

- If there is more than one equipment item, a number after the name indicates the number of items. (e.g. Recorder 1/Recorder 2/Recorder 3...)

- The number of equipment items that can be connected is three for recorders, and a total of three for Home theater/Player/Camcorder/LUMIX/Digital camera.

#### Note

- There is a limit to the number of HDMI connectors.

### ③ Operate the equipment with the TV remote control, pointing it at the TV

- To operate the equipment, read the manual of the equipment.

### ■ Available TV remote control buttons

Whether an operation is available differs depending on the connected equipment.

	Move the cursor/Select		Play
	Set/Access		Stop
	Return to previous menu		Reverse/Forward
	Display the functions menu on the equipment		Skip Reverse/Forward
	Available when the purpose of the keys is displayed on screen		Pause
	Exit		Closed caption
	Channel Up/Down		SAP (Select Audio Mode)
	0-9		Select digital subchannel

## Back to TV

Returns the input selection of the device selected with the VIERA Link Control to the TV input.

### Select “Back to TV”

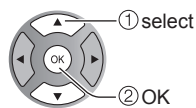
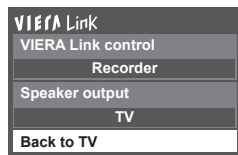

# Editing and Setting Channels

The current channel settings can be changed according to your needs and reception conditions.

## ANT/Cable setup and operation

**1 Display the menu**

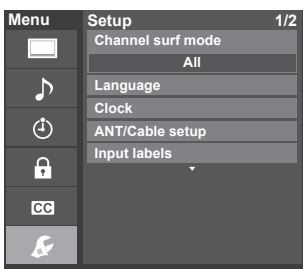
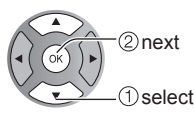

**2 Select "Setup"**

**3 Select "ANT/Cable setup"**

■ Press to exit from a menu screen

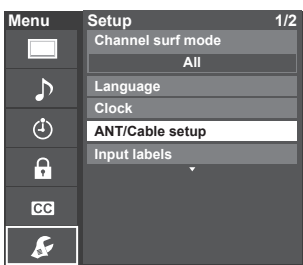
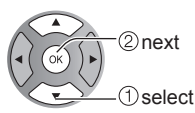

## Auto program (Set automatically)

Automatically searches and adds available channels to the memory.

**① Select "ANT in"**

➔ Select "Cable" or "Antenna"  
Or select "Not used" (p. 13).

**② Select "Auto program"**

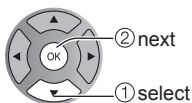
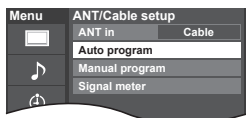

**③ Select a scanning mode (p. 13)**

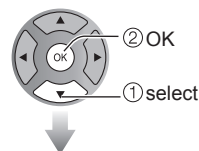
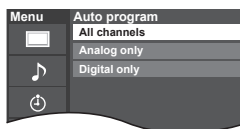

- After the scanning is completed, select "Apply". (see p. 29 ⑤).
- All previously saved channels are erased.

## Manual program (Set manually)

Use this procedure when changing the channel setup or changing the channel display.  
Also, use this to add or skip channels from the channel list manually.

You can select a channel tuning mode (Digital only/Analog only) in "Channel surf mode" (p. 34)

### ① Select "Edit"

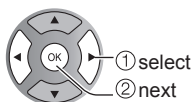
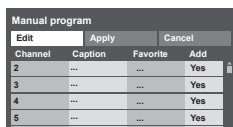

### ② Select the item to edit

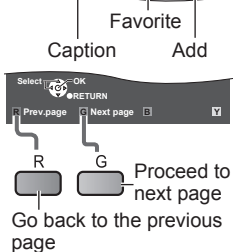
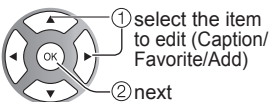
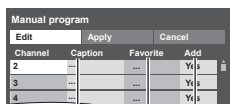

- **Caption:**  
Changes the station identifier
- **Favorite:**  
Registers channels to the Favorite List
- **Add:**  
Adds or skips channels

### ③ Edit

#### ● Caption

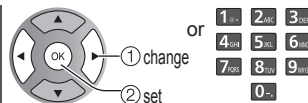
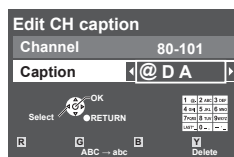

#### Caption

Select or edit the station identifier.  
(maximum 7 characters available)



#### ● Favorite

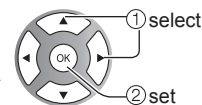

**Set favorite** Select the number

#### ● Add

Press OK to select "Yes (add)" or "No (skip)"



### ④ Move the cursor to a channel number

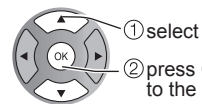
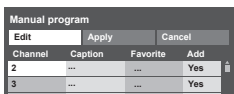

### ⑤ Select "Apply"

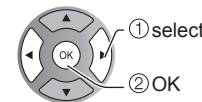

## To cancel the Edit

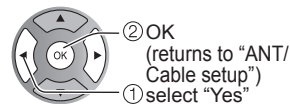
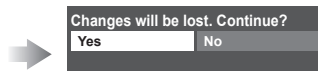
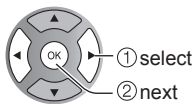
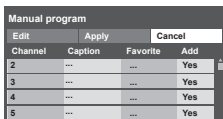

## Signal meter (Check signal strength)

Check the signal strength if interference is found or freezing occurs on a digital image.

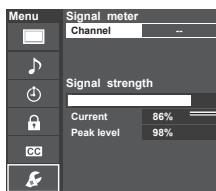

Signal intensity

- If the signal is weak, check the antenna.  
If no problem is found, consult your local dealer.

#### Note

- Not available if "Cable" is selected in "ANT in" (see p. 28).
- Available only for digital antenna channels.

# How to Use Menu Functions

Various menus allow you to make settings for the picture, sound, and other functions so that you can enjoy watching TV best suited for you.

## 1 Display the menu

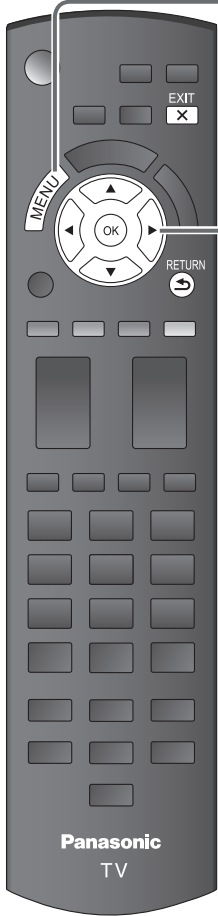

- Shows the functions that can be adjusted.
- Some functions will be disabled depending on the type of input signal.

### Menu structure

Menu bar  
Press OK to move to the Menu items.

Menu items  
Press OK to proceed to next screen if available.

Help information

Operation guide

(example: Input labels)

## 2 Select the menu

- Picture settings
- Audio settings
- Timer (Sleep, On/Off timer)
- Lock (Channel, Game, Program etc.)
- Closed Caption setting
- Setup (other settings)

## 3 Adjust or select a menu item

■ Press to exit from a menu screen



■ Press to go back to the previous screen



Menu Picture 1/2

Reset to defaults

Picture mode ◀ Vivid ▶

Back light 20

Contrast 0

Brightness 0

Color 0

Tint 0

Sharpness 0

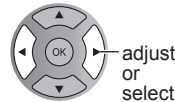

(example: Picture menu)

- “Reset to default” will be grayed out if no changes are made in the following menus: “Picture”, “PC adjustments”, “Audio” and “Closed caption”.

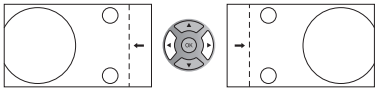
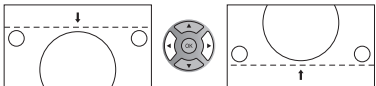
 <b>Picture settings</b>		Adjust the image or picture quality	
Settings	Items	Item Description	
<b>Reset to defaults</b>		Resets all picture adjustments to factory default settings except for “Advanced picture”.	
<b>Picture mode</b>	<b>Vivid</b>	Provides enhanced picture contrast and sharpness for viewing in a well-lit room.	
	<b>Standard</b>	Recommended for normal viewing conditions with subdued room lighting.	
	<b>Cinema</b>	For watching movies in a darkened room. It provides a soft, film-like picture.	
	<b>Game</b>	For playing video games.	
	<b>Custom (Photo)</b>	Customizes each item according to your taste. Photo is displayed in JPEG menu.	
<b>Back light</b>		Adjusts the luminance of the back light.	
<b>Contrast, Brightness, Color, Tint, Sharpness</b>		Adjusts the color, brightness, etc. for each picture mode to suit your taste	
		• Display range	Contrast/Brightness/Color/Sharpness : 0 - 100 Tint : -50 - +50
<b>Color temp.</b>	<b>Cool/Normal/Warm</b>	Selects a choice of Cool (blue), Normal, or Warm (red) color.	
<b>A.I. picture</b>	<b>Off/On</b>	Controls dark areas without affecting the black level or brightness in the overall picture.	
<b>C.A.T.S.</b>	<b>Off/On</b>	Automatically adjusts the screen brightness according to the ambient lighting condition.	
<b>Video NR</b>	<b>Off/On</b>	Reduces noise, commonly called snow. Leave it off when receiving a strong signal.	
• Some menus are grayed out depending on the input signal or condition. (e.g. “Zoom adjustments” will be grayed out if the aspect is not set to Zoom.)			
<b>Aspect adjustments</b>	<b>Screen format</b>	<b>JUST/4:3/ZOOM/ FULL/H-FILL</b>	Changes the format (aspect ratio). Lets you choose the aspect depending on the format of received signal. (p. 36)
	<b>H size</b>	<b>Size 1/Size 2</b>	Adjusts the horizontal display range to reduce noise of both side edges of an image. Size 2: Adjusts the image size according to the aspect mode to reduce noise. (p. 36)
	<b>Zoom adjustments</b>		Adjusts vertical alignment and size when aspect setting is “ZOOM”.
<b>PC adjustments</b>	<b>Reset to defaults</b>	Resets PC adjustments.	
	<b>Sync</b>	<b>H &amp; V</b>	The H and V sync signals are input from the HD/VD connector. (p. 39)
		<b>On green</b>	Uses a synchronized signal on the Video G signal, which is input from the G connector. (p. 39)
	<b>Dot clock</b>	Alleviates the problem if a picture appears to be vertically-striped, flickers partially or is blurred.	
	<b>H-position</b>	Adjusts the horizontal position.	
	<b>V-position</b>	Adjusts the vertical position.	
	<b>Clock phase</b>	Alleviates the problem if the whole picture appears to flicker or is blurred. First adjust the Dot Clock to get the best possible picture, then adjust the clock Phase so that a clear picture appears. ● It may not be possible to display a clear picture due to poor input signals.	
	<b>Input resolution</b>	Switches to wide display. ● VGA (640×480 pixels), WVGA (852×480 pixels), XGA (1,024×768 pixels), WXGA (1,280×768 pixels) ● Options change depending on signals	
	<b>H-frequency</b>	Displays the H (Horizontal)/V (Vertical) frequencies.	
	<b>V-frequency</b>	Display range Horizontal: 15 - 110 kHz Vertical: 48 - 120 Hz	



Settings	Items	Item Description
<ul style="list-style-type: none"> <li>Some menus are grayed out depending on the input signal or condition. (e.g. "3:2 pulldown" will be grayed out if the input signal is high definition or you are viewing photos, etc.)</li> </ul>		
<b>Advanced picture</b>	<b>3D Y/C filter</b>	<b>Off/On</b> Minimizes noise and cross-color in the picture.
	<b>Color matrix</b>	<b>SD/HD</b> Selects image resolution of component-connected devices. SD: Standard Definition HD: High Definition Only used with 480p video signal.
	<b>MPEG NR</b>	<b>Off/On</b> Reduces noise of specific digital signals of DVD, Cable box, etc.
	<b>Black level</b>	<b>Dark/Light</b> Selects Dark or Light. Valid only for external input signals.
	<b>3:2 pulldown</b>	<b>Off/On/Auto</b> Adjusts the picture recorded in 24 fps for optimum quality.

### **Audio settings** Adjust Audio quality

Settings	Items	Item Description
<b>Reset to defaults</b>		Resets Bass, Treble, and Balance adjustments to factory default settings.
<b>Bass</b>		Increases or decreases the bass response.
<b>Treble</b>		Increases or decreases the treble response.
<b>Balance</b>		Emphasizes the left / right speaker volume.
<b>Advanced audio</b>	<b>Surround</b>	<b>Off/On</b> Enhances audio L/R response when listening to stereo.
	<b>Volume leveler</b>	Minimizes volume disparity after switching to external inputs.
	<b>TV speakers</b>	<b>Off/On</b> Switches to "Off" when using external speakers. Off: "Surround" and "Volume leveler" do not work if "Off" is selected.
	<b>HDMI in</b>	<b>Digital/Comp./Video</b> The default setting is "Digital" for the HDMI connection. (Digital input signal) Select audio input terminal when DVI cable is connected. (Analog audio input signal)

### **Timer settings** The TV can automatically turn On/Off at the designated date and time.

If the Timer settings are grayed out, first set the clock (see p. 34) and make sure "Auto power on" is set to "No" (see p. 34)

Settings	Items	Item Description
<b>Sleep (Off timer)</b>	<b>Sleep (minutes)</b>	<b>0/15/30/60/90</b> Select how long for the TV to automatically turn off.
<b>Timer 1-5 (On/Off timer)</b>	<b>Timer set</b>	Enables or disables this timer. (Off/On)
	<b>Inputs</b>	Sets the input to select when the TV turns on.
	<b>Channel</b>	Sets the channel to select when the TV turns on.
	<b>Day</b>	Sets the day when the TV turns on. [SUN/MON/TUE/WED/THU/FRI/SAT(displays the nearest future date) MON-FRI/SAT-SUN/DAILY/Every SUN/Every MON/Every TUE/Every WED/Every THU/Every FRI/ Every SAT]
	<b>On time</b>	Sets the time when the TV turns on. The TV will turn off after 90 minutes or as specified.
	<b>Off time</b>	Sets the time when the TV turns off within 24 hours.



## Locks specified channels or shows to prevent children from watching objectionable content.

You will be asked to enter your password each time you display the Lock menu.

- Password setting/entering (p. 17)

Set "Custom" in "Mode" to specify "Channel", "Game" and "Program" settings.

Settings	Items	Item Description
<b>Mode</b>	<b>Off</b>	Unlocks all the Lock settings of "Channel", "Game" and "Program".
	<b>All</b>	Locks all the inputs regardless of the Lock settings of "Channel", "Game" and "Program".
	<b>Custom</b>	Locks specified inputs of "Channel", "Game" and "Program".
<b>Channel</b> (These channels will be blocked regardless of the program rating.)	<b>Mode</b>	Set channel lock status. (Off/All/Custom) All: Locks all channels Off: Unlocks all channels Custom: Locks specified channels. Set "Channel 1" - "Channel 7"
	<b>Channel 1-7</b>	Select a channel to lock. (Select up to 7 (1-7) channels to block.)
<b>Game</b>	<b>On/Off</b>	Locks Channel 3, Channel 4, and external inputs.
<b>Program</b> (To set a rating level)	<b>Mode</b>	Set program lock status. (Off/On) "V-chip" technology enables restricted shows to lock according to TV ratings. On: Set each rating level (MPAA, U.S.TV, C.E.L.R., C.F.L.R.)
	<b>MPAA</b>	Select U.S. movie ratings to lock.
	<b>U.S.TV</b>	U.S. TV program ratings.
	<b>C.E.L.R.</b>	Canadian English ratings.
	<b>C.F.L.R.</b>	Canadian French ratings.
<b>Change password</b>		Change the password. Input the new 4-digit password twice.

- This television is designed to support the "Downloadable U.S. Region Rating System" when available. (Available only in U.S.A.)
- The Off rating is independent of other ratings.
- When placing a lock on a specific-age-based-rating level, the Off rating and any other more restrictive ratings will also be blocked.

## CC Closed caption Display closed caption

The television includes a built-in decoder that is capable of providing a text display of the audio. The program being viewed must be transmitting the Closed caption (CC) information. (p. 38)

Settings	Items	Item Description
<b>Reset to defaults</b>		Resets all Closed caption settings to factory default settings.
<b>Mode</b>	<b>On/Off/CC on mute</b>	On: To display Closed captions. CC on mute: To display Closed captions when the audio is muted. (When not using, select "Off").
	<b>Analog</b>	<b>CC1-4/T1-4</b> Choose the Closed caption service of Analog broadcasting. CC1-4: Information related to pictures (Appears at the bottom of the screen) T1-4: Textual information (Appears over the entire screen)
<b>Digital</b>	<b>Primary/Second./Service 3/4/5/6</b>	The Digital Closed caption menu lets you configure the way you choose to view the digital captioning.
<b>Digital setting</b> (Set display settings in digital program)	<b>Size</b>	Text size
	<b>Font</b>	Text font
	<b>Style</b>	Text style (Raised, Depressed, etc.)
	<b>Foreground</b>	Color of text
	<b>Fore. opacity</b>	Opacity of text
	<b>Background</b>	Color of text box
	<b>Back. opacity</b>	Opacity of text box
	<b>Outline</b>	Outline color of text (Identify the setting options on the screen.)

- The settings in "Analog" or "Digital" depend on the broadcaster.

Settings	Items	Item Description
<b>Channel surf mode</b>	<b>All/Favorite/Digital only/Analog only</b>	Sets the mode to select the channel with the Channel up/down button. Favorite: Only channels registered as FAVORITE. (p. 16)
<b>Language</b>	<b>English/Español/Français</b>	Selects the screen menu language.
<b>Clock</b>		Adjusts the clock. (p. 14)
<b>ANT/Cable setup</b>	See p. 28-29 for more detail.	
<b>Input labels</b> (Display labels of connected devices)	<b>Selects the terminal and label of the external equipment.</b> Devices connected to external input terminals can be labeled for easier identification during the input selection. (Input select (p. 19)) Terminals: HDMI/Comp./Video/PC Label: [BLANK] Not used/Blu-ray/DVD/DVD REC/HOME THTR/GAME/COMPUTER/VCR/CABLE/SATELLITE/DVR/CAMERA/MONITOR/AUX/RECEIVER/MEDIA CTR/MEDIA EXT/OTHER	• You can also enter the label name directly. (Entering characters (p. 17))
<b>VIERA Link settings</b>	See p. 24-25 for more detail.	
<b>ECO/energy saving</b>	<b>Power save (Standard/Saving)</b>	Reduces screen brightness to lower power consumption. Eye-friendly for viewing in a dark room.
	<b>No signal for 10 minutes (Stay on/ Power TV off)</b>	To conserve energy, the TV automatically turns off when NO SIGNAL and NO OPERATION continue for more than 10 minutes. • Not in use when "Auto power on" is set to "Yes", or "On/Off Timer" is set. • "No signal for 10 minutes was activated" will be displayed for about 10 seconds when the TV is turned on for the first time after the power was turned off by "No signal for 10 minutes". • The on-screen display will flash 3, 2 and 1 to indicate the last three (3) remaining minutes prior to the shut-off.
	<b>No activity for 3 hours (Stay on/ Power TV off)</b>	To conserve energy, the TV automatically turns off when no operation of remote and side panel key continues for more than 3 hours. • Not in use when "Auto power on" is set to "Yes", or "On/Off Timer" is set, or while "PC input" is selected. • "No activity for 3 hours was activated" will be displayed for about 10 seconds when the TV is turned on for the first time after the power was turned off by "No activity for 3 hours". • The on-screen display will flash 3, 2 and 1 to indicate the last three (3) remaining minutes prior to the shut-off.
<b>Advanced setup</b>	<b>Auto power on (No/Yes)</b>	Turns TV On automatically when the cable box or connected device is turned On. TV AC cord must be plugged into this device. TV turns on every time the power is restored.
	<b>Image viewer auto play</b>	<b>Slideshow/Thumbnail/ Set later/Off</b> Sets the playback type to play back SD cards automatically. Set later: "Image viewer settings" menu will be displayed repeatedly. "Viewing photos with VIERA IMAGE VIEWER" (p. 20)
<b>First time setup</b>		Restarts the first time setup from "Language" setting. (p. 12)
<b>About</b>		Displays TV version and software license.
<b>Reset to defaults</b>		Performing Reset will clear all settings made with Setup, such as channel settings. • Password setting/entering (p. 17)

# Ratings List for parental control

“V-chip” technology enables you to lock channels or shows according to standard ratings set by the entertainment industry.

## ■ U.S. MOVIE RATINGS (MPAA)

NR	NO RATING (NOT RATED) AND NA (NOT APPLICABLE) PROGRAMS. Movie which has not been rated or where rating does not apply.
G	GENERAL AUDIENCES. All ages admitted.
PG	PARENTAL GUIDANCE SUGGESTED. Some material may not be suitable for children.
PG-13	PARENTS STRONGLY CAUTIONED. Some material may be inappropriate for children under 13.
R	RESTRICTED. Under 17 requires accompanying parent or adult guardian.
NC-17	NO ONE 17 AND UNDER ADMITTED.
X	ADULTS ONLY.

## ■ U.S. TV PROGRAMS RATINGS (U. S. TV)

Age-based Group	Age-based Ratings	Possible Content Selections	Description
NR (Not Rated)	TV-NR	<ul style="list-style-type: none"> <li>Viewable</li> <li>Blocked</li> </ul>	Not Rated.
Youth	TV-Y	<ul style="list-style-type: none"> <li>Viewable</li> <li>Blocked</li> </ul>	All children. The themes and elements in this program are specifically designed for a very young audience, including children from ages 2-6.
	TV-Y7	<ul style="list-style-type: none"> <li>FV Blocked</li> <li>Viewable</li> <li>Blocked</li> </ul>	Directed to older children. Themes and elements in this program may include mild physical or comedic violence, or may frighten children under the age of 7.
Guidance	TV-G	<ul style="list-style-type: none"> <li>Viewable</li> <li>Blocked</li> </ul>	General audience. It contains little or no violence, no strong language, and little or no sexual dialogue or situations.
	TV-PG	<ul style="list-style-type: none"> <li>D,L,S,V (all selected)</li> <li>Any combination of D, L, S, V</li> </ul>	Parental guidance suggested. The program may contain infrequent coarse language, limited violence, some suggestive sexual dialogue and situations.
	TV-14	<ul style="list-style-type: none"> <li>D,L,S,V (all selected)</li> <li>Any combination of D, L, S, V</li> </ul>	Parents strongly cautioned. This program may contain sophisticated themes, sexual content, strong language and more intense violence.
	TV-MA	<ul style="list-style-type: none"> <li>L,S,V (all selected)</li> <li>Any combination of L, S, V</li> </ul>	Mature audiences only. This program may contain mature themes, profane language, graphic violence, and explicit sexual content.

FV: Fantasy/Cartoon Violence. V: Violence S: Sex L: Offensive Language D: Dialogue with sexual content.

## ■ CANADIAN ENGLISH RATINGS (C. E. L. R.)

E	Exempt - Exempt programming includes: news, sports, documentaries and other information programming, talk shows, music videos, and variety programming.
C	Programming intended for children under age 8. No offensive language, nudity or sexual content.
C8+	Programming generally considered acceptable for children 8 years and over. No profanity, nudity or sexual content.
G	General programming, suitable for all audiences.
PG	Parental Guidance suggested. Some material may not be suitable for children.
14+	Programming contains themes or content which may not be suitable for viewers under the age of 14. Parents are strongly cautioned to exercise discretion in permitting viewing by pre-teens and early teens.
18+	18+ years old. Programming restricted to adults. Contains constant violence or scenes of extreme violence.

## ■ CANADIAN FRENCH RATINGS (C. F. L. R.)

E	Exempt - Exempt programming.
G	General - Programming intended for audience of all ages. Contains no violence, or the violence content is minimal or is depicted appropriately.
8 ans+	8+ General - Not recommended for young children. Programming intended for a broad audience but contains light or occasional violence. Adult supervision recommended.
13 ans+	Programming may not be suitable for children under the age of 13 - Contains either a few violent scenes or one or more sufficiently violent scenes to affect them. Adult supervision strongly suggested.
16 ans+	Programming may not be suitable for children under the age of 16 - Contains frequent scenes of violence or intense violence.
18 ans+	Programming restricted to adults. Contains constant violence or scenes of extreme violence.

### Caution

- The V-Chip system that is used in this set is capable of blocking “NR” programs (non rated, not applicable and none) as per FCC Rules Section 15.120(e)(2). If the option of blocking “NR” programs is chosen “unexpected and possibly confusing results may occur, and you may not receive emergency bulletins or any of the following types of programming:”
  - Emergency Bulletins (Such as EAS messages, weather warnings and others)
  - Locally originated programming • News • Political • Public Service Announcements • Religious • Sports • Weather

# Technical Information

## Aspect Ratio (FORMAT)

Press the **FORMAT** button to cycle through the aspect modes. This lets you choose the aspect depending on the format of the received signal and your preference. (p. 16)  
(e.g.: in case of 4:3 image)

### ● FULL

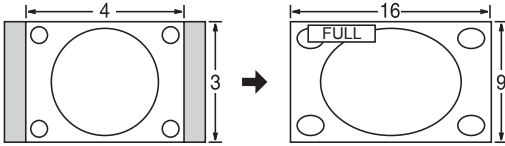

Enlarges the 4:3 image horizontally to the screen's side edges.  
(Recommended for anamorphic picture)

### ● JUST

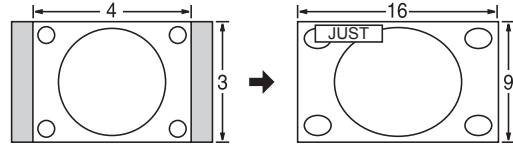

Stretches to justify the 4:3 image to the four corners of the screen.

(Recommended for normal TV broadcast)

### ● H-FILL

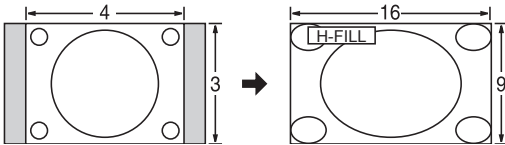

Enlarges the 4:3 image horizontally to the screen's side edges. The side edges of the image are cut off.

### ● 4:3

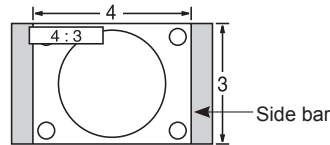

Standard  
(Note that "Image retention" of the side bar may occur from displaying it for a long time.)

### ● ZOOM

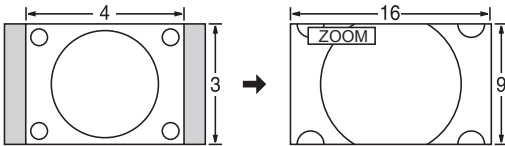

Enlarges the 4:3 image to the entire screen.  
(Recommended for Letter Box)

### Note

- 480i (4:3), 480i (16:9), 480p (4:3), 480p (16:9):  
FULL, JUST, 4:3 or ZOOM
- 1080p / 1080i / 720p:  
FULL, H-FILL, JUST, 4:3 or ZOOM

### ● Zoom adjustments

Vertical image position and size can be adjusted in "ZOOM".

① Select "Zoom adjustments" on the "Picture" menu. (p. 31)

② V-position: Vertical position adjustment

③ V-size: Vertical size adjustment

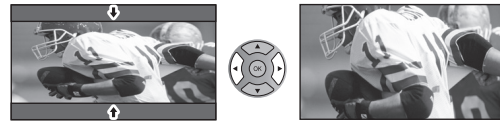

● To reset the aspect ratio →  (OK)

## H size

### ● Aspect Ratio: 4:3

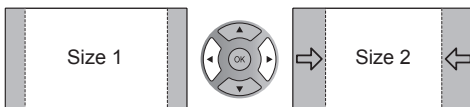

● The width will be decreased on both sides to reduce noise.

### ● Aspect Ratio: FULL/JUST(H-FILL/ZOOM)

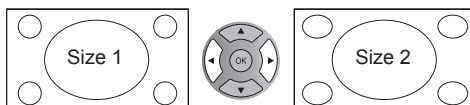

● The width will be increased on both sides to reduce noise.

See page 31 for more information

## Data format for SD Card browsing

Photo:	Still images recorded with digital still cameras compatible with JPEG files of DCF* and EXIF** standards
Data format:	Baseline JPEG (Sub-sampling: 4:4:4, 4:2:2 or 4:2:0)
Max. number of files:	9,999
Image resolution:	160 x 120 to 20,000,000

\* DCF (Design rule for camera file system): A Japan Electronics and Information Technology Industries Association's standard  
 \*\* EXIF (Exchangeable Image File Format)

### Caution

- A JPEG image modified with a PC may not be displayed.
- Partly degraded files might be displayed at a reduced resolution.

### Note

- Folder structure viewed in PC

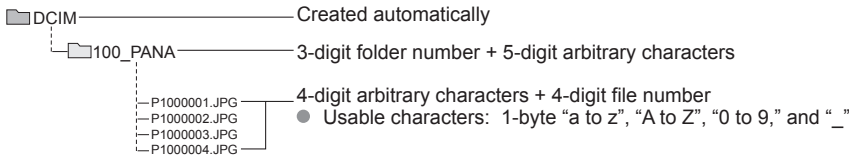

- The folder and file names may be different depending on the digital camera used.
- For the suitable SD Memory Cards, please confirm the latest information on the following website.  
<http://panasonic.jp/support/global/cs> (This site is in English only)

## Cautions when handling SD Cards

- Use an SD Card which meets SD standards. If not, it may cause the TV to malfunction.
- Do not remove the card while the unit is accessing data (this can damage card or unit).
- Do not touch the terminals on the back of the card.
- Do not subject the card to high pressure or impact.
- Insert the card in the correct direction (otherwise, card or unit may be damaged).
- Electrical interference, static electricity or erroneous operation may damage the data or card.
- Back up the recorded data at regular intervals in case of deteriorated or damaged data or erratic operation of the unit. (Panasonic is not liable for any deterioration or damage of recorded data.)

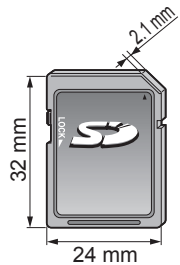

## SD Card warning messages

Message	Meaning
SD card slot is empty.	<ul style="list-style-type: none"> <li>● The card is not inserted.</li> </ul>
No photos	<ul style="list-style-type: none"> <li>● The card has no data or this type of data is not supported.</li> </ul>
Cannot read file	<ul style="list-style-type: none"> <li>● The file is broken or unreadable.</li> <li>● The TV does not support the format.</li> </ul>

## VIERA Link™ "HDAVI Control™"

HDMI connections to some Panasonic equipment allows you to interface automatically. (p. 23)

- This function may not work normally depending on the equipment condition.
- The equipment can be operated by other remote controls with this function on even if TV is in Standby mode.
- Image or sound may not be available for the first few seconds when the playback starts.
- Image or sound may not be available for the first few seconds when Input mode is switched.
- Volume function will be displayed when adjusting the volume of the equipment.
- If you connect equipment that has "HDAVI Control 2 or later" function to the TV with HDMI cable, the sound from DIGITAL AUDIO OUT terminal can be output as multi channel surround.
- "HDAVI Control 5" is the newest standard (current as of December, 2010) for the HDAVI Control compatible equipment. This standard is compatible with the conventional HDAVI equipment.

## HDMI connection

HDMI (high-definition multimedia interface) allows you to enjoy high-definition digital images and high-quality sound by connecting the TV unit and HD devices.

HDMI-compatible equipment (\*1) with an HDMI or DVI output terminal, such as a Cable or Satellite box or a DVD player, can be connected to the HDMI connector using an HDMI compliant (fully wired) cable.

- HDMI is the world's first complete digital consumer AV interface complying with a non-compression standard.
- If the external equipment has only a DVI output, connect to the HDMI terminal via a DVI to HDMI adapter cable (\*2).
- When the DVI to HDMI adapter cable is used, connect the audio cable to the audio input terminal.
- Audio settings can be made on the "HDMI in" menu screen. (p. 32)  
Applicable audio signal sampling frequencies (L.PCM): 48 kHz, 44.1 kHz, 32 kHz  
(\*1): The HDMI logo is displayed on an HDMI-compliant device.  
(\*2): Enquire at your local digital equipment retailer shop.

### Caution

- Use with a PC is not assumed.
- All signals are reformatted before being displayed on the screen.
- If the connected device has an aspect adjustment function, set the aspect ratio to "16:9".
- These HDMI connectors are "type A".
- These HDMI connectors are compatible with HDCP (High-Bandwidth Digital Content Protection) copyright protection.
- A device having no digital output terminal may be connected to the input terminal of either "COMPONENT" or "VIDEO" to receive analog signals.
- The HDMI input terminal can be used with only the following image signals: 480i, 480p, 720p, 1080i, 1080p.  
Match the output setting of the digital device.
- For details of the applicable HDMI signals, see p. 39.

## DIGITAL AUDIO OUT terminal

You can enjoy your Home theater by connecting a Dolby Digital (5.1 channel) decoder and "Multi Channel" amplifier to the DIGITAL AUDIO OUT terminals.

### Caution

- Depending on your DVD player and DVD-Audio software the copyright protection function may operate and disable optical output.
- When an ATSC channel is selected, the output from the DIGITAL AUDIO OUT jack will be Dolby Digital. When an NTSC channel is selected, the output will be PCM.

## Closed Caption (CC)

- For viewing the CC of digital broadcasting, set the aspect to FULL (If viewing with H-FILL, JUST, ZOOM or 4:3; characters might be cut off).
- The CC can be displayed on the TV only when the receiver (such as a Cable box or satellite receiver) has the CC set to ON within the device itself. Check with your Cable or Satellite provider for instructions. The TV's CC button does not operate the Satellite or Cable box's CC function.
- If the CC is set to On on both the receiver and TV when the signal is 480i (except for the HDMI connection), the CC may overlap on the TV.
- If a digital program is being output in analog format, the CC data will also be output in analog format.
- If the recorder or output monitor is connected to the TV, the CC needs to be set up on the recorder or output monitor.

## PC Input Terminals Connection

- Signal Names for D-sub 15P Connector

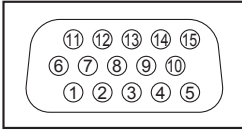

Pin Layout for PC Input Terminal

Pin No.	Signal Name	Pin No.	Signal Name	Pin No.	Signal Name
①	R	⑥	GND (Ground)	⑪	NC (not connected)
②	G	⑦	GND (Ground)	⑫	NC
③	B	⑧	GND (Ground)	⑬	HD/SYNC
④	NC (not connected)	⑨	NC (not connected)	⑭	VD
⑤	GND (Ground)	⑩	GND (Ground)	⑮	NC

## Input signal that can be displayed

- \* Mark: Applicable input signal for Component (Y, PB, PR), HDMI and PC

	horizontal frequency (kHz)	vertical frequency (Hz)	COMPONENT	HDMI	PC
525 (480) / 60i	15.73	59.94	*	*	
525 (480) /60p	31.47	59.94	*	*	
750 (720) /60p	45.00	59.94	*	*	
1,125 (1,080) /60i	33.75	59.94	*	*	
1,125 (1,080)/60p	67.43	59.94		*	
1,125 (1,080)/60p	67.50	60.00		*	
1,125(1,080)/24p	26.97	23.98		*	
1,125(1,080)/24p	27.00	24.00		*	
640 × 400 @70	31.47	70.08			*
640 × 480 @60	31.47	59.94			*
Macintosh13" (640 × 480)	35.00	66.67			*
640 × 480 @75	37.50	75.00			*
852 × 480 @60	31.44	59.89			*
800 × 600 @60	37.88	60.32			*
800 × 600 @75	46.88	75.00			*
800 × 600 @85	53.67	85.08			*
Macintosh16" (832 × 624)	49.73	74.55			*
1,024 × 768 @60	48.36	60.00			*
1,024 × 768 @70	56.48	70.07			*
1,024 × 768 @75	60.02	75.03			*
1,024 × 768 @85	68.68	85.00			*
Macintosh 21" (1,152 × 870)	68.68	75.06			*
1,280 × 768 @60	47.78	59.87			*
1,280 × 1,024 @60	63.98	60.02			*
1,366 × 768 @60	48.39	60.04			*

### Note

- Signals other than above may not be displayed properly.
- The above signals are reformatted for optimal viewing on your display.
- Computer signals which can be input are those with a horizontal scanning frequency of 15 to 110 kHz and vertical scanning frequency of 48 to 120 Hz. (However, the image will not be displayed properly if the signals exceed 1,200 lines.)

Panasonic does not guarantee operation and performance of peripheral devices made by other manufacturers; and we disclaim any liability or damage arising from operation and/or performance from usage of such other maker's peripheral devices.



# Care and Cleaning

**First, unplug the Power cord plug from the wall outlet.**

## Display panel

The front of the display panel has been specially treated. Wipe the panel surface gently using only a cleaning cloth or a soft, lint-free cloth.

- If the surface is particularly dirty, soak a soft, lint-free cloth in diluted mild liquid dish soap (1 part mild liquid dish soap diluted by 100 times the amount of water) and then wring the cloth to remove excess liquid. Use this cloth to wipe the surface of the display panel, then wipe it evenly with a dry cloth of the same type until the surface is dry.
- Do not scratch or hit the surface of the panel with fingernails or other hard objects. Furthermore, avoid contact with volatile substances such as insect sprays, solvents, and thinner; otherwise, the quality of the surface may be adversely affected.

## Cabinet

If the cabinet becomes dirty, wipe it with a soft, dry cloth.

- If the cabinet is particularly dirty, soak the cloth in a weak mild liquid dish soap and then wring the cloth dry. Use this cloth to wipe the cabinet and then wipe it dry with a dry cloth.
- Do not allow any mild liquid dish soap to come into direct contact with the surface of the LCD TV. If water droplets get inside the unit, operating problems may result.
- Avoid contact with volatile substances such as insect sprays, solvents, and thinner; otherwise, the quality of the cabinet surface may be adversely affected or the coating may peel off.
- Do not let articles made from rubber or PVC be in contact with the TV for long periods of time.

## Pedestal

- **Cleaning**  
Wipe the surfaces with a soft, dry cloth. If the unit is particularly dirty, clean it using a cloth soaked with water to which a small amount of mild liquid dish soap has been added and then wipe with a dry cloth.  
Do not use products such as solvents, thinner, or household wax for cleaning, as they can damage the surface coating. (If using a chemically-treated cloth, follow the instructions supplied with the cloth.)
- Do not attach sticky tape or labels, as they can make the surface of the pedestal dirty. Do not allow long-term contact with rubber, vinyl products, or the like. (Doing so will cause deterioration.)

## Power cord plug

Wipe the plug with a dry cloth at regular intervals. (Moisture and dust can lead to fire or electrical shock.)

# Specifications

		TC-L19C30
<b>Power Source</b>		AC 110-127 V, 60 Hz
<b>Power Consumption</b>	<b>Rated Power Consumption</b>	33 W
	<b>Standby condition</b>	0.3 W
<b>Display panel</b>	<b>Aspect Ratio</b>	16:9
	<b>Visible screen size</b>	19" class (18.5 inches measured diagonally)
	<b>(W × H × Diagonal)</b>	16.1" × 9.1" × 18.5" (410 mm × 230 mm × 470 mm)
	<b>(No. of pixels)</b>	1,049,088 (1,366 (W) × 768 (H)) [4,098 × 768 dots]
<b>Sound</b>	<b>Speaker</b>	1-way 2 bottom SP System
	<b>Audio Output</b>	10 W [5 W + 5 W] (10 % THD)
<b>PC signals</b>		VGA, SVGA, XGA, WXGA, SXGA Horizontal scanning frequency 31 - 69 kHz Vertical scanning frequency 59 - 86 Hz
<b>Channel Capability-ATSC/NTSC (Digital/Analog)</b>		VHF/ UHF: 2 - 69, CATV: 1 - 135
<b>Operating Conditions</b>		Temperature: 32 °F – 95 °F (0 °C – 35 °C) Humidity: 20 % – 80 % RH (non-condensing)
<b>Connection Terminals</b>	<b>VIDEO IN</b>	VIDEO: RCA PIN Type × 1 1.0 V [p-p] (75 Ω) AUDIO L-R: RCA PIN Type × 2 0.5 V [rms]
	<b>COMPONENT IN</b>	Y: 1.0 V [p-p] (including synchronization) Pb, Pr: ±0.35 V [p-p] AUDIO L-R: RCA PIN Type × 2 0.5 V [rms]
	<b>HDMI</b>	TYPE A Connector × 1 ● This TV supports "HDAVI Control 5" function.
	<b>PC</b>	D-SUB 15PIN: R,G,B / 0.7 V [p-p] (75 Ω) HD, VD / 1.0 - 5.0 V [p-p] (high impedance)
	<b>Card slot</b>	SD CARD slot × 1
	<b>DIGITAL AUDIO OUT</b>	PCM / Dolby Digital, Fiber Optic
<b>FEATURES</b>		3D Y/C FILTER, CLOSED CAPTION, V-Chip, HDAVI Control 5 Vesa compatible, VIERA IMAGE VIEWER
<b>Dimensions (W × H × D)</b>	<b>Including TV stand</b>	18.5" × 13.7" × 6.5" (469 mm × 346 mm × 163 mm)
	<b>TV Set only</b>	18.5" × 12.3" × 1.7" (2.4") (469 mm × 311 mm × 42 mm (59 mm))
<b>Mass</b>	<b>Including TV stand</b>	8.8 lb. (4.0 kg) NET
	<b>TV Set only</b>	7.7 lb. (3.5 kg) NET

[TC-L19C30]

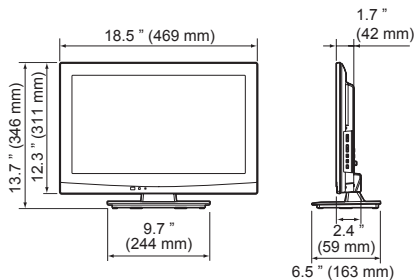

**Note**

● Design and Specifications are subject to change without notice. Mass and Dimensions shown are approximate.

# Frequently Asked Questions (FAQ)

If there is a problem with your TV, please refer to the table below to determine the symptoms, then carry out the suggested check. If this does not solve the problem, visit the Panasonic website for further assistance. (see cover)

Questions	Answers
<b>How do I view the picture from devices such as a: Cable/Satellite box, game console, Blu-ray or DVD player?</b>	<ul style="list-style-type: none"><li>● Press the INPUT button on the remote to select the correct input source.</li><li>● Check that the device is turned on and functioning correctly.</li></ul>
<b>Why is there no picture or just a blue, black or snowy screen being displayed?</b>	<ul style="list-style-type: none"><li>● Check if the power cord is plugged in and the TV is turned on (front red LED light should be on; not blinking)</li><li>● Press the INPUT button on the remote to select the correct input source.</li><li>● Ensure all connections are correct and secure.</li><li>● When using external video source, such as a Cable/Satellite box or DVD player, check that the device is on and functioning correctly.</li><li>● Press MENU on the TV's remote control. If the menu is displayed, then the TV is working; recheck above steps.</li></ul>
<b>Why doesn't the picture look like it is in High Definition?</b>	<ul style="list-style-type: none"><li>● Press the INFO button on the remote to confirm the type of signal being received (p. 15). HD signal should be 720P, 1080i or 1080p.</li><li>● Select a High Definition channel from your HD source (Cable, Satellite or fiber optic service). HD channels sometimes broadcast non-HD content.</li><li>● Ensure that your HD source (HD box, Blu-ray player, etc.) is connected to the TV with an HDMI or Component cable and set to output an HD video signal.</li></ul>
<b>Why do black bars appear on the top and bottom and/or sides of the screen?</b>	<ul style="list-style-type: none"><li>● Change the format (aspect ratio) of the picture by pressing the FORMAT button on the remote control. (p.16)</li><li>● Check the aspect settings on your external video source, such as Cable/Satellite box, DVD/Blu-ray Disc player, etc. Note: Some content, such as film-based movies, are available in extra-wide format. Top and bottom bars are unavoidable.</li></ul>
<b>Why is the picture snowy when "ANT/Cable in" is selected?</b>	<ul style="list-style-type: none"><li>● When using a cable service (without a box), check that all connections are secure.</li><li>● When using a cable or satellite box, change the connection (wiring) to Composite, Component or HDMI. (p.10)</li><li>● If you're using an antenna, then check that connections are secure. Change the position or direction of the antenna and check the "Signal meter". (p.29)</li></ul>
<b>Why is the picture chaotic and/or torn and/or with a buzz in the speakers?</b>	<ul style="list-style-type: none"><li>● Check if electrical products such as kitchen appliances, fluorescent lights or light dimmers are nearby. They may interfere with the TV's picture.</li><li>● Try viewing a picture from another device, such as a DVD player or a game console, to narrow down the source of the problem.</li></ul>
<b>Why is there a black box on the screen?</b>	<ul style="list-style-type: none"><li>● Change settings of Closed Caption (CC). (p. 15, 38)</li></ul>
<b>Why is the screen blank and the power indicator blinking?</b>	<ul style="list-style-type: none"><li>● The TV has gone into shutdown mode to protect itself. Try unplugging it for a few minutes and connecting it again. If there was a temporary power surge on the AC line it may now be OK. If the blinking returns, call 1-877-95VIERA (U.S.A.) or 1-866-330-0014 (Canada).</li></ul>
<b>Why do some small spots on the screen remain bright or dark?</b>	<ul style="list-style-type: none"><li>● The LCD panel is made up of a few million pixels and is produced with advanced technology through an intricate process. Sometimes a few pixels may be bright or dark. These pixels do not indicate a defective panel and will have no impact on the performance of the TV.</li></ul>

Picture

## Questions

## Answers

### Sound

**Why is there no sound coming from the TV?**

- Make sure the volume is up and MUTE is off.
- Confirm the TV speakers are set to ON by pressing MENU and selecting "Audio" --> "Advanced audio". (p.32)
- Check that the correct SAP (Secondary Audio Program) is selected by pressing the SAP button on the remote control. (p.15)
- If the TV is connected to a Panasonic Home Theater via HDMI cable, then check VIERA Link controls. (p.22)
- If the TV is connected to a Home Theater via optical cable, then: Check the connection, the audio system is on, the correct input is selected.
- Check "HDMI in" analog/digital audio settings. (p. 32)

**Why is the sound unusual, distorted, low volume or in another language?**

- Check that the correct SAP (Secondary Audio Program) is selected by pressing the SAP button on the remote control.
- Check that all connections of external equipment connected to the TV are secure.
- When using Cable or Satellite box, check the device's audio settings. (example: try changing the box's Audio Range to 'narrow')

**Why is there a clicking, ticking or buzzing sound coming from the TV unit?**

- When TV power is turned on or shut off there are electrical components that make a click sound. This is normal operation.
- Changes in the temperature and humidity of the room may cause thermal expansion and contraction that can produce sounds. This is not a sign of faulty operation or a malfunction.

**What is the easiest and best way to connect a High-Definition Cable or Satellite box to the TV?**

- Use an HDMI cable. It carries both digital video and audio signal in HD. HDMI cable is the only cable needed to connect an HD device to the TV.

**Why is there no yellow jack (video input) on the back of the TV?**

- The Video input is shared with the Component input. Just connect the yellow plug into the green jack. Be sure to connect the red and white audio plugs into the appropriate red and white audio inputs. (p. 10)

**Why does the CC button not display Closed Caption?**

- When viewing TV via an HDMI connected device, such as a Cable or Satellite box, CC must be enabled at the device.
- Closed Caption is available only at supported TV programming.

**Why does the screen and back cover of the TV get warm?**

- The main unit radiates heat and some of the parts may become hot. This is normal operation and does not affect the performance of the set.
- Ensure good ventilation.
- Do not block the ventilation holes of the TV and do not place the TV on top of other equipment.

**Why doesn't the Remote Control work?**

- Check that the batteries are fresh, are of the same type and are installed with the correct polarity (+ & -).
- To operate other devices, such as changing channels when using Cable or Satellite boxes or operating non-Panasonic Blu-ray players, use the remote supplied with the device.

**Why is the "ANT/Cable" option at the top of the "Input select" menu gray-out and cannot be selected?**

- During "First time setup", step 3, you indicated that the "Antenna/Cable in" connector is "not used" (p.13). This is the proper setting if the TV is connected to a Cable or Satellite box via any of the other inputs. To re-activate the "ANT/Cable" input, press MENU, select SETUP and then redo the First time setup, selecting Cable or Antenna in step 3.

**Some menu items are grayed-out and cannot be selected. Why?**

- Depending on certain modes or the selected input, some options are not available. For example, Zoom adjustments are only available when the FORMAT is changed to zoom mode.

### Other

# Index

<b>A</b>	Accessories .....	7
	ANT/Cable .....	13, 28
	Antenna .....	9, 13
	Audio.....	32
	Audio, Advanced .....	32
	Auto Power ON.....	34
	Auto Program.....	28
<b>B</b>	Battery .....	8
	Blinking LED .....	42
<b>C</b>	Cable .....	9, 10
	Care & Cleaning .....	40
	CC Closed Caption.....	15, 33, 38
	Channel .....	13, 15-16, 28-29
	Channel Surf Mode.....	16, 34
	Clock.....	14
	Colored buttons .....	11
	Component .....	10, 41
	Composite.....	10
	Connections.....	9-10
	Customer Services Directory .....	46
<b>E</b>	ECO/energy .....	18, 34
	Exit.....	11
<b>F</b>	FAQ's .....	42-43
	Favorite .....	16
	First Time Setup.....	12-14, 34
	Format .....	16, 36
<b>H</b>	HDAVI Control.....	22
	HDMI.....	10, 38, 41
	Home use .....	12
<b>I</b>	Image Viewer Auto.....	34
	Info.....	15
	Input.....	19
<b>L</b>	Language.....	12, 34
	Last .....	11
	Lock / Parental control .....	33, 35
<b>M</b>	Menu .....	30
	Mute.....	11
<b>P</b>	Pedestal.....	7, 8
	Photo .....	20-21
	Picture, Advanced .....	32
	Picture settings .....	31
	Power.....	11
<b>R</b>	Remote control .....	11
	Reset .....	34
<b>S</b>	Safety.....	4
	SAP.....	15
	Scan.....	13, 28
	SD Card .....	20, 37
	Signal Meter.....	29
	Sleep.....	32
	Specifications.....	41
	Store Demonstration.....	12
	Sub menu .....	16
<b>T</b>	Technical Information.....	36-39
	Timer.....	32
<b>V</b>	VIERA IMAGE VIEWER .....	20
	VIERA Link.....	18, 22-27
	VIERA TOOLS .....	18
	Viewing Photos .....	20
	Volume.....	11
<b>W</b>	Warranty .....	45, 47
	Watching TV, DVD, Blu-ray, etc. ....	15, 19
<b>Z</b>	Zoom.....	16, 36

# Limited Warranty (for U.S.A. and Puerto Rico only)

PANASONIC CONSUMER ELECTRONICS COMPANY,  
DIVISION OF:  
PANASONIC CORPORATION OF NORTH AMERICA  
One Panasonic Way  
Secaucus, New Jersey 07094

## Panasonic LCD Televisions Limited Warranty

### Limited Warranty Coverage

If your product does not work properly because of a defect in materials or workmanship, Panasonic Consumer Electronics Company (referred to as "the warrantor") will, for the length of the period indicated on the chart below, which starts with the date of original purchase ("warranty period"), at its option either (a) repair your product with new or refurbished parts, (b) replace it with a new or a refurbished equivalent value product, or (c) refund your purchase price. The decision to repair, replace or refund will be made by the warrantor.

LCD TV CATEGORIES	PARTS	LABOR	SERVICE
Up to 42" (diagonal)	1 (ONE) YEAR	1 (ONE) YEAR	Carry-In
46" (diagonal) and larger			On-Site

During the "Labor" warranty period there will be no charge for labor. During the "Parts" warranty period, there will be no charge for parts.

You must carry-in your product or arrange for on-site service during the Limited warranty period. If non-rechargeable batteries are included, they are not warranted. This warranty only applies to products purchased and serviced in the United States or Puerto Rico. This warranty is extended only to the original purchaser of a new product which was not sold "as is". A purchase receipt or other proof of the original purchase date is required for warranty service.

### On-Site or Carry-in Service

For On-Site or Carry-In Service in the United States and Puerto Rico call 1-877-95-VIERA (1-877-958-4372)

On-site service where applicable requires clear, complete and easy access to the product by the authorized servicer and does not include removal or re-installation of an installed product. It is possible that certain on-site repairs will not be completed on-site, but will require that the product or parts of the product, at the servicer's discretion be removed for shop diagnosis and/or repair and then returned.

### Limited Warranty Limits And Exclusions

This warranty ONLY COVERS failures due to defects in materials or workmanship, and DOES NOT COVER normal wear and tear or cosmetic damage, nor does it cover markings or retained images on the LCD panel resulting from viewing fixed images (including, among other things, non-expanded standard 4:3 pictures on wide screen TV's, or onscreen data in a stationary and fixed location). The warranty ALSO DOES NOT COVER damages which occurred in shipment, or failures which are caused by products not supplied by the warrantor, or failures which result from accidents, misuse, abuse, neglect, bug infestation, mishandling, misapplication, alteration, faulty installation, set-up adjustments, misadjustment of consumer controls, improper maintenance, power line surge, lightning damage, modification, or commercial use (such as in a hotel, office, restaurant, or other business), rental use of the product, service by anyone other than a Factory Service Center or other Authorized Servicer, or damage that is attributable to acts of God.

**THERE ARE NO EXPRESS WARRANTIES EXCEPT AS LISTED UNDER "LIMITED WARRANTY COVERAGE". THE WARRANTOR IS NOT LIABLE FOR INCIDENTAL OR CONSEQUENTIAL DAMAGES RESULTING FROM THE USE OF THIS PRODUCT, OR ARISING OUT OF ANY BREACH OF THIS WARRANTY.** (As examples, this excludes damages for lost time, cost of having someone remove or re-install an installed unit if applicable, or travel to and from the servicer. The items listed are not exclusive, but are for illustration only.) **ALL EXPRESS AND IMPLIED WARRANTIES, INCLUDING THE WARRANTY OF MERCHANTABILITY, ARE LIMITED TO THE PERIOD OF THE LIMITED WARRANTY.**

Some states do not allow the exclusion or limitation of incidental or consequential damages, or limitations on how long an implied warranty lasts, so the exclusions may not apply to you.

This warranty gives you specific legal rights and you may also have others rights which vary from state to state. If a problem with this product develops during or after the warranty period, you may contact your dealer or Service Center. If the problem is not handled to your satisfaction, then write to the warrantor's Consumer Affairs Department at the addresses listed for the warrantor.

**PARTS AND SERVICE (INCLUDING COST OF AN ON-SITE SERVICE CALL, WHERE APPLICABLE) WHICH ARE NOT COVERED BY THIS LIMITED WARRANTY ARE YOUR RESPONSIBILITY.**

# Customer Services Directory (for U.S.A. and Puerto Rico)

## Customer Services Directory (United States and Puerto Rico)

Obtain Product Information and Operating Assistance; locate your nearest Dealer or Service Center; purchase Parts and Accessories; or make Customer Service and Literature requests by visiting our Web Site at:

<http://www.panasonic.com/help>

or, contact us via the web at:

<http://www.panasonic.com/contactinfo>

You may also contact us directly at:

1-877-95-VIERA (958-4372)

Monday-Friday 9 am-9 pm; Saturday-Sunday 10 am-7 pm, EST.

■ For hearing or speech impaired TTY users, TTY: 1-877-833-8855

## Accessory Purchases (United States and Puerto Rico)

Purchase Parts, Accessories and Instruction Books on line for all Panasonic Products by visiting our Web Site at:

<http://www.pstc.panasonic.com>

or, send your request by E-mail to:

[npcparts@us.panasonic.com](mailto:npcparts@us.panasonic.com)

You may also contact us directly at:

1-800-332-5368 (Phone) 1-800-237-9080 (Fax Only) (Monday - Friday 9 am to 9 pm, EST.)

Panasonic Service and Technology Company

20421 84th Avenue South,

Kent, WA 98032

(We Accept Visa, MasterCard, Discover Card, American Express, and Personal Checks)

■ For hearing or speech impaired TTY users, TTY: 1-866-605-1277

# Limited Warranty (for Canada)

**Panasonic Canada Inc.**  
5770 Ambler Drive, Mississauga, Ontario L4W 2T3  
**PANASONIC PRODUCT – LIMITED WARRANTY**

Panasonic Canada Inc. warrants this product to be free from defects in material and workmanship under normal use and for a period as stated below from the date of original purchase agrees to, at its option either (a) repair your product with new or refurbished parts, (b) replace it with a new or a refurbished equivalent value product, or (c) refund your purchase price. The decision to repair, replace or refund will be made by Panasonic Canada Inc.

<b>Viera TV (42" &amp; over)</b>	<b>In-home service</b>	<b>One (1) year, parts (including panel) and labour.</b>
<b>Viera TV (under 42")</b>	<b>Carry-in service</b>	<b>One (1) year, parts (including panel) and labour.</b>

In-home Service will be carried out only to locations accessible by roads and within 50 km of an authorized Panasonic service facility.

In-home service requires clear, complete and easy access to the product by the Authorized Servicer and does not include removal or re-installation of an installed product. If removal is required to service the product, it will be at the discretion of the Servicer and in no event will Panasonic Canada Inc. or the Servicer be liable for any special, indirect or consequential damages.

This warranty is given only to the original purchaser, or the person for whom it was purchased as a gift, of a Panasonic brand product mentioned above sold by an authorized Panasonic dealer in Canada and purchased and used in Canada, which product was not sold "as is", and which product was delivered to you in new condition in the original packaging.

**IN ORDER TO BE ELIGIBLE TO RECEIVE WARRANTY SERVICE HEREUNDER, A PURCHASE RECEIPT OR OTHER PROOF OF DATE OF ORIGINAL PURCHASE, SHOWING AMOUNT PAID AND PLACE OF PURCHASE IS REQUIRED**

## **LIMITATIONS AND EXCLUSIONS**

This warranty ONLY COVERS failures due to defects in materials or workmanship, and DOES NOT COVER normal wear and tear or cosmetic damage. The warranty ALSO DOES NOT COVER damages which occurred in shipment, or failures which are caused by products not supplied by Panasonic Canada Inc., or failures which result from accidents, misuse, abuse, neglect, mishandling, misapplication, alteration, faulty installation, set-up adjustments, misadjustment of consumer controls, improper maintenance, power line surge, lightning damage, modification, introduction of sand, humidity or liquids, commercial use such as hotel, office, restaurant, or other business or rental use of the product, or service by anyone other than a Authorized Servicer, or damage that is attributable to acts of God. Dry cell batteries are also excluded from coverage under this warranty.

THIS EXPRESS, LIMITED WARRANTY IS IN LIEU OF ALL OTHER WARRANTIES, EXPRESS OR IMPLIED, INCLUDING ANY IMPLIED WARRANTIES OF MERCHANTABILITY AND FITNESS FOR A PARTICULAR PURPOSE. IN NO EVENT WILL PANASONIC CANADA INC. BE LIABLE FOR ANY SPECIAL, INDIRECT OR CONSEQUENTIAL DAMAGES RESULTING FROM THE USE OF THIS PRODUCT OR ARISING OUT OF ANY BREACH OF ANY EXPRESS OR IMPLIED WARRANTY. (As examples, this warranty excludes damages for lost time, travel to and from the Authorized Servicer, loss of or damage to media or images, data or other memory or recorded content. This list of items is not exhaustive, but for illustration only.)

In certain instances, some jurisdictions do not allow the exclusion or limitation of incidental or consequential damages, or the exclusion of implied warranties, so the above limitations and exclusions may not be applicable. This warranty gives you specific legal rights and you may have other rights which vary depending on your province or territory.

## **WARRANTY SERVICE**

**For product operation and information assistance**, please contact:

Our Customer Care Centre:      1-800 #:                      1-866-330-0014  
Email link: "Contact us → email" on [www.vieraconcierge.ca](http://www.vieraconcierge.ca)

**For product repairs**, please contact Viera Customer Care Agent using the above contact info.

## **IF YOU SHIP THE PRODUCT TO A SERVICENTRE**

Carefully pack and send prepaid, adequately insured and preferably in the original carton.  
Include details of the defect claimed, and proof of date of original purchase.