

# Panasonic®

Model No.  
Número de modelo

**TC-L37D2**  
**TC-L42D2**

## Operating Instructions

37"/42" Class 1080p LCD HDTV  
(37.0/42.0 inches measured diagonally)

## Manual de instrucciones

Televisión de alta definición de 1080p y  
clase 37"/42" de LCD  
(37,0/42,0 pulgadas medidas diagonalmente)

# VIERA

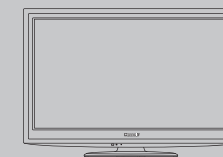

## Quick Start Guide

► See page 7-14

## Guía de inicio rápido

► vea la página 7-14

### Customer's Record

The model number and serial number of this product can be found on its back cover. You should note this serial number in the space provided below and retain this book, plus your purchase receipt, as a permanent record of your purchase to aid in identification in the event of theft or loss, and for Warranty Service purposes.

Model Number \_\_\_\_\_ Serial Number \_\_\_\_\_

### Anotación del cliente

El modelo y el número de serie de este producto se encuentran en su panel posterior. Deberá anotarlos en el espacio provisto a continuación y guardar este manual, más el recibo de su compra, como prueba permanente de su adquisición, para que le sirva de ayuda al identificarlo en el caso de que le sea sustraído o lo pierda, y también para disponer de los servicios que le ofrece la garantía.

Modelo \_\_\_\_\_ Número de serie \_\_\_\_\_

**Panasonic Consumer Electronics Company,**  
**Division of Panasonic Corporation of North America**  
One Panasonic Way, Secaucus  
New Jersey 07094 U.S.A.

**Panasonic Canada Inc.**  
5770 Ambler Drive  
Mississauga, Ontario  
L4W 2T3 CANADA

© 2010 Panasonic Corporation of North America. All Rights Reserved.  
© 2010 Panasonic Corporation of North America. Todos los Derechos Reservados.

Printed in U.S.A.  
Impreso en EE.UU.  
M0210-0

For assistance (U.S.A./Puerto Rico), please call:

**1-877-95-VIERA (958-4372)**

or visit us at [www.panasonic.com/contactinfo](http://www.panasonic.com/contactinfo)

For assistance (Canada), please call:

**1-866-330-0014**

or visit us at [www.vieraconciierge.ca](http://www.vieraconciierge.ca)

Para solicitar ayuda (EE.UU./Puerto Rico), llame al:

**1-877-95-VIERA (958-4372)**

ó visítenos en [www.panasonic.com/contactinfo](http://www.panasonic.com/contactinfo)

# HDMI

# HDTV

# VIERA Link™

# SD HG



# VIERA™ IMAGE VIEWER

**English**

Thank you for purchasing this Panasonic product.  
Please read these instructions before operating your set and retain them for future reference. The images shown in this manual are for illustrative purposes only.

**Español**

Gracias por su decisión de comprar este producto marca Panasonic.  
Lea estas instrucciones antes de utilizar su televisor y guárdelas para consultarlas en el futuro. Las imágenes mostradas en este manual tienen solamente fines ilustrativos.



TQB2AA0582-1

# Experience an amazing level of multimedia excitement

## Enjoy rich multimedia

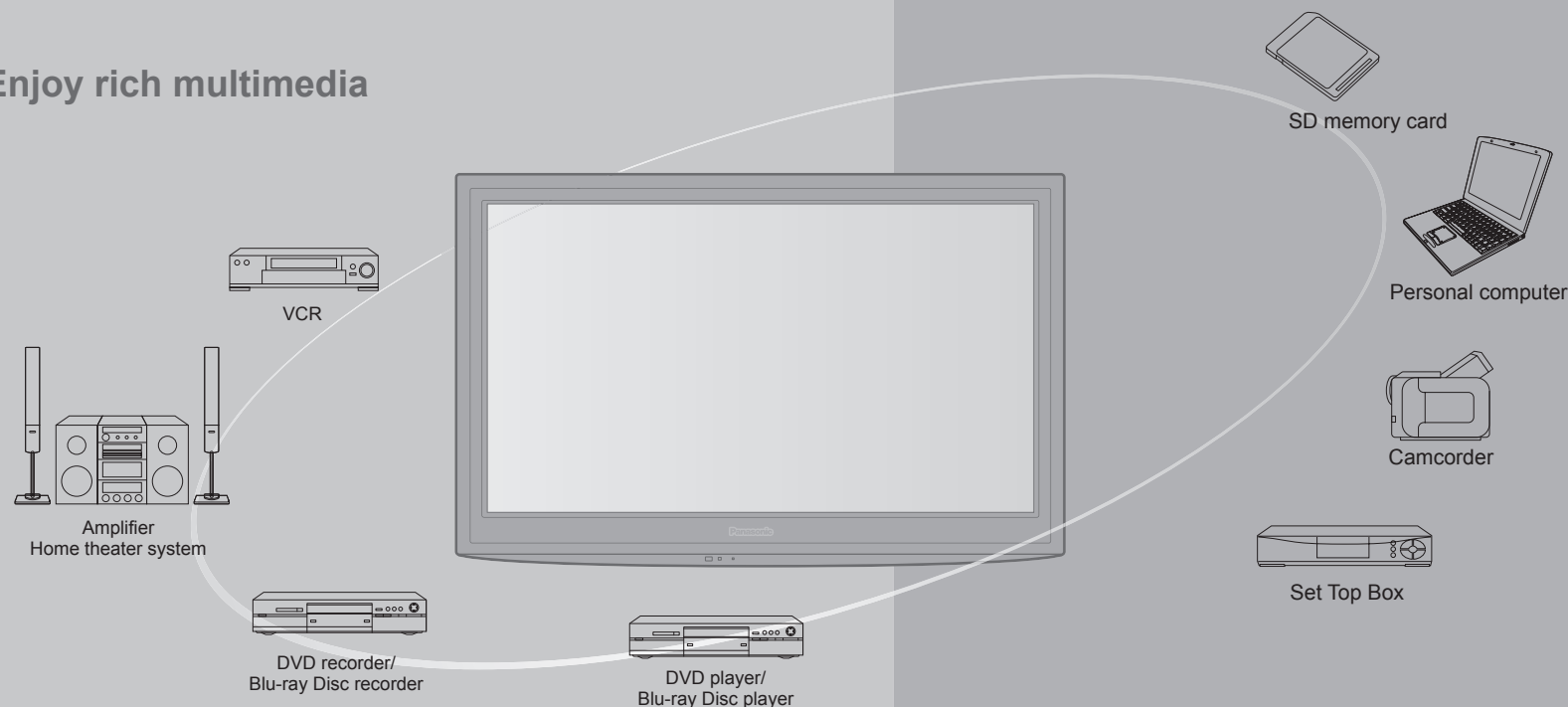

# Contents

## Please read before using the unit

- Safety Precautions ..... 4

## Quick Start Guide

- Accessories/Optional Accessory ..... 7
- Basic Connection ..... 9
- Identifying Controls ..... 11
- First Time Setup ..... 12

## Enjoy your TV!

### Basic Features

- Watching TV ..... 15
- Using VIERA TOOLS ..... 17
- Viewing with VIERA IMAGE VIEWER ..... 18
- Playing an iPod on TV ..... 20
- Watching Videos and DVDs ..... 24
- Displaying PC Screen on TV ..... 26

### Advanced Features

- How to Use Menu Functions (picture, sound quality, etc.) ..... 27
- VIERA Link™ “HDAVI Control™” ..... 30
- Lock ..... 36
- Editing and Setting Channels ..... 38
- Closed Caption ..... 40
- Input Labels ..... 41
- Using Timer ..... 42
- Recommended AV Connections ..... 43

### FAQs, etc.

- Ratings List for Lock ..... 44
- Technical Information ..... 45
- Care and Cleaning ..... 49
- FAQ ..... 50
- Specifications ..... 52
- Limited Warranty (for U.S.A. and Puerto Rico only) ..... 53
- Customer Services Directory (for U. S. A. and Puerto Rico) ..... 54
- Limited Warranty (for Canada) ..... 55

Quick Start Guide

Viewing

Advanced

FAQs, etc.

<p><b>HDMI</b></p> <p>HDMI, the HDMI logo and High-Definition Multimedia Interface are trademarks or registered trademarks of HDMI Licensing LLC in the United States and other countries.</p>	<p><b>VIERA Link™</b></p> <p>VIERA Link™ is a trademark of Panasonic Corporation.</p>	<p><b>SDHC</b></p> <p>SDHC Logo is a trademark of SD-3C, LLC.</p>
<p>HDAVI Control™ is a trademark of Panasonic Corporation.</p>	<p>Manufactured under license from Dolby Laboratories. Dolby and the double-D symbol are trademarks of Dolby Laboratories.</p>	<p><b>CEA</b> Consumer Electronics Association <a href="http://www.CE.org/safety">www.CE.org/safety</a></p>



This product qualifies for ENERGY STAR in the “Home Use” setting and this is the setting in which energy savings will be achieved. Any modifications to the “Home Use” setting or other factory default settings could result in greater energy consumption beyond levels that meet ENERGY STAR qualifications.



# Safety Precautions



**CAUTION**

**RISK OF ELECTRIC SHOCK**

**DO NOT OPEN**



**WARNING: To reduce the risk of electric shock, do not remove cover or back. No user-serviceable parts inside. Refer servicing to qualified service personnel.**

 The lightning flash with arrowhead within a triangle is intended to tell the user that parts inside the product are a risk of electric shock to persons.

 The exclamation point within a triangle is intended to tell the user that important operating and servicing instructions are in the papers with the appliance.

## Note to CATV System Installer

This reminder is provided to direct the CATV system installer's attention to Article 820-40 of the NEC that provides guidelines for proper grounding and, in particular, specifies that the cable ground shall be connected to the grounding system of the building, as close to the point of cable entry as practical.

## Secure Ventilation

Slots and openings in the cabinet and the back or bottom are provided for ventilation, and to ensure reliable operation of the LCD TV and to protect it from overheating. These openings must not be blocked or covered. There should be at least 10 cm of space from these openings. The openings should never be blocked by placing the LCD TV on a bed, sofa, rug or other similar surface. This LCD TV should not be placed in a built-in installation such as a bookcase unless proper ventilation is provided.

## Important Safety Instructions

- 1) Read these instructions.
- 2) Keep these instructions.
- 3) Heed all warnings.
- 4) Follow all instructions.
- 5) Do not use this apparatus near water.
- 6) Clean only with dry cloth.
- 7) Do not block any ventilation openings. Install in accordance with the manufacturer's instructions.
- 8) Do not install near any heat sources such as radiators, heat registers, stoves or other apparatus (including amplifiers) that produce heat.
- 9) Do not defeat the safety purpose of the polarized or grounding-type plug. A polarized plug has two blades with one wider than the other. A grounding type plug has two blades and a third grounding prong. The wide blade or the third prong are provided for your safety. If the provided plug does not fit into your outlet, consult an electrician for replacement of the obsolete outlet.
- 10) Protect the power cord from being walked on or pinched particularly at plugs, convenience receptacles, and the point where they exit from the apparatus.
- 11) Only use attachments / accessories specified by the manufacturer.
- 12) Use only with the cart, stand, tripod, bracket or table specified by the manufacturer, or sold with the apparatus. When a cart is used, use caution when moving the cart / apparatus combination to avoid injury from tip-over.
- 13) Unplug this apparatus during lightning storms or when unused for long periods of time.
- 14) Refer all servicing to qualified service personnel. Servicing is required when the apparatus has been damaged in any way, such as power-supply cord or plug is damaged, liquid has been spilled or objects have fallen into the apparatus, the apparatus has been exposed to rain or moisture, does not operate normally, or has been dropped.
- 15) Operate only from the type of power source indicated on the marking label. If you are not sure of the type of power supplied to your home consult your television dealer or local power company.
- 16) Follow all warnings and instructions marked on the LCD TV.
- 17) Never push objects of any kind into this LCD TV through cabinet slots as they may touch dangerous voltage points or short out parts that could result in a fire or electric shock. Never spill liquid of any kind on the LCD TV.
- 18) If an outside antenna is connected to the television equipment, be sure the antenna system is grounded so as to provide some protection against voltage surges and built up static charges. In the U.S. Section 810-21 of the National Electrical Code provides information with respect to proper grounding of the main and supporting structure, grounding of the lead-in wire to an antenna discharge unit, size of grounding conductors, location of antenna discharge unit, connection to grounding electrodes, and requirements for the grounding electrode.

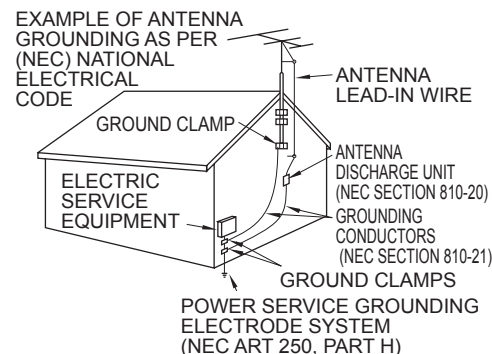

- 19) An outside antenna system should not be located in the vicinity of overhead power lines, other electric light, power circuits, or where it can fall into such power lines or circuits. When installing an outside antenna system, extreme care should be taken to keep from touching such power lines or circuits as contact with them might be fatal.
- 20) Unplug this LCD TV from the wall outlet and refer servicing to qualified service personnel under the following conditions:
  - a. When the power cord or plug is damaged or frayed.
  - b. If liquid has been spilled into the LCD TV.
  - c. If the LCD TV has been exposed to rain or water.
  - d. If the LCD TV does not operate normally by following the operating instructions.
 

Adjust only those controls that are covered by the operating instructions as improper adjustment of other controls may result in damage and will often require extensive work by a qualified technician to restore the LCD TV to normal operation.
  - e. If the LCD TV has been dropped or the cabinet has been damaged.
  - f. When the LCD TV exhibits a distinct change in performance - this indicates a need for service.
- 21) When replacement parts are required, be sure the service technician uses replacement parts specified by the manufacturer that have the same characteristics as the original parts. Unauthorized substitutions may result in fire, electric shock, or other hazards.
- 22) **WARNING: TO REDUCE THE RISK OF FIRE OR ELECTRIC SHOCK, DO NOT EXPOSE THIS APPARATUS TO RAIN, MOISTURE, DRIPPING OR SPLASHING. DO NOT PLACE LIQUID CONTAINERS (FLOWER VASES, CUPS, COSMETICS, ETC.) ABOVE THE SET (INCLUDING ON SHELVES ABOVE, ETC.).**
- 23) **WARNING: SMALL PARTS CAN PRESENT CHOKING HAZARD IF ACCIDENTALLY SWALLOWED. KEEP SMALL PARTS AWAY FROM YOUNG CHILDREN. DISCARD UNNEEDED SMALL PARTS AND OTHER OBJECTS, INCLUDING PACKAGING MATERIALS AND PLASTIC BAGS/SHEETS TO PREVENT THEM FROM BEING PLAYED WITH BY YOUNG CHILDREN, CREATING THE POTENTIAL RISK OF SUFFOCATION.**
- 24) **CAUTION:** The Power switch on this unit will not completely shut off all power from AC outlet. Since the power cord serves as the main disconnect device for the unit, you will need to unplug it from the AC outlet to shut down all power. Therefore, make sure the unit has been installed so that the power cord can be easily unplugged from AC outlet in case of an accident. To avoid fire hazard, the power cord should also be unplugged from the AC outlet when left unused for a long period of time (for example, when on vacation).
- 25) **CAUTION:** TO PREVENT ELECTRIC SHOCK, DO NOT USE THIS PLUG WITH A RECEPTACLE OR OTHER OUTLET UNLESS THE BLADES CAN BE FULLY INSERTED TO PREVENT BLADE EXPOSURE.
- 26) **CAUTION:** USE WITH OTHER STAND MAY RESULT IN INSTABILITY POSSIBLY CAUSING INJURY.
- 27) **CAUTION:** DANGER OF EXPLOSION IF BATTERY IS INCORRECTLY REPLACED. REPLACE ONLY WITH THE SAME OR EQUIVALENT TYPE.
- 28) **CAUTION:** This LCD TV is for use only with the following optional accessory. Use with any other type of optional accessories may cause instability which could result in the possibility of injury. (All of the following accessories are manufactured by Panasonic Corporation)
  - Wall-hanging bracket: TY-WK3L2RW

Always be sure to ask a qualified technician to carry out set-up.

**NOTE:** This equipment is designed to operate in North America and other countries where the broadcasting system and AC house current are exactly the same as in North America.

## FCC STATEMENT

This equipment has been tested and found to comply with the limits for a Class B digital device, pursuant to Part 15 of the FCC Rules. These limits are designed to provide reasonable protection against harmful interference in a residential installation. This equipment generates, uses and can radiate radio frequency energy and, if not installed and used in accordance with the instructions, may cause harmful interference to radio communications. However, there is no guarantee that interference will not occur in a particular installation. If this equipment does cause harmful interference to radio or television reception, which can be determined by turning the equipment off and on, the user is encouraged to try to correct the interference by one or more of the following measures:

- Reorient or relocate the receiving antenna.
- Increase the separation between the equipment and receiver.
- Connect the equipment into an outlet on a circuit different from that to which the receiver is connected.
- Consult the dealer or an experienced radio/TV technician for help.

This device complies with Part 15 of the FCC Rules. Operation is subject to the following two conditions: (1) This device may not cause harmful interference, and (2) this device must accept any interference received, including interference that may cause undesired operation.

### FCC Caution:

**To assure continued compliance, follow the attached installation instructions and use only shielded interface cables when connecting to computer or peripheral devices. Any changes or modifications not expressly approved by Panasonic Corp. of North America could void the user's authority to operate this device.**

### FCC Declaration of Conformity Model No. TC-L37D2, TC-L42D2

Responsible Party: Panasonic Corporation of North America  
One Panasonic Way, Secaucus, NJ 07094

Contact Source: Panasonic Consumer Electronics Company  
1-877-95-VIERA (958-4372)

email: [consumerproducts@panasonic.com](mailto:consumerproducts@panasonic.com)

# Safety Precautions (Continued)



## WARNING

CEA CHILD SAFETY NOTICES: Flat panel displays are not always supported on the proper stands or installed according to the manufacturer's recommendations. Flat panel displays that are inappropriately situated on dressers, bookcases, shelves, desks, speakers, chests or carts may fall over and may cause personal injury or even death.

The consumer electronics industry (of which Panasonic is a member) is committed to making home entertainment enjoyable and safe. To prevent personal injury or death, be sure to follow the following safety guidelines:

### TUNE INTO SAFETY:

- One size does NOT fit all. Follow the manufacturer's recommendations for the safe installation and use of your flat panel display.
- Carefully read and understand all enclosed instructions for proper use of this product.
- Don't allow children to climb on or play with furniture and television sets.
- Don't place flat panel displays on furniture that can easily be used as steps, such as a chest of drawers.
- Remember that children can become excited while watching a program, especially on "larger than life" flat panel displays. Care should be taken to install the display where it cannot be pushed, pulled over, or knocked down.
- Care should be taken to route all cords and cables connected to the flat panel display so that they cannot be pulled or grabbed by curious children.

### WALL MOUNTING: IF YOU DECIDE TO WALL MOUNT YOUR FLAT PANEL DISPLAY, ALWAYS:

- Use a mount that has been recommended by the display manufacturer and/or listed by an independent laboratory (such as UL, CSA, ETL).
- Follow all instructions supplied by the display and wall mount manufacturers.
- If you have any doubts about your ability to safely install your flat panel display, contact your retailer about professional installation.
- Make sure the wall where you are mounting the display is appropriate. Some wall mounts are not designed to be mounted to walls with steel studs or old cinder block construction. If you are unsure, contact a professional installer.
- A minimum of two people are required for installation. Flat panel displays can be heavy.

**The American Academy of Pediatrics discourages television viewing for children younger than two years of age.**

### This product incorporates the following software:

- (1) software developed independently by or for Panasonic Corporation,
- (2) software owned by a third party and licensed to Panasonic Corporation,
- (3) software licensed under the GNU General Public License, Version 2 (GPL v2),
- (4) software licensed under the GNU LESSER General Public License (LGPL) and/or,
- (5) open source software other than software licensed under the GPL and/or LGPL

For the software categorized as (3) or (4), please refer to the terms and conditions of GPL v2 and LGPL, as the case may be at <http://www.gnu.org/licenses/old-licenses/gpl-2.0.html> and <http://www.gnu.org/licenses/old-licenses/lgpl-2.1.html> In addition, software categorized as (3) or (4) is copyrighted by several individuals and/or entities. Please refer to the copyright notice of those individuals at <http://www.am-linux.jp/dl/DTV10UT/>.

GPL/LGPL SOFTWARE IS DISTRIBUTED IN THE HOPE THAT IT WILL BE USEFUL, BUT WITHOUT ANY WARRANTY, EXPRESS, IMPLIED OR STATUTORY, INCLUDING THE IMPLIED WARRANTIES OF MERCHANTABILITY OR FITNESS FOR A PARTICULAR PURPOSE.

For at least three (3) years from delivery of products, Panasonic will give to anyone who contacts us at the address provided below, for a charge of no more than our cost of physically performing source code distribution, a complete machine-readable copy of the corresponding source code covered under GPL v2/LGPL.

Contact Information

[cdrequest@am-linux.jp](mailto:cdrequest@am-linux.jp)

Source code is also freely available to you and any other member of the public via our website below.



<http://www.am-linux.jp/dl/DTV10UT/>

# Accessories/Optional Accessory

## Accessories

✓ Check you have all the items shown.

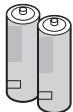
### Accessories

- |   |   |   |
|---|---|---|
| <input type="checkbox"/> Remote Control Transmitter<br>● N2QAYB000485   | <input type="checkbox"/> Batteries for the Remote Control Transmitter (2)<br>● AA Battery | <input type="checkbox"/> Pedestal<br>● TBLX0165 (With BAG) / TBLA0543 (TC-L37D2)<br>● TBLX0164 (With BAG) / TBLA0540 (TC-L42D2) |
|                              |        |  How to assemble (p. 8)                      |
| <input type="checkbox"/> Universal Dock for iPod (p. 20)<br>● TNM2AX0013  | <input type="checkbox"/> Operating Instructions   | <input type="checkbox"/> VIERA Concierge and Quick Start Guide  |
|  * Adapters sold separately. | <input type="checkbox"/> Product Registration Card (U.S.A)                                |   |

### Optional Accessory

**Wall-hanging bracket**  
● TY-WK3L2RW

Please contact your nearest Panasonic dealer to purchase the recommended wall-hanging bracket. For additional details, please refer to the wall-hanging bracket installation manual.

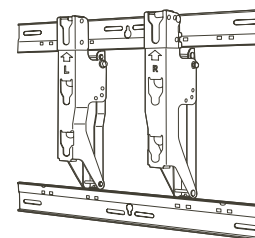

#### Back of the TV

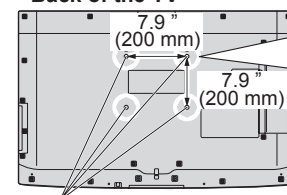

Holes for wall-hanging bracket installation

Screw for fixing the TV onto the wall-hanging bracket (not supplied with the TV)

**Depth of screw:**  
Minimum: 0.39" (10.0 mm)  
Maximum: 0.67" (17.0 mm)

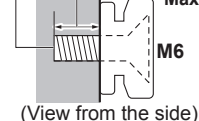

(View from the side)

### WARNING

- Customer assumes liability if mounting the unit themselves or if a Panasonic bracket is not used. Any damage resulting from not having a professional installer mount your unit will void your warranty.
- Always be sure to ask a qualified technician to perform any necessary set-up. Incorrect fitting may cause equipment to fall, resulting in injury and product damage.
- Do not mount the unit directly below ceiling lights (such as spotlights, floodlights or halogen lights) which typically give off high heat. Doing so may warp or damage plastic cabinet parts.
- Take care when fixing wall brackets to the wall. Always ensure that there are no electrical cables or pipes in the wall before hanging bracket.
- When using an angled-type wall hanging bracket, please ensure that there is sufficient space for the connecting cables so that they do not press against the wall when the TV is tilted forward.
- For safety reasons, remove units no longer being used from their wall-mounted locations.

## Installing the remote's batteries

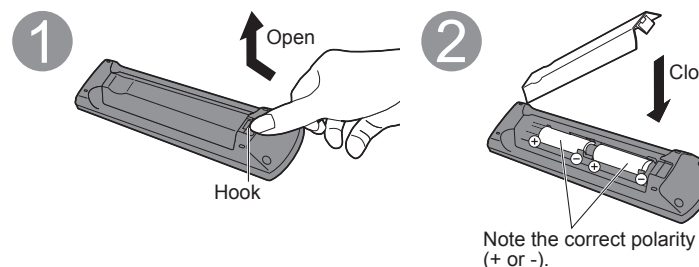

### Caution

- Incorrect installation may cause battery leakage and corrosion, resulting in damage to the remote control.
- Do not mix old and new batteries.
- Do not mix different battery types (such as alkaline and manganese batteries).
- Do not use rechargeable (Ni-Cd) batteries.
- Do not burn or break batteries.



## Attaching the pedestal to TV

### Assembling the pedestal ■ Set-up

- Fix securely with assembly screws (A). (Total 4 screws)
- Tighten screws firmly.
- Fix securely with assembly screws (B). (Total 4 screws)
- Tighten screws firmly.

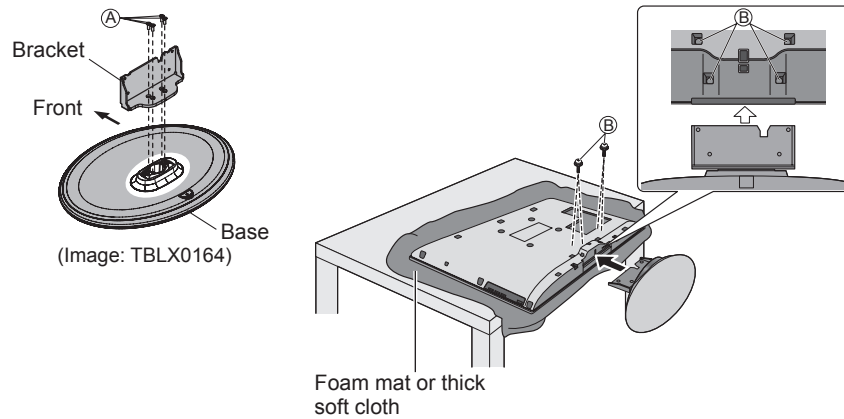

### Accessories

Assembly screws  
(4 of each)



XSS5+15FNK  
M5 x 15



XYN4+F12FJK  
M4 x 12

Bracket (1)

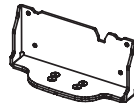

Base (1)

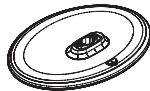

### Location

Place the TV at a comfortable distance for viewing. Avoid placing it where sunlight or other bright light (including reflections) will fall on the screen. Use of some types of fluorescent lighting can reduce remote control transmitter range. Adequate ventilation is essential to prevent an internal component failure. Keep away from areas of excessive heat or moisture.

Adjust the LCD panel to your desired angle.

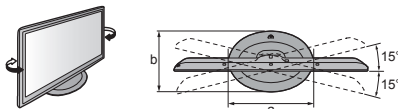

(View from above)

- TC-L37D2  
a: 15.8" (399 mm)  
b: 11.1" (280 mm)
- TC-L42D2  
a: 17.8" (450 mm)  
b: 12.2" (309 mm)

### Note

- Ensure that the pedestal does not hang over the edge of the base even if the TV swivels to the full rotation range.
- Do not place any objects or hands within the full rotation range.

### WARNING

**Do not disassemble or modify the pedestal.**

- Otherwise the TV may fall over and become damaged, and personal injury may result.

### Caution

**Do not use any other TV and displays.**

- Otherwise the TV may fall over and become damaged, and personal injury may result.

**Do not use the pedestal if it becomes warped or physically damaged.**

- If you use the pedestal when it is physically damaged, personal injury may result. Contact your nearest Panasonic Dealer immediately.

**During set-up, make sure that all screws are securely tightened.**

- If sufficient care is not taken to ensure screws are properly tightened during assembly, the pedestal will not be strong enough to support the TV, and it might fall over and become damaged, and personal injury may result.

### Reference of connection

#### Antenna terminal

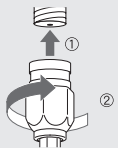

- Firmly tighten by hand.

#### Pin terminals

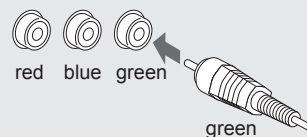

- Match colors of plugs and terminals.
- Insert firmly.

#### HDMI terminal

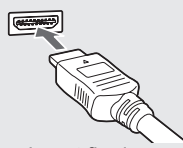

- Insert firmly.

# Basic Connection

## Example

## Connecting Antenna (To watch TV)

TV



### VHF/UHF Antenna

- NTSC (National Television System Committee): Conventional broadcasting
- ATSC (Advanced Television Systems Committee): Digital TV Standards include digital high-definition television (HDTV), standard-definition television (SDTV), data broadcasting, multi-channel surround-sound audio and interactive television.

## To connect the antenna terminal

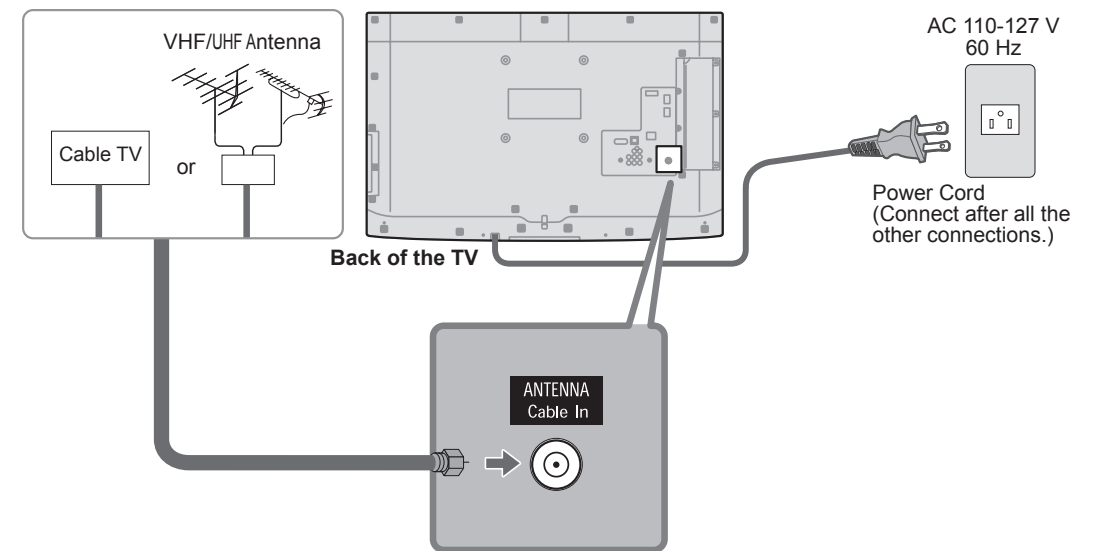

### Cable

- You need to subscribe to a cable TV service to enjoy viewing their programming.
- You can enjoy high-definition programming by subscribing to a high-definition cable service. The connection for high-definition can be done with the use of an HDMI or Component Video cable. (p. 10)
- To view high-definition programming select the correct video input. (p. 24)

### Note

- Not all cables and external equipment shown in this book are supplied with the TV.
- For more details on the external equipment's connections, please refer to the operating manuals for the equipment.
- For additional assistance, visit us at: [www.panasonic.com](http://www.panasonic.com)  
[www.panasonic.ca](http://www.panasonic.ca)

# Basic Connection (Continued)

## AV cable connections

High-Definition

### A To use HDMI terminals

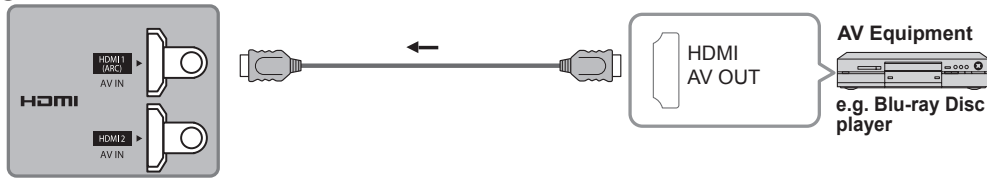

- Connecting to the HDMI terminals will enable you to enjoy high-definition digital images and high-quality sound.
- The HDMI connection is required for a 1080p signal.
- For "VIERA Link™ connections", please refer to p. 31.

### B To use COMPONENT terminals

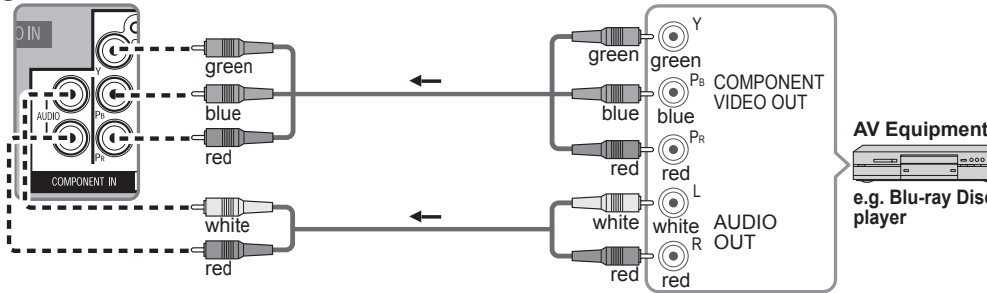

Standard-Definition

### C To use COMPOSITE terminals

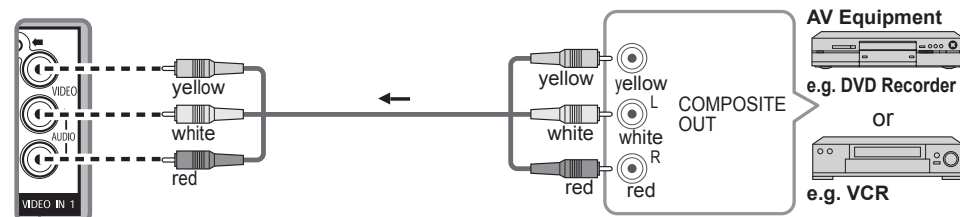

#### Note

- For more details on the external equipment's connections, please refer to the operating manual for the equipment.

# Identifying Controls

## TV controls/indicators

### Front of the TV

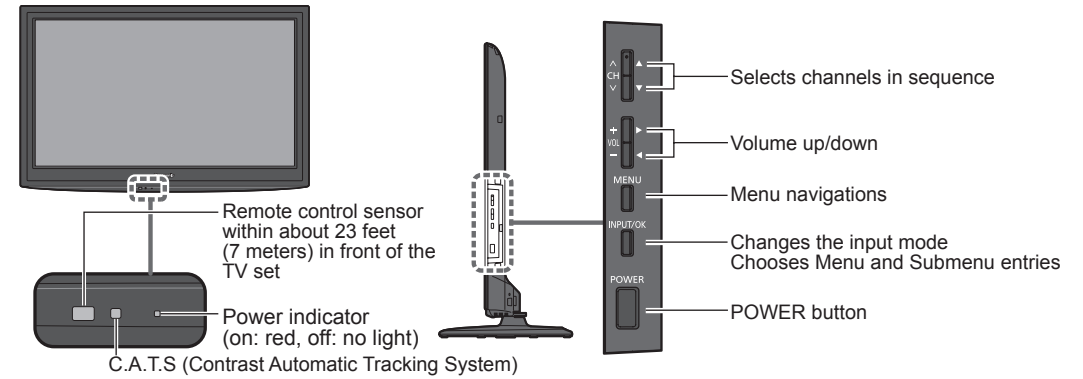

#### Note

- The TV consumes a small amount of electric energy even when turned off.
- Do not place any objects between the TV remote control sensor and remote control.

## Remote control

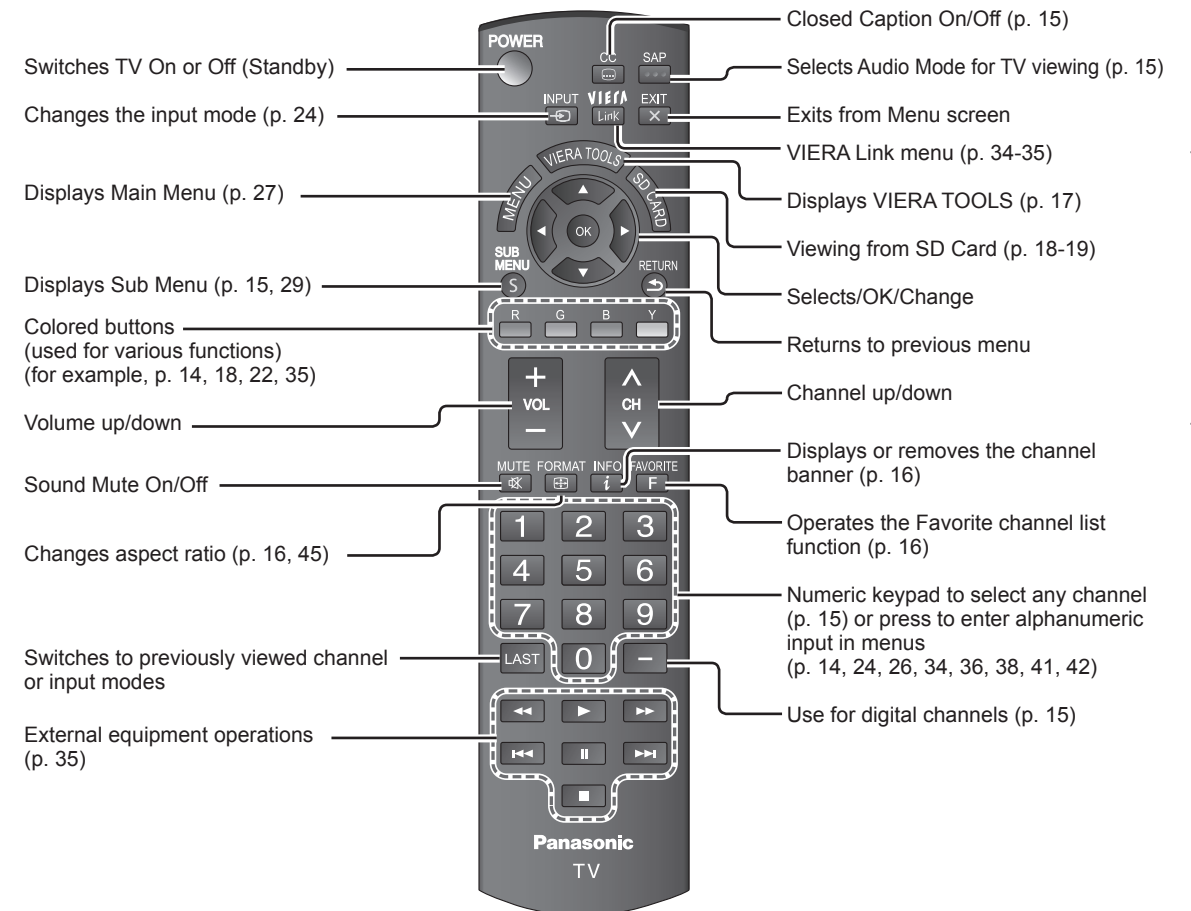

Quick Start Guide

● Identifying Controls  
● Basic Connection (AV cable connections)

# First Time Setup

First time setup screen is displayed only when the TV is turned on for the first time after the power cord is inserted into a wall outlet and when "Auto power on" (p. 29) is set to "No".

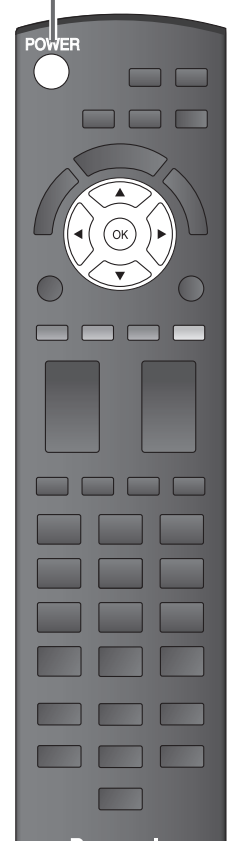

**1 Turn the TV On with the POWER button**  
(TV) (Remote)

**2 Configure your viewing mode**

**① Select your language**

**② Select your viewing mode (Be sure to select "Home use")**

● Please confirm your selection (Home Use) before pressing OK button.

**■ If you select "Store Demonstration" by mistake in ②, confirmation screen will be displayed.**

● Select "No" and return to previous screen ②.  
● If you select "Yes", Screen enters the store demonstration mode.

To display the "Set viewing mode" screen again as shown above and select "Home Use", do one of the following:

- Press and hold down the side POWER button for at least five seconds.
- Unplug power cord for 30 seconds and plug it again.

### Note

- RETURN is not available on ② - ①.
- EXIT is not available on ②.
- When you have used ② to turn the TV off, the next time you turn the TV on the "Language" settings will be displayed.
- If you use any other step other than ② to turn the TV off, or if you used the EXIT button to quit before completing the settings, the next time you turn the TV on "First time setup" will not be automatically displayed.
  - The settings up to that point are saved.
  - You can reset the settings using "First time setup". (p. 29)
- To change the setting (Language, ANT/Cable setup, Input labels, Clock) later, go to the Menu screen (p. 29)

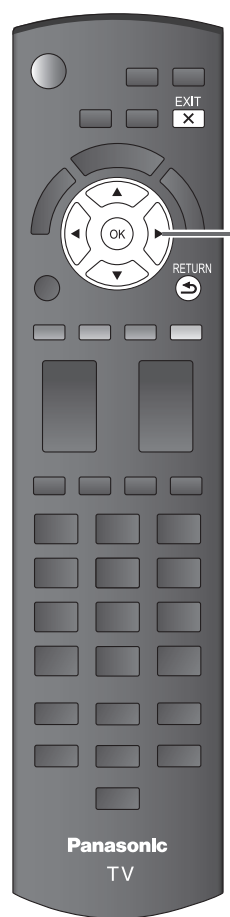

**3 Auto channel setup (ANT/Cable setup)**

**① Select the connected Antenna in terminal**

Not used: Go to ④ (Label inputs)

Select "Not used" when no wire is connected to the "Antenna/Cable" terminal.

- Typical when a Cable/Satellite box is connected to a TV input.
- Prevents accidental tuning to an unavailable signal.

**② Select "Start"**

Skip: Go to ④ (Label inputs)

**Start scanning the channels**  
(Available channels are automatically set.)

Auto program	
Progress	8%
Number of analog channels	10
Number of digital channels	0
Press RETURN to quit	

**③ Complete the Auto program setup**

Completion message is displayed when the Auto program scan is successfully completed.

Auto program	
Number of analog channels	10
Number of digital channels	0
Auto program completed. Press OK to continue.	

If there is no available channel, return to ③ - ① (ANT/ Cable setup). "Not used" will be selected.

**■ Press to return to the previous screen**

**■ Operation of the EXIT button during "First time setup"**

Press the button once to display confirmation screen. Press again to close confirmation screen.

**[EXIT confirmation screen]**

Yes → Exit "First time setup"  
No → Return to the original screen.

# First Time Setup (Continued)

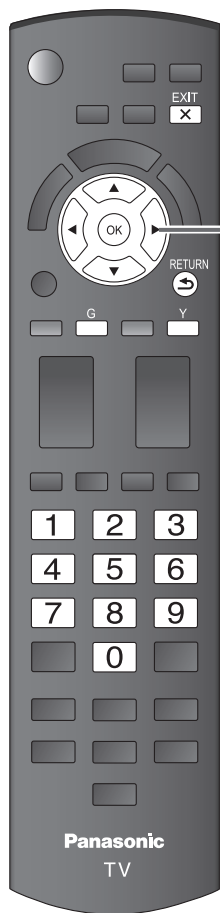

## 4 Select the Input labels (Label inputs)

Select NEXT then press OK to go to the next step.

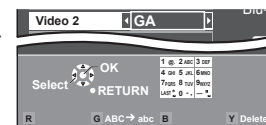
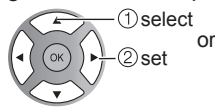
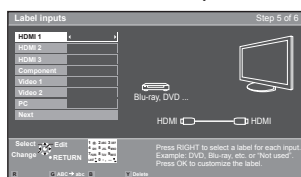

Follow the instructions on screen to complete the following operations.

Label: [BLANK] Not used/Blu-ray/DVD/DVD REC/HOME THTR/GAME/COMPUTER/VCR/CABLE/SATELLITE/DVR/CAMERA/MONITOR/AUX/RECEIVER/MEDIA CTR/MEDIA EXT/OTHER

## 5 Adjust the Clock (Set clock)

Select NEXT then press OK to go to the next step.

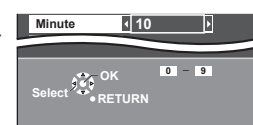
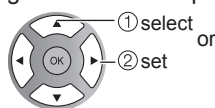
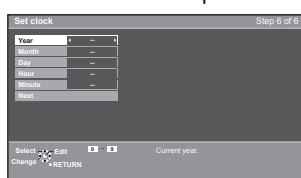

Follow the instructions on screen to complete the following operations.

## 6 Complete the First time setup

Completion message is displayed when you have successfully completed the First time setup.

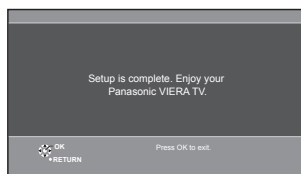

### Note

- About broadcasting systems

#### Analog (NTSC):

Conventional broadcasting

#### Digital (ATSC):

New programming that allows you to view more channels featuring high-quality video and sound

# Watching TV

Basic connection (p. 9-10)

## To watch TV and other functions

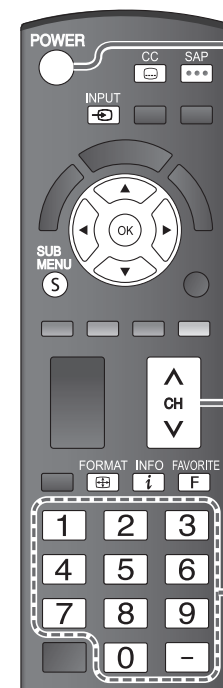

## 1 Turn power on

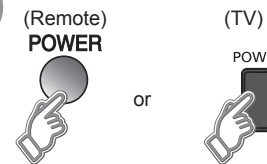

### Note

- If the mode is not TV, press and select TV. (p. 24)

## 2 Select a channel number

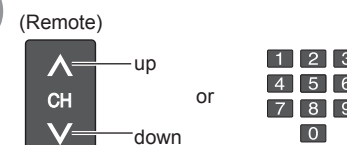

### To directly enter the digital channel number

- When tuning to a digital channel, press the button to enter the minor number in a compound channel number.

example: CH15-1:

### Note

- Reselect "Cable" or "Antenna" in "ANT in" of "ANT/Cable setup" to switch the signal reception between cable TV and the antenna. (p. 13, 39)
- The channel number and volume level remain the same even after the TV is turned off.

## Other Useful Functions (Operate after 2)

### Listen with SAP (Secondary Audio Program)



#### Select Audio mode for watching TV

##### Digital mode

Press SAP to select next Audio track (if available) when receiving a digital channel.

Audio track 1 of 2 (English)

##### Analog mode

Press SAP to select the desired Audio mode.

- Each press of SAP will change the Audio mode. (Stereo/SAP/Mono)

### Closed caption



#### Switches the Closed caption mode On or Off

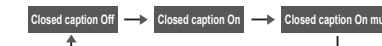

### Display the SUB MENU





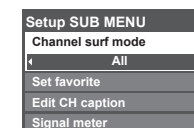

#### Press SUB MENU to show the Sub menu screen (p. 29)

This menu consists of shortcuts to convenient functions.



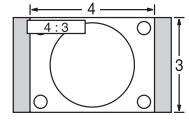

# Watching TV (Continued)

Information recall	<p>■ <b>Displays or removes the channel banner</b></p>  <div style="border: 1px solid black; padding: 5px; margin: 5px;"> <p>Channel: 15-2 THE NEWS 12:30 PM</p> <p>ABC-HD CC SAP TV-G 1080i Standard 4:3</p> <p>Station identifier SAP indication Signal resolution Picture mode Sleep timer remaining time</p> <p>Closed caption Rating level Aspect ratio</p> </div>
Change aspect ratio	<p>■ <b>Press FORMAT to cycle through the aspect modes (p. 45)</b></p>   <ul style="list-style-type: none"> <li>• 480i, 480p: FULL/JUST/4:3/ZOOM</li> <li>• 1080p, 1080i, 720p: FULL/H-FILL/JUST/4:3/ZOOM</li> </ul>
Call up a favorite channel	<p>■ <b>FAVORITE</b></p>  <p>Channel numbers registered in Favorite are displayed on the favorite tune screen. Select the desired broadcast station with the cursor or use the number buttons. (see below)</p>

## Favorite Feature

### ■ Set the Favorite Feature

1 Display the SUB MENU.



2 Select "Set favorite"

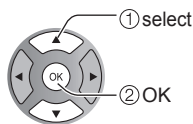
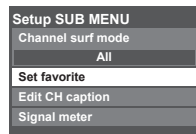

3 Set the displayed channel

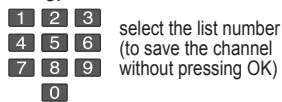
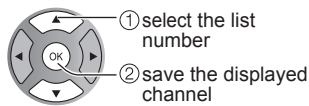
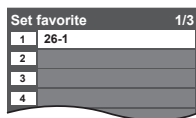

Delete a Favorite channel

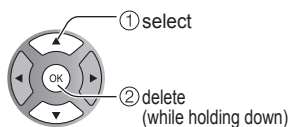
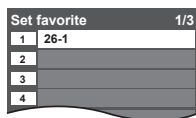

### ■ Use the Favorite Feature

1 Display "Favorite channels"



2 Select the channel

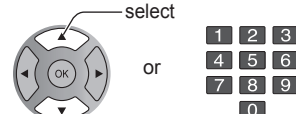
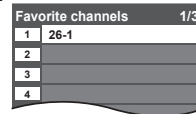

3 Set a Favorite channel

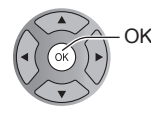
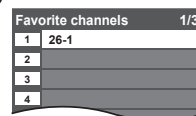

### ■ To change the page



Press repeatedly to change between pages (1/3, 2/3, 3/3 or exit)



Changes the page forward/backward

# Using VIERA TOOLS

VIERA TOOLS is the easy way to access frequently-used menu items. They are displayed as shortcut icons on the TV screen.

Unlike a conventional menu, you can enjoy using, playing or setting a function quickly.

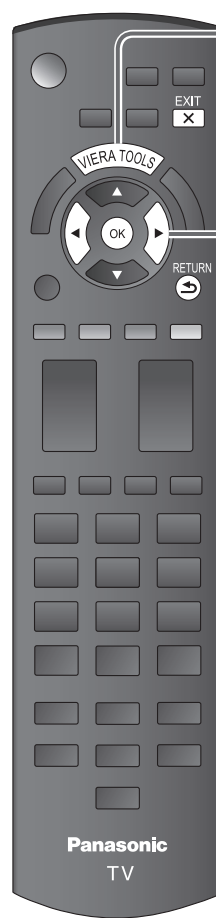

- ### 1 Display VIERA TOOLS

- ### 2 Select the item

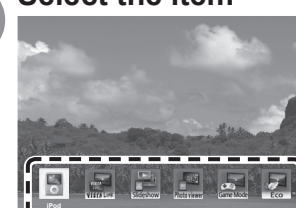
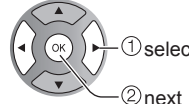

- ### 3 Set each item

  - iPod → Playing an iPod (p. 20-23)
  - VIERA Link → VIERA Link (p.34-35)
  - Slideshow → Slideshow (p. 18-19)
  - Photo viewer → Photo viewer (p. 18-19)
  - Game Mode → Game Mode setting (Game/Standard)
  - Eco mode → ECO/energy saving (p. 29)

■ **Press to exit from a menu screen**



■ **Press to return to the previous screen**



Please select Picture mode. Game mode allows optimum picture settings for gaming.

Game Standard

# Viewing with VIERA IMAGE VIEWER

The VIERA Image Viewer is a function that lets you easily view still images on a VIERA television by simply inserting an SD card into the VIERA SD card slot.  
(Media other than SD Cards will not work.)

**Photo viewer**

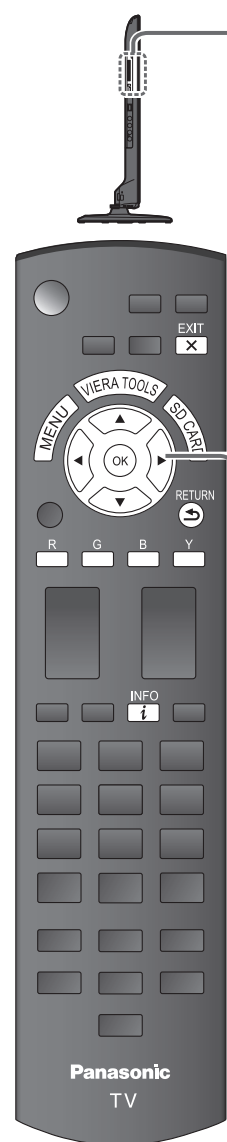

## 1 Insert the SD card

\* This setting will be skipped next time unless you select "Set later".

### Set "Image viewer settings" and select "Play image viewer now"

- "Image viewer settings" will be displayed automatically each time an SD card is inserted for the first time.

**Image viewer settings**

Image viewer auto play  
Set later

Play image viewer now

① select Slideshow: A Slideshow will start automatically next time.  
② change Thumbnail: The Photo viewer menu will be displayed automatically next time.  
③ set Set later: "Image viewer settings" menu will be displayed repeatedly.  
Off: The data can be played manually.

■ Manual operation ("Image viewer auto play" is "Off")

**Display "Photo viewer"      Start the Slideshow**



SD CARD



VIERA TOOLS

① select      ② next

## 2 Select the data to be viewed

**Thumbnail view**

Photo viewer All photos

Total 238

Name Pana0001 Pana0002 Pana0003 Pana0004

Date 03/04/2010

Size 1029x1200

① select      ② view

To launch Slideshow  
Selected picture information is displayed  
Total number of images

**Note**

- Depending on the JPEG format, "Information" contents may not be displayed correctly. Refer to p. 46 (Data format for SD Card browsing) for details.

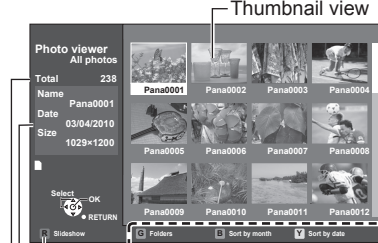

## 3 View

Navigation area

Accessing

Rotate

Prev. Play Next

RETURN

Single photo view

① Rotate 90 degrees (counter-clockwise)

② To next photo

③ Rotate 90 degrees (clockwise)

To previous photo

Present status (While reading the data)

Accessing

Prev. Pause Next

RETURN

Slideshow

① Rotate 90 degrees (counter-clockwise)

② To next photo

③ Rotate 90 degrees (clockwise)

To previous photo

■ Press to exit from a menu screen  
EXIT

■ Press to return to the previous screen  
RETURN

- Insert the card  
Gently insert the SD Card label surface facing front.
- Remove the card  
Press in lightly on SD Card, then release.
- Compliant card type (maximum capacity):  
SDHC Card (32 GB), microSDHC Card (16 GB), SD Card (2 GB), miniSD Card (2 GB), microSD Card (2 GB) (requiring microSDHC Card/miniSD Card/microSD Card adapter)
- If a microSDHC Card, miniSD Card or microSD Card is used, insert / remove it together with the adapter.
- For cautions and details on SD Cards (p. 46)

## SD Card

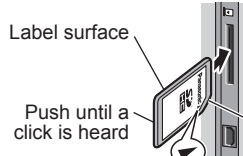

Label surface

Push until a click is heard



Cutout

Press in lightly on SD Card, then release.

## Sort

■ To sort by Folder, month or date

In ②

### ① Select the sort type

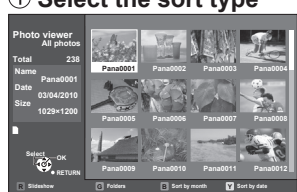

- Folders (ascending order of numeric/alphabetical)
- Sort by month (ascending order of the month)
- Sort by date (ascending order of the date)

### ② Select the directory

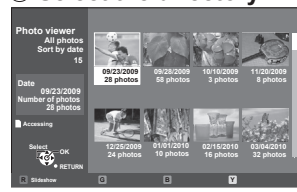

① select      ② OK

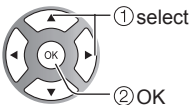

RETURN  
Return to previous screen

## Photo settings

In ② or ③

### ① Display "Photo settings"



Photo settings

Picture

Audio

Slideshow settings

Soundtrack Off

① select      ② change      ③ next

### Adjust the Picture/Audio

Picture 1/2

Reset to defaults

Picture mode Vivid

Back light 20

① select      ② adjust

example: Picture menu  
Picture menu/Audio menu (p. 28)

### Set the Soundtrack

Soundtrack Off

change

Select the music from 6 types.  
(Off/Music 1/Music 2/Music 3/Music 4/Music 5/iPod)

### Slideshow settings

Slideshow settings

Display interval Fast

Repeat playback Off

Transition effect Off

Photo effect Sepia

① select      ② adjust

**Note**

- To stop in mid-cycle → Press RETURN

<b>Display interval</b>	You can set how many seconds each image is displayed in the Slideshow mode. (Short/Fast/Normal/Slow/Very slow)
<b>Repeat playback</b>	Turn the Slideshow Repeat function on or off. (Off/On).
<b>Transition effect</b>	Select the Transition effect. (Off /Wipe ↓/Wipe ↑/Wipe →/Wipe ←/Comb ↕/Comb →←/Dissolve/Checker wipe/Random/Array/Collage)
<b>Photo effect</b>	Select the conversion effect. (Off/Sepia/Gray scale)

# Playing an iPod on TV

You can enjoy iPod music/videos/photos on your TV, and you can also charge the battery by connecting the Universal Dock for iPod to your TV.

## Set up Universal Dock for iPod

### Controls and basic functions

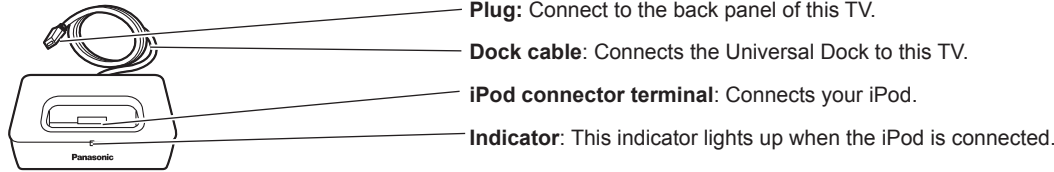

### Connecting the Universal Dock for iPod

Ensure that the power of this TV is switched off before you connect the Universal Dock. Connect the plug of the Universal Dock to the Dock for iPod terminal of this TV.

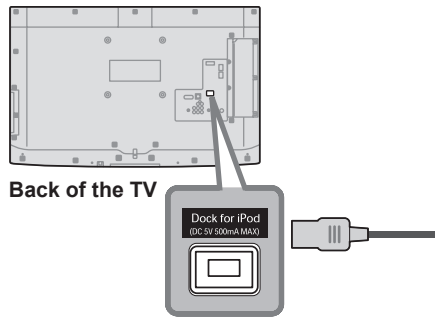

#### Note

- Do not connect any other optional Dock. (Only use the included Universal Dock for iPod)

### Connecting your iPod

Insert your iPod into the connector terminal of the Universal Dock.

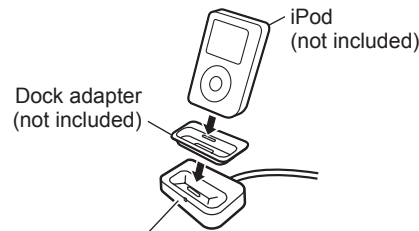

The indicator lights up when the iPod is inserted, and charging begins.

#### Note

- Panasonic has no warranty for iPod data management.
- Do not twist your iPod when inserting it or taking it off from the Universal Dock, and be careful not to knock over this Universal Dock when your iPod is inserted.
- Do not remove your iPod from the Universal Dock while you play your iPod with the TV.
- It is recommended that you update your iPod software before using it with the Universal Dock. The updater for the iPod software is available on the Apple website.
- Attach the Dock adapter (which should be supplied with your iPod) to the Dock for the stable use of the iPod. If you need an adapter, consult your iPod dealer.

### Charging your iPod

Your iPod can be recharged while your iPod is connected to the Universal Dock.

- iPod will start recharging regardless of whether this TV is on or off (standby).

### Disconnecting the Universal Dock for iPod

#### Preparation

Switch off the power of the TV.

- Switch off the iPod.
- Pull out the plug of the Universal Dock from the Dock for iPod terminal of the TV.

## Basic feature

### Feature

- You can enjoy music/videos/photos on your iPod on the TV screen.
- You can enjoy music on your iPod while viewing photos with VIERA IMAGE VIEWER.

### Available modes for your iPod

#### TV control mode (Music/Video/Podcasts)

You can operate your iPod through the TV screen using the TV remote control. (p. 22)



#### Remote mode (Photo)

You can operate your iPod through the iPod screen using either the TV remote control or the iPod itself. (p. 23)

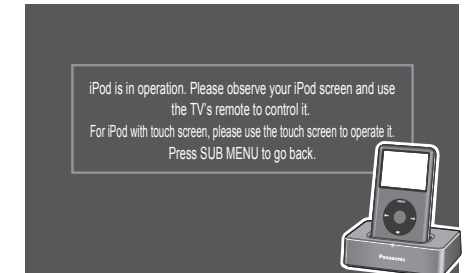

- Remote mode lets you view videos (Camera Videos) recorded by iPod nano 5G Videos Camera function.

### iPod menu feature

#### iPod viewer (Main screen)

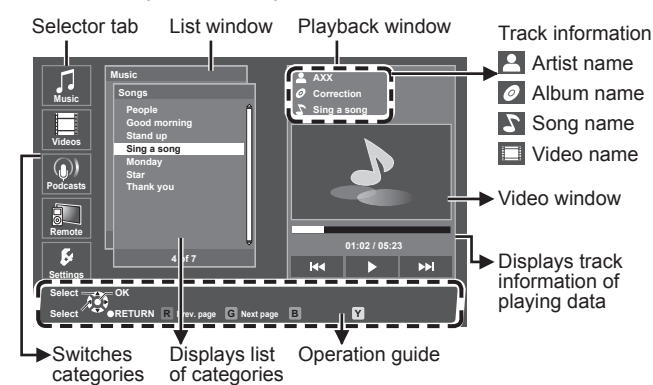

#### Full screen (Only for Video playback)



### Compatible iPod models

iPhone			iPod					iPod nano				iPod mini			
3GS	3G	iPhone	touch (2G)	touch (1G)	classic	5G (video)	Photo/4G (color display)	4G	5G (video camera)	4G (video)	3G (video)	2G (aluminium)	1G	2G	1G
16GB	8GB	4GB	8GB	8GB	80GB	30GB	20GB	20GB	8GB	8GB	4GB	2GB	1GB	4GB	4GB
32GB	16GB	8GB	16GB	16GB	120GB	60GB	30GB	40GB	16GB	16GB	8GB	4GB	2GB	6GB	6GB
		16GB	32GB	32GB	160GB	80GB	40GB					8GB	4GB		

- Compatibility depends on the software version of your iPod.
- For the iPod Touch/iPhone only music/video/photo services can be enjoyed on this TV.

iPod is a trademark of Apple Inc., registered in the U.S. and other countries.  
 iPhone is a trademark of Apple Inc.  
 "Made for iPod" means that an electronic accessory has been designed to connect specifically to iPod and has been certified by the developer to meet Apple performance standards.  
 "Works with iPhone" means that an electronic accessory has been designed to connect specifically to iPhone and has been certified by the developer to meet Apple performance standards.  
 Apple is not responsible for the operation of this device or its compliance with safety and regulatory standards.



# Playing an iPod on TV (Continued)

## Playing an iPod on this TV

### Preparations

- Set up Universal Dock for iPod (P. 20).
- Before connecting/disconnecting the iPod, turn the TV off or reduce the volume of the TV to its minimum.
- Use the menu on your iPod to select the appropriate video/photo output settings for your TV. (Refer to the operating instructions of your iPod.)

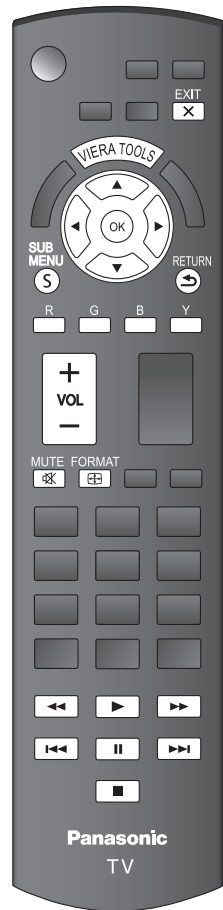

**1 Display main window**  
Connect your iPod (not included) firmly Select iPod icon in VIERA TOOLS (p. 17)



**2 Select the category in the Selector tab**

① select  
② next/set

- Remote mode (Photo playback)
- Settings (iPod options)

**3 Select track in the List window and play**

① select  
② next/set



**Full screen**  
(Only for Video playback)



● For more information, refer to the operating instructions for iPod.

### Available TV remote control buttons

	Play		Set/Access
	Stop		Return to previous menu
	Reverse/Forward		Exit
	Skip Reverse/Forward		Mute
	Pause		Volume up / down
	Move the cursor/Select		

■ Press to exit from a menu screen



■ Press to return to the previous screen



### Remote mode (Photo playback)

**In 2**  
① Select "Remote"



Screen will be switched when "Remote" is selected.

**2 Operate**  
Operate your iPod through the iPod screen using either the TV remote control or the iPod.

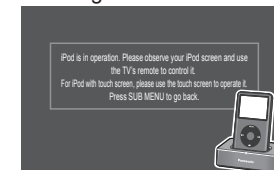

**SUB MENU**  
 S  
Go back to main menu

\*For iPod with touch screen, please use the touch screen to operate it.

### Settings (iPod options)

**In 2**  
① Select "Settings"



② Select the item and adjust

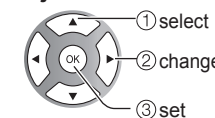
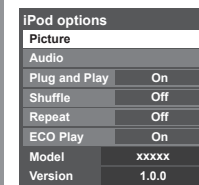

(example)

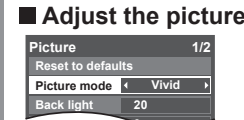

example: Picture menu  
Picture menu/Audio menu (p. 28)

● How to play a favorite song?

Before you set these settings, connect your iPod to the Universal Dock with the desired track set to pause. (When the "Shuffle" setting is "Songs" or "Albums", iPod starts shuffle play.)

### Background music (Music playback)

While viewing Photo viewer (p. 18-19)  
① Follow the direction ①-② in Photo settings (p. 19)

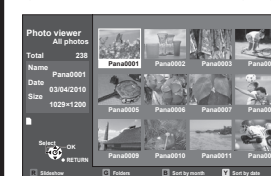

② Set "iPod" in "Soundtrack"  
(Refer to "Photo settings" on p. 19)



③ Operate  
Operate your iPod using either the TV remote control or the iPod itself.

### Other functions

#### On Timer playback

When the TV is turned On using the Timer, the iPod starts playing.

① Follow the direction ①-④ in "Using Timer" (p. 42)

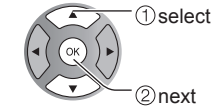

② Set "On" in "Timer set"

③ Set "iPod" in "Inputs"



④ Set other Timer items

● Performance may change depending on the software version of the iPod.



# Watching Videos and DVDs

If you have applicable equipment connected to the TV, you can watch videos and DVDs on the TV screen.

## Input Select

You can select the external equipment to access.

- With the connected equipment turned On  
**Display the Input select menu**

- Select the input mode**

Input select	
1	TV
2	HDMI 1 <b>GAME</b>
3	HDMI 2
4	HDMI 3 <b>GAME</b>
5	Component <b>AUX</b>
6	Video 1
7	Video 2 <b>GAME</b>
8	PC

1 2 3  
4 5 6  
7 8 9  
0

or

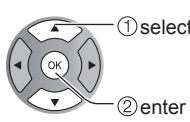

① select  
② enter

Press the corresponding NUMBER button on the remote control to select the input of your choice.

Select the input of your choice, then press OK.

  - During the selection, if no action is taken for several seconds, the "Input select" menu disappears.
  - The terminal and label of the connected equipment are displayed. To label each of the inputs, please refer to p. 41.

(example)



Terminal Label  
(example)
- Operate the connected equipment using the remote control supplied with the equipment**

- Note**
- The input label will be displayed on the "Input select" screen if the Input label is set on p. 41.
  - For side input terminals (HDMI 3/Video 2), "GAME" input label is set as default. (Picture mode is set to "Game", refer to p. 47.)
  - For more details on the Picture mode setting, refer to p. 47. For "Input labels", refer to p. 41.

■ To return to TV  
INPUT → 1

- Note**
- For details, see the manual for the connected equipment.

## VIERA Link™ Setting

If you connect equipment that has the "HDMI Control" function to the TV using an HDMI cable, you will find it easier to use. Please refer to p. 30-35. Before using these functions, you need to set "VIERA Link" setting to "On" as shown below.

- Display the menu**

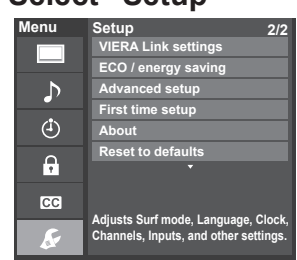

- Select "Setup"**

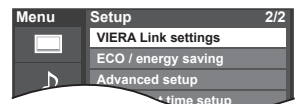

① select  
② next
- Select "VIERA Link settings"**

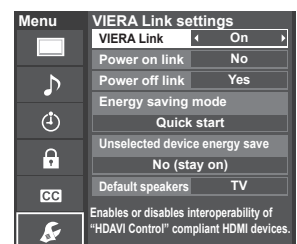

① select  
② next
- Select "VIERA Link"**



select
- Select "On"** (default is On)

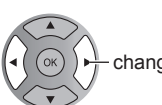

change

■ Press to exit from a menu screen  
EXIT

■ Press to return to the previous screen  
RETURN

Now you can set each "VIERA Link" function according to your preference (p. 32-35).

- Note**
- If no HDMI equipment is connected or standard HDMI equipment (non- "VIERA Link") is used, set it to "Off".
  - For more details on the external equipment's connections, please refer to the operating manuals for the equipment.

# Displaying PC Screen on TV

The screen of the PC connected to the unit can be displayed on the TV.  
You can also listen to PC sound with the audio cable connected. To connect PC. (p. 43)

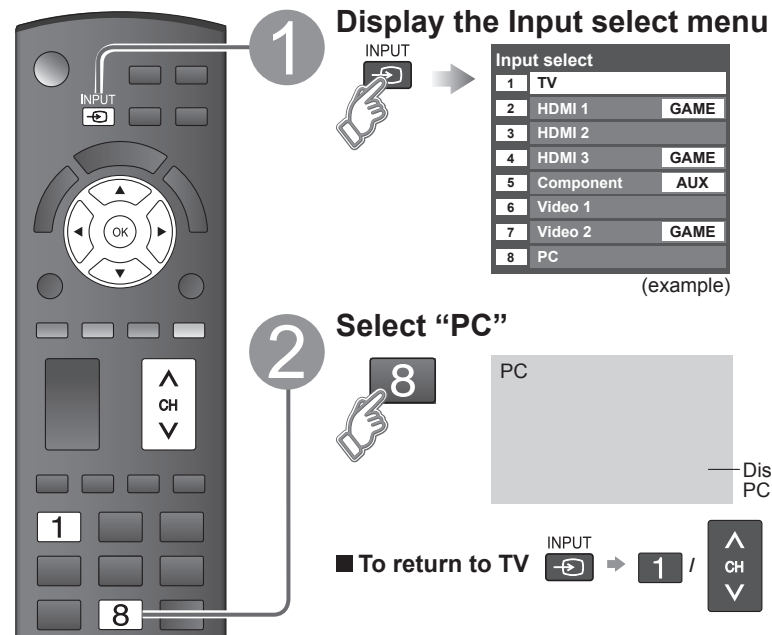

Input select	
1	TV
2	HDMI 1 GAME
3	HDMI 2
4	HDMI 3 GAME
5	Component AUX
6	Video 1
7	Video 2 GAME
8	PC

(example)

● Corresponding signals (p. 48)

## PC menu setting (change as desired)

● Making settings → "How to Use Menu Functions" ① to ④ (p. 27)

Menu	Item	Adjustments/Configurations (options)
Picture	Reset to defaults	Resets PC adjustments. Confirmation screen is displayed. Select "Yes" and press OK to reset.
	Sync	<ul style="list-style-type: none"> <li>● H &amp; V: The H and V sync signals are input from the HD/VD connector. (p. 49)</li> <li>● On green: Uses a synchronized signal on the Video G signal, which is input from the G connector. (p. 49)</li> </ul>
	Dot clock	Alleviates the problem if a picture appears to be vertically-striped, flickers partially or is blurred.
	H-position	Adjusts the horizontal position.
	V-position	Adjusts the vertical position.
	Clock phase	Alleviates the problem if the whole picture appears to flicker or is blurred. First adjust the Dot Clock to get the best possible picture, then adjust the Clock Phase so that a clear picture appears. <b>Note</b> It may not be possible to display a clear picture due to poor input signals.
	Input resolution	Switches to wide display. <ul style="list-style-type: none"> <li>● Input signal switched from 640×480 to 852×480</li> <li>● Input signal switched from 1024×768 to 1280×768 or 1366×768</li> </ul>
	H-frequency V-frequency	Displays the H (Horizontal)/V (Vertical) frequencies. <ul style="list-style-type: none"> <li>● Display range Horizontal: 15 - 110 kHz Vertical: 48 - 120 Hz</li> </ul>

● Audio menu (p. 28)

# How to Use Menu Functions

Various menus allow you to make settings for the picture, sound, and other functions so that you can enjoy watching TV best suited for you.

**1 Display the menu**

**2 Select the menu**

**3 Select the item**

**4 Adjust or select**

● Shows the functions that can be adjusted.  
● Some functions will be disabled depending on the type of input signal.

**Menu structure**

Menu bar  
Press OK to move to the Menu items.

Menu items  
Press OK to proceed to the next screen if available.

Help information  
Select or enter the name of the device connected to the HDMI 1 terminal.

Operation guide

(example: Input labels)

Press to exit from a menu screen  
EXIT X

Press to return to the previous screen  
RETURN ↶

① select  
② next  
select  
adjust or select

(example: Picture menu)

(example: Picture menu)

# How to Use Menu Functions

## Menu list

Menu	Item	Adjustments/Configurations (alternatives)	
Picture	Reset to defaults*	Resets all picture adjustments to factory default settings except for "Advanced picture".	
	Picture mode	Basic picture mode ( <b>Vivid/Standard/Cinema/Game/Custom</b> ) (p. 47)	
	Back light	Adjusts the luminance of the back light.	
	Contrast, Brightness, Color, Tint, Sharpness	Adjusts color, brightness, etc. for each picture mode to suit your taste ● Display range <b>Contrast/Brightness/Color/Sharpness:</b> 0 - 100 <b>Tint:</b> -50 - +50	
	Color temp.	Selects a choice of Cool (blue), Normal, or Warm (red) color. ( <b>Cool/Normal/Warm</b> )	
	A.I. picture	Controls dark areas without affecting the black level or brightness in the overall picture ( <b>Off/On</b> )	
	C.A.T.S.	Adjusts the brightness and gradation according to the ambient lighting condition. ( <b>Off/On</b> )	
	Video NR	Reduces noise, commonly called snow. Leave it off when receiving a strong signal. ( <b>Off/On</b> )	
	Aspect adjustments	Screen format	Changes the format (aspect ratio). ( <b>FULL/H-FILL/JUST/4:3/ZOOM</b> ) Lets you choose the aspect depending on the format of received signal. (p. 45)
		HD size	Selects between 95 % (Size 1) or 100 % (Size 2) for the scanning area with High-definition signal. ( <b>Size 1/Size 2</b> ) Select "Size 1" if noise is generated on the edges of the screen. ● Size 1: Selected item for "HD size". Scanning 95 % ● Size 2: Selected item for "HD size". Scanning 100 %
		H size	Adjusts the horizontal display range to reduce noise of both side edges of an image. ( <b>Size 1/Size 2</b> ) Size 2: Adjusts the image size according to the aspect mode for to reduce noise. (p. 48)
		Zoom adjustments	Adjusts vertical alignment and size when aspect setting is "ZOOM"
	PC adjustments	Sets PC display (p. 26)	
	Advanced picture	3D Y/C filter	Minimizes noise and cross-color in the picture. ( <b>Off/On</b> )
		Color matrix	Selects image resolution of component-connected devices ( <b>SD/HD</b> ) ● SD: Standard Definition HD: High Definition ● Only used with 480p video signal.
		MPEG NR	Reduces noise of specific digital signals of DVD, STB, etc. ( <b>Off/On</b> )
		Motion Picture Pro 4	Improved moving picture quality by reducing motion blur. ( <b>Off/Weak/Strong</b> )
		Black level	Selects Dark or Light. Valid only for external input signals. ( <b>Dark/Light</b> )
		3:2 pulldown	Adjusts the picture recorded in 24 fps for optimum quality. ( <b>Off/On/Auto</b> )
	Audio	Reset to defaults*	Resets Bass, Treble, and Balance adjustments to factory default settings.
Bass		Increases or decreases the bass response.	
Treble		Increases or decreases the treble response.	
Balance		Emphasizes the left / right speaker volume.	
Advanced audio		Surround	Enhances audio response when listening to stereo. ( <b>Off/On</b> )
		Volume leveler	Minimizes volume disparity after switching to external inputs.
		TV speakers	Switches to "Off" when using external speakers ( <b>Off/On</b> ) ● "Surround" and "Volume leveler" do not work if "Off" is selected.
	HDMI 1 in HDMI 2 in HDMI 3 in	The default setting is "Digital" for the HDMI connection. (Digital input signal) Select audio input terminal when DVI cable is connected. (Analog audio input signal) ( <b>Digital/Component/Video 1/Video 2</b> )	
Timer	Sleep, Timer 1-5	The TV can automatically turn On/Off at the designated date and time	
Lock		Locks the channels and programs. (p. 36)	
Closed caption	Closed caption	Displays subtitles (Closed caption). (p. 40)	

- In the AV mode, the Audio and Setup menus give fewer options.
- \* Confirmation screen is displayed. Select "Yes" and press OK to reset.

## (Continued)

## Menu list

Menu	Item	Adjustments/Configurations (alternatives)	
Setup	Channel surf mode	Sets the mode to select the channel with the Channel up/down button. ( <b>All/Favorite/Digital only/Analog only</b> ) ● Favorite: Only channels registered as FAVORITE. (p. 16)	
	Language	Selects the screen menu language.	
	Clock	Adjusts the clock. (p. 14)	
	ANT/Cable setup	Sets channels. (p. 13)	
	Input labels	Selects the terminal and label of the external equipment. (p. 41)	
	VIERA Link settings	VIERA Link	Controls the equipment connected to HDMI terminals ( <b>Off/On</b> ) (p. 32) ● "Power off link", "Power on link", "Energy saving mode", "Unselected device energy save" and "Default speakers" cannot be selected if "Off" is set.
		Power on link	Sets "Power on link" of the HDMI connected equipment ( <b>No/Yes</b> ) (p. 32)
		Power off link	Sets "Power off link" of the HDMI connected equipment ( <b>No/Yes</b> ) (p. 32)
		Energy saving mode	Sets "Energy saving mode" of the HDMI connected equipment. ( <b>Quick start/Save</b> ) (p. 32)
		Unselected device energy save	Sets "Unselected device energy save" of the HDMI connected equipment. (p. 32) ( <b>No (stay on)/Yes (with prompt)/Yes (no prompt)</b> )
		Default speakers	Selects the default speakers ( <b>TV/Theater</b> ) (p. 32)
	ECO/energy saving	Power save	Reduces screen brightness to lower power consumption. Eye-friendly for viewing in a dark room. ( <b>Standard/Saving</b> )
		No signal for 10 minutes	To conserve energy, the TV automatically turns off when NO SIGNAL and NO OPERATION continue for more than 10 minutes. ( <b>Stay on/Power TV off</b> ) <b>Note</b> ● Not in use when "Auto power on", "On/Off Timer" or "Lock" is set, or while "SD mode" or "Digital Channel" is selected. ● "No signal for 10 minutes was activated" will be displayed for about 10 seconds when the TV is turned on for the first time after the power was turned off by "No signal for 10 minutes". ● The on-screen display will flash 3, 2 and 1 to indicate the last three (3) remaining minutes prior to the shut-off.
		No activity for 3 hours	To conserve energy, the TV automatically turns off when no operation of remote and side panel key continues for more than 3 hours. ( <b>Stay on/Power TV off</b> ) <b>Note</b> ● Not in use when "Auto power on" or "On/Off Timer" is set, or while "PC input" is selected. ● "No activity for 3 hours was activated" will be displayed for about 10 seconds when the TV is turned on for the first time after the power was turned off by "No activity for 3 hours". ● The on-screen display will flash 3, 2 and 1 to indicate the last three (3) remaining minutes prior to the shut-off.
	Advanced setup	Auto power on	Turns TV On automatically when the cable box or a connected device is turned On ( <b>No/Yes</b> ) TV AC cord must be plugged into this device. TV comes on every time the power is restored. ● The "Sleep" timer, "On / Off timer", and "First time setup" will not function if "Auto power on" is set. (p. 42)
		Image viewer auto play	Set "Thumbnail" or "Slideshow" to play back SD cards automatically. ( <b>Slideshow/Thumbnail/Set later/Off</b> )
		First time setup	Restart first time setup from "Language" setting. (p. 12)
		About	Displays TV version and software license.
		Reset to defaults	Performing Reset will clear all items set with Setup, such as channel settings.

## Sub menu list

Menu	Item	Adjustments/Configurations (alternatives)
SUB MENU	Channel surf mode	Sets the mode to select the channel with Channel up/down button. ( <b>All/Favorite/Digital only/Analog only</b> )
	Set favorite	Sets favorite channels. (p. 16)
	Edit CH caption	Changes the station identifier. (p. 39)
	Signal meter	Checks the signal strength if interference or freezing occurs on a digital image.

# VIERA Link™ “HDAVI Control™”\*

Simultaneously control all Panasonic “HDAVI Control” equipped components using one button on the TV remote. Enjoy additional HDMI Inter-Operability with Panasonic products which have the “HDAVI Control” function. This TV supports “HDAVI Control 5” function. Connections to the equipment (DVD recorder DIGA, HD Camcorder, Home theater system, Amplifier, etc.) with HDMI cables allow you to interface with them automatically.

Equipment with the “HDAVI Control” function enables the following operations:

Version	Operations
HDAVI Control or later	<ul style="list-style-type: none"> <li>● Automatic Input Switching (p. 33)</li> <li>● Power on link (p. 33)</li> <li>● Power off link (p. 33)</li> <li>● Default speakers (p. 33)</li> <li>● One-touch theater playback (p. 33)</li> <li>● Speaker control (p. 35)</li> </ul>
HDAVI Control 2 or later	<ul style="list-style-type: none"> <li>● VIERA Link control only with the TV's remote control (p. 35)</li> <li>● Unselected device energy save (for available equipment only) (p. 33)</li> </ul>
HDAVI Control 3 or later	<ul style="list-style-type: none"> <li>● Provides setting information (p. 33)</li> <li>● Automatic lip-sync function (p. 33)</li> </ul>
HDAVI Control 4 or later	<ul style="list-style-type: none"> <li>● Energy saving mode (with Quick Start mode) (p. 33)</li> </ul>
HDAVI Control 5	<ul style="list-style-type: none"> <li>● Audio Return Channel Audio Return Channel (ARC) is a function that enables digital sound signals to be sent via an HDMI cable.</li> </ul>

■ **For the first time/When adding new equipment, reconnecting equipment or changing the setup after the connection, turn the equipment on and then switch the TV on. Set the input mode to HDMI1, HDMI2 or HDMI3 (p. 24), and make sure that the image is displayed correctly.**

VIERA Link “HDAVI Control”, based on the control functions provided by HDMI which is an industry standard known as HDMI CEC (Consumer Electronics Control), is a unique function that we have developed and added. As such, its operation with other manufacturers’ equipment that supports HDMI CEC cannot be guaranteed. Please refer to the individual manuals for other manufacturers’ equipment supporting the VIERA Link function.

## ■ HDMI cable

This function needs an HDMI compliant (fully wired) cable. Non-HDMI-compliant cables cannot be utilized.

It is recommended that you use Panasonic’s HDMI cable. Recommended part number:

RP-CDHS15 (4.9 ft/1.5 m), RP-CDHS30 (9.8 ft/3.0 m), RP-CDHS50 (16.4 ft/5.0 m)

\* For more details on the external equipment’s connections, please refer to the operating manuals for the equipment.

## VIERA Link™ Connections

Follow the connection diagrams below for HDAVI control of a single piece of AV equipment such as a DVD recorder (DIGA), Home theater system. Refer to page 32-35 for Setup Menu settings and additional control information.

● Optional HDMI and/or optical cables are not included.

If connection (or setting) of equipment compatible with HDAVI control is changed, switch the power of this unit Off and On again while the power of all equipment is On (so that the unit can correctly recognize the connected equipment) and check that the DVD recorder (DIGA), Home theater system playback operate.

### Note

- HDMI 1 is recommended. When connecting to HDMI 2/HDMI 3, set the input mode to HDMI 2/HDMI 3 (p. 24) initially before connecting to HDMI 2/HDMI 3. After connection, confirm the HDMI control functions (p. 32-35).

### ■ Connecting this unit to the DVD recorder (DIGA), Home theater system

- For DVD recorder (DIGA): Connect with HDMI cable
- For Home theater system  
Connect with the HDMI and audio cables. If audio cable is not connected, you cannot listen to the TV program through the theater system.

### ■ Connecting this unit to a DVD recorder (DIGA) and AV amp

When using a “VIERA Link” audio-video amplifier and a compatible DVD recorder (DIGA) use a daisy chain connection as shown below.

\* No optical cable is necessary for the equipment that has “HDAVI control 5” and is connected with an HDMI cable (HDMI 1 only).

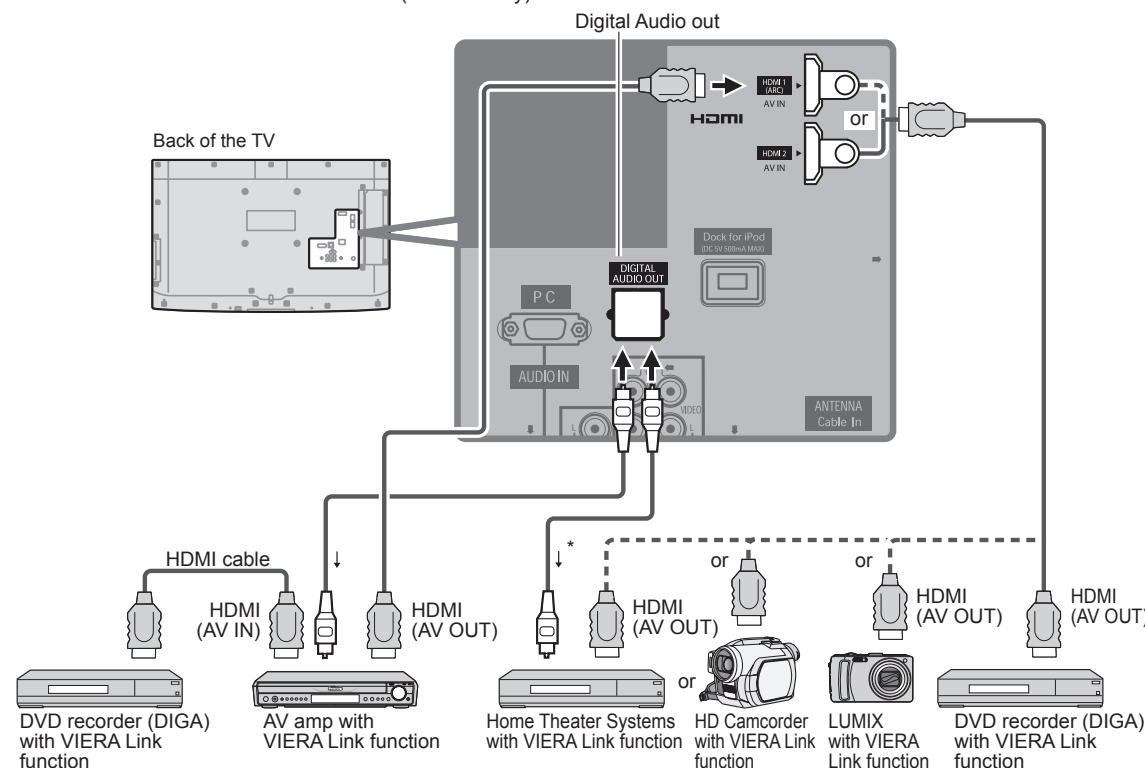

- One AV amp and one DVD recorder (DIGA) can be operated with this unit.
- Be sure to connect the AV amp between this unit and the DVD recorder (DIGA).

### ■ Setting of this unit after connection

After making connections as shown above, set “VIERA Link” (under “VIERA Link settings”) to “On” using the Setup menu. (p. 25, 32-33).

### Note

- Individual HDMI equipment may require additional menu settings specific to each model. Please refer to their respective operating instruction manuals.
- When audio from other equipment connected to this unit via HDMI is output using “DIGITAL AUDIO OUT” of this unit, the system switches to 2CH audio. (When connecting to an AV amp via HDMI, you can enjoy higher sound quality.)
- For details about HDMI cables for connecting a Panasonic HD camcorder, read the manual for the equipment.



# VIERA Link™ “HDAVI Control™”\*

(Continued)

**1 Display the menu**

**2 Select “Setup”**

**3 Select “VIERA Link settings”**

**4 Select “VIERA Link”**

**5 Select “On”**  
(default is On)

**6 Select settings**

**7 Set**

**■ Press to exit from a menu screen**  
EXIT

**■ Press to return to the previous screen**  
RETURN

**Menu Setup 2/2**

- VIERA Link settings
- ECO / energy saving
- Advanced setup
- First time setup
- About
- Reset to defaults

**Menu Setup 2/2**

- VIERA Link settings
- ECO / energy saving
- Advanced setup
- time setup

**Menu VIERA Link settings**

- VIERA Link On
- Power on link No
- Power off link Yes
- Energy saving mode Quick start
- Unselected device energy save No (stay on)
- Default speakers TV

**Menu VIERA Link settings**

- VIERA Link On
- Power on link No
- Power off link Yes
- Energy saving mode Quick start
- Unselected device energy save No (stay on)
- Default speakers Theater

**Automatic Input Switching**

**Power on link**

**Power off link**

**Energy saving mode**  
(for “HDAVI Control 4 or later” (with Quick Start mode))

**Unselected device energy save**  
(for “HDAVI Control 2 or later”)

**Default speakers**

**One-touch theater playback**

**Provides setting information**  
(for “HDAVI Control 3 or later”)

**Automatic lip-sync function**  
(for “HDAVI Control 3 or later”)

When using a Blu-ray Disc player, DVD player/recorder or Home theater system, the TV will automatically change to the appropriate input, when playback begins on one of those devices.

- For a Home theater system, the speakers automatically switch to the theater system.

When “Yes” is selected (p. 29), the TV is turned on automatically and switches to the appropriate HDMI input whenever a VIERA Link compatible equipment is initially turned on and the Play mode is selected.

When “Yes” is selected (p. 29) and the TV is turned off, all connected VIERA Link compatible equipment is also automatically turned off.

- A Panasonic DVD Recorder will not turn off if it is still in Rec mode.

**Caution:** The TV remains on even if the VIERA Link compatible equipment is turned off.

- Condition

Power off link: Yes; Energy saving mode: Quick Start

The equipment has “HDAVI Control 4 or later (with Quick Start mode)” connected with an HDMI cable.

When TV is turned off, all connected VIERA Link compatible equipment is moved to ECO Standby mode\* automatically under above conditions.

\* Minimum power consumption of Standby condition for the equipment.

- Condition

Unselected device energy save: Yes

The equipment has “HDAVI Control 2 or later” (for available equipment only) connected with an HDMI cable.

[ Examples of timing for operation ]

- When the input is switched from the HDMI.
- When the “Speaker output” is changed from “Home theater” to “TV”.

The connected VIERA Link compatible equipment will be turned off automatically when not in use.

“TV” is the default setting. To set the Home theater system as Default speakers, change the Default speakers setting from “TV” to “Theater”. Sound will be output from the Home theater whenever the TV is powered on.

If the “ONE TOUCH PLAY” key is pressed on the remote control for a Panasonic Home theater system, the following sequence of operations is performed automatically:

- ① Home theater power switches On, and playback begins.
- ② TV power switches On, and the playback screen is displayed.
- ③ Audio is muted on the TV and switches to the theater system.

The following information about the TV settings can be transmitted to each piece of an equipment (Recorder/Home theater/Player) that has “HDAVI Control 3 or later” function connected to a TV with an HDMI cable.

Transmittable data	Recorder	Home theater	Player
① On Screen Display Language setting (English/Español/Français)	○	○	○
② Panel Aspect Ratio (16:9 fixed)	○	○	○
③ Closed caption information (Mode/CC type/Digital setting)	○	---	---
④ Channel information (Input signal/Channel list/Caption information)	○	---	---

**Note**

- There is a possibility that all the GUI language information might be set from the equipment that has an HDMI CEC function connected to the TV with an HDMI cable. Depending on the operating conditions or the specification for each piece of equipment, the setting may or may not be applied.
- For more details on the external equipment’s operation, please refer to the operating manuals for the equipment.

**[For Recorder]**

- You cannot operate other functions while transmitting the TV’s information above except the Power On/Off key operation. When you turn off this unit, the transmission will be interrupted (only when you are transmitting ④ Channel information).

Minimizes lip-sync delays between the picture and audio when you connect to a Panasonic theater system or Amplifier.

# VIERA Link™ “HDAVI Control™”

You can enjoy more convenient operation with the “HDAVI Control” function in the “VIERA Link” menu.

For more details on the “HDAVI Control” function, refer to p. 30

**1 Display the VIERA Link menu**

or

**2 Select the item**

**3 Select**

**4 Set**

■ Press to exit from a menu screen



■ Press to return to the previous screen



Speaker control

VIERA Link control only with the TV's remote control (for “HDAVI Control 2 or later”)

Back to TV

(Continued)

You can select the Home theater or TV speakers for audio output.

Control the theater speakers with the TV remote control. This function is available only when a Panasonic Amplifier or Player theater is connected.

■ **Home theater:** Adjustment for the equipment output.

Volume up / down →

Mute →

- The sound of the TV is muted.
- When the equipment is turned off, the TV speakers take over.
- Selecting “Home theater” turns the equipment on automatically if it is in Standby mode.

■ **TV:** The TV speakers are on.

① Select “Speaker output”

② Select “Home theater” or “TV”

① select  
② change

In the VIERA Link menu, you can select an HDMI connected equipment and access it quickly. Continue using your TV remote control to operate the equipment, pointing it at the TV.

① Select “VIERA Link control”

② Select the equipment you want to access (Recorder/Home theater/Player/Camcorder/LUMIX/Digital camera)

① select  
② change

- If there is more than one equipment item, a number after the name indicates the number of items. (e.g. Recorder 1/Recorder 2/Recorder 3...)
- The number of equipment items that can be connected is three for recorders, and a total of three for Home theater/Player/Camcorder/LUMIX Digital camera.

**Note**

- There is a limit to the number of HDMI connectors.
- ③ **Operate the equipment with the TV remote control, pointing it at the TV**
- To operate the equipment, read the manual of the equipment.

■ **Available TV remote control buttons**

Whether an operation is available differs depending on the connected equipment.

	Move the cursor/Select		Play
	Set/Access		Stop
	Return to previous menu		Reverse/Forward
	Display the functions menu on the equipment		Skip Reverse/Forward
	Available when the purpose of the keys is displayed on screen		Pause
	Exit		Closed caption
	Channel Up/Down		SAP (Select Audio Mode)
	0-9		Select digital subchannel

Returns the input selection of the device selected with the VIERA Link Control to the TV input.

Select “Back to TV”

① select  
② OK

# Lock

You can lock specified channels or shows to prevent children from watching objectionable content.

**1 Display the menu**

**2 Select "Lock"**

**3 Input your 4-digit password**

**4 Select the Lock mode**

**5 Select the item**

**6 Set**

Menu Password  
Enter password.  
.....

Menu Password  
Enter password.  
.....

Menu Lock  
Mode Off  
Channel Off  
Game Off  
Program Off  
Change password

Menu Lock  
Mode Custom  
Channel Off  
Game Off  
Program Off  
Change password

Menu Change password  
Enter new password.  
.....

Blocks access, with password protection, to channels, programs or inputs.

A 4-digit code must be entered to view a blocked program or change rating settings.

If it is your first time entering the password, enter the password twice in order to register it.

Off: Unlocks all the lock settings of "Channel", "Game" and "Program".  
All: Locks all the inputs regardless of the lock settings of "Channel", "Game" and "Program".  
Custom: Locks specified inputs of "Channel", "Game" and "Program".

• "Channel", "Game" and "Program" are not accessible unless "Custom" is selected in "Mode".

## Press to exit from a menu screen



### Caution

- Make a note of your password in case you forget it. (If you have forgotten your password, consult your local dealer.)

### Note

- When you select a locked channel, a message will be displayed that allows you to view the channel if you input your password.

**Channel lock**

Select up to 7 (1-7) channels to block. These channels will be blocked regardless of the program rating.

**1 Select "Mode" and set to "Custom"**

**2 Select a channel to lock**

To lock/unlock all channels:  
Select "Mode" and set to "All" or "Off".

All: Locks all channels  
Off: Unlocks all channels

Locks Channel 3, Channel 4, and external inputs.  
**Select "Game" in 5 and set to "On"**

**To set a rating level**  
"V-chip" technology enables restricted shows to lock according to TV ratings.

**1 Select "Mode" and set to "On"**

**2 Select the rating category you wish to follow**

**3 Select the rating to lock**

Example of "MPAA" (U.S. movie ratings)

NR	No rating
G	General Audience: All ages admitted
PG	Parental Guidance Suggested
PG-13	Parents Strongly Cautioned: Inappropriate for children under 13
R	Restricted: Under 17 requires accompanying parent or adult guardian
NC-17	No one 17 and under admitted
X	Adults only

• To get more information (p. 44)

**Program lock**

**Change password**

**To change the password**

**1** In 4, select "Change password" and press OK  
**2** Input the new 4-digit password twice

### Note

- This television is designed to support the "Downloadable U.S. Region Rating System" when available. (Available only in U.S.A.)
- The Off rating is independent of other ratings.
- When placing a lock on a specific-age-based-rating level, the Off rating and any other more restrictive ratings will also be blocked.

# Editing and Setting Channels

The current channel settings can be changed according to your needs and reception conditions.

- 1 Display the menu**  
Press the **MENU** button.
- 2 Select "Setup"**  
Use the directional pad to move the cursor to **Setup** and press **OK**.
- 3 Select "ANT/Cable setup"**  
Use the directional pad to move the cursor to **ANT/Cable setup** and press **OK**.
- 4 Select the function**  
Use the directional pad to move the cursor to the desired function (e.g., **Auto program**) and press **OK**.
- 5 Set**  
Use the directional pad to move the cursor to the desired option and press **OK**.

■ Press to exit from a menu screen  
EXIT X

■ **To reset the settings of the Setup menu**  
 ① Select "Reset to defaults" in the Setup menu (⊕) and press OK  
 ② Input your 4-digit password with the number buttons  
 ③ Select "YES" on the confirmation screen and press OK

**Auto program**  
Set automatically

**Manual program**  
Set manually

**Signal meter**  
Check signal strength

Automatically searches and adds available channels to the memory.

① **Select "ANT in"**  
 → Select "Cable" or "Antenna" or select "Not used" (p. 13).

② **Select "Auto program"**

③ **Select a scanning mode (p. 13)**

Settings are made automatically after the scanning is completed, select "Apply". (see below ⑤).  
 ● After the scanning is completed, select "Apply".  
 ● All previously saved channels are erased.

Use this procedure when changing the channel setup or changing the channel display. Also, use this to add or skip channels from the channel list manually. You can select a channel tuning mode (Digital only/Analog only) in "Channel surf mode" (p. 29)

① **Select "Edit"**

② **Select the item to edit**

③ **Edit**

**Caption**  
 Select or edit the station identifier. (maximum 7 characters available)

**Favorite**  
 Registers channels to the Favorite List

**Add**  
 Adds or skips channels

③ **Edit**

**Caption**  
 Edit CH caption  
 Channel: 80-101  
 Caption: @DA

**Set favorite**  
 Select the number

④ **Move the cursor to a channel number**

⑤ **Select "Apply"**

**To cancel the Edit**

Changes will be lost. Continue?  
 Yes No

Check the signal strength if interference is found or freezing occurs on a digital image.

① **Signal strength**

Signal intensity

● If the signal is weak, check the antenna. If no problem is found, consult your local dealer.

**Note**  
 ● Not available if "Cable" is selected in "ANT in" (see above).  
 ● Available only for digital antenna channels.

● If "Lock" (p. 36) is activated and "ANT/Cable setup" is selected, "Enter password." will be displayed.



# Closed Caption

**1 Display the menu**



**2 Select "Closed caption"**

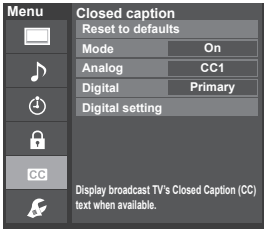



■ **Press to exit from a menu screen**

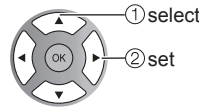
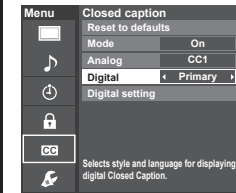

The television includes a built-in decoder that is capable of providing a text display of the audio. The program being viewed must be transmitting the Closed caption (CC) information. (p. 45)

## ■ Select the item and set



**Mode** On: To display Closed captions.  
CC on mute: To display Closed captions when the audio is muted. (When not using, select "Off").

**Analog** (Choose the Closed caption service of Analog broadcasting.)  
CC1-4: Information related to pictures (Appears at the bottom of the screen)

T1-4: Textual information (Appears over the entire screen)

**Digital** (The Digital Closed caption menu lets you configure the way you choose to view the digital captioning.)

Select the setting.  
● "Primary", "Second.", "Service 3", "Service 4", "Service 5", "Service 6"

- The settings in "Analog" or "Digital" depend on the broadcaster.

## ■ To make more in-depth display settings in digital programs

- 1 Select "Digital setting" and press OK
- 2 Select the item and set

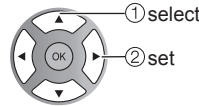
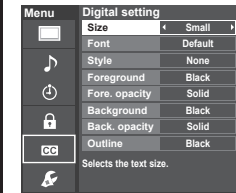

**Size** Text size

**Font** Text font

**Style** Text style (Raised, Depressed, etc.)

**Foreground** Color of text

**Fore. opacity** Opacity of text

**Background** Color of text box

**Back. opacity** Opacity of text box

**Outline** Outline color of text (Identify the setting options on the screen.)

## ■ To reset the settings

- 1 Select "Reset to defaults". Confirmation screen is displayed.
- 2 Select "Yes" and press OK.

**Closed caption**  
**Display**  
**Closed**  
**caption**

# Input Labels

**1 Display the menu**

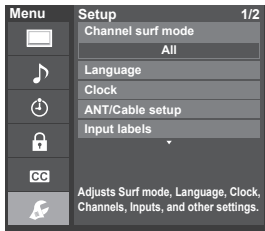

**2 Select "Setup"**

**3 Select "Input labels"**



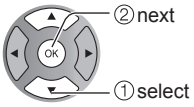
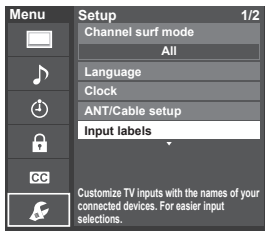

■ **Press to exit from a menu screen**

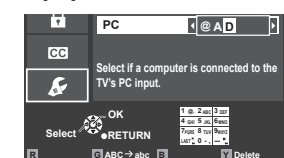
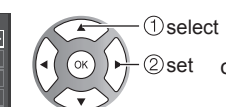
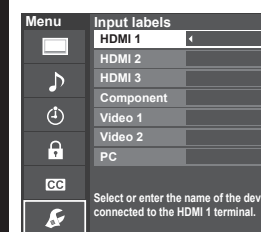

Devices connected to external input terminals can be labeled for easier identification during the input selection. (In selecting the input mode from p. 24 2)

## ■ Select the terminal and label of the external equipment



Follow the instructions on screen to complete the following operations.

- Terminals: HDMI 1-3/Component/Video 1-2/PC
- Label: [BLANK] Not used/Blu-ray/DVD/DVD REC/HOME THTR/GAME/COMPUTER/VCR/CABLE/SATELLITE/DVR/CAMERA/MONITOR/AUX/RECEIVER/MEDIA CTR/MEDIA EXT/OTHER

- For the PC terminal, only "Not used" is available.
- If "Not used" is selected, the INPUT button press will skip its input.
- Each selected label will be displayed on the "Input select" screen. (p. 24)

**Input labels**  
**Display**  
**labels of**  
**connected**  
**devices**

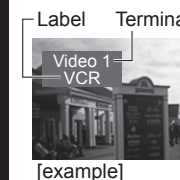

# Using Timer

The TV can automatically turn On/Off at the designated date and time.

- The Clock must be set before On time/Off time settings. (p. 14)
- The "Sleep" timer and "On / Off timer" will not work if the "Auto power on" (p. 29) is set.

- ### 1 Display the menu
- ### 2 Select "Timer"

② next  
① select
- ### 3 Select the timer to set

① select  
② next

**Sleep** Turns Off automatically  
**Timer 1** Turns On/Off automatically (5 timers can be set.)  
**Timer 5**
- ### 4 Set the Timer

■ **To set "Sleep" (Off Timer)**  
Set to shut the unit off after a pre-selected amount of time.

0/15/30/60/90 (minutes)

set

■ **To set "Timer 1-5" (On/Off Timer)**  
Select the item and set

① select  
② set

or

1 2 3  
4 5 6  
7 8 9  
0

**Timer set** Timer setting (Off/On)  
**Inputs** Select the inputs  
**Channel** Select the channel  
**Day** Select the day

SUN/MON/TUE/WED/THU/FRI/SAT  
(displays the nearest future date)  
MON-FRI/SAT-SUN/DAILY/Every SUN/Every MON/  
Every TUE/Every WED/Every THU/Every FRI/ Every SAT

**On time** The time to turn On  
**Off time** The time to turn Off

■ **Press to exit from a menu screen**  
EXIT

■ **Press to return to the previous screen**  
RETURN

**Note**

  - The TV automatically turns Off after 90 minutes when turned On by the Timer. This operation will be cancelled if the Off time is selected or if a key is pressed.

# Recommended AV Connections

These diagrams show our recommendations on how to connect the TV unit to your various equipment.

For other connections, consult the instructions for each piece of equipment and its specifications.

For additional assistance, please visit our website at: [www.panasonic.com](http://www.panasonic.com)

[www.panasonic.ca](http://www.panasonic.ca)

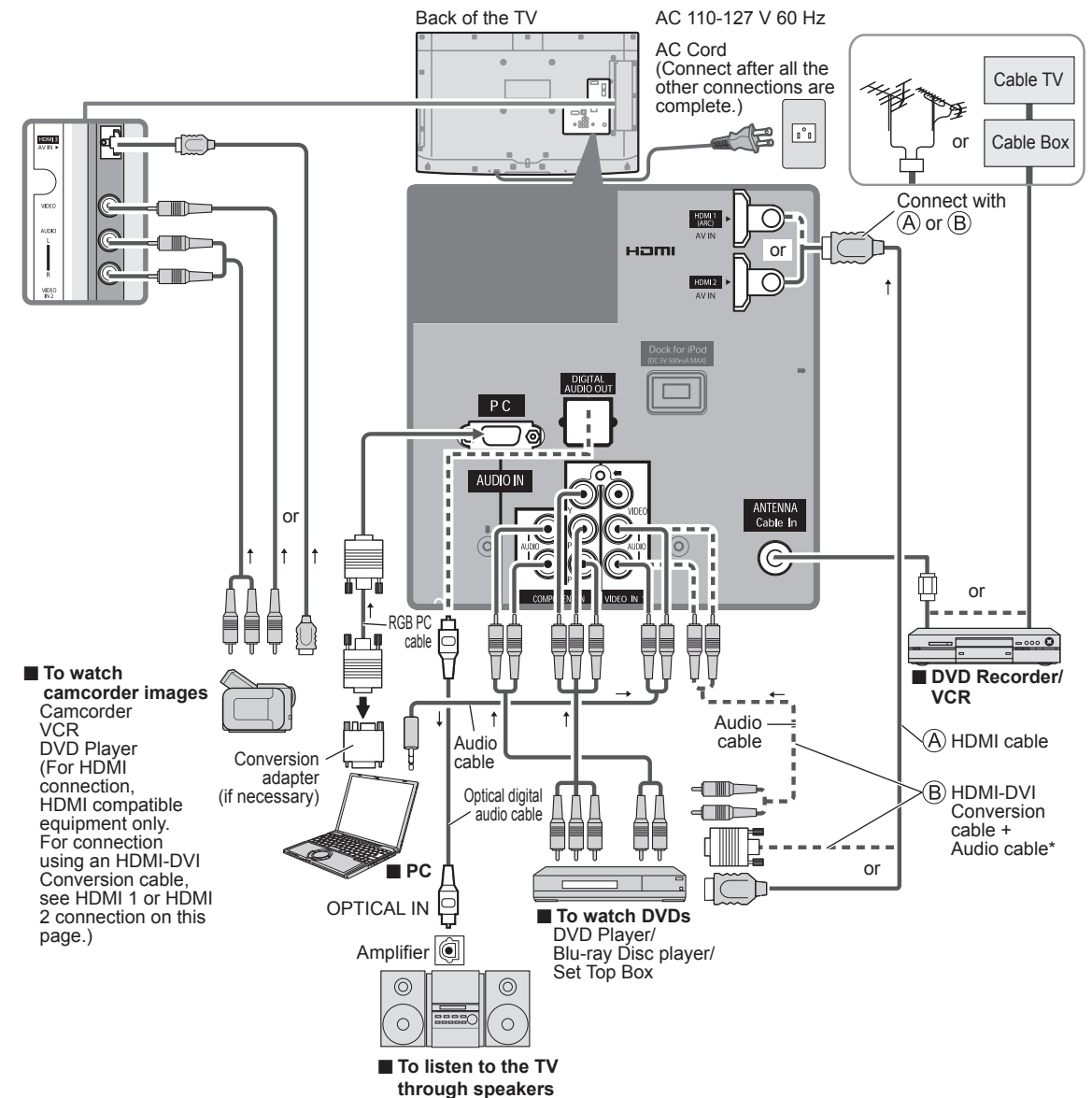

\* Please see p. 28 for the setup when using an external analog audio cable with an HDMI to DVI cable.

# Ratings List for Lock

“V-chip” technology enables you to lock channels or shows according to standard ratings set by the entertainment industry. (p. 37)

## U.S. MOVIE RATINGS (MPAA)

NR	NO RATING (NOT RATED) AND NA (NOT APPLICABLE) PROGRAMS. Movie which has not been rated or where rating does not apply.
G	GENERAL AUDIENCES. All ages admitted.
PG	PARENTAL GUIDANCE SUGGESTED. Some material may not be suitable for children.
PG-13	PARENTS STRONGLY CAUTIONED. Some material may be inappropriate for children under 13.
R	RESTRICTED. Under 17 requires accompanying parent or adult guardian.
NC-17	NO ONE 17 AND UNDER ADMITTED.
X	ADULTS ONLY.

## U.S. TV PROGRAMS RATINGS (U. S. TV)

Age-based Group	Age-based Ratings	Possible Content Selections	Description
NR (Not Rated)	TV-NR	<ul style="list-style-type: none"> <li>Viewable</li> <li>Blocked</li> </ul>	Not Rated.
Youth	TV-Y	<ul style="list-style-type: none"> <li>Viewable</li> <li>Blocked</li> </ul>	All children. The themes and elements in this program are specifically designed for a very young audience, including children from ages 2-6.
	TV-Y7	<ul style="list-style-type: none"> <li>FV Blocked</li> <li>Viewable</li> <li>Blocked</li> </ul>	Directed to older children. Themes and elements in this program may include mild physical or comedic violence, or may frighten children under the age of 7.
Guidance	TV-G	<ul style="list-style-type: none"> <li>Viewable</li> <li>Blocked</li> </ul>	General audience. It contains little or no violence, no strong language, and little or no sexual dialogue or situations.
	TV-PG	<ul style="list-style-type: none"> <li>D,L,S,V (all selected)</li> <li>Any combination of D, L, S, V</li> </ul>	Parental guidance suggested. The program may contain infrequent coarse language, limited violence, some suggestive sexual dialogue and situations.
	TV-14	<ul style="list-style-type: none"> <li>D,L,S,V (all selected)</li> <li>Any combination of D, L, S, V</li> </ul>	Parents strongly cautioned. This program may contain sophisticated themes, sexual content, strong language and more intense violence.
	TV-MA	<ul style="list-style-type: none"> <li>L,S,V (all selected)</li> <li>Any combination of L, S, V</li> </ul>	Mature audiences only. This program may contain mature themes, profane language, graphic violence, and explicit sexual content.

FV: Fantasy/Cartoon Violence. V: Violence S: Sex L: Offensive Language D: Dialogue with sexual content.

## CANADIAN ENGLISH RATINGS (C. E. L. R.)

E	Exempt - Exempt programming includes: news, sports, documentaries and other information programming, talk shows, music videos, and variety programming.
C	Programming intended for children under age 8. No offensive language, nudity or sexual content.
C8+	Programming generally considered acceptable for children 8 years and over. No profanity, nudity or sexual content.
G	General programming, suitable for all audiences.
PG	Parental Guidance suggested. Some material may not be suitable for children.
14+	Programming contains themes or content which may not be suitable for viewers under the age of 14. Parents are strongly cautioned to exercise discretion in permitting viewing by pre-teens and early teens.
18+	18+ years old. Programming restricted to adults. Contains constant violence or scenes of extreme violence.

## CANADIAN FRENCH RATINGS (C. F. L. R.)

E	Exempt - Exempt programming.
G	General - Programming intended for audience of all ages. Contains no violence, or the violence content is minimal or is depicted appropriately.
8 ans+	8+ General - Not recommended for young children. Programming intended for a broad audience but contains light or occasional violence. Adult supervision recommended.
13 ans+	Programming may not be suitable for children under the age of 13 - Contains either a few violent scenes or one or more sufficiently violent scenes to affect them. Adult supervision strongly suggested.
16 ans+	Programming may not be suitable for children under the age of 16 - Contains frequent scenes of violence or intense violence.
18 ans+	Programming restricted to adults. Contains constant violence or scenes of extreme violence.

### Caution

- The V-Chip system that is used in this set is capable of blocking “NR” programs (non rated, not applicable and none) as per FCC Rules Section 15.120(e)(2). If the option of blocking “NR” programs is chosen “unexpected and possibly confusing results may occur, and you may not receive emergency bulletins or any of the following types of programming:”
  - Emergency Bulletins (Such as EAS messages, weather warnings and others)
  - Locally originated programming • News • Political • Public Service Announcements • Religious • Sports • Weather

# Technical Information

## Closed caption (CC)

- For viewing the CC of digital broadcasting, set the aspect to FULL (If viewing with H-FILL, JUST, ZOOM or 4:3; characters might be cut off).
- The CC can be displayed on the TV if the receiver (such as a set-top box or satellite receiver) has the CC set On using the Component or HDMI connection to the TV.
- If the CC is set to On on both the receiver and TV when the signal is 480i (except for the HDMI connection), the CC may overlap on the TV.
- If a digital program is being output in analog format, the CC data will also be output in analog format.
- If the recorder or output monitor is connected to the TV, the CC needs to be set up on the recorder or output monitor.

## Aspect Ratio (FORMAT)

Press the FORMAT button to cycle through the aspect modes. This lets you choose the aspect depending on the format of the received signal and your preference. (p. 16)  
(e.g.: in case of 4:3 image)

### FULL

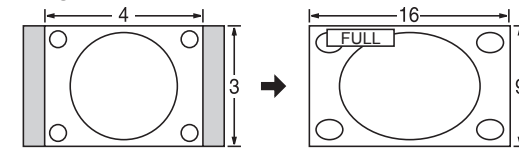

Enlarges the 4:3 image horizontally to the screen's side edges. (Recommended for anamorphic picture)

### JUST

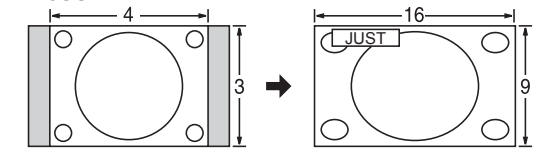

Stretches to justify the 4:3 image to the four corners of the screen. (Recommended for normal TV broadcast)

### H-FILL

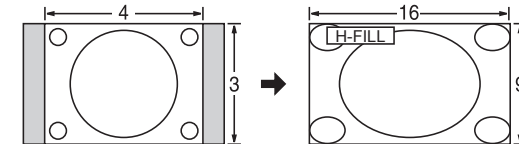

Enlarges the 4:3 image horizontally to the screen's side edges. The side edges of the image are cut off.

### 4:3

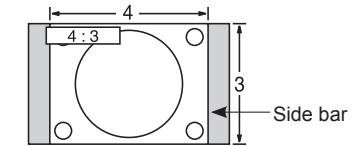

Standard (Note that “Image retention” of the side bar may occur from displaying it for a long time.)

### Note

- 480i (4:3), 480i (16:9), 480p (4:3), 480p (16:9): FULL, JUST, 4:3 or ZOOM
- 1080p / 1080i / 720p: FULL, H-FILL, JUST, 4:3 or ZOOM

### ZOOM

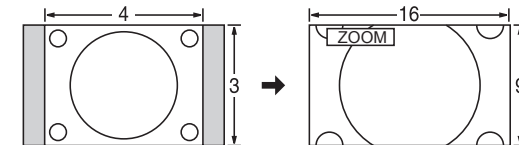

Enlarges the 4:3 image to the entire screen. (Recommended for Letter Box)

### Zoom adjustments

Vertical image position and size can be adjusted in “ZOOM”.

① Select “Zoom adjustments” on the “Picture” menu. (p. 28)

② V-position: Vertical position adjustment

③ V-size: Vertical size adjustment

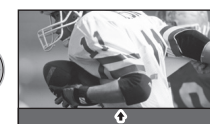

- To reset the aspect ratio → (OK)

# Technical Information (Continued)

## Data format for SD Card browsing

- Photo: Still images recorded with digital still cameras compatible with JPEG files of DCF\* and EXIF\*\* standards
- Data format: Baseline JPEG (Sub-sampling: 4:4:4, 4:2:2 or 4:2:0)
- Max. number of files: 9,999
- Image resolution: 160 x 120 to 20,000,000
- \* DCF (Design rule for camera file system): A Japan Electronics and Information Technology Industries Association's standard
- \*\* EXIF (Exchangeable Image File Format)

### Caution

- A JPEG image modified with a PC may not be displayed.
- Partly degraded files might be displayed at a reduced resolution.

### Note

- Folder structure viewed in PC

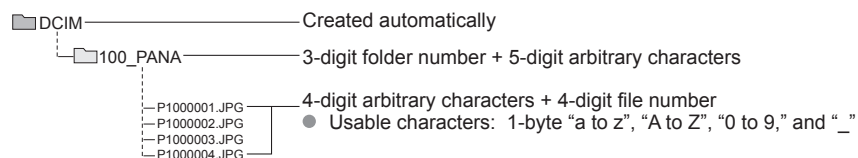

- The folder and file names may be different depending on the digital camera used.
- For the suitable SD Memory Cards, please confirm the latest information on the following website. <http://panasonic.jp/support/global/cs> (This site is in English only)

## Cautions in handling SD Card

- Use an SD Card which meets SD standards. If not, it may cause the TV to malfunction.
- Do not remove the card while the unit is accessing data (this can damage card or unit).
- Do not touch the terminals on the back of the card.
- Do not subject the card to high pressure or impact.
- Insert the card in the correct direction (otherwise, card or unit may be damaged).
- Electrical interference, static electricity or erroneous operation may damage the data or card.
- Back up the recorded data at regular intervals in case of deteriorated or damaged data or erratic operation of the unit. (Panasonic is not liable for any deterioration or damage of recorded data.)

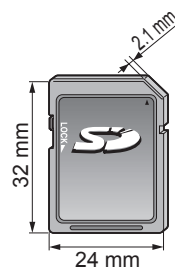

## SD Card warning messages

Message	Meaning
SD card slot is empty.	● The card is not inserted.
No photos	● The card has no data or this type of data is not supported.
Cannot read file	● The file is broken or unreadable. ● The TV does not support the format.

## VIERA Link™ "HDAVI Control™"

HDMI connections to some Panasonic equipment allow you to interface automatically. (p. 30)

- This function may not work normally depending on the equipment condition.
- The equipment can be operated by other remote controls with this function on even if TV is in Standby mode.
- Image or sound may not be available for the first few seconds when the playback starts.
- Image or sound may not be available for the first few seconds when Input mode is switched.
- Volume function will be displayed when adjusting the volume of the equipment.
- If you connect equipment that has "HDAVI Control 2 or later" function to the TV with an HDMI cable, the sound from the DIGITAL AUDIO OUT terminal can be output as multi-channel surround.
- "HDAVI Control 5" is the newest standard (current as of December, 2009) for the HDAVI Control compatible equipment. This standard is compatible with the conventional HDAVI equipment.

## HDMI connection

HDMI (high-definition multimedia interface) allows you to enjoy high-definition digital images and high-quality sound by connecting the TV unit and the devices.

HDMI-compatible equipment (\*1) with an HDMI or DVI output terminal, such as a set-top box or a DVD player, can be connected to the HDMI connector using an HDMI compliant (fully wired) cable.

- HDMI is the world's first complete digital consumer AV interface complying with a non-compression standard.
  - If the external equipment has only a DVI output, connect to the HDMI terminal via a DVI to HDMI adapter cable (\*2).
  - When the DVI to HDMI adapter cable is used, connect the audio cable to the audio input terminal.
  - Audio settings can be made on the "HDMI 1 in", "HDMI 2 in" or "HDMI 3 in" menu screen. (p. 28)  
Applicable audio signal sampling frequencies (L.PCM): 48 kHz, 44.1 kHz, 32 kHz
- (\*1): The HDMI logo is displayed on an HDMI-compliant device.  
(\*2): Enquire at your local digital equipment retailer shop.

### Caution

- Use with a PC is not assumed.
- All signals are reformatted before being displayed on the screen.
- If the connected device has an aspect adjustment function, set the aspect ratio to "16:9".
- These HDMI connectors are "type A".
- These HDMI connectors are compatible with HDCP (High-Bandwidth Digital Content Protection) copyright protection.
- A device having no digital output terminal may be connected to the input terminal of either "COMPONENT" or "VIDEO" to receive analog signals.
- The HDMI input terminal can be used with only the following image signals: 480i, 480p, 720p, 1080i, 1080p. Match the output setting of the digital device.
- For details of the applicable HDMI signals, see p. 48.

## DIGITAL AUDIO OUT terminals

You can enjoy your Home theater by connecting a Dolby Digital (5.1 channel) decoder and "Multi Channel" amplifier to the DIGITAL AUDIO OUT terminals.

### Caution

- Depending on your DVD player and DVD-Audio software the copyright protection function may operate and disable optical output.
- When an ATSC channel is selected, the output from the DIGITAL AUDIO OUT jack will be Dolby Digital. When an NTSC channel is selected, the output will be PCM.

## Picture mode

- Vivid: Provides enhanced picture contrast and sharpness for viewing in a well-lit room.
- Standard: Recommended for normal viewing conditions with subdued room lighting.
- Cinema: For watching movies in a darkened room. It provides a soft, film-like picture.
- Game: For playing video games. This mode will be set automatically if "GAME" is selected from the Input label setting (p. 41)
- Custom (Photo): Customizes each item according to your taste. Photo is displayed in JPEG menu.

### Note

- Picture mode will be automatically set to "Standard" if you change the Input label from "GAME" to other labels.
- Picture mode will be automatically set to "Game" if you change from an Input label other than "GAME" to "GAME" label.



# Technical Information (Continued)

## H size

- Aspect Ratio: 4:3

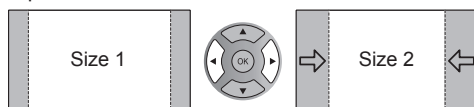

- The width will be decreased on both sides to reduce noise.

- Aspect Ratio: FULL/JUST(H-FILL/ZOOM)

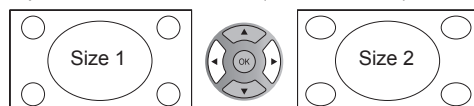

- The width will be increased on both sides to reduce noise.

See page 28 for more information

## Input signal that can be displayed

\* Mark: Applicable input signal for Component (Y, PB, PR), HDMI and PC

	horizontal frequency (kHz)	vertical frequency (Hz)	COMPONENT	HDMI	PC
525 (480) / 60i	15.73	59.94	*	*	
525 (480) / 60p	31.47	59.94	*	*	
750 (720) / 60p	45.00	59.94	*	*	
1,125 (1,080) / 60i	33.75	59.94	*	*	
1,125 (1,080) / 60p	67.43	59.94		*	
1,125 (1,080) / 60p	67.50	60.00		*	
1,125 (1,080) / 24p	26.97	23.98		*	
1,125 (1,080) / 24p	27.00	24.00		*	
640 × 400 @70	31.47	70.08			*
640 × 480 @60	31.47	59.94			*
Macintosh13" (640 × 480)	35.00	66.67			*
640 × 480 @75	37.50	75.00			*
852 × 480 @60	31.44	59.89			*
800 × 600 @60	37.88	60.32			*
800 × 600 @75	46.88	75.00			*
800 × 600 @85	53.67	85.08			*
Macintosh16" (832 × 624)	49.73	74.55			*
1,024 × 768 @60	48.36	60.00			*
1,024 × 768 @70	56.48	70.07			*
1,024 × 768 @75	60.02	75.03			*
1,024 × 768 @85	68.68	85.00			*
Macintosh 21" (1,152 × 870)	68.68	75.06			*
1,280 × 768 @60	47.78	59.87			*
1,280 × 1,024 @60	63.98	60.02			*
1,366 × 768 @60	48.39	60.04			*

### Note

- Signals other than above may not be displayed properly.
- The above signals are reformatted for optimal viewing on your display.

## PC Input Terminals Connection

- Computer signals which can be input are those with a horizontal scanning frequency of 15 to 110 kHz and vertical scanning frequency of 48 to 120 Hz. (However, the image will not be displayed properly if the signals exceed 1,200 lines.)
- Some PC models cannot be connected to the set.
- There is no need to use an adapter for computers with IBM PC/AT compatible D-sub 15P terminal.
- The maximum resolution: 1,280 × 1,024
- If the display resolution exceeds these maximums, it may not be possible to show fine detail with sufficient clarity.
- Signal Names for D-sub 15P Connector

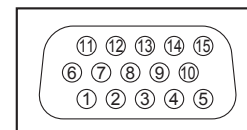

Pin Layout for PC Input Terminal

Pin No.	Signal Name	Pin No.	Signal Name	Pin No.	Signal Name
①	R	⑥	GND (Ground)	⑪	NC (not connected)
②	G	⑦	GND (Ground)	⑫	NC
③	B	⑧	GND (Ground)	⑬	HD/SYNC
④	NC (not connected)	⑨	NC (not connected)	⑭	VD
⑤	GND (Ground)	⑩	GND (Ground)	⑮	NC

# Care and Cleaning

First, unplug the Power cord plug from the wall outlet.

## Display panel

The front of the display panel has been specially treated. Wipe the panel surface gently using only a cleaning cloth or a soft, lintfree cloth.

- If the surface is particularly dirty, soak a soft, lint-free cloth in diluted mild liquid dish soap (1 part mild liquid dish soap diluted by 100 times the amount of water) and then wring the cloth to remove excess liquid. Use this cloth to wipe the surface of the display panel, then wipe it evenly with a dry cloth of the same type until the surface is dry.
- Do not scratch or hit the surface of the panel with fingernails or other hard objects. Furthermore, avoid contact with volatile substances such as insect sprays, solvents, and thinner; otherwise, the quality of the surface may be adversely affected.

## Cabinet

If the cabinet becomes dirty, wipe it with a soft, dry cloth.

- If the cabinet is particularly dirty, soak the cloth in a weak mild liquid dish soap and then wring the cloth dry. Use this cloth to wipe the cabinet and then wipe it dry with a dry cloth.
- Do not allow any mild liquid dish soap to come into direct contact with the surface of the LCD TV. If water droplets get inside the unit, operating problems may result.
- Avoid contact with volatile substances such as insect sprays, solvents, and thinner; otherwise, the quality of the cabinet surface may be adversely affected or the coating may peel off. Furthermore, do not leave it for long periods in contact with articles made from rubber or PVC.

## Pedestal

- Cleaning

Wipe the surfaces with a soft, dry cloth. If the unit is particularly dirty, clean it using a cloth soaked with water to which a small amount of mild liquid dish soap has been added and then wipe with a dry cloth.

Do not use products such as solvents, thinner, or household wax for cleaning, as they can damage the surface coating. (If using a chemically-treated cloth, follow the instructions supplied with the cloth.)

- Do not attach sticky tape or labels, as they can make the surface of the pedestal dirty. Do not allow long-term contact with rubber, vinyl products, or the like. (Doing so will cause deterioration.)

## Power cord plug

Wipe the plug with a dry cloth at regular intervals. (Moisture and dust can lead to fire or electrical shock.)

# FAQ

Before requesting service or assistance, please follow these simple guides to resolve the problem. If the problem still persists, please contact your local Panasonic dealer or Panasonic Service Center for assistance. For details (p. 54, 55)  
For additional assistance, please contact us via the website at:  
www.panasonic.com/contactinfo  
www.panasonic.ca

## White spots or shadow images (noise)

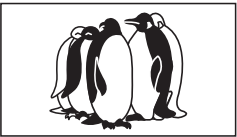

- Check the position, direction, and connection of the antenna.

## Interference or frozen digital channels (intermittent sound)

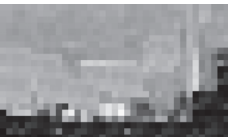

- Change the direction of antenna for digital channels.
- Check "Signal meter" (p. 39). If the signal is weak, check the antenna and consult your local dealer.

## The LCD panel moves slightly when it is pushed with a finger. A clattering sound might be heard

This is not a malfunction.

- There is some looseness around the panel to prevent damage to the panel.

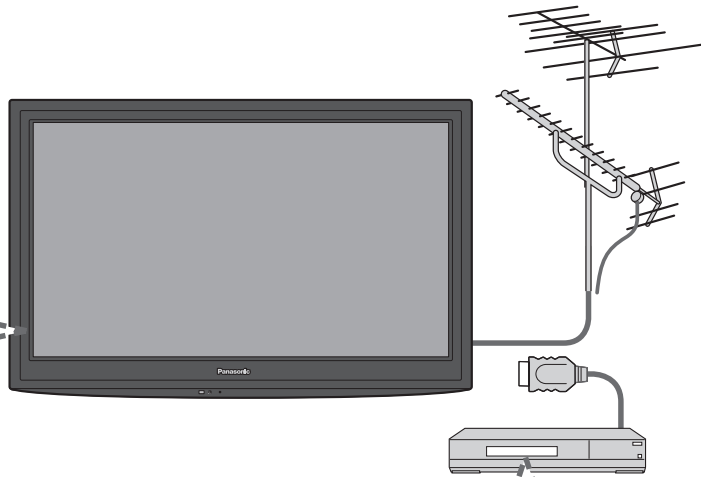

## Pictures from external equipment are distorted when the unit is connected via HDMI

- Is the HDMI cable connected properly? (p. 31, 43)
- Turn Off the TV unit and equipment, then turn them On again.
- Check an input signal from the equipment. (p. 48)
- Use equipment compliant with EIA/CEA-861/861B.

## When the channel is changed on an STB that is connected with HDMI, "HDMI" may be displayed on the top left of the screen

- This is not a malfunction.

## Recording does not start immediately

- Check the settings of the recorder. For details, read the manual of the recorder.

## The remote control does not work

- Are the batteries installed correctly? (p. 7)
- Are the batteries new?



If there is a problem with your TV, please refer to the table below to determine the symptoms, then carry out the suggested check. If this does not solve the problem, please contact your local Panasonic dealer, quoting the model number and serial number (both found on the rear of the TV).

	Problem	Actions
Screen	Some spots remain bright or dark	<ul style="list-style-type: none"> <li>● The LCD panel is made up of a few million pixels and is produced with advanced technology through an intricate process. Sometimes a few pixels may be bright or dark. These pixels do not indicate a defective panel and will have no impact on the performance of the TV.</li> </ul>
	Chaotic image, noisy	<ul style="list-style-type: none"> <li>● Check nearby electrical products. (car or motorcycle ignition systems, fluorescent lamp, etc.)</li> </ul>
	No image is displayed on screen	<ul style="list-style-type: none"> <li>● Check Picture menu (p. 28)</li> <li>● Check the cable connections.</li> <li>● Check that the correct input has been selected.</li> </ul>
	Only spots are displayed instead of images	<ul style="list-style-type: none"> <li>● Check the channel settings. (p. 38)</li> <li>● Check the antenna cables.</li> </ul>
	Neither image nor sound is produced	<ul style="list-style-type: none"> <li>● Is the power cord plugged into the outlet?</li> <li>● Is the TV unit turned On?</li> <li>● Check Picture menu (p. 28) and volume.</li> <li>● Check the AV cable connections. (p. 9-10)</li> <li>● Check that the correct input has been selected. (p. 24)</li> </ul>
	Black Box appears	<ul style="list-style-type: none"> <li>● Change settings of Closed caption (CC). (p. 40)</li> </ul>
Sound	No sound is produced	<ul style="list-style-type: none"> <li>● Are the speakers' cables connected correctly? (p. 43)</li> <li>● Is "Sound Mute" active? (p. 11)</li> <li>● Is the volume set to the minimum?</li> <li>● Is "TV speakers" set to "Off"? (p. 28)</li> <li>● Change "SAP" settings. (p. 15)</li> <li>● Check "HDMI 1 in", "HDMI 2 in" or "HDMI 3 in" settings. (p. 28)</li> </ul>
	Sound is unusual	<ul style="list-style-type: none"> <li>● Set "SAP" setting to "Stereo" or "Mono".</li> <li>● Check the HDMI device connected to the unit.</li> <li>● Set the audio setting of the HDMI device to "Linear PCM".</li> <li>● If digital sound connection has a problem, select analog sound connection.</li> </ul>
	Unknown sound heard 1- Sounds from TV cabinet 2- Tick/Click sound 3- Buzzing sound	<ol style="list-style-type: none"> <li>1- Changes in the temperature and humidity of the room may cause the TV's cabinet to expand or contract and produce metallic sounds. This is not a sign of faulty operation or a malfunction.</li> <li>2- When the TV is powered on, an electrical component in the TV activates producing a tick/click sound. This is not a sign of faulty operation or a malfunction.</li> <li>3- Electrical circuits are active while the TV set is on. This is not a sign of faulty operation or a malfunction.</li> </ol>
Other	The main unit is hot.	<ul style="list-style-type: none"> <li>● The main unit radiates heat and some of the parts may become hot. This is not a problem for performance or quality. Set up in a location with good ventilation. Do not cover the ventilation holes of the TV with a tablecloth, etc., and do not place on top of other equipment.</li> </ul>

# Specifications

	TC-L37D2	TC-L42D2	
<b>Power Source</b>	AC 110-127 V, 60 Hz		
<b>Power Consumption</b>	<b>Rated Power Consumption</b>	130 W	137 W
	<b>On mode Average Power Consumption*</b>	73 W	78 W
	<b>Standby condition</b>	0.3 W	0.3 W
<b>Display panel</b>	<b>Aspect Ratio</b>	16:9	
	<b>Visible screen size</b>	37" class (37.0 inches measured diagonally)    42" class (42.0 inches measured diagonally)	
	<b>(W × H × Diagonal)</b>	32.2" × 18.1" × 37.0" (819 mm × 460 mm × 940 mm)    36.6" × 20.6" × 42.0" (930 mm × 523 mm × 1,067 mm)	
	<b>(No. of pixels)</b>	2,073,600 (1,920 (W) × 1,080(H))    [5,760 × 1,080 dots]	
<b>Sound</b>	<b>Speaker</b>	1-way 2 speakers slim under SP System	
	<b>Audio Output</b>	20 W [10 W + 10 W] (10 % THD)	
<b>PC signals</b>	VGA, SVGA, XGA, WXGA, SXGA Horizontal scanning frequency 31 - 69 kHz Vertical scanning frequency 59 - 86 Hz		
<b>Channel Capability-ATSC/NTSC (Digital/Analog)</b>	VHF/ UHF: 2 - 69, CATV: 1 - 135		
<b>Operating Conditions</b>	Temperature: 32 °F – 95 °F (0 °C – 35 °C) Humidity: 20 % – 80 % RH (non-condensing)		
<b>Connection Terminals</b>	<b>VIDEO IN 1-2</b>	VIDEO: RCA PIN Type × 1 1.0 V [p-p] (75 Ω) AUDIO L - R: RCA PIN Type × 2 0.5 V [rms]	
	<b>COMPONENT IN</b>	Y: 1.0 V [p-p] (including synchronization) Pb, Pr: ±0.35 V [p-p] AUDIO L-R: RCA PIN Type × 2 0.5 V [rms]	
	<b>HDMI 1-3</b>	TYPE A Connector × 3 • This TV supports "HDAVI Control 5" function.	
	<b>PC</b>	D-SUB 15PIN: R,G,B / 0.7 V [p-p] (75 Ω) HD, VD / 1.0 - 5.0 V [p-p] (high impedance)	
	<b>Dock for iPod</b>	DC 5V 500mA MAX	
	<b>Card slot</b>	SD CARD slot × 1	
	<b>DIGITAL AUDIO OUT</b>	PCM / Dolby Digital, Fiber Optic	
<b>FEATURES</b>	3D Y/C FILTER, CLOSED CAPTION, V-Chip, HDAVI Control 5 Vesa compatible, VIERA IMAGE VIEWER		
<b>Dimensions (W × H × D)</b>	<b>Including TV stand</b>	36.1" × 24.9" × 11.3" (917 mm × 632 mm 287 mm)	40.7" × 27.5" × 13.0" (1,032 mm × 697 mm × 329 mm)
	<b>TV Set only</b>	36.1" × 23.2" × 1.7" (3.0") (917 mm × 590 mm × 45 mm (77 mm))	40.7" × 25.8" × 1.5" (3.0") (1,032 mm × 655 mm × 39 mm (77 mm))
<b>Mass</b>	<b>Including TV stand</b>	38.6 lb. (17.5 kg) NET	47.4 lb. (21.5 kg) NET
	<b>TV Set only</b>	32.0 lb. (14.5 kg) NET	40.8 lb. (18.5 kg) NET

[TC-L37D2]

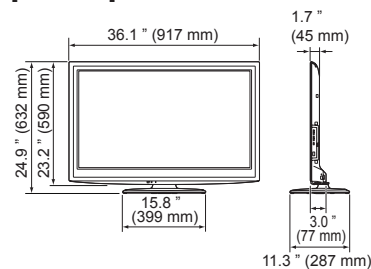

[TC-L42D2]

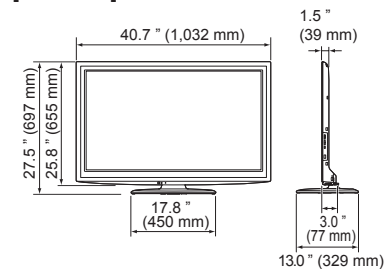

**Note**

• Design and Specifications are subject to change without notice. Mass and Dimensions shown are approximate.  
\* Based on IEC 62087 Ed.2 section 11.6.1 measurement method.

# Limited Warranty (for U.S.A. and Puerto Rico only)

PANASONIC CONSUMER ELECTRONICS COMPANY,  
DIVISION OF:  
PANASONIC CORPORATION OF NORTH AMERICA  
One Panasonic Way  
Secaucus, New Jersey 07094

## Panasonic LCD Televisions Limited Warranty

### Limited Warranty Coverage

If your product does not work properly because of a defect in materials or workmanship, Panasonic Consumer Electronics Company (referred to as "the warrantor") will, for the length of the period indicated on the chart below, which starts with the date of original purchase ("warranty period"), at its option either (a) repair your product with new or refurbished parts, (b) replace it with a new or a refurbished equivalent value product, or (c) refund your purchase price. The decision to repair, replace or refund will be made by the warrantor.

LCD TV CATEGORIES	PARTS	LABOR	SERVICE
Up to 42" (diagonal)	1 (ONE) YEAR	1 (ONE) YEAR	Carry-In
46" (diagonal) and larger			On-Site

During the "Labor" warranty period there will be no charge for labor. During the "Parts" warranty period, there will be no charge for parts.

You must carry-in your product or arrange for on-site service during the Limited Warranty period. If non-rechargeable batteries are included, they are not warranted. This warranty only applies to products purchased and serviced in the United States or Puerto Rico. This warranty is extended only to the original purchaser of a new product which was not sold "as is". A purchase receipt or other proof of the original purchase date is required for warranty service.

### On-Site or Carry-In Service

For On-Site or Carry-In Service in the United States and Puerto Rico call 1-877-95-VIERA (1-877-958-4372).

On-site service where applicable requires clear, complete and easy access to the product by the authorized servicer and does not include removal or re-installation of an installed product. It is possible that certain on-site repairs will not be completed on-site, but will require that the product or parts of the product, at the servicer's discretion be removed for shop diagnosis and/or repair and then returned.

### Limited Warranty Limits And Exclusions

This warranty ONLY COVERS failures due to defects in materials or workmanship, and DOES NOT COVER normal wear and tear or cosmetic damage, nor does it cover markings or retained images on the LCD panel resulting from viewing fixed images (including, among other things, non-expanded standard 4:3 pictures on wide screen TVs, or onscreen data in a stationary and fixed location). The warranty ALSO DOES NOT COVER damages which occurred in shipment, or failures which are caused by products not supplied by the warrantor, or failures which result from accidents, misuse, abuse, neglect, bug infestation, mishandling, misapplication, alteration, faulty installation, set-up adjustments, misadjustment of consumer controls, improper maintenance, power line surge, lightning damage, modification, or commercial use (such as in a hotel, office, restaurant, or other business), rental use of the product, service by anyone other than a Factory Service Center or other Authorized Servicer, or damage that is attributable to acts of God.

**THERE ARE NO EXPRESS WARRANTIES EXCEPT AS LISTED UNDER "LIMITED WARRANTY COVERAGE". THE WARRANTOR IS NOT LIABLE FOR INCIDENTAL OR CONSEQUENTIAL DAMAGES RESULTING FROM THE USE OF THIS PRODUCT, OR ARISING OUT OF ANY BREACH OF THIS WARRANTY.** (As examples, this excludes damages for lost time, cost of having someone remove or re-install an installed unit if applicable, or travel to and from the servicer. The items listed are not exclusive, but are for illustration only.) **ALL EXPRESS AND IMPLIED WARRANTIES, INCLUDING THE WARRANTY OF MERCHANTABILITY, ARE LIMITED TO THE PERIOD OF THE LIMITED WARRANTY.**

Some states do not allow the exclusion or limitation of incidental or consequential damages, or limitations on how long an implied warranty lasts, so the exclusions may not apply to you.

This warranty gives you specific legal rights and you may also have others rights which vary from state to state. If a problem with this product develops during or after the warranty period, you may contact your dealer or Service Center. If the problem is not handled to your satisfaction, then write to the warrantor's Consumer Affairs Department at the addresses listed for the warrantor.

**PARTS AND SERVICE (INCLUDING COST OF AN ON-SITE SERVICE CALL, WHERE APPLICABLE) WHICH ARE NOT COVERED BY THIS LIMITED WARRANTY ARE YOUR RESPONSIBILITY.**

# Customer Services Directory (for U.S.A. and Puerto Rico)

## Customer Services Directory (United States and Puerto Rico)

Obtain Product Information and Operating Assistance; locate your nearest Dealer or Service Center; purchase Parts and Accessories; or make Customer Service and Literature requests by visiting our Web Site at:

<http://www.panasonic.com/help>

or, contact us via the web at:

<http://www.panasonic.com/contactinfo>

You may also contact us directly at:

1-877-95-VIERA (958-4372)

Monday-Friday 9 am-9 pm; Saturday-Sunday 10 am-7 pm, EST.

■ For hearing or speech impaired TTY users, TTY: 1-877-833-8855

## Accessory Purchases (United States and Puerto Rico)

Purchase Parts, Accessories and Instruction Books on line for all Panasonic Products by visiting our Web Site at:

<http://www.pstc.panasonic.com>

or, send your request by E-mail to:

[npcparts@us.panasonic.com](mailto:npcparts@us.panasonic.com)

You may also contact us directly at:

1-800-332-5368 (Phone) 1-800-237-9080 (Fax Only) (Monday - Friday 9 am to 9 pm, EST.)

Panasonic Service and Technology Company

20421 84th Avenue South,

Kent, WA 98032

(We Accept Visa, MasterCard, Discover Card, American Express, and Personal Checks)

■ For hearing or speech impaired TTY users, TTY: 1-866-605-1277

# Limited Warranty (for Canada)

Panasonic Canada Inc.

5770 Ambler Drive, Mississauga, Ontario L4W 2T3

## PANASONIC PRODUCT – LIMITED WARRANTY

Panasonic Canada Inc. warrants this product to be free from defects in material and workmanship under normal use and for a period as stated below from the date of original purchase agrees to, at its option either (a) repair your product with new or refurbished parts, (b) replace it with a new or a refurbished equivalent value product, or (c) refund your purchase price. The decision to repair, replace or refund will be made by Panasonic Canada Inc.

Viera TV (42" & over)	In-home service	One (1) year, parts (including panel) and labour.
Viera TV (under 42")	Carry-in service	One (1) year, parts (including panel) and labour.

In-home Service will be carried out only to locations accessible by roads and within 50 km of an authorized Panasonic service facility.

In-home service requires clear, complete and easy access to the product by the Authorized Servicer and does not include removal or re-installation of an installed product. If removal is required to service the product, it will be at the discretion of the Servicer and in no event will Panasonic Canada Inc. or the Servicer be liable for any special, indirect or consequential damages.

This warranty is given only to the original purchaser, or the person for whom it was purchased as a gift, of a Panasonic brand product mentioned above sold by an authorized Panasonic dealer in Canada and purchased and used in Canada, which product was not sold "as is", and which product was delivered to you in new condition in the original packaging.

**IN ORDER TO BE ELIGIBLE TO RECEIVE WARRANTY SERVICE HEREUNDER, A PURCHASE RECEIPT OR OTHER PROOF OF DATE OF ORIGINAL PURCHASE, SHOWING AMOUNT PAID AND PLACE OF PURCHASE IS REQUIRED**

### LIMITATIONS AND EXCLUSIONS

This warranty ONLY COVERS failures due to defects in materials or workmanship, and DOES NOT COVER normal wear and tear or cosmetic damage. The warranty ALSO DOES NOT COVER damages which occurred in shipment, or failures which are caused by products not supplied by Panasonic Canada Inc., or failures which result from accidents, misuse, abuse, neglect, mishandling, misapplication, alteration, faulty installation, set-up adjustments, misadjustment of consumer controls, improper maintenance, power line surge, lightning damage, modification, introduction of sand, humidity or liquids, commercial use such as hotel, office, restaurant, or other business or rental use of the product, or service by anyone other than a Authorized Servicer, or damage that is attributable to acts of God. Dry cell batteries are also excluded from coverage under this warranty.

THIS EXPRESS, LIMITED WARRANTY IS IN LIEU OF ALL OTHER WARRANTIES, EXPRESS OR IMPLIED, INCLUDING ANY IMPLIED WARRANTIES OF MERCHANTABILITY AND FITNESS FOR A PARTICULAR PURPOSE. IN NO EVENT WILL PANASONIC CANADA INC. BE LIABLE FOR ANY SPECIAL, INDIRECT OR CONSEQUENTIAL DAMAGES RESULTING FROM THE USE OF THIS PRODUCT OR ARISING OUT OF ANY BREACH OF ANY EXPRESS OR IMPLIED WARRANTY. (As examples, this warranty excludes damages for lost time, travel to and from the Authorized Servicer, loss of or damage to media or images, data or other memory or recorded content. This list of items is not exhaustive, but for illustration only.)

In certain instances, some jurisdictions do not allow the exclusion or limitation of incidental or consequential damages, or the exclusion of implied warranties, so the above limitations and exclusions may not be applicable. This warranty gives you specific legal rights and you may have other rights which vary depending on your province or territory.

### WARRANTY SERVICE

For product operation and information assistance, please contact:

Our Customer Care Centre:

1-800 #:

1-866-330-0014

Email link: "Contact us → email" on [www.vieraconcierge.ca](http://www.vieraconcierge.ca)

For product repairs, please contact Viera Customer Care Agent using the above contact info.

### IF YOU SHIP THE PRODUCT TO A SERVICENTRE

Carefully pack and send prepaid, adequately insured and preferably in the original carton. Include details of the defect claimed, and proof of date of original purchase.