

USA Only: Disposal may be regulated in your community due to environmental considerations. For disposal or recycling information, please visit Panasonic website: <http://www.panasonic.com/environmental> or call 1-888-769-0149.

Sólo Estados Unidos: La disposición puede estar regulada en su comunidad debido a consideraciones ambientales. Para información sobre la disposición o reciclaje, por favor visite la página web de Panasonic: <http://www.panasonic.com/environmental> o llame al 1-888-769-0149.

#### Customer's Record

The model number and serial number of this product can be found on its back cover. You should note this serial number in the space provided below and retain this book, plus your purchase receipt, as a permanent record of your purchase to aid in identification in the event of theft or loss, and for Warranty Service purposes.

Model Number \_\_\_\_\_

Serial Number \_\_\_\_\_

#### Anotación del cliente

El modelo y el número de serie de este producto se encuentran en su panel posterior. Deberá anotarlos en el espacio provisto a continuación y guardar este manual, más el recibo de su compra, como prueba permanente de su adquisición, para que le sirva de ayuda al identificarlo en el caso de que le sea sustraído o lo pierda, y también para disponer de los servicios que le ofrece la garantía.

Modelo \_\_\_\_\_

Número de serie \_\_\_\_\_

**Panasonic Consumer Marketing Company of North America,  
Division of Panasonic Corporation of North America**  
One Panasonic Way, Secaucus  
New Jersey 07094 U.S.A.

**Panasonic Canada Inc.**  
5770 Ambler Drive  
Mississauga, Ontario  
L4W 2T3 CANADA

# Panasonic®

Model No.  
Número de modelo

**TC-P50U50**



Scan, watch and discover how to  
get the most out of your TV

Escanee, observe y descubra como  
obtener el máximo de su TV

<http://rd.pnaqr.com/TC-P00U50/2/1/>

## Owner's Manual

50" Class 1080p Plasma HDTV

(49.9 inches measured diagonally)

## Manual de usuario

Televisión de alta definición de 1080p y  
clase 50" de Plasma

(49,9 pulgadas medidas diagonalmente)

# VIERA

For assistance (U.S.A./Puerto Rico), please call:

**1-877-95-VIERA (958-4372)**

[www.panasonic.com/help](http://www.panasonic.com/help)

For assistance (Canada), please call:

**1-866-330-0014**

[conciERGE.panasonic.ca](http://conciERGE.panasonic.ca)

Para solicitar ayuda (EE.UU./Puerto Rico), llame al:

**1-877-95-VIERA (958-4372)**

[www.panasonic.com/help](http://www.panasonic.com/help)



**English**

Thank you for purchasing this Panasonic product.  
Please read these instructions before operating your set and retain them for future  
reference. The images shown in this manual are for illustrative purposes only.

**Español**

Gracias por su decisión de comprar este producto marca Panasonic.  
Lea estas instrucciones antes de utilizar su televisor y guárdelas para consultarlas en  
el futuro. Las imágenes mostradas en este manual tienen solamente fines ilustrativos.



TQB2AA0642

**This product incorporates the following software or technology:**

- (1) the software developed independently by or for Panasonic Corporation,
- (2) the software owned by third party and licensed to Panasonic Corporation,
- (3) the software based in part on the work of the Independent JPEG Group,
- (4) the software developed by the FreeType Project,
- (5) open sourced software other than the software licensed under the GPL and the LGPL.

For the software categorized as (5), please refer to the applicable license terms included in the "Setup" menu on product.

This product is licensed under the AVC patent portfolio license for the personal and non-commercial use of a consumer to (i) encode video in compliance with the AVC Standard ("AVC Video") and/or (ii) decode AVC Video that was encoded by a consumer engaged in a personal and non-commercial activity and/or was obtained from a video provider licensed to provide AVC Video. No license is granted or shall be implied for any other use. Additional information may be obtained from MPEG LA, LLC.  
See <http://www.mpegla.com>.

**■ Do not display a still picture for a long time**

This causes the image to remain on the plasma screen ("Image retention"). This is not considered a malfunction and is not covered by the warranty.



To prevent the "Image retention", the screen saver is automatically activated after a few minutes if no signals are sent or no operations are performed.

**Typical still images**

- Channel number and other logos
- Image displayed in 4:3 mode
- SD Card photo   ● Video game   ● Computer image

**■ Set up**

- Do not place the unit where it's exposed to sunlight or other bright light (including reflections).
- Use of some types of fluorescent lighting may reduce the remote control's transmission range.

**VIERA Link™**

VIERA Link™ is a trademark of Panasonic Corporation.

**HDMI**

HDMI, the HDMI logo and High-Definition Multimedia Interface are trademarks or registered trademarks of HDMI Licensing LLC in the United States and other countries.



SDXC Logo is a trademark of SD-3C, LLC.

**AVCHD™**

“AVCHD” and the “AVCHD” logo are trademarks of Panasonic Corporation and Sony Corporation.



This product qualifies for ENERGY STAR in the “Home Use” setting and this is the setting in which energy savings will be achieved. Any modifications to the “Home Use” setting or other factory default settings could result in greater energy consumption beyond levels that meet ENERGY STAR qualifications.

Manufactured under license from Dolby Laboratories. Dolby and the double-D symbol are trademarks of Dolby Laboratories.

HDAVI Control™ is a trademark of Panasonic Corporation.

**HDTV**

# Contents

## Please read before using the unit

- Safety Precautions..... 4

## Getting started

- Accessories/Optional Accessory..... 7
- Connections..... 10
- Identifying Controls..... 12
- First Time Setup..... 13

## Basic Features

- Watching TV..... 14
- Watching content from external devices..... 16
- Using Media player..... 17

## Advanced Features

- VIERA Link™ “HDAVI Control™”..... 22
- Editing and Setting Channels..... 27
- How to Use Menu Functions..... 29

## Support Information

- Technical Information..... 30
- Care and Cleaning..... 34
- Frequently Asked Questions (FAQ)..... 35
- Specifications..... 37
- Index..... 38
- Limited Warranty  
(for U.S.A. and Puerto Rico only)..... 39
- Customer Services Directory  
(for U.S.A. and Puerto Rico)..... 40
- Limited Warranty (for Canada)..... 41

Getting started



Basic

Advanced

Support Information



# Safety Precautions

	<b>CAUTION</b> <b>RISK OF ELECTRIC SHOCK</b> <b>DO NOT OPEN</b>	
<p>WARNING: To reduce the risk of electric shock, do not remove cover or back. No user-serviceable parts inside. Refer servicing to qualified service personnel.</p>		



The lightning flash with arrowhead within a triangle is intended to tell the user that parts inside the product are a risk of electric shock to persons.



The exclamation point within a triangle is intended to tell the user that important operating and servicing instructions are in the papers with the appliance.

WARNING: To reduce the risk of fire or electric shock, do not expose this apparatus to rain or moisture. Do not place liquid containers (flower vase, cups, cosmetics, etc.) above the set (including on shelves above, etc.).

## Important Safety Instructions

- 1) Read these instructions.
- 2) Keep these instructions.
- 3) Heed all warnings.
- 4) Follow all instructions.
- 5) Do not use this apparatus near water.
- 6) Clean only with dry cloth.
- 7) Do not block any ventilation openings. Install in accordance with the manufacturer's instructions.
- 8) Do not install near any heat sources such as radiators, heat registers, stoves, or other apparatus (including amplifiers) that produce heat.
- 9) Do not defeat the safety purpose of the polarized or grounding-type plug. A polarized plug has two blades with one wider than the other. A grounding type plug has two blades and a third grounding prong. The wide blade or the third prong are provided for your safety. If the provided plug does not fit into your outlet, consult an electrician for replacement of the obsolete outlet.
- 10) Protect the power cord from being walked on or pinched particularly at plugs, convenience receptacles, and the point where they exit from the apparatus.
- 11) Only use attachments / accessories specified by the manufacturer.
- 12) Use only with the cart, stand, tripod, bracket, or table specified by the manufacturer, or sold with the apparatus. When a cart is used, use caution when moving the cart / apparatus combination to avoid injury from tip-over.
- 13) Unplug this apparatus during lightning storms or when unused for long periods of time.
- 14) Refer all servicing to qualified service personnel. Servicing is required when the apparatus has been damaged in any way, such as power-supply cord or plug is damaged, liquid has been spilled or objects have fallen into the apparatus, the apparatus has been exposed to rain or moisture, does not operate normally, or has been dropped.
- 15) To prevent electric shock, ensure the grounding pin on the AC cord power plug is securely connected.



## WARNING/CAUTION (TV set)



### WARNING

Small parts can present choking hazard if accidentally swallowed.

Keep small parts away from young children. Discard unneeded small parts and other objects, including packaging materials and plastic bags/sheets to prevent them from being played with by young children, creating the potential risk of suffocation.

#### ■ Set up

This Plasma TV may fall and can cause personal injury or even death if not installed correctly. To prevent personal injury or death, follow these warnings:

- **Install the Plasma TV in accordance with the manufacturer's recommended pedestal or stand, corresponding hardware and installation instructions.** This Plasma TV is for use only with the following optional accessories. Use with any other type of optional accessories may cause instability. The following accessories are manufactured by Panasonic Corporation.
  - Wall-hanging bracket (Angled) TY-WK4P1RW
- **Be sure to ask a qualified technician to carry out the installation and set-up.** Two or more people are required to install or remove the television.

- **Some wall mounts (wall-hanging brackets) are not designed to be mounted to walls with steel studs or old cinder block constructions.** Ask your dealer or licensed contractor to properly secure the wall-hanging bracket.
- **Do not route the TV's power cord inside the wall.** The power cord was not designed for in-wall mounting. Doing so can lead to fire hazard.
- **Do not place the Plasma TV or its stand on a sloped or unstable surface.** The Plasma TV may fall or tip over.
- **Do not support the Plasma TV on a non-specified pedestal.**
- **Do not place the Plasma TV on furniture that can easily be used as steps, such as a chest of drawers.**
- **Do not climb or allow children to climb on the Plasma TV**
- **Place or install the Plasma TV where it cannot be pushed, pulled over or knocked down.**
- **Route all cords and cables such that they cannot be tripped over or pulled by curious children.**
- **Do not place any objects on top of the Plasma TV.** If water spills onto the Plasma TV or foreign objects get inside it, a short-circuit may occur, which could result in fire or electric shock. If any foreign objects get inside the Plasma TV, please consult an Authorized Service Center.

- In the unlikely event that you receive a shock from this product, it is possible that your household outlet may be wired improperly.

Have an electrician verify that the TV's outlet is properly wired. If the symptom persists, have the TV serviced by a qualified authorized technician.

- To prevent the spread of fire, keep candles or other open flames away from this product at all times



## ■ AC Power Supply Cord

To prevent fire or electric shock:

- The Plasma TV is designed to operate on a 120 V AC, 60 Hz service. Insert the power cord plug as far as it will go into the wall socket.  
If the plug is not fully inserted, heat may generate, which could cause a fire.
- The included power cord is for use with this unit only.
- Do not use any power cord other than that provided with this TV.
- Do not handle the power cord plug with wet hands.
- Do not do anything that might damage the power supply cord.
- When disconnecting the power supply cord, hold the plug, not the cord.
- Do not use the power supply cord if the plug or cord is damaged.  
Replace the cord or contact your Authorized Service Center.
- Do not use a 3-prong to 2-prong AC plug adapters to connect your TV's plug to the wall outlet.  
Doing so will defeat the TV plug's safety feature, which can lead to a shock hazard. If the wall outlet does not accommodate a 3-prong plug, have a qualified electrician replace your outlet and check the associated wiring.

## ■ Handling the power supply cord

- Insert the power plug fully into the socket outlet. (If the power plug is loose, it could generate heat and cause fire.)
- Ensure that the power plug is easily accessible.
- Ensure the earth pin on the power plug is securely connected to prevent electrical shock.
  - An apparatus with CLASS I construction shall be connected to a power socket outlet with a protective earthing connection.
- Do not touch the power plug with a wet hand. (This may cause electrical shock.)
- Do not use any power cord other than that provided with this TV. (This may cause fire or electrical shock.)
- Do not damage the power cord. (A damaged cord may cause fire or electrical shock.)
  - Do not move the TV with the cord plugged in the socket outlet.
  - Do not place a heavy object on the cord or place the cord near a high-temperature object.
  - Do not twist the cord, bend it excessively, or stretch it.
  - Do not pull on the cord. Hold onto the power plug body when disconnecting cord.
  - Do not use a damaged power plug or socket outlet.
- If a problem occurs (such as no picture or no sound), or if smoke or an abnormal odor is detected from the Plasma TV, unplug the power supply cord immediately. Continued use of the TV under these conditions might cause a fire or permanent damage to the TV. Have the TV evaluated by an Authorized Service Center. Servicing of the TV by unauthorized personnel is strongly discouraged due to its high voltage.
- If water or an object gets inside the Plasma TV, if the Plasma TV is dropped, or if the enclosure becomes damaged, unplug the power supply cord immediately. A short-circuit may occur, which could cause a fire. Contact an Authorized Service Center for an evaluation.

## ⚠ CAUTION

- Do not cover the ventilation holes.  
Doing so may cause the Plasma TV to overheat, which can cause a fire or damage to the Plasma TV.
- Leave a space of 3 15/16" (10 cm) or more at the top, left and right, and 2 3/4" (7 cm) or more at the rear.
- When using the pedestal, keep the space between the bottom of the TV and the pedestal or stand surface clear from objects that may obstruct ventilation.

## ■ When Moving the Plasma TV

- Be sure to disconnect all cables before moving the Plasma TV.  
Moving the TV with its cables attached might damage the cables which, in turn, can cause fire or electric shock.
  - To prevent an electric shock, disconnect the power plug from the wall outlet as a safety precaution before carrying out any cleaning.
  - Transport only in upright position.  
Transporting the unit with its display panel facing upright or downward may cause damage to the internal circuitry.
  - Using a dry cloth, clean any dust from the power supply cord and plug regularly.  
Build-up of dust on the power cord plug can increase humidity, which might damage the insulation and cause a fire.
- This Plasma TV radiates infrared rays;**  
therefore, it may affect other infrared communication equipment. Install your infrared sensor in a place away from direct or reflected light from your Plasma TV.
- The TV will still consume some power as long as the power supply cord is connected to the wall outlet.**

- Display panel is made of glass. Do not apply strong force or impact to the display panel.  
This may cause damage resulting in injury.
- The TV is heavy. TV should be handled by 2 or more people. Support as shown to avoid injury by the TV tipping or falling.

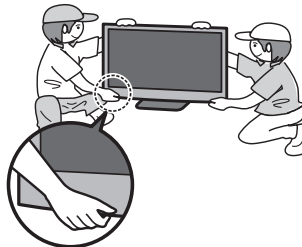

## FCC STATEMENT

This equipment has been tested and found to comply with the limits for an Other Class B digital device, pursuant to Part 15 of the FCC Rules. These limits are designed to provide reasonable protection against harmful interference in a residential installation. This equipment generates, uses and can radiate radio frequency energy and, if not installed and used in accordance with the instructions, may cause harmful interference to radio communications. However, there is no guarantee that interference will not occur in a particular installation. If this equipment does cause harmful interference to radio or television reception, which can be determined by turning the equipment off and on, the user is encouraged to try to correct the interference by one or more of the following measures:

- Reorient or relocate the receiving antenna.
- Increase the separation between the equipment and receiver.
- Connect the equipment into an outlet on a circuit different from that to which the receiver is connected.
- Consult the Panasonic Service Center or an experienced radio/TV technician for help.

### FCC Caution:

**To assure continued compliance, follow the attached installation instructions and use only shielded interface cables when connecting to peripheral devices. Any changes or modifications not expressly approved by Panasonic Corp. of North America could void the user's authority to operate this device.**

Responsible Party: Panasonic Corporation of North America  
One Panasonic Way, Secaucus, NJ 07094

Contact Source: Panasonic Consumer Marketing Company of North America  
1-877-95-VIERA (958-4372)

email: [consumerproducts@panasonic.com](mailto:consumerproducts@panasonic.com)

## CEA CHILD SAFETY NOTICES

### WARNING

Flat panel displays are not always supported on the proper stands or installed according to the manufacturer's recommendations. Flat panel displays that are inappropriately situated on dressers, bookcases, shelves, desks, speakers, chests or carts may fall over and may cause personal injury or even death.

The consumer electronics industry (of which Panasonic is a member) is committed to making home entertainment enjoyable and safe. To prevent personal injury or death, be sure to follow the following safety guidelines:

### TUNE INTO SAFETY:

- One size does NOT fit all. Follow the manufacturer's recommendations for the safe installation and use of your flat panel display.
- Carefully read and understand all enclosed instructions for proper use of this product.
- Don't allow children to climb on or play with furniture and television sets.
- Don't place flat panel displays on furniture that can easily be used as steps, such as a chest of drawers.
- Remember that children can become excited while watching a program, especially on "larger than life" flat panel displays. Care should be taken to install the display where it cannot be pushed, pulled over, or knocked down.
- Care should be taken to route all cords and cables connected to the flat panel display so that they cannot be pulled or grabbed by curious children.

### WALL MOUNTING: IF YOU DECIDE TO WALL MOUNT YOUR FLAT PANEL DISPLAY, ALWAYS:

- Use a mount that has been recommended by the display manufacturer and/or listed by an independent laboratory (such as UL, CSA, ETL).
- Follow all instructions supplied by the display and wall mount manufacturers.
- If you have any doubts about your ability to safely install your flat panel display, contact your retailer about professional installation.
- Make sure the wall where you are mounting the display is appropriate. Some wall mounts are not designed to be mounted to walls with steel studs or old cinder block construction. If you are unsure, contact a professional installer.
- A minimum of two people are required for installation. Flat panel displays can be heavy.

**Panasonic recommends that a qualified installer perform the wall-mount installation. See page 4.**

**The American Academy of Pediatrics discourages media viewing for children younger than two years. For more details, see [www.aap.org](http://www.aap.org).**



# Accessories/Optional Accessory

## Accessories

Check you have all the items shown.

### Accessories

- Remote Control Transmitter
  - N2QAYB000706



- Batteries for the Remote Control Transmitter (2)
  - AA Battery

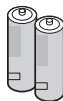

- Power cord

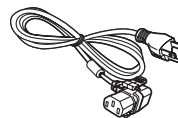

- Owner's Manual
- Quick start guide
- Child safety
- Product Registration Card (U.S.A.)

- Pedestal

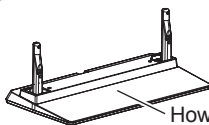

How to assemble (p. 8)

- Ferrite core for HDMI cable (2) for USB cable (1)



### Optional Accessory

Please contact your nearest Panasonic dealer to purchase the recommended wall-hanging bracket. For additional details, please refer to the wall-hanging bracket installation manual.

#### Wall-hanging bracket

- TY-WK4P1RW

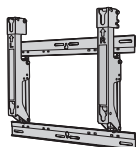

a: 15.7" (400 mm)  
b: 11.8" (300 mm)

The angle of wall-hanging bracket can be adjusted in "zero tilting (vertical)" and "5, or 10-degree tilting" for this TV.

Rear of the TV

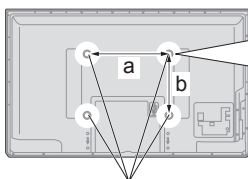

Holes for wall-hanging bracket installation

Screw for attaching the TV to the wall-hanging bracket (not supplied with the TV)

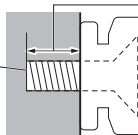

(View from the side)

Depth of screw:  
minimum 0.67" (17.0 mm),  
maximum 1.38" (35.0 mm)

M8

#### Warning

- In order to maintain the TV's performance and safety, be absolutely sure to ask your dealer or a licensed contractor to secure the wall-hanging brackets.
- Carefully read the instructions accompanying optional accessories, and be absolutely sure to take steps to prevent the TV from tipping over.
- Handle the TV carefully during installation since subjecting it to impact or other forces may cause product damage.
- Take care when fixing wall brackets to the wall. Always ensure that there are no electrical cables or pipes in the wall before hanging bracket.
- When using the angled-type wall hanging bracket, please ensure that there is sufficient space for the connecting cables not to press against the wall when the TV is tilted forward.
- For safety reasons, remove units no longer being used from their wall-mounted locations.



## Assembling the pedestal

- Fix securely with assembly screws (A) (Total 4 screws).
- Tighten screws firmly.

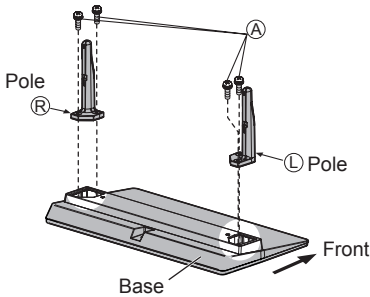

## Set-up

- Tighten assembly screws (B) (total 4 screws) loosely at first, then tighten them firmly to fix securely.

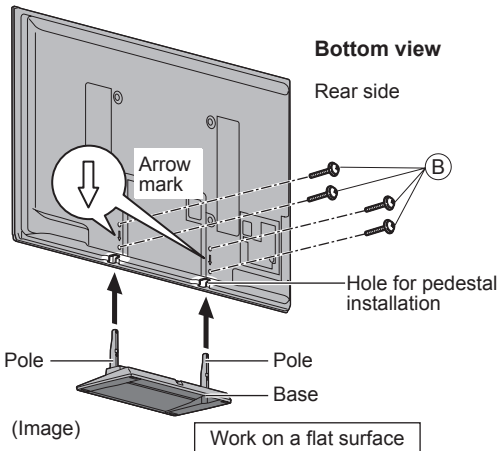

## Accessories

Assembly screws  
(4 of each)



- XYN5+F18FN  
size (M5 × 18) (Silver)



- THEL080N  
size (M5 × 30) (Black)

Poles (2)

- (L) TBLA3680
- (R) TBLA3679

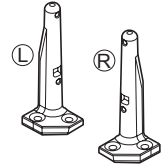

- (L) or (R) is printed at the bottom of the poles.

Base (1)

- TBL5ZX0337

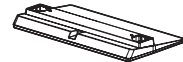

## Removing the pedestal from the TV

Be sure to remove the pedestal in the following way when using the wall hanging bracket or repacking the TV.

- ① Remove the assembly screws (B) from the TV.
- ② Lift the TV from the pedestal.
- ③ Remove the assembly screws (A) from the pole.

### Warning

**Do not disassemble or modify the pedestal.**

- Otherwise, the TV may fall over and become damaged, and personal injury may result.

### Caution

**Do not use any pedestal other than that provided with this TV.**

- Otherwise, the TV may fall over and become damaged, and personal injury may result.

**Do not use the pedestal if it becomes warped or physically damaged.**

- If you use the pedestal when it is physically damaged, personal injury may result. Contact your nearest Panasonic Dealer immediately.

**During set-up, make sure that all screws are securely tightened.**

- If sufficient care is not taken to ensure screws are properly tightened during assembly, the pedestal will not be strong enough to support the TV, and it might fall over and become damaged, and personal injury may result.

**When removing the pedestal, do not remove the pedestal by any methods other than the specified procedure. (Above)**

- Otherwise, the TV and/or pedestal may fall over and become damaged, and personal injury may result.

## Power cord connection

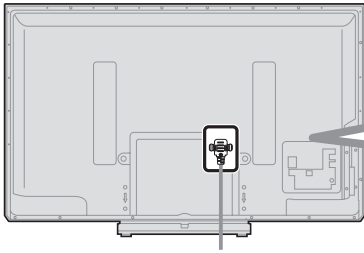

### To attach

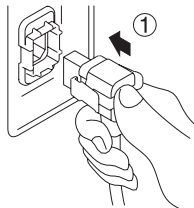

Insert it firmly until the tabs on both sides click into place.

### To remove

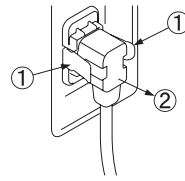

Keep pushing both sides until they snap and pull.

## Attaching Ferrite Core

Be sure to attach the provided ferrite core to the HDMI cable/USB cable (not supplied) to reduce interference or electrical noise.

- 1 Attach the ferrite core as close as possible to connector on the TV side as shown.

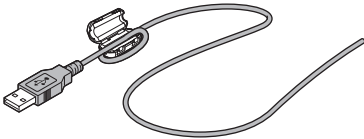

(example: USB connector)

- 2 Close the ferrite core until it clicks.

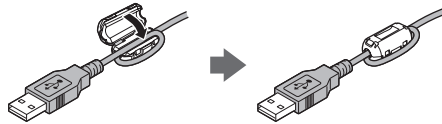

## Installing the remote's batteries

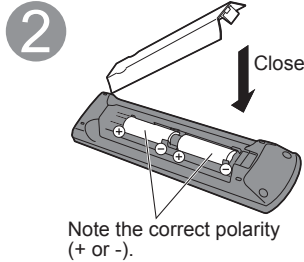
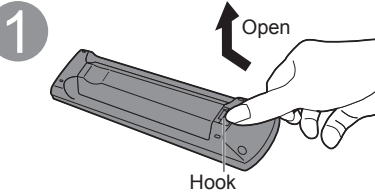

### Caution

- Incorrect installation may cause battery leakage and corrosion, resulting in damage to the remote control.
- Do not mix old and new batteries.
- Do not mix different battery types (such as alkaline and manganese batteries).
- Do not use rechargeable (Ni-Cd) batteries.
- Do not burn or break batteries.

# Connections

## Connection Panels

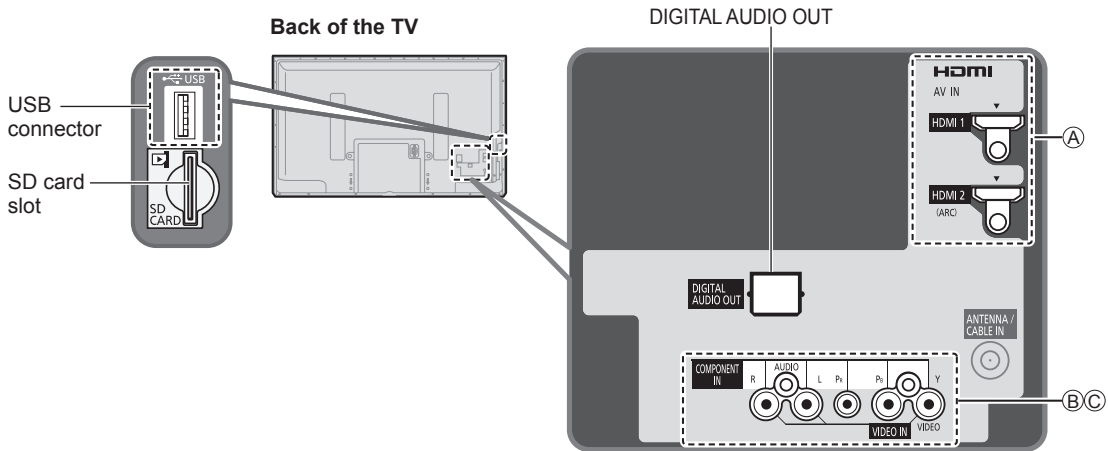

## Antenna or Cable connection

\* See page 9  
(Power cord connection)

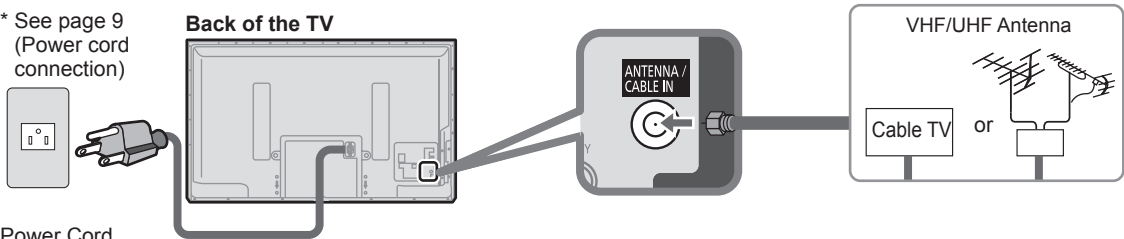

**Power Cord**  
(Connect after all the other connections have been made.)

### VHF/UHF Antenna

- NTSC (National Television System Committee):  
ATSC (Advanced Television Systems Committee):  
Digital TV Standards include digital high-definition television (HDTV), standard-definition television (SDTV), data broadcasting, multi-channel surround sound audio and interactive television.

### Cable

- You need to subscribe to a cable TV service to enjoy viewing their programming.
- You may need to subscribe to a high-definition (HD) cable service to enjoy HD programming.  
The connection for high-definition can be done with the use of an HDMI or Component Video cable. (p. 11)

### Note

- When using a Cable box, external equipment and video cables shown in this manual are not supplied with the TV.
- When disconnecting the power cord, be absolutely sure to disconnect the power cord plug from the wall outlet first.
- For additional assistance, visit us at: [www.panasonic.com/help](http://www.panasonic.com/help)  
[www.panasonic.ca](http://www.panasonic.ca)



# Identifying Controls

## TV controls/indicators

### Front of the TV



C.A.T.S. sensor  
Plasma C.A.T.S. (Contrast Automatic Tracking System)

Power indicator  
(on: red, off: no light)

Remote control sensor within about 23 feet (7 meters) in front of the TV set

### Back of the TV

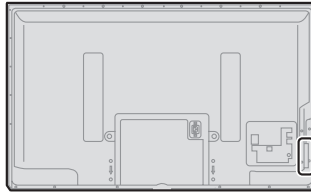

Changes the input mode  
Chooses Menu and Submenu entries (Press and hold down for MENU function)

Selects channels in sequence

Volume up/down

POWER button

- An image of the control panel is displayed on the screen while using it.

### Note

- The TV consumes a small amount of electric energy even when turned off.
- Do not place any objects between the TV remote control sensor and remote control.

## Remote control

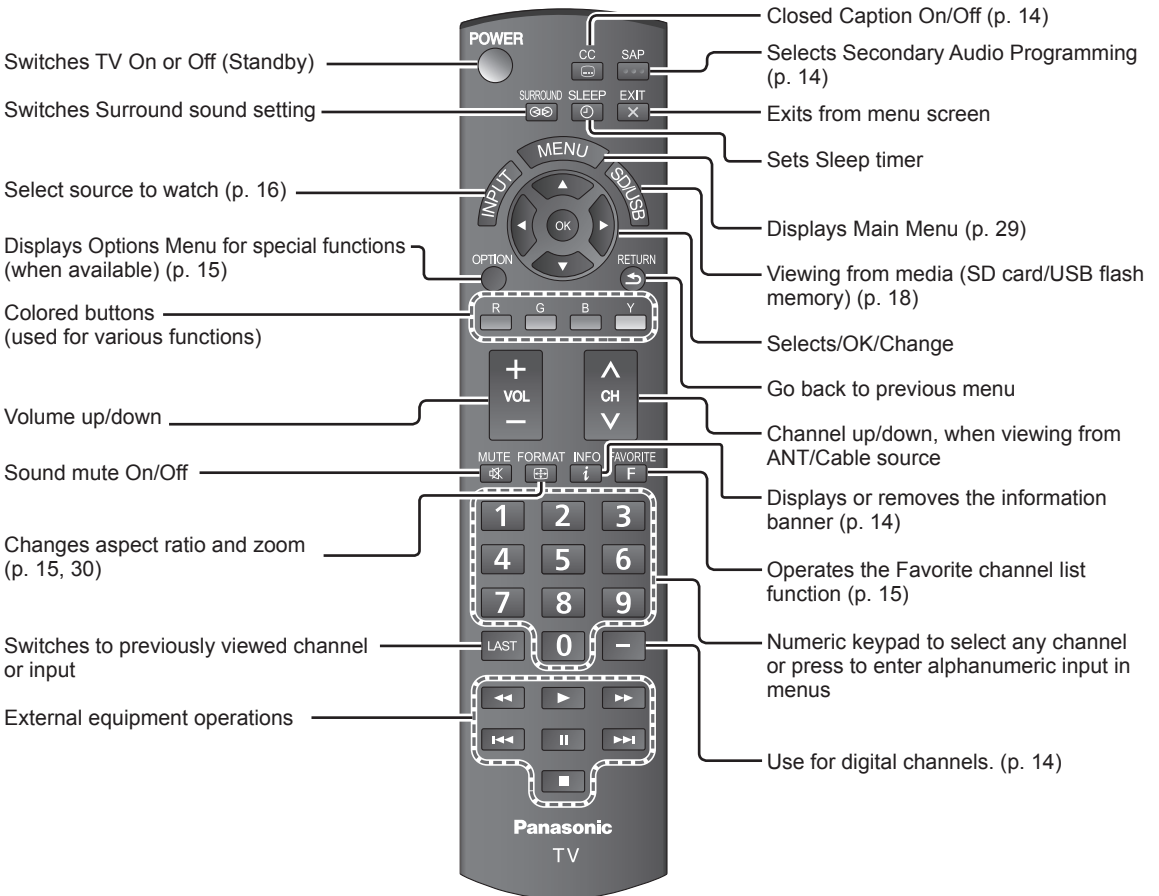

# First Time Setup

The first time setup screen is displayed only when the TV is turned on for the first time, after the power cord is inserted into a wall outlet and the “Auto power on” is set to “No”.

(Press **MENU** → **Setup** → **Advanced setup** → **Auto power on**)



1

## Turn the TV on with the POWER button

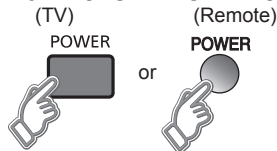

2

## Setup the following items

- **Select your language**
- **Select your viewing mode (Be sure to select “Home Use”)**  
If you select “Store Demonstration” by mistake, confirmation screen will be displayed.  
To display the “Set viewing mode” screen again and select “Home Use”, do one of the following:
  - Press and hold down the side POWER button for at least five seconds.
  - Unplug power cord for 30 seconds and plug in again.
- **ANT/Cable setup**  
Select and set the settings according to your ANT/Cable environment.  
Select “Yes” on the confirmation screen, to start the scanning process.  
After scanning is finished completely, press OK to continue.
- **Label the inputs for easy identification**  
To name each input, follow the instructions on screen.  
When done, select NEXT and press OK to go to the next step.  
(Input select: Refer to Watching content from external devices (p. 16))
- **Adjust the Clock**  
Select the clock mode and set other settings.

3

## Complete First time setup

Completion screen is displayed.

### You can repeat the First time setup

- Press **MENU** → **Setup** → **First time setup**

To watch TV via a Cable box, Satellite receiver, or any other source (DVD, DVR, gaming device, etc.), press the INPUT button and select the appropriate input.

# Watching TV

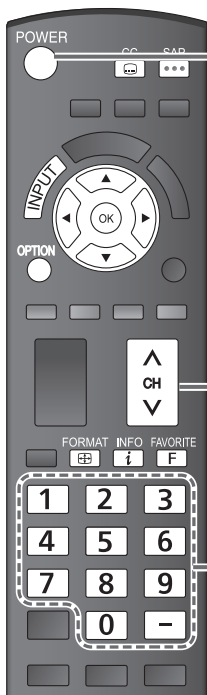

**1 Turn power on**  
(Remote) POWER or (TV) POWER

**Note**  
● Please select correct input --> (p. 16)

**2 Select a channel number**

up  
CH  
down

or

1	2	3
4	5	6
7	8	9
	0	

**To directly enter a digital channel number**  
- When tuning to a digital channel, press the button to enter the minor number in a compound channel number.

example: CH15-1: **1** **5** **-** **1**

**[For Cable/Satellite box connection]**  
- Use your connected box's remote control.

**Note**  
If at the end of the scanning no channels are found, then check:  
1. Antenna's position – or  
2. Availability of Cable service  
Cable, Satellite or Fiber services with a box are typically connected to the TV's A/V inputs, preferably HDMI, for best HD picture. In such a case, the channel scanning is not needed (set "ANT IN" to "Not used").

## Other Useful Functions

### Listen with SAP (Secondary Audio Programming)

**Select the Audio mode for watching TV**

**Digital mode:** Select available audio service when receiving a digital channel. Audio track is automatically selected as DTV language and SAP settings in Audio menu.  
**Menu > Audio > DTV language and SAP settings**  
\* If you change the audio settings with SAP button, DTV language and SAP settings does not change.

**Audio track 1 of 7** — Track number / Number of tracks  
**English (Main audio)** — Current audio track information (language, audio type)  
**English audio** — Audio service information

(example)  
**Analog mode:** Select the desired Audio mode. (Stereo/SAP/Mono)  
● SAP is not available when watching TV with a Cable or Satellite box connected via HDMI.  
● Contact your Cable or Satellite operator for instructions on enabling SAP with their box.

### Closed caption

**Switches the Closed caption mode On or Off**

CC

● Closed caption is not available when watching TV with a Cable or Satellite box connected via HDMI.  
● Contact your Cable or Satellite operator for instructions on enabling CC with their box.

### Displaying Information

**Displays TV status information. Also, when watching programs via the Antenna/Cable input, INFO will include the channel banner.**

INFO

15-2 ABC-HD	THE NEWS CC SAP TV-G	1080i	Standard	4:3	12:30 PM ⌚ 30
Station identifier	SAP indication Closed caption	Signal resolution Rating Level	Picture mode	Aspect ratio	Sleep timer remaining time

## Change aspect ratio and Zoom the picture

### ■ Press **FORMAT** to cycle through the aspect modes (p. 30)

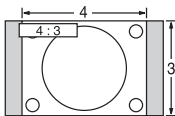

- 480i, 480p: FULL/JUST/4:3/ZOOM
- 1080p, 1080i, 720p: FULL/H-FILL/JUST/4:3/ZOOM

Use when the picture does not fill the whole screen (bars appear on either side of the image) or portions of the picture is trimmed.

#### Note

1. Some content, such as film-based movies, are available in extra-wide format. Top and bottom bars are unavailable.
2. Connected devices, such as Cable/Satellite box, DVD/Blu-ray players and game consoles have their own aspect (format) settings. Adjust the device's aspect settings.

## Display the Options menu

### ■ Press **OPTION** to show the Options menu screen

This menu consists of shortcuts to convenient functions.

Options menu is only available when the TV is using the Antenna/Cable input, not when using Cable or Satellite box.

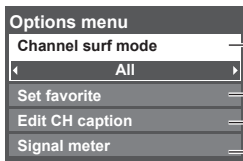

- Specify favorites or type of channels to view when pressing the channel up/down button.
- Set favorite channel (below)
- Edit the channel identifier (p. 28)
- Check the antenna's signal strength (p. 28)

## Call up a favorite channel

### ■ FAVORITE

Channel numbers registered in Favorite are displayed on the favorite tune screen. Select the desired broadcast station with the cursor or use the number buttons. (p. 14)

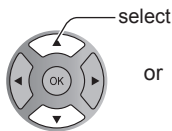
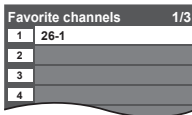

or



### ■ Set the Favorite channel

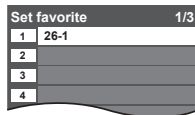
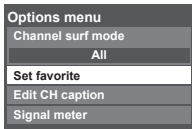

- ① select the list number
- ② save the displayed channel

or



- select the list number (to save the channel without pressing OK)



### ■ Delete a favorite channel

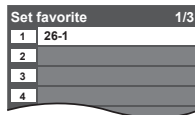

- ① select
- ② delete (while holding down)

### ■ To change the page



Press repeatedly to change between pages (1/3, 2/3, 3/3 or exit)



Changes the page forward/backward

- Favorite channels cannot be set when using Cable or Satellite box.



## Set Sleep Timer

The TV automatically goes into Standby after the selected period.

■ Press SLEEP repeatedly until the desired time appears.

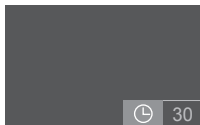

- Off/15/30/60/90 (minutes)

### Note

- It is also possible to set the time from "Sleep Timer" in the "Timer" menu (p. 29).
- To cancel, set to "Off" or turn off the TV.
- To display the remaining time Information banner (p. 14)
- When the remaining time is within 3 minutes, the remaining time will be displayed on screen.

# Watching content from external devices

1 With the connected equipment turned On  
**Display the Input select menu**



2 **Select the input mode**

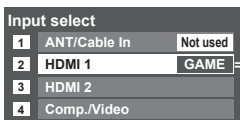

(example)



or

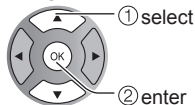

Input label



Terminal Label  
(example)

G Set ANT/Cable in (p. 27)

R Enable Inputs  
Edit labels

➔ Input labels  
(Press MENU -> Setup -> Input labels)

You can also press the corresponding NUMBER button or press INPUT repeatedly to cycle through the available inputs. If you are unsure which input to select, wait 2 seconds between each selection.

- For your convenience, you can edit the inputs with labels that are easy to remember.
- During the selection, if no action is taken for several seconds, the "Input select" menu disappears.

3 **Operate the connected equipment directly or use the remote control supplied with the equipment**

### Note

- For details, see the manual for the connected equipment.

# Using Media player

You can view still and motion images and play music saved on a USB flash memory and an SD card.

## Basic features for Media player

### Available contents and features

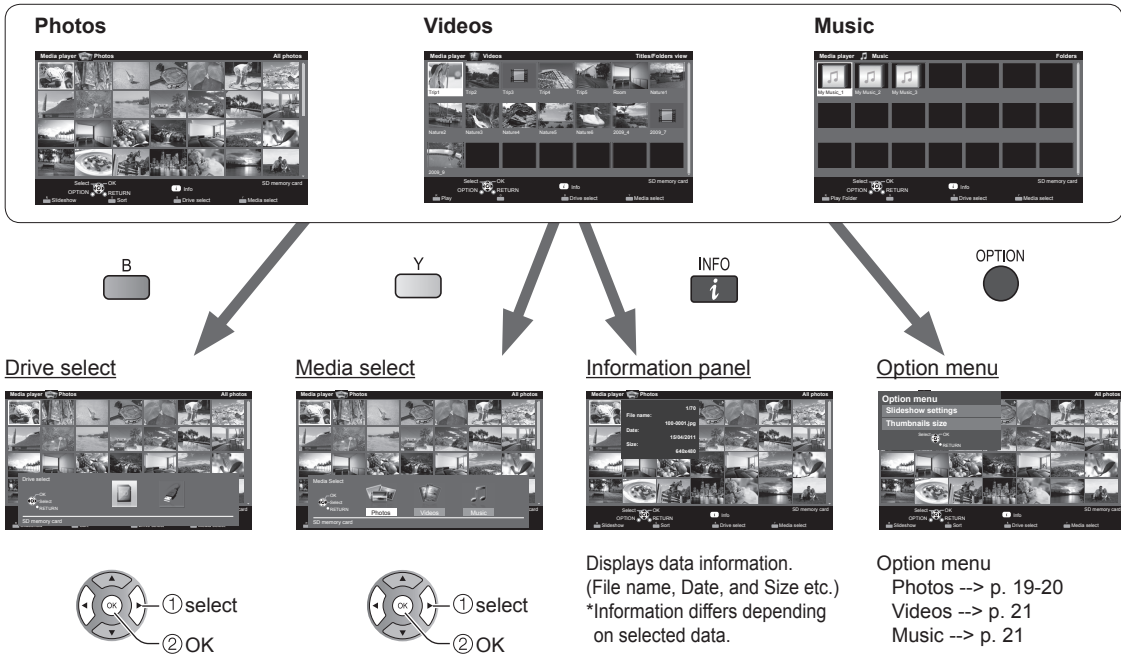

Basic

- Using Media player
- Watching content from external devices

## Media information

### Inserting or removing an SD card/USB flash memory

#### SD card

- Insert the card
- Remove the card

Gently insert the SD Card label surface facing front.

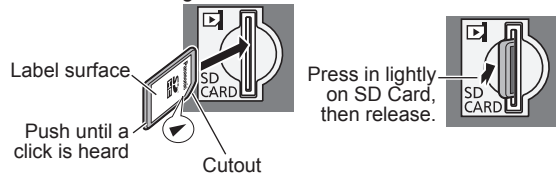

- Compliant card type (maximum capacity): SDXC Card (64 GB), SDHC Card (32 GB), microSDHC Card (32 GB), SD Card (2 GB), miniSD Card (2 GB), microSD Card (2 GB) (requiring microSDHC Card/miniSD Card/microSD Card/ adapter)
- If a microSDHC Card, miniSD Card or microSD Card is used, insert/remove it together with the adapter.

#### USB flash memory

- Insert the device
- Remove the device



- Media player only supports USB Mass storage class devices.

- For more information and cautions on SD card and USB flash memory (p. 31)

## 1 Insert Media (SD card or USB flash memory)

- Auto play setting → Setup > Advanced setup > Image viewer auto play

## 2 Display Media player



## 3 Select Drive and Media

(Display connected drive)

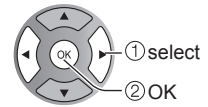
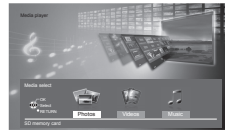
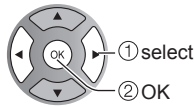

## 4 Select the data (Photos/Videos/Music)

How to view the data differs depending on data storage conditions.

### ① Select Title/Folder



(e.g. Photos)

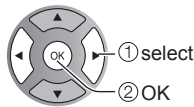

### ② Select file



(e.g. Photos)

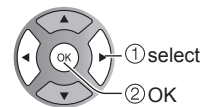

## 5 View or Play

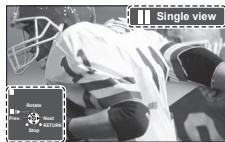

(e.g. Photos)

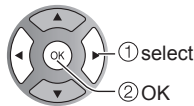

Thumbnail / Playback view image and operation are different depending on selected contents.

- Photos view --> p. 19-20
- Videos view --> p. 21
- Music view --> p. 21

# Photos view

## [Photos thumbnail]



## [Features]

- Slideshow setting → R
- Sort → G
- Drive select → B
- Media select → Y

## [Photos playback screen]

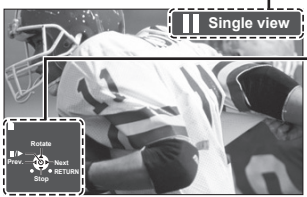

## Photo status

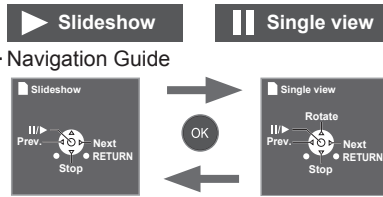

- To display/hide Guide and Banner → INFO

## Sort

### ① Display "Sort select" menu and select item

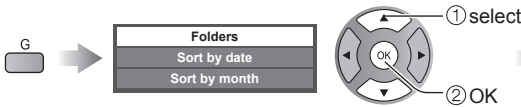

### ② Displayed each view



- Folders (ascending order of numeric/alphabetical)
- Sort by month (ascending order of the month)
- Sort by date

## Photo options

### ① Display "Options menu" and select item

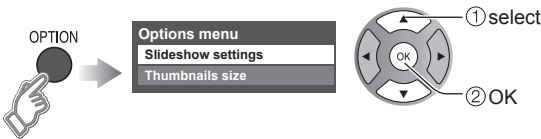

### ■ Slideshow settings (p. 20)

### ■ Thumbnails size

To change the number of photos on a thumbnail screen at a time  
 → (7 × 4 ↔ 10 × 6)

# Slideshow

## ① Display “Slideshow settings”

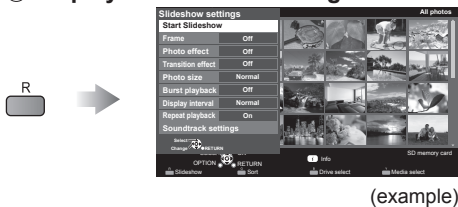

## ② Adjust items and select “Slideshow start”

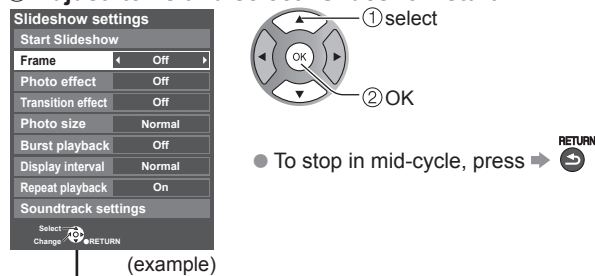

### ■ Slideshow settings

Settings	Item Description
Frame	Select the Frame ( <b>Off/Array/Collage/Drift(with calendar)/Drift/Gallery(with calendar)/Gallery/Cinema</b> )
Photo effect	Select the display effect ( <b>Off/Sepia/Gray scale</b> )
Transition effect	Select the Transition effect shown between photos ( <b>Off /Fade in/Wipe ↓/Wipe ↑/Wipe →/Wipe ←/Slide in ↓/Slide in ↑/Slide in →/Slide in ←/Zoom in/Comb ↑↓/Comb →←/Dissolve/Checker wipe/Motion/Random</b> )
Photo size	Removes the black borders that are added according to the size of the photo being displayed. ( <b>Normal/Zoom</b> )
Burst playback	Continuously plays photos that were shot. ( <b>Off/On</b> )
Display interval	Set “Display interval” each image is displayed in the Slideshow mode. ( <b>Short/Fast/Normal/Slow/Very slow</b> )
Repeat playback	Turn the Slideshow Repeat (cycle) function on or off ( <b>Off/On</b> ).
Soundtrack settings	Select the music ( <b>Off/Music 1/Music 2/Music 3/Music 4/Music 5/User selected/Auto</b> ) User selected: Plays the soundtrack registered in the “Soundtrack settings”. (below) Auto: Plays the songs on the SD card or USB flash memory.

- Picture quality may become lower depending on the slideshow settings.
- Picture setting may not work depending on the slideshow settings.

### ■ Soundtrack settings

#### ① Select “Soundtrack settings” ② Select “User selected” ③ Select the song and register

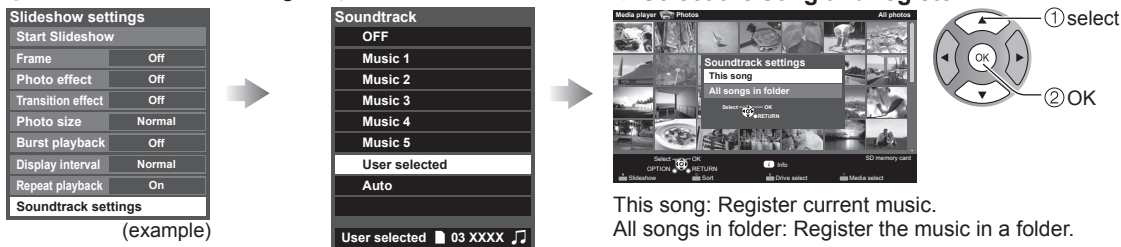

## Videos view

### [Videos thumbnail]

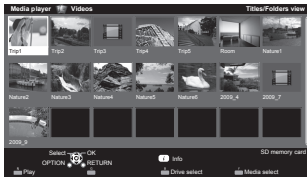

### [Features]

- Play → R
- Drive select → B
- Media select → Y

### [Videos playback screen]



Movie banner

Drive type (SD/USB)



Date and time or File name

Elapsed time of current movie

- To display/hide Guide and Banner → INFO

Navigation area

- Subtitles are not supported in MKV file.



- Forward/Reverse Five levels of 1 to 5 (x2, x5, x30, x70, x100) are available.

## Music view

### [Music thumbnail]

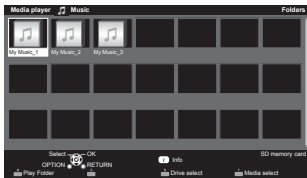

### [Features]

- Play folder → R
- Drive select → B
- Media select → Y

### [Music playback screen]

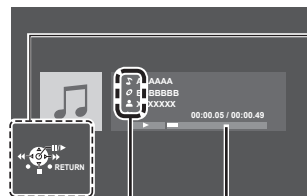

Navigation area



- Forward/Reverse Five levels of 1 to 5 (x2, x5, x30, x70, x100) are available.

- Artist name
- Album name
- Song name

Elapsed time of current song

- To display/hide Guide and Banner → INFO

## Video/Music options

Displayed menu will differ depending on contents.

### ① Select "Video/Music options" in "Options menu"

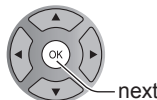
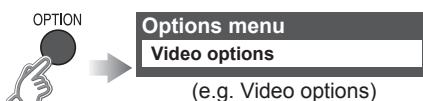

### ■ Repeat playback

Set play repeat function  
Video: (On/Off)  
Music: (Off/Repeat Folder/One song)



(e.g. Video options)



# VIERA Link™ “HDAVI Control™”\*

Simultaneously control all Panasonic “HDAVI Control” equipped components using one button on the TV remote. Enjoy additional HDMI Inter-Operability with compatible Panasonic products.

This TV supports “HDAVI Control 5” function.

Connections to equipment (Blu-ray Disc player, DVD recorder DIGA, HD Camcorder, Home theater system, Amplifier, etc.) with HDMI cables enables VIERA Link controls.

Equipment with the “HDAVI Control” function enables the following operations:

Version	Operations (See p. 24-26, for more information)
HDAVI Control or later	<ul style="list-style-type: none"><li>● Automatic Input Switching</li><li>● Power on link</li><li>● Power off link</li><li>● Default speakers</li><li>● Speaker control</li></ul>
HDAVI Control 2 or later	<ul style="list-style-type: none"><li>● VIERA Link control only with the TV's remote control</li><li>● Unselected device energy save (for available equipment only)</li></ul>
HDAVI Control 3 or later	<ul style="list-style-type: none"><li>● Provides setting information (Language, time, etc.)</li><li>● Automatic lip-sync function</li></ul>
HDAVI Control 4 or later	<ul style="list-style-type: none"><li>● Energy saving mode (with Quick Start mode)</li></ul>
HDAVI Control 5	<ul style="list-style-type: none"><li>● Audio Return Channel Audio Return Channel (ARC) is a function that enables digital sound signals to be sent via an HDMI cable back from the TV to a connected audio device.</li></ul>

■ **When adding new equipment, reconnecting equipment or changing the setup after the connection, turn the equipment on and then switch the TV on. Set the input mode to HDMI1 or HDMI 2 (p. 16), and make sure that the image is displayed correctly.**

VIERA Link “HDAVI Control”, is based on the control functions provided by HDMI and industry standard known as HDMI CEC (Consumer Electronics Control), with unique function that we have developed and added. As such, its operation with other manufacturers' equipment that supports HDMI CEC cannot be guaranteed.

Please refer to the individual manuals for other manufacturers' equipment supporting the VIERA Link function.

## ■ HDMI cable

This function needs an HDMI compliant (fully wired) cable. Non-HDMI-compliant cables cannot be utilized.

It is recommended that you use Panasonic's HDMI cable. Recommended part number:

RP-CDHS15 (4.9 ft/1.5 m), RP-CDHS30 (9.8 ft/3.0 m), RP-CDHS50 (16.4 ft/5.0 m)

\* For more details on the external equipment's connections, please refer to the operating manual for the equipment.

## Terminal overview

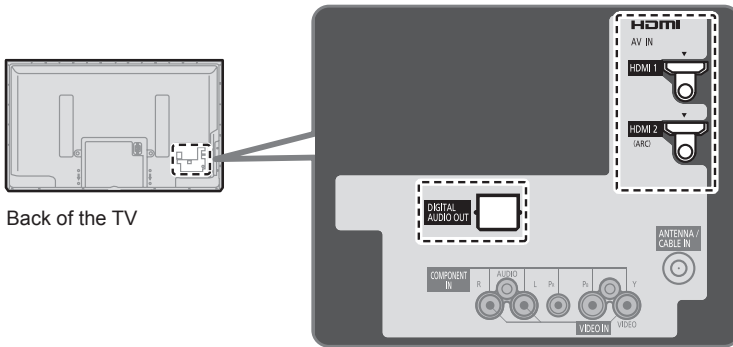

## Connecting Blu-ray Disc player/DVD Recorder (DIGA)

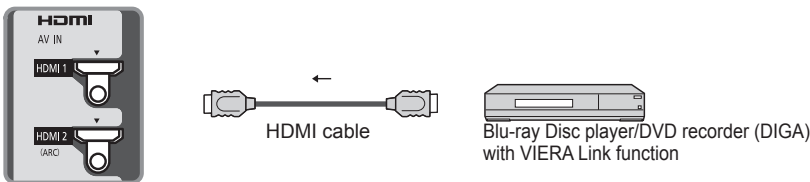

## Connecting Home theater system/AV amp

HDMI 2 is recommended.

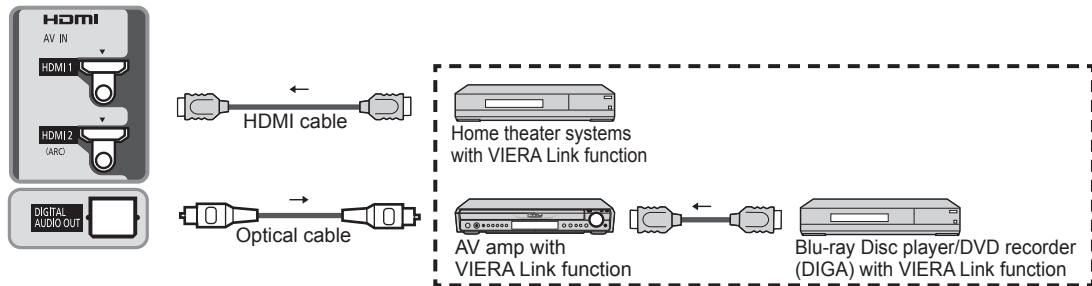

No optical cable is necessary when connecting a Home Theater supporting "HDAVI control 5" with an HDMI cable. Audio will be supported via ARC (Audio Return Channel) (p. 22)

- One AV amp and one Blu-ray Disc player/DVD recorder (DIGA) can be operated with this unit.

## Connecting HD Camcorder/Digital camera

Press INPUT and select an available HDMI terminal, then connect the camcorder to this input. After connection, confirm the HDAVI control functions. (p. 24-26)

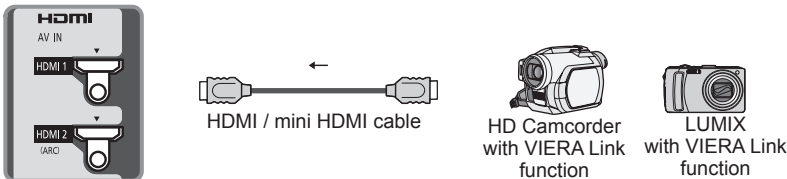

If connection (or setting) of equipment compatible with HDAVI control is changed, switch the power of this unit Off and On again while the power of all equipment is On (so that the unit can correctly recognize the connected equipment) and check that the connected equipment playback operates.

### Note

- Individual HDMI equipment may require additional menu settings specific to each model. Please refer to their respective manuals.
- When audio from other equipment connected to this unit via HDMI is output using "DIGITAL AUDIO OUT" of this unit, the system switches to 2CH audio.  
(When connecting to an AV amp via HDMI, you can enjoy higher sound quality.)
- Some devices use Mini-HDMI terminal. HDMI (type A) to Mini-HDMI (type C) cable or adapter should be used.



# VIERA Link settings and Available features

To use all VIERA Link functions: After everything is connected, in VIERA Link settings menu, set “VIERA Link” to “On”. Some features are disabled depending on the “HDAVI Control” version of the equipment. Please check the list (p. 22)

## 1 Select “VIERA Link settings”

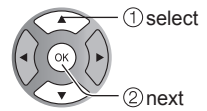
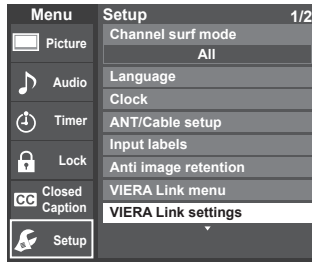

## 2 Set “VIERA Link” to “On”

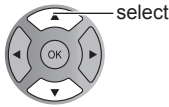
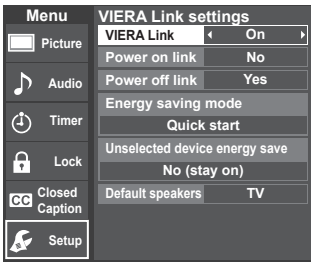

## 3 Select and make other settings

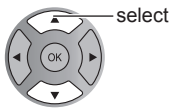
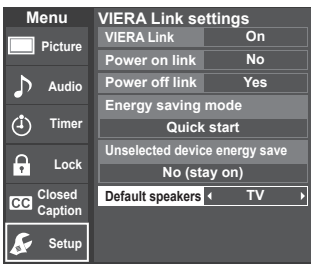

## Automatic Input Switching

When using a Blu-ray Disc player, DVD player/recorder or Home theater system, the TV will automatically change to the appropriate input, when playback begins on one of those devices.

- For a Home theater system the speakers automatically switch to the theater system.

## Power on link

Yes: The TV is turned on automatically and switches to the appropriate HDMI input whenever VIERA Link compatible equipment is initially turned on and the Play mode is selected.

## Power off link

When “Yes” is selected and the TV is turned off, all connected VIERA Link compatible equipment is also automatically turned off.

- A Panasonic DVD Recorder will not turn off if it is still in Rec mode.
- The TV remains on even if the VIERA Link compatible equipment is turned off.

## Energy saving mode

Quick Start: When TV is turned off, all connected VIERA Link compatible equipment is moved to ECO Standby mode\* automatically under these conditions.

- Power off link:(Yes), The connected equipment has “HDAVI Control 4 or later (with Quick Start mode)”
- \* Minimum power consumption of Standby condition for the equipment.

## Unselected device energy save

Yes: The connected VIERA Link compatible equipment will be turned off automatically when not in use under these conditions.

- The connected equipment has “HDAVI Control 2 or later” (for available equipment only)

[ Example of timing for operation ]

- When the input is switched from the HDMI.

## Default speakers

“TV” is the default setting. To set the Home theater system as Default speakers, change the Default speakers setting from “TV” to “Theater”. Sound will be output from the Home theater whenever the TV is powered on.

## Automatic lip-sync function

Minimizes lip-sync delays between the picture and audio when you connect to a Panasonic theater system or Amplifier.

## TV provided setting information

The following information about the TV settings can be transmitted to each piece of equipment (Recorder/Home theater/Player) that has “HDAVI Control 3 or later” function connected to a TV with an HDMI cable.

Transmittable data	Recorder	Home theater	Player
① On Screen Display Language setting (English/Español/Français)	○	○	○
② Panel Aspect Ratio (16:9 fixed)	○	○	○
③ Closed caption information (Mode/CC type/Digital setting)	○	---	---

### Note

- There is a possibility that all the GUI language information might be set from equipment that has an HDMI CEC function connected to the TV with an HDMI cable. Depending on the operating conditions or the specification for each piece of equipment the setting may or may not be applied.
- For more details on the external equipment’s operation, please refer to the operating manual for the equipment.

## VIERA Link menu and Available features

Some features are disabled depending on the "HDAVI Control" version of the equipment. Please check the list (p. 22)

### 1 Display the VIERA Link menu

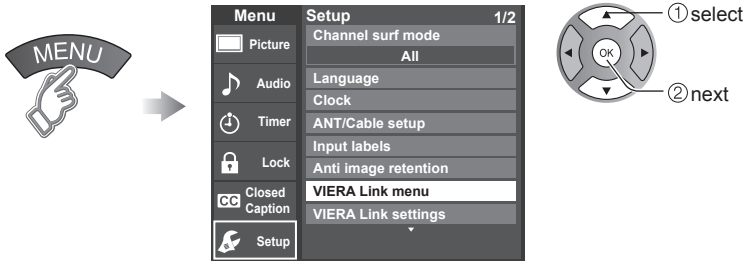

### 2 Select the item and set the settings

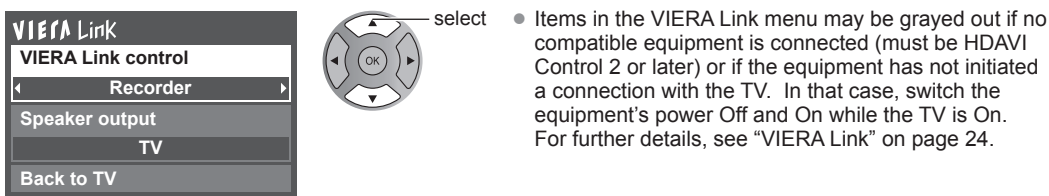

## Speaker control

You can select the Home theater or TV speakers for audio output. Control the theater speakers with the TV remote control. This function is available only when a Panasonic Amplifier or Player theater is connected.

- ① Select "Speaker output"
- ② Select "Home theater" or "TV"

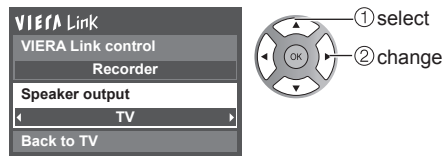

■ **Home theater:** Adjustment for the equipment

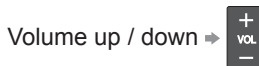

Mute →

- The sound of the TV is muted.
- When the equipment is turned off, the TV speakers take over.
- Selecting "Home theater" turns the equipment on automatically if it is in Standby mode.

■ **TV:** The TV speakers are on.

## VIERA Link control only with the TV's remote control

In the VIERA Link menu, you can select HDMI connected equipment and access it quickly. Continue using your TV remote control to operate the equipment, pointing it at the TV.

- ① Select "VIERA Link control"
- ② Select the equipment you want to access (Recorder/Home theater/Player/Camcorder/LUMIX/Others)

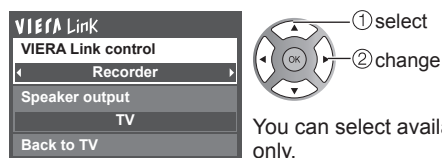

- If there is more than one equipment item, a number after the name indicates the number of items. (e.g. Recorder 1/Recorder 2/Recorder 3...)
- The number of equipment items that can be connected is three for recorders, and a total of three for Home theater/Player/Camcorder/LUMIX/Others.

### Note

- There is a limit to the number of HDMI connectors.
- ③ **Operate the equipment with the TV remote control, pointing it at the TV**
  - To operate the equipment, read the manual of the equipment.

Available TV remote control buttons: Whether an operation is available differs depending on the connected equipment.

## Back to TV

Returns the input selection of the device selected with the VIERA Link Control to the TV input.

# Editing and Setting Channels

The current channel settings can be changed according to your needs and reception conditions.

## ANT/Cable setup and operation

### 1 Select "Setup"

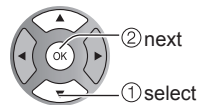
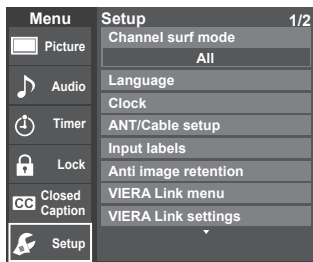

### 2 Select "ANT/Cable setup"

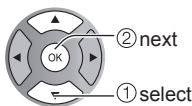
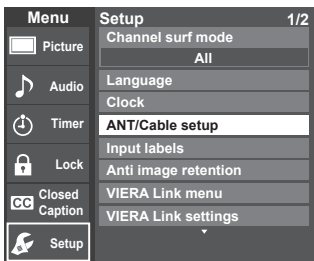

## Auto program (Set automatically)

Automatically searches and adds available channels to the memory.

- ① Select "ANT in"  
 ➔ Select "Cable" or "Antenna"  
 Or select "Not used".

### ② Select "Auto program"

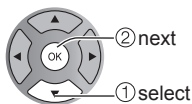
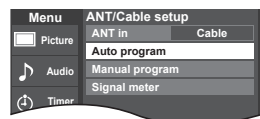

### ③ Select a scanning mode

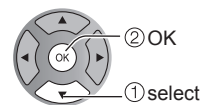
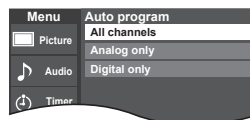

- After the scanning is completed, select "Apply". (see p. 28 ⑤).
- All previously saved channels are erased.

## Manual program (Set manually)

Use this procedure when changing the channel setup or changing the channel display. Also, use this to add or skip channels from the channel list manually.

You can select a channel tuning mode (Digital only/Analog only) in "Channel surf mode"

### ① Select "Edit"

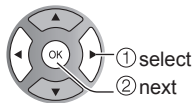
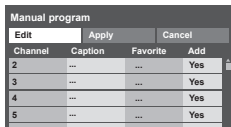

### ② Select the item to edit

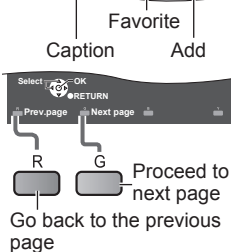
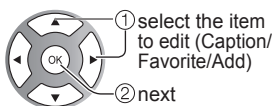
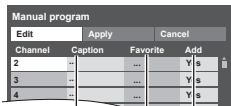

- Caption: Changes the station identifier
- Favorite: Registers channels to the Favorite List
- Add: Adds or skips channels

### ③ Edit

#### ● Caption

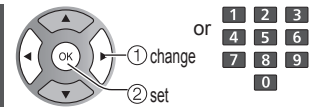
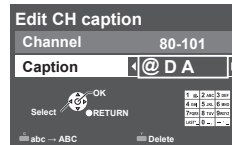

#### Caption

Select or edit the station identifier. (maximum 7 characters available)



#### ● Favorite

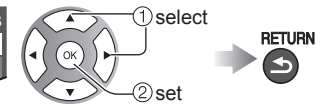

**Set favorite** Select the number

#### ● Add

Press OK to select "Yes (add)" or "No (skip)"



### ④ Move the cursor to a channel number

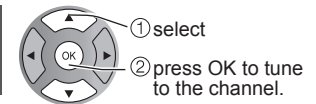
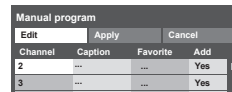

### ⑤ Select "Apply"

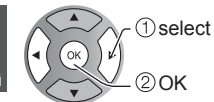

## To cancel the Edit

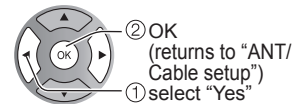
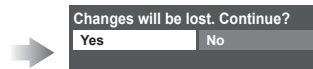
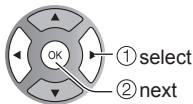
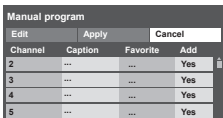

## Signal meter (Check signal strength)

Check the signal strength if interference is found or freezing occurs on a digital image.

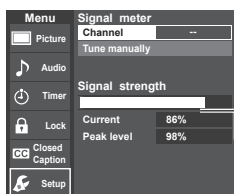

Signal intensity

- If the signal is weak, check the antenna. If no problem is found, consult your local dealer.

#### Note

- Not available if "Cable" is selected in "ANT in" (see p. 27).
- Available only for digital antenna channels.

# How to Use Menu Functions

Various menus allow you to set the picture, sound, and other functions so that you can enjoy watching TV best suited for you.

## 1 Display the menu



- Shows the functions that can be adjusted.
- Some functions will be disabled depending on the type of input signal.

### Menu structure

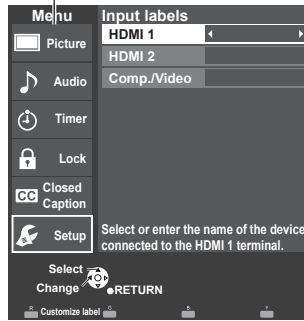

- Menu bar  
Press OK to move to the Menu items.
- Menu items  
Press OK to proceed to the next screen if available.
- Help information  
The explanations of the menu item are displayed here.
- Operation guide

(example: Input labels)

## 2 Select the menu

- Please refer to Help information for details in the menu items.
- Please refer to Operation guide to operate the menu.
- \* Some menus are grayed out depending on the input signal or condition.
- \* "Reset to default" (except one in "Setup") will be grayed out if there is no change.

<b>Picture</b>	<b>Adjust the image or picture quality</b> Picture mode/Contrast/Brightness/Color/Tint/Sharpness/Color temp./Color mgmt./C.A.T.S./Video NR/Aspect adjustments/HDMI settings/Advanced picture
<b>Audio</b>	<b>Adjust Audio quality</b> Bass/Treble/Balance/Advanced audio (A.I.sound/Surround/Bass boost/Volume leveler/TV speakers/HDMI*in)/DTV language and SAP settings
<b>Timer</b>	<b>Automatically turn On/Off at date and time</b> Sleep (Off timer) /Timer1-5 (Turn On/Off at the set date) * If the Timer settings are grayed out, first set the clock and make sure "Auto power on" is set to "No". (See below, "Setup")
<b>Lock</b>	<b>Locks specified channels or shows to prevent children from watching objectionable content.</b> You will be asked to enter your password each time you display the Lock menu. Mode (Lock Off/All/Custom) /Channel/Game/Program/Change password * When "Mode" is set to "Custom", set "Channel," "Game" and "Program" respectively.
<b>Closed Caption</b>	<b>Display Closed caption (CC)</b> The television includes a built-in decoder that is capable of providing a text display of the audio. Mode(On/Off/CC on mute)/Analog/Digital/Digital setting * The settings in "Analog" or "Digital" depend on the broadcaster.
<b>Setup</b>	<b>Other function settings</b> <ul style="list-style-type: none"> <li>• Channel surf mode Sets the mode to select the channel with the Channel up/down button.</li> <li>• Language Selects the screen menu language.</li> <li>• Clock Adjusts the TV's date and time. (Needed for timer function)</li> <li>• ANT/Cable setup Scans for Antenna or Cable channels.</li> <li>• Input labels Customize TV inputs with the names of your connected devices for easier input selections.</li> <li>• Anti Image retention Prevents residual images.</li> <li>• VIERA Link menu Displays VIERA Link menu.</li> <li>• VIERA Link Settings Sets automatic power on and input switching plus energy savings for connected HDMI devices.</li> <li>• ECO/energy saving Activates energy saving features with automatic power off.</li> <li>• Keyboard type Selects the country/region of the keyboard connected to this TV.</li> <li>• Advanced setup Adjusts detailed items concerning the TV setting. (Auto power on/Image viewer auto play)</li> <li>• First time setup Launches First time setup wizard. Repeats the initial step-by-step TV setup.</li> <li>• About Displays TV's firmware version and software license.</li> <li>• Reset to defaults Clears all TV settings and memory to factory defaults.</li> </ul>

# Technical Information

## Ratings List for parental control

“V-chip” technology enables you to lock channels or shows according to standard ratings set by the entertainment industry.

### ■ U.S. MOVIE RATINGS (MPAA)

NR	Not Rated.
G	All children and General Audience.
PG	Parental Guidance suggested.
PG-13	Parental Guidance for children under 13.
R	Restricted Viewing, parental guidance is suggested for children under 17.
NC-17/X	No one 17 or under allowed.

### ■ U.S. TV PROGRAMS RATINGS (U. S. TV)

Age-Based Ratings

TV-NR	Not Rated.
TV-Y	All children.
TV-Y7	Directed to children age 7 and older.
TV-G	General Audience.
TV-PG	Parental Guidance suggested.
TV-14	Parents Strongly cautioned, parental guidance is suggested for children under 14.
TV-MA	Mature Audience only.

Contents-Based Ratings

FV	Fantasy Violence.
D	Suggestive Dialogue.
L	Strong Language.
S	Sexual situations.
V	Violence.

#### Caution

- The V-Chip system that is used in this set is capable of blocking “NR” programs (non rated, not applicable and none) as per FCC Rules Section 15.120(e)(2). If the option of blocking “NR” programs is chosen “unexpected and possibly confusing results may occur, and you may not receive emergency bulletins or any of the following types of programming:”
  - Emergency Bulletins (Such as EAS messages, weather warnings and others)
  - Locally originated programming • News • Political • Public Service Announcements • Religious • Sports • Weather

### ■ CANADIAN ENGLISH RATINGS (C. E. L. R.)

E	Exempt programming.
C	All children.
C8+	Children 8 years and older.
G	General programming.
PG	Parental Guidance.
14+	Viewers 14 and older.
18+	Adult programming.

### ■ CANADIAN FRENCH RATINGS (C. F. L. R.)

E	Exempt programming.
G	General programming.
8 ans+	Not recommended for young children.
13 ans+	Not recommended for ages under 13.
16 ans+	Not recommended for ages under 16.
18 ans+	Programming restricted to adults.

## Aspect Ratio (FORMAT)

Press the FORMAT button to cycle through the aspect modes. This lets you choose the aspect depending on the format of the received signal and your preference. (p. 15)  
(e.g.: in case of 4:3 image)

- FULL: Enlarges the 4:3 image horizontally to the screen's side edges. (Recommended for anamorphic picture)
- JUST: Stretches to justify the 4:3 image to the four corners of the screen. (Recommended for normal TV broadcast)
- H-FILL: Enlarges the 4:3 image horizontally to the screen's side edges. The side edges of the image are cut off.
- 4:3: Standard (Note that “Image retention” of the side bar may occur from displaying it for a long time.)
- ZOOM: Enlarges the 4:3 image to the entire screen. (Recommended for Letter Box)
- 480i (4:3), 480i (16:9), 480p (4:3), 480p (16:9): FULL, JUST, 4:3 or ZOOM
- 1080p / 1080i / 720p: FULL, H-FILL, JUST, 4:3 or ZOOM

#### ● Zoom adjustments

Vertical image position and size can be adjusted in “ZOOM”.

① Select “Zoom adjustments” on the “Picture” menu.

② V-position: Vertical position adjustment

③ V-size: Vertical size adjustment

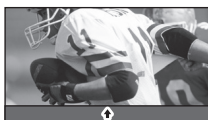

- To reset the aspect ratio →  (OK)

## H size

### ● Aspect Ratio: 4:3

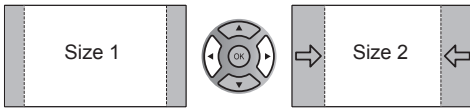

- The width will be decreased on both sides to reduce noise.

### ● Aspect Ratio: FULL/JUST(H-FILL/ZOOM)

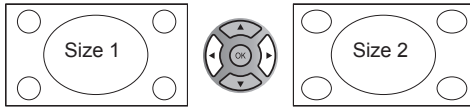

- The width will be increased on both sides to reduce noise.

## Data format information

### Compatible Data format for Media player (SD card/USB flash memory)

Media	Compatible format
Photo	<ul style="list-style-type: none"> <li>• JPEG files (DCF and EXIF standards)                             <ul style="list-style-type: none"> <li>Sub-sampling - 4:4:4, 4:2:2 and 4:2:0</li> <li>Image resolution - 8 × 8 to 30,712 × 17,272 pixels</li> </ul> </li> </ul>
Videos	<ul style="list-style-type: none"> <li>• SD-Video Files (SD-Video Standard Ver.1.3)                             <ul style="list-style-type: none"> <li>Modified data with a PC may not be displayed correctly.</li> </ul> </li> <li>• AVCHD Standard compatible files                             <ul style="list-style-type: none"> <li>Modified data with a PC may not be displayed correctly.</li> </ul> </li> <li>• MP4 files (Video codec H.264   Audio codec MP3/AC-3/LPCM)</li> <li>• MKV files (Video codec H.264   Audio codec MP3/AC-3/LPCM)</li> </ul>
Music	<ul style="list-style-type: none"> <li>• MP3 files (MPEG Audio Layer-3)</li> <li>• AAC files (MPEG2-AAC / MPEG4-AAC)</li> </ul>

### Note

- Format the card with the recording equipment.
- The picture may not appear correctly on this TV depending on the recording equipment used.
- Some files may not be played back even if they fulfill these conditions.
- Depending on how you make SD Card, USB Flash Memory or the media server, files and folders may not be displayed in the order you numbered.
- Depending on how you create the files and the structure of folders, the files and folders may not be displayed.
- When there are many files and folders, operation may take time to complete or some files may not be displayed or playable.
- Media player cannot display still images that are not DCF formatted (i.e. TIFF, BMP).
- Data modified with a PC may not be displayed.
- Images imported from a PC must be compatible with EXIF 2.0, 2.1 and 2.2.
- Partly degraded files might be displayed at a reduced resolution.
- All ".JPG" extension data in the card and USB flash memory will be read in Photo viewer mode.
- The folder and file names may be different depending on the digital camera used.
- Do not use two-byte characters or other special codes.
- The card may become unusable with this TV if file or folder names are changed.
- For the suitable SD Memory Cards, please confirm the latest information on the following website.  
<http://panasonic.jp/support/global/cs> (This site is in English only)



## Cautions when handling SD Cards

- Use an SD Card which meets SD standards. If not, it may cause the TV to malfunction.
- Do not remove the card while the unit is accessing data (this can damage card or unit).
- Do not touch the terminals on the back of the card.
- Do not subject the card to high pressure or impact.
- Insert the card in the correct direction (otherwise, card or unit may be damaged).
- Electrical interference, static electricity or erroneous operation may damage the data or card.
- Back up the recorded data at regular intervals in case of deteriorated or damaged data or erratic operation of the unit. (Panasonic is not liable for any deterioration or damage of recorded data.)

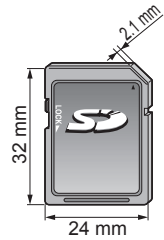

## SD Card/USB flash memory warning messages

Message	Meaning
No media. Please insert an SD memory card or USB storage device.	● The device is not inserted.
No media. Device removed.	● The device is removed.
No photos/ No movies/No music files to play/ No playable media	● The device has no data or this type of data is not supported.
Cannot read file	● The file is broken or unreadable. ● The TV does not support the format.

## VIERA Link™ “HDAVI Control™”

HDMI connections to some Panasonic equipment allow you to interface automatically. (p. 23)

- This function may not work normally depending on the equipment condition.
- The equipment can be operated by other remote controls with this function on even if the TV is in Standby mode.
- Image or sound may not be available for the first few seconds when playback starts.
- Image or sound may not be available for the first few seconds when input mode is switched.
- Volume function will be displayed when adjusting the volume of the equipment.
- If you connect equipment that has “HDAVI Control 2 or later” function to the TV with an HDMI cable, the sound from the DIGITAL AUDIO OUT terminal can be output as multi-channel surround.
- “HDAVI Control 5” is the newest standard (current as of November, 2011) for the HDAVI Control compatible equipment. This standard is compatible with the conventional HDAVI equipment.

## HDMI connection

HDMI (high-definition multimedia interface) allows you to enjoy high-definition digital images and high-quality sound by connecting the TV unit and HD devices.

HDMI-compatible equipment (\*1) with an HDMI or DVI output terminal, such as a Cable or Satellite box or a DVD player, can be connected to the HDMI connector using an HDMI compliant (fully wired) cable.

- HDMI is the world’s first complete digital consumer AV interface complying with a non-compression standard.
- If the external equipment has only a DVI output, connect to the HDMI terminal via a DVI to HDMI adapter cable (\*2).
- When the DVI to HDMI adapter cable is used, connect the audio cable to the audio input terminal.
- Audio settings can be made on the “HDMI 1 in” or “HDMI 2 in” menu screen.
- Applicable audio signal sampling frequencies (L.PCM): 48 kHz, 44.1 kHz, 32 kHz

(\*1): The HDMI logo is displayed on an HDMI-compliant device.

(\*2): Enquire at your local digital equipment retailer shop.

### Caution

- The HDMI terminals on this TV were not specifically designed for use with a PC.
- All signals are reformatted before being displayed on the screen.
- If the connected device has an aspect adjustment function, set the aspect ratio to “16:9”.
- These HDMI connectors are “type A”.
- These HDMI connectors are compatible with HDCP (High-Bandwidth Digital Content Protection) copyright protection.
- A device having no digital output terminal may be connected to the input terminal of either “COMPONENT”, or “VIDEO” to receive analog signals.
- The HDMI input terminal can be used with only the following image signals: 480i, 480p, 720p, 1080i, and 1080p. Match the output setting of the digital device.
- For details of the applicable HDMI signals, see p. 33.

## DIGITAL AUDIO OUT terminal

You can enjoy your Home theater by connecting a Dolby Digital (5.1 channel) decoder and "Multi Channel" amplifier to the DIGITAL AUDIO OUT terminals.

### Caution

- Depending on your DVD player and DVD-Audio software the copyright protection function may operate and disable optical output.
- When an ATSC channel is selected, the output from the DIGITAL AUDIO OUT jack will be Dolby Digital. When an NTSC channel is selected, the output will be PCM.
- When playing a movie on SD Card Movie player, when the sound has been recorded in Dolby Digital, the output from the DIGITAL AUDIO OUT terminal will be Dolby Digital. When the sound is recorded in other formats, the output will be PCM.

## Closed Caption (CC)

- For viewing the CC of digital broadcasting, set the aspect to FULL (If viewing with H-FILL, JUST, ZOOM or 4:3; characters might be cut off).
- If the CC is set to On on both the receiver and TV when the signal is 480i (except for the HDMI connection), the CC may overlap on the TV.
- If a digital program is being output in analog format, the CC data will also be output in analog format.
- If the recorder or output monitor is connected to the TV, the CC needs to be set up on the recorder or output monitor.

## 4:3 side bars

Do not display a picture in 4:3 mode for an extended period, as this can cause "Image retention" to remain on either or both sides of the display field.

To reduce the risk of such "Image retention", change the brightness of the side bars.

The side bar may flash (alternate black/white) depending on the picture.

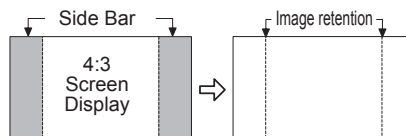

## Input signal that can be displayed

\* Applicable input signal for Component (Y, P<sub>B</sub>, P<sub>R</sub>), HDMI

	horizontal frequency (kHz)	vertical frequency (Hz)
525 (480)/60i	15.73	59.94
525 (480)/60p	31.47	59.94
750 (720)/60p	45.00	59.94
1,125 (1,080)/60i	33.75	59.94
1,125 (1,080)/60p	67.43	59.94
1,125 (1,080)/60p	67.50	60.00
1,125 (1,080)/24p*	26.97	23.98
1,125 (1,080)/24p*	27.00	24.00

(\* HDMI only)

### Note

- Signals other than those shown above may not be displayed properly.
- The above signals are reformatted for optimal viewing on your display.

Panasonic does not guarantee operation and performance of peripheral devices made by other manufacturers; and we disclaim any liability or damage arising from operation and/or performance from usage of such other maker's peripheral devices.

# Care and Cleaning

**First, unplug the Power cord plug from the wall outlet.**

## Display panel

The front of the display panel has been specially treated. Wipe the panel surface gently using only a cleaning cloth or a soft, lint-free cloth.

- If the surface is particularly dirty, after cleaning up the dust, soak a soft, lint-free cloth in diluted, mild liquid dish soap (1 part mild liquid dish soap diluted by 100 times the amount of water), and then wring the cloth to remove excess liquid. Use this cloth to wipe the surface of the display panel, then wipe it evenly with a dry cloth of the same type until the surface is dry.
- Do not scratch or hit the surface of the panel with fingernails or other hard objects. Furthermore, avoid contact with volatile substances such as insect sprays, solvents, and thinner; otherwise, the quality of the surface may be adversely affected.

## Cabinet

If the cabinet becomes dirty, wipe it with a soft, dry cloth.

- If the cabinet is particularly dirty, soak the cloth in diluted, mild liquid dish soap and then wring the cloth dry. Use this cloth to wipe the cabinet and then wipe it dry with a dry cloth.
- Do not allow any mild liquid dish soap to come into direct contact with the surface of the Plasma TV. If water droplets get inside the unit, operating problems may result.
- Avoid contact with volatile substances such as insect sprays, solvents, and thinner; otherwise, the quality of the cabinet surface may be adversely affected or the coating may peel off.
- Do not let articles made from rubber or PVC be in contact with the TV for long periods of time.

## Pedestal

- **Cleaning**  
Wipe the surfaces with a soft, dry cloth. If the unit is particularly dirty, clean it using a cloth soaked with water to which a small amount of mild liquid dish soap has been added and then wipe with a dry cloth.  
Do not use products such as solvents, thinner, or household wax for cleaning, as they can damage the surface coating. (If using a chemically-treated cloth, follow the instructions supplied with the cloth.)
- Do not attach sticky tape or labels, as they can make the surface of the pedestal dirty. Do not allow long-term contact with rubber, vinyl products, or the like. (Doing so will cause deterioration.)

## Power cord plug

Wipe the plug with a dry cloth at regular intervals. (Moisture and dust can lead to fire or electrical shock.)

# Frequently Asked Questions (FAQ)

If there is a problem with your TV, please refer to the table below to determine the symptoms, then carry out the suggested check. If this does not solve the problem, visit the Panasonic website for further assistance. (see cover)

Questions	Answers
<p><b>How do I view the picture from devices such as a: Cable/Satellite box, game console, Blu-ray or DVD player?</b></p>	<ul style="list-style-type: none"> <li>● Press the INPUT button on the remote to select the correct input source.</li> <li>● Check that the device is turned on and functioning correctly.</li> </ul>
<p><b>Why is there no picture or just a blue, black or snowy screen being displayed?</b></p>	<ul style="list-style-type: none"> <li>● Check if the power cord is plugged in and the TV is turned on (front red LED light should be on, not blinking).</li> <li>● Press the INPUT button on the remote to select the correct input source.</li> <li>● Ensure all connections are correct and secure. Especially check for Component and VIDEO connection since these terminals are shared.</li> <li>● When using external video source, such as a Cable/Satellite box or DVD player, check that the device is on and functioning correctly.</li> <li>● Press MENU on the TV's remote control. If the menu is displayed, then the TV is working; recheck above steps.</li> </ul>
<p><b>Why doesn't the picture look like it is in High-Definition?</b></p>	<ul style="list-style-type: none"> <li>● Press the INFO button on the remote to confirm the type of signal being received (p. 14). HD signal should be 720p, 1080i or 1080p.</li> <li>● Select a High Definition channel from your HD source (Cable, Satellite or fiber optic service). HD channels sometimes broadcast non-HD content.</li> <li>● Ensure that your HD source (HD box, Blu-ray player, etc.) is connected to the TV with an HDMI or Component cable and set to output an HD video signal.</li> </ul>
<p><b>Why do black bars appear on the top and bottom and/or sides of the screen?</b></p>	<ul style="list-style-type: none"> <li>● Change the format (aspect ratio) of the picture by pressing the FORMAT button on the remote control. (p. 15)</li> <li>● Check the aspect settings on your external video source, such as Cable/Satellite box, DVD/Blu-ray Disc player, etc. Note: Some content, such as film-based movies, are available in extra-wide format. Top and bottom bars are unavoidable.</li> </ul>
<p><b>Why is the picture snowy when "ANT/Cable in" is selected?</b></p>	<ul style="list-style-type: none"> <li>● When using a cable service (without a box), check that all connections are secure.</li> <li>● When using a cable or satellite box, change the connection (wiring) to Composite, Component or HDMI. (p. 11)</li> <li>● If you're using an antenna, then check that connections are secure. Change the position or direction of the antenna and check the "Signal meter". (p. 28)</li> </ul>
<p><b>Why is the picture chaotic and/or torn and/or with a buzz in the speakers?</b></p>	<ul style="list-style-type: none"> <li>● Check if electrical products such as kitchen appliances, fluorescent lights or light dimmers are nearby. They may interfere with the TV's picture.</li> <li>● Try viewing a picture from another device, such as a DVD player or a game console, to narrow down the source of the problem.</li> </ul>
<p><b>Why is there a black box on the screen?</b></p>	<ul style="list-style-type: none"> <li>● Change settings of Closed Caption (CC). (p. 14)</li> </ul>
<p><b>Why is the screen blank and the power indicator blinking?</b></p>	<ul style="list-style-type: none"> <li>● The TV has gone into shutdown mode to protect itself. Try unplugging it for a few minutes and connecting it again. If there was a temporary power surge on the AC line it may now be OK. If the blinking returns, call 1-877-95-VIERA (U.S.A.) or 1-866-330-0014 (Canada).</li> </ul>
<p><b>Why do some small spots on the screen remain bright or dark?</b></p>	<ul style="list-style-type: none"> <li>● The Plasma panel is made up of a few million pixels and is produced with advanced technology through an intricate process. Sometimes a few pixels may be bright or dark. These pixels do not indicate a defective panel and will have no impact on the performance of the TV.</li> </ul>
<p><b>Why is the picture brightness changing?</b></p>	<ul style="list-style-type: none"> <li>● Turn the C.A.T.S. feature off. Press MENU -&gt; Setup &gt; Picture &gt; C.A.T.S.</li> </ul>

Picture

● Frequently Asked Questions (FAQ)  
● Care and Cleaning

Support Information

	Questions	Answers
Sound	Why is there no sound coming from the TV?	<ul style="list-style-type: none"> <li>● Make sure the volume is up and MUTE is off.</li> <li>● Confirm the TV speakers are set to ON by pressing MENU and selecting "Audio" --&gt; "Advanced audio".</li> <li>● Check that the correct SAP (Secondary Audio Program) is selected by pressing the SAP button on the remote control. (p. 14)</li> <li>● If the TV is connected to a Panasonic Home Theater via HDMI cable, then check VIERA Link controls. (p. 26)</li> <li>● If the TV is connected to a Home Theater via optical cable, then: Check the connection, the audio system is on, the correct input is selected.</li> <li>● Check "HDMI 1 in" or "HDMI 2 in" analog/digital audio settings.</li> </ul>
	Why is the sound unusual, distorted, low volume or in another language?	<ul style="list-style-type: none"> <li>● Check that the correct SAP (Secondary Audio Program) is selected by pressing the SAP button on the remote control.</li> <li>● Check that all connections of external equipment connected to the TV are secure.</li> <li>● When using Cable or Satellite box, check the device's audio settings. (Example: try changing the box's Audio Range to 'narrow')</li> </ul>
	Why is there a clicking, ticking or buzzing sound coming from the TV unit?	<ul style="list-style-type: none"> <li>● When TV power is turned on or shut off, there are electrical components that make a click sound. This is normal operation.</li> <li>● Changes in the temperature and humidity of the room may cause thermal expansion and contraction that can produce sounds. This is not a sign of faulty operation or a malfunction.</li> </ul>
Other	What is the easiest and best way to connect a High-Definition Cable or Satellite box to the TV?	<ul style="list-style-type: none"> <li>● Use an HDMI cable. It carries both digital video and audio signal in HD. HDMI cable is the only cable needed to connect an HD device to the TV.</li> </ul>
	Why does the CC button not display Closed Caption?	<ul style="list-style-type: none"> <li>● When viewing TV via an HDMI connected device, such as a Cable or Satellite box, CC must be enabled at the device.</li> <li>● Closed Caption is available only at supported TV programming.</li> </ul>
	Why does the screen and back cover of the TV get warm?	<ul style="list-style-type: none"> <li>● The main unit radiates heat and some of the parts may become hot. This is normal operation and does not affect the performance of the set.</li> <li>● Ensure good ventilation.</li> <li>● Do not block the ventilation holes of the TV and do not place the TV on top of other equipment.</li> </ul>
	Why doesn't the Remote Control work?	<ul style="list-style-type: none"> <li>● Check that the batteries are fresh, are of the same type and are installed with the correct polarity (+ &amp; -).</li> <li>● To operate other devices, such as changing channels when using Cable, or Satellite boxes, or operating non-Panasonic Blu-ray players, use the remote supplied with the device.</li> </ul>
	Why is the "ANT/Cable" option at the top of the "Input select" menu grayed-out and unable to be selected?	<ul style="list-style-type: none"> <li>● During "First time setup", you indicated in ANT/Cable setup that you are using Cable or Satellite box and the box is connected to one of the TV's AV inputs. In this case, the Antenna/Cable input is deactivated to prevent unintentional switching into unused tuner. To re-activate, press MENU, select SETUP and repeat "First time setup".</li> </ul>
	Some menu items are grayed-out and unable to be selected. Why?	<ul style="list-style-type: none"> <li>● Depending on certain modes or the selected input, some options are not available. For example, Zoom adjustments are only available when the FORMAT is changed to zoom mode.</li> </ul>
	How do I reset my TV to all factory defaults and settings?	<ul style="list-style-type: none"> <li>● In the main menu, select "Setup". Highlight "Reset to defaults" and press OK. Enter your password (if created earlier) or create a temporary new password. Select Yes to reset the TV.</li> </ul>

# Specifications

		TC-P50U50
<b>Power Source</b>		AC 120 V, 60 Hz
<b>Power Consumption (Rated power / Standby power)</b>		332 W / 0.2 W
<b>Display Panel</b>	<b>Panel System</b>	Plasma Display panel
	<b>Screen size</b>	50 " class (49.9 inches measured diagonally)
	<b>W × H × Diagonal</b>	43.5 " × 24.4 " × 49.9 " (1,105 mm × 622 mm × 1,268 mm)
	<b>Number of pixels</b>	1,920 × 1,080
<b>Speaker Output</b>		20 W [10 W + 10 W] (10 % THD)
<b>Channel Capability (Digital/Analog)</b>		VHF/ UHF: 2 - 69, CATV: 1 - 135
<b>Operating Conditions</b>		Temperature: 32 °F - 104 °F (0 °C - 40 °C)      Humidity: 20 % - 80 % RH (non-condensing)
<b>Connection Terminals</b>	<b>VIDEO IN</b>	RCA PIN (VIDEO, AUDIO-L, AUDIO-R)
	<b>COMPONENT IN</b>	RCA PIN (Y, PB, PR, AUDIO-L, AUDIO-R)
	<b>HDMI IN 1/2</b>	TYPE A Connector (supports "HDAVI Control 5" function)
	<b>USB</b>	USB2.0 Type A connector
	<b>DIGITAL AUDIO OUT</b>	PCM / Dolby Digital, Fiber Optic
	<b>OTHERS</b>	SD CARD slot
<b>Dimensions</b>	<b>Including pedestal (W × H × D)</b>	46.6 " × 29.8 " × 10.5 " (1,184 mm × 757 mm × 266 mm)
	<b>TV Set only (W × H × D)</b>	46.6 " × 28.2 " × 3.3 " (1,184 mm × 716 mm × 82 mm)
<b>Mass</b>	<b>Including pedestal</b>	51.8 lb. (23.5 kg) NET
	<b>TV Set only</b>	49.6 lb. (22.5 kg) NET

## Note

- Design and Specifications are subject to change without notice. Mass and Dimensions shown are approximate.

# Index

<b>A</b>	Accessories .....	7
	Ant/Cable .....	27
	Antenna .....	10
	Auto Program.....	27
<b>B</b>	Battery .....	9
<b>C</b>	Cable .....	10,11
	Care & Cleaning .....	34
	CC Closed Caption .....	14,33
	Channel .....	14-15,27-28
	Channel Surf Mode.....	15
	Colored buttons .....	12
	Component .....	11
	Composite.....	11
	Connections.....	10-11
	Customer Service Directory.....	40
<b>E</b>	Exit.....	12
<b>F</b>	FAQ's .....	35-36
	Favorite .....	15
	First Time Setup.....	13
	Format .....	15,30
<b>H</b>	HDAVI Control.....	22
	HDMI.....	11,32
	Home Use.....	13
<b>I</b>	Info.....	14
	Input.....	16
<b>L</b>	language .....	13
	Last.....	12
	Lock / Parental control .....	30
<b>M</b>	Media player .....	17-21
	Menu .....	29
	Movies/Video .....	21
	Music .....	21
	Mute .....	12
<b>O</b>	Options menu .....	15
<b>P</b>	Pedestal.....	7-8
	Photo .....	19-20
	Power.....	12
<b>R</b>	Remote control .....	12
<b>S</b>	Safety.....	4
	SAP.....	14
	Scan.....	27
	SD Card .....	17,31-32
	Signal Meter.....	28
	Specifications.....	37
	Store Demonstration.....	13
<b>T</b>	Technical Information.....	30-33
<b>U</b>	USB .....	17,31-32
<b>V</b>	VIERA Link.....	22-26
	Viewing contents.....	18
	Volume.....	12
<b>W</b>	Warranty .....	39,41
	Watching TV, DVD, Blu-ray, etc. ....	14,16
<b>Z</b>	Zoom.....	15

# Limited Warranty (for U.S.A. and Puerto Rico only)

Panasonic Consumer Marketing Company of North America,  
Division of Panasonic Corporation of North America  
One Panasonic Way  
Secaucus, New Jersey 07094

## Panasonic Plasma Television Limited Warranty

### Limited Warranty Coverage

If your product does not work properly because of a defect in materials or workmanship, Panasonic Consumer Marketing Company of North America (referred to as "the warrantor") will, for the length of the period indicated on the chart below, which starts with the date of original purchase ("Limited Warranty period"), at its option either (a) repair your product with new or refurbished parts, (b) replace it with a new or a refurbished equivalent value product, or (c) refund your purchase price. The decision to repair, replace or refund will be made by the warrantor.

PLASMA TV CATEGORIES	PARTS	LABOR	SERVICE
Up to 42" (diagonal)	1 (ONE) YEAR	1 (ONE) YEAR	Carry-In
46" (diagonal) and larger			On-Site

During the "Labor" Limited Warranty period there will be no charge for labor. During the "Parts" Limited Warranty period, there will be no charge for parts.

You must carry-in your product or arrange for on-site service during the Limited Warranty period. If non-rechargeable batteries are included, they are not warranted. This Limited Warranty only applies to products purchased and serviced in the United States or Puerto Rico. This Limited Warranty is extended only to the original purchaser of a new product which was not sold "as is". A purchase receipt or other proof of the original purchase date is required for Limited Warranty service.

### On-Site or Carry-in Service

For On-Site or Carry-In Service in the United States and Puerto Rico call 1-877-95-VIERA (1-877-958-4372).

On-site service where applicable requires clear, complete and easy access to the product by the authorized servicer and does not include removal or re-installation of an installed product. It is possible that certain on-site repairs will not be completed on-site, but will require that the product or parts of the product, at the servicer's discretion be removed for shop diagnosis and/or repair and then returned.

### Limited Warranty Limits And Exclusions

This Limited Warranty ONLY COVERS failures due to defects in materials or workmanship, and DOES NOT COVER normal wear and tear or cosmetic damage, nor does it cover markings or retained images on the glass panel resulting from viewing fixed images (including, among other things, non-expanded standard 4:3 pictures on wide screen TV's, or onscreen data in a stationary and fixed location). The Limited Warranty ALSO DOES NOT COVER damages which occurred in shipment, or failures which are caused by products not supplied by the warrantor, or failures which result from accidents, misuse, abuse, neglect, bug infestation, mishandling, misapplication, alteration, faulty installation, set-up adjustments, misadjustment of consumer controls, improper maintenance, power line surge, lightning damage, modification, or commercial use (such as in a hotel, office, restaurant, or other business), rental use of the product, service by anyone other than a Factory Service Center or other Authorized Servicer, or damage that is attributable to acts of God.

**THERE ARE NO EXPRESS WARRANTIES EXCEPT AS LISTED UNDER "LIMITED WARRANTY COVERAGE". THE WARRANTOR IS NOT LIABLE FOR INCIDENTAL OR CONSEQUENTIAL DAMAGES RESULTING FROM THE USE OF THIS PRODUCT, OR ARISING OUT OF ANY BREACH OF THIS LIMITED WARRANTY.** (As examples, this excludes damages for lost time, cost of having someone remove or re-install an installed unit if applicable, or travel to and from the servicer. The items listed are not exclusive, but are for illustration only.) **ALL EXPRESS AND IMPLIED WARRANTIES, INCLUDING THE LIMITED WARRANTY OF MERCHANTABILITY, ARE LIMITED TO THE PERIOD OF THE LIMITED WARRANTY.**

Some states do not allow the exclusion or limitation of incidental or consequential damages, or limitations on how long an implied Limited Warranty lasts, so the exclusions may not apply to you.

This Limited Warranty gives you specific legal rights and you may also have others rights which vary from state to state. If a problem with this product develops during or after the Limited Warranty period, you may contact your dealer or Service Center. If the problem is not handled to your satisfaction, then write to the warrantor's Consumer Affairs Department at the addresses listed for the warrantor.

**PARTS AND SERVICE (INCLUDING COST OF AN ON-SITE SERVICE CALL, WHERE APPLICABLE) WHICH ARE NOT COVERED BY THIS LIMITED WARRANTY ARE YOUR RESPONSIBILITY.**



# Customer Services Directory (for U.S.A. and Puerto Rico)

## Customer Services Directory (United States and Puerto Rico)

Obtain Product Information and Operating Assistance; locate your nearest Dealer or Service Center; purchase Parts and Accessories; or make Customer Service and Literature requests by visiting our Web Site at:

<http://www.panasonic.com/help>

or, contact us via the web at:

<http://www.panasonic.com/contactinfo>

You may also contact us directly at:

1-877-95-VIERA (958-4372)

Monday-Friday 9 am-9 pm; Saturday-Sunday 10 am-7 pm, EST.

■ **For hearing or speech impaired TTY users, TTY: 1-877-833-8855**

## Accessory Purchases (United States and Puerto Rico)

Purchase Parts, Accessories and Instruction Books on line for all Panasonic Products by visiting our Web Site at:

<http://www.pstc.panasonic.com>

or, send your request by E-mail to:

[npcparts@us.panasonic.com](mailto:npcparts@us.panasonic.com)

You may also contact us directly at:

1-800-332-5368 (Phone) 1-800-237-9080 (Fax Only) (Monday - Friday 9 am to 9 pm, EST.)

**Panasonic National Parts Center**

20421 84th Avenue South,

Kent, WA 98032

(We Accept Visa, MasterCard, Discover Card, American Express, and Personal Checks)

■ **For hearing or speech impaired TTY users, TTY: 1-866-605-1277**

# Limited Warranty (for Canada)

**Panasonic Canada Inc.**  
5770 Ambler Drive, Mississauga, Ontario L4W 2T3  
**PANASONIC PRODUCT – LIMITED WARRANTY**

Panasonic Canada Inc. warrants this product to be free from defects in material and workmanship under normal use and for a period as stated below from the date of original purchase agrees to, at its option either (a) repair your product with new or refurbished parts, (b) replace it with a new or a refurbished equivalent value product, or (c) refund your purchase price. The decision to repair, replace or refund will be made by Panasonic Canada Inc.

<b>Viera TV (46" &amp; over)</b>	<b>In-home service</b>	<b>One (1) year, parts (including panel) and labour.</b>
<b>Viera TV (under 46")</b>	<b>Carry-in service</b>	<b>One (1) year, parts (including panel) and labour.</b>

In-home Service will be carried out only to locations accessible by roads and within 50 km of an authorized Panasonic service facility.

In-home service requires clear, complete and easy access to the product by the Authorized Servicer and does not include removal or re-installation of an installed product. If removal is required to service the product, it will be at the discretion of the Servicer and in no event will Panasonic Canada Inc. or the Servicer be liable for any special, indirect or consequential damages.

This warranty is given only to the original purchaser, or the person for whom it was purchased as a gift, of a Panasonic brand product mentioned above sold by an authorized Panasonic dealer in Canada and purchased and used in Canada, which product was not sold "as is", and which product was delivered to you in new condition in the original packaging.

**IN ORDER TO BE ELIGIBLE TO RECEIVE WARRANTY SERVICE HEREUNDER, A PURCHASE RECEIPT OR OTHER PROOF OF DATE OF ORIGINAL PURCHASE, SHOWING AMOUNT PAID AND PLACE OF PURCHASE IS REQUIRED**

## **LIMITATIONS AND EXCLUSIONS**

This warranty ONLY COVERS failures due to defects in materials or workmanship, and DOES NOT COVER normal wear and tear or cosmetic damage. The warranty ALSO DOES NOT COVER damages which occurred in shipment, or failures which are caused by products not supplied by Panasonic Canada Inc., or failures which result from accidents, misuse, abuse, neglect, mishandling, misapplication, alteration, faulty installation, set-up adjustments, misadjustment of consumer controls, improper maintenance, power line surge, lightning damage, modification, introduction of sand, humidity or liquids, commercial use such as hotel, office, restaurant, or other business or rental use of the product, or service by anyone other than a Authorized Servicer, or damage that is attributable to acts of God. Dry cell batteries are also excluded from coverage under this warranty.

THIS EXPRESS, LIMITED WARRANTY IS IN LIEU OF ALL OTHER WARRANTIES, EXPRESS OR IMPLIED, INCLUDING ANY IMPLIED WARRANTIES OF MERCHANTABILITY AND FITNESS FOR A PARTICULAR PURPOSE. IN NO EVENT WILL PANASONIC CANADA INC. BE LIABLE FOR ANY SPECIAL, INDIRECT OR CONSEQUENTIAL DAMAGES RESULTING FROM THE USE OF THIS PRODUCT OR ARISING OUT OF ANY BREACH OF ANY EXPRESS OR IMPLIED WARRANTY. (As examples, this warranty excludes damages for lost time, travel to and from the Authorized Servicer, loss of or damage to media or images, data or other memory or recorded content. This list of items is not exhaustive, but for illustration only.)

In certain instances, some jurisdictions do not allow the exclusion or limitation of incidental or consequential damages, or the exclusion of implied warranties, so the above limitations and exclusions may not be applicable. This warranty gives you specific legal rights and you may have other rights which vary depending on your province or territory.

## **WARRANTY SERVICE**

**For product operation and information assistance, please contact:**

Our Customer Care Centre: 1-800 #: 1-866-330-0014  
or visit our website: <https://conciierge.panasonic.ca>

**For product repairs, please contact Viera Customer Care Agent using the above contact info.**

## **IF YOU SHIP THE PRODUCT TO A SERVICENTRE**

Carefully pack and send prepaid, adequately insured and preferably in the original carton.  
Include details of the defect claimed, and proof of date of original purchase.