

Panasonic®

Model No.
Número de modelo

TC-P55VT60
TC-P60VT60
TC-P65VT60



Scan, watch and discover how to get the most out of your TV

Escanee, observe y descubra como obtener el máximo de su TV

<http://SCN.BY/9T9AB0HTW8JBJT>

Owner's Manual

55"/60"/65" Class 1080p Plasma HDTV
(55,1/60,1/64,7 inches measured diagonally)

Manual de usuario

Televisión de alta definición de 1080p
y clase 55"/60"/65" de Plasma
(55,1/60,1/64,7 pulgadas medidas diagonalmente)

VIERA

For assistance (U.S.A./Puerto Rico), please call:
1-877-95-VIERA (958-4372)
www.panasonic.com/help

For assistance (Canada), please call:
1-866-330-0014
conciERGE.panasonic.ca

Para solicitar ayuda (EE.UU./Puerto Rico), llame al:
1-877-95-VIERA (958-4372)
www.panasonic.com/help



**Built-in Manual
manual electrónico**

Register online at
www.panasonic.com/register
(U.S. customers only)

English

Thank you for purchasing this Panasonic product. Please read these instructions before operating your set and retain them for future reference. The images shown in this manual are for illustrative purposes only.

Español

Gracias por su decisión de comprar este producto marca Panasonic. Lea estas instrucciones antes de utilizar su televisor y guárdelas para consultarlas en el futuro. Las imágenes mostradas en este manual tienen solamente fines ilustrativos.



TQB2AA0707-1

This product incorporates the following software:

- (1) the software developed independently by or for Panasonic Corporation,
- (2) the software owned by third party and licensed to Panasonic Corporation,
- (3) the software licensed under the GNU LESSER GENERAL PUBLIC LICENSE Version 2.1 (LGPL V2.1) and/or,
- (4) open sourced software other than the software licensed under the LGPL V2.1.

The software categorized as (3) and (4) are distributed in the hope that it will be useful, but WITHOUT ANY WARRANTY, without even the implied warranty of MERCHANTABILITY or FITNESS FOR A PARTICULAR PURPOSE. Please refer to the detailed terms and conditions thereof shown in the "License" menu on this product.

At least three (3) years from delivery of this product, Panasonic will give to any third party who contacts us at the contact information provided below, for a charge no more than our cost of physically performing source code distribution, a complete machine-readable copy of the corresponding source code covered under LGPL V2.1 or the other licenses with the obligation to do so, as well as the respective copyright notice thereof.
Contact Information : cdrequest@unipf.jp

The source code and the copyright notice are also available for free in our website below.
<http://www.unipf.jp/dl/DTV13U/>

"PlayReady" is a trademark registered by Microsoft. Please be aware of the following.

- (a) This product contains technology subject to certain intellectual property rights of Microsoft. Use or distribution of this technology outside of this product is prohibited without the appropriate license(s) from Microsoft.
- (b) Content owners use Microsoft PlayReady™ content access technology to protect their intellectual property, including copyrighted content. This device uses PlayReady technology to access PlayReady-protected content and/or WMDRM-protected content. If the device fails to properly enforce restrictions on content usage, content owners may require Microsoft to revoke the device's ability to consume PlayReady-protected content. Revocation should not affect unprotected content or content protected by other content access technologies. Content owners may require you to upgrade PlayReady to access their content. If you decline an upgrade, you will not be able to access content that requires the upgrade.

This product is licensed under the AVC patent portfolio license for the personal and non-commercial use of a consumer to (i) encode video in compliance with the AVC Standard ("AVC Video") and/or (ii) decode AVC Video that was encoded by a consumer engaged in a personal and non-commercial activity and/or was obtained from a video provider licensed to provide AVC Video. No license is granted or shall be implied for any other use. Additional information may be obtained from MPEG LA, LLC.
See <http://www.mpegla.com>.

■ Do not display a still picture for a long time

This causes the image to remain on the plasma screen ("Image retention").
This is not considered a malfunction and is not covered by the warranty.



To prevent the "Image retention", the screen saver is automatically activated after a few minutes if no signals are sent or no operations are performed.

Typical still images

- Channel number and other logos
- Image displayed in 4:3 mode
- Video game

■ Set up

- Do not place the unit where it's exposed to sunlight or other bright light (including reflections).
- Use of some types of fluorescent lighting may reduce the remote control's transmission range.

VIERA Link™ VIERA Link™ is a trademark of Panasonic Corporation.

HDMI

HDMI, the HDMI logo and High-Definition Multimedia Interface are trademarks or registered trademarks of HDMI Licensing LLC in the United States and other countries.



SDXC Logo is a trademark of SD-3C, LLC.

AVCHD™

“AVCHD” and the “AVCHD” logo are trademarks of Panasonic Corporation and Sony Corporation.



DLNA®, the DLNA Logo and DLNA CERTIFIED™ are trademarks, service marks, or certification marks of the Digital Living Network Alliance.

RealD 3D

“RealD 3D” is a trademark of RealD.

**FULL HD 3D
GLASSES**

“Full HD 3D Glasses™” logo and “Full HD 3D Glasses™” word are trademark of Full HD 3D Glasses Initiative.



Manufactured under license under U.S. Patent Nos: 5,956,674; 5,974,380; 6,487,535 & other U.S. and worldwide patents issued & pending. DTS, the Symbol, & DTS and the Symbol together are registered trademarks & DTS 2.0+Digital Out is a trademark of DTS, Inc. Product includes software. © DTS, Inc. All Rights Reserved.



Manufactured under license from Dolby Laboratories. Dolby and the double-D symbol are trademarks of Dolby Laboratories.



Speech Powered by Dragon 2002-2013 Nuance Communications, Inc. All rights reserved.

HDAVI Control™ is a trademark of Panasonic Corporation.

The Bluetooth® word mark and logos are registered trademarks owned by Bluetooth SIG, Inc. and any use of such marks by Panasonic Corporation is under license. Other trademarks and trade names are those of their respective owners.

Skype™ is a trademark of Skype limited.



Contents

Please read before using the unit

- Safety Precautions 4
- Accessories/Optional Accessories 9
- Connections 13
- Identifying Controls 17
- First Time Setup 20
- Operations 21
- Using eHELP (Built-in Manual) 22
- Viewing 3D images on TV 23
- Frequently Asked Questions (FAQ) 25
- Care and Cleaning 26
- Specifications 27
- Limited Warranty (for U.S.A. and Puerto Rico only) 29
- Customer Services Directory (for U.S.A. and Puerto Rico) 30
- Limited Warranty (for Canada) 31



Safety Precautions



WARNING: To reduce the risk of electric shock, do not remove cover or back. No user-serviceable parts inside. Refer servicing to qualified service personnel.



The lightning flash with arrowhead within a triangle is intended to tell the user that parts inside the product are at risk of electric shock to persons.

The exclamation point within a triangle is intended to tell the user that important operating and servicing instructions are in the papers with the appliance.

WARNING: To reduce the risk of fire or electric shock, do not expose this apparatus to rain or moisture. Do not place liquid containers (flower vase, cups, cosmetics, etc.) above the set (including on shelves above, etc.).

Important Safety Instructions

- 1) Read these instructions.
- 2) Keep these instructions.
- 3) Heed all warnings.
- 4) Follow all instructions.
- 5) Do not use this apparatus near water.
- 6) Clean only with dry cloth.
- 7) Do not block any ventilation openings. Install in accordance with the manufacturer's instructions.
- 8) Do not install near any heat sources such as radiators, heat registers, stoves, or other apparatus (including amplifiers) that produce heat.
- 9) Do not defeat the safety purpose of the polarized or grounding-type plug. A polarized plug has two blades with one wider than the other. A grounding type plug has two blades and a third grounding prong. The wide blade or the third prong are provided for your safety. If the provided plug does not fit into your outlet, consult an electrician for replacement of the obsolete outlet.
- 10) Protect the power cord from being walked on or pinched particularly at plugs, convenience receptacles, and the point where they exit from the apparatus.
- 11) Only use attachments / accessories specified by the manufacturer.
- 12) Use only with the cart, stand, tripod, bracket, or table specified by the manufacturer, or sold with the apparatus. When a cart is used, use caution when moving the cart / apparatus combination to avoid injury from tip-over.
- 13) Unplug this apparatus during lightning storms or when unused for long periods of time.
- 14) Refer all servicing to qualified service personnel. Servicing is required when the apparatus has been damaged in any way, such as power-supply cord or plug is damaged, liquid has been spilled or objects have fallen into the apparatus, the apparatus has been exposed to rain or moisture, does not operate normally, or has been dropped.
- 15) To prevent electric shock, ensure the grounding pin on the AC cord power plug is securely connected.



WARNING/CAUTION (TV set)



Small parts can present choking hazard if accidentally swallowed. Keep small parts away from young children. Discard unneeded small parts and other objects, including packaging materials and plastic bags/sheets to prevent them from being played with by young children, creating the potential risk of suffocation.

■ Set up

This Plasma TV may fall and can cause personal injury or even death if not installed correctly. To prevent personal injury or death, follow these warnings:

- **Install the Plasma TV in accordance with the manufacturer's recommended pedestal or stand, corresponding hardware and installation instructions.**

This Plasma TV is for use only with the following

optional accessories. Use with any other type of optional accessories may cause instability. The following accessories are manufactured by Panasonic Corporation.

- Wall-hanging bracket (Angled)
TY-WK5P1RW (TC-P55VT60, TC-P60VT60)
TY-WK6P1RW (TC-P65VT60)

- **Be sure to ask a qualified technician to carry out the installation and set-up.** Two or more people are required to install or remove the television.
- **Some wall mounts (wall-hanging brackets) are not designed to be mounted to walls with steel studs or old cinder block constructions.** Ask your dealer or licensed contractor to properly secure the wall-hanging bracket.
- **Do not route the TV's power cord inside the wall.** The power cord was not designed for in-wall mounting. Doing so can lead to fire hazard.

- **Do not place the Plasma TV or its stand on a sloped or unstable surface.**
The Plasma TV may fall or tip over.
- **Do not support the Plasma TV on a non-specified pedestal.**
- **Do not place the Plasma TV on furniture that can easily be used as steps, such as a chest of drawers.**
- **Do not climb or allow children to climb on the Plasma TV**
- **Place or install the Plasma TV where it cannot be pushed, pulled over or knocked down.**
- **Route all cords and cables such that they cannot be tripped over or pulled by curious children.**
- **Do not place any objects on top of the Plasma TV.**
If water spills onto the Plasma TV or foreign objects get inside it, a short-circuit may occur, which could result in fire or electric shock. If any foreign objects get inside the Plasma TV, please consult an Authorized Service Center.
- **In the unlikely event that you receive a shock from this product, it is possible that your household outlet may be wired improperly.**
Have an electrician verify that the TV's outlet is properly wired. If the symptom persists, have the TV serviced by a qualified authorized technician.
- **To prevent the spread of fire, keep candles or other open flames away from this product at all times**



■ AC Power Supply Cord

To prevent fire or electric shock:

- **The Plasma TV is designed to operate on a 120 V AC, 60 Hz service. Insert the power cord plug as far as it will go into the wall socket.**
If the plug is not fully inserted, heat may generate, which could cause a fire.
- **The included power cord is for use with this unit only.**
- **Do not use any power cord other than that provided with this TV.**
- **Do not handle the power cord plug with wet hands.**
- **Do not do anything that might damage the power supply cord.**
- **When disconnecting the power supply cord, hold the plug, not the cord.**
- **Do not use the power supply cord if the plug or cord is damaged.**
Replace the cord or contact your Authorized Service Center.
- **Do not use a 3-prong to 2-prong AC plug adapters to connect your TV's plug to the wall outlet.**
Doing so will defeat the TV plug's safety feature, which can lead to a shock hazard. If the wall outlet does not accommodate a 3-prong plug, have a qualified electrician replace your outlet and check the associated wiring.
- **If water or an object gets inside the Plasma TV, if the Plasma TV is dropped, or if the enclosure becomes damaged, unplug the power supply cord immediately.**
A short-circuit may occur, which could cause a fire. Contact an Authorized Service Center for an evaluation.

■ Radio waves

- **Do not place this TV in any medical institutions or locations with medical devices.**
Radio waves from this TV may interfere with the medical devices and cause accidents due to the malfunction.

- **Do not use this TV near any automatic control devices such as automatic doors or fire alarms.**
Radio waves from this TV may interfere with the automatic control devices and cause accidents due to the malfunction.
- **Keep this TV away at least 9 inches (22 cm) from the location where a cardiac pacemaker is implanted.**
Radio waves from this TV may interfere with the operation of the pacemaker.

■ Handling the power supply cord

- **Insert the power plug fully into the socket outlet. (If the power plug is loose, it could generate heat and cause fire.)**
- **Ensure that the power plug is easily accessible.**
- **Ensure the earth pin on the power plug is securely connected to prevent electrical shock.**
 - An apparatus with CLASS I construction shall be connected to a power socket outlet with a protective earthing connection.
- **Do not touch the power plug with a wet hand. (This may cause electrical shock.)**
- **Do not use any power cord other than that provided with this TV. (This may cause fire or electrical shock.)**
- **Do not damage the power cord. (A damaged cord may cause fire or electrical shock.)**
 - Do not move the TV with the cord plugged in the socket outlet.
 - Do not place a heavy object on the cord or place the cord near a high-temperature object.
 - Do not twist the cord, bend it excessively, or stretch it.
 - Do not pull on the cord. Hold onto the power plug body when disconnecting cord.
 - Do not use a damaged power plug or socket outlet.
- **If a problem occurs (such as no picture or no sound), or if smoke or an abnormal odor is detected from the Plasma TV, unplug the power supply cord immediately.**
Continued use of the TV under these conditions might cause a fire or permanent damage to the TV. Have the TV evaluated by an Authorized Service Center. Servicing of the TV by unauthorized personnel is strongly discouraged due to its high voltage.

CAUTION

- **Do not cover the ventilation holes.**
Doing so may cause the Plasma TV to overheat, which can cause a fire or damage to the Plasma TV.
- **Leave a space of 3 15/16" (10 cm) or more at the top, left and right, and 2 3/4" (7 cm) or more at the rear.**
- **When using the pedestal, keep the space between the bottom of the TV and the pedestal or stand surface clear from objects that may obstruct ventilation.**
- **When Moving the Plasma TV**
 - **Be sure to disconnect all cables before moving the Plasma TV.**
Moving the TV with its cables attached might damage the cables which, in turn, can cause fire or electric shock.
 - **To prevent an electric shock, disconnect the power plug from the wall outlet as a safety precaution before carrying out any cleaning.**
 - **Transport only in upright position.**
Transporting the unit with its display panel facing upright or downward may cause damage to the internal circuitry.
 - **Using a dry cloth, clean any dust from the power supply cord and plug regularly.**
Build-up of dust on the power cord plug can increase humidity, which might damage the insulation and cause a fire.

This Plasma TV radiates infrared rays; therefore, it may affect other infrared communication equipment. Install your infrared sensor in a place away from direct or reflected light from your Plasma TV.
The TV will still consume some power as long as the power supply cord is connected to the wall outlet.

- **Display panel is made of glass. Do not apply strong force or impact to the display panel.**
This may cause damage resulting in injury.
- **The TV is heavy. TV should be handled by 2 or more people. Support as shown to avoid injury by the TV tipping or falling.**

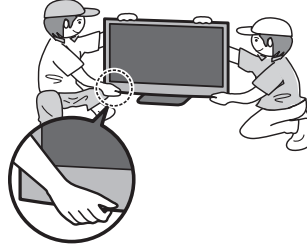

WARNING/CAUTION (3D Eyewear)

WARNING

■ Accidental Ingestion

- **Keep 3D Eyewear parts in places out of the reach of children.**
There is a danger small children could swallow such parts by mistake.
 - If a child accidentally swallows such parts, seek immediate medical attention.

■ Place

- **Do not use 3D Eyewear in hospital or other medical facilities.**
Radio waves from 3D Eyewear may cause interference of medical equipments.
- **Do not use 3D Eyewear nearby automatic control equipments, like an automatic door, a fire alarm apparatus, etc.**
Radio waves from 3D Eyewear may cause interference of automatic control equipments.
- **Keep 3D Eyewear more than 9 inches (22 cm) away from the implant of cardiac pacemaker, or similar implantable medical equipments, at all times.**
Radio waves from 3D Eyewear may affect implantable cardiac pacemaker or similar equipment operations.

■ Disassembly

- **Do not disassemble or modify the 3D Eyewear.**

■ About lithium battery

- **Batteries must not be exposed to excessive heat such as sunshine, fire or the like.**

CAUTION

■ 3D Eyewear

- **Handle the 3D Eyewear carefully and store in the case when not in use.**
Failure to do so may damage the Eyewear and glass section, which may result in injury.
- **Handle the tips of the frame carefully when**

putting on the 3D Eyewear as inserting the tip of the frame into the eye may cause injury.

- **Be careful not to close the hinge section of the 3D Eyewear on your finger.**
Doing so may result in injury.
 - Provide supervision when children are using this product.

■ Use of 3D Eyewear

- **Parents/guardians should monitor children's viewing habits to avoid their prolonged use without rest periods.**
- **In commercial application and public viewing, someone in authority should convey the precautions and monitor the user of the 3D Eyewear.**
- **Use only the 3D Eyewear recommended for this TV.**
- **Only use the 3D Eyewear for its intended 3D content viewing purpose.**
- **Do not move around while wearing the 3D Eyewear.**
The surrounding area appears dark, which may result in falling or other accidents that may cause injury.
- **Inspect the 3D Eyewear for damage before each use.**

■ Viewing of 3D Images

- **In the event that you experience dizziness, nausea, or other discomfort while viewing 3D images, discontinue use and rest your eyes.**
 - When you set the effect by using "3D adjustment", take into account that the vision of 3D images varies among different individuals.
- **Do not use if the 3D Eyewear is cracked or broken.**
- **Content for 3D viewing includes commercially available Blu-ray discs, 3D broadcasts, etc.**
- **When preparing your own 3D content, ensure that it is properly produced.**

■ About lithium battery

- **Danger of explosion if battery is incorrectly replaced.**
Replace only with the same or equivalent type (coin-shaped lithium battery CR2025).

FCC and IC STATEMENT

This equipment has been tested and found to comply with the limits for an Other Class B digital device, pursuant to Part 15 of the FCC Rules. These limits are designed to provide reasonable protection against harmful interference in a residential installation. This equipment generates, uses and can radiate radio frequency energy and, if not installed and used in accordance with the instructions, may cause harmful interference to radio communications. However, there is no guarantee that interference will not occur in a particular installation. If this equipment does cause harmful interference to radio or television reception, which can be determined by turning the equipment off and on, the user is encouraged to try to correct the interference by one or more of the following measures:

- Reorient or relocate the receiving antenna.
- Increase the separation between the equipment and receiver.
- Connect the equipment into an outlet on a circuit different from that to which the receiver is connected.
- Consult the Panasonic Service Center or an experienced radio/TV technician for help.

FCC Caution:

To assure continued compliance, follow the attached installation instructions and use only shielded interface cables when connecting to peripheral devices. Any changes or modifications not expressly approved by Panasonic Corp. of North America could void the user's authority to operate this device.

FCC and Industry Canada (IC) RF Exposure Warning :

- This TV is provided with two built-in transmitters: (1) Wireless LAN Adapter with FCC ID:H8N-WLU5150/ IC ID:1353A-WLU5150; and (2) Bluetooth Adapter with FCC ID:NKR-P705/IC ID:4441A-P705.
- These transmitters comply with FCC and IC radiation exposure limits set forth for an uncontrolled environment for mobile use with minimum 8 inches (20 cm) spacing requirement between transmitters and all person's body (excluding extremities of hands, wrist and feet) during wireless modes of operation.
- This TV may also be provided with : (1) 3D Eyewear approved under FCC ID: OHP-SIRIUS / IC ID:7702B-SIRIUS (2) VIERA Touch Pad Controller approved under FCC ID: MG3-0602284 / IC ID:2575A-0602284.
- Other third-party wireless transmitters should not be used as they have not been RF exposure evaluated for use with this TV and may not comply with RF exposure requirements.

<Only for wireless LAN if capable of transmission in the 5.15 ~ 5.25 GHz frequency band>

This product is restricted to indoor use due to its operation in the 5.15 to 5.25 GHz frequency range.

FCC and IC require this product to be used indoors for the frequency range 5.15 to 5.25 GHz to reduce the potential for harmful interference to co-channel Mobile Satellite systems. High power radars are allocated as primary users of the 5.25 to 5.35 GHz and 5.65 to 5.85 GHz bands. These radar stations can cause interference with and/or damage this product.

Responsible Party:	Panasonic Corporation of North America One Panasonic Way, Secaucus, NJ 07094
Contact Source:	Panasonic Consumer Marketing Company of North America 1-877-95-VIERA (958-4372)
email:	consumerproducts@panasonic.com

This device complies with Part 15 of the FCC Rules and all applicable IC RSS standards.

Operation is subject to the following two conditions:

(1) This device may not cause harmful interference, and (2) this device must accept any interference received, including interference that may cause undesired operation.

■ About built-in wireless LAN/Bluetooth

- To use the built-in wireless LAN, using an access point is recommended.
- To use the built-in wireless LAN in the access point mode, up to 7 devices are connectable. But the transfer rate will vary according to communication environment or connected equipments.
- Do not use the built-in wireless LAN to connect to any wireless network (SSID*) for which you do not have usage rights. Such networks may be listed as a result of searches. However, using them may be regarded as illegal access.
- Check that the Access point supports WPS*2.
(If it does not support WPS, the encryption key of the Access point is required when configuring settings.)
- Follow the instructions on the Access point setup screen and configure the appropriate security settings. For more details on setting of Access point, please refer to operating manual for the Access point.
- We recommend using 11n (5 GHz) for the wireless system between the built-in wireless LAN and Access point. Communication is also possible with 11a, 11b, and 11g, but the communication speed may be slower.
- If the wireless system of the Access point is changed, devices that could connect by wireless LAN may no longer be able to connect.
- Data transmitted and received over radio waves may be intercepted and monitored.
- Keep the TV away from the following devices as much as possible:
Wireless LAN, microwaves, and other devices that use 2.4 GHz and 5 GHz signals. Otherwise, the TV failures such as malfunction may occur due to the radio wave interference.
- When noises occur due to the static electricity, etc., the TV might stop operating for the protection of the devices. In this case, turn the TV Off with power On / Off switch, then turn it On again.

*1 SSID is a name for identifying a particular wireless network for transmission.

*2 WPS: Wi-Fi Protected Setup

WARNING

Flat panel displays are not always supported on the proper stands or installed according to the manufacturer's recommendations. Flat panel displays that are inappropriately situated on dressers, bookcases, shelves, desks, speakers, chests, or carts may fall over and may cause personal injury or even death.

The consumer electronics industry (of which Panasonic is a member) is committed to making home entertainment enjoyable and safe. To prevent personal injury or death, be sure to follow the following safety guidelines:

TUNE INTO SAFETY:

- One size does NOT fit all. Follow the manufacturer's recommendations for the safe installation and use of your flat panel display.
- Carefully read and understand all enclosed instructions for proper use of this product.
- Don't allow children to climb on or play with furniture and television sets.
- Don't place flat panel displays on furniture that can easily be used as steps, such as a chest of drawers.
- Remember that children can become excited while watching a program, especially on "larger than life" flat panel displays. Care should be taken to install the display where it cannot be pushed, pulled over, or knocked down.
- Care should be taken to route all cords and cables connected to the flat panel display so that they cannot be pulled or grabbed by curious children.

WALL MOUNTING: IF YOU DECIDE TO WALL MOUNT YOUR FLAT PANEL DISPLAY, ALWAYS:

- Use a mount that has been recommended by the display manufacturer and/or listed by an independent laboratory (such as UL, CSA, ETL).
- Follow all instructions supplied by the display and wall mount manufacturers.
- If you have any doubts about your ability to safely install your flat panel display, contact your retailer about professional installation.
- Make sure the wall where you are mounting the display is appropriate. Some wall mounts are not designed to be mounted to walls with steel studs or old cinder block construction. If you are unsure, contact a professional installer.
- A minimum of two people are required for installation. Flat panel displays can be heavy.

Panasonic recommends that a qualified installer perform the wall-mount installation. See page 4.

The American Academy of Pediatrics discourages media viewing for children younger than two years. For more details, see www.aap.org.



Accessories/Optional Accessories

Accessories

Check that all the following items have been included with your TV

- Remote Control
 ● N2QAYB000862
- VIERA Touch Pad Controller
 ● N2QBYB000026
- Batteries (4)
 ● AA Battery
- Pedestal
 ● Assembly (p. 11)
- Power cord

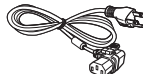
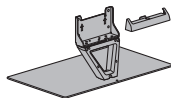

- 3D Eyewear (2)
 (Battery type:
 included CR2025 battery (1))



- Cable tie



- Owner's Manual
 Quick start guide
 Child safety
 Product Registration Card (U.S.A.)

Optional Accessories

Please contact your nearest Panasonic dealer to purchase the recommended optional accessories. For additional details, please refer to the optional accessories installation manual.

Electronic Touch Pen This device provides you to paint or play games on the TV screen.

- TY-TP10U

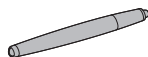

- Available only for specific applications.
- This TV can be paired with up to 2 Touch Pens simultaneously. (Pairing condition may differ depending on the registration status for each Bluetooth device.)

3D Eyewear

(Rechargeable type)

- TY-ER3D4SU
 ● TY-ER3D4MU



- Use Panasonic 3D Eyewear supporting Bluetooth wireless technology.
- Product information (Model No. and release date etc.) is subject to change without notice.
- For more product information (USA) <http://www.panasonic.com> (Canada) <http://panasonic.ca> (Global reference) <http://panasonic.net/avc/viera>

Wall-hanging bracket

- TY-WK5P1RW (55"/60") **Back of the TV**
 ● TY-WK6P1RW (65")

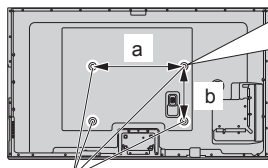
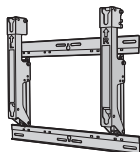

screws for attaching the TV to the wall-hanging bracket (not supplied with the TV)

(View from the side)

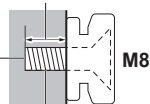

Depth of screw:
Minimum: 0.67" (17.0 mm)
Maximum: 0.91" (23.0 mm)

(image)

- Tilting angle for this TV:
 (for 55")
 0 (vertical) to 15 degrees
 (for 60")
 0 (vertical) to 20 degrees
 (for 65")
 0 (vertical) to 10 degrees

Holes for wall-hanging bracket installation

- (55"/60")
 a: 19.7" (500 mm)
 b: 11.8" (300 mm)
 (65")
 a: 26.9" (684 mm)
 b: 11.8" (300 mm)

Warning

- In order to maintain the TV's performance and safety, be absolutely sure to ask your dealer or a licensed contractor to secure the wall-hanging brackets.
- Carefully read the instructions accompanying optional accessories, and be absolutely sure to take steps to prevent the TV from tipping over.
- Do not mount the unit directly below ceiling lights (such as spotlights, floodlights or halogen lights) that typically give off high heat. Doing so may warp or damage plastic cabinet parts.
- Handle the TV carefully during installation since subjecting it to impact or other forces may cause product damage.
- Take care when fixing wall brackets to the wall. Always ensure that there are no electrical cables or pipes in the wall before hanging the bracket.
- When using the angled-type wall-hanging bracket, please ensure that there is sufficient space for the connecting cables not to press against the wall when the TV is tilted forward.
- To prevent fall and injury, remove the TV from its fixed wall position when it is no longer in use.

Attaching the pedestal to TV

(A) Assembly screws (Black) (8)



(C) Bracket



(E) Cover

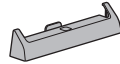

(B) Assembly screws (Black) (1)



(D) Base

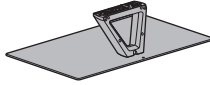

(F) Cable clamps (4)

- Cable binding instructions (p. 16)

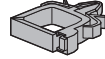

Attaching the pedestal

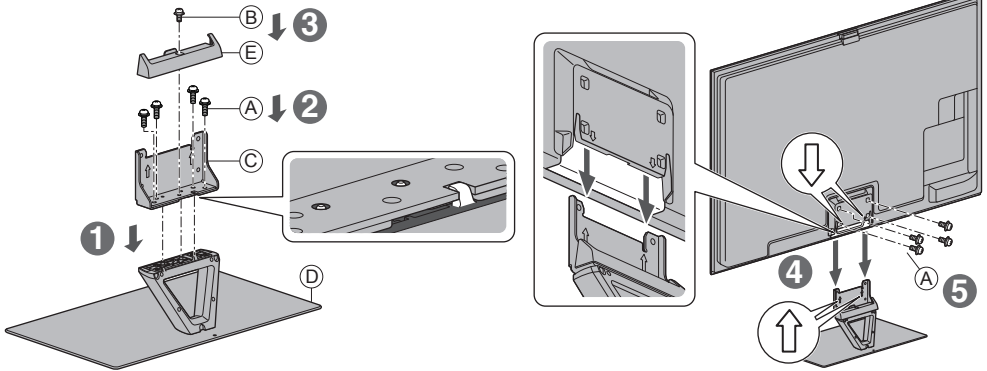

Removing the pedestal from the TV

Be sure to remove the pedestal in the following way when using the wall-hanging bracket or repacking the TV.

- ① Remove the assembly screws (A) from the TV.
- ② Lift the TV from the pedestal.
- ③ Remove the assembly screw (B) from the cover.
- ④ Pull out the cover.
- ⑤ Remove the assembly screws (A) from the bracket.

Warning

Do not disassemble or modify the pedestal.

- Otherwise, the TV may fall over and become damaged, and personal injury may result.

Caution

Do not use any pedestal other than that provided with this TV.

- Otherwise, the TV may fall over and become damaged, and personal injury may result.

Do not use the pedestal if it becomes warped or physically damaged.

- If you use the pedestal when it is physically damaged, personal injury may result. Contact your nearest Panasonic Dealer immediately.

During set-up, make sure that all screws are securely tightened.

- If sufficient care is not taken to ensure screws are properly tightened during assembly, the pedestal will not be strong enough to support the TV, and it might fall over and become damaged, and personal injury may result.

When removing the pedestal, do not remove the pedestal by any methods other than the specified procedure. (Above)

- Otherwise, the TV and/or pedestal may fall over and become damaged, and personal injury may result.

Installing the remote's batteries

■ Remote Control

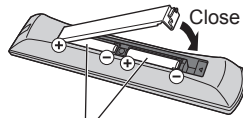
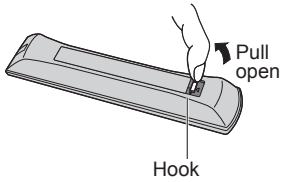

Note the correct polarity (+ or -).

■ VIERA Touch Pad Controller

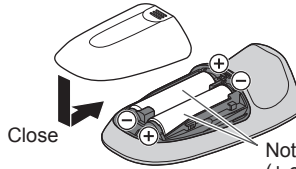
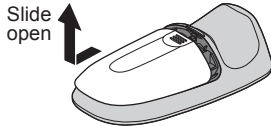

Caution

- Incorrect installation may cause battery leakage and corrosion, resulting in damage to the remote control.
 - Do not mix old and new batteries.
 - Do not mix different battery types (such as alkaline and manganese batteries).
 - Do not use rechargeable (Ni-Cd) batteries.
- Do not burn or break batteries.

Connections

Connection Panels

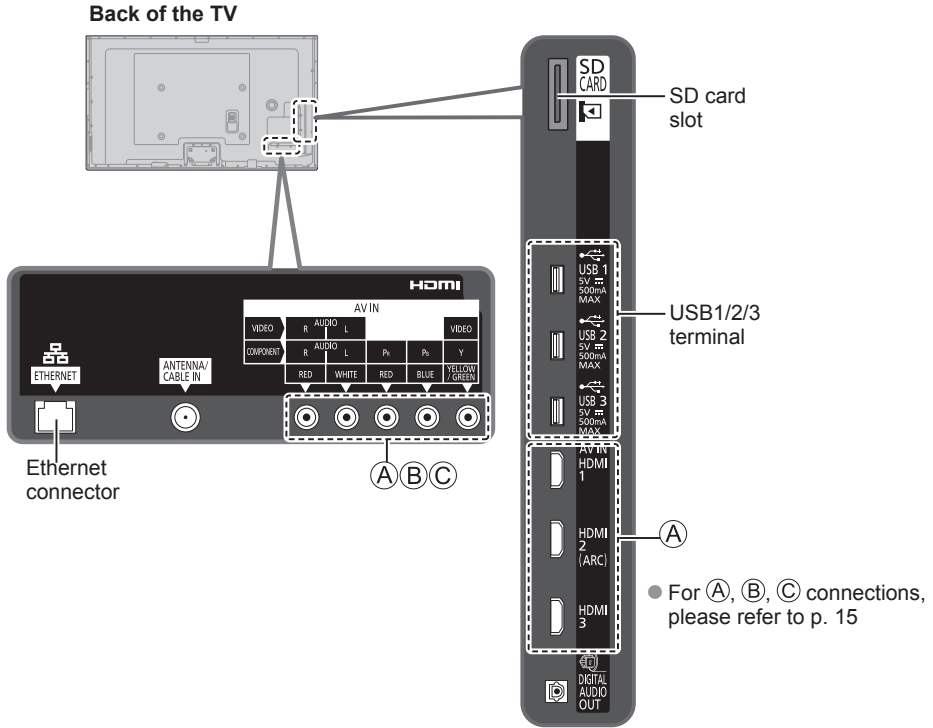

Antenna or Cable connection

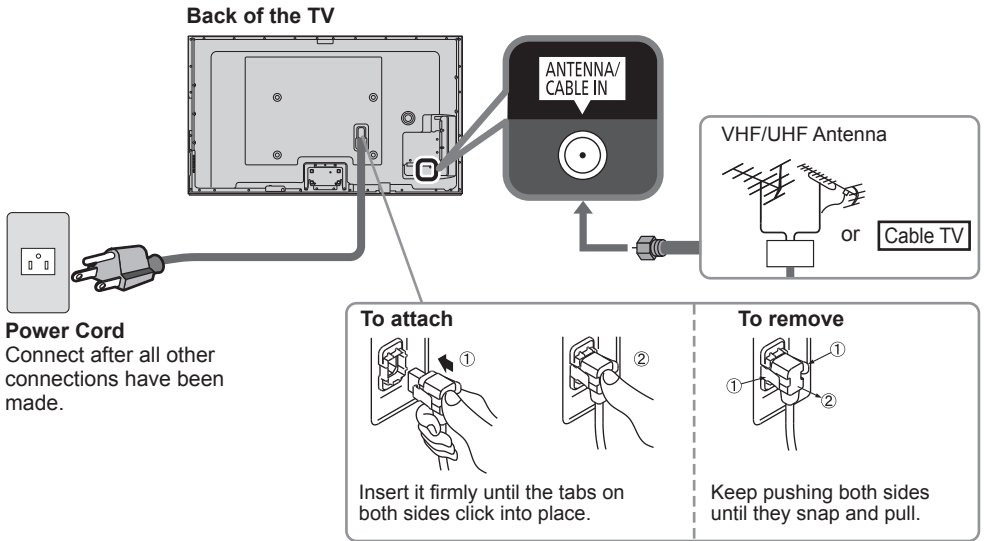

VHF/UHF Antenna

- NTSC (National Television System Committee): Analog television system

ATSC (Advanced Television Systems Committee):

Digital TV Standards include digital high-definition television (HDTV), standard-definition television (SDTV), data broadcasting, multi-channel surround sound audio and interactive television.

Cable

- You need to subscribe to a cable TV service to enjoy viewing their programming.
- A high-definition connection can be made using an HDMI or Component Video cable. (p. 15)

Note

- When using a Cable box, external equipment and video cables shown in this manual are not supplied with the TV.
- For additional assistance, visit us at: www.panasonic.com/help
www.panasonic.ca

AV cable connection

Best

A To use HDMI terminals (Set-top-box / DVD recorder / Blu-ray Disc player / Camcorder / etc.)

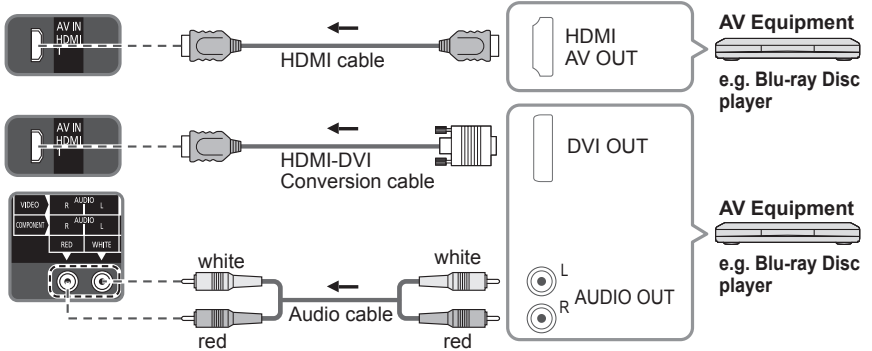

Good

B To use COMPONENT terminals (DVD recorder / Blu-ray Disc player / etc.)

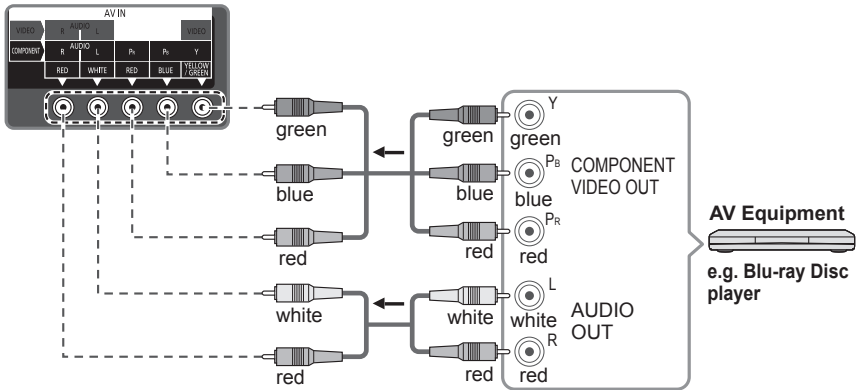

Basic
(Not HD)

C To use COMPOSITE terminals (Camcorder / Game system / DVD recorder / etc.)

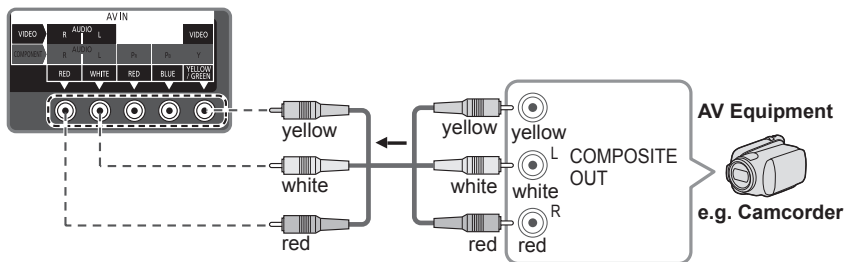

Note

- In some cases, it is not possible to connect depending on the type of cable or equipment.
- The Green terminal is shared for both the COMPONENT and COMPOSITE (VIDEO IN) connection. When using COMPOSITE (VIDEO IN) connection, the Yellow connector (Video) should be inserted into Green connection.

Audio connection

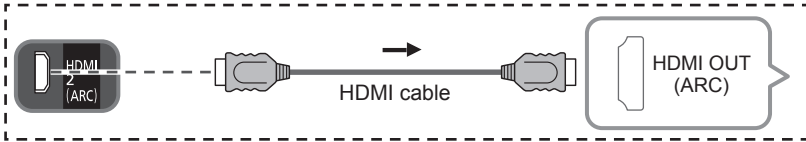
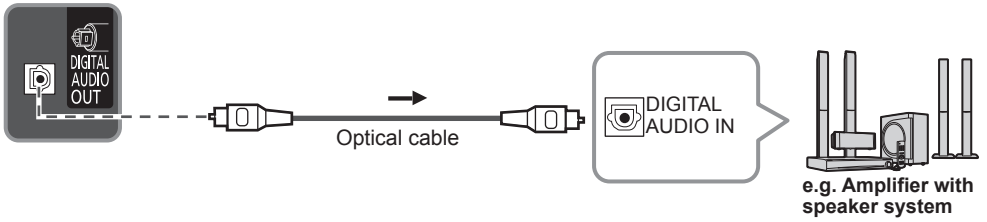

HDMI connection is available if connected audio equipment has ARC (Audio Return Channel) function.

- Please refer to eHELP (p. 22) for Network connection, VIERA link connection or other connections.

Cable Binding Instructions

Back of the TV

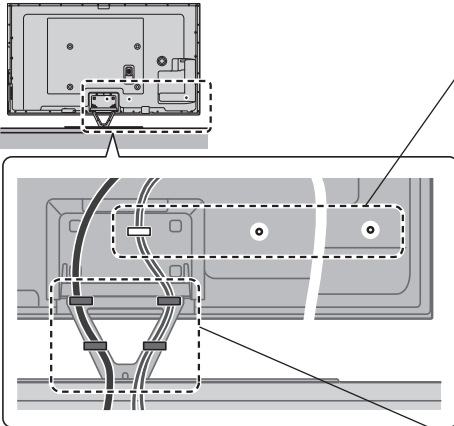

(example)

- Do not bundle the Antenna cable and AC cord together (could cause distorted image).
- Fasten the cables with the Cable tie/ clamp as necessary.
- To fix cables with options, please refer to the operating manual for the options.

To attach:

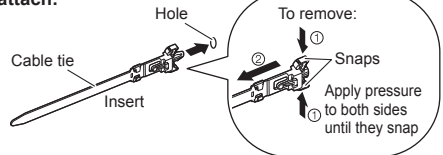

To bundle:

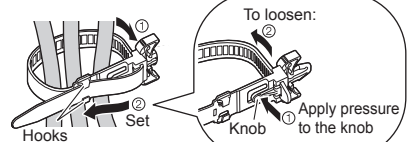

To attach:

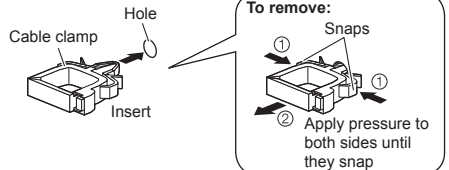

To bundle:

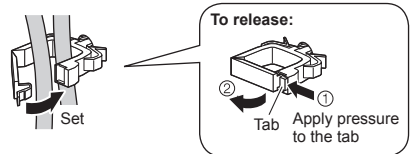

Panasonic does not guarantee operation and performance of peripheral devices made by other manufacturers; and we disclaim any liability or damage arising from operation and/or performance from usage of such other maker's peripheral devices.

Identifying Controls

TV controls/indicators

Front of the TV

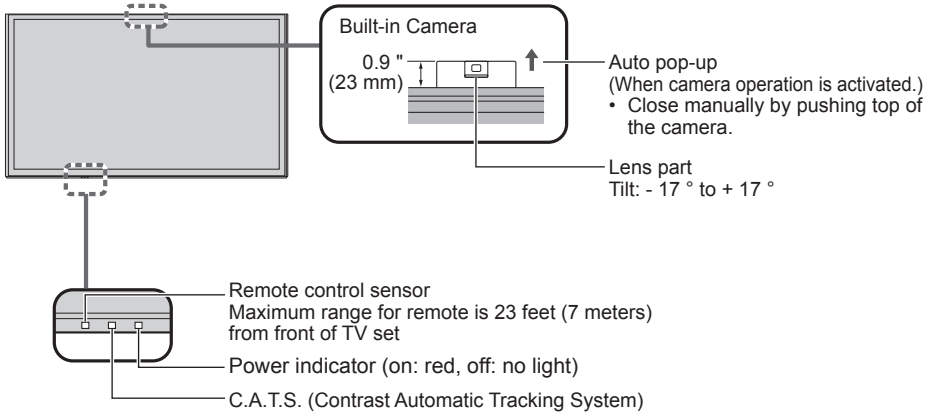

Back of the TV

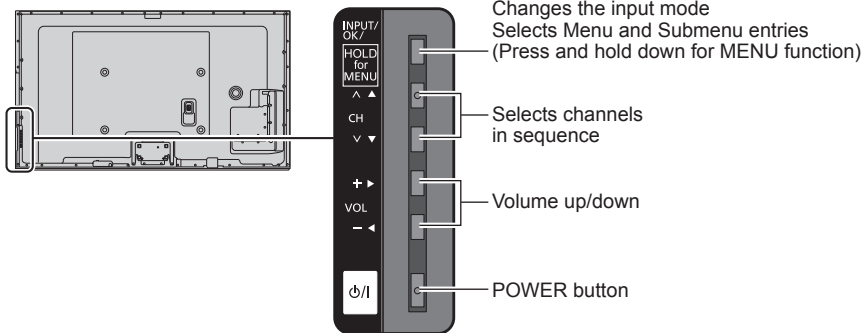

- An image of the control panel is displayed on the screen while in use.

Note

- The TV consumes a small amount of electric energy even when turned off.
- Do not place any objects between the TV remote control sensor and remote control.
- For more information about camera operation, please refer to eHELP. (p. 22)

Remote control

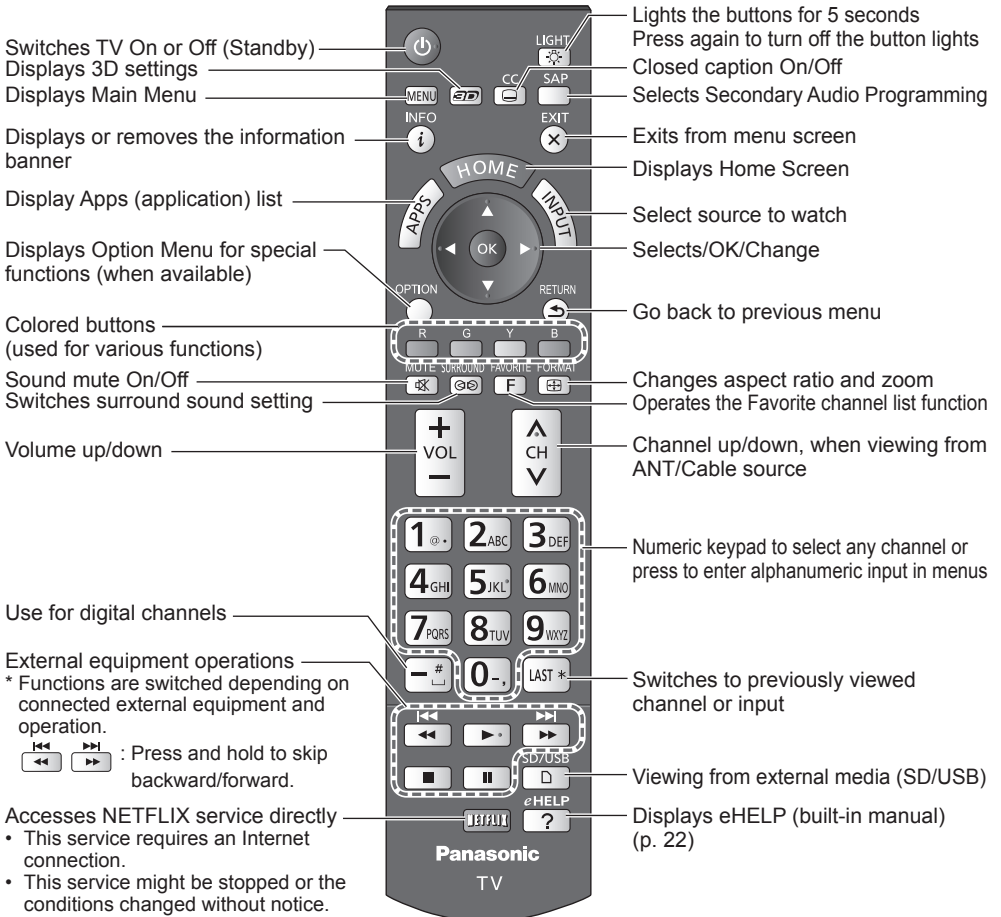

VIERA Touch Pad Controller

The Touch Pad Controller is designed to facilitate TV operation, such as when accessing Home Screen or the Browser with the Touch Pad and free pointing system. It also covers other TV operations as a Remote controller.

- Touch Pad Controller must be paired with the TV prior to operation.
(Pairing to this TV with Bluetooth wireless technology.)

Parts names and functions

Front of the Touch Pad

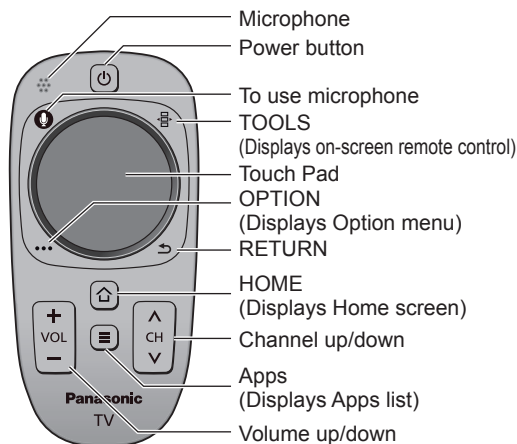

Side of the Touch Pad

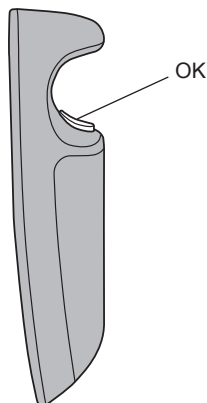

- The Touch Pad Controller must be pointed toward the TV to turn on the power.
(Only the Power-on switch works at first.)
- The TV can be paired with one Touch Pad Controller only.
- About Voice Control:
It is recommended to speak within about 6 inches (15 cm) from microphone of VIERA Touch Pad Controller when using Voice Control function.
(Please refer to eHELP (p. 22) for Voice Control function.)
- Transmission Range:
Use the Touch Pad Controller within the range of 10.5 ft (3.2 m) from front surface of the TV.
The range may be shortened if there are any obstacles or can be affected by the surrounding environment or building structure.

Pairing Touch Pad Controller

(In First Time Setup (p. 20))

To pair the Touch Pad Controller, hold the touch pad within 1.6 ft (50 cm) of the TV and simultaneously press and hold the OPTION and HOME button on the Touch Pad Controller following the instructions on screen.

- You can also pair the Touch Pad Controller.
(Press **Menu** --> **Setup** --> **VIERA Touch Pad settings**)

Operating Touch Pad Controller

Touch Pad operations

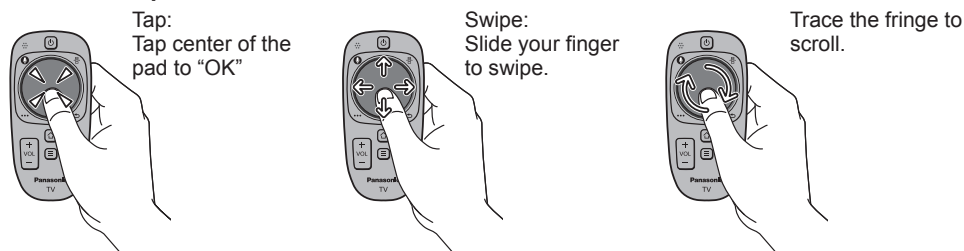

- Some operations differ depending on the application.

First Time Setup

The first time setup screen is displayed only when the TV is turned on for the first time, after the power cord is inserted into a wall outlet.

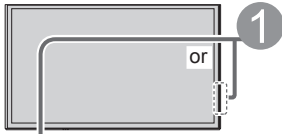

1 Turn the TV on with the POWER button (TV) (Remote)

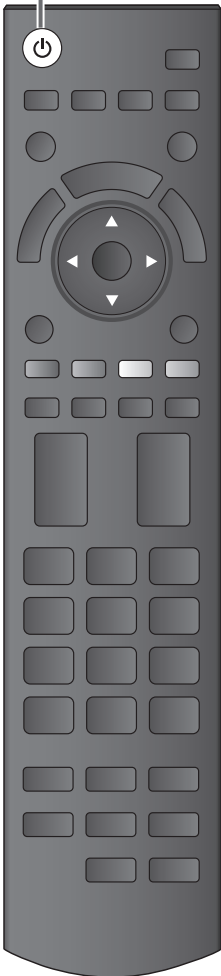
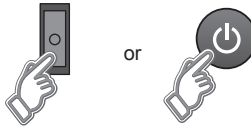

2 Setup the following items

- **Select your language**
- **Select your country**
- **Select your viewing mode (Be sure to select “Home Use”)**
If you select “Store Demonstration” by mistake, confirmation screen will be displayed.
To display the “Set viewing mode” screen again in order to select “Home Use”, perform one of the following actions:
 - Press and hold down the rear POWER button for at least five seconds.
 - Unplug the power cord for 30 seconds and then plug it in again.
- **Configure Network connection**
Follow the instructions on screen to complete the Network connection.
- **ANT/Cable setup**
Set up based on how your TV programming is connected. Select “Yes” if you are connected to a Cable, Satellite or Fiber Optic box. Select “No” if you are connected to the Antenna/Cable In with a coaxial wire into the screw-on connector. In this case you will need to scan for channels that are available in your area.
- **Adjust the Clock**
Select the clock mode and adjust other settings.
When “Auto” is selected, clock will be set automatically according to Time zone and DST. The TV must be connected to the Internet to use this feature.
- **Pair the Touch Pad Controller**
Follow the instructions on screen to complete the pairing. (p. 19)
- **Complete First time setup**
Completion screen is displayed.

3 Select type of Home Screen

The “Tutorial” for “my Home Screen” starts.

Follow the instruction of the “Tutorial” to select desired “Home Screen”.

Example: Home screen selection



Example: Lifestyle Screen



- “Home Screen” is displayed as the start-up screen when the TV is turned on or the HOME button is pressed.

Operations

Turn power on

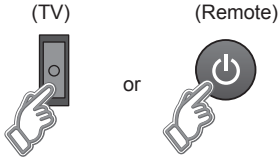

The last viewed Home Screen is displayed each time the TV is turned on.

Example: Lifestyle Screen



Example: Selected content screen

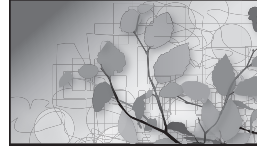

- To return to “Home Screen” at any time.



- You can customize “Home Screen” and display desired information, access specific features easily, select the default “Home Screen”, etc. For details, follow the on-screen instructions or refer to the eHELP (Watching TV > my Home Screen > Settings)

Watching TV

Select the TV viewer from “Home Screen”

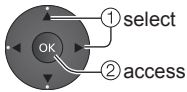

To watch TV via a Cable box, Satellite receiver, or any other source (DVD, DVR, gaming device, etc.), press the INPUT button and select the appropriate input.

To access each feature

Access “Apps list” and select a feature

Example: Apps list



- Apps is the applications (features) of the TV.
- For operations of each feature and the setup of “Apps list”, follow the on-screen instructions or refer to the eHELP (Convenience features > Using Apps list).

Using eHELP (Built-in Manual)

eHELP is a built-in manual that explains how to easily operate the TV's features. Press the eHELP button to access the guide.

1 Display eHELP

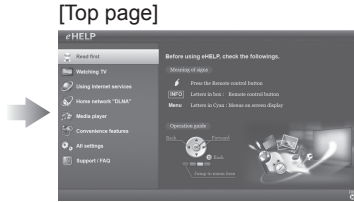

When you enter eHELP again after exiting, the confirmation screen is displayed while the TV is turned on. You can select "TOP PAGE" or "LAST PAGE".

2 Select the desired page from the menu

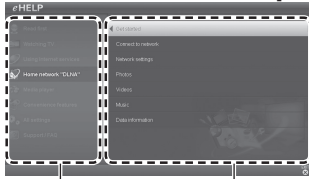

Categories

Menus

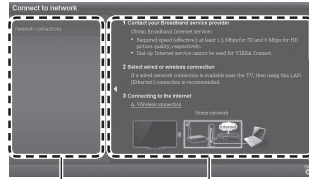

Submenus

Desired page



① Select
② Next



① Select
② Next



① Select
② Next
(If available)



Scroll up/down
(If available the scroll bar appears.)

RETURN



To return to the previous menu/layer



EXIT



To exit eHELP

Jump to menu item

Display the menu related to the explanation page.



- The menu item is not available depending on situation or condition.

Viewing 3D images on TV

Using Precautions

■ Lens

- Do not apply pressure to the liquid crystal shutter. Also, do not drop or bend the 3D Eyewear.
- Do not scratch the surface of the liquid crystal shutter with a pointed instrument etc. Doing so may cause damage to the 3D Eyewear, and reduce the quality of the 3D image.

■ Cautions during viewing

- Do not use devices that emit strong electromagnetic waves (such as cellular phones or personal transceivers) near the 3D Eyewear. Doing so may cause the 3D Eyewear to malfunction.
- The 3D Eyewear cannot operate fully at high or low temperatures. Please use within the specified usage temperature range.
- If the 3D Eyewear is used in a room in which fluorescent lights (50 Hz) are used, the light within the room may appear to be flickering. In this case, either darken or switch off the fluorescent lights when using the 3D Eyewear.
- Wear the 3D Eyewear correctly. 3D images will not be correctly visible if the 3D Eyewear is worn upside down or back-to-front.
- Other kinds of displays (such as computer screens, digital clocks, or calculators etc.) may be difficult to see while wearing the 3D Eyewear. Do not wear the 3D Eyewear when watching anything other than 3D images.

■ For comfortable viewing

- View from at least the recommended distance (3 times the effective height of the screen),

Recommended Distance:

For a 55-inch television, 6.89 ft (2.1 m) or more

For a 60-inch television, 7.55 ft (2.3 m) or more

For a 65-inch television, 7.87 ft (2.4 m) or more

When the top and bottom area of the screen is blackened, such as when playing movies, view the screen at a distance 3 times further than the height of the actual image.

(That makes the viewing distance closer than above recommended distance.)

- Stop using the 3D Eyewear immediately if your skin feels unusual.
In rare cases, the paint or materials used in the 3D Eyewear may cause an allergic reaction.
- Stop using the 3D Eyewear immediately if you experience any redness, pain, or itching on the nose or temples. Prolonged use may cause such symptoms due to excess pressure, which may result in the user feeling unwell.
- Use in area of Bluetooth® signals from other devices may interfere with 3D Eyewear operation.

■ Using radio waves

This unit uses the 2.4 GHz radio frequency ISM band (Bluetooth®). However other wireless equipment may use the same frequency. Be sure to take note of the following to prevent radio wave interference from other equipment.

- Restriction of use
For use only in your country.
- Range of use
The range of use is up to approximately 10.5 ft (3.2 m). The range may be less depending on the structure of the building, the environment and any obstacles between the receiver and the transmitter. Such obstacles as reinforced concrete walls and metal doors, in particular, obstruct the transmitter's signals.
- Interference from other equipment
Due to radio interference, malfunctions may occur if the unit is placed too close to other equipment. We recommend keeping the unit as far away as possible from the following devices:
Bluetooth® devices other than this unit, wireless LAN, microwaves, office automation devices, digital cordless telephones and other electronic devices.
The unit is designed to automatically avoid radio interference from these household devices. However malfunctions may happen when radio interference occurs.

Registration

■ First registration

Perform the first registration when the 3D Eyewear is used for the first time.

① **Turn the TV on**

② **Press the button for about 1 second to turn the power on.**

The lamp lights for about 2 seconds and then flashes.

The 3D Eyewear will be turned on and start registration.

Place the 3D Eyewear within 1.6 ft (50 cm) from the TV while registration in progress.

③ **When the registration is successfully completed, the 3D Eyewear will reconnect with TV automatically when 3D Eyewear is turned on near the TV in 3D mode.**

■ Registration again

When connection with registered TV fails, or when using with another TV, re-register the 3D Eyewear.

① **Turn the TV on**

② **Within 1.6 ft (50 cm) from the TV, press Power button until lamp lights, then release it to start registration.**

③ **When the registration is successfully completed, the 3D Eyewear will reconnect with TV automatically when 3D Eyewear is turned on near the TV in 3D mode.**

Note

- If the registration failed, the 3D Eyewear will power off. In this case, power off the TV and perform from step ①.
- Please refer to eHelp (p. 22) for more details.

Viewing 3D images

Using the television menu controls, set so that 3D images are shown.

- You can watch 3D images in the following cases:
 - When a 3D image supporting Blu-ray Disc is played on a 3D image supporting player/recorder connected using a HDMI cable to a 3D image supporting television.
 - 3D image supported broadcast (program)
 - 3D Photo, 3D Movie taken by LUMIX/Camcorder.

1 Turn the 3D Eyewear on and put it on

Make sure that registration is finished completely.
(Displays messages and information on the screen.)

2 View

When the TV receives a 3D signal, it also tries to detect the 3D mode (format). 3D images are automatically displayed according to the signal. If the 3D images are not displayed correctly or the images cause discomfort, the images can be adjusted by 3D format select or 3D settings.

3 Turn off the 3D Eyewear

The 3D Eyewear indicator lamp turns off, and the power turns off.

- Please refer to eHelp (p. 22) for more details.

Change the view 3D↔2D

■ Simply switches 3D ↔ 2D images (Auto mode)

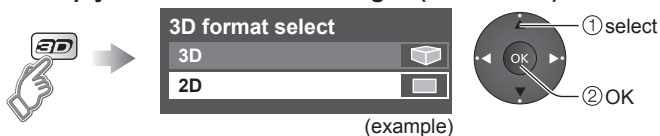

-  → Switches to Manual mode

Frequently Asked Questions (FAQ)

Questions	Answers
How can I confirm that my TV is working properly?	<ul style="list-style-type: none">● The TV has a built in Self Test. On the remote control, press MENU and scroll down and select HELP to access the TV SELF TEST. Run the test and follow the on screen instructions.
Why doesn't the remote control work?	<ul style="list-style-type: none">● Check that the batteries are fresh, are of the same type and are installed with the correct polarity (+ & -).● To operate other devices, such as changing channels when using Cable or Satellite boxes, or operating non-Panasonic Blu-ray players, use the remote supplied with the device.
Why doesn't the Touch Pad Controller work?	<ul style="list-style-type: none">● Check that the batteries are fresh, are of the same type and are installed with the correct polarity (+ & -).● Check if the controller is paired with the TV. (p. 19)● Check if the pairing range is within 1.6 ft (50 cm).● Check if the Touch Pad Controller is pointed toward the TV to turn on the power.
Why is there no picture or just a blue, black or snowy screen being displayed?	<ul style="list-style-type: none">● Ensure that the power cord is plugged in and the TV is turned on (front red LED light should be on, not blinking).● Press the INPUT button on the remote to select the correct input source.● Ensure all connections are correct and secure.● When using external video source, such as a Cable/Satellite box or DVD player, ensure that the device is on and functioning correctly.● Press MENU on the TV's remote control. If the menu is displayed, then the TV is working; recheck above steps.
Why is the screen blank and the power indicator blinking?	<ul style="list-style-type: none">● The TV has gone into shutdown mode to protect itself. Try unplugging it for a few minutes and connecting it again. If there was a temporary power surge on the AC line it may now be OK. If the blinking returns, call 1-877-95-VIERA (U.S.A.) or 1-866-330-0014 (Canada).

Care and Cleaning

First, unplug the power cord plug from the wall outlet.

Display panel

The front of the display panel has been specially treated. Wipe the panel surface gently using only a cleaning cloth or a soft, lint-free cloth.

- If the surface is particularly dirty after cleaning up the dust, soak a soft, lint-free cloth in diluted, mild liquid dish soap (1 part mild liquid dish soap diluted by 100 times the amount of water), and then wring the cloth to remove excess liquid. Use this cloth to wipe the surface of the display panel, then wipe it evenly with a dry cloth of the same type until the surface is dry.
- Do not scratch or hit the surface of the panel with fingernails or other hard objects. Furthermore, avoid contact with volatile substances such as insect sprays, solvents, and thinner; otherwise, the quality of the surface may be adversely affected.

Cabinet

If the cabinet becomes dirty, wipe it with a soft, dry cloth.

- If the cabinet is particularly dirty, soak the cloth in diluted, mild liquid dish soap and then wring the cloth dry. Use this cloth to wipe the cabinet and then wipe it dry with a dry cloth.
- Do not allow any mild liquid dish soap to come into direct contact with the surface of the TV.
- If water droplets get inside the unit, operating problems may result.
- Avoid contact with volatile substances such as insect sprays, solvents, and thinner; otherwise, the quality of the cabinet surface may be adversely affected or the coating may peel off.
- Do not let articles made from rubber or PVC be in contact with the TV for long periods of time.

Pedestal

Cleaning

- Wipe the surfaces with a soft, dry cloth. If the unit is particularly dirty, clean it using a cloth soaked with water to which a small amount of mild liquid dish soap has been added and then wipe with a dry cloth. Do not use products such as solvents, thinner, or household wax for cleaning, as they can damage the surface coating.
- Note: If using a chemically-treated cloth, follow the instructions supplied with the cloth.
- Do not attach sticky tape or labels, as they can make the surface of the pedestal dirty. Do not allow long-term contact with rubber, vinyl products, or the like. (Doing so will cause deterioration.)

3D Eyewear

- Clean using a soft, dry cloth.
- Wiping the 3D Eyewear with a soft cloth that is covered in dust or dirt may scratch the eyewear. Shake off any dust from the cloth before use.
- Do not use benzene, thinner, or wax on the 3D Eyewear, as doing so may cause the paint to peel off.
- Do not dunk the 3D Eyewear in liquid such as water when cleaning.
- Avoid storing the 3D Eyewear in hot or highly humid locations.
- As the liquid crystal shutters (lens) are fragile and easily broken, be very careful when cleaning them.

Power cord plug

Wipe the plug with a dry cloth at regular intervals.

Note: Moisture and dust can lead to fire or electrical shock.

Back panel (Cooling fan)

- The main unit is equipped with a cooling fan on the upper part of the back side. To remove dust or other foreign materials adhering to the fan, vacuum it attaching lightly the opening of the suction nozzle of a vacuum cleaner to the vent holes.
- * Be extremely careful not to damage the display panel or other parts.
- If a message appears even after cleaning and then turning on, contact your dealer or service center.

Specifications

		TC-P55VT60	TC-P60VT60	TC-P65VT60
Power Source		AC 120 V, 60 Hz		
Power Consumption (Rated power / Standby power)		472 W / 0.2 W	472 W / 0.2 W	585 W / 0.2 W
Display Panel	Panel System	Plasma Display panel		
	Screen size	55" class (55.1 inches measured diagonally)	60" class (60.1 inches measured diagonally)	65" class (64.7 inches measured diagonally)
	W × H × Diagonal	48.0" × 27.0" × 55.1" (1,221 mm × 687 mm × 1,401 mm)	52.3" × 29.4" × 60.1" (1,331 mm × 748 mm × 1,527 mm)	56.4" × 31.7" × 64.7" (1,434 mm × 807 mm × 1,646 mm)
	Number of pixels	1,920 × 1,080		
Speaker Output		20 W [5 W + 5 W + 10 W] (10 % THD)		
Channel Capability(Digital/Analog)		VHF / UHF: 2 - 69, CATV: 1 - 135		
Operating Conditions		Temperature: 32 °F - 104 °F (0 °C - 40 °C) Humidity: 20 % - 80 % RH (non-condensing)		
Connection Terminals	VIDEO IN	RCA PIN (VIDEO, AUDIO-L, AUDIO-R)		
	COMPONENT IN	RCA PIN (Y, PB, PR, AUDIO-L, AUDIO-R)		
	HDMI IN 1/2/3	TYPE A Connector (supports "HDAVI Control 5" function)		
	USB 1/2/3	USB2.0 Type A connector DC 5V, Max. 500 mA		
	DIGITAL AUDIO OUT	PCM / Dolby Digital, Fiber Optic		
	OTHERS	SD card slot, ETHERNET (10BASE-T/100BASE-TX)		
Dimensions	Including pedestal (W × H* × D)	51.9" × 33.7" × 11.7" (1,318 mm × 855 mm × 296 mm)	56.2" × 36.1" × 12.2" (1,428 mm × 917 mm × 308 mm)	60.3" × 38.4" × 12.8" (1,531 mm × 975 mm × 323 mm)
	TV Set only (W × H* × D)	51.9" × 30.2" × 2.0" (1,318 mm × 767 mm × 51 mm)	56.2" × 32.7" × 2.0" (1,428 mm × 829 mm × 51 mm)	60.3" × 35.0" × 2.0" (1,531 mm × 887 mm × 51 mm)
Mass	Including pedestal	84.9 lb. (38.5 kg) NET	97.0 lb. (44.0 kg) NET	111.4 lb. (50.5 kg) NET
	TV Set only	69.5 lb. (31.5 kg) NET	80.5 lb. (36.5 kg) NET	92.6 lb. (42.0 kg) NET

* With Camera pop-up: + 0.9" (23 mm) height

Built-in Camera	
Lens	F2.0 Lens; FOV (D) 50.9° (in HD mode)
Focus	Fixed focus
Resolution	1,280 × 720

Wireless LAN

Standard Compliance and Frequency Range *1, *2	IEEE 802.11a/n : 5.15 GHz - 5.35 GHz, 5.47 GHz - 5.85 GHz IEEE 802.11b/g/n : 2.400 GHz - 2.4835 GHz
Security	WPA2-PSK (TKIP/AES), WPA-PSK (TKIP/AES), WEP (64bit/128bit)

*1 The frequency and channel differ depending on the country.

*2 802.11b/g/n CH1 ~ CH11 only use for United States and Canada.

Bluetooth

Standard Compliance	Bluetooth® 3.0
Frequency Range	2.402 GHz - 2.480 GHz

3D Eyewear

Battery	Coin-shaped lithium battery CR2025 Operation time: Approx. 75 hours in continuous use of the battery made by Panasonic
----------------	---

- Use Panasonic 3D Eyewear supporting Bluetooth wireless technology.

Note

- Design and Specifications are subject to change without notice. Mass and Dimensions shown are approximate.
- 3D Eyewear and VIERA Touch Pad Controller use Bluetooth wireless technology.

Limited Warranty (for U.S.A. and Puerto Rico only)

Panasonic Consumer Marketing Company of North America,
Division of Panasonic Corporation of North America
One Panasonic Way
Secaucus, New Jersey 07094

Panasonic Television Limited Warranty

Limited Warranty Coverage

If your product does not work properly because of a defect in materials or workmanship, Panasonic Consumer Marketing Company of North America (referred to as "the warrantor") will, for the length of the period indicated on the chart below, which starts with the date of original purchase ("Limited Warranty period"), at its option either (a) repair your product with new or refurbished parts, (b) replace it with a new or a refurbished equivalent value product, or (c) refund your purchase price. The decision to repair, replace or refund will be made by the warrantor.

TV CATEGORIES	PARTS	LABOR	SERVICE
Up to 42" (diagonal)	1 (ONE) YEAR	1 (ONE) YEAR	Carry-In
46" (diagonal) and larger			On-Site
3D Eyewear			Mail In

During the "Labor" Limited Warranty period there will be no charge for labor. During the "Parts" Limited Warranty period, there will be no charge for parts.

You must carry-in your product or arrange for on-site service during the Limited Warranty period. If non-rechargeable batteries are included, they are not warranted. This Limited Warranty only applies to products purchased and serviced in the United States or Puerto Rico. This Limited Warranty is extended only to the original purchaser of a new product which was not sold "as is". A purchase receipt or other proof of the original purchase date is required for Limited Warranty service.

On-Site or Carry-In Service

For On-Site or Carry-In Service in the United States and Puerto Rico call 1-877-95-VIERA (1-877-958-4372).

On-site service where applicable requires clear, complete and easy access to the product by the authorized servicer and does not include removal or re-installation of an installed product. It is possible that certain on-site repairs will not be completed on-site, but will require that the product or parts of the product, at the servicer's discretion be removed for shop diagnosis and/or repair and then returned.

Mail-In Service

For assistance in the U.S.A. and Puerto Rico in obtaining replacement, please ship the product prepaid to:

Panasonic Exchange Center
4900 George McVay Drive
Suite B
McAllen, TX 78503

panacare@us.panasonic.com

When shipping the unit, carefully pack, include all accessories, and send it prepaid, adequately insured and preferably in the original carton. When shipping Lithium Ion batteries please visit our Web Site at www.panasonic.com/BatteryHandling as Panasonic is committed to providing the most up to date information. Include a letter detailing the complaint, a return address and provide a daytime phone number where you can be reached. A valid registered receipt is required under the Limited Warranty.

Limited Warranty Limits And Exclusions

This Limited Warranty ONLY COVERS failures due to defects in materials or workmanship, and DOES NOT COVER normal wear and tear or cosmetic damage, nor does it cover markings or retained images on the glass panel resulting from viewing fixed images (including, among other things, non-expanded standard 4:3 pictures on wide screen TVs, or onscreen data in a stationary and fixed location such as network logos, video games and banners). The Limited Warranty ALSO DOES NOT COVER damages which occurred in shipment, or failures which are caused by products not supplied by the warrantor, or failures which result from accidents, misuse, abuse, neglect, bug infestation, mishandling, misapplication, alteration, faulty installation, set-up adjustments, misadjustment of consumer controls, improper maintenance, power line surge, lightning damage, modification, or commercial use (such as in a hotel, office, restaurant, or other business), rental use of the product, service by anyone other than a Factory Service Center or other Authorized Servicer, or damage that is attributable to acts of God.

THERE ARE NO EXPRESS WARRANTIES EXCEPT AS LISTED UNDER "LIMITED WARRANTY COVERAGE". THE WARRANTOR IS NOT LIABLE FOR INCIDENTAL OR CONSEQUENTIAL DAMAGES RESULTING FROM THE USE OF THIS PRODUCT, OR ARISING OUT OF ANY BREACH OF THIS LIMITED WARRANTY. (As examples, this excludes damages for lost time, cost of having someone remove or re-install an installed unit if applicable, or travel to and from the servicer. The items listed are not exclusive, but are for illustration only.) **ALL EXPRESS AND IMPLIED WARRANTIES, INCLUDING THE LIMITED WARRANTY OF MERCHANTABILITY, ARE LIMITED TO THE PERIOD OF THE LIMITED WARRANTY.**

Some states do not allow the exclusion or limitation of incidental or consequential damages, or limitations on how long an implied Limited Warranty lasts, so the exclusions may not apply to you.

This Limited Warranty gives you specific legal rights and you may also have others rights which vary from state to state. If a problem with this product develops during or after the Limited Warranty period, you may contact your dealer or Service Center. If the problem is not handled to your satisfaction, then write to the warrantor's Consumer Affairs Department at the addresses listed for the warrantor.

PARTS AND SERVICE (INCLUDING COST OF AN ON-SITE SERVICE CALL, WHERE APPLICABLE) WHICH ARE NOT COVERED BY THIS LIMITED WARRANTY ARE YOUR RESPONSIBILITY.

Customer Services Directory (for U.S.A. and Puerto Rico)

Customer Services Directory (United States and Puerto Rico)

Obtain Product Information and Operating Assistance, locate your nearest Dealer or Service Center, purchase Parts and Accessories, or make Customer Service and Literature requests by visiting our Web Site at:

<http://www.panasonic.com/help>

or, contact us via the web at:

<http://www.panasonic.com/contactinfo>

You may also contact us directly at:

1-877-95-VIERA (958-4372)

Monday-Friday 9 am-9 pm; Saturday-Sunday 10 am-7 pm, EST.

■ For hearing or speech impaired TTY users, TTY: 1-877-833-8855

Accessory Purchases (United States and Puerto Rico)

Purchase Parts, Accessories and Instruction Books on line for all Panasonic Products by visiting our Web Site at:

<http://www.pstc.panasonic.com>

or, send your request by E-mail to:

npcparts@us.panasonic.com

You may also contact us directly at:

1-800-332-5368 (Phone) 1-800-237-9080 (Fax Only) (Monday - Friday 9 am to 9 pm, EST.)

Panasonic National Parts Center

20421 84th Avenue South,

Kent, WA 98032

(We Accept Visa, MasterCard, Discover Card, and American Express)

■ For hearing or speech impaired TTY users, TTY: 1-866-605-1277

Limited Warranty (for Canada)

Panasonic Canada Inc.
5770 Ambler Drive, Mississauga, Ontario L4W 2T3
PANASONIC PRODUCT – LIMITED WARRANTY

Panasonic Canada Inc. warrants this product to be free from defects in material and workmanship under normal use and for a period as stated below from the date of original purchase agrees to, at its option either (a) repair your product with new or refurbished parts, (b) replace it with a new or a refurbished equivalent value product, or (c) refund your purchase price. The decision to repair, replace or refund will be made by Panasonic Canada Inc.

Viera TV (46" & over)	In-home service	One (1) year, parts (including panel) and labour.
Viera TV (under 46")	Carry-in service	One (1) year, parts (including panel) and labour.

In-home Service will be carried out only to locations accessible by roads and within 50 km of an authorized Panasonic service facility.

In-home service requires clear, complete and easy access to the product by the Authorized Servicer and does not include removal or re-installation of an installed product. If removal is required to service the product, it will be at the discretion of the Servicer and in no event will Panasonic Canada Inc. or the Servicer be liable for any special, indirect or consequential damages.

This warranty is given only to the original purchaser, or the person for whom it was purchased as a gift, of a Panasonic brand product mentioned above sold by an authorized Panasonic dealer in Canada and purchased and used in Canada, which product was not sold "as is", and which product was delivered to you in new condition in the original packaging.

IN ORDER TO BE ELIGIBLE TO RECEIVE WARRANTY SERVICE HEREUNDER, A PURCHASE RECEIPT OR OTHER PROOF OF DATE OF ORIGINAL PURCHASE, SHOWING AMOUNT PAID AND PLACE OF PURCHASE IS REQUIRED

LIMITATIONS AND EXCLUSIONS

This warranty ONLY COVERS failures due to defects in materials or workmanship, and DOES NOT COVER normal wear and tear or cosmetic damage. The warranty ALSO DOES NOT COVER damages which occurred in shipment, or failures which are caused by products not supplied by Panasonic Canada Inc., or failures which result from accidents, misuse, abuse, neglect, mishandling, misapplication, alteration, faulty installation, set-up adjustments, misadjustment of consumer controls, improper maintenance, power line surge, lightning damage, modification, introduction of sand, humidity or liquids, commercial use such as hotel, office, restaurant, or other business or rental use of the product, or service by anyone other than a Authorized Servicer, or damage that is attributable to acts of God. Dry cell batteries are also excluded from coverage under this warranty.

THIS EXPRESS, LIMITED WARRANTY IS IN LIEU OF ALL OTHER WARRANTIES, EXPRESS OR IMPLIED, INCLUDING ANY IMPLIED WARRANTIES OF MERCHANTABILITY AND FITNESS FOR A PARTICULAR PURPOSE. IN NO EVENT WILL PANASONIC CANADA INC. BE LIABLE FOR ANY SPECIAL, INDIRECT OR CONSEQUENTIAL DAMAGES RESULTING FROM THE USE OF THIS PRODUCT OR ARISING OUT OF ANY BREACH OF ANY EXPRESS OR IMPLIED WARRANTY. (As examples, this warranty excludes damages for lost time, travel to and from the Authorized Servicer, loss of or damage to media or images, data or other memory or recorded content. This list of items is not exhaustive, but for illustration only.)

In certain instances, some jurisdictions do not allow the exclusion or limitation of incidental or consequential damages, or the exclusion of implied warranties, so the above limitations and exclusions may not be applicable. This warranty gives you specific legal rights and you may have other rights which vary depending on your province or territory.

WARRANTY SERVICE

For product operation and information assistance, please contact:

Our Customer Care Centre: 1-800 #. 1-866-330-0014
or visit our website: <https://conclierge.panasonic.ca>

For product repairs, please contact Viera Customer Care Agent using the above contact info.

IF YOU SHIP THE PRODUCT TO A SERVICENTRE

Carefully pack and send prepaid, adequately insured and preferably in the original carton.
Include details of the defect claimed, and proof of date of original purchase.

USA Only: Disposal may be regulated in your community due to environmental considerations. For disposal or recycling information, please visit Panasonic website:

<http://www.panasonic.com/environmental>
or call 1-888-769-0149.

Sólo Estados Unidos: La disposición puede estar regulada en su comunidad debido a consideraciones ambientales. Para información sobre la disposición o reciclaje, por favor visite la página web de Panasonic: <http://www.panasonic.com/environmental> o llame al 1-888-769-0149.

Customer's Record

The model number and serial number of this product can be found on its back cover. You should note this serial number in the space provided below and retain this book, plus your purchase receipt, as a permanent record of your purchase to aid in identification in the event of theft or loss, and for Warranty Service purposes.

Model Number _____

Serial Number _____

Anotación del cliente

El modelo y el número de serie de este producto se encuentran en su panel posterior. Deberá anotarlos en el espacio provisto a continuación y guardar este manual, más el recibo de su compra, como prueba permanente de su adquisición, para que le sirva de ayuda al identificarlo en el caso de que le sea sustraído o lo pierda, y también para disponer de los servicios que le ofrece la garantía.

Modelo _____

Número de serie _____

**Panasonic Consumer Marketing Company of North America,
Division of Panasonic Corporation of North America**
One Panasonic Way, Secaucus
New Jersey 07094 U.S.A.

Panasonic Canada Inc.
5770 Ambler Drive
Mississauga, Ontario
L4W 2T3 CANADA