

Customer's Record

The model number and serial number of this product can be found on its back cover. You should note this serial number in the space provided below and retain this book, plus your purchase receipt, as a permanent record of your purchase to aid in identification in the event of theft or loss, and for Warranty Service purposes.

Model Number _____

Serial Number _____

Panasonic Canada Inc.
5770 Ambler Drive
Mississauga, Ontario
L4W 2T3 CANADA

©Panasonic Corporation 2016

Printed in Mexico

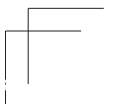
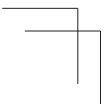

Panasonic®

Model No.
TC-55DX700C
TC-65DX700C

Owner's Manual

55"/65" Class 4K Ultra HD TV*
(54.6/64.5 inches measured diagonally)

* Actual resolution: 3,840 × 2,160p

VIERA

For assistance (Canada), please visit:
www.panasonic.ca/english/support

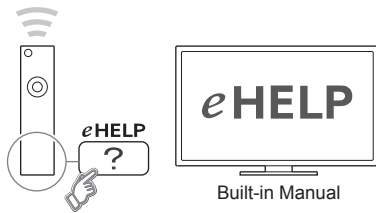
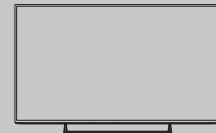

Thank you for purchasing this Panasonic product.

Please read these instructions carefully before operating this product and retain them for future reference.

Please carefully read the "Safety Precautions" of this manual before use.

The images shown in this manual are for illustrative purposes only.

M0416-0

English



TQB3AC0041

This product incorporates the following software:

- (1) the software developed independently by or for Panasonic Corporation,
- (2) the software owned by third party and licensed to Panasonic Corporation,
- (3) Firefox OS is powered by Mozilla,
- (4) the software licensed under the GNU LESSER GENERAL PUBLIC LICENSE Version 2.1 (LGPL V2.1) and/or,
- (5) open sourced software other than the software licensed under the LGPL V2.1.

About the software categorized as (3), please refer to the "About Firefox OS" menu.

The software categorized as (4) and (5) are distributed in the hope that it will be useful, but WITHOUT ANY WARRANTY, without even the implied warranty of MERCHANTABILITY or FITNESS FOR A PARTICULAR PURPOSE. Please refer to the detailed terms and conditions thereof shown in the "Software License" menu on this product.

At least three (3) years from delivery of this product, Panasonic will give to any third party who contacts us at the contact information provided below, for a charge no more than our cost of physically performing source code distribution, a complete machine-readable copy of the corresponding source code covered under LGPL V2.1 or the other licenses with the obligation to do so, as well as the respective copyright notice thereof.

Contact Information: cdrequest@unipf.jp

The source code and the copyright notice are also available for free in our website below.

<http://www.unipf.jp/dl/DTV16U/>

"PlayReady" is a trademark registered by Microsoft. Please be aware of the following.

(a) This product contains technology subject to certain intellectual property rights of Microsoft. Use or distribution of this technology outside of this product is prohibited without the appropriate license(s) from Microsoft.

(b) Content owners use Microsoft PlayReady™ content access technology to protect their intellectual property, including copyrighted content. This device uses PlayReady technology to access PlayReady-protected content and/or WMDRM-protected content. If the device fails to properly enforce restrictions on content usage, content owners may require Microsoft to prevent the device's ability to consume PlayReady-protected content. Revocation should not affect unprotected content or content protected by other content access technologies.

Content owners may require you to upgrade PlayReady to access their content.

If you decline an upgrade, you will not be able to access content that requires the upgrade.

Contents

Please read before using the unit

Safety Precautions	4
Accessories/Optional accessories	8
Connections	10
Identifying Controls	13
First Time Setup	15
Using eHELP (Built-in Manual)	16
Frequently Asked Questions (FAQ)	17
Care and Cleaning	18
Specifications	19
Limited Warranty (for Canada)	21

VIERA Link™ and HDAVI Control™ are trademarks of Panasonic Corporation.

HDMI, the HDMI Logo, and High-Definition Multimedia Interface are trademarks or registered trademarks of HDMI Licensing LLC in the United States and other countries.

Manufactured under license from Dolby Laboratories. Dolby, Dolby Audio, and the double-D symbol are trademarks of Dolby Laboratories.

DLNA®, the DLNA Logo and DLNA CERTIFIED™ are trademarks, service marks, or certification marks of the Digital Living Network Alliance.

Speech Powered by Dragon
2002-2016 Nuance Communications, Inc. All rights reserved.

Firefox® OS is a registered trademark of the Mozilla Foundation.



This product is licensed under the AVC patent portfolio license for the personal and non-commercial use of a consumer to (i) encode video in compliance with the AVC Standard ("AVC Video") and/or (ii) decode AVC Video that was encoded by a consumer engaged in a personal and non-commercial activity and/or was obtained from a video provider licensed to provide AVC Video. No license is granted or shall be implied for any other use. Additional information may be obtained from MPEG LA, LLC.
See <http://www.mpegla.com>.

Panasonic does not guarantee operation and performance of peripheral devices made by other manufacturers; and we disclaim any liability or damage arising from operation and/or performance from usage of such other maker's peripheral devices.





Safety Precautions

CAUTION
RISK OF ELECTRIC SHOCK
DO NOT OPEN

WARNING: To reduce the risk of electric shock, do not remove cover or back. No user-serviceable parts inside. Refer servicing to qualified service personnel.

 The lightning flash with arrowhead within a triangle is intended to tell the user that parts inside the product are a risk of electric shock to persons.

 The exclamation point within a triangle is intended to tell the user that important operating and servicing instructions are in the papers with the appliance.

Note to CATV System Installer

This reminder is provided to direct the CATV system installer's attention to Article 820-40 of the NEC that provides guidelines for proper grounding and, in particular, specifies that the cable ground shall be connected to the grounding system of the building, as close to the point of cable entry as practical.

Secure Ventilation

Slots and openings in the cabinet and the back or bottom are provided for ventilation, and to ensure reliable operation of the TV and to protect it from overheating. These openings must not be blocked or covered. There should be at least 4 inches (10 cm) of space around the TV. The openings should never be blocked by placing the TV on a bed, sofa, rug or other similar surface. This TV should not be placed in a built-in installation such as a bookcase unless proper ventilation is provided.

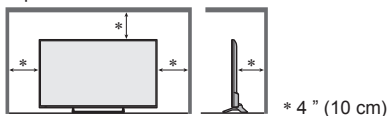

Important Safety Instructions (TV set)

- 1) Read these instructions.
- 2) Keep these instructions.
- 3) Heed all warnings.
- 4) Follow all instructions.
- 5) Do not use this apparatus near water.
- 6) Clean only with dry cloth.
- 7) Do not block any ventilation openings. Install in

accordance with the manufacturer's instructions.

- 8) Do not install near any heat sources such as radiators, heat registers, stoves or other apparatus (including amplifiers) that produce heat.
- 9) Do not defeat the safety purpose of the polarized or grounding-type plug. A polarized plug has two blades with one wider than the other. A grounding type plug has two blades and a third grounding prong. The wide blade or the third prong are provided for your safety. If the provided plug does not fit into your outlet, consult an electrician for replacement of the obsolete outlet.
- 10) Protect the power cord from being walked on or pinched particularly at plugs, convenience receptacles, and the point where they exit from the apparatus.
- 11) Only use attachments / accessories specified by the manufacturer.
- 12) Use only with the cart, stand, tripod, bracket or table specified by the manufacturer, or sold with the apparatus. When a cart is used, use caution when moving the cart / apparatus combination to avoid injury from tip-over. 
- 13) Unplug this apparatus during lightning storms or when unused for long periods of time.
- 14) Refer all servicing to qualified service personnel. Servicing is required when the apparatus has been damaged in any way, such as power-supply cord or plug is damaged, liquid has been spilled or objects have fallen into the apparatus, the apparatus has been exposed to rain or moisture, does not operate normally, or has been dropped.
- 15) Operate only from the type of power source indicated on the marking label. If you are not sure of the type of power supplied to your home, consult your television dealer or local power company.
- 16) Follow all warnings and instructions marked on the TV.
- 17) Never push objects of any kind into this TV through cabinet slots as they may touch dangerous voltage points or short out parts that could result in a fire or electric shock. Never spill liquid of any kind on the TV.
- 18) If an outside antenna is connected to the television equipment, be sure the antenna system is grounded so as to provide some protection against voltage surges and built up static charges. In the U.S. Section 810-21 of the National Electrical Code provides information with respect to proper grounding of the mast and supporting structure, grounding of the lead-in wire to an antenna discharge unit, size of grounding conductors, location of antenna discharge unit, connection to grounding electrodes, and requirements for the grounding electrode.

EXAMPLE OF ANTENNA GROUNDING AS PER (NEC)
NATIONAL ELECTRICAL CODE

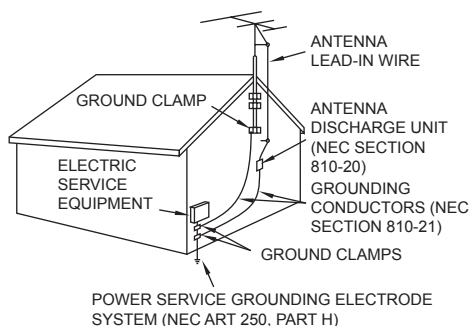

19) An outside antenna system should not be located in the vicinity of overhead power lines, other electric light, power circuits, or where it can fall into such power lines or circuits. When installing an outside antenna system, extreme care should be taken to keep from touching such power lines or circuits as contact with them might be fatal.

20) Unplug this TV from the wall outlet and refer servicing to qualified service personnel under the following conditions:

- a. When the power cord or plug is damaged or frayed.
- b. If liquid has been spilled into the TV.
- c. If the TV has been exposed to rain or water.
- d. If the TV does not operate normally by following the operating instructions.

Adjust only those controls that are covered by the operating instructions as improper adjustment of other controls may result in damage and will often require extensive work by a qualified technician to restore the TV to normal operation.

- e. If the TV has been dropped or the cabinet has been damaged.
 - f. When the TV exhibits a distinct change in performance - this indicates a need for service.
- 21) When replacement parts are required, be sure the service technician uses replacement parts specified by the manufacturer that have the same characteristics as the original parts. Unauthorized substitutions may result in fire, electric shock, or other hazards.

22) WARNING:

TO REDUCE THE RISK OF FIRE OR ELECTRIC SHOCK, DO NOT EXPOSE THIS APPARATUS TO RAIN, MOISTURE, DRIPPING OR SPLASHING.

DO NOT PLACE LIQUID CONTAINERS (FLOWER VASES, CUPS, COSMETICS, ETC.) ABOVE THE SET (INCLUDING ON SHELVES ABOVE, ETC.).

23) WARNING:

SMALL PARTS CAN PRESENT CHOKING HAZARD IF ACCIDENTALLY SWALLOWED. KEEP SMALL PARTS AWAY FROM YOUNG CHILDREN.

DISCARD UNNEEDED SMALL PARTS AND OTHER OBJECTS, INCLUDING PACKAGING MATERIALS AND PLASTIC BAGS/SHEETS TO PREVENT THEM FROM BEING PLAYED WITH BY YOUNG CHILDREN, CREATING THE POTENTIAL RISK OF SUFFOCATION.

24) WARNING:

To prevent the spread of fire, keep candles or other open flames away from this product at all times.



25) WARNING:

Do not place this TV in any medical institutions or locations with medical devices.

Radio waves from this TV may interfere with the medical devices and cause accidents due to the malfunction.

26) WARNING:

Do not use this TV near any automatic control devices such as automatic doors or fire alarms.

Radio waves from this TV may interfere with the automatic control devices and cause accidents due to the malfunction.

27) WARNING:

Keep this TV away at least 9 inches (22 cm) from the location where a cardiac pacemaker is implanted.

Radio waves from this TV may interfere with the operation of the pacemaker.

28) CAUTION:

The Power switch on this unit will not completely shut off all power from AC outlet. Since the power cord serves as the main disconnect device for the unit, you will need to unplug it from the AC outlet to shut down all power.

Therefore, make sure the unit has been installed so that the power cord can be easily unplugged from AC outlet in case of an accident. To avoid fire hazard, the power cord should also be unplugged from the AC outlet when left unused for a long period of time (for example, when on vacation).

29) CAUTION:

TO PREVENT ELECTRIC SHOCK, DO NOT USE THIS PLUG WITH A RECEPTACLE OR OTHER OUTLET UNLESS THE BLADES CAN BE FULLY INSERTED TO PREVENT BLADE EXPOSURE.

30) CAUTION:

USE WITH OTHER STAND MAY RESULT IN INSTABILITY POSSIBLY CAUSING INJURY.

31) CAUTION:

DANGER OF EXPLOSION IF BATTERY IS INCORRECTLY REPLACED. REPLACE ONLY WITH THE SAME OR EQUIVALENT TYPE.

IC STATEMENT

This device complies with Industry Canada's licence-exempt RSSs. Operation is subject to the following two conditions:

- 1) This device may not cause interference; and
- 2) This device must accept any interference, including interference that may cause undesired operation of the device.

FCC and Industry Canada (IC) RF Exposure Warning:

- **This TV is provided built-in transmitter: Wireless LAN Adapter with FCC ID: NKR-P75B/IC ID: 4441A-P75B.**
- **This transmitter complies with FCC and IC radiation exposure limits set forth for an uncontrolled environment for mobile use with minimum 8 inches (20 cm) spacing requirement between transmitters and all person's body (excluding extremities of hands, wrist and feet) during wireless modes of operation.**
- **Other third-party wireless transmitters should not be used as they have not been RF exposure evaluated for use with this TV and may not comply with RF exposure requirements.**

<Only for wireless LAN if capable of transmission in the 5.15 ~ 5.25 GHz frequency band>

This product is restricted to indoor use due to its operation in the 5.15 to 5.25 GHz frequency range.

IC requires this product to be used indoors for the frequency range 5.15 to 5.25 GHz to reduce the potential for harmful interference to co-channel Mobile Satellite systems. High power radars are allocated as primary users of the 5.25 to 5.35 GHz and 5.65 to 5.85 GHz bands. These radar stations can cause interference with and/or damage this product.

WARNING

Flat panel displays are not always supported on the proper stands or installed according to the manufacturer's recommendations. Flat panel displays that are inappropriately situated on dressers, bookcases, shelves, desks, speakers, chests, or carts may fall over and may cause personal injury or even death.

The Consumer Electronics Association (CEA), of which Panasonic is a member, is committed to making home entertainment enjoyable and safe. To prevent personal injury or death, be sure to follow these following safety guidelines:

CEA CHILD SAFETY NOTICE

THE CONSUMER ELECTRONICS INDUSTRY CARES

- Manufacturers, retailers and the rest of the consumer electronics industry are committed to making home entertainment safe and enjoyable.
- As you enjoy your television, please note that all televisions – new and old- must be supported on proper stands or installed according to the manufacturer's recommendations. Televisions that are inappropriately situated on dressers, bookcases, shelves, desks, speakers, chests, carts, etc., may fall over, resulting in injury.

TUNE IN TO SAFETY

- ALWAYS follow the manufacturer's recommendations for the safe installation of your television.
- ALWAYS read and follow all instructions for proper use of your television.
- NEVER allow children to climb on or play on the television or the furniture on which the television is placed.
- NEVER place the television on furniture that can easily be used as steps, such as a chest of drawers.
- ALWAYS install the television where it cannot be pushed, pulled over or knocked down.
- ALWAYS route cords and cables connected to the television so that they cannot be tripped over, pulled or grabbed.

WALL OR CEILING MOUNT YOUR TELEVISION

- ALWAYS contact your retailer about professional installation if you have any doubts about your ability to safely mount your television.
- ALWAYS use a mount that has been recommended by the television manufacturer and has a safety certification by an independent laboratory (such as UL, CSA, ETL).
- ALWAYS follow all instructions supplied by the television and mount manufacturers.
- ALWAYS make sure that the wall or ceiling where you are mounting the television is appropriate. Some mounts are not designed to be mounted to walls and ceilings with steel studs or cinder block construction. If you are unsure, contact a professional installer.
- Televisions can be heavy. A minimum of two people is required for a wall or ceiling mount installation.

**MOVING AN OLDER TELEVISION TO A NEW PLACE
IN YOUR HOME**

- Many new television buyers move their older CRT televisions into a secondary room after the purchase of a flat-panel television. Special care should be made in the placement of older CRT televisions.
- ALWAYS place your older CRT television on furniture that is sturdy and appropriate for its size and weight.
- NEVER place your older CRT television on a dresser where children may be tempted to use the drawers to climb.
- ALWAYS make sure your older CRT television does not hang over the edge of your furniture.

Panasonic recommends that a qualified installer perform the wall-mount installation. See page 20.



The American Academy of Pediatrics discourages media viewing for children younger than two years. For more details, see www.aap.org.

Accessories/ Optional accessories

Accessories

Check that all the following items have been included with your TV

- Remote Control
• N2QAYB001013



- Batteries (2)
• AA Battery



- Power cord

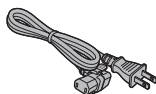

- Pedestal
• Assembly (p. 8)

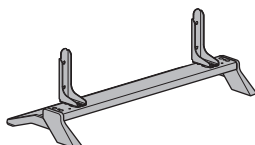

- Owner's Manual

- Quick start guide

- Child safety sheet

Optional Accessories

Please contact your nearest Panasonic dealer to purchase the recommended optional accessories. For additional details, please refer to the optional accessories installation manual.

- Product information (Model No. and release date etc.) is subject to change without notice.
- For more information
<http://www.panasonic.com>

Attaching the pedestal to TV

- A** Assembly screws
(Black) (4)



- B** Assembly screws
(Black) (4)



- C** Bracket (2)



- D** Base

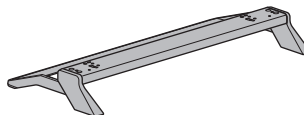

Attaching the pedestal

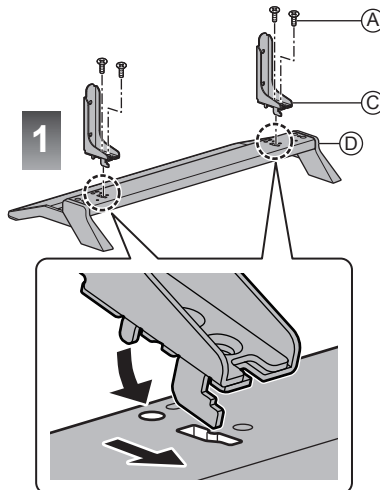

Bottom view

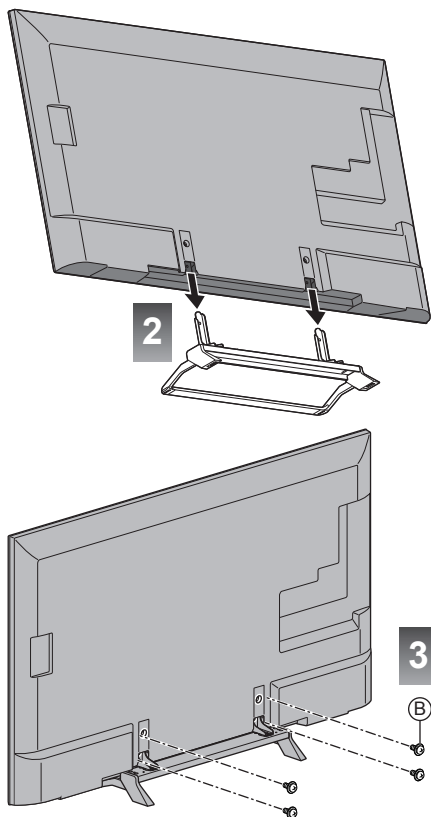

Removing the pedestal from the TV

Be sure to remove the pedestal in the following way when using the wall-hanging bracket or repacking the TV.

- 1 Remove the assembly screws **B** from the TV.
- 2 Lift the TV from the pedestal.
- 3 Remove the assembly screws **A** from the bracket.

Warning

Do not disassemble or modify the pedestal.

- Otherwise, the TV may fall over and become damaged, and personal injury may result.

Caution

Do not use any pedestal other than that provided with this TV.

- Otherwise, the TV may fall over and become damaged, and personal injury may result.

Do not use the pedestal if it becomes warped or physically damaged.

- If you use the pedestal when it is physically damaged, personal injury may result. Contact your nearest Panasonic Dealer immediately.

During set-up, make sure that all screws are securely tightened.

- If sufficient care is not taken to ensure screws are properly tightened during assembly, the pedestal will not be strong enough to support the TV, and it might fall over and become damaged, and personal injury may result.

When removing the pedestal, do not remove the pedestal by any methods other than the specified procedure. (p. 9)

- Otherwise, the TV and/or pedestal may fall over and become damaged, and personal injury may result.

■ Moving the TV

Before moving the TV, disconnect all cables.

- Move the TV with at least two people.

Connections

Please refer to eHELP for other connections (VIERA Link connection etc.).

Connection Panels

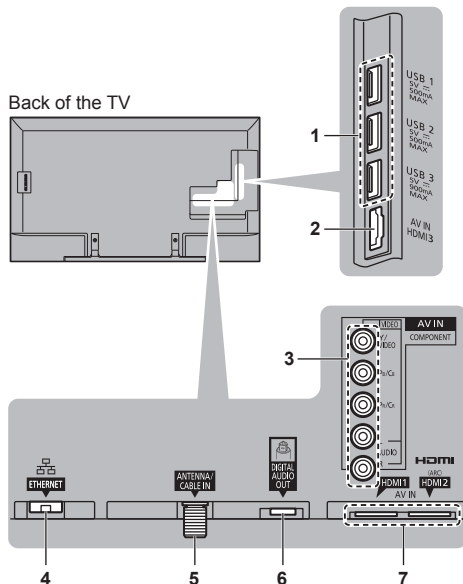

- 1 USB1/2/3
- 2 HDMI3
- 3 Component/Video terminal
- 4 Ethernet connector
- 5 Antenna cable in
- 6 Digital audio out
- 7 HDMI1/2

VHF/UHF Antenna

- NTSC (National Television System Committee): Analog television system
- ATSC (Advanced Television Systems Committee): Digital TV Standards include digital high-definition television (HDTV), standard-definition television (SDTV), data broadcasting, multi-channel surround sound audio and interactive television.

Power cord connection

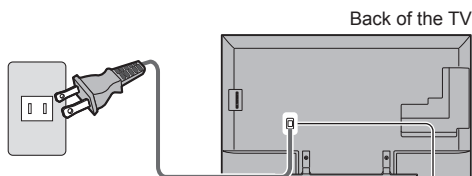

Power Cord

Connect after all other connections have been made.

To attach

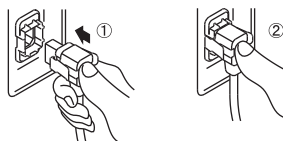

Insert it firmly until the tabs on both sides click into place.

To remove

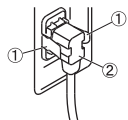

Keep pushing both sides until they snap and pull.

Antenna connection

Back of the TV

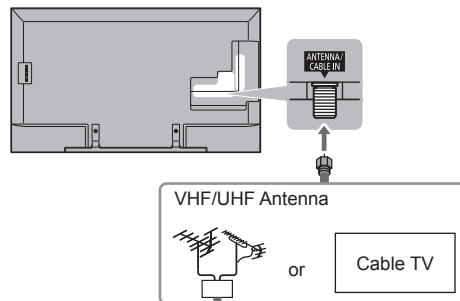

Cable

- You need to subscribe to a cable TV service to enjoy viewing their programming.
- A high-definition connection can be made using an HDMI or Component Video cable. (p. 11)

Note

- When using a Cable box, external equipment and video cables shown in this manual are not supplied with the TV.
- For additional assistance, visit us at: www.panasonic.ca/english/support

Connections for 4K contents

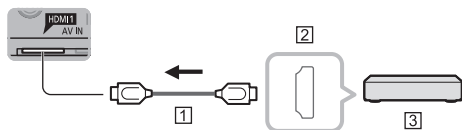

- ① HDMI cable
- ② HDMI AV OUT
- ③ 4K compatible equipment
 - To watch contents of 4K format, connect the 4K compatible equipment to HDMI by using a 4K compatible cable.
 - Please refer to eHELP for more details.

HDMI auto setting (Setup menu)

Reproduces the image more precisely with the expanded color gamut when connecting the 4K compatible equipment. Select the mode depending on the equipment.

Mode1:

For better compatibility. Set to "Mode1" when the image or sound in HDMI input is not played properly.

Mode2:

For the 4K compatible equipment that has the function to output the image precisely with the expanded color gamut

- To change the mode
 1. Select the HDMI input mode connected to the equipment.
 2. Display the menu and select "HDMI auto setting" (Setup menu).
- For information about the valid format, refer to eHELP.
(Watching TV > 4K compatible equipment).

AV cable connection

To use HDMI terminals

(for best HD picture)

(Set-top-box / DVD recorder / Blu-ray Disc player / Camcorder / etc.)



- ① HDMI cable
- ② AV Equipment (e.g. Blu-ray Disc player)

For devices with DVI output

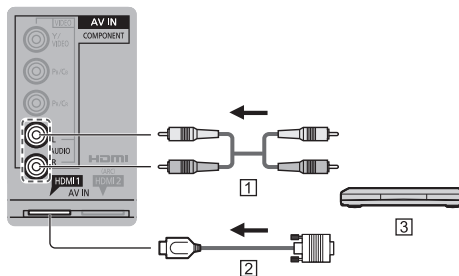

- ① Audio cable
- ② HDMI-DVI Conversion cable
- ③ AV Equipment (e.g. Blu-ray Disc player)

To use COMPONENT terminals

(DVD recorder / Blu-ray Disc player / etc.)

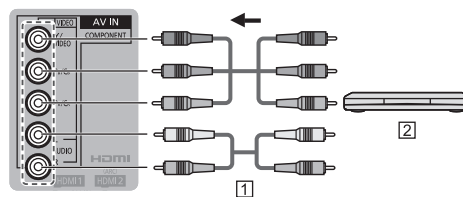

- ① Component cable
- ② AV Equipment (e.g. Blu-ray Disc player)

To use COMPOSITE terminals (for SD picture)

(Camcorder / Game system / DVD recorder / etc.)

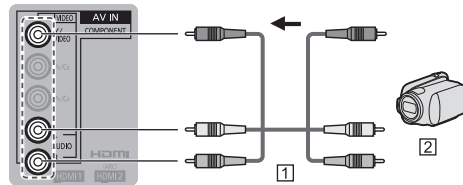

- ① VIDEO cable
- ② AV Equipment (e.g. Camcorder)

Note

- In some cases, it is not possible to connect depending on the type of cable or equipment.
- The Green terminal is shared for both the COMPONENT and COMPOSITE (VIDEO IN) connection. When using COMPOSITE (VIDEO IN) connection, the Yellow connector (VIDEO) should be inserted into Green connection.

Network connection

- To enable the network service functions, you need to connect the TV to a broadband network environment. If you do not have any broadband network services, please consult your retailer for assistance.
- Prepare the Internet environment for wired connection or wireless connection.

Wired connection

TV

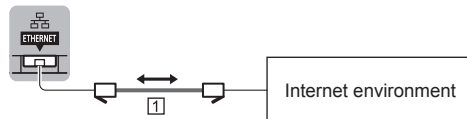

- 1 LAN cable (Shielded)

Wireless connection

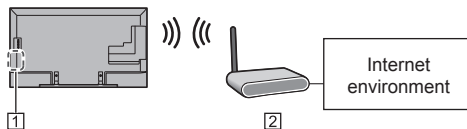

- 1 Built-in wireless LAN
2 Access point

About built-in wireless LAN

- To use the built-in wireless LAN, using an access point is recommended.
- To use the built-in wireless LAN in the access point mode, up to 7 devices are connectable. But the transfer rate will vary according to communication environment or connected equipments.
- Do not use the built-in wireless LAN to connect to any wireless network (SSID*1) for which you do not have usage rights. Such networks may be listed as a result of searches. However, using them may be regarded as illegal access.
- Check that the Access point supports WPS*2.
(If it does not support WPS, the encryption key of the Access point is required when configuring settings.)
- Follow the instructions on the Access point setup screen and configure the appropriate security settings.
For more details on setting of Access point, please refer to operating manual for the Access point.
- We recommend using 11n (5 GHz) for the wireless system between the built-in wireless LAN and Access point.
Communication is also possible with 11a, 11b, and 11g, but the communication speed may be slower.
- If the wireless system of the Access point is changed, devices that could connect by wireless LAN may no longer be able to connect.
- Data transmitted and received over radio waves may be intercepted and monitored.
- Keep the TV away from the following devices as much as possible:

Wireless LAN, microwaves, and other devices that use 2.4 GHz and 5 GHz signals. Otherwise, the TV failures such as malfunction may occur due to the radio wave interference.

- When noises occur due to the static electricity, etc., the TV might stop operating for the protection of the devices. In this case, turn the TV Off with power On / Off switch, then turn it On again.

*1 SSID is a name for identifying a particular wireless network for transmission.

*2 WPS: Wi-Fi Protected Setup

Audio connection

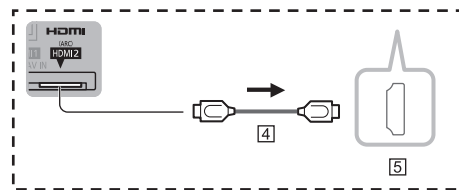
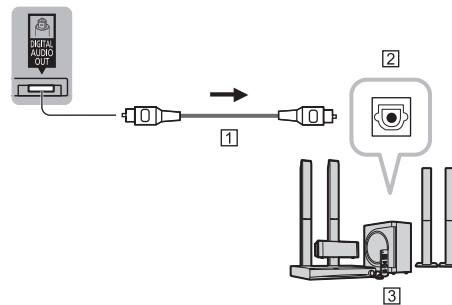

- 1 Optical cable
2 DIGITAL AUDIO IN
3 e.g. Amplifier with speaker system
4 HDMI cable
5 HDMI OUT (ARC)

HDMI connection is available if connected audio equipment has ARC (Audio Return Channel) function.

Identifying Controls

TV controls/indicators

Front of the TV

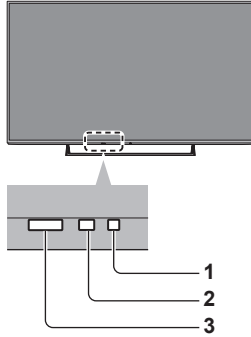

- 1 Power indicator (On: red, Off: no light)
- 2 C.A.T.S. (Contrast Automatic Tracking System)
- 3 Remote Control sensor

Maximum range for remote is 23 feet (7 meters) from front of TV set

Back of the TV

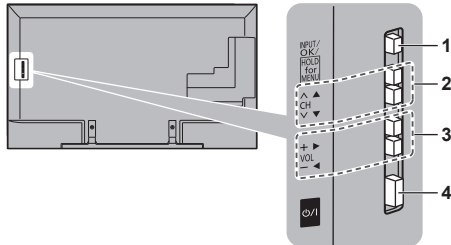

- 1 Changes the input mode
Selects Menu and Submenu entries
(Press and hold down for MENU function)
- 2 Selects channels in sequence
- 3 Volume up/down
- 4 POWER button
 - An image of the control panel is displayed on the screen while in use.



Note

- The TV consumes a small amount of electric energy even when turned off.
- Do not place any objects between the TV remote control sensor and remote control.

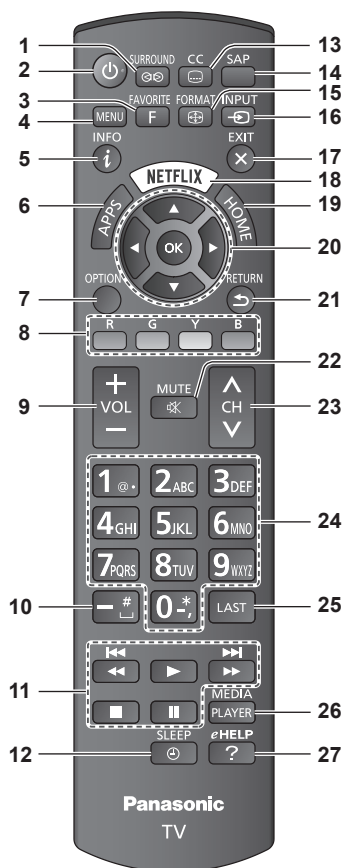
Remote Control



- 1 Switches surround sound setting
 - 2 Switches TV On or Off (Standby)
 - 3 Operates the Favorite channel list function
 - 4 Displays Menu
 - 5 Displays or removes the information banner
 - 6 Displays Apps (application) list
 - 7 Displays Option Menu for special functions (when available)
 - 8 Colored buttons (used for various functions)
 - 9 Volume up/down
 - 10 Use for digital channels
 - 11 External equipment operations
- * Functions are switched depending on connected external equipment and operation.

 : Press to skip to previous/next chapter or track etc.
 Press and hold to play fast rewind/forward.

12 Set Sleep timer

- 13 Closed caption On/Off
- 14 Selects Secondary Audio Programming
- 15 Changes aspect ratio and zoom
- 16 Selects source to watch
- 17 Returns to TV screen
- 18 Accesses NETFLIX service directly
 - This service requires an Internet connection.
 - This service might be stopped or the conditions changed without notice.
- 19 Displays Home screen
 - Please refer to eHELP for more details.
(Read first > Features)
- 20 Selects/OK/Change
- 21 Go back to previous menu
- 22 Sound mute On/Off
- 23 Channel up/down, when viewing from ANT/Cable source
- 24 Numeric keypad to select any channel or press to enter alphanumeric input in menus
- 25 Switches to previously viewed channel or input
- 26 Media player (Displays devices selection screen)
 - Please refer to eHELP for more details.
(Media player)
- 27 Displays eHELP (built-in manual) (p. 16)

Installing the remote's batteries

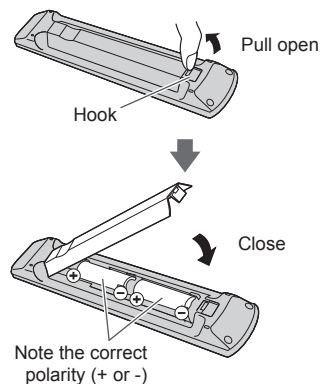

Caution

- Incorrect installation may cause battery leakage and corrosion, resulting in damage to the remote control.
 - Do not mix old and new batteries.
 - Do not mix different battery types (such as alkaline and manganese batteries).
 - Do not use rechargeable (Ni-Cd) batteries.
- Do not burn or break batteries.

First Time Setup

The first time setup screen is displayed only when the TV is turned on for the first time, after the power cord is inserted into a wall outlet.

1 Turn the TV on with the POWER button

(TV)

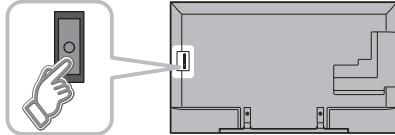

or

(Remote)

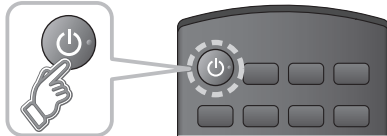

2 Setup the following items

- **Select your language**
- **Select your viewing mode**
(Be sure to select “Home Use”)

If you select the item other than “Home Use” by mistake, confirmation screen will be displayed.

To display the “Set viewing mode” screen again in order to select “Home Use”, perform one of the following actions:

- Press and hold down the rear POWER button for at least five seconds.
- Unplug the power cord for 30 seconds and then plug it in again.

- **Configure Network connection**

Follow the instructions on screen to complete the Network connection.

- **ANT/Cable setup**

Set up based on how your TV programming is connected. Select “Yes” if you are connected to a Cable, Satellite or Fiber Optic box. Select “No” if you are connected to the Antenna/Cable In with a coaxial wire into the screw-on connector. In this case you will need to scan for channels that are available in your area.

- **Adjust the Clock**

Select the clock mode and adjust other settings.

When “Auto” is selected, clock will be set automatically according to Time zone and DST. The TV must be connected to the Internet to use this feature.

- **Complete first time setup**

Completion screen is displayed.

Displays some information on the screen for several seconds.

To watch TV via a Cable box, Satellite receiver, or any other source (DVD, DVR, gaming device, etc.), press the INPUT button and select the appropriate input.

Using eHELP (Built-in Manual)

eHELP is a built-in manual that explains how to easily operate the TV's features. Press the eHELP button to access the guide.

1 Display eHELP

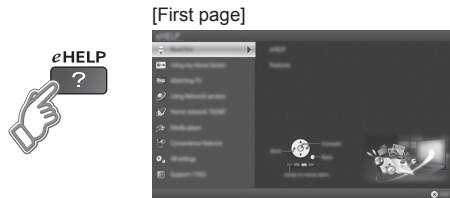

When you enter eHELP again after exiting, the confirmation screen is displayed while the TV is turned on. You can select "First page" or "Last viewed page".

2 Select the desired page from the menu

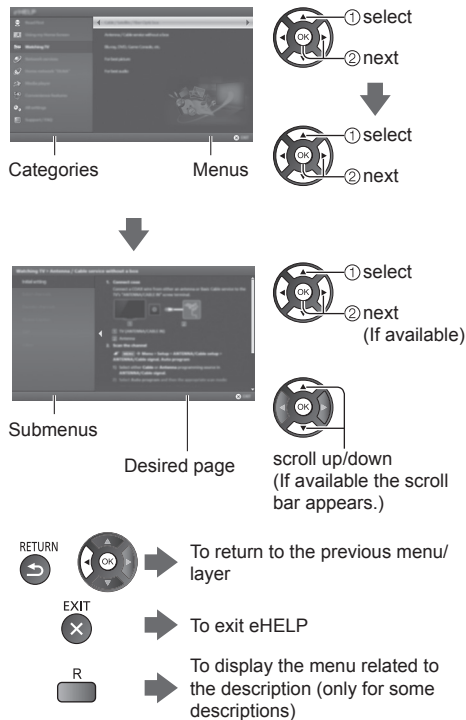

- To check the features of this TV
(Read first > Features)

Frequently Asked Questions (FAQ)

How can I confirm that my TV is working properly?

- The TV has a built-in Self Test. On the remote control, press MENU and scroll down and select HELP to access the TV SELF TEST. Run the test and follow the on screen instructions.

Why doesn't the remote control work?

- Check that the batteries are fresh, are of the same type and are installed with the correct polarity (+ & -).
- To operate other devices, such as changing channels when using Cable or Satellite boxes, or operating non-Panasonic Blu-ray players, use the remote supplied with the device.

Why is there no picture or just a blue, black or snowy screen being displayed?

- Ensure that the power cord is plugged in and the TV is turned on (front red LED light should be on, not blinking).
- Press the INPUT button on the remote to select the correct input source.
- Ensure all connections are correct and secure.
- When using external video source, such as a Cable/Satellite box or DVD player, ensure that the device is on and functioning correctly.
- Press MENU on the TV's remote control. If the menu is displayed, then the TV is working; recheck above steps.

The display panel moves slightly and clattered sound is heard when it is pushed with a finger.

- There is a little gap around the panel to prevent damage to the panel. This is not a malfunction.

Why is the screen blank and the power indicator blinking?

- The TV has gone into shutdown mode to protect itself. Try unplugging it for a few minutes and connecting it again. If there was a temporary power surge on the AC line it may now be OK. If the blinking returns, visit www.panasonic.ca/english/support.

Care and Cleaning

First, unplug the power cord plug from the wall outlet.

Display panel

The front of the display panel has been specially treated. Wipe the panel surface gently using only a cleaning cloth or a soft, lint-free cloth.

- If the surface is particularly dirty after cleaning up the dust, soak a soft, lint-free cloth in diluted, mild liquid dish soap (1 part mild liquid dish soap diluted by 100 times the amount of water), and then wring the cloth to remove excess liquid. Use this cloth to wipe the surface of the display panel, then wipe it evenly with a dry cloth of the same type until the surface is dry.
- Do not scratch or hit the surface of the panel with fingernails or other hard objects. Furthermore, avoid contact with volatile substances such as insect sprays, solvents, and thinner; otherwise, the quality of the surface may be adversely affected.

Cabinet

If the cabinet becomes dirty, wipe it with a soft, dry cloth.

- If the cabinet is particularly dirty, soak the cloth in diluted, mild liquid dish soap and then wring the cloth dry. Use this cloth to wipe the cabinet and then wipe it dry with a dry cloth.
- Do not allow any mild liquid dish soap to come into direct contact with the surface of the TV. If water droplets get inside the unit, operating problems may result.
- Avoid contact with volatile substances such as insect sprays, solvents, and thinner; otherwise, the quality of the cabinet surface may be adversely affected or the coating may peel off.
- Do not let articles made from rubber or PVC be in contact with the TV for long periods of time.

Pedestal

Cleaning

- Wipe the surfaces with a soft, dry cloth. If the unit is particularly dirty, clean it using a cloth soaked with water to which a small amount of mild liquid dish soap has been added and then wipe with a dry cloth. Do not use products such as solvents, thinner, or household wax for cleaning, as they can damage the surface coating.

Note: If using a chemically-treated cloth, follow the instructions supplied with the cloth.

- Do not attach sticky tape or labels, as they can make the surface of the pedestal dirty. Do not allow long-term contact with rubber, vinyl products, or the like. (Doing so will cause deterioration.)

Power cord plug

Wipe the plug with a dry cloth at regular intervals.

Note: Moisture and dust can lead to fire or electrical shock.

Specifications

Display Panel

Panel System

LCD panel with LED backlight

Refresh Rate

120 Hz

Screen size

- TC-55DX700C
55" class (54.6 inches measured diagonally)
- TC-65DX700C
65" class (64.5 inches measured diagonally)

W × H × Diagonal

- TC-55DX700C
47.6" × 26.7" × 54.6"
(1,210 mm × 680 mm × 1,388 mm)
- TC-65DX700C
56.2" × 31.6" × 64.5"
(1,428 mm × 804 mm × 1,639 mm)

Number of pixels

3,840 × 2,160

Speaker Output

20 W [10 W + 10 W]

Channel Capability (Digital/Analog)

VHF/ UHF: 2 - 69, CATV: 1 - 135

Operating Conditions

Temperature: 32 °F - 95 °F (0 °C - 35 °C)
Humidity: 20 % - 80 % RH (non-condensing)

Connection Terminals

VIDEO IN

RCA PIN (VIDEO, AUDIO-L, AUDIO-R)

COMPONENT IN

RCA PIN (Y, PB/CB, PR/CR, AUDIO-L, AUDIO-R)

HDMI IN 1/2/3

Type A connector
(supports "HDMI Control 5" function)

USB 1/2/3

Type A connector

USB 1/2: DC 5 V, Max. 500 mA
[Hi-Speed USB (USB 2.0)]
USB 3: DC 5 V, Max. 900 mA
[SuperSpeed USB (USB 3.0)]

DIGITAL AUDIO OUT

PCM / Dolby Digital / Fiber Optic

OTHERS

ETHERNET (10BASE-T/100BASE-TX)

Dimensions

Including pedestal (W × H × D)

- TC-55DX700C
48.9" × 30.2" × 9.3"
(1,242 mm × 768 mm × 235 mm)
- TC-65DX700C
57.6" × 35.7" × 14.7"
(1,463 mm × 907 mm × 373 mm)

TV Set only (W × H × D)

- TC-55DX700C
48.9" × 28.3" × 2.7"
(1,242 mm × 719 mm × 68 mm)
- TC-65DX700C
57.6" × 33.1" × 2.4"
(1,463 mm × 842 mm × 62 mm)

Mass

Including pedestal

- TC-55DX700C
47.4 lb. (21.5 kg) NET
- TC-65DX700C
64.0 lb. (29.0 kg) NET

TV Set only

- TC-55DX700C
43.0 lb. (19.5 kg) NET
- TC-65DX700C
56.3 lb. (25.5 kg) NET

Wireless LAN

Standard Compliance and Frequency Range^{*1, *2}

IEEE 802.11a/n: 5.15 GHz - 5.35 GHz,
5.47 GHz - 5.85 GHz
IEEE 802.11b/g/n: 2.400 GHz - 2.4835 GHz

Security

WPA2-PSK (TKIP/AES)
WPA-PSK (TKIP/AES)
WEP (64 bit/128 bit)

*1 The frequency and channel differ depending on the country.

*2 802.11b/g/n CH1 ~ CH11 only use for United States and Canada.

Note

- Design and Specifications are subject to change without notice. Mass and Dimensions shown are approximate.
- For the information about the power source and power consumption, refer to the nameplate on the rear enclosure.

■ When using the wall-hanging bracket

Please contact a professional installer to purchase the recommended UL qualified wall-hanging bracket. For additional details, please refer to the wall-hanging bracket installation manual.

Back of the TV

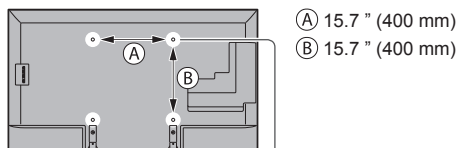

Holes for wall-hanging bracket installation

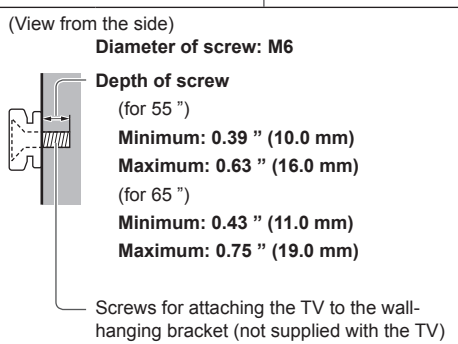

Warning

- Always be sure to ask a qualified technician to carry out set-up.
- Do not mount the unit directly below ceiling lights (such as spotlights, floodlights or halogen lights) that typically give off high heat. Doing so may warp or damage plastic cabinet parts.
- Take care when fixing wall brackets to the wall. Always ensure that there are no electrical cables or pipes in the wall before hanging bracket.
- To prevent fall and injury, remove the TV from its fixed wall position when it is no longer in use.
- Incorrect wall-hanging bracket or incorrect fitting may cause equipment to fall, resulting in injury and product damage.
- Panasonic disclaims liability for any damage or injury arising from incorrect wall-hanging bracket, incorrect fitting or otherwise failure to follow the above instructions.

Limited Warranty (for Canada)

Panasonic Canada Inc.
5770 Ambler Drive, Mississauga, Ontario L4W 2T3

PANASONIC PRODUCT – LIMITED WARRANTY

Panasonic Canada Inc. warrants this product to be free from defects in material and workmanship under normal use and for a period as stated below from the date of original purchase agrees to, at its option either (a) repair your product with new or refurbished parts, (b) replace it with a new or a refurbished equivalent value product, or (c) refund your purchase price. The decision to repair, replace or refund will be made by Panasonic Canada Inc.

TV (50" & over)	In-home service	One (1) year, parts (including panel) and labour.
TV (under 50")	Carry-in service	One (1) year, parts (including panel) and labour.

In-home Service will be carried out only to locations accessible by roads and within 50 km of an authorized Panasonic service facility.

In-home service requires clear, complete and easy access to the product by the Authorized Servicer and does not include removal or re-installation of an installed product. If removal is required to service the product, it will be at the discretion of the Servicer and in no event will Panasonic Canada Inc. or the Servicer be liable for any special, indirect or consequential damages.

This warranty is given only to the original purchaser, or the person for whom it was purchased as a gift, of a Panasonic brand product mentioned above sold by an authorized Panasonic dealer in Canada and purchased and used in Canada, which product was not sold "as is", and which product was delivered to you in new condition in the original packaging.

IN ORDER TO BE ELIGIBLE TO RECEIVE WARRANTY SERVICE HEREUNDER, A PURCHASE RECEIPT OR OTHER PROOF OF DATE OF ORIGINAL PURCHASE, SHOWING AMOUNT PAID AND PLACE OF PURCHASE IS REQUIRED

LIMITATIONS AND EXCLUSIONS

This warranty ONLY COVERS failures due to defects in materials or workmanship, and DOES NOT COVER normal wear and tear or cosmetic damage. The warranty ALSO DOES NOT COVER damages which occurred in shipment, or failures which are caused by products not supplied by Panasonic Canada Inc., or failures which result from accidents, misuse, abuse, neglect, mishandling, misapplication, alteration, faulty installation, set-up adjustments, misadjustment of consumer controls, improper maintenance, power line surge, lightning damage, modification, introduction of sand, humidity or liquids, commercial use such as hotel, office, restaurant, or other business or rental use of the product, or service by anyone other than a Authorized Servicer, or damage that is attributable to acts of God. Dry cell batteries are also excluded from coverage under this warranty.

THIS EXPRESS, LIMITED WARRANTY IS IN LIEU OF ALL OTHER WARRANTIES, EXPRESS OR IMPLIED, INCLUDING ANY IMPLIED WARRANTIES OF MERCHANTABILITY AND FITNESS FOR A PARTICULAR PURPOSE. IN NO EVENT WILL PANASONIC CANADA INC. BE LIABLE FOR ANY SPECIAL, INDIRECT OR CONSEQUENTIAL DAMAGES RESULTING FROM THE USE OF THIS PRODUCT OR ARISING OUT OF ANY BREACH OF ANY EXPRESS OR IMPLIED WARRANTY.

(As examples, this warranty excludes damages for lost time, travel to and from the Authorized Servicer, loss of or damage to media or images, data or other memory or recorded content. This list of items is not exhaustive, but for illustration only.)

In certain instances, some jurisdictions do not allow the exclusion or limitation of incidental or consequential damages, or the exclusion of implied warranties, so the above limitations and exclusions may not be applicable. This warranty gives you specific legal rights and you may have other rights which vary depending on your province or territory.

WARRANTY SERVICE

For product operation, repairs and information assistance, please visit our Support page on:

www.panasonic.ca/english/support

IF YOU SHIP THE PRODUCT TO A SERVICENTRE

Carefully pack and send prepaid, adequately insured and preferably in the original carton.
Include details of the defect claimed, and proof of date of original purchase.