

# Panasonic<sup>®</sup>

## Basic Owner's Manual

Digital Camera

Model No. **DC-G95D**



# LUMIX

Please read these instructions carefully before using this product, and save this manual for future use.

**More detailed owner's manual is available in "Owner's Manual for advanced features" (PDF format). To read it, download it from the website. (P93)**

### U.S. customers only

Register online at <http://shop.panasonic.com/support/register>

to receive these benefits:

- Safety Notification
- Owner Verification
- Efficient Warranty Service
- Special Offers and Promotions from Panasonic



If you have any questions, visit:

USA : <http://shop.panasonic.com/support>

Canada : [www.panasonic.ca/english/support](http://www.panasonic.ca/english/support)

DVQX2263ZA

F0422AJ0

**Dear Customer,**

***Thank you for choosing Panasonic!***

You have purchased one of the most sophisticated and reliable products on the market today. Used properly, we're sure it will bring you and your family years of enjoyment. Please take time to fill in the information below. The serial number is on the tag located on the underside of your camera. Be sure to **retain this manual** as your convenient camera information source.

Date of Purchase	Dealer Phone No.
Dealer Purchased From	Model No.
Dealer Address	Serial No.

Please note that the actual controls and components, menu items, etc. of your Digital Camera may look somewhat different from those shown in the illustrations in this Owner's Manual.

**Carefully observe copyright laws.**

- Recording of pre-recorded tapes or discs or other published or broadcast material for purposes other than your own private use may infringe copyright laws. Even for the purpose of private use, recording of certain material may be restricted.

**For the U.S.A. and Canada only**



A lithium ion battery that is recyclable powers the product you have purchased. Please call 1-800-8-BATTERY for information on how to recycle this battery.

## Information for Your Safety

### **WARNING:**

**To reduce the risk of fire, electric shock or product damage,**

- **Do not expose this unit to rain, moisture, dripping or splashing.**
- **Use the recommended accessories.**
- **Do not remove covers.**
- **Do not repair this unit by yourself. Refer servicing to qualified service personnel.**

The socket outlet shall be installed near the equipment and shall be easily accessible.

## ■ Product identification marking

Product	Location
Digital camera	Bottom
Battery charger	Bottom

### THE FOLLOWING APPLIES ONLY IN THE U.S.A.

#### FCC Note:

This equipment has been tested and found to comply with the limits for a Class B digital device, pursuant to Part 15 of the FCC Rules. These limits are designed to provide reasonable protection against harmful interference in a residential installation. This equipment generates, uses, and can radiate radio frequency energy and, if not installed and used in accordance with the instructions, may cause harmful interference to radio communications. However, there is no guarantee that interference will not occur in a particular installation. If this equipment does cause harmful interference to radio or television reception, which can be determined by turning the equipment off and on, the user is encouraged to try to correct the interference by one or more of the following measures:

- Reorient or relocate the receiving antenna.
- Increase the separation between the equipment and receiver.
- Connect the equipment into an outlet on a circuit different from that to which the receiver is connected.
- Consult the dealer or an experienced radio/TV technician for help.

#### FCC Caution:

- Any unauthorized changes or modifications to this equipment would void the user's authority to operate this device.
- To assure continued compliance, follow the attached installation instructions and use only shielded interface cables with ferrite core when connecting to computer or peripheral devices.

This device complies with Part 15 of the FCC Rules. Operation is subject to the following two conditions: (1) This device may not cause harmful interference, and (2) this device must accept any interference received, including interference that may cause undesired operation.

#### Supplier's Declaration of Conformity

Trade Name: Panasonic  
Model No.: DC-G95D  
Responsible Party: Panasonic Corporation of North America  
Two Riverfront Plaza, Newark, NJ 07102-5490  
Support Contact: <http://shop.panasonic.com/support>



---

## THE FOLLOWING APPLIES ONLY IN THE U.S.A.

### How to Display Certification and Compliance Information

Certification and compliance information for this camera can be viewed on the menu screen.

**MENU** →  **[Setup]** → **[Approved Regulations]**

Contains FCC ID: VPYLB1JS955

This transmitter must not be co-located or operated in conjunction with any other antenna or transmitter.

This equipment complies with FCC radiation exposure limits set forth for an uncontrolled environment and meets the FCC radio frequency (RF) Exposure Guidelines.

This equipment has very low levels of RF energy that is deemed to comply without testing of specific absorption rate (SAR).

---

## THE FOLLOWING APPLIES ONLY IN CANADA.

### How to Display Certification and Compliance Information

Certification and compliance information for this camera can be viewed on the menu screen.

**MENU** →  **[Setup]** → **[Approved Regulations]**

CAN ICES-003(B) / NMB-003(B)

Contains IC: 772C-LB1JS955

This device contains licence-exempt transmitter(s)/receiver(s) that comply with Innovation, Science and Economic Development Canada's licence-exempt RSS(s). Operation is subject to the following two conditions:

- (1) This device may not cause interference.
- (2) This device must accept any interference, including interference that may cause undesired operation of the device.

The available scientific evidence does not show that any health problems are associated with using low power wireless devices. There is no proof, however, that these low power wireless devices are absolutely safe. Low power Wireless devices emit low levels of radio frequency energy (RF) in the microwave range while being used. Whereas high levels of RF can produce health effects (by heating tissue), exposure of low-level RF that does not produce heating effects causes no known adverse health effects. Many studies of low-level RF exposures have not found any biological effects. Some studies have suggested that some biological effects might occur, but such findings have not been confirmed by additional research. DC-G95 (HMN is 1JS1904) has been tested and found to comply with ISED radiation exposure limits set forth for an uncontrolled environment and meets RSS-102 of the ISED radio frequency (RF) Exposure rules.

## ■ About the battery pack

### **CAUTION**

Battery pack (Lithium ion battery pack)

- Use the specified unit to recharge the battery pack.
- Do not use the battery pack with equipment other than the specified unit.
- Do not get dirt, sand, liquids, or other foreign matter on the terminals.
- Do not touch the plug terminals (+ and –) with metal objects.
- Do not disassemble, remodel, heat or throw into fire.

If any electrolyte should come into contact with your hands or clothes, wash it off thoroughly with water.

If any electrolyte should come into contact with your eyes, never rub the eyes. Rinse eyes thoroughly with water, and then consult a doctor.

### **CAUTION**

- Danger of explosion if battery is incorrectly replaced. Replace only with the type recommended by the manufacturer.
- When disposing of the batteries, please contact your local authorities or dealer and ask for the correct method of disposal.

- Do not heat or expose to flame.
- Do not leave the battery(ies) in a car exposed to direct sunlight for a long period of time with doors and windows closed.
- Do not expose to low air pressure at high altitudes.
- Do not expose to extremely low air pressure, as this may result in explosions or leakage of flammable liquids and gases.

### **Warning**

Risk of fire, explosion and burns. Do not disassemble, heat above 60 °C (140 °F) or incinerate.

## ■ About the AC adaptor (supplied)

### **CAUTION!**

**To reduce the risk of fire, electric shock or product damage,**

- **Do not install or place this unit in a bookcase, built-in cabinet or in another confined space. Ensure this unit is well ventilated.**

### **AC adaptor**

This AC adaptor operates on AC between 110 V and 240 V.

But

- In the U.S.A. and Canada, the AC adaptor must be connected to a 120 V AC power supply only.
- When connecting to an AC supply outside of the U.S.A. or Canada, use a plug adaptor to suit the AC outlet configuration.

- The AC adaptor is in the standby condition when the mains plug is connected. The primary circuit is always "live" as long as the mains plug is connected to an electrical outlet.

## **Cautions for Use**

- Do not use any other USB connection cables except the supplied one.
- Always use a genuine Panasonic shutter remote control (DMW-RS2: optional).
- Use a "High Speed HDMI micro cable" with the HDMI logo.  
Cables that do not comply with the HDMI standards will not work.  
"High Speed HDMI micro cable" (Type D–Type A plug, up to 2 m (6.6 feet) long)
- Do not use the headphone cables with the length of 3 m (9.8 feet) or more.
- Do not use the stereo microphone cables with the length of 3 m (9.8 feet) or more.

### **Keep this unit as far away as possible from electromagnetic equipment (such as microwave ovens, TVs, video games etc.).**

- If you use this unit on top of or near a TV, the pictures and/or sound on this unit may be disrupted by electromagnetic wave radiation.
- Do not use this unit near cell phones because doing so may result in noise adversely affecting the pictures and/or sound.
- Recorded data may be damaged, or pictures may be distorted, by strong magnetic fields created by speakers or large motors.
- Electromagnetic wave radiation may adversely affect this unit, disturbing the pictures and/or sound.
- If this unit is adversely affected by electromagnetic equipment and stops functioning properly, turn this unit off and remove the battery or disconnect AC adaptor. Then reinsert the battery or reconnect AC adaptor and turn this unit on.

### **Do not use this unit near radio transmitters or high-voltage lines.**

- If you record near radio transmitters or high-voltage lines, the recorded pictures and/or sound may be adversely affected.

- 
- **Before cleaning the camera, remove the battery or the DC coupler (DMW-DCC8: optional), or disconnect the power plug from the outlet.**
  - **Do not press the monitor with excessive force.**
  - **Do not press the lens with excessive force.**
  - **Do not spray the camera with insecticides or volatile chemicals.**
  - **Do not keep rubber or plastic products in contact with the camera for a long period of time.**
  - **Do not use solvents such as benzene, thinner, alcohol, kitchen detergents, etc., to clean the camera, since it may deteriorate the external case or the coating may peel off.**
  - **Do not leave the camera with the lens facing the sun, as rays of light from the sun may cause it to malfunction.**
  - **Always use the supplied cords and cables.**
  - **Do not extend the cords or the cables.**
  - **During access (image writing, reading and deleting, formatting etc.), do not turn this unit off, remove the battery, card or disconnect the AC adaptor. Furthermore, do not subject the camera to vibration, impact or static electricity.**
  - The data on the card may be damaged or lost due to electromagnetic waves, static electricity or breakdown of the camera or the card. We recommend storing important data on a PC etc.
  - Do not format the card on your PC or other equipment. Format it on the camera only to ensure proper operation.
- 
- **The battery is not charged when the camera is shipped. Charge the battery before use.**
  - **The battery is a rechargeable lithium ion battery. If the temperature is too high or too low, the operating time of the battery will become shorter.**
  - The battery becomes warm after using and during and after charging. The camera also becomes warm during use. This is not a malfunction.
  - **Do not leave any metal items (such as clips) near the contact areas of the power plug or near the batteries.**
  - Store the battery in a cool and dry place with a relatively stable temperature: (Recommended temperature: 15 °C to 25 °C (59 °F to 77 °F), Recommended humidity: 40%RH to 60%RH)
  - **Do not store the battery for a long time while fully charged.** When storing the battery for a long period of time, we recommend charging it once a year. Remove the battery from the camera and store it again after it has completely discharged.
-



# Contents

Information for Your Safety.....	2
----------------------------------	---

## Preparation/Basic

Care of the camera .....	10
Standard Accessories .....	11
About cards that can be used with this unit .....	12
About the Lens .....	13
Names and Functions of Components .....	14
Quick Start Guide .....	16
Basic Operations .....	25
Setting menu items .....	29
Quick Menu .....	30
Fn Buttons.....	30

## Recording

Easy Recording (Intelligent Auto Mode).....	31
Record Using MF .....	32
Selecting the Drive Mode .....	34
4K Photo Recording .....	34
Post Focus Recording.....	38
Bracket Recording.....	41
Live View Composite Recording .....	43
Image Stabilizer.....	44
Recording Motion Pictures .....	46
Creative Video Mode.....	49

## Playback

Playing Back Pictures .....	52
Playing Back Motion Pictures.....	52
Deleting Images .....	53

## Menu Guide

Menu Guide .....	54
------------------	----

## Wi-Fi/Bluetooth

What you can do with the Wi-Fi®/Bluetooth® function.....	65
Connecting to a Smartphone.....	67
Operating the Camera with a Smartphone.....	72

## Others

Importing Images to a PC.....	75
Monitor Display/Viewfinder Display .....	76
Troubleshooting .....	80
Specifications.....	85
Digital Camera Accessory System .....	92
Reading the Owner's Manual (PDF format).....	93
Limited Warranty (ONLY FOR U.S.A.).....	94
Limited Warranty (ONLY FOR CANADA) .....	97

## Care of the camera

### ■ Handling of the Camera

**Do not subject the camera to strong vibration, impacts, or pressure.**

**These may cause a malfunction or damage.**

- Do not drop or knock against hard surfaces.
- Do not push hard on the lens section or monitor.

**If sand, dust, or liquid gets on the monitor, wipe it off with a dry soft cloth.**

- If the monitor is closed when such liquids are present, malfunction may result.
- Touch operations may be incorrectly recognized.

**Do not place a hand inside the camera mount.**

**This may cause a failure or damage because the sensor is a precision device.**

**If you shake the camera while turning the camera off, a sensor may operate or a rattling sound may be heard. This is caused by the image stabilizer mechanism in the body. It is not a malfunction.**

### ■ Splash Resistant

**Splash Resistant is a term used to describe an extra level of protection this camera offers against exposure to a minimal amount of moisture, water or dust. Splash Resistant does not guarantee that damage will not occur if this camera is subjected to direct contact with water.**

**In order to minimize the possibility of damage please be sure the following precautions are taken:**

- Splash Resistant works in conjunction with the lenses that were specifically designed to support this feature.
- Securely close the doors, socket caps, contact points cover, flash, etc.
- When the lens or cap is removed or a door is open, do not allow sand, dust, and moisture to enter inside.
- If liquid gets on the camera, wipe it off with a dry soft cloth.

### ■ Condensation (When the Lens, the Viewfinder or Monitor is Fogged Up)

- Condensation occurs when there are temperature or humidity differences. Be careful because condensation can lead to stains or mold on the lens, viewfinder, and monitor or cause a failure.
- If condensation occurs, turn off the camera and leave it for approx. 2 hours. The fog will disappear naturally when the temperature of the camera becomes close to the ambient temperature.

**■ Also Refer to the Cautions for Use in the “Owner’s Manual for advanced features” (PDF Format)**

# Standard Accessories





Check that all the accessories are supplied before using the camera.  
Product numbers correct as of April 2022. These may be subject to change.

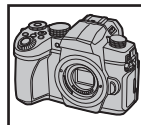







Digital Camera Body

(This is referred to as **camera body** in this owner's manual.)



1	Interchangeable Lens*1,2
2	Lens Hood
3	Lens Cap*3
4	Lens Rear Cap*3
5	Battery Pack (Indicated as <b>battery pack</b> or <b>battery</b> in the text) Charge the battery before use.
6	Battery Charger*4 (Indicated as <b>battery charger</b> or <b>charger</b> in the text)
7	AC Adaptor This is used for charging and power supply.
8	USB Connection Cable
9	Shoulder Strap
10	Body Cap*5
11	Hot Shoe Cover*5
12	Cover for the battery grip connector*5

DC-G95DM			
1	 H-FS12060	3	 VYF3514
2	 SYA0066	4	 VKF4605

5	 DMW-BLC12PP	8	 K1HY04YY0106	11	 SKF0106K
6	 DMW-BTC12 (A: DVLC1001Z)	9	 DVPW1001Z	12	 SKF0145K
7	 VSK0815F	10	 VKF4971		

\*1 This is referred to as **lens** in this owner's manual.

\*2 The interchangeable lens (H-FS12060) is dust and splash resistant.

\*3 This is attached to the interchangeable lens at the time of purchase.

\*4 Order the part number (A) to purchase only a battery charger.

\*5 This is attached to the camera body at the time of purchase.

• SD Memory Card, SDHC Memory Card and SDXC Memory Card are indicated as **card** in the text.

• **The card is optional.**

• Description in this owner's manual is based on the interchangeable lens (H-FS12060).

**(For U.S.A. only)**

• If accessories are lost, customers can visit us at <http://shop.panasonic.com/support> for further information about obtaining replacement parts.

**(For Canada only)**

• If any accessories are lost, customers in Canada should visit our support page at [www.panasonic.ca/english/support](http://www.panasonic.ca/english/support) for further information about obtaining replacement parts.

## About cards that can be used with this unit

<b>SD Memory Card</b> (512 MB to 2 GB)	<ul style="list-style-type: none"> <li>This unit is compatible with UHS-I/UHS-II UHS Speed Class 3 standard SDHC/SDXC memory cards.</li> <li>Operation of the cards on the left has been confirmed with Panasonic's cards.</li> </ul>
<b>SDHC Memory Card</b> (4 GB to 32 GB)	
<b>SDXC Memory Card</b> (48 GB to 128 GB)	

### ■ Recording of motion pictures/4K photos and speed class ratings

Use a card that meets the following ratings of the SD Speed Class or UHS Speed Class.

[Rec Format]	[Rec Quality]	Speed class	Label example
[AVCHD]	All	Class 4 or higher	CLASS <b>4</b> <b>4</b>
	FHD/HD		
[MP4]	4K	UHS Speed Class 3	<b>U3</b>

<b>When recording in High Speed Video/ 4K Photo/Post Focus</b>	UHS Speed Class 3	<b>U3</b>
--	-------------------	-----------

- Please confirm the latest information on the following website.

<https://panasonic.jp/support/global/cs/dsc/>

(This Site is English only.)

- Keep the memory card out of reach of children to prevent swallowing.



## About the Lens

This unit can use the dedicated lenses compatible with the Micro Four Thirds™ System lens mount specification (Micro Four Thirds mount).

You can also use a lens of any of the following standards by attaching a mount adaptor.



Lens	Mount adaptor
Four Thirds™ mount specification lens	 Mount Adaptor (DMW-MA1: optional)
Leica M Mount interchangeable lens	M Mount Adaptor (DMW-MA2M: optional)
Leica R Mount interchangeable lens	R Mount Adaptor (DMW-MA3R: optional)

For smoother recording, we recommend updating the firmware of the interchangeable lens to the latest version.

To check the firmware version of the interchangeable lens, attach it to the camera body and select [Version Disp.] in the [Setup] menu.

- **To view the latest information on the firmware or to download the firmware, visit the support site below:**

<https://panasonic.jp/support/global/cs/dsc/>

(This Site is English only.)



# Names and Functions of Components

## ■ Camera body

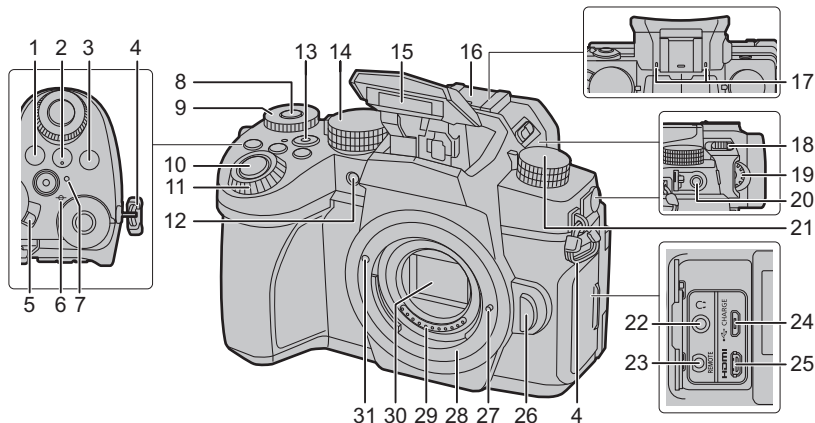

<b>1</b> [WB] (White Balance) button	<b>17</b> Stereo microphone • Be careful not to cover the microphone with your finger. Doing so may make sound difficult to record.
<b>2</b> [ISO] (ISO sensitivity) button	<b>18</b> [⚡] (Flash open lever) • The flash opens, and recording with the flash becomes possible.
<b>3</b> [±] (Exposure Compensation) button	<b>19</b> Diopter adjustment dial (P23)
<b>4</b> Shoulder strap eyelet (P16)	<b>20</b> [MIC] socket
<b>5</b> Camera ON/OFF switch (P22)	<b>21</b> Drive mode dial (P34)
<b>6</b> [∞] (Focus distance reference mark)	<b>22</b> Headphone socket • Excessive sound pressure from earphones and headphones can cause hearing loss.
<b>7</b> Charging lamp (P20)/ WIRELESS connection lamp (P65)	<b>23</b> [REMOTE] socket
<b>8</b> Dial operation switch button (P26)/ Fn button (Fn1) (P30)	<b>24</b> [USB/CHARGE] socket (P19)
<b>9</b> Rear dial (P25)	<b>25</b> [HDMI] socket
<b>10</b> Shutter button (P24)	<b>26</b> Lens release button (P21)
<b>11</b> Front dial (P25)	<b>27</b> Lens lock pin
<b>12</b> Self-timer indicator/ AF Assist Lamp	<b>28</b> Mount
<b>13</b> Motion picture button (P46)	<b>29</b> Contact points
<b>14</b> Mode dial (P27)	<b>30</b> Sensor
<b>15</b> Flash	<b>31</b> Lens fitting mark (P21)
<b>16</b> Hot shoe (Hot shoe cover) (P16) • Keep the hot shoe cover out of reach of children to prevent swallowing.	

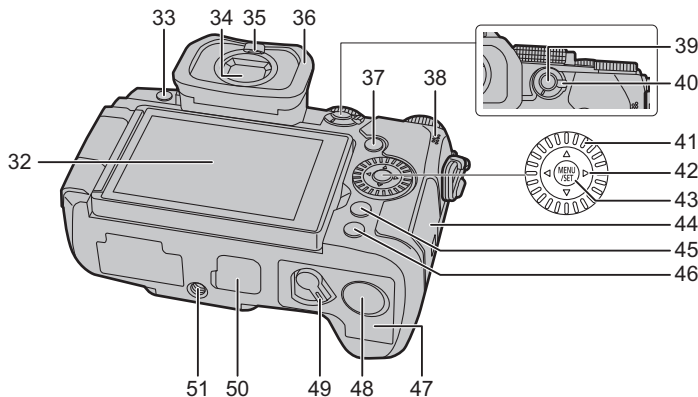

<b>32</b>	Touch screen (P28)/monitor (P76)	<b>47</b>	Battery door (P18)
<b>33</b>	[LVF] button (P28)/[Fn3] button (P30)		DC coupler cover
<b>34</b>	Viewfinder (P28)		• When using an AC adaptor, ensure that the Panasonic DC coupler (DMW-DCC8: optional) and AC adaptor (DMW-AC10PP: optional) are used.
<b>35</b>	Eye sensor (P28)	<b>48</b>	• Always use a genuine Panasonic AC adaptor (DMW-AC10PP: optional).
<b>36</b>	Eye cup		• When using an AC adaptor (optional), use the AC cable supplied with the AC adaptor (optional).
<b>37</b>	[▶] (Playback) button (P52)	<b>49</b>	Release lever (P18)
<b>38</b>	Speaker		Cover for the battery grip connector
<b>39</b>	[AF/AE LOCK] button	<b>50</b>	• Keep the cover for the battery grip connector out of reach of children to prevent swallowing.
<b>40</b>	Focus mode lever (P32)		Tripod mount
<b>41</b>	Control dial	<b>51</b>	• It may not be possible to attach and securely fasten a tripod with a screw length of 5.5 mm (0.22 inch) or more to the camera. Doing so may also damage the camera.
<b>42</b>	Cursor buttons (P25)/ ▲ Fn button (Fn9) (P30)/ ▶ Fn button (Fn10) (P30)/ ▼ Fn button (Fn11) (P30)/ ◀ [ ] (AF Mode) button		
<b>43</b>	[MENU/SET] button (P25, 29)		
<b>44</b>	Card door (P21)		
<b>45</b>	[Q.MENU] button (P30)/[Fn2] button (P30)/ [ ] (Delete) button (P53)/ [ ] (Cancel) button (P29)		
<b>46</b>	[DISP.] button		
			• <b>Fn buttons ([Fn4] to [Fn8]) are touch icons.</b>
			Touch the [Fn] tab on the recording screen to display them.

## ■ Lens

### H-FS12060

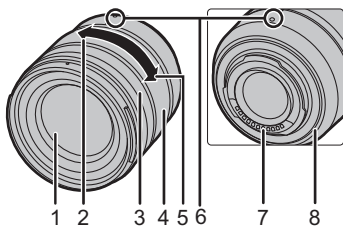

- |   |                         |
|---|-------------------------|
| 1 | Lens surface            |
| 2 | Tele                    |
| 3 | Focus ring              |
| 4 | Zoom ring               |
| 5 | Wide                    |
| 6 | Lens fitting mark (P21) |
| 7 | Contact points          |
| 8 | Lens mount rubber       |

## ■ Removing the Hot Shoe Cover

The camera comes with a hot shoe cover attached to the hot shoe.

Remove the hot shoe cover by pulling it in the direction indicated by arrow ② while pressing it in the direction indicated by arrow ①.

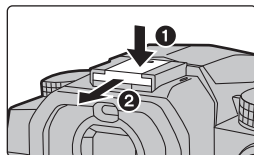

## Quick Start Guide

- Check that the camera is turned off.

### Attaching the Shoulder Strap

Attach the shoulder strap when using the camera to prevent it from dropping.

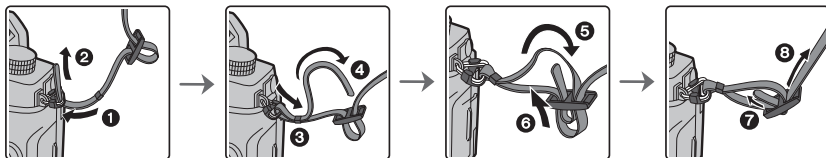



- In addition, attach the other side of the shoulder strap in the same manner.
- Use the shoulder strap around your shoulder.
  - Do not wrap the strap around your neck. It may result in injury or accident.
  - Do not leave the shoulder strap where an infant can reach it. It may result in an accident by mistakenly wrapping around the neck.

## Charging the Battery

You can charge the battery either using the supplied charger, or in the camera body. If you turn on the camera, you can also power it from a power outlet.

• **The battery that can be used with this unit is DMW-BLC12PP. (As of April 2022)**

● **The battery is not charged at the time of purchase. Charge the battery before use.**

### Charge the battery using the battery charger

**Charging time**

**Approx. 175 min**

- Use the supplied charger and AC adaptor.
- The indicated charging time is for when the battery has been discharged completely. The charging time may vary depending on how the battery has been used. The charging time for the battery in hot/cold environments or a battery that has not been used for a long time may be longer than normal.

- **Use the products supplied with the camera for charging.**
- Use the charger indoors.

- 1 Connect the battery charger (supplied) and the AC adaptor (supplied) with the USB connection cable (supplied).**
  - Check the direction of the terminals and plug in/out straight holding onto the plug. (It may result in malfunction by the deforming of the terminal if it is plugged in obliquely or in wrong direction.)
- 2 Insert the AC adaptor (supplied) into the power outlet.**

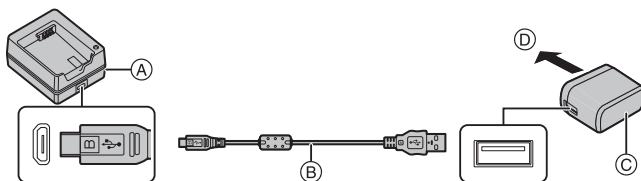

(A) Charger (supplied)

(B) USB connection cable (supplied)

(C) AC adaptor (supplied)

(D) To power outlet

**3 Insert the battery (E) in the correct direction.**

- The [CHARGE] indicator (F) lights up and charging begins.

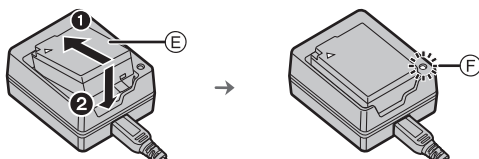

- Do not use any other USB connection cables except the supplied one.
- Do not use any other AC adaptors except the supplied one.
- The AC adaptor (supplied) and USB connection cable (supplied) are for this camera only. Do not use them with other devices.

**■ About the [CHARGE] indicator**

**On:** Charging.

**Off:** Charging has completed.

(After charging is complete, disconnect the AC adaptor (supplied) from the power outlet and remove the battery.)

**• When the [CHARGE] indicator flashes**

- The battery temperature is too high or too low. It is recommended to charge the battery again in an ambient temperature of between 10 °C and 30 °C (50 °F and 86 °F).
- The terminals of the charger or the battery are dirty. In this case, wipe them with a dry cloth.

**Battery Insertion**

- Always use genuine Panasonic batteries (DMW-BLC12PP).
- If you use other batteries, we cannot guarantee the quality of this product.

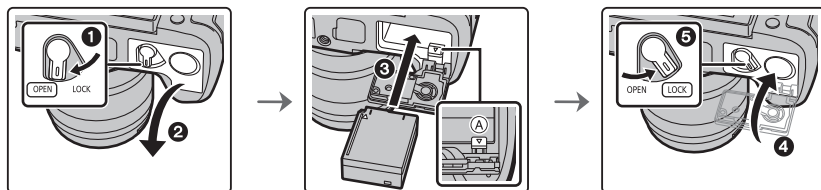

- Being careful about the battery orientation, insert all the way until you hear a locking sound and then check that it is locked by lever (A).

**■ To remove**

Push the lever (A) in the direction of the arrow to remove.

- Turn the camera off and wait for the “LUMIX” display on the monitor to clear before removing the battery.
- Remove the battery after use.

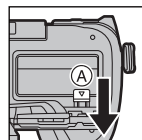

## Charge the battery using the camera

### Charging time

Approx. 180 min

- Using the camera body and the supplied AC adaptor. The camera is turned off.
  - The indicated charging time is for when the battery has been discharged completely. The charging time may vary depending on how the battery has been used. The charging time for the battery in hot/cold environments or a battery that has not been used for a long time may be longer than normal.
- **Use the products supplied with the camera for charging.**
  - The battery inserted in the Battery Grip (optional) cannot be charged.

- 1 Turn off the camera.**
- 2 Insert the battery into the camera.**
- 3 Connect the camera [USB/CHARGE] socket and the AC adaptor (supplied) with the USB connection cable (supplied).**

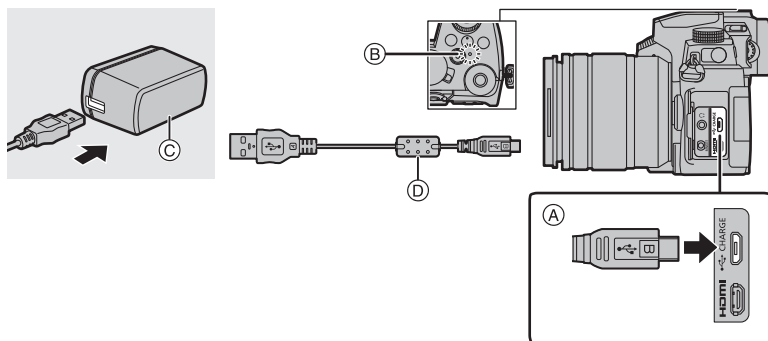

- A Connect the USB connection cable (supplied) to the [USB/CHARGE] socket.**
  - Place the camera in an upright position, and find the terminal at the top.
  - Check the direction of the terminals and plug in/out straight holding onto the plug. (It may result in malfunction by the deforming of the terminal if it is plugged in obliquely or in wrong direction.)

Do not connect devices to incorrect terminals. Doing so may cause malfunction.
- B Charging lamp**
- C AC adaptor (supplied)**
- D USB connection cable (supplied)**

- 4 Insert the AC adaptor (supplied) into the power outlet.**

- The camera consumes a small amount of power even after it is turned off by setting the camera ON/OFF switch to [OFF]. When leaving the product unused for a long time, disconnect the AC adaptor (supplied) from the power outlet for power saving.
- You can also charge the battery by connecting a USB device (PC, etc.) and the camera with the USB connection cable (supplied). In that case, charging may take a while.
- Do not use any other USB connection cables except the supplied one.
- Do not use any other AC adaptors except the supplied one.
- The AC adaptor (supplied) and USB connection cable (supplied) are for this camera only. Do not use them with other devices.

### ■ About the charging lamp

**Lit red:** Charging.  
**Off:** Charging has completed.  
(When charging is complete, disconnect the camera from the power outlet.)

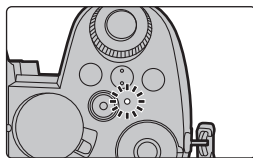



#### • When the charging lamp flashes

- Reconnect the USB connection cable (supplied) in a location where the ambient temperature (and the temperature of battery) is in a 10 °C to 30 °C (50 °F to 86 °F) range, and try charging again.
- If the USB device (PC etc.) is not capable of supplying sufficient power, charging is not possible.

### About the power supply

If you connect the camera to a power outlet (AC adaptor (supplied)) or the USB device (PC etc.) while the camera is turned on, power can be supplied via the USB connection cable (supplied).

- Insert the battery into the camera.
- [  ] is displayed on the recording screen while power is being supplied.
- **In certain situations where the camera is used, such as during recording, the battery may drain. The camera will turn off when the battery power runs out.**
- Before connecting or disconnecting the AC adaptor (supplied), turn the camera off.
- Power may not be supplied depending on the power supply capacity of the USB device (PC etc.).
- If the ambient temperature is high or power is supplied continuously, after [  ] is displayed, the supply of power may stop. Wait until the camera cools down.

## Inserting the Card (Optional)

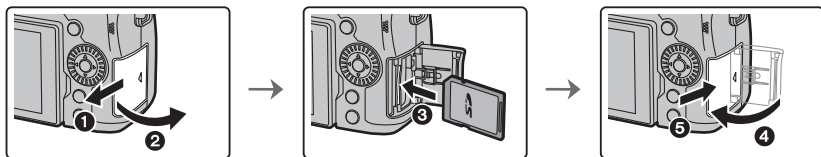

- Push it securely all the way until you hear a click while being careful about the direction in which you insert it.
- Do not touch the card terminals (A).

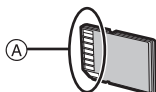

### ■ To remove

Insert until a clicking sound is heard and then pull it straight out.

- Turn the camera off and wait for the "LUMIX" display on the monitor to clear before removing the card.

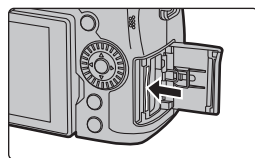

## Attaching a Lens

- Change lenses where there is not a lot of dirt or dust.

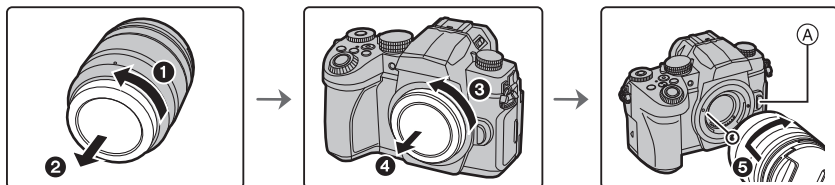

- Do not press the lens release button (A) when you attach a lens.

### ■ Remove a lens

- 1 Attach the lens cap.
- 2 While pressing on the lens release button (B), rotate the lens toward the arrow until it stops and then remove.

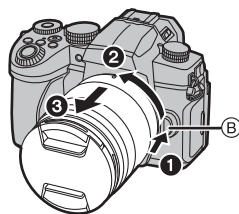

## Changing the Monitor Position

At the time when this camera is purchased, the monitor is stowed in the camera body. Bring out the monitor as shown below.

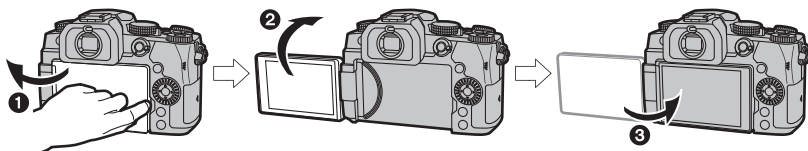

❶ Open the monitor. (It opens up to 180°.)

❷ It can be rotated 180° forward.

❸ Return the monitor to its original position.

- When rotating the monitor, be careful not to apply too much force. Doing so may cause damage.
- When not using the monitor it is recommended that you close it with the screen facing inward to prevent dirt and scratches.

## Setting the Clock (When Turning On for the First Time)

- The clock is not set when the camera is shipped.

- 1 Turn the camera on.
- 2 Press [MENU/SET].
- 3 Press ▲/▼ to select the language, and press [MENU/SET].
- 4 Press [MENU/SET].
- 5 Press ◀/▶ to select the items (year, month, day, hour, minute), and press ▲/▼ to set.
- 6 Press [MENU/SET] to set.
- 7 When [The clock setting has been completed.] is displayed, press [MENU/SET].
- 8 When [Please set the home area] is displayed, press [MENU/SET].
- 9 Press ◀/▶ to select the home area, and then press [MENU/SET].

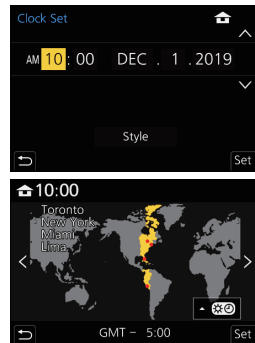
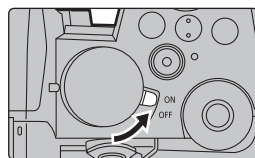

## Formatting the card (initialization)

Format the card before recording a picture with this unit.

**Since data cannot be recovered after formatting, make sure to back up necessary data in advance.**

**MENU** →  **[Setup]** → **[Format]**

## Adjusting the Viewfinder Diopter

Rotate the diopter adjustment dial until you can see the characters displayed in the viewfinder clearly.

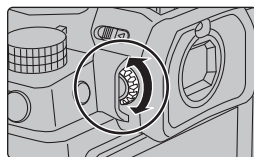

## Taking pictures

**1** Set the mode dial to **[iA]**.

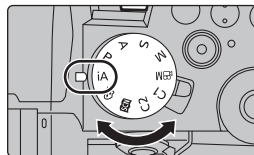

**2** Hold the camera gently with both hands, keep your arms still at your side and stand with your feet slightly apart.

- Do not cover the flash **(A)**, AF Assist lamp **(B)**, microphone **(C)**, or speaker **(D)** with your fingers or other objects.
- Make sure your footing is stable and there is no danger of colliding with another person or object in the vicinity while taking pictures.

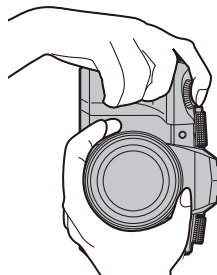
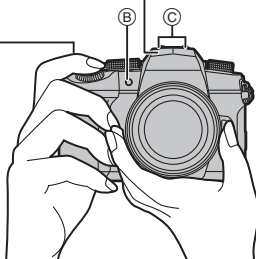
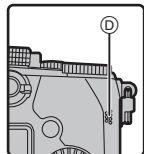
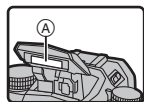

### 3 Press the shutter button halfway to focus.

- (A) Shutter speed
- (B) Aperture value
- (C) Focus indication

- Aperture value and shutter speed are displayed.

(It will flash in red if the correct exposure is not achieved, except when set to flash.)

- Once the subject is in focus, the focus indication is displayed. (When the subject is not in focus, the indication flashes.)

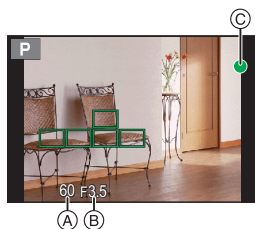
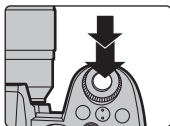
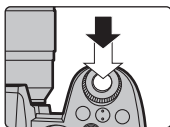

### 4 Press the shutter button fully (push it in further), and take the picture.

- Make sure that the camera does not move at the moment the shutter button is pressed.
- Pictures cannot be taken until focus is achieved when [Focus/Release Priority] is set to [FOCUS].
- To display the picture in Playback Mode, press [▶]. (P52)

#### ■ Free angle shooting

The monitor can be rotated to suit your needs. This is convenient as it allows you to take pictures from various angles by adjusting the monitor.

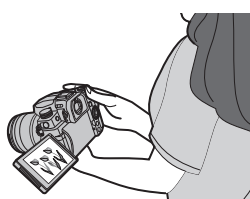
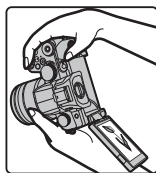
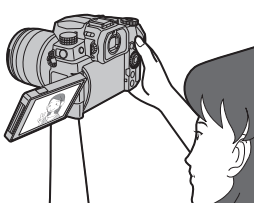
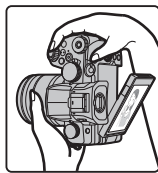

Taking pictures at a high angle

Taking pictures at a low angle



# Basic Operations

## Cursor buttons/[MENU/SET] button

**Pressing the cursor button:** Selects an item or numeric value.

- This owner's manual expresses the up, down, left, and right of the cursor button as ▲/▼/◀/▶.

**Pressing [MENU/SET]:** Confirms a setting.

- Displays the menu during recording and playback.

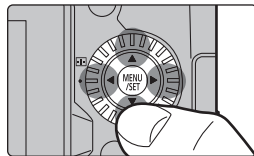

## Control Dial

**Rotating:** Selects an item or numeric value.

- This is expressed as follows in this document:
  - When rotating the control dial to the left or right: (⊙)

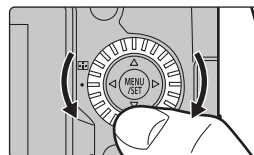



## Front Dial/Rear Dial

**Rotating:** Selects an item or numeric value.

- This owner's manual describes operations of the front dial/rear dial as follows:

<p>e.g.: When rotating the front dial to the left or right</p>	<p>e.g.: When rotating the rear dial to the left or right</p>

Allows you to set the aperture, shutter speed, and other settings when in P / A / S / M modes.

Mode dial	 Front dial	 Rear Dial
P	Program Shift	Program Shift
A	Aperture value	Aperture value
S	Shutter speed	Shutter speed
M	Aperture value	Shutter speed

### Temporarily changing the items assigned to the front/rear dials ([Dial Operation Switch])

#### 1 Set a Fn button to [Dial Operation Switch]. (P30)

- This function is set in Fn button (Fn1) at the time of purchase.

#### 2 Press the Fn button.

- A guide will be displayed showing the items temporarily assigned to the front/rear dials.
- If no operations are performed, the guide will disappear in a few seconds.

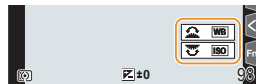

#### 3 Rotate the front/rear dials while the guide is displayed.

#### 4 Press [MENU/SET] and set.

- You can also complete this step by performing either of the operations below:
  - Press the shutter button halfway
  - Press the Fn button

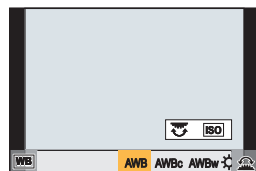

#### You can set the following settings in [Dial Set.] of the [Custom] ([Operation]) menu.



- Operation methods of the front/rear dials
- Operation method of the control dial
- Items to be assigned temporarily to the front/rear dials in [Dial Operation Switch]

## Mode dial (Selecting a Recording Mode)

Rotate the mode dial and select the recording mode.

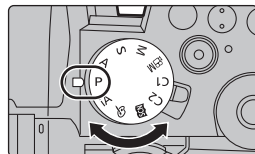
- Rotate the mode dial slowly to select the desired mode.



iA	<b>Intelligent Auto Mode (P31)</b>
	<b>Intelligent Auto Plus Mode (P31)</b>
P	<b>Programme AE Mode</b> The camera automatically sets the shutter speed and the aperture value according to the brightness of the subject.
A	<b>Aperture-Priority AE Mode</b> The shutter speed is automatically determined by the aperture value you set.
S	<b>Shutter-Priority AE Mode</b> The aperture value is automatically determined by the shutter speed you set.
M	<b>Manual Exposure Mode</b> The exposure is adjusted by the aperture value and the shutter speed which are manually adjusted.
 M	<b>Creative Video Mode (P49)</b>
C1C2	<b>Custom Mode</b> Use this mode to take pictures with previously registered settings.
 SCN	<b>Scene Guide Mode</b> This mode allows you to take pictures that match the scene being recorded.
	<b>Creative Control Mode</b> This mode records with additional image effects.

## [LVF] button (Switching the Monitor/Viewfinder)

### Press [LVF].

- Ⓐ [LVF] button
- Ⓑ Eye sensor

- The monitor/viewfinder will switch as follows:
  - Automatic viewfinder/monitor switching
  - Viewfinder display
  - Monitor display

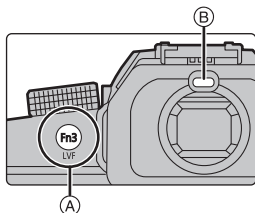

### ■ Notes on automatic viewfinder/monitor switching

Bring your eye or an object near the viewfinder to automatically switch to the viewfinder display using the eye sensor.

- To reduce the battery consumption, set [Power Save LVF Shooting] in [Economy].

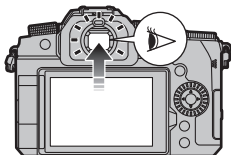

- When [Eye Sensor AF] is set to [ON] in the [Custom] ([Focus / Release Shutter]) menu, looking through the viewfinder will adjust focus.

## Touch screen (Touch operations)

### ■ Touch

To touch and release the touch screen.

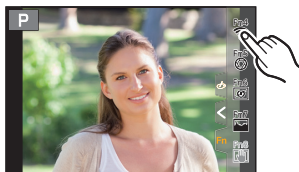

### ■ Drag

A movement without releasing the touch screen.

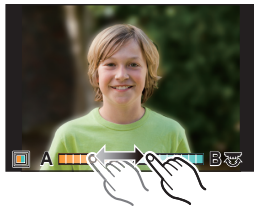

### ■ Pinch (enlarge/reduce)

On the touch screen, spread (pinch out) two fingers to zoom in and narrow (pinch in) them to zoom out.



# Setting menu items

You can either operate the buttons or touch the monitor to set menu items.

**1** Press [MENU/SET] to display the menu.

**2** Press ◀.

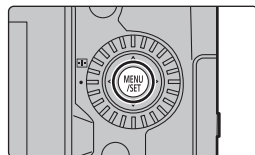

**3** Press ▲/▼ to select a menu selector icon, such as [📷].

- You can also select the menu toggle icons by rotating the front dial.



**4** Press [MENU/SET].

**5** Press ▲/▼ of the cursor button to select the menu item and press [MENU/SET].

- You can also move to the next screen by rotating the rear dial.

**6** Press ▲/▼ of the cursor button to select the setting and press [MENU/SET].

- Depending on the menu item, its setting may not appear or it may be displayed in a different way.

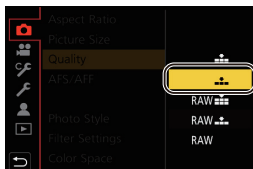

- You can also rotate the control dial to select the menu selector icon, menu item, or setting.

## ■ Close the menu

Press [DISP.] or press the shutter button halfway.



- Press [DISP.] to display the menu description.
- Menu items that are not available are displayed in gray. If you press [MENU/SET] while a gray item is selected, the reason why it cannot be set is displayed in some setting situations.

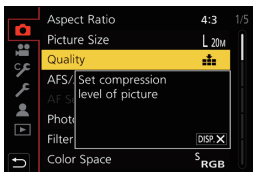

## Quick Menu

This menu enables you to quickly set functions that are frequently used during recording without calling the menu screen.

- 1 Press [Q.MENU] to display the Quick Menu.
- 2 Rotate the front dial to select the menu item.
- 3 Rotate the rear dial to select the setting.
- 4 Press [Q.MENU] to exit the Quick Menu once the setting is complete.

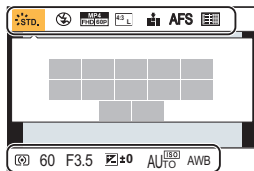

## Fn Buttons

You can register functions to the Fn (Function) buttons.

Different functions can be set for both during recording and playback.

- 1 Select the menu.

**MENU** → [Custom] → [Operation] → [Fn Button Set] → [Setting in REC mode]/[Setting in PLAY mode]

- 2 Press ▲/▼ to select the Fn button you want to assign a function to and then press [MENU/SET].
- 3 Press ▲/▼ to select the function you want to assign and then press [MENU/SET].

- To restore the default Fn button settings, select [Restore to Default].
- Select [Off] when not setting a function in the Fn button.

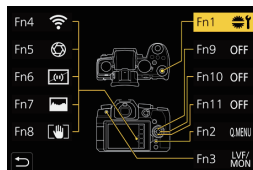

### ■ Fn button settings at the time of purchase

[Setting in REC mode]	[Fn1]: [Dial Operation Switch] [Fn2]: [Q.MENU] [Fn3]: [L.V.F/Monitor Switch] [Fn4]: [Wi-Fi] [Fn5]: [Preview]	[Fn6]: [Level Gauge] [Fn7]: [Histogram] [Fn8]: [I.S. Lock (Video)] [Fn9] to [Fn11]: No function is set by default.
[Setting in PLAY mode]	[Fn1]: [Wi-Fi]	[Fn3]: [L.V.F/Monitor Switch]

- If you press and hold a Fn button ([Fn1] to [Fn3], [Fn9] to [Fn11]) for 2 seconds, the screen in step 3 can be displayed quickly. This screen, however, may not be displayed depending on conditions such as the function registered or the screen displayed.
- Some functions may not be available depending on the mode or the displayed screen.
- Some functions cannot be assigned depending on the Fn button.

# Easy Recording (Intelligent Auto Mode)

Recording Mode:  

The [iA] mode (Intelligent Auto mode) can record images using settings automatically selected by the camera.

The camera detects the scene to set the optimal recording settings automatically to match the subject and recording conditions.

## 1 Set the mode dial to [iA].

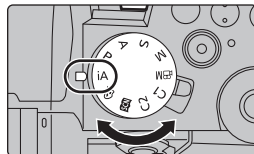

## 2 Hold the camera with the lens facing toward the subject.

- When the camera identifies the optimum scene, the icon of the scene concerned will change. (Automatic Scene Detection)





### ■ Switching between Intelligent Auto Plus Mode and Intelligent Auto Mode

#### 1 Select the menu.

**MENU** →   [Intelligent Auto] → [Intelligent Auto Mode]

#### 2 Press ▲/▼ to select [] or [] and then press [MENU/SET].

- [] allows you to adjust some settings such as the brightness and color tone while also using [] for other settings so that you can record pictures more suited to your preferences.
- At the time of purchase, the mode is set to Intelligent Auto Plus Mode.

### ■ [Intelligent Auto] menu

**MENU** →   [Intelligent Auto]

[iHandheld Night Shot]	• When [iHandheld Night Shot] is set to [ON] and [  ] is detected while taking handheld night shots, pictures of the night scenery will be taken at a high burst speed and composed into a single picture.
[iHDR]	• When [iHDR] is set to [ON] and there is, for example, strong contrast between the background and the subject, multiple still pictures are recorded with differing exposures and combined to create a single still picture rich in gradation.

## Taking pictures with customized color, defocus control, and brightness settings

Recording Mode:

### ■ Setting color

- 1 Press [WB].
- 2 Rotate the rear dial to adjust color.
  - To return to the recording screen, press [WB] again.
  - The color setting will return to the default level (center point) when this unit is turned off or the camera is switched to another Recording Mode.

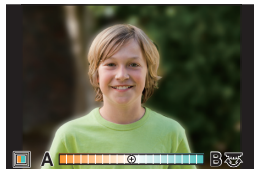

### ■ Taking a picture with a blurred background (Defocus Control)

- 1 Press [] to display the brightness setting screen.
- 2 Press the Fn button (Fn1) to display the setting screen.
- 3 Set the blurriness by rotating the rear dial.
  - To return to the recording screen, press [MENU/SET].
  - To cancel the setting, press [Fn2] on the blurriness setting screen.



### ■ Setting brightness

- 1 Press [].
- 2 Rotate the rear dial to adjust brightness.
  - In the [Custom] ([Operation]) menu, [Exposure Comp. Disp. Setting], you can change the functions to be set on the exposure compensation screen.
  - To return to the recording screen, press [] again.

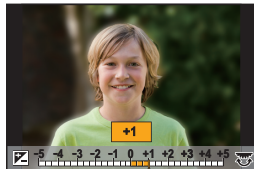

## Record Using MF

Applicable modes:

MF (Manual Focus) refers to manual focusing.

Use this function when you want to fix the focus or when the distance between the lens and the subject is determined and you do not want to activate AF.

- 1 Set the focus mode lever to [MF].
- 2 Press [] (◀).

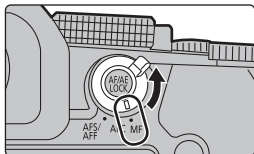



### 3 Press ▲/▼/◀/▶ to adjust the focus position, and press [MENU/SET].

- The assist screen is displayed, enlarging the area. (MF Assist)

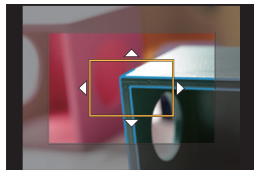

### 4 Adjust the focus.

- Ⓐ MF Assist (enlarged screen)
- Ⓑ Peaking
- Ⓒ MF Guide
- In-focus portions are highlighted with color. (Peaking)
- You can check whether the point of focus is to the near side or to the far side. (MF Guide)

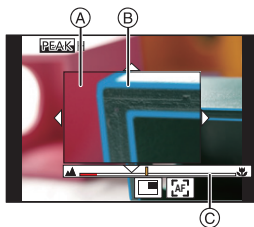

You can perform the following operations:

Button operation	Touch operation	Description of operation
▲/▼/◀/▶	Dragging	Moves the enlarged area.
	Pinching out/in	Enlarges/reduces the screen in small steps.
	—	Enlarges/reduces the screen.
		Switches the enlarged display (windowed/full screen).
[DISP.]	[Reset]	First time: The position of the enlarged area is reset to the center. Second time: The size is reset to the default.

### 5 Press the shutter button halfway.

- The recording screen will be displayed.
- MF Assist and MF Guide may not display depending on the lens used. To display MF Assist, use the touch screen or buttons to operate the camera directly.





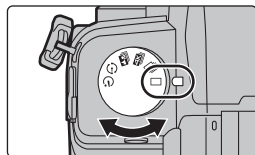

## Selecting the Drive Mode

Applicable modes:   **P** **A** **S** **M**   

You can change what the camera will do when you press the shutter button.

### Rotating the drive mode dial.



 <b>Single</b>	When the shutter button is pressed, only one picture is recorded.
 <b>Burst</b>	Recordings are made in succession while the shutter button is pressed.
 <b>4K PHOTO (P34)</b>	When the shutter button is pressed, a 4K photo is recorded.
 <b>Post Focus (P38)</b>	When the shutter button is pressed, Post Focus recording is performed.
 <b>Time Lapse Shot/ Stop Motion Animation</b>	Pictures are recorded with Time Lapse Shot or Stop Motion Animation.
 <b>Self Timer</b>	When the shutter button is pressed, recording takes place after the set time has elapsed.

## 4K Photo Recording





Applicable modes:   **P** **A** **S** **M**   

The camera allows you to take burst pictures of 8 million pixels (approx.) at 30 frames/second. After taking these pictures, you can save the desired moment extracted from their burst file.

- Use a UHS Speed Class 3 card.

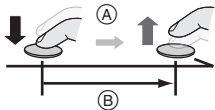
- 1 Set the drive mode dial to []. (P34)**
- 2 Select the recording method.**

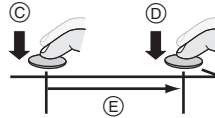
**MENU** →  **[Rec]** → **[4K PHOTO]** → **[Rec Method]**

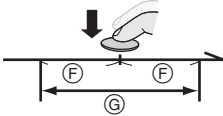
 <b>[4K Burst]</b>	<p><b>For capturing the best shot of a fast-moving subject</b></p> <p>Burst recording is performed while the shutter button is pressed and held.</p>  <ul style="list-style-type: none"> <li>• Press the button fully slightly in advance. Recording starts approximately 0.5 seconds after it has been pressed fully.</li> </ul> <p>(A) Press and hold (B) Recording is performed</p>
 <b>[4K Burst(S/S)]</b> “S/S” is an abbreviation of Start/Stop.	<p><b>For capturing unpredictable photo opportunities</b></p> <p>Burst recording starts when the shutter button is pressed and stops when pressed again.</p>  <ul style="list-style-type: none"> <li>(C) Start (First)</li> <li>(D) Stop (Second)</li> <li>(E) Recording is performed</li> </ul> <p> <b>Adding markers to select and save pictures</b></p> <p>You can add markers if you press [Fn2] during recording. (Up to 40 markers per recording) When selecting and saving pictures from a 4K burst file, you can skip to the positions where you added markers.</p>
 <b>[4K Pre-Burst]</b>	<p><b>For recording as needed whenever a photo opportunity arises</b></p> <p>Burst recording is performed for approximately 1 second before and after the moment that the shutter button is pressed.</p>  <ul style="list-style-type: none"> <li>(F) Approximately 1 second</li> <li>(G) Recording is performed</li> </ul>

**3 Press the shutter button halfway to exit the menu.**

**4 Press the shutter button to perform recording.**

- The camera will perform burst recording of a 4K photo and saves it as a 4K burst file with a [Rec Format] setting of [MP4].
- When [Auto Review] is enabled, the picture selection screen will be displayed automatically. To continue recording, press the shutter button halfway to display the recording screen.

#### ■ Preventing camera shake when you are recording pictures

To reduce camera shake, we recommend that you use a tripod and shutter remote control (DMW-RS2: optional) when using [Light Composition] or [Sequence Composition].

### ■ Setting Pre-Burst Recording ([4K Burst]/[4K Burst(S/S)])

The camera starts recording approximately 1 second before the shutter button is pressed fully, so you will not miss a photo opportunity.

**MENU** → [Rec] → [4K PHOTO] → [Pre-Burst Recording] → [ON]

- AF operation settings and menus that cannot be set while this function is in use are the same as those during [4K Pre-Burst] operation.

### ■ Setting Loop Recording ([4K Burst(S/S)])

You can perform recording while deleting the oldest recorded data, allowing you to keep on recording while waiting for a photo opportunity without replacing the card.

**MENU** → [Rec] → [4K PHOTO] → [Loop Recording(4K PHOTO)] → [ON]

- Once you start recording, the 4K burst file will be recorded and divided approximately every 2 minutes.  
Approximately the last 10 minutes (up to approximately 12 minutes) will be saved. The preceding part will be deleted.
- **We recommend that you use a sufficiently charged battery or an AC adaptor (optional) and DC coupler (optional).**
- If the surrounding temperature is high or 4K photos are recorded continuously, [] may be displayed and recording may be stopped halfway through. Wait until the camera cools down.
- When [] ([4K Pre-Burst])\* or [Pre-Burst Recording] is set, the battery drains faster and the camera temperature rises. Select only when recording.  
\* To protect itself, the camera may switch to [] ([4K Burst]).
- Files will be split up and saved and played back as smaller files in the following cases. (You can continue recording without interruption.)  
**When using an SDHC memory card:**  
If the file size exceeds 4 GB  
**When using an SDXC memory card:**  
If the continuous recording time exceeds 3 hours and 4 minutes or the file size exceeds 96 GB
- The angle of view becomes narrower.

## Selecting Pictures from a 4K Burst File

- 1 Select an image with the [] icon on the playback screen, and press **▲**.

- If the image was recorded with [4K Pre-Burst], proceed to step 3.



- 2 Drag the slide bar to make a rough selection of scenes.

- Touching [] allows you to switch to the marker operation screen.

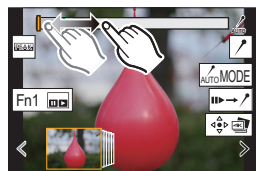

### 3 Drag the frames to select the frame you want to save as a picture.

- To continuously rewind/forward frame-by-frame, touch and hold [ < ]/[ > ].

### 4 Touch [ ] to save the picture.

- The picture will be saved in JPEG format.

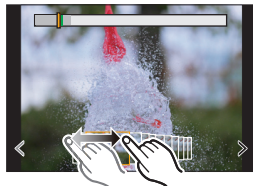

## Marker

When selecting and saving pictures from a 4K burst file, you can select pictures easily by skipping between marked positions.

#### White marker:

This is manually set during recording or playback.

#### Green marker:



This is automatically set by the camera during recording. (Auto Marking function\*1)

- \*1 The camera automatically sets markers on scenes in which a face or the movement of a subject is detected.  
(Example: At the scene when a vehicle passes by, a balloon bursts, or a person turns around)

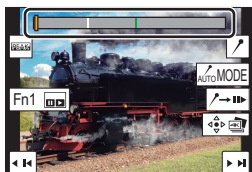
#### Marker operation screen



#### ■ Skips to the marked positions

Touching [  ] allows you to switch to the marker operation screen, where you can press  to skip to the marked positions.

Touch [  ] to return to the original operation.

- Up to 10 markers are displayed for each file.
- In the following cases, markers may not be set by the Auto Marking function depending on the recording conditions and the status of subjects.
  - The camera is moving because of panning or jitter
  - The movement of a subject is slow/small
  - The subject is small
  - A face is not facing front

#### ■ Switches a marker to be displayed

Touch [  ].

**Settings:** [Auto]/[Face Priority]/[Motion Priority]/[Off]\*2

- \*2 Displays manually set markers only.

## [4K PHOTO Bulk Saving]

You can save pictures of a 4K burst file that were extracted from any 5 second period at once.

- When Auto Review is set, the slide view screen is displayed automatically after 4K photo recording. Press the shutter button halfway to display the recording screen, and then follow the steps below.

### 1 Select the menu.

**MENU** →  **[Playback]** → **[4K PHOTO Bulk Saving]**

### 2 Press to select the 4K photo burst files and press **[MENU/SET]**.

- If the burst time is 5 seconds or less, all frames will be saved as pictures.

### 3 Select the first frame of the pictures to be saved at once.

- Select the frame in the same way as you select pictures from a 4K burst file.
- Pictures will be saved as a group of Burst Mode pictures in JPEG format.

## Post Focus Recording

Applicable modes:   **P** **A** **S** **M**   

The camera allows you to take 4K burst pictures while shifting the focus to different areas. After taking these pictures, you can select the desired focus area.

This function is suited for recording still objects.

- Use a UHS Speed Class 3 card.
- We recommend that you use a tripod when recording images to be used for Focus Stacking.

### 1 Set the drive mode dial to . (P34)

### 2 Decide on the composition, and press the shutter button halfway.

- AF will detect focus areas on the screen. (Excluding the edges of the screen)
- While the shutter button is pressed and held halfway, shake may be seen on the screen.
- If no areas on the screen can be brought into focus, the focus display (A) will flash. Recording is not possible in this case.



**From the time you press the shutter button halfway until the end of recording:**

- Maintain the same distance to the subject and the same composition.

### 3 Press the shutter button fully to start recording.



- The focus point changes automatically while recording. When the icon (B) disappears, recording automatically ends.
  - A motion picture will be recorded with [Rec Format] set to [MP4]. (Audio will not be recorded.)
  - When [Auto Review] is enabled, a screen that lets you select the desired focus area will be displayed. (P39)
- When the ambient temperature is high or Post Focus recording is performed continuously, the camera may display [A] and recording may stop. Wait until the camera cools down.
  - During recording, the angle of view will be narrower.

## Selecting the Focus Position for the Picture to Save

### 1 Select an image with the [▲] icon on the playback screen, and press ▲.



### 2 Touch the desired focus area.

- If a picture that is in focus is not available for the selected area, a red frame will be displayed. You cannot save a picture in this case.
- You cannot select the edges of the screen.



Button operation	Touch operation	Description of operation
▲/▼/◀/▶/ 	Touching	Selects a focus area. • It cannot be selected during enlarged display.
		Enlarges the display.
		Reduces the display (during enlarged display).
Fn1		Switches to the Focus Stacking function. (P40)
—		In-focus portions are highlighted with color. ([Peaking]) • Switches in order of [PEAK OFF] → [PEAK L] ([LOW]) → [PEAK H] ([HIGH]).
[MENU/SET]		Saves the picture.

- You can fine-adjust the focus by dragging the slide bar during enlarged display. (You can also perform the same operation by pressing ◀/▶.)



### 3 Touch [ ] to save the picture.

- The picture will be saved in JPEG format.

## Focus Stacking

Save a picture with multiple focus positions merged.

- 1 Touch [MENU] in step 2 of “Selecting the Focus Position for the Picture to Save”.
- 2 Touch the merging method.

<b>[Auto Merging]</b>	Automatically selects pictures that are suited to be merged, and merges them into a single picture. <ul style="list-style-type: none"> <li>• Priority will be given to pictures with closer focus.</li> <li>• Perform the focus stacking and save the picture.</li> </ul>
<b>[Range Merging]</b>	Merges pictures with specified focus areas into a single picture.

(When [Range Merging] is selected)

- 3 Touch the desired focus area.

- Specify at least two areas.
- In-focus parts between the selected two points are indicated.
- Parts that cannot be selected are indicated in gray.
- To cancel the selection, touch the focus area again.

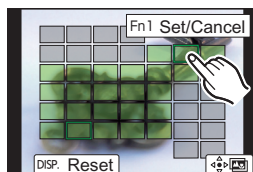
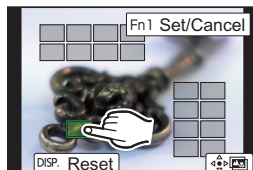

Button operation	Touch operation	Description of operation
	Touching	Selects an area.
<b>Fn1</b>		<b>[Set/Cancel]</b>
<b>[DISP.]</b>	<b>[All]</b>	Selects all areas. (Before selecting areas)
	<b>[Reset]</b>	Cancels all selections. (After selecting areas)
<b>[MENU/SET]</b>		Merges pictures and saves the resulting picture.

- 4 Touch [MENU/SET] to merge the pictures and save the resulting picture.

- The picture will be saved in JPEG format. Recording information (Exif information) of the original picture with the closest focus distance, including the shutter speed, aperture, and ISO sensitivity, will also be recorded to the new picture.







- The camera may automatically correct the misalignments of pictures caused by camera shake. If they are corrected, the angle of view becomes slightly narrower when pictures are merged.
- Pictures may be merged into an unnatural picture in the following cases:
  - When the subject moves during recording
  - When the distance between subjects is great
  - When pictures are too defocused (If you take pictures with a larger aperture value, the resulting picture may look less unnatural.)
- Focus Stacking may not be available for images recorded with other than this camera.

## Bracket Recording

Applicable modes:   **P** **A** **S** **M**   

You can take multiple pictures while automatically adjusting a setting by pressing the shutter button.

### 1 Select the menu.

[MENU] →  [Rec] → [Bracket] → [Bracket Type]	
 <b>Exposure Bracket</b>	Press the shutter button to perform recording while adjusting the exposure. (P42) • This does not work when recording with the flash.
 <b>Aperture Bracket</b>	Press the shutter button to perform recording while adjusting the aperture. (P42) • Available in Aperture-Priority AE Mode or when the ISO sensitivity is set to [AUTO] in Manual Exposure Mode.
FOCUS <b>Focus Bracket</b>	Press the shutter button to perform recording while adjusting the focus position. (P42)
WB  <b>White Balance Bracket</b>	Press the shutter button once to take three pictures with different white balance settings automatically. (P43)

### 2 Press ▲/▼ to select [More Settings] and then press [MENU/SET].

- For information on [More Settings], refer to the page that describes each function.
- Press the shutter button halfway to exit the menu.

### 3 Focus on the subject and take a picture.

- When Exposure Bracket is selected, the bracket display flashes until all of the pictures you have set are taken. If you change the bracket settings or turn off the camera before all of the pictures you have set are taken, the camera restarts recording from the first picture.

#### ■ To deactivate Bracket

Select [OFF] in step 1.

## Exposure Bracket

### ■ About [More Settings] (step 2 in P41)

<b>[Step]</b>	Sets the number of pictures to be taken and the exposure compensation range. [3•1/3] (Takes three pictures with an interval of 1/3 EV) to [7•1] (Takes seven pictures with an interval of 1 EV)
<b>[Sequence]</b>	Sets the order in which pictures are taken.
<b>[Single Shot Setting]<sup>*1</sup></b>	[□]: Takes one picture each time you press the shutter button. [☑]: Takes all the pictures set to be taken when you press the shutter button once.

\*1 Not available for burst recording. When using burst recording, if you press and hold the shutter button, recording will be performed continuously until a specified number of pictures are taken.

- When taking pictures using Exposure Bracket after setting the Exposure Compensation value, the pictures taken are based on the selected Exposure Compensation value.

## Aperture Bracket

Recording Mode: **A** **M**

### ■ About [More Settings] (step 2 in P41)

<b>[Image Count]</b>	[3], [5]: Takes a specified number of pictures with different aperture values within the range based on the initial aperture value. [ALL]: Takes pictures using all aperture values.
----------------------	---

- When using burst recording, if you press and hold the shutter button, recording will be performed until a specified number of pictures are taken.

## Focus Bracket

### ■ About [More Settings] (step 2 in P41)

<b>[Step]</b>	Sets the interval between focus positions.
<b>[Image Count]<sup>*2</sup></b>	Sets the number of pictures to be taken.
<b>[Sequence]</b>	[0/-/+]: Alternately moves the focus position closer and farther away within the range centered on the initial position as you take pictures. [0/+]: Moves the focus position farther away from the initial position as you take pictures.

\*2 Not available for burst recording. When using burst recording, if you press and hold the shutter button, recording will be performed continuously until a specified number of pictures are taken.

- Pictures taken with Focus Bracket are displayed as a set of group pictures.

## White Balance Bracket

### ■ About [More Settings] (step 2 in P41)

Rotate the control dial to adjust the correction range, and press [MENU/SET].

: Horizontal ([A] to [B])

: Vertical ([G] to [M])

• You can also set the correction range by touching .

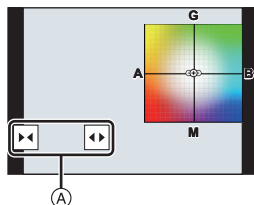

## Live View Composite Recording

Applicable modes: 

The camera records images at set exposure time intervals, and combines parts with changes in bright light to save the result as one picture.



A combined image is displayed at each exposure time interval, so you can keep recording while checking results.

With its ability to take pictures with reduced overall brightness, this function is useful for capturing the light trails of stars and fireworks with bright night scenery in the background.

**1** Set the mode dial to [M].

**2** Rotate the rear dial to set the shutter speed to [LC].

**3** Select the menu.

 →  [Rec] → [Live View Composite]

**4** Select the exposure time per frame (shutter speed).

- This can be set in a range of [1/2 SEC] to [60 SEC].
- Press the shutter button halfway to return to the recording screen.

**5** Press the shutter button fully to obtain an image with reduced noise.

- A countdown screen is displayed. Wait until this step completes.

**6** Press the shutter button fully to start recording.

- Images are combined every time the exposure time set in step 4 has passed.

**7** Press the shutter button fully again to stop recording.

- This will run noise reduction and save the image.
- Live View Composite can record up to 3 hours per recording.  
(Recording stops automatically when the recording time exceeds 3 hours.)

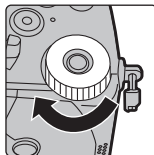

## ■ Screen indications during recording

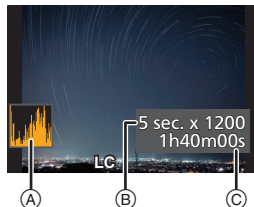

- Ⓐ Histogram display
  - After following step **5**, this is displayed automatically.
- Ⓑ Exposure time per frame × Number of pictures combined
- Ⓒ Elapsed time
  - The time is updated with each increase in the number of pictures combined.











- 💡 • We recommend using a tripod or the Shutter Remote Control (DMW-RS2: optional) for Live View Composite recording.
- We recommend that you use a sufficiently charged battery or an AC adaptor (optional) and DC coupler (optional).

- When the shutter button is pressed fully to stop recording, the last image may not be included in the combined image.

## Image Stabilizer

The camera can use both the in-body image stabilizer and the in-lens image stabilizer. Of the Dual I.S. modes that effectively combine two image stabilizers, this supports Dual I.S.2 ( , ,  ) with high correction efficiency. Furthermore, during motion picture recording, you can use the 5-Axis Hybrid Image Stabilizer that incorporates electronic stabilization.

- The image stabilizers to be activated differ depending on your lens. The icon for the currently activated image stabilizer is displayed on the recording screen.

Attached lens	Available image stabilizer	Icons displayed	
		When taking pictures	When recording motion pictures
<b>Panasonic lenses compatible with Dual I.S. Mode</b> (Based on the Micro Four Thirds System standard)	<b>Lens + Body</b> (Dual I.S.)	 /  /  / 	 / 
<b>Lenses compatible with the image stabilizer function</b> (Based on the Micro Four Thirds System standard/ Four Thirds System standard)	<b>Lens or Body</b>	 / 	

<b>Lenses without the image stabilizer function (Based on the Micro Four Thirds System standard/Four Thirds System standard)</b>	<b>Body</b>		
<b>When using a Leica lens mount adaptor (optional)/ Mount adaptor made by another manufacturer</b>	<b>Body</b>		

- The 5-Axis Hybrid Image Stabilizer function can be used with all lenses. Set [E-Stabilization (Video)] in [Stabilizer] to [ON] in the [Rec] menu. The recording screen displays the following icons when [ON] is set:
  - Panasonic lenses compatible with Dual I.S. Mode: [DUAL2] / [DUAL]
  - Other than the above:
- If the recording screen icon is not indicated with [DUAL2] or [DUAL] even when a supported lens is being used, update the lens firmware to the latest version. For the latest information on supported lenses or to download their firmware, refer to our website.

### ■ Using the Image Stabilizer

- When using a lens with an O.I.S. switch, set it to [ON].
- When using lenses without a function for communicating with this camera, a message asking you to check the focal length setting is displayed after you turn on the camera. Correctly operating the image stabilization function requires that the focal length be set to match the attached lens. Set the focal length in accordance as prompted by the message. This can also be set using the menu. (P46)

### Image Stabilizer Settings

Applicable modes: **P** **A** **S** **M**

Set the image stabilizer movement to match the recording situation.



**MENU** → **[Rec]/** **[Motion Picture]** → **[Stabilizer]**

<b>[Operation Mode]</b>	 (Normal)	Camera shake is corrected for up/down, left/right, and rotational movements.
	 (Panning)	Camera shake is corrected for up/down movements. This mode is ideal for panning (a method of taking pictures which involves turning the camera to track the movements of a subject which continues to move in a fixed direction).
	<b>[OFF]</b>	The image stabilizer does not work. ( • When using a lens with an O.I.S. switch, set the switch to [OFF].

<b>[E-Stabilization (Video)]</b>	<p>Jitter during motion picture recording is corrected along the vertical, horizontal, roll, pitch, and yaw axes by making use of the In-Lens Image Stabilizer, In-Body Image Stabilizer, and Electronic Image Stabilizer. (5-Axis Hybrid Image Stabilizer)</p> <p><b>[ON]/[OFF]</b></p> <ul style="list-style-type: none"> <li>• When [ON] is selected, the angle of view of recorded motion pictures may become narrower.</li> </ul>
<b>[I.S. Lock (Video)]</b>	<p>Allows you to enhance the image stabilization effect during motion picture recording.</p> <p><b>[ON]/[OFF]</b></p> <ul style="list-style-type: none"> <li>• This effect works only during recording. [ <li>• <b>To change the composition during recording, set the effect to [OFF] first, and then move the camera.</b></li> </li></ul> <p>Use an Fn button to switch between [ON]/[OFF] during recording. (P30)</p> <ul style="list-style-type: none"> <li>• [I.S. Lock (Video)] is not available when using other manufacturer's lenses with an image stabilization function.</li> </ul>
<b>[Focal Length Set]</b>	<p>When using lenses without a function for communicating with this camera, manually set the focal length.</p>

### Setting the focal length of a lens

- 1 Select the menu.

**MENU** →  **[Rec]/** **[Motion Picture]** → **[Stabilizer]** → **[Focal Length Set]**

- 2 Enter a focal length.

◀/▶: Select the item (digit); ▲/▼: Setting

- 3 Press **[MENU/SET]**.



- The Image Stabilizer may produce operational sound or cause vibration during its operation, but these are not malfunctions.
- It is recommended to disable the Image Stabilizer when using a tripod.

## Recording Motion Pictures

Applicable modes:   **P** **A** **S** **M**   

This camera can record full high definition motion pictures compatible with the AVCHD format or motion pictures recorded in MP4.

In addition, the camera can record 4K motion pictures in MP4.

Audio will be recorded in stereo.

## 1 Start recording by pressing the motion picture button.

- (A) Elapsed recording time
- (B) Available recording time

- Recording of motion picture appropriate for each mode is possible.
- The recording state indicator (red) (C) will lit while recording motion pictures.
- If no operation is performed, part of the information on the screen will gradually become darker after approximately 10 seconds has passed, and will no longer be displayed after approximately 1 minute has passed.

Pressing the [DISP.] button or touching the monitor will make the display reappear.

This operation is to prevent screen burn-in and is not a malfunction.

- Release the motion picture button right after you press it.
- Still picture recording is also possible during the motion picture recording by fully pressing the shutter button. (Except for in Creative Video Mode)

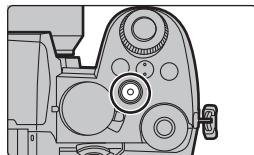

## 2 Stop the recording by pressing the motion picture button again.

### ■ Continuous motion picture recordable times

- [AVCHD] motion pictures:

You can continue recording without interruption even if the file size exceeds 4 GB, but the motion picture file will be divided.

- [MP4] motion pictures with a [Rec Quality] size of [FHD] or [HD]:

You can continue recording without interruption even if the continuous recording time exceeds 30 minutes or the file size exceeds 4 GB, but the motion picture file will be divided and recorded/played back separately.

- [MP4] motion pictures with a [Rec Quality] size of [4K]:

Motion picture file will be recorded and played back in separate files in the following cases. (You can continue recording without interruption.)

- When using an SDHC memory card: If the file exceeds 4 GB
- When using an SDXC memory card: If the continuous recording time exceeds 3 hours and 4 minutes or If the file exceeds 96 GB

- The maximum available continuous recording time is displayed on the screen.

### ■ [Rec Format]/[Rec Quality]

**MENU** → [Motion Picture] → [Rec Format]

Settings: [AVCHD]/[MP4]

**MENU** →  **[Motion Picture]** → **[Rec Quality]**

When **[AVCHD]** is selected

Item	Size	Recording frame rate	Sensor output	Bit rate
<b>[FHD/28M/60p]</b> <sup>*1</sup>	1920×1080	60p	60 frames/second	28 Mbps
<b>[FHD/17M/60i]</b>	1920×1080	60i	60 frames/second	17 Mbps
<b>[FHD/24M/30p]</b>	1920×1080	60i	30 frames/second	24 Mbps
<b>[FHD/24M/24p]</b>	1920×1080	24p	24 frames/second	24 Mbps

\*1 AVCHD Progressive

When **[MP4]** is selected

Item	Size	Recording frame rate	Sensor output	Bit rate
<b>[4K/100M/30p]</b> <sup>*2</sup>	3840×2160	30p	30 frames/second	100 Mbps
<b>[4K/100M/24p]</b> <sup>*2</sup>	3840×2160	24p	24 frames/second	100 Mbps
<b>[FHD/28M/60p]</b>	1920×1080	60p	60 frames/second	28 Mbps
<b>[FHD/20M/30p]</b>	1920×1080	30p	30 frames/second	20 Mbps
<b>[HD/10M/30p]</b>	1280×720	30p	30 frames/second	10 Mbps

\*2 4K motion pictures

#### ■ When recording 4K motion pictures

- When recording motion pictures in 4K, use a card rated as UHS Speed Class 3.
- When you record 4K motion pictures, the angle of view will be narrower than motion pictures of other sizes.
- To ensure highly accurate focus, 4K motion pictures are recorded at reduced AF speeds. It may be difficult to focus on the subject with AF, but this is not a malfunction.
- ISO sensitivity operates as [AUTO] (for motion pictures) during motion picture recording. In Creative Video Mode, you can set the ISO sensitivity for motion picture recording.
- In quiet recording environments, the sound of aperture and focus actions may be recorded. This is not a malfunction. You can set the focus operation during motion picture recording to [OFF] in [Continuous AF].
- When the ambient temperature is high or motion picture is recorded continuously, after [] is displayed, recording may stop to protect the camera. Wait until the camera cools down.



# Creative Video Mode

Recording Mode: 

It is possible to manually change the aperture, shutter speed and ISO sensitivity and record motion pictures.

- 1 Set the mode dial to [i/M].
- 2 Select the menu.

**MENU** →  **[Creative Video]** → **[Exposure Mode]** → **[P]/[A]/[S]/[M]**

- The operation for changing the aperture value or shutter speed is the same as the operation for setting the mode dial to P, A, S or M.
- Program Shift does not work.

## 3 Press the motion picture button (or shutter button) to start recording.

- The operational sound of the zoom or button operation may be recorded when it is operated during the recording of a motion picture.

Using touch icons allows silent operation while recording motion pictures.

- 1 Touch . (This cannot be used when recording with High Speed Video.)
- 2 Touch icon.

 **T**↑↓ : Zoom\*

**F** : Aperture value



**SS** : Shutter speed



 : Exposure Compensation

**ISO** : ISO sensitivity

 : Sound Rec level adjustment

- 3 Drag the slide bar to set.

/ : Changes the setting slowly

/ : Changes the setting quickly

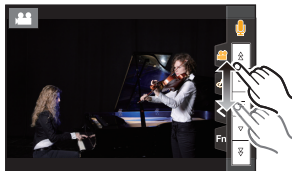

\* When using an interchangeable lens that supports power zoom (electronic zoom)

## 4 Press the motion picture button (or shutter button) again to stop recording.

### [High Speed Video]

Records slow motion pictures of MP4 format by performing ultra-high-speed recording.

- Use a UHS Speed Class 3 card.

- 1 Set the mode dial to [i/M].
- 2 Select the menu.

**MENU** →  **[Creative Video]** → **[High Speed Video]**

Settings	Frame rate (for recording)	[Rec Quality] (for storage)	Slow motion effect
[120fps/FHD]	120 frames/second	FHD/20M/30p	Approx. 1/4×
[90fps/FHD]	90 frames/second	FHD/20M/30p	Approx. 1/3×
[60fps/FHD]	60 frames/second	FHD/20M/30p	Approx. 1/2×
[OFF]	—		

- Press the motion picture button (or shutter button) to start recording.
- Press the motion picture button (or shutter button) again to stop recording.

- In the following case, the angle of view becomes narrower:
  - When [120fps/FHD] or [90fps/FHD] is set
- AF does not work.
- Audio is not recorded.
- When using an interchangeable lens with no focus ring, you cannot set focus with MF.
- Under fluorescent lighting, flicker or horizontal bars may be seen.

## [4K Live Cropping]

By cropping your motion picture down from the 4K angle of view to Full High Definition, you can record a motion picture that pans and zooms in/out while leaving the camera in a fixed position.

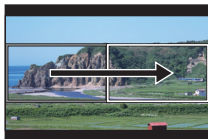

Pan

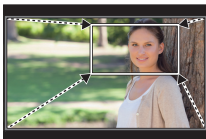

Zoom in

- [Rec Format] and [Rec Quality] in the [Motion Picture] menu will be fixed to [MP4] and [FHD/20M/30p], respectively.
- Hold the camera firmly in place while recording.
- The angle of view becomes narrower.

- Set the mode dial to [M].
- Select the menu.



**MENU** → **M [Creative Video]** → **[4K Live Cropping]** → **[40SEC]/[20SEC]**

### 3 Set the cropping start frame.

#### Ⓐ Cropping start frame

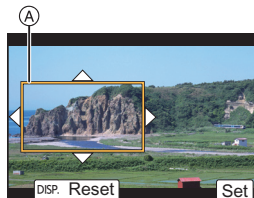
- When making settings for the first time, a cropping start frame of size 1920×1080 is displayed. (After setting the cropping start frame and end frame, the start frame and end frame that you set immediately before will be displayed.)
- The camera will remember the frame position and size even when the camera is turned off.



Button operation	Touch operation	Description of operation	
▲/▼/◀/▶	Touching	Moves the frame.	
 / 	—	Enlarges/reduces the frame in small steps.	The range of settings allowed is from 1920×1080 to 3840×2160.
	Pinching out/in	Enlarges/reduces the frame.	
[DISP.]	[Reset]	Returns the position of the frame to the center and its size to the default setting.	
[MENU/SET]	[Set]	Decides the position and size of the frame.	

### 4 Set the cropping end frame.

#### Ⓑ Cropping end frame

### 5 Press the motion picture button (or shutter button) to start recording.

- Immediately release the motion picture button (or the shutter button) after pressing it.
- When the set operating time has elapsed, recording automatically ends.  
To end recording midway, press the motion picture button (or the shutter button) again.

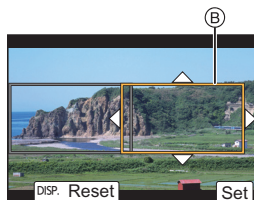

To add zoom in/out effects, set different angles of view for the cropping start and end frames. For example, to zoom in while recording, set a larger angle of view for the start frame and a smaller angle of view for the end frame.

#### ■ Changing the position and size of a crop frame

Press ◀ while the recording screen is displayed, and perform steps 3 and 4.

#### ■ To cancel [4K Live Cropping] recording

Set to [OFF] in [4K Live Cropping] in step 2.

- The setting of the AF Mode switches to [AF].  
(The eye to be brought into focus will not be indicated.)

## Playing Back Pictures

**1** Press [▶].

**2** Press ◀/▶.

- ◀: Play back the previous picture
- ▶: Play back the next picture

- If you press and hold ◀/▶, you can play back the pictures in succession.

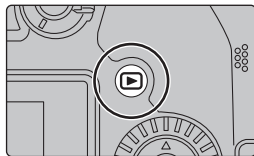

### ■ To finish playback

Press [▶] again or press the shutter button halfway.

## Playing Back Motion Pictures

This unit was designed to play motion pictures using the AVCHD and MP4 formats.

**Select an icon indicated with [A], and then press ▲ to play it back.**

(A) Motion picture recording time

- Touching [▶] in the middle of the screen allows you to play back motion pictures.



## ■ Operations during Motion Picture Playback

Button operation	Touch operation	Description of operation	Button operation	Touch operation	Description of operation
▲	▶/	Play/Pause	▼	■	Stop
◀	◀◀	Fast rewind* <sup>1</sup>	▶	▶▶	Fast forward* <sup>1</sup>
	◀	Frame-by-frame rewind (while pausing)* <sup>2</sup>		▶	Frame-by-frame forward (while pausing)
(⊙)	—	Reduce volume level	(⊙)	+	Increase volume level

\*1 The fast forward/rewind speed increases if you press ▶/◀ again.

\*2 When a motion picture recorded with [AVCHD] is rewound frame-by-frame, its frames will be shown in intervals of approximately 0.5 seconds.

● You can create a picture from a motion picture by pressing [MENU/SET] during a pause.

## Deleting Images

Once deleted, pictures cannot be recovered.

### ■ To delete a single picture

- 1 In Playback Mode, select the picture to delete and then press [⏏].
- 2 Press ▲/▼ to select [Delete Single] and then press [MENU/SET].

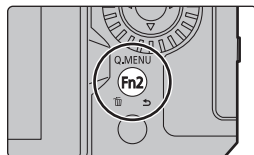

### ■ To delete multiple pictures (up to 100) or all the pictures

• Picture groups are treated as a single picture. (All the pictures in the selected picture group will be deleted.)

- 1 In Playback Mode, press [⏏].
- 2 Press ▲/▼ to select [Delete Multi] or [Delete All] and then press [MENU/SET].
  - After selecting [Delete All], if you select [Delete All Non-rating], you can delete all pictures except for those with ratings.

(When [Delete Multi] is selected)

- 3 Press ▲/▼/◀/▶ to select the picture, and then press [MENU/SET] to set. (Repeat this step.)
  - [⏏] appears on the selected pictures.
  - If [MENU/SET] is pressed again, the setting is canceled.
- 4 Press [DISP.] to execute.

● Depending on the number of pictures to be deleted, it may take some time to delete them.

# Menu Guide

This chapter provides a menu list and default settings. Menus explained in detail in other chapters are indicated with page numbers.

## ■ Displaying Descriptions About Menu Items and Settings

If you press [DISP.] while a menu item or setting is selected, a description of the menu is displayed.

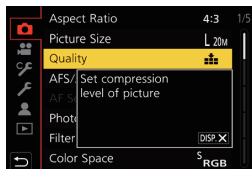

## Menus Displayed in Each Recording Mode

### IA IA+ [Intelligent Auto]

[Intelligent Auto Mode] (P31)

[iHandheld Night Shot]

[iHDR]

### 📹 [Creative Video]

[Exposure Mode] (P49)

[High Speed Video] (P49)

[4K Live Cropping] (P50)

### C [Custom Mode]

You can change the settings registered to custom sets (C2).

### SCN [Scene Guide]

[Scene Switch]

### 🌀 [Creative Control]

[Filter Effect]

[Simultaneous Record w/o Filter]

### 📷 [Rec]

[Aspect Ratio] (P56)

[Flash]

[Self Timer]

[Picture Size] (P57)

[Red-Eye Removal]

[Time Lapse/Animation]

[Quality] (P57)

[ISO Sensitivity (photo)]

[Live View Composite] (P43)

[AFS/AFF]

[Min. Shtr Speed]

[Panorama Settings]

[AF Sensitivity(Photo)]

[Long Shtr NR]

[Silent Mode]

[Photo Style] (P58)

[Shading Comp.]

[Shutter Type] (P61)

[Filter Settings]

[Diffraction Compensation]

[Shutter Delay]

[Color Space]

[Stabilizer] (P45)

[Bracket] (P41)

[Metering Mode] (P60)

[Ex. Tele Conv.]

[HDR]

[Highlight Shadow]

[Digital Zoom]

[Multi Exp.]

[i.Dynamic]

[Burst Rate]

[i.Resolution]

[4K PHOTO] (P34)

**[Motion Picture]**

[Rec Format] (P47)	[Highlight Shadow]	[Sound Rec Level Disp.]
[Rec Quality] (P48)	[i.Dynamic]	[Sound Rec Level Adj.]
[Snap Movie]	[i.Resolution]	[Sound Rec Level Limiter]
[AFS/AFF]	[ISO Sensitivity (video)]	[Wind Noise Canceller/ [Wind Cut]
[Continuous AF]	[Diffraction Compensation]	[Lens Noise Cut]
[AF Custom Setting(Video)]	[Stabilizer] (P44)	[Special Mic.]
[Photo Style] (P58)	[Flkr Decrease]	[Sound Output]
[Filter Settings]	[Ex. Tele Conv.]	
[Luminance Level] (P61)	[Digital Zoom]	
[Metering Mode] (P60)	[Picture Mode in Rec.]	

**[Custom]**

<b>[Exposure]</b>	<b>[Operation]</b>	[Highlight]
[ISO Increments]	[Fn Button Set] (P30)	[Zebra Pattern]
[Extended ISO]	[WB/ISO/Expo. Button]	[Expo.Meter]
[Exposure Comp. Reset]	[ISO Displayed Setting]	[MF Guide]
	[Exposure Comp. Disp. Setting]	[LVF/Monitor Disp. Set]
<b>[Focus / Release Shutter]</b>	[Q.MENU]	[Monitor Info. Disp.]
[AF/AE Lock]	[Dial Set.]	[Rec Area]
[AF/AE Lock Hold]	[Operation Lock Setting]	[Remaining Disp.]
[Shutter AF]	[Focus Ring Lock]	[Menu Guide]
[Half Press Release]	[Video Button]	
[Quick AF]	[Video Rec. Button (Remote)]	<b>[Lens / Others]</b>
[Eye Sensor AF]	[Touch Settings]	[Lens Position Resume]
[Pinpoint AF Setting]		[Power Zoom Lens]
[AF Assist Lamp]	<b>[Monitor / Display]</b>	[Lens Fn Button Setting]
[AF Assist Area]	[Auto Review]	[Aperture Ring Increment]
[Focus/Release Priority]	[Monochrome Live View]	[Face Recog.]
[Focus Switching for Vert / Hor]	[Constant Preview]	[Profile Setup]
[Loop Movement Focus Frame]	[Live View Boost]	
[AF Area Display]	[Peaking]	
[AF+MF]	[Histogram]	
[MF Assist]	[Guide Line]	
[MF Assist Display]	[Center Marker]	

**[Setup]**

[Cust.Set Mem.]	[Monitor Display]/ [Viewfinder]	[No.Reset]
[Clock Set] (P22)		[Reset]
[World Time]	[Monitor Luminance]	[Reset Network Settings]
[Travel Date]	[Eye Sensor]	[Pixel Refresh]
[Wi-Fi]	[Battery Use Priority]	[Sensor Cleaning]
[Bluetooth]	[USB Mode]	[Level Gauge Adjust.]
[Wireless Connection Lamp]	[USB Power Supply]	[Demo Mode]
[Beep]	[TV Connection]	[Approved Regulations]
[Headphone Volume]	[Language]	[Format] (P23)
[Economy]	[Version Disp.]	
[Monitor Display Speed]	[Folder / File Settings]	

**[My Menu]**

[My Menu Setting]
-------------------

**[Playback]**

[Slide Show]	[4K PHOTO Bulk Saving] (P38)	[Rotate]
[Playback Mode]	[Light Composition]	[Video Divide]
[Protect]	[Sequence Composition]	[Time Lapse Video]
[Rating]	[Clear Retouch]	[Stop Motion Video]
[Title Edit]	[Text Stamp]	[Rotate Disp.]
[Face Rec Edit]	[Resize]	[Picture Sort]
[RAW Processing] (P62)	[Cropping]	[Delete Confirmation]

**[Aspect Ratio]**

**Applicable modes:**

This allows you to select the aspect ratio of the pictures to suit printing or the playback method.

**MENU** → **[Rec]** → **[Aspect Ratio]**

<b>[4:3]</b>	[Aspect Ratio] of a 4:3 TV
<b>[3:2]</b>	[Aspect Ratio] of a 35 mm film camera
<b>[16:9]</b>	[Aspect Ratio] of a 16:9 TV
<b>[1:1]</b>	Square aspect ratio



**[Picture Size]**

Applicable modes:

The higher the numbers of pixels, the finer the detail of the pictures will appear even when they are printed onto large sheets.

**MENU** → **[Rec]** → **[Picture Size]**

Aspect ratio	Picture size		Aspect ratio	Picture size	
[4:3]	[L] (20M)	5184×3888	[16:9]	[L] (14.5M)	5184×2920
	[EXM] (10M)	3712×2784		[EXM] (8M)	3840×2160
	[EXS] (5M)	2624×1968		[EXS] (2M)	1920×1080
[3:2]	[L] (17M)	5184×3456	[1:1]	[L] (14.5M)	3888×3888
	[EXM] (9M)	3712×2480		[EXM] (7.5M)	2784×2784
	[EXS] (4.5M)	2624×1752		[EXS] (3.5M)	1968×1968

**[Quality]**

Applicable modes:

Set the compression rate at which the pictures are to be stored.

**MENU** → **[Rec]** → **[Quality]**

Settings	File format	Description of settings
[]	JPEG	A JPEG image in which image quality was given priority.
[]		A standard image quality JPEG image.
[RAW]	RAW+JPEG	You can record a RAW image and a JPEG image ([] or []) simultaneously.
[RAW]		
[RAW]	RAW	You can only record RAW images.

- RAW images are always recorded in the [4:3] (5184×3888) aspect ratio.
- When you delete an image recorded with [RAW] or [RAW], both the RAW and JPEG images will be deleted simultaneously.
- When you play back an image recorded with [RAW], gray areas corresponding to the aspect ratio at the time of recording are displayed.

**About RAW**

RAW format refers to a data format of images that have not been processed. Playback and editing of RAW images require the camera or the dedicated software.













- You can process RAW images in [RAW Processing] in the [Playback] menu. (P62)
- Use software (“SILKYPIX Developer Studio” (P75) by Ichikawa Soft Laboratory) to process and edit RAW files on a PC.

**[Photo Style]**

**Applicable modes:**   **P** **A** **S** **M**   

You can select effects to match the type of image you wish to record.

**MENU** →  **[Rec]** /  **[Motion Picture]** → **[Photo Style]**

 <b>[Standard]</b>	This is the standard setting.
 <b>[Vivid]</b>	Brilliant effect with high saturation and contrast.
 <b>[Natural]</b>	Soft effect with low contrast.
 <b>[Monochrome]</b>	Monochrome effect with no color shades.
 <b>[L.Monochrome]</b>	Black-and-white effect with rich gradation and crisp black accents.
 <b>[L.Monochrome D]</b>	Monochrome effect that creates a dynamic impression with enhanced highlights and shadows.
 <b>[Scenery]</b>	An effect appropriate for sceneries with vivid blue skies and greens.
 <b>[Portrait]</b>	An effect appropriate for portraits with a healthy and beautiful skin tone.
 <b>[Custom]</b>	Use the setting registered in advance.
 <b>[Cinelike D]</b>	Gives priority to the dynamic range by using a gamma curve designed to create film-like images. • Suited for editing.
 <b>[Cinelike V]</b>	Gives priority to the contrast by using a gamma curve designed to create film-like images.
 <b>[V-Log L]</b>	A gamma curve effect designed for post production editing. • It allows you to add rich gradation to images during post production editing.

• This can be set to [Standard] or [Monochrome] in Intelligent Auto Plus Mode.

## ■ Adjusting the picture quality

- 1 Press ◀/▶ to select the type of Photo Style.
- 2 Press ▲/▼ to select the items, and then press ◀/▶ to adjust.
  - You can register adjusted details to [Custom] by pressing [DISP].

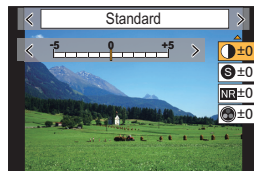

☐ [Contrast] <sup>*1</sup>	[+]	Increases the difference between the brightness and the darkness in the picture.
	[-]	Decreases the difference between the brightness and the darkness in the picture.
Ⓢ [Sharpness]	[+]	The picture is sharply defined.
	[-]	The picture is softly focused.
NR [Noise Reduction]	[+]	The noise reduction effect is enhanced. Picture resolution may deteriorate slightly.
	[-]	The noise reduction effect is reduced. You can obtain pictures with higher resolution.
● [Saturation] <sup>*1,2</sup>	[+]	The colors in the picture become vivid.
	[-]	The colors in the picture become natural.
● [Color Tone] <sup>*3</sup>	[+]	Adds a bluish tone.
	[-]	Adds a yellowish tone.
⊘ [Filter Effect] <sup>*3</sup>	[Yellow]	The blue sky can be recorded clearly.
	[Orange]	The blue sky can be recorded in darker blue.
	[Red]	The blue sky can be recorded in much darker blue.
	[Green]	The skin and lips of people appear in natural tones. Green leaves appear brighter and more enhanced.
	[Off]	—
⊠ [Grain Effect] <sup>*3</sup>	[Low]/ [Standard]/ [High]	Sets the graininess in a picture.
	[Off]	—

\*1 It cannot be adjusted when [V-Log L] is set.

\*2 Not displayed when [Monochrome], [L.Monochrome] or [L.Monochrome D] is selected.

\*3 Displayed when [Monochrome], [L.Monochrome] or [L.Monochrome D] is selected.

• If you adjust the picture quality, [+] is displayed beside the Photo Style icon on the screen.

- 3 Press [MENU/SET].

**[Metering Mode]**

**Applicable modes:** **P** **A** **S** **M**

Type of optical measurement to measure brightness can be changed.

**MENU** → **[Rec]** / **[Motion Picture]** → **[Metering Mode]**

	Brightness measurement position	Conditions
<b>[]</b> <b>Multiple</b>	Whole screen	Normal usage (produces balanced pictures)
<b>[]</b> <b>Center weighted</b>	Center and surrounding area	Subject in center
<b>[]</b> <b>Spot</b>	[+] (spot metering target)	Great difference between brightness of subject and background (e.g. person in spotlight on stage, backlighting)

**[Silent Mode]**

**Applicable modes:** **P** **A** **S** **M**

Disables operational sounds and output of light at once.

**MENU** → **[Rec]** → **[Silent Mode]**

**Settings: [ON]/[OFF]**

- Audio from the speaker will be muted and the flash and the AF Assist lamp will be disabled. The following settings are fixed.
  - [Flash Mode]: [] (forced flash off)
  - [Shutter Type]: [ESHTR]
  - [AF Assist Lamp]: [OFF]
  - [Beep Volume]: [] (OFF)
  - [E-Shutter Vol]: [] (OFF)
- Even when [ON] is set, the following lamp light up/flash.
  - WIRELESS connection lamp
  - Self-timer indicator
- Sounds that are produced by the camera regardless of your operations, such as the lens aperture sound, cannot be muted.
- **Be sure to pay special attention to the privacy, the likeness rights, etc. of the subject when you use this function. Use at your own risk.**

## [Shutter Type]

Applicable modes:   **P** **A** **S** **M**   

Select the shutter type to be used for taking pictures.

**MENU** →  **[Rec]** → **[Shutter Type]**

Settings: **[AUTO]/[MSHTR]/[EFC]/[ESHTR]**

	Mechanical shutter	Electronic Front Curtain	Electronic Shutter
Description	The camera starts and ends an exposure with the mechanical shutter.	The camera starts an exposure electronically, and ends it with the mechanical shutter.	The camera starts and ends an exposure electronically.
Flash	○	○	—
Shutter Speed (Sec.)	B (Bulb) <sup>*1</sup> / 60 to 1/4000	B (Bulb) <sup>*1</sup> / 60 to 1/2000	1 <sup>*2</sup> to 1/16000
Shutter sound	Mechanical shutter sound	Mechanical shutter sound	Electronic shutter sound

\*1 This setting is available only in Manual Exposure Mode.

\*2 When the ISO sensitivity is higher than [ISO3200], the shutter speed will be faster than 1 second.

- Compared to Mechanical Shutter Mode, Electronic Front Curtain Mode produces less shutter-induced shake, so it can minimize the influence of shutter vibration.
- Electronic Shutter Mode allows you to take pictures without causing shutter vibration.

## [Luminance Level]

Applicable modes:   **P** **A** **S** **M**   

Select the luminance range to match the use of motion picture.

- The recording format is set to [MP4].

**MENU** →  **[Motion Picture]** → **[Luminance Level]**

Settings: **[0-255]/[16-255]**

- This will be fixed at [16-255] when the [Rec Format] is [AVCHD].
- The setting is fixed at [0-255] in the following cases:
  - When taking pictures (including picture-taking during motion picture recording)
  - When [Photo Style] is set to [V-Log L]

**[RAW Processing]**

You can process the pictures taken in RAW format. The processed pictures will be saved in JPEG format.

**MENU** → **[Playback]** → **[RAW Processing]**

**1** Select RAW images with / , and then press **[MENU/SET]**.

**2** Press / to select an item.

- You can set the following items. The settings you used for the recording are selected when you start setting these items.



[White Balance]

[Highlight]

[Noise Reduction]

[Brightness correction]

[Shadow]

[i.Resolution]

[Photo Style]

[Saturation]/[Color Tone]

[Sharpness]

[i.Dynamic]

[Filter Effect]

[More Settings] (P63)

[Contrast]

[Grain Effect]

**3** Press **[MENU/SET]** and set.

**4** Press **[MENU/SET]**.

- This operation returns you to the screen in step **2**. To set other items, repeat steps **2** through **4**.

**5** Select **[Begin Processing]** with / , and then press **[MENU/SET]**.

### ■ How to set each item

Button operation	Touch operation	Description of operation
/ / /	<b>Dragging</b>	Selects a setting.
	<b>[WB K Set]</b>	Displays the screen that lets you set the color temperature. (when [White Balance] is set to [  ]/[  ]/[  ]/[  ])
	<b>[Adjust.]</b>	Displays the white balance adjustment screen. (when [White Balance] is set)
<b>[DISP.]</b>	<b>[DISP.]</b>	Displays the comparison screen.
<b>[MENU/SET]</b>	<b>[Set]</b>	Sets the adjusted level and returns you to the item selection screen.



- When [Noise Reduction], [i.Resolution] or [Sharpness] is selected, the comparison screen cannot be displayed.
- Each time you touch the screen twice, the display switches between enlarged and normal view.

On the comparison screen, you can use the following operations to make adjustments:

Ⓐ Current setting

Button operation	Touch operation	Description of operation
	<b>Dragging</b>	Selects a setting.
<b>[DISP.]</b>	<b>[DISP.]</b>	Returns you to the setting screen.
<b>[MENU/SET]</b>	<b>[Set]</b>	Sets the adjusted level and returns you to the item selection screen.



- If you touch the picture at the center, it will be enlarged. If you touch **[5]**, the picture will be reduced to the original size.

### ■ [More Settings] setting

Use ▲/▼ to select items and press [MENU/SET] to perform the following operations.

#### [Reinstate Adjustments]:

Returns the settings to the ones you used during the recording.

#### [Color Space]:

Allows you to select a [Color Space] setting from [sRGB] or [Adobe RGB].

#### [Picture Size]:

Allows you to select the size in which the image will be saved in JPEG format.

### [Sequence Composition]

Select multiple frames from a 4K burst file to create a sequence composition of a moving subject into one picture.

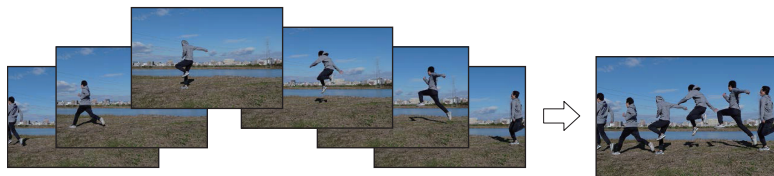

**[MENU]** → **[▶]** **[Playback]** → **[Sequence Composition]**

1 Press **◀/▶** to select the 4K photo burst files and press **[MENU/SET]**.

## 2 Select frames to combine.

Select the frames so that the moving subject will not overlap on the preceding or subsequent frames. (The sequence composition may not be created properly if the subject overlaps.)

- 1 Drag the slide bar or use ▲/▼/◀/▶ to select the frames to combine.
- 2 Press [MENU/SET].
  - The selected frames are remembered, and the display goes to the preview screen.
  - Press ▲/▼ to select items and press [MENU/SET] to perform the following operations.
    - [Next]: Lets you select more frames for combining.
    - [Reselect]: Discards the frame selected immediately before and lets you select a different image.
- 3 Repeat steps 1 and 2 to select more frames to combine.
  - You can select 3 to 40 frames.
- 4 Press ▲/▼ to select [Save], and then press [MENU/SET].



- Pictures are saved in JPEG format. Recording information (Exif information) of the first frame such as shutter speed, aperture, and ISO sensitivity are also registered.



### Tips for [Sequence Composition]

We recommend using a tripod to take pictures for [Sequence Composition].

### [Video Divide]

Recorded motion picture and 4K burst files can be divided in two. It is recommended for when you want to divide a part you need with a part you do not need.

**Dividing a file is permanent. Decide before you divide!**

**MENU** → **[Playback]** → **[Video Divide]**

- 1 Press ◀/▶ to select the file to divide, and then press [MENU/SET].
- 2 Press ▲ at the location to divide.
  - You can finely adjust the location for division by pressing ◀/▶ while the file is paused.
- 3 Press ▼.
  - The file may be lost if the card or battery is removed while processing the dividing.



- It may not be possible to divide a file at a point near the beginning or end.
- This function is not available in the following case:
  - When the recording time is short.



# What you can do with the Wi-Fi®/Bluetooth® function

- Remote shooting (P73)
- Playing back/saving images stored on the camera (P74)
- Editing motion pictures recorded with Snap Movie

## Connect to a smartphone that supports Bluetooth Low Energy to expand the scope of applications

- Pairing (connection setup) (P68)
- Camera Power Operations (P72)
- Shutter Remote Control
- Sending recorded images to a smartphone automatically
- Recording location information of a smartphone on recorded images
- Synchronizing the camera's clock with a smartphone

This owner's manual refers to both smartphones and tablets as smartphones from this point on unless noted otherwise.

- For details, refer to the "Owner's Manual for advanced features" (PDF format).

### ■ Before Use

#### • Set the clock. (P22)

- To use the Wi-Fi function on this unit, a wireless access point or a destination device equipped with the wireless LAN function is required.

### ■ About the WIRELESS connection lamp

<b>Lit blue</b>	When the Wi-Fi/Bluetooth function is ON or connected
<b>Blinking blue</b>	When sending image data by operating the camera

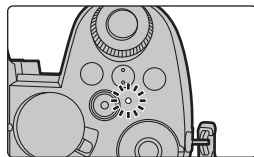

- In [Wireless Connection Lamp] in the [Setup] menu, you can set the lamp so that it will not light/flash.

### ■ About the [Wi-Fi] button

In this owner's manual, a Fn button to which [Wi-Fi] is assigned is referred to as the [Wi-Fi] button.

(By default, [Wi-Fi] is assigned to [Fn4] when the camera is in Recording Mode, while it is assigned to [Fn1] when the camera is in Playback Mode.)

- For information about the Fn button, refer to P30.

**Steps for pressing [Wi-Fi] (in Recording Mode)**

- 1 Touch [Fn].
- 2 Touch [  ].

**■ Use the camera as a wireless LAN device**

When using equipment or computer systems that require more reliable security than wireless LAN devices, ensure that the appropriate measures are taken for safety designs and defects for the systems used. Panasonic will not take any responsibility for any damage that arises when using the camera for any purpose other than as a wireless LAN device.

**■ Use of the Wi-Fi function of this camera is presumed to be in countries where this camera is sold**

There is the risk that the camera violates the radio wave regulations if used in countries other than those where this camera is sold, and Panasonic takes no responsibility for any violations.

**■ There is the risk that data sent and received via radio waves may be intercepted**

Please note that there is the risk that data sent and received via radio waves may be intercepted by a third party.

**■ Do not use the camera in areas with magnetic fields, static electricity or interference**

- Do not use the camera in areas with magnetic fields, static electricity or interference, such as near microwave ovens. These may cause the interruption of the radio waves.
- Using the camera near devices such as microwave ovens or cordless telephones that use the 2.4 GHz radio wave band may cause a decrease in performance in both devices.

**■ Do not connect to the wireless network you are not authorized to use**

When the camera utilizes its Wi-Fi function, wireless networks will be searched automatically. When this happens, wireless networks that you are not authorized to use (SSID\*) may be displayed, however do not attempt to connect to the network as it may be considered as unauthorized access.

- \* SSID refers to the name that is used to identify a network over a wireless LAN connection. If the SSID matches for both devices, transmission is possible.

# Connecting to a Smartphone

## Installing “Panasonic Image App”

“Panasonic Image App” is an application for smartphones provided by Panasonic.

### • OS

**App for Android™:** Android 4.4 or higher  
(Android 5.0 or higher is required to use the Bluetooth function.)

**App for iOS:** iOS 9.3 or higher  
(The Bluetooth function cannot be used with the iPad 2.)

- 1 Connect the smartphone to a network.
- 2 (Android) Select “Google Play™ Store”.  
(iOS) Select “App Store”.
- 3 Enter “Panasonic Image App” or “LUMIX” into the search box.
- 4 Select “Panasonic Image App”  and install it.

- Use the latest version.
- Supported OSs are current as of April 2022 and are subject to change.
- The service may not be able to be used properly depending on the type of smartphone being used.

Refer to the support site below for details about the “Image App”.

<https://panasonic.jp/support/global/cs/dsc/>

(This Site is English only.)

- When downloading the app on a mobile network, high packet communication fees may be incurred depending on the details of your contract.
- Read the [Help] in the “Image App” menu for further details on how to operate.
- When you operate the “Image App” on the smartphone that is connected to the camera via Wi-Fi, [Help] in the “Image App” may not be displayed depending on the smartphone. In this case, after terminating the connection to the camera, reconnect the smartphone to a mobile phone network such as the 3G or LTE network or to a Wi-Fi router, and then display [Help] in the “Image App”.
- Some of the screens and information provided in this owner’s manual may differ from your device depending on the supported OS and “Image App” version.



## Connecting to a Smartphone (Bluetooth Connection)

Follow a simple connection setup procedure (pairing) to connect to a smartphone that supports Bluetooth Low Energy.

When pairing is set up, the camera also automatically connects to the smartphone via Wi-Fi.

### • Supported smartphones

**Android:** Android 5.0 or higher equipped with Bluetooth 4.0 or higher (excluding those that do not support Bluetooth Low Energy)

**iOS:** iOS 9.3 or higher (excluding the iPad 2)

### ■ First-time connection

You need to set up pairing (connection) for the first time only.

When pairing is set up, a Wi-Fi connection is made automatically.

#### (On the camera)

**MENU** →  **[Setup]** → **[Bluetooth]** → **[Bluetooth]** → **[SET]** → **[Pairing]**

- The camera enters pairing standby mode and displays its device name.

#### (On your smartphone)

##### 1 Start "Image App".

- If a message is displayed indicating that the smartphone is searching for cameras, close the message.

##### 2 Select **[Bluetooth]**.

##### 3 Turn on the **Bluetooth**.

##### 4 Select the device name displayed on the camera's screen from the **[Camera enable to be registered]** list.

- Bluetooth connection between the camera and the smartphone will be made.  
(For Android devices) A Wi-Fi connection will be made by selecting **[Connection]**.

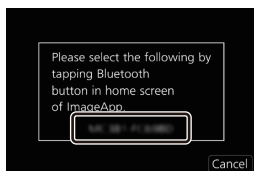

**If you are using an Android device, follow the steps up to here to complete the setup. Proceed to the steps below only if you are using an iOS device.**

- If **[Wi-Fi Password]** is set to **[OFF]** on the camera, select **[Wi-Fi Setup]**. (At the time of purchase, **[Wi-Fi Password]** is set to **[OFF]**.)
- If **[Wi-Fi Password]** is set to **[ON]** on the camera, you need to install the profile.

##### ① Install the profile.

- If a pass code is set on the smartphone, you need to enter it.

##### ② Press the home button to close the browser.

**5 Turn on the Wi-Fi function in the smartphone's setting menu.****6 On the Wi-Fi setting screen, select the SSID displayed on the camera. (The device name selected in step 4)**

- If the SSID is not displayed, it may be displayed after the Wi-Fi function is turned off and on.
- The paired smartphone will be registered as a paired device after connected via Wi-Fi.

**7 Start "Image App".**

- After the Wi-Fi connection is completed, the paired smartphone is registered as a paired device.

**■ Connecting to a Paired Smartphone****(On the camera)****MENU** → **⌘ [Setup]** → **[Bluetooth]** → **[Bluetooth]** → **[ON]****(On your smartphone)**

- 1 Start "Image App" and then select [Bluetooth].
- 2 Turn on the Bluetooth.
- 3 Select the camera (device name) you want to connect to from the [Camera registered] list.

**■ End Bluetooth Connection**

To terminate the Bluetooth connection, turn off the Bluetooth function of the camera.

**MENU** → **⌘ [Setup]** → **[Bluetooth]** → **[Bluetooth]** → **[OFF]**

- Even if you terminate the connection, the pairing information for it will not be deleted.

**■ Canceling Pairing****(On the camera)**

- 1 Select the menu.

**MENU** → **⌘ [Setup]** → **[Bluetooth]** → **[Bluetooth]** → **[SET]** → **[Delete]**

- 2 Select the smartphone you want to delete.

**(On your smartphone)**

Select the camera (device name) for which to delete the pairing information from the [Camera registered] list.

- [📶] is displayed on the recording screen during Bluetooth connection. When the Bluetooth function is enabled, but a connection is not established, [📶] appears translucent.

## Connecting to a Smartphone (Wi-Fi connection)

Use Wi-Fi to connect the camera and a smartphone that does not support Bluetooth Low Energy.

- You can also connect via Wi-Fi to a smartphone that supports Bluetooth Low Energy by following the same steps.

### Connecting Without Entering a Password

#### (On the camera)

**MENU** →  **[Setup]** → **[Wi-Fi]** → **[Wi-Fi Function]** → **[New Connection]** → **[Remote Shooting & View]**

#### A SSID

- The information required for directly connecting your smartphone to this unit (SSID) is displayed.
- You can also display the information by pressing [Wi-Fi] on the camera.



#### (On your smartphone)

- 1 Turn on the Wi-Fi function in the setup menu.
- 2 On the Wi-Fi setting screen, select the SSID displayed on the camera.
- 3 Start “Image App”.
  - When the connection confirmation screen is displayed on the camera, select [Yes] to connect. (For first time connection only)



### At the time of purchase, [Wi-Fi Password] is set to [OFF].

Before connecting to a Wi-Fi network, ensure that the device displayed on the connection confirmation screen is the one you actually want to connect to. When a wrong device is displayed, if you select [Yes], the camera will automatically connect to that device.

We recommend that you set [Wi-Fi Password] to [ON] if, for example, there is another Wi-Fi device nearby.

## Using Password Authentication to Connect

### Preparations:

(On the camera) Set the [Wi-Fi Password] to [ON].

**MENU** →  **[Setup]** → **[Wi-Fi]** → **[Wi-Fi Setup]** → **[Wi-Fi Password]** → **[ON]**

(On the camera)

**MENU** →  **[Setup]** → **[Wi-Fi]** → **[Wi-Fi Function]** → **[New Connection]** → **[Remote Shooting & View]**

Ⓐ SSID and password

Ⓑ QR code

- The information required for directly connecting your smartphone to this unit (SSID, password and QR code) is displayed.
- You can also display the information by pressing [Wi-Fi] on the camera.

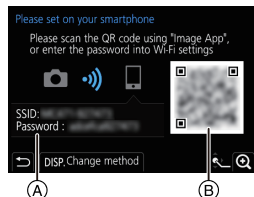

(On your smartphone)

- 1 Turn on the Wi-Fi function in the setting menu.
- 2 On the Wi-Fi setting screen, select the SSID displayed on the camera.
- 3 Enter the password displayed on the camera into the smartphone. (For first time connection only)
- 4 Start "Image App".



## Terminating the Wi-Fi connection

- 1 Set the camera to Recording Mode.
  - Press the shutter button halfway to return to recording mode.
- 2 Select the camera's menu items to terminate the Wi-Fi connection.

**MENU** →  **[Setup]** → **[Wi-Fi]** → **[Wi-Fi Function]**  
→ **[Yes]**

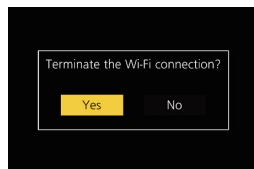

- 3 On the smartphone, close "Image App".





# Operating the Camera with a Smartphone

## ■ Required wireless connectivity mode

The wireless connectivity mode required varies depending on the function to be used after connecting to a smartphone.

Wireless connectivity required	Support for Bluetooth Low Energy
	Indicates that the function can be used with smartphones that support Bluetooth Low Energy.
	Indicates that the function can be used with smartphones that do not support Bluetooth Low Energy.
	Indicates that the function can be used with smartphones that support Bluetooth Low Energy. • Indicates that the function requires you to connect to a smartphone using both Bluetooth and Wi-Fi.

## Camera Power Operations

Wireless connectivity required:  

By operating a smartphone, you can turn on the camera to record from a remote location or to view images even when the camera is in your bag.

### Preparations:

- 1 Make a Bluetooth connection to the smartphone. (P68)
- 2 Select the camera's menu.

 →  [Setup] → [Bluetooth] → [Remote Wakeup] → [ON]

- 3 Set the camera ON/OFF switch to [OFF].
- 4 On the smartphone, start up the "Image App", and set the Bluetooth function to a state in which a connection can be made (standby state).
- 5 Operate the smartphone.

① Select [  ].

② Select [Remote operation].



- The camera automatically turns on, allowing it to make a Wi-Fi connection automatically.
  - (iOS devices) Depending on the connection status of the smartphone, you may need to change the connected device on the Wi-Fi setup screen. Follow the on-screen message on the smartphone to change the setting.



## ■ Turning Off the Camera

Operate the smartphone.

- 1 Select [  ].
- 2 Select [  OFF].

- When [Remote Wakeup] is set to [ON], the Bluetooth function continues to operate even after the camera is turned off, thus causing the battery to drain.

## Remote shooting

Wireless connectivity required: Wi-Fi

You can use the smartphone to record from a remote location while viewing the live view images from the camera.

- 1 **Connect to a smartphone. (P70)**
- 2 **Operate the smartphone.**

(When connected via Bluetooth) Select [  ] → [Remote operation]

(iOS devices) If you need to change the connected device on the Wi-Fi setup screen, follow the on-screen message to change the setting.



- 1 Select [  ].
- 2 Record an image.
  - The recorded images are saved in the camera.
  - Some settings are not available.



## ■ Operation Method During Remote Recording

Set either the camera or the smartphone as the priority control device to be used during remote recording.

**MENU** →  [Setup] → [Wi-Fi] → [Wi-Fi Setup] → [Priority of Remote Device]

 <b>[Camera]</b>	<p>Allows you to perform operations with both the camera and the smartphone during remote recording.</p> <ul style="list-style-type: none"> <li>• The camera's dial settings, etc. cannot be changed with the smartphone.</li> </ul>
 <b>[Smartphone]</b>	<p>Allows you to perform operations only with the smartphone during remote recording.</p> <ul style="list-style-type: none"> <li>• The camera's dial settings, etc. can be changed with the smartphone.</li> <li>• To end remote recording, press any of the buttons on the camera to turn on the screen, and select [End].</li> </ul>

## Playing back/saving images stored on the camera

**Wireless connectivity required:** Wi-Fi

- 1 **Connect to a smartphone. (P70)**
- 2 **Operate the smartphone.**

(When connected via Bluetooth) Select [  ] → [Remote operation]

(iOS devices) If you need to change the connected device on the Wi-Fi setup screen, follow the on-screen message to change the setting.

- 1 Select [  ].

- You can switch the images to be displayed by selecting the icon (A) on the top left of the screen. To display images stored in the camera, select [LUMIX].

**(To play back the image)**

- 2 Touch the image to enlarge it.
  - When you play a motion picture, image quality differs from that of the actual recorded motion picture. The image quality may deteriorate or the sound may skip during motion picture or picture playback.

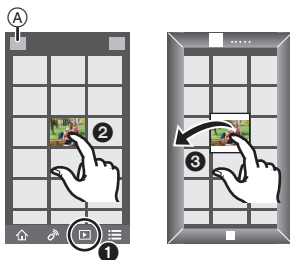

**(To save the image)**

- 3 Touch and hold and then drag the image.

- An OS version of Android 7.0 or higher or iOS 10.0 or higher is required to save pictures in RAW format.
- Depending on the smartphone or its OS version, pictures in RAW format may not be displayed correctly.
- You cannot save the following types of images:
  - Motion pictures in AVCHD and 4K formats
  - 4K burst files
  - Images recorded with the Post Focus function

# Importing Images to a PC

## Downloading software

- To download the software, you need to connect the PC to the Internet.
- It may take some time to download the software depending on the communication environment.
- Supported OSs are current as of April 2022 and are subject to change.

### PHOTOfunSTUDIO 10.0 AE (Windows® 10 / 8.1)

This software allows you to manage images. For example, you can send pictures and motion pictures to a PC and sort them by recording date or model name. You can also perform operations such as writing images to a DVD, processing and correcting images, and editing motion pictures.

Check the site below to download and install the software.

Download the software while it is available for download.

- Download expiration: July 2025

[https://panasonic.jp/support/global/cs/soft/download/d\\_pfs10ae.html](https://panasonic.jp/support/global/cs/soft/download/d_pfs10ae.html)

(This Site is English only.)

- For 4K motion pictures and 4K photos, a 64 bit OS version of Windows 10 / 8.1 is required.
- For details about information such as the operating environment or operating method, refer to the “Owner’s Manual for advanced features” (PDF format) or the operating instructions for the respective software programs.
- “PHOTOfunSTUDIO” is not compatible with Mac.

### SILKYPIX Developer Studio SE (Windows® 10 / 8.1 (64-bit recommended), macOS 10.13 to macOS 10.15, macOS 11)

This is software to edit RAW format images.

Edited images can be saved in a format (JPEG, TIFF, etc.) that can be displayed on a personal computer.

Check the site below to download and install the software.

<http://www.isl.co.jp/SILKYPIX/english/p/>

- For details on how to use the SILKYPIX Developer Studio, refer to the Help or the Ichikawa Soft Laboratory’s support website.

### LoiLoScope 30 day full trial version (Windows® 10 / 8.1 / 8)

This software allows you to edit motion pictures with ease.

Check the site below to download and install the software.

<http://loilo.tv/product/20>

- For more information on how to use LoiLoScope, read the LoiLoScope manual available for download at the site.
- “LoiLoScope” is not compatible with Mac.

# Monitor Display/Viewfinder Display

**Display example: When [ ] (monitor style) is set and the monitor display is in use**





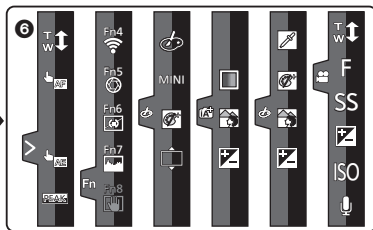
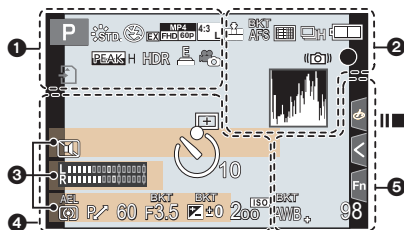



























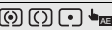

- The information displayed, such as histograms, magnifications, and numeric values, are only for the purpose of reference.

## In recording



1	
	Recording Mode (P27)
	Custom settings
	Motion picture recording mode (P46)
	Photo Style (P58)
	Flash Mode
	Flash
	Extra Tele Conversion (when recording motion pictures)
	Recording format/Recording quality (P47)
	Snap Movie
	Aspect Ratio (P56)/ Picture size (P57)
	Extra Tele Conversion (when taking still pictures)
	Image size ([Panorama Settings])
	Image effect (filter) adjustment display

	EXPS	Image effect (filter) setting
	Loop Recording	Loop Recording
	Card (displayed only during recording)	Card (displayed only during recording)
	8m30s	Elapsed recording time*1 (P47)
	Simultaneous recording indicator	Simultaneous recording indicator
	LVF/ MON AUTO	Automatic viewfinder/monitor switching (P28)
	PEAKS H PEAKS L	Peaking
	Highlight Shadow	Highlight Shadow
	HDR	HDR/iHDR
	Multi exposure	Multi exposure
	Digital Zoom	Digital Zoom
	Electronic shutter (P61)	Electronic shutter (P61)
	120fps	High speed video (P49)
	Picture-taking during motion picture recording (Photo Priority)	Picture-taking during motion picture recording (Photo Priority)
	Overheat indicator	Overheat indicator

<b>2</b>	 RAW	Quality (P57)	<b>3</b>	Name <sup>*2</sup>
	AFS AFF AFC MF	Focus Mode (P32)		Number of days that have passed since the departure date <sup>*3</sup>
	 BKT AFS	Focus Bracket (P42)		Age <sup>*2</sup>
		Post Focus (P38)		Location <sup>*3</sup>
		AF Mode		Current date and time/ Travel destination setting <sup>*3</sup> : 
		Pull Focus		Exposure meter
		Face Recognition		Focal distance display
	AFL	AF Lock		Step zoom
		Burst	<b>4</b>	
		4K Photo (P34)		 AF area
		Self-timer		+ Spot metering target
		Battery indication		+ Center marker display
		Power is being supplied (P20)		 Self-timer
	<b>BG</b>	Battery Grip		 Recording level display
	DUAL2 DUAL 	Image Stabilizer (P44)		 Recording level Limiter (OFF)
	DUAL2 DUAL 			 Silent Mode (P60)
		Jitter alert		 External Microphone
	<b>PRE</b>	4K Pre-Burst/Pre-Burst Recording		AEL AE Lock
		Recording state (Lights red.)/ Focus (Lights green.) (P24)		 Metering Mode (P60)
		Focus (Under low illumination)		 Program Shift
		Focus (Starlight AF)		F3.5 Aperture value (P24)
		Connected to Wi-Fi		 BKT F3.5 Aperture Bracket (P42)
		Connected to Bluetooth		60 Shutter speed (P24)
	<b>GPS</b>	Location Logging		 Exposure compensation value
		Histogram		 Exposure Bracket (P42)
				 Brightness (P32)
				 Manual Exposure Assistance
				 200 ISO sensitivity

5

BKT AWB*	White Balance Bracket (P43)
	White Balance Adjustment
AWBc AWBw 	White Balance
	Color (P32)
98	Number of recordable pictures
r20	Maximum number of pictures that can be taken continuously
R 8m30s	Available recording time*1

6

Touch tab	
	Touch zoom
	Touch Shutter
	Touch AF
	Touch AE
	Peaking
	Fn4 Fn button (P30)
            	Color (P32)
	Defocus control function (P32)
	Brightness (P32)
	Type of defocus ([Miniature Effect])
	One point color
	Position of the light source
	Image effect (filter) adjustment
	Image effect ON/OFF
	Image effect (filter)
	Aperture value (P24)
	Shutter speed (P24)
	ISO sensitivity
	Sound recording level adjustment

\*1 h: hour, m: minute, s: second

\*2 This is displayed for about 5 seconds when the camera is turned on if the [Profile Setup] setting is set.

\*3 This is displayed for about 5 seconds when the camera is turned on, after setting the clock and after switching from Playback Mode to Recording Mode.

## In recording

## On-monitor recording information

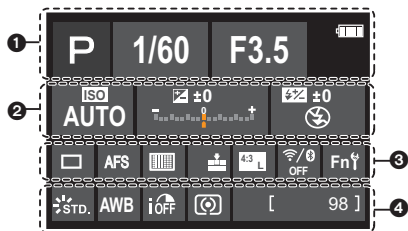

1

	Recording Mode (P27)
	Motion picture recording mode (P46)
F3.5	Aperture value (P24)
1/60	Shutter speed (P24)
	Battery indication
	Power is being supplied (P20)
	Card (displayed only during recording)

2

	AUTO	ISO sensitivity
	±0	Exposure compensation value
		Brightness (P32)
		Manual Exposure Assistance
		Flash Mode
	±0	Flash

3

	Single
	Burst
	4K Photo (P34)
	Post Focus (P38)
	Self-timer
	Focus Mode (P32)
	AF Mode
	Quality (P57)
	Aspect Ratio (P56)/ Picture size (P57)
	Wi-Fi/Bluetooth (P65)
	Fn button setting (P30)

4

	Photo Style (P58)
	White Balance
	Intelligent Dynamic Range Control
	Metering Mode (P60)
98	Number of recordable pictures
r20	Maximum number of pictures that can be taken continuously
R8m30s	Available recording time*
---	No card

\* h: hour, m: minute, s: second

# Troubleshooting

First, try out the following procedures.

**If the problem is not resolved, it may be improved by selecting [Reset] on the [Setup] menu.**

- Please also refer to the “Owner’s Manual for advanced features” (PDF format), which describes more detailed information.

## **When I shake the camera, I hear a rattling sound.**

- The sound is caused by the In-Body Image Stabilizer. This is not a malfunction.

## **When I shake the camera, I hear a rattling sound from the attached lens.**

- Depending on the lens you attach, it may move inside and create a sound. This is not a malfunction.

## **Recording stops before finishing.**

**Cannot record.**

**Cannot use some functions.**

- In high ambient temperatures or if the camera is used for continuous recording, the temperature of the camera will rise.  
To protect the camera against a rise in temperature, after [  ] is displayed, recording will be stopped, and the following functions will not be available for a time.  
Wait until the camera cools down.
  - [4K PHOTO]
  - Post Focus
  - Motion picture recording
  - Power supply via the USB connection cable

## **The charging lamp blinks.**

- Charging is being performed in a place with extremely high or low temperature.
  - Reconnect the USB connection cable (supplied) and retry charging in a place where ambient temperature is 10 °C to 30 °C (50 °F to 86 °F) (temperature conditions also apply to the battery itself).
- Charging is not possible if the power supply capacity of the computer is low.

**The camera does not operate even if it is turned on. The camera quickly turns off after being turned on.**

- The battery is drained. Charge the battery. (P17)



### The battery becomes flat too quickly.

- When [4K Pre-Burst] or [Pre-Burst Recording] is set, the battery drains faster. Set these settings only when recording.
- When connected to Wi-Fi, the battery drains quickly. Turn the camera off frequently such as by using [Economy].

### Multiple images are recorded at once.

- When drive mode is set to [] (Burst), pressing and holding the shutter button will take burst pictures.
- When bracketing is set, then pressing the shutter button records multiple images while automatically changing the settings.

### The subject is not focused properly.

- Confirm the following details:
  - Is the subject outside of the focus range?
  - Is [Shutter AF] set to [OFF]?
  - Is [Focus/Release Priority] set to [RELEASE]?
  - Is AF Lock set where it is not appropriate?
- If there are fingerprints or dirt on the lens, the focus may be set to the lens and not the subject.

### The recorded image is blurred.

#### The stabilizer is not effective.

- The shutter speed will become slower and the stabilizer function may not work properly when recording in dark places. In these cases, use a tripod and the self-timer when recording.

### Striping or flicker may appear under lighting such as fluorescent lighting and LED lighting fixture.

- This is characteristic of MOS sensors which serve as the camera's pickup sensors. This is not a malfunction.
- When using the electronic shutter, lowering the shutter speed may reduce the effect of the horizontal stripes.
- If flicker or horizontal stripes are noticeable when recording motion picture, this can be mitigated by fixing the shutter speed. Either set [Flkr Decrease], or record in Creative Video Mode.



**The brightness or coloring of the recorded image is different from the actual scene.**

- When recording under fluorescent or LED lighting fixture, etc., increasing the shutter speed may introduce slight changes to brightness or coloring.  
These are a result of the characteristics of the light source and do not indicate a malfunction.
- When recording subjects in extremely bright locations or recording under fluorescent lighting, LED lighting fixture, mercury lamp, sodium lighting, etc., the coloring or screen brightness may change or horizontal striping may appear on the screen.

**The subject appears distorted on the image.**

- When a moving subject is recorded while using the following functions, the subject may appear distorted in the picture:
  - [ESHTR]
  - Motion picture recording
  - [4K PHOTO]This is a characteristic of the MOS sensor that is the image sensor of the camera, and is not a malfunction.

**Cannot record motion pictures.**

- When using a large capacity card, you may not be able to record for a while after turning on the camera.

**Motion picture recording stops before finishing.**

- Recording motion picture using the SD card requires an SD card of a supported speed class. Use a compatible SD card.

**Sometimes focus adjustment with AF mode is difficult while recording 4K motion pictures.**

- This may occur when taking a picture by reducing the AF speed in order to adjust the focus at high precision. This is not a malfunction.

**The flash does not fire.**

- Open the flash if it is closed.
- The flash does not fire when [☹] (forced flash off) is selected.
- The flash does not fire when using the following functions:
  - Motion picture recording
  - [4K PHOTO]
  - Post Focus
  - [ESHTR]
  - [Silent Mode]
  - [Filter Settings]
  - [HDR]

### **The monitor/viewfinder turns off when the camera is turned on.**

- If no operations are performed within the set time period, [Auto LVF/Monitor Off] is activated, and the monitor/viewfinder turns off.
- When an object or your hand is positioned near the eye sensor, the monitor display may switch to the viewfinder display.

### **Cannot play back.**

#### **There are no recorded pictures.**

- Folders and images processed on a PC cannot be played on the camera. We recommend using the software "PHOTOfunSTUDIO" to write images from the PC to the card.
- Set [Playback Mode] to [Normal Play].

### **A Wi-Fi connection cannot be established.**

#### **Radio waves get disconnected.**

#### **Wireless access point is not displayed.**

#### **General tips for using a Wi-Fi connection**

- Use within the communication range of the device to be connected.
- Usage near devices that utilize the 2.4 GHz frequency such as microwave ovens and cordless telephones may result in the radio wave being lost. Use the camera at a sufficient distance from these devices.
- When the remaining battery level is low, it may not be possible to connect to or maintain communication with other devices. (A message such as [Communication error] is displayed.)
- If you place the camera on a metal table or shelf, the radio waves may be adversely affected. In such cases, you may not be able to establish a connection. Move the camera away from the metal surface.

#### **Wireless access point**

- Confirm that the connected wireless access point can be used.
- Confirm the radio wave conditions of the wireless access point.
  - Move the camera closer to the wireless access point.
  - Change the location and angle of the wireless access point.
- Depending on the wireless access point, the radio wave may not be displayed even though it is present.
  - Turn off and then on the wireless access point.
  - If the wireless channel of the wireless access point cannot be set automatically, manually set the channel supported by the camera.
  - If the wireless access point SSID is set not to broadcast, it may not be detected. Enter the SSID, and then connect.

**When trying to connect to a PC by Wi-Fi, this does not recognize the user name and password, and connection is not possible.**

- Depending on the version of the OS, there are two types of user account (local account/ Microsoft account). Ensure you use the local account user name and password.

**The PC is not recognized when I use a Wi-Fi connection.  
The camera cannot be connected to the PC using the Wi-Fi function.**

- At the time of purchase, this camera is set to use a workgroup name of "WORKGROUP". If you have changed the workgroup name of the PC, this will not be recognized. In the [Wi-Fi Setup] menu, [PC Connection], change the workgroup name of the PC to which to connect.
- Check that the login name and password are correctly typed.
- When the clock settings of the PC connected to the camera differs considerably from those of the camera, the camera cannot be connected to the PC depending on the OS.
  - Confirm that the [Clock Set]/[World Time] settings of the camera match the time, date, and time zone settings of the Windows or Mac.
  - If there are considerable differences, correct them.

**Transmission of the image fails midway.  
Some images cannot be transmitted.**

- Is the size of the image too large?
  - Reduce the image size at [Size], and then send.
  - Transmit after dividing the motion picture with [Video Divide].
- It may take longer time to transmit when distance to the wireless access point is far. Transmit closer to the wireless access point.
- File format of the motion picture that can be sent differs depending on the destination.

**There is a sound from the lens unit.**

- The lens movement and aperture operation emit sound when turning the camera on or off; this is not a malfunction.
- This is the sound of aperture operation when brightness changes; this is not a malfunction.

**The camera becomes warm.**

- During use, the camera may get warm, but this does not affect performance or quality.

**The clock is wrong.**

- When the camera is left for a long time, the clock may reset. Reset the clock. (P22)

# Specifications

Specifications are subject to change without notice.

## Digital Camera Body (DC-G95D):

Information for your safety

<b>Power Source:</b>	8.4 V===
<b>Power Consumption:</b>	3.1 W (When recording with Monitor) (When the Interchangeable lens (H-FS12060) is used)
	2.2 W (When playing back with Monitor) (When the Interchangeable lens (H-FS12060) is used)

Type	
<b>Type</b>	Digital Single Lens Mirrorless camera
<b>Recording media</b>	SD Memory Card / SDHC Memory Card* / SDXC Memory Card* * UHS-I/UHS-II UHS Speed Class 3
<b>Lens mount</b>	Micro Four Thirds mount
Image sensor	
<b>Image sensor</b>	4/3" Live MOS sensor, total pixel number 21,770,000 pixels, Primary color filter
<b>Camera effective pixels</b>	20,300,000 pixels

Recording format for still images		
<b>File format for still images</b>	JPEG (based on "Design rule for Camera File system", based on "Exif 2.31" standard) / RAW	
<b>File format for 4K photos</b>	MP4 (H.264/MPEG-4 AVC, AAC (2 ch))	
<b>Picture size (pixels)</b>	<p>When the aspect ratio setting is [4:3]            3328×2496 pixels (4K photo), 5184×3888 pixels ([L]),            3712×2784 pixels ([M]), 2624×1968 pixels ([S])</p> <p>When the aspect ratio setting is [3:2]            3504×2336 pixels (4K photo), 5184×3456 pixels ([L]),            3712×2480 pixels ([M]), 2624×1752 pixels ([S])</p> <p>When the aspect ratio setting is [16:9]            3840×2160 pixels (4K photo), 5184×2920 pixels ([L]),            3840×2160 pixels ([M]), 1920×1080 pixels ([S])</p> <p>When the aspect ratio setting is [1:1]            2880×2880 pixels (4K photo), 3888×3888 pixels ([L]),            2784×2784 pixels ([M]), 1968×1968 pixels ([S])</p>	
<b>Image quality for pictures</b>	Fine / Standard / RAW+Fine / RAW+Standard / RAW	
Recording format for motion picture		
<b>Video format</b>	AVCHD Progressive / AVCHD / MP4	
<b>Audio format</b>	AVCHD	Dolby Audio™ (2 ch)
	MP4	AAC (2 ch)
<b>Image quality for motion pictures</b>	[Rec Format]: [AVCHD], [MP4] Refer to P47 of this document for details. Refer to P49 of this document for details about High Speed Video.	
Viewfinder / Monitor		
<b>Viewfinder</b>	OLED Live Viewfinder (4:3) (Approx. 2,360,000 dots) (field of view ratio about 100%) (Magnification approx. 1.48×, approx. 0.74× (35 mm film camera equivalent), with 50 mm lens at infinity; $-1.0 \text{ m}^{-1}$ ) (with diopter adjustment $-4$ to $+4$ diopter)	
<b>Monitor</b>	3.0" OLED Monitor (3:2) (Approx. 1,040,000 dots) (field of view ratio about 100%) Touch screen	

Focus	
<b>Auto focus type</b>	TTL type based on image detection (Contrast AF)
<b>Focus mode</b>	AFS / AFF / AFC / MF
<b>AF mode</b>	Face/Eye Detection / Tracking / 49-area-focusing / Custom Multi / 1-area-focusing / Pinpoint (Focus area selection is possible by touching)
Exposure control	
<b>Light metering system, Light metering mode</b>	1728-zone multi-pattern sensing system, Multiple / Center weighted / Spot
<b>Metering range</b>	EV 0 to EV 18
<b>Exposure</b>	Program AE / Aperture-priority AE / Shutter-priority AE / Manual exposure
<b>Exposure compensation</b>	1/3 EV Step, $\pm 5$ EV
<b>ISO sensitivity (standard output sensitivity)</b>	1 EV step (1/3 EV step change possible), AUTO / $\square$ ISO / 200 to 25600* * When [Extended ISO] is set: 100 to 25600
Image stabilizer	
<b>Image stabilizer type</b>	Compliant with Image sensor shift type, 5-axis stabilizer, Dual I.S.2
<b>Image stabilizer effect</b>	5.0 stops Based on the CIPA standard (Yaw/Pitch direction: focal length f=60 mm) (35 mm conversion: f=120 mm) (When using the interchangeable lens (H-FS12060))
White balance	
<b>White balance mode</b>	AWB / AWBc / AWBw / Daylight / Cloudy / Shade / Incandescent lights / Flash / White set 1, 2, 3, 4 / Color temperature 1, 2, 3, 4
Shutter	
<b>Shutter type</b>	Focal-plane shutter
<b>Shutter speed</b>	Still picture: B (Bulb) (Max. approx. 30 minutes), 60 seconds to 1/4000 of a second (Mechanical shutter), B (Bulb) (Max. approx. 30 minutes), 60 seconds to 1/2000 of a second (Electronic Front Curtain), 1 second to 1/16000 of a second (Electronic shutter) Motion picture: 1/25 of a second to 1/16000 of a second

<b>Burst recording</b>	
<b>Mechanical shutter/ Electronic front curtain/ Electronic shutter</b>	9 pictures/second (High speed, AFS/MF), 6 pictures/second (High speed, AFF/AFC), 6 pictures/second (Middle speed), 2 pictures/second (Low speed)
<b>Number of burst picture frames</b>	With RAW file: 30 frames or more Without RAW file: 600 frames or more When recording is performed under the test conditions specified by Panasonic
<b>Minimum illumination</b>	
Approx. 9 lx (when i-Low light is used, the shutter speed is 1/30 of a second) (When the Interchangeable lens (H-FS12060) is used)	
<b>Flash</b>	
<b>Flash</b>	Built-in pop up flash GN 9.0 equivalent (ISO200·m) (GN 6.4 equivalent (ISO100·m))
<b>Flash mode</b>	AUTO / AUTO/Red-Eye Reduction / Forced ON / Forced ON/Red-Eye Reduction / Slow Sync. / Slow Sync./Red-Eye Reduction / Forced OFF
<b>Flash synchronization speed</b>	Equal to or smaller than 1/200 of a second
<b>Flash range</b>	Approx. 0.5 m (1.6 feet) to 7.3 m (24 feet) (When the Interchangeable lens (H-FS12060) is mounted, WIDE, [ISO AUTO] is set)



**Zoom**

<b>Digital zoom</b>	2× / 4×
<b>Extra tele conversion</b>	When taking still pictures: Max. 2× When recording motion pictures: 2.7× (FHD) / 4.0× (HD)

**Microphone / Speaker**

<b>Microphone</b>	Stereo
<b>Speaker</b>	Monaural

**Language select**

[ENGLISH]/[DEUTSCH]/[FRANÇAIS]/[ESPAÑOL]/[PORTUGUÊS]/[ITALIANO]/[繁體中文]/  
[日本語]

**Interface**

<b>USB</b>	USB 2.0 (High Speed) Micro-B
<b>HDMI</b>	micro HDMI Type D
<b>[REMOTE]</b>	∅ 2.5 mm jack
<b>[MIC]</b>	∅ 3.5 mm jack
<b>Headphones</b>	∅ 3.5 mm jack

**Splash Resistant**

Yes

**Dimensions / Mass**

<b>Dimensions</b>	Approx. 130.4 mm (W)×93.5 mm (H)×77.4 mm (D) (5.14" (W)×3.69" (H)×3.05" (D)) (excluding the projecting parts)
<b>Mass (Weight)</b>	Approx. 533 g/1.18 lb (with one card and the battery) Approx. 481 g/1.06 lb (camera body)

Operating environment	
Recommended operating temperature	0 °C to 40 °C (32 °F to 104 °F)
Permissible relative humidity	10%RH to 80%RH
Wi-Fi	
Compliance standard	IEEE 802.11b/g/n (standard wireless LAN protocol)
Frequency range used (central frequency)	2412 MHz to 2462 MHz (1 to 11 ch)
Encryption method	Wi-Fi compliant WPA™/WPA2™
Access method	Infrastructure mode
Bluetooth	
Compliance standard	Bluetooth v4.2 (Bluetooth Low Energy (BLE))
Frequency range used (central frequency)	2402 MHz to 2480 MHz

### Battery Charger (Panasonic DMW-BTC12):

Information for your safety

Input:	5.0 V $\text{---}$ 1.8 A
Output:	8.4 V $\text{---}$ 0.75 A

### AC Adaptor (Panasonic VSK0815F):

Information for your safety

Input:	110–240 V $\sim$ 50/60 Hz 0.25 A
Output:	5.0 V $\text{---}$ 1.8 A

### Battery Pack (lithium-ion) (Panasonic DMW-BLC12PP):

Information for your safety

Voltage/capacity:	7.2 V/1200 mAh
-------------------	----------------

The symbols on this product (including the accessories) represent the following:

$\sim$	AC
$\text{---}$	DC
$\square$	Class II equipment (The construction of the product is double-insulated.)

<b>Interchangeable Lens for digital camera</b>	<b>H-FS12060</b> “LUMIX G VARIO 12–60 mm/F3.5–5.6 ASPH./POWER O.I.S.”
<b>Mount</b>	Micro Four Thirds mount
<b>Focal length</b>	f=12 mm to 60 mm (35 mm film camera equivalent: 24 mm to 120 mm)
<b>Lens construction</b>	11 elements in 9 groups (3 aspherical lenses, 1 ED lens)
<b>Aperture type</b>	7 diaphragm blades/circular aperture diaphragm
<b>Maximum aperture</b>	F3.5 (Wide) to F5.6 (Tele)
<b>Minimum aperture value</b>	F22
<b>Angle of view</b>	84° (Wide) to 20° (Tele)
<b>In focus distance</b>	Wide: 0.20 m (0.66 feet) to ∞ / Tele: 0.25 m (0.82 feet) to ∞ (from the focus distance reference line)
<b>Maximum image magnification</b>	0.27× (35 mm film camera equivalent: 0.54×)
<b>Optical image stabilizer</b>	Yes
<b>Filter diameter</b>	58 mm
<b>Maximum diameter</b>	Ø66 mm (2.6")
<b>Overall length</b>	Approx. 71 mm (2.8") (from the tip of the lens to the base side of the lens mount)
<b>Mass (Weight)</b>	Approx. 210 g/0.46 lb
<b>Dust and splash resistant</b>	Yes
<b>Recommended operating temperature</b>	0 °C to 40 °C (32 °F to 104 °F)
<b>Permissible relative humidity</b>	10%RH to 80%RH

# Digital Camera Accessory System

Description	Accessory#
Battery Pack	DMW-BLC12
Battery Charger <sup>*1</sup>	DMW-BTC12
AC Adaptor <sup>*2</sup>	DMW-AC10
DC Coupler <sup>*2</sup>	DMW-DCC8
LED Video Light	VW-LED1
Flash	DMW-FL580L, DMW-FL360L, DMW-FL200L
Stereo Shotgun Microphone	DMW-MS2
Stereo Microphone	VW-VMS10
Shutter Remote Control	DMW-RS2
Battery Grip <sup>*3</sup>	DMW-BGG1
Body Cap	DMW-BDC1
Tripod Adaptor <sup>*4</sup>	DMW-TA1
Mount Adaptor	DMW-MA1, DMW-MA2M, DMW-MA3R
Tripod Grip	DMW-SHGR1

\*1 Supplied with an AC adaptor and a USB connection cable.

\*2 The AC Adaptor (optional) can only be used with the designated Panasonic DC Coupler (optional). The AC adaptor (optional) cannot be used by itself.

\*3 Supplied with a battery pack (DMW-BLC12).

\*4 Use if the attached lens is in contact with the tripod pedestal.

Product numbers correct as of April 2022. These may be subject to change.

- Some optional accessories may not be available in some countries.
- NOTE: Accessories and/or model numbers may vary between countries. Consult your local dealer.
- For lens-related optional accessories such as compatible lenses and filters, refer to catalogs/ Web pages, etc.

(For U.S.A. only)

- To order optional accessories please visit <http://shop.panasonic.com> or your local Photo Specialty Dealer.

## Reading the Owner's Manual (PDF format)

More detailed owner's manual is available in "Owner's Manual for advanced features" (PDF format). To read it, download it from the website.

[https://panasonic.jp/support/dsc/oi/G90\\_G95D/index.html](https://panasonic.jp/support/dsc/oi/G90_G95D/index.html)

- Click the desired language.



- You will need Adobe Reader to browse or print the "Owner's Manual for advanced features" (PDF format).

You can download and install a version of Adobe Reader that you can use with your OS from the following website. (As of April 2022)

<http://www.adobe.com/products/acrobat/readstep2.html>

---

This product incorporates the following software:

- (1) the software developed independently by or for Panasonic,
- (2) the software owned by third party and licensed to Panasonic,
- (3) the software licensed under the GNU General Public License, Version 2.0 (GPL V2.0),
- (4) the software licensed under the GNU LESSER General Public License, Version 2.1 (LGPL V2.1), and/or
- (5) open source software other than the software licensed under the GPL V2.0 and/or LGPL V2.1.

The software categorized as (3) - (5) are distributed in the hope that it will be useful, but WITHOUT ANY WARRANTY, without even the implied warranty of MERCHANTABILITY or FITNESS FOR A PARTICULAR PURPOSE. Please refer to the detailed terms and conditions thereof displayed by selecting [MENU/SET] → [Setup] → [Version Disp.] → [Software info].

At least three (3) years from delivery of this product, Panasonic will give to any third party who contacts us at the contact information provided below, for a charge no more than our cost of physically performing source code distribution, a complete machine-readable copy of the corresponding source code covered under GPL V2.0 or LGPL V2.1, as well as the respective copyright notice thereof.

Contact Information: [oss-cd-request@gg.jp.panasonic.com](mailto:oss-cd-request@gg.jp.panasonic.com)

The source code and the copyright notice are also available for free in our website below.  
<https://panasonic.net/cns/oss/index.html>

# Limited Warranty (ONLY FOR U.S.A.)

## Panasonic Products Limited Warranty

### Limited Warranty Coverage (For USA Only)

If your product does not work properly because of a defect in materials or workmanship, Panasonic Corporation of North America (referred to as "the warrantor") will, for the length of the period indicated on the chart below, which starts with the date of original purchase ("warranty period"), at its option either (a) repair your product with new or refurbished parts, (b) replace it with a new or a refurbished equivalent value product, or (c) refund your purchase price. The decision to repair, replace or refund will be made by the warrantor.

Product or Part Name	Parts	Labor
Digital Camera	1 Year	1 Year
All included Accessories (Except Non-Rechargeable Batteries)	90 Days	Not Applicable
Only Non-Rechargeable Batteries	10 Days	Not Applicable

During the "Labor" warranty period there will be no charge for labor. During the "Parts" warranty period, there will be no charge for parts. This Limited Warranty excludes both parts and labor for non-rechargeable batteries, antennas, and cosmetic parts (cabinet). This warranty only applies to products purchased and serviced in the United States. This warranty is extended only to the original purchaser of a new product which was not sold "as is".

### Mail-In Service--Online Repair Request

#### Online Repair Request

To submit a new repair request and for quick repair status visit our Web Site at <http://shop.panasonic.com/support>.

When shipping the unit, carefully pack, include all supplied accessories listed in the Owner's Manual, and send it prepaid, adequately insured and packed well in a carton box. When shipping Lithium Ion batteries please visit our Web Site at <http://shop.panasonic.com/support> as Panasonic is committed to providing the most up to date information. Include a letter detailing the complaint, a return address and provide a daytime phone number where you can be reached. A valid registered receipt is required under the Limited Warranty.

**IF REPAIR IS NEEDED DURING THE WARRANTY PERIOD, THE PURCHASER WILL BE REQUIRED TO FURNISH A SALES RECEIPT/PROOF OF PURCHASE INDICATING DATE OF PURCHASE, AMOUNT PAID AND PLACE OF PURCHASE. CUSTOMER WILL BE CHARGED FOR THE REPAIR OF ANY UNIT RECEIVED WITHOUT SUCH PROOF OF PURCHASE.**

**Limited Warranty Limits and Exclusions**

This warranty ONLY COVERS failures due to defects in materials or workmanship, and DOES NOT COVER normal wear and tear or cosmetic damage. The warranty ALSO DOES NOT COVER damages which occurred in shipment, or failures which are caused by products not supplied by the warrantor, or failures which result from accidents, misuse, abuse, neglect, mishandling, misapplication, alteration, faulty installation, set-up adjustments, misadjustment of consumer controls, improper maintenance, power line surge, lightning damage, modification, introduction of sand, humidity or liquids, or rental use of the product, or service by anyone other than a Factory Service Center or other Authorized Servicer, or damage that is attributable to acts of God.

**THERE ARE NO EXPRESS WARRANTIES EXCEPT AS LISTED UNDER “LIMITED WARRANTY COVERAGE”.**

**THE WARRANTOR IS NOT LIABLE FOR INCIDENTAL OR CONSEQUENTIAL DAMAGES RESULTING FROM THE USE OF THIS PRODUCT, OR ARISING OUT OF ANY BREACH OF THIS WARRANTY.**

(As examples, this excludes damages for lost time, travel to and from the servicer, loss of or damage to media or images, data or other memory or recorded content. The items listed are not exclusive, but for illustration only.)

**ALL EXPRESS AND IMPLIED WARRANTIES, INCLUDING THE WARRANTY OF MERCHANTABILITY, ARE LIMITED TO THE PERIOD OF THE LIMITED WARRANTY.**

Some states do not allow the exclusion or limitation of incidental or consequential damages, or limitations on how long an implied warranty lasts, so the exclusions may not apply to you.

This warranty gives you specific legal rights and you may also have other rights which vary from state to state. If a problem with this product develops during or after the warranty period, you may contact your dealer or Service Center. If the problem is not handled to your satisfaction, then write to:

Panasonic Corporation of North America  
Consumer Affairs Department 8th Fl.  
Two Riverfront Plaza  
Newark NJ 07102-5490

**PARTS AND SERVICE, WHICH ARE NOT COVERED BY THIS LIMITED WARRANTY, ARE YOUR RESPONSIBILITY.**

Product registration is not mandatory. Failure to complete the form does not affect the consumer's warranty rights.

**Shop**  
**Accessories!**

for all your Panasonic gear

Go to

<http://shop.panasonic.com/support>

Get everything you need to get the most out of your Panasonic products  
Accessories & Parts for your Camera, Phone, A/V products, TV, Computers & Networking, Personal Care, Home Appliances, Headphones, Batteries, Backup Chargers & more...

**Customer Services Directory**

For Product Information, Operating Assistance, Parts, Owner's Manuals, Dealer and Service info  
go to <http://shop.panasonic.com/support>

For the hearing or speech impaired TTY: 1- 877-833-8855

**As of November 2021**



# Limited Warranty (ONLY FOR CANADA)

## Panasonic Canada Inc.

5770 Ambler Drive, Mississauga, Ontario L4W 2T3

### PANASONIC PRODUCT – LIMITED WARRANTY

Panasonic Canada Inc. warrants this product to be free from defects in material and workmanship under normal use and for a period as stated below from the date of original purchase agrees to, at its option either (a) repair your product with new or refurbished parts, (b) replace it with a new or a refurbished equivalent value product, or (c) refund your purchase price. The decision to repair, replace or refund will be made by Panasonic Canada Inc.

<b>Digital Camera</b>	<b>One (1) year, parts and labour</b>
<b>Digital Camera Peripherals</b>	<b>One (1) year, parts and labour</b>
<b>Digital Camera Accessories</b>	<b>Ninety (90) days, parts and labour</b>

This warranty is given only to the original purchaser, or the person for whom it was purchased as a gift, of a Panasonic brand product mentioned above sold by an authorized Panasonic dealer in Canada and purchased and used in Canada, which product was not sold "as is", and which product was delivered to you in new condition in the original packaging.

**IN ORDER TO BE ELIGIBLE TO RECEIVE WARRANTY SERVICE HEREUNDER, A PURCHASE RECEIPT OR OTHER PROOF OF DATE OF ORIGINAL PURCHASE, SHOWING AMOUNT PAID AND PLACE OF PURCHASE IS REQUIRED**

## **LIMITATIONS AND EXCLUSIONS**

This warranty ONLY COVERS failures due to defects in materials or workmanship, and DOES NOT COVER normal wear and tear or cosmetic damage. The warranty ALSO DOES NOT COVER damages which occurred in shipment, or failures which are caused by products not supplied by Panasonic Canada Inc., or failures which result from accidents, misuse, abuse, neglect, mishandling, misapplication, alteration, faulty installation, set-up adjustments, misadjustment of consumer controls, improper maintenance, improper batteries, power line surge, lightning damage, modification, introduction of sand, humidity or liquids, or rental use of the product, or service by anyone other than a Authorized Servicer, or damage that is attributable to acts of God.

Dry cell batteries, printer ink cartridge and paper are also excluded from coverage under this warranty.

Rechargeable batteries are warranted for ninety (90) days from date of original purchase.

THIS EXPRESS, LIMITED WARRANTY IS IN LIEU OF ALL OTHER WARRANTIES, EXPRESS OR IMPLIED, INCLUDING ANY IMPLIED WARRANTIES OF MERCHANTABILITY AND FITNESS FOR A PARTICULAR PURPOSE. IN NO EVENT WILL PANASONIC CANADA INC. BE LIABLE FOR ANY SPECIAL, INDIRECT OR CONSEQUENTIAL DAMAGES RESULTING FROM THE USE OF THIS PRODUCT OR ARISING OUT OF ANY BREACH OF ANY EXPRESS OR IMPLIED WARRANTY. (As examples, this warranty excludes damages for lost time, travel to and from the Authorized Servicer, loss of or damage to media or images, data or other memory or recorded content. This list of items is not exhaustive, but for illustration only.)

In certain instances, some jurisdictions do not allow the exclusion or limitation of incidental or consequential damages, or the exclusion of implied warranties, so the above limitations and exclusions may not be applicable. This warranty gives you specific legal rights and you may have other rights which vary depending on your province or territory.

## **WARRANTY SERVICE**

**For product operation, repairs and information assistance**, please visit our Support page:

**[www.panasonic.ca/english/support](http://www.panasonic.ca/english/support)**

- Micro Four Thirds™ and Micro Four Thirds Logo marks are trademarks or registered trademarks of OM Digital Solutions Corporation, in Japan, the United States, the European Union and other countries.
- Four Thirds™ and Four Thirds Logo marks are trademarks or registered trademarks of OM Digital Solutions Corporation, in Japan, the United States, the European Union and other countries.
- SDXC Logo is a trademark of SD-3C, LLC.
- The terms HDMI and HDMI High-Definition Multimedia Interface, and the HDMI Logo are trademarks or registered trademarks of HDMI Licensing Administrator, Inc. in the United States and other countries.
- “AVCHD”, “AVCHD Progressive” and the “AVCHD Progressive” logo are trademarks of Panasonic Holdings Corporation and Sony Corporation.
- Dolby, Dolby Audio, and the double-D symbol are trademarks of Dolby Laboratories.
- HDAVI Control™ is a trademark of Panasonic Holdings Corporation.
- Adobe is a trademark or registered trademark of Adobe Systems Incorporated in the United States and/or other countries.
- Pentium is a trademark of Intel Corporation in the U.S. and/or other countries.
- Windows is a registered trademark or trademark of Microsoft Corporation in the United States and/or other countries.
- iMovie, Mac, OS X and macOS are trademarks of Apple Inc., registered in the U.S. and other countries.
- iPad, iPhone, iPod, and iPod touch are trademarks of Apple Inc., registered in the U.S. and other countries.
- App Store is a service mark of Apple Inc.
- Google, Android and Google Play are trademarks of Google LLC.
- The Bluetooth® word mark and logos are registered trademarks owned by Bluetooth SIG, Inc. and any use of such marks by Panasonic Holdings Corporation is under license. Other trademarks and trade names are those of their respective owners.



- The Wi-Fi CERTIFIED™ Logo is a registered trademark of Wi-Fi Alliance®.
- The Wi-Fi Protected Setup™ Logo is a trademark of Wi-Fi Alliance®.
- “Wi-Fi®” is a registered trademarks of Wi-Fi Alliance®.
- “Wi-Fi Protected Setup™”, “WPA™”, and “WPA2™” are trademarks of Wi-Fi Alliance®.
- DLNA, the DLNA Logo and DLNA CERTIFIED are trademarks, service marks, or certification marks of the Digital Living Network Alliance.
- This product uses “DynaFont” from DynaComware Corporation. DynaFont is a registered trademark of DynaComware Taiwan Inc.
- QR Code is a registered trademark of DENSO WAVE INCORPORATED.
- Other names of systems and products mentioned in these instructions are usually the registered trademarks or trademarks of the manufacturers who developed the system or product concerned.



This product is licensed under the AVC Patent Portfolio License for the personal use of a consumer or other uses in which it does not receive remuneration to (i) encode video in compliance with the AVC Standard (“AVC Video”) and/or (ii) decode AVC Video that was encoded by a consumer engaged in a personal activity and/or was obtained from a video provider licensed to provide AVC Video. No license is granted or shall be implied for any other use. Additional information may be obtained from MPEG LA, L.L.C.

See <http://www.mpegla.com>

Panasonic Corporation of North America  
Two Riverfront Plaza, Newark, NJ 07102-5490  
<http://shop.panasonic.com>

Panasonic Canada Inc.  
5770 Ambler Drive, Mississauga, Ontario L4W 2T3  
[www.panasonic.com](http://www.panasonic.com)

© Panasonic Entertainment & Communication Co., Ltd. 2022

Printed in China