



Panasonic[®]

Basic Owner's Manual Blu-ray Disc™ Player

Model No. **DP-UB9000**



Thank you for purchasing this product.
Please read these instructions carefully before using this product, and save this manual for future use.

If you have any questions, visit :
<http://shop.panasonic.com/support>

Register online at <http://shop.panasonic.com/support> (U.S. customers only)



P

TQBS0285-5

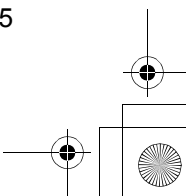

IMPORTANT SAFETY INSTRUCTIONS

Read these operating instructions carefully before using the unit. Follow the safety instructions on the unit and the applicable safety instructions listed below. Keep these operating instructions handy for future reference.

- 1 Read these instructions.
- 2 Keep these instructions.
- 3 Heed all warnings.
- 4 Follow all instructions.
- 5 Do not use this apparatus near water.
- 6 Clean only with dry cloth.
- 7 Do not block any ventilation openings. Install in accordance with the manufacturer's instructions.
- 8 Do not install near any heat sources such as radiators, heat registers, stoves, or other apparatus (including amplifiers) that produce heat.
- 9 Do not defeat the safety purpose of the polarized or grounding-type plug. A polarized plug has two blades with one wider than the other. A grounding-type plug has two blades and a third grounding prong. The wide blade or the third prong are provided for your safety. If the provided plug does not fit into your outlet, consult an electrician for replacement of the obsolete outlet.
- 10 Protect the power cord from being walked on or pinched particularly at plugs, convenience receptacles, and the point where they exit from the apparatus.
- 11 Only use attachments/accessories specified by the manufacturer.
- 12 Use only with the cart, stand, tripod, bracket, or table specified by the manufacturer, or sold with the apparatus. When a cart is used, use caution when moving the cart/apparatus combination to avoid injury from tip-over.
- 13 Unplug this apparatus during lightning storms or when unused for long periods of time.
- 14 Refer all servicing to qualified service personnel. Servicing is required when the apparatus has been damaged in any way, such as power-supply cord or plug is damaged, liquid has been spilled or objects have fallen into the apparatus, the apparatus has been exposed to rain or moisture, does not operate normally, or has been dropped.



| | | |
|---|---|--|
| | CAUTION RISK OF ELECTRIC SHOCK DO NOT OPEN | |
| <p>CAUTION : TO REDUCE THE RISK OF ELECTRIC SHOCK, DO NOT REMOVE SCREWS. NO USER-SERVICEABLE PARTS INSIDE. REFER SERVICING TO QUALIFIED SERVICE PERSONNEL</p> | | |



The lightning flash with arrowhead symbol, within an equilateral triangle, is intended to alert the user to the presence of uninsulated "dangerous voltage" within the product's enclosure that may be of sufficient magnitude to constitute a risk of electric shock to persons.



The exclamation point within an equilateral triangle is intended to alert the user to the presence of important operating and maintenance (servicing) instructions in the literature accompanying the appliance.

This device complies with Part 15 of the FCC Rules. Operation is subject to the following two conditions:

- (1) This device may not cause harmful interference, and
- (2) this device must accept any interference received, including interference that may cause undesired operation.

Contains FCC ID: ACJ-TNPA6600

5.47-5.725 GHz band is restricted to indoor operations only.

FCC CAUTION

Any changes or modifications not expressly approved by the party responsible for compliance could void the user's authority to operate this equipment.

This transmitter must not be co-located or operated in conjunction with any other antenna or transmitter.

This equipment complies with FCC radiation exposure limits set forth for an uncontrolled environment and meets the FCC radio frequency (RF) Exposure Guidelines.

This equipment has very low levels of RF energy that are deemed to comply without testing of specific absorption ratio (SAR).

But it is desirable that it should be installed and operated keeping the radiator at least 20 cm (7 7/8") or more away from person's body (excluding extremities: hands, wrists, feet and ankles).

FCC Note:

This equipment has been tested and found to comply with the limits for a Class B digital device, pursuant to Part 15 of the FCC Rules. These limits are designed to provide reasonable protection against harmful interference in a residential installation. This equipment generates, uses, and can radiate radio frequency energy and, if not installed and used in accordance with the instructions, may cause harmful interference to radio communications. However, there is no guarantee that interference will not occur in a particular installation. If this equipment does cause harmful interference to radio or television reception, which can be determined by turning the equipment off and on, the user is encouraged to try to correct the interference by one or more of the following measures:

- Reorient or relocate the receiving antenna.
- Increase the separation between the equipment and receiver.
- Connect the equipment into an outlet on a circuit different from that to which the receiver is connected.
- Consult the dealer or an experienced radio/TV technician for help.

FCC Caution: To assure continued compliance, follow the attached installation instructions and use only shielded interface cables when connecting to peripheral devices.

Any changes or modifications not expressly approved by the party responsible for compliance could void the user's authority to operate this equipment.

This device complies with Part 15 of the FCC Rules. Operation is subject to the following two conditions:

- (1) This device may not cause harmful interference, and
- (2) this device must accept any interference received, including interference that may cause undesired operation.

Responsible Party:

Panasonic Corporation of North America
Two Riverfront Plaza, Newark, NJ 07102-5490
Support Contact: <http://shop.panasonic.com/support>

Conforms to UL STD 62368-1.

Precautions

WARNING

Unit

To reduce the risk of fire, electric shock or product damage,

- Do not expose this unit to rain, moisture, dripping or splashing.
- Do not place objects filled with liquids, such as vases, on this unit.
- Use the recommended accessories.
- Do not remove covers.
- Do not repair this unit by yourself. Refer servicing to qualified service personnel.

AC power supply cord

The power plug is the disconnecting device. Install this unit so that the power plug can be unplugged from the socket outlet immediately.

Small object

Keep the batteries out of reach of children to prevent swallowing.

CAUTION

Unit

- This unit utilizes a laser. Use of controls or adjustments or performance of procedures other than those specified herein may result in hazardous radiation exposure.
- Do not place sources of naked flames, such as lighted candles, on this unit.
- Some portions of this unit may become hot during use. When moving or cleaning this unit, disconnect the AC power supply cord and wait for 3 minutes or longer.

Placement

To reduce the risk of fire, electric shock or product damage,

- Do not install or place this unit in a bookcase, built-in cabinet or in another confined space. Ensure this unit is well ventilated.
- Do not obstruct this unit's ventilation openings with newspapers, tablecloths, curtains, and similar items.
- Do not place the unit on amplifiers/receivers or equipment that may become hot. The heat can damage the unit.

Batteries

Mishandling of batteries can cause electrolyte leakage and may cause a fire.

- Danger of explosion if battery is incorrectly replaced. Replace only with the type recommended by the manufacturer.
- When disposing of the batteries, please contact your local authorities or dealer and ask for the correct method of disposal.
- Do not mix old and new batteries or different types at the same time.
- Do not heat or expose to flame.
- Do not leave the battery(ies) in a car exposed to direct sunlight for a long period of time with doors and windows closed.
- Do not take apart or short circuit.
- Do not recharge alkaline or manganese batteries.
- Do not use batteries if the covering has been peeled off.

Remove batteries if you do not intend to use the remote control for a long period of time. Store in a cool, dark place.

Wireless LAN connection

The following limits are in place regarding the usage of this unit. You must be aware of these limits before using this unit. Panasonic will in no way be responsible for any incidental damage which may arise due to a failure to obey these limits, or to any condition of use or disuse of this unit.

- **Data transmitted and received over radio waves may be intercepted and monitored.**
- **This unit contains delicate electronic components.** Please use this unit in the manner in which it was intended and follow the following points:
 - Do not expose this unit to high temperatures or direct sunlight.
 - Do not bend, or subject this unit to strong impacts.
 - Keep this unit away from moisture.
 - Do not disassemble or alter this unit in any way.

To dispose or transfer this unit

The unit may keep the user settings information in the unit. If you discard this unit either by disposal or transfer, then follow the procedure to return all the settings to the factory presets to delete the user settings.

- ① Turn the unit off.
 - ② Press and hold [OK], the yellow button and the blue button on the remote control at the same time for more than 5 seconds.
 - "00 RET" is displayed on the unit's display.
 - ③ Press [▶] (right) repeatedly on the remote control until "08 FIN" is displayed on the unit's display.
 - ④ Press and hold [OK] for more than 5 seconds.
- The operation history may be recorded in the memory of this unit.

PRIVACY POLICY (excerpt)

Panasonic Entertainment & Communication Co., Ltd., a company having its registered office of 1-10-12 Yagumo-higashi-machi, Moriguchi City, Osaka 570-0021, Japan, automatically collects personal data such as IP address and/or Device ID from your device as soon as you connect it to the Internet. We do this to protect our customers and the integrity of our Service as well as to protect the rights or property of Panasonic. You have a right of access, rectification and objection to in certain circumstances, a right of erasure, restriction of processing, data portability and a right to object to other forms of processing. If you wish to exercise any of the above rights and/or wish to know more about the processing of your personal data in this context, please refer to the full text of our privacy policy displayed at "Legal Notices" of your device.

Table of contents

| | |
|---|----|
| IMPORTANT SAFETY | |
| INSTRUCTIONS | 2 |
| Precautions | 3 |
| Accessories | 4 |
| Control reference guide | 5 |
| Quick Start Guide | 7 |
| Specifications | 9 |
| Licenses | 10 |
| Limited Warranty | 11 |
| Referencia rápida en español (Spanish Quick Reference) ... | 12 |

Accessories

Check the supplied accessories before using this unit.

- 1 **Remote control**
(N2QAYA000175)
- 2 **Batteries for remote control**
 - 1 **AC power supply cord**
(K2CB2YY00098)



- Product numbers are provided in this Owner's Manual correct as of August 2018. These may be subject to change.
- Do not use AC power supply cord with other equipment.
- Using the remote control

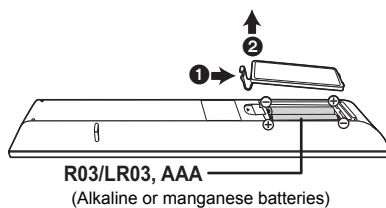

- Insert the batteries to the terminal so that it (+ and -) matches those in the remote control.

A more detailed owner's manual is available in "Owner's Manual (PDF format)". To read it, download it from the website.

<https://panasonic.jp/support/global/cs/bd/oi/index.html>

You will need Adobe Reader to browse or print the Owner's Manual (PDF format). You can download and install a version of Adobe Reader that you can use with your OS from the following website. (As of August 2018)
<http://www.adobe.com/products/acrobat/readstep2.html>



Firmware updates

Panasonic is constantly improving the unit's firmware to ensure that our customers are enjoying the latest technology. Panasonic recommends updating your firmware as soon as you are notified. For details, refer to "Firmware updates" (⇒ 9).

Control reference guide

■ Remote control

When other Panasonic devices respond to the remote control of the unit, change the remote control code.

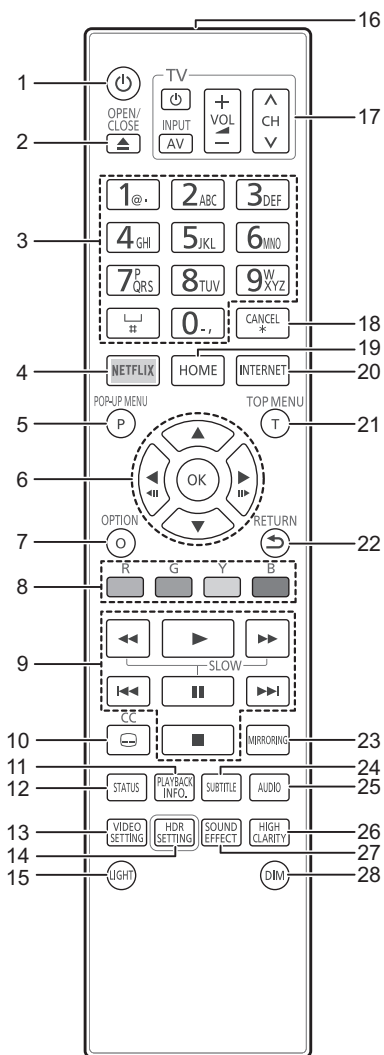

- 1 Turn the unit on and off
- 2 Open or close the disc tray
- 3 Select title numbers, etc./Enter numbers or characters
- 4 Show NETFLIX screen
- 5 Show Pop-up menu
- 6 [▲, ▼, ◀, ▶] : Move the highlight for selection
[OK] : Confirm the selection
(◀|||)(|||▶) : Frame-by-frame
- 7 Show Option menu
- 8 Colored buttons (red, green, yellow, blue)
Used for various purposes depending on the screen
- 9 Basic playback control buttons
- 10 Show Closed Caption setup screen
- 11 Show "Playback Information Window"
- 12 Show the status messages
- 13 Show "Video Settings"
- 14 Show "HDR Setting"
- 15 Light up the remote control buttons
- 16 Transmit the remote control signal
- 17 TV operation buttons
You can operate the TV through the unit's remote control. Some buttons may not work depending on the TV.
- 18 Cancel
Clear the currently selected character.
(when entering a password for "Ratings" in the Setup menu, for example)
- 19 Show HOME menu
- 20 Show the Home screen of the Network Service
- 21 Show Top menu
- 22 Return to previous screen
- 23 Show Mirroring screen
- 24 Show "Subtitle"/"Subtitle Settings"
- 25 Change soundtrack
- 26 Switch the "High Clarity Sound" settings
- 27 Switch the "Sound Effects" setting
- 28 Switch the brightness of the unit's display

■ Front

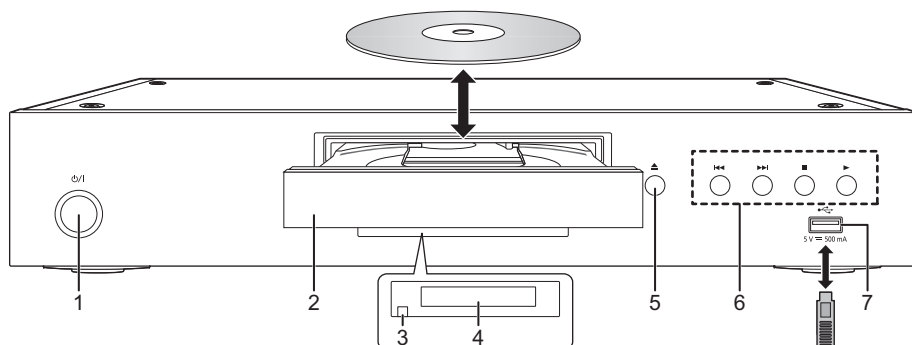

- | | |
|--|--|
| <p>1 Standby/on switch (⏻/⏻) Press to switch the unit from on to standby mode or vice versa. In standby mode, the unit is still consuming a small amount of power.</p> <p>2 Disc tray</p> <p>3 Remote control signal sensor Distance: Within approx. 7 m (23 feet) Angle: Approx. 20° up and down, 30° left and right</p> | <p>4 Display</p> <p>5 Disc tray open/close button</p> <p>6 Basic playback control buttons</p> <p>7 USB port (5 V DC 500 mA) This port supports USB 2.0 High Speed.</p> |
|--|--|

CAUTION

Do not place objects in front of the unit. The disc tray may collide with objects when it is opened, and this may cause malfunction.



- When inserting a media item, ensure that it is facing the correct way, which is the right side facing up.
- If you connect a Panasonic product with a USB connection cable, the setup screen may be displayed on the connected equipment. For details, refer to the instructions for the connected equipment.

■ Rear

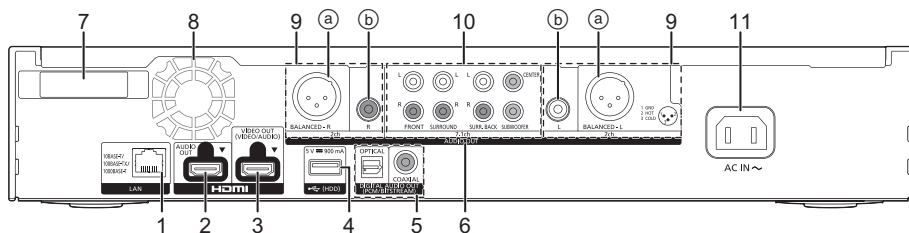

- | | |
|---|--|
| <p>1 LAN port</p> <p>2 HDMI AUDIO OUT terminal</p> <p>3 HDMI VIDEO OUT terminal</p> <p>4 USB port (HDD) (5 V DC 900 mA) This port supports USB 3.0 Super-Speed.</p> <p>5 DIGITAL AUDIO OUT terminal (OPTICAL/COAXIAL terminal)</p> <p>6 Analog AUDIO OUT terminals</p> <p>7 Wireless LAN antenna</p> <p>8 Cooling fan</p> | <p>9 2ch AUDIO OUT terminals a) BALANCED terminals b) AUDIO OUT terminals</p> <p>10 7.1ch AUDIO OUT terminals</p> <p>11 AC IN (~) terminal</p> |
|---|--|

The symbols on this product represent the following.

| | |
|-----|---|
| ~ | AC |
| --- | DC |
| | Class II equipment (The construction of the product is double-insulated.) |

Quick Start Guide

STEP 1 : Connecting to a TV

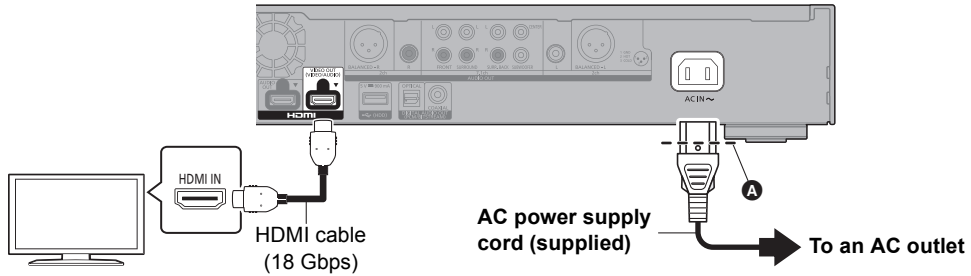

- Insert the AC power supply cord up to **A**, a point just before the round hole.
- To enjoy 4K output, you need to connect this unit to a 4K compatible TV.
- To enjoy images in 4K/60p, you need an HDMI cable that supports 18 Gbps.
When outputting 1080p or 24p (4K) signal, please use HDMI cables 5.0 meters (16.4 ft.) or less.
It is recommended that you use Panasonic's HDMI cable.
- **If you connect this unit to a 4K-compatible TV and perform "Easy Setting", 4K/60p will be automatically selected.**
- To view Ultra HD Blu-ray content in 4K/HDR format, connect to the HDMI terminal of a device that supports HDCP2.2, 4K/60p (4:4:4), and HDR signals that meet Ultra HD Blu-ray standards.
- This unit consumes a small amount of AC power (⇒ 9) even when turned off in standby mode. For the purpose of energy conservation, the unit should be disconnected if you will not be using it for extended period of time.

STEP 2 : Connecting to the network

■ Wireless LAN connection

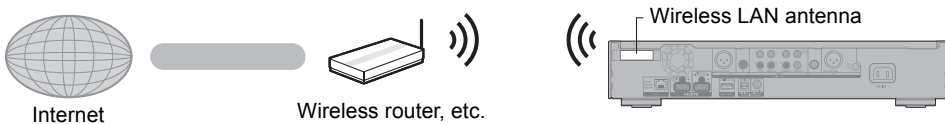

- Ensure that the wireless LAN antenna is not in contact with the HDMI cable and other cords. Otherwise, the radio signal range may be reduced.
- When using a USB-HDD, place it as far away from the wireless LAN antenna as possible. Otherwise, it may cause slower communication speeds or communication instability because of radio signal interference.

■ LAN cable connection

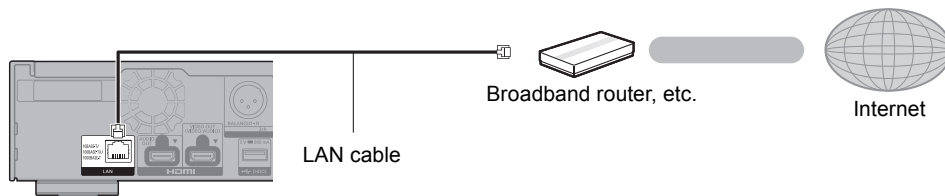

Use category 5e or above straight LAN cables (STP) when connecting to peripheral devices.

STEP 3 : Settings



1 Turn on the TV and select the appropriate video input.

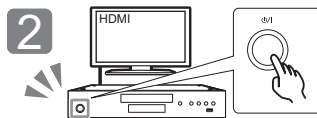

2 Press [OK].
Follow the on-screen instructions to continue with the settings.

In your use of internet functions

You must agree to the terms of use for the Internet function and the privacy policy.
[HOME] ⇒ "Setup" ⇒ "Player Settings" ⇒ "Network" ⇒ "Legal Notices"

STEP 4 : Playback

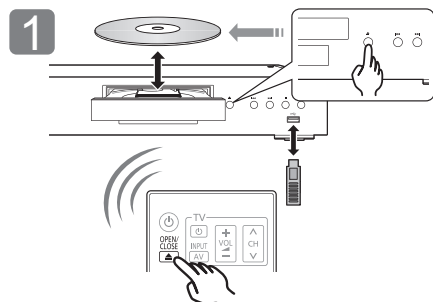

1 Insert the media.



2 Select the item to play and press [OK].

Operating during playback

The following functions may not work depending on the media and contents.

| | | |
|--------------------|--|---|
| Stop | Press [■]. | The stopping point is memorized. Resume play function Press [▶] to restart from this point. • The point is cleared if the media is removed. |
| Pause | Press [⏸]. | Press [⏸] again or [▶] to restart play. |
| Search | While playing, press [◀◀] or [▶▶]. | The speed increases up to 5 steps. • Press [▶] to revert to normal playback speed. |
| Slow motion | While paused, press [◀◀] or [▶▶]. | |
| Skip | While playing or paused, press [◀◀] or [▶▶]. | Skip to the title, chapter or track. |

Playable media

Ultra HD Blu-ray: Video

BD-Video: Video

BD-RE/BD-RE DL: Video, JPEG, MPO

BD-R/BD-R DL: Video, MKV, JPEG, MPO

DVD-Video: Video

DVD-R/DVD-R DL: Video, AVCHD, MKV, JPEG, MPO, AAC, AIFF, ALAC, DSD (DFF, DSF), FLAC, MP3, WAV, WMA

DVD-RW/+R/+RW/+R DL: Video, AVCHD

Music CD: Music [CD-DA]

CD-R/CD-RW: MKV, JPEG, MPO, AAC, AIFF, ALAC, FLAC, MP3, Music [CD-DA], WAV, WMA

USB devices (up to 4 TB): AVCHD, AVCHD 3D, MKV, MP4, MPEG2, JPEG, MPO, AAC, AIFF, ALAC, DSD (DFF, DSF), FLAC, MP3, WAV, WMA

Region management information

The unit can play back BD-Video/DVD-Video discs of the following regions codes, including "ALL":

Example: BD-Video DVD-Video



- The unit cannot playback DVD-Video discs in PAL format.

Specifications

| | |
|---|---|
| Power supply | AC 120 V, 60 Hz |
| Power consumption | Approx. 44 W |
| Power consumption in quick start standby mode | Approx. 16 W (Quick Start: On) |
| Power consumption in standby mode | Approx. 0.3 W (Quick Start: Off, Networked Standby: Off) |
| Dimensions (W×H×D) including the projecting parts | 430 mm×81 mm×325 mm (Approx. 16 15/16"×3 1/4"×12 13/16") |
| Mass (Weight) | Approx. 7.8 kg (17.2 lbs) |

- Specifications are subject to change without notice.

Firmware updates

Occasionally, Panasonic may release updated firmware for this unit that may add or improve the way a feature operates. These updates are available free of charge.

This unit is capable of checking the firmware automatically when connected to the Internet via a broadband connection.

When a new firmware version is available, the following message is displayed.

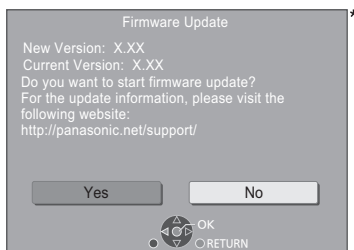

Select "Yes" to start downloading the firmware. When the firmware update starts after the downloading is finished, a black screen is displayed.

You cannot operate the unit until the update is complete. Don't remove the AC power supply cord during the update. Removing the AC power supply cord while the update is in progress may damage the unit.

After the firmware is installed, unit will restart and the following screen will be displayed.



- You can also download the latest firmware from the following website and store it to a USB device to update the firmware.

<https://panasonic.jp/support/global/cs/>
(This site is in English only.)

- To show the firmware version on this unit; [HOME] ⇨ "Setup" ⇨ "Player Settings" ⇨ "System" ⇨ "System Information" ⇨ "Firmware Version Information"
- Downloading will require several minutes. It may take longer or may not work properly depending on the connection environment.

* "X.XX" represents the firmware version number.

Licenses

This product uses Cinavia technology to limit the use of unauthorized copies of some commercially-produced film and videos and their soundtracks.

For details, refer to the Owner's Manual (PDF format).

"AVCHD", "AVCHD 3D", "AVCHD Progressive" and "AVCHD 3D/Progressive" are trademarks of Panasonic Holdings Corporation and Sony Corporation.

Java is a registered trademark of Oracle and/or its affiliates.

Dolby, Dolby Audio, Dolby Vision, and the double-D symbol are trademarks of Dolby Laboratories.

For DTS patents, see <http://patents.dts.com>.

Manufactured under license from DTS, Inc.

DTS, the Symbol, DTS and the Symbol together, DTS-HD, and the DTS-HD logo are registered trademarks and/or trademarks of DTS, Inc. in the United States and/or other countries.

© DTS, Inc. All Rights Reserved.

THX and the THX logo are trademarks of THX Ltd., registered in the United States and other countries.

The product with Hi-Res AUDIO logo is conformed to High-Resolution Audio standard defined by Japan Audio Society. This logo is used under license from Japan Audio Society.

The terms HDMI and HDMI High-Definition Multimedia Interface, and the HDMI Logo are trademarks or registered trademarks of HDMI Licensing Administrator, Inc. in the United States and other countries.

<AVC>

This product is licensed under the AVC Patent Portfolio License for the personal use of a consumer or other uses in which it does not receive remuneration to (i) encode video in compliance with the AVC Standard ("AVC Video") and/or (ii) decode AVC Video that was encoded by a consumer engaged in a personal activity and/or was obtained from a video provider licensed to provide AVC Video. No license is granted or shall be implied for any other use. Additional information may be obtained from MPEG LA, L.L.C.

See <http://www.mpegla.com>

<VC-1>

This product is licensed under the VC-1 Patent Portfolio License for the personal and non-commercial use of a consumer to (i) encode video in compliance with the VC-1 Standard ("VC-1 Video") and/or (ii) decode VC-1 Video that was encoded by a consumer engaged in a personal and non-commercial activity and/or was obtained from a video provider licensed to provide VC-1 Video. No license is granted or shall be implied for any other use. Additional information may be obtained from MPEG LA, L.L.C.

See <http://www.mpegla.com>

"DVD Logo" is a trademark of DVD Format/Logo Licensing Corporation.

"Wi-Fi®", "Miracast®", and "Wi-Fi Direct®" are registered trademarks of Wi-Fi Alliance®.

"Wi-Fi Protected Setup™" and "WPA™" are trademarks of Wi-Fi Alliance®.

Windows is a trademark or a registered trademark of Microsoft Corporation in the United States and other countries.

Android is a trademark of Google Inc.

Adobe is a trademark or registered trademark of Adobe Systems Incorporated in the United States and/or other countries.

HDR10+™ logo is a trademark of HDR10+ Technologies, LLC.

Copyright 2004-2014 Verance Corporation. Cinavia™ is a Verance Corporation trademark. Protected by U.S. Patent 7,369,677 and worldwide patents issued and pending under license from Verance Corporation. All rights reserved.

This product incorporates the following software:

- (1) the software developed independently by or for Panasonic Entertainment & Communication Co., Ltd.,
- (2) the software owned by third party and licensed to Panasonic Entertainment & Communication Co., Ltd.,
- (3) the software licensed under the GNU Lesser Public License, Version 2.0 (GPL V2.0),
- (4) the software licensed under the GNU LESSER General Public License, Version 2.1 (LGPL V2.1), and/or
- (5) open source software other than the software licensed under the GPL V2.0 and/or LGPL V2.1.

The software categorized as (3) - (5) are distributed in the hope that it will be useful, but WITHOUT ANY WARRANTY, without even the implied warranty of MERCHANTABILITY or FITNESS FOR A PARTICULAR PURPOSE.

Please refer to the detailed terms and conditions thereof shown in the Player Settings menu.

At least three (3) years from delivery of this product, Panasonic will give to any third party who contacts us at the contact information provided below, for a charge no more than our cost of physically performing source code distribution, a complete machine-readable copy of the corresponding source code covered under GPL V2.0, LGPL V2.1 or the other licenses with the obligation to do so, as well as the respective copyright notice thereof.

Contact Information: oss-cd-request@gg.jp.panasonic.com

The source code and the copyright notice are also available for free in our website below.

<https://panasonic.net/cns/oss/>

(1) MS/WMA

This product is protected by certain intellectual property rights of Microsoft Corporation and third parties. Use or distribution of such technology outside of this product is prohibited without a license from Microsoft or an authorized Microsoft subsidiary and third parties.

(2) MS/PlayReady/Final Product Labeling

This product contains technology subject to certain intellectual property rights of Microsoft. Use or distribution of this technology outside of this product is prohibited without the appropriate license(s) from Microsoft.

(3) MS/PlayReady/End User Notices

Content owners use Microsoft PlayReady™ content access technology to protect their intellectual property, including copyrighted content. This device uses PlayReady technology to access PlayReady-protected content and/or WMDRM-protected content. If the device fails to properly enforce restrictions on content usage, content owners may require Microsoft to revoke the device's ability to consume PlayReady-protected content. Revocation should not affect unprotected content or content protected by other content access technologies. Content owners may require you to upgrade PlayReady to access their content. If you decline an upgrade, you will not be able to access content that requires the upgrade.

(4) Vorbis, FLAC, WPA Supplicant

The software licenses are displayed when "License" in the Setup menu is selected.*

* [HOME] ⇨ "Setup" ⇨ "Player Settings" ⇨ "System" ⇨ "System Information"

Limited Warranty

Panasonic Products Limited Warranty

Limited Warranty Coverage (For USA Only)

If your product does not work properly because of a defect in materials or workmanship, Panasonic Corporation of North America (referred to as "the warrantor") will, for the length of the period indicated on the chart below, which starts with the date of original purchase ("warranty period"), at its option either (a) repair your product with new or refurbished parts, (b) replace it with a new or a refurbished equivalent value product, or (c) refund your purchase price. The decision to repair, replace or refund will be made by the warrantor.

| Product or Part Name | Parts | Labor |
|--|---------|----------------|
| Blu-ray Disc Player | 1 Year | 90 Days |
| All included Accessories (Except Non-Rechargeable Batteries) | 90 Days | Not Applicable |
| Only Non-Rechargeable Batteries | 10 Days | Not Applicable |

During the "Labor" warranty period there will be no charge for labor. During the "Parts" warranty period, there will be no charge for parts. This Limited Warranty excludes both parts and labor for non-rechargeable batteries, antennas, and cosmetic parts (cabinet). This warranty only applies to products purchased and serviced in the United States. This warranty is extended only to the original purchaser of a new product which was not sold "as is".

Mail-In Service--Online Repair Request Online Repair Request

To submit a new repair request and for quick repair status visit our Web Site at <http://shop.panasonic.com/support>

When shipping the unit, carefully pack, include all supplied accessories listed in the Owner's Manual, and send it prepaid, adequately insured and packed well in a carton box. When shipping Lithium Ion batteries please visit our Web Site at <http://shop.panasonic.com/support> as Panasonic is committed to providing the most up to date information. Include a letter detailing the complaint, a return address and provide a daytime phone number where you can be reached. A valid registered receipt is required under the Limited Warranty.

IF REPAIR IS NEEDED DURING THE WARRANTY PERIOD, THE PURCHASER WILL BE REQUIRED TO FURNISH A SALES RECEIPT/PROOF OF PURCHASE INDICATING DATE OF PURCHASE, AMOUNT PAID AND PLACE OF PURCHASE. CUSTOMER WILL BE CHARGED FOR THE REPAIR OF ANY UNIT RECEIVED WITHOUT SUCH PROOF OF PURCHASE.

Limited Warranty Limits and Exclusions

This warranty ONLY COVERS failures due to defects in materials or workmanship, and DOES NOT COVER normal wear and tear or cosmetic damage. The warranty ALSO DOES NOT COVER damages which occurred in shipment, or failures which are caused by products not supplied by the warrantor, or failures which result from accidents, misuse, abuse, neglect, mishandling, misapplication, alteration, faulty installation, set-up adjustments, misadjustment of consumer controls, improper maintenance, power line surge, lightning damage, modification, introduction of sand, humidity or liquids, commercial use such as hotel, office, restaurant, or other business or rental use of the product, or service by anyone other than a Factory Service Center or other Authorized Servicer, or damage that is attributable to acts of God. **THERE ARE NO EXPRESS WARRANTIES EXCEPT AS LISTED UNDER "LIMITED WARRANTY COVERAGE". THE WARRANTOR IS NOT LIABLE FOR INCIDENTAL OR CONSEQUENTIAL DAMAGES RESULTING FROM THE USE OF THIS PRODUCT, OR ARISING OUT OF ANY BREACH OF THIS WARRANTY.**

(As examples, this excludes damages for lost time, travel to and from the servicer, loss of or damage to media or images, data or other memory or recorded content. The items listed are not exclusive, but for illustration only.)

ALL EXPRESS AND IMPLIED WARRANTIES, INCLUDING THE WARRANTY OF MERCHANTABILITY, ARE LIMITED TO THE PERIOD OF THE LIMITED WARRANTY.

Some states do not allow the exclusion or limitation of incidental or consequential damages, or limitations on how long an implied warranty lasts, so the exclusions may not apply to you. This warranty gives you specific legal rights and you may also have other rights which vary from state to state. If a problem with this product develops during or after the warranty period, you may contact your dealer or Service Center. If the problem is not handled to your satisfaction, then write to:

Panasonic Corporation of North America
Consumer Affairs Department 8th Fl.
Two Riverfront Plaza
Newark NJ 07102-5490

PARTS AND SERVICE, WHICH ARE NOT COVERED BY THIS LIMITED WARRANTY, ARE YOUR RESPONSIBILITY.

Shop Accessories!

for all your Panasonic gear

Go to

<http://shop.panasonic.com/support>

Get everything you need to get the most out of your Panasonic products

Accessories & Parts for your Camera, Phone, A/V products, TV, Computers & Networking, Personal Care, Home Appliances, Headphones, Batteries, Backup Chargers & more...

Customer Services Directory

For Product Information, Operating Assistance, Parts, Owner's Manuals, Dealer and Service info go to <http://shop.panasonic.com/support>

For the hearing or speech impaired TTY: 1- 877-833-8855

1912

The model number and serial number of this product can be found on either the back or the bottom of the unit. Please note them in the space provided below and keep for future reference.

MODEL NUMBER _____ DP-UB9000 _____
SERIAL NUMBER _____

User memo:

DATE OF PURCHASE _____
DEALER NAME _____
DEALER ADDRESS _____
TELEPHONE NUMBER _____

Referencia rápida en español (Spanish Quick Reference)

Conexiones básicas

Conexión a un televisor compatible con HDMI

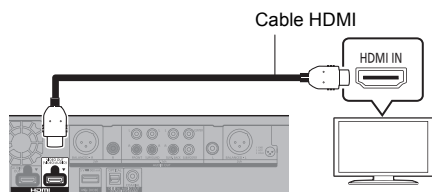

Conexión a un televisor compatible con HDMI y a un amplificador/receptor compatible con HDMI

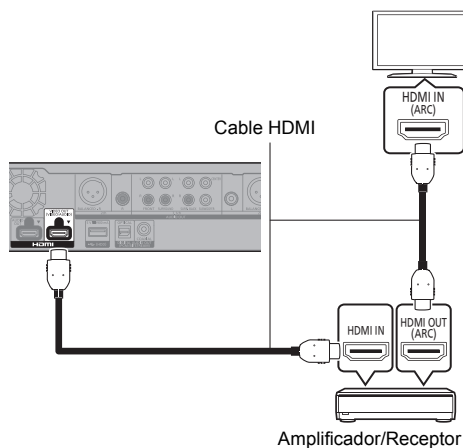

Conecte el cable de alimentación de CA por último



Cable de alimentación de CA (incluido)

A una toma de corriente doméstica

- Conéctelo cuando haya realizado el resto de conexiones.

Ahorro de energía

Esta unidad consume una pequeña cantidad de energía aunque esté ajustada en el modo de espera (Accionamiento rápido : Desactivado, aprox. 0,3 W). Para ahorrar energía cuando no vaya a utilizar la unidad durante mucho tiempo, desenchúfela de la toma de corriente.



Conexiones básicas

Preparación

Encienda el televisor y seleccione la entrada de vídeo adecuada en el televisor.

1 Pulse [⏻] para encender la unidad.

Después de conectar su nuevo reproductor y pulsar el botón de encendido, aparecerá la pantalla de la configuración básica.

2 Inserte el medio.

Inicia la reproducción

Pulse [▶].

Parada

Pulse [■].

La posición de detención se memoriza.

Función de reanudación de la reproducción

Pulse [▶] para reiniciar la reproducción desde esta posición.

- El punto se anula si se extrae el medio.
- En los discos BD-Video incluidos los BD-J, la función de reanudación de la reproducción no funciona.

Pausa

Pulse [⏸].

- Pulse [⏸] otra vez o [▶] para reiniciar la reproducción.

Búsqueda/Cámara lenta

Búsqueda

Durante la reproducción, pulse [◀◀] o [▶▶].

- Ultra HD Blu-ray, MKV, MP4 y MPEG2: No se escucha sonido. (Cuando "Ajuste de la Guía por voz" está configurado como "Activado", el audio no se escucha con independencia del medio.)

Cámara lenta

Durante la pausa, pulse [◀◀] o [▶▶].

- Vídeo BD y AVCHD: [▶▶] únicamente.
- MKV, MP4 y MPEG2: No es eficaz.

La velocidad aumenta hasta 5 pasos.

- Música y MP3, etc.: La velocidad está fija en un paso.
- Pulse [▶] para recuperar la velocidad de reproducción normal.

Salto

Durante la reproducción o la pausa, pulse

[◀◀◀] o [▶▶▶].

Salta hasta el título, capítulo o pista que desee reproducir.

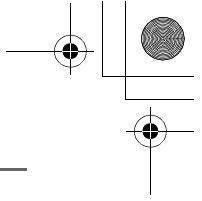
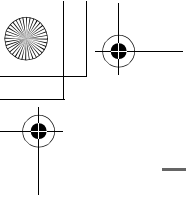

25 horizontal lines for writing.

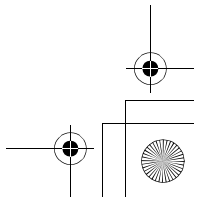
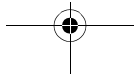
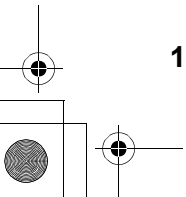
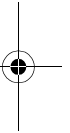
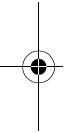

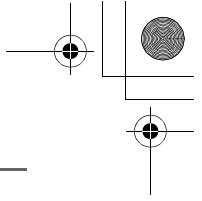
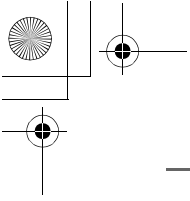

A series of 21 horizontal lines spanning the width of the page, providing a ruled area for writing or drawing.

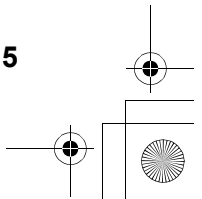
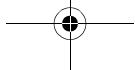
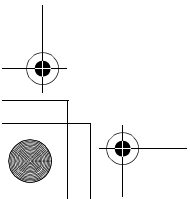
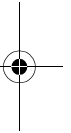
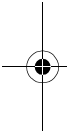



| | |
|---|-------------------------|
| CAUTION - VISIBLE AND INVISIBLE LASER RADIATION WHEN OPEN, DO NOT STARE INTO BEAM. | FDA 21CFRCLASS II (III) |
| CAUTION - CLASS 2 VISIBLE AND INVISIBLE LASER RADIATION WHEN OPEN, DO NOT STARE INTO THE BEAM. | IEC60825-1:CLASS 2 |
| ATTENTION - RAYONNEMENT LASER VISIBLE ET INVISIBLE, CLASSE 2, EN CAS D'OUVERTURE, NE PAS REGARDER DANS LE FAISCEAU. | |
| FORSIGTIG - SYNLIG OG USYNLIG LASERSTRÅLING KLASSE 2, NÅR LÅGET ER ÅBENT, UNDGÅ AT SE LIGE IND I STRÅLEN. | |
| VARO - AVATTAESSA OLET ALTTIINA LUOKAN 2 NÄKYVÄÄ JA NÄKYMÄTONTÄ LASERSÄTELYÄ, ÄLÄ TUJOTA SÄTEESEEN. | |
| VARNING - KLASS 2 SYNLIG OCH OSYNLIG LASERSTRÅLNING NÅR DENNA DEL ÄR ÖPPNAD, STIRRA EJ IN I STRÅLEN. | |
| VORSICHT - SICHTBARE UND UNSICHTBARE LASERSTRAHLUNG KLASSE 2, WENN ABDECKUNG GEÖFFNET, NICHT IN DEN STRAHL BLICKEN. | |

(Inside of product)

USA Only: To dispose of your product, please recycle in accordance with local environmental regulations. For further recycling information please visit <https://shop.panasonic.com/recycle>

Panasonic Corporation of North America

Two Riverfront Plaza, Newark, NJ 07102-5490
<http://shop.panasonic.com>

