

Panasonic

LUMIX S9

Owner's Manual
<Quick Start Guide>
Digital Camera
DC-S9

Please read these instructions carefully before using this product, and save this manual for future use.

Owner's Manual <Complete Guide>

Refer to "Owner's Manual <Complete Guide>" (HTML format/PDF format) for details about how to use the camera and notes on use.
<https://panasonic.jp/support/dsc/oi/S9/index.html>

U.S. customers only
Register online at <http://shop.panasonic.com/support/register>
to receive these benefits:

- ✓ Safety Notification
- ✓ Owner Verification
- ✓ Efficient Warranty Service
- ✓ Special Offers and Promotions from Panasonic

If you have any questions, visit:
USA : <http://shop.panasonic.com/support>

Panasonic Corporation of North America
Two Riverfront Plaza, Newark, NJ 07102-5490
<http://shop.panasonic.com>
© Panasonic Entertainment & Communication Co., Ltd. 2024
DVQX2516ZB
F0424KN1064

Dear Customer,
Thank you for choosing Panasonic!
You have purchased one of the most sophisticated and reliable products on the market today. Used properly, we're sure it will bring you and your family years of enjoyment. Please take time to fill in the information below. The serial number is on the tag located on the underside of your camera. Be sure to **retain this manual** as your convenient camera information source.

Date of Purchase	Dealer Phone No.
Dealer Purchased From	Model No.
Dealer Address	Serial No.

Please note that the actual controls and components, menu items, etc. of your Digital Camera may look somewhat different from those shown in the illustrations in this Owner's Manual.

Information for Your Safety

WARNING:
To reduce the risk of fire, electric shock or product damage,

- Do not expose this unit to rain, moisture, dripping or splashing.
- Use the recommended accessories.
- Do not remove covers.
- Do not repair this unit by yourself. Refer servicing to qualified service personnel.

Product identification marking

Product	Location
Digital camera	Bottom

THE FOLLOWING APPLIES ONLY IN THE U.S.A.

FCC Note:
This equipment has been tested and found to comply with the limits for a Class B digital device, pursuant to Part 15 of the FCC Rules. These limits are designed to provide reasonable protection against harmful interference in a residential installation. This equipment generates, uses, and can radiate radio frequency energy and, if not installed and used in accordance with the instructions, may cause harmful interference to radio communications. However, there is no guarantee that interference will not occur in a particular installation. If this equipment does cause harmful interference to radio or television reception, which can be determined by turning the equipment off and on, the user is encouraged to try to correct the interference by one or more of the following measures:

- Reorient or relocate the receiving antenna.
- Increase the separation between the equipment and receiver.
- Connect the equipment into an outlet on a circuit different from that to which the receiver is connected.
- Consult the dealer or an experienced radio/TV technician for help.

FCC Caution:

- Any unauthorized changes or modifications to this equipment would void the user's authority to operate this device.
- To assure continued compliance, follow the attached installation instructions and use only shielded interface cables with ferrite core when connecting to computer or peripheral devices.

This device complies with Part 15 of the FCC Rules. Operation is subject to the following two conditions: (1) This device may not cause harmful interference, and (2) this device must accept any interference received, including interference that may cause undesired operation.

Supplier's Declaration of Conformity
Trade Name: Panasonic
Model No.: DC-S9
Responsible Party: Panasonic Corporation of North America
Two Riverfront Plaza, Newark, NJ 07102-5490
Support Contact: <http://shop.panasonic.com/support>

How to Display Certification and Compliance Information
Certification and compliance information for this camera can be viewed on the menu screen.

- 1 Select the [Others] tab of the [Setup] menu.
- 2 Select [Approved Regulations] and confirm your selection.

Contains FCC ID: VPYLBEE5ZZ1PJ

This transmitter must not be co-located or operated in conjunction with any other antenna or transmitter.

This equipment complies with FCC radiation exposure limits set forth for an uncontrolled environment and meets the FCC radio frequency (RF) Exposure Guidelines as this equipment has very low levels of RF energy.

Compliance with FCC requirement 15.407(c)
Data transmission is always initiated by software, which is the passed down through the MAC, through the digital and analog baseband, and finally to the RF chip. Several special packets are initiated by the MAC. These are the only ways the digital baseband portion will turn on the RF transmitter, which it then turns off at the end of the packet. Therefore, the transmitter will be on only while one of the aforementioned packets is being transmitted. In other words, this device automatically discontinues transmission in case of either absence of information to transmit or operational failure.

Frequency Tolerance: ± 20ppm

About the battery pack

CAUTION

Battery pack (Lithium ion battery pack)

- Use the specified unit to recharge the battery pack.
- Do not use the battery pack with equipment other than the specified unit.
- Do not get dirt, sand, liquids, or other foreign matter on the terminals.
- Do not touch the plug terminals (+ and -) with metal objects.
- Do not disassemble, remodel, heat or throw into fire.

If any electrolyte should come into contact with your hands or clothes, wash it off thoroughly with water.
If any electrolyte should come into contact with your eyes, never rub the eyes. Rinse eyes thoroughly with water, and then consult a doctor.

CAUTION

- Danger of explosion if battery is incorrectly replaced. Replace only with the type recommended by the manufacturer.
- When disposing of the batteries, please contact your local authorities or dealer and ask for the correct method of disposal.

- Do not heat or expose to flame.
- Do not leave the battery(ies) in a car exposed to direct sunlight for a long period of time with doors and windows closed.
- Do not expose to low air pressure at high altitudes.
- Do not expose to extremely low air pressure, as this may result in explosions or leakage of flammable liquids and gases.

Warning
Risk of fire, explosion and burns. Do not disassemble, heat above 60 °C (140 °F) or incinerate.

Concerning the button cell or coin battery

WARNING

- **INGESTION HAZARD:** This product contains a button cell or coin battery.
- **DEATH** or serious injury can occur if ingested.
- A swallowed button cell or coin battery can cause **Internal Chemical Burns** in as little as **2 hours**.
- **KEEP** new and used batteries **OUT OF REACH** of CHILDREN
- **Seek immediate medical attention** if a battery is suspected to be swallowed or inserted inside any part of the body.

This product contains non-replaceable batteries. Even used batteries may cause severe injury or death. Call a local poison control center for treatment information. Battery type: MS414GE. Nominal voltage: 3 V. Do not force discharge, recharge, disassemble, heat above (manufacturer's specified temperature rating) or incinerate. Doing so may result in injury due to venting, leakage or explosion resulting in chemical burns.

Standard Accessories

- Always use a genuine Panasonic Tripod Grip (DMW-SHGR2: optional).
- Use a Premium High Speed HDMI micro cable (Type D–Type A plug) with the length less than 3 m (9.8 feet).
- Use a stereo microphone cable with the length less than 3 m (9.8 feet).

Keep the accessory shoe cover out of reach of children to prevent swallowing.
Keep the memory card out of reach of children to prevent swallowing.

Product numbers correct as of May 2024.

Digital camera body

Battery pack DMW-BLK22	Body cap ^{*1} 1HE1MC891Z
Shoulder strap DVPW1035Z	Accessory shoe cover ^{*1} DVKV1118Z/K (Black)

Interchangeable lens "LUMIX S 20-60mm F3.5-5.6"^{*2}
S-R2060

Lens hood 1ZE4SR2060Z	Lens rear cap ^{*3} RGE1Z276Z
Lens cap ^{*3} CGE1Z293Z	

^{*1} This is attached to the camera at the time of purchase.
^{*2} This is supplied with Lens Kit DC-S9K.
^{*3} This is attached to the lens at the time of purchase.

- If accessories are lost, customers can visit us at <http://shop.panasonic.com/support> for further information about obtaining replacement parts.
- To order optional accessories please visit <http://shop.panasonic.com> or your local Photo Specialty Dealer.

Names of Important Parts

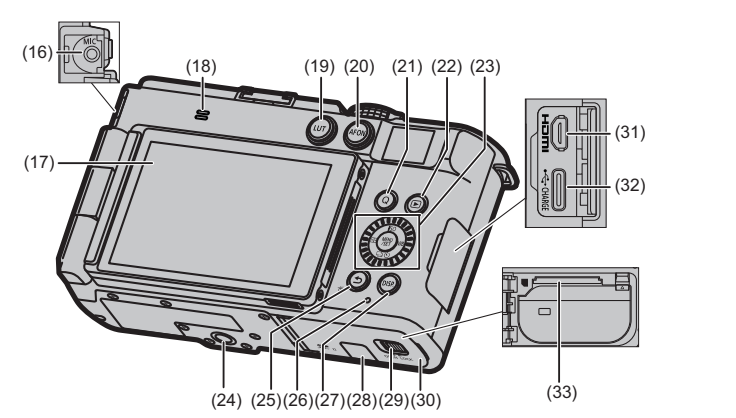
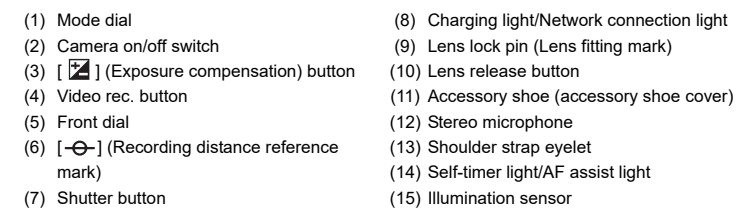
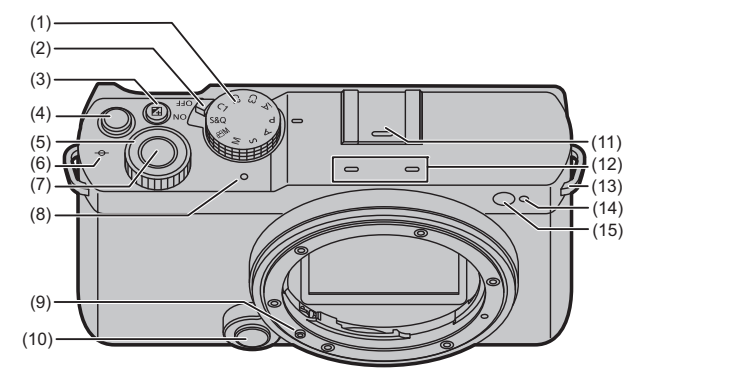

Attaching a Shoulder Strap

Attach a shoulder strap to the camera with the following procedure to prevent it from dropping.

- 1
- 2
- 3
- 4

Charging the Battery

Charge using an AC adaptor (optional/commercially available) and a USB connection cable (commercially available).

- 1 **Set the camera on/off switch to [OFF].**
- 2 **Insert the battery into the camera.**
- 3 **Connect the camera USB port and the AC adaptor using the USB connection cable.**
- 4 **Connect the AC adaptor to an electrical outlet.**
 - The charging light turns red and charging begins. The charging light turns off when charging is complete.

(A) To the AC adaptor

Charging time	Approx. 240 min
---------------	-----------------

- Using either the camera body and the optional AC Adaptor (DMW-AC11) or the camera body and the supplied accessories of the optional Battery Charger (DMW-BTC15).

Cautions

- The battery that can be used with the camera is DMW-BLK22. (As of May 2024)
- **Always use genuine Panasonic batteries (DMW-BLK22).**
- **If you use other batteries, we cannot guarantee the quality of this product.**
- **It is recommended to use the Panasonic AC Adaptor (DMW-AC11: optional) or the supplied accessories of the Panasonic Battery Charger (DMW-BTC15: optional) for charging.**
- You can charge with the camera body using a commercially available AC adaptor and a USB connection cable.
 - *Recommended specifications for the commercially available AC adaptor
 - Supports 5 V/3 A (15 W) DC output
 - USB Type-C terminal
 - *Use a USB connection cable with 15 W output or better for charging.
- You can also use an AC adaptor with 5 V/500 mA or better for charging. However, charging time may be longer than with the recommended AC adaptor.
- Operation is not guaranteed with all commercially available devices.
- Using charging methods other than those specified may result in fluid leakage, overheating, combustion, rupturing, etc., and these may cause injury.
- This battery may present a risk of fire or chemical burn if mistreated.
- Place the removed battery in a plastic bag, and store or keep away from metallic objects (clips, etc.).
- When disposing of the batteries, please contact your local authorities or dealer and ask for the correct method of disposal.

Inserting Cards (Optional)

You can use SD memory cards with this camera.

- For information on memory cards with confirmed operation, check the following support site:
<https://panasonic.jp/support/global/cs/dsc/connect/index.html>
(English only)

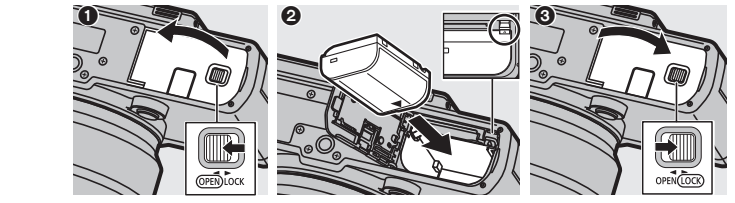

- 1
- 2
- 3
- 4

(A) To the AC adaptor

Charging time	Approx. 240 min
---------------	-----------------

- Using either the camera body and the optional AC Adaptor (DMW-AC11) or the camera body and the supplied accessories of the optional Battery Charger (DMW-BTC15).

Inserting Cards (Optional)

You can use SD memory cards with this camera.

- For information on memory cards with confirmed operation, check the following support site:
<https://panasonic.jp/support/global/cs/dsc/connect/index.html>
(English only)

- 1
- 2
- 3

- Match the orientation of the cards as shown in the figure and then insert them firmly until they click.
- To remove a card, confirm that the corresponding card access light has turned off, push the card until it clicks, then pull the card out straight.
- Format the cards with the camera before use.
[] → [] → [] → Select [Card Format]

Attaching a Lens

The lens mount of this camera is compliant with the L-Mount standard of Leica Camera AG.

- Refer to catalogs/websites for information regarding supported lenses. <https://panasonic.jp/support/global/cs/dsc/connect/index.html> (English only)

– Attaching commercially available accessories that do not comply with the L-Mount standard may lead to operation failure or malfunction of the camera.

If a failure or malfunction occurs due to this cause, the warranty will be void.

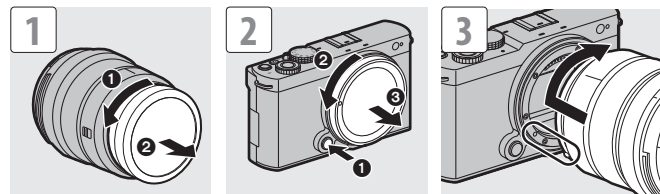

- When removing the lens or body cap, rotate while pressing the lens release button.

Setting the Clock (When Turning On for the First Time)

When you turn the camera on for the first time, a screen to set the time zone and clock appears. Follow the message to make the settings.

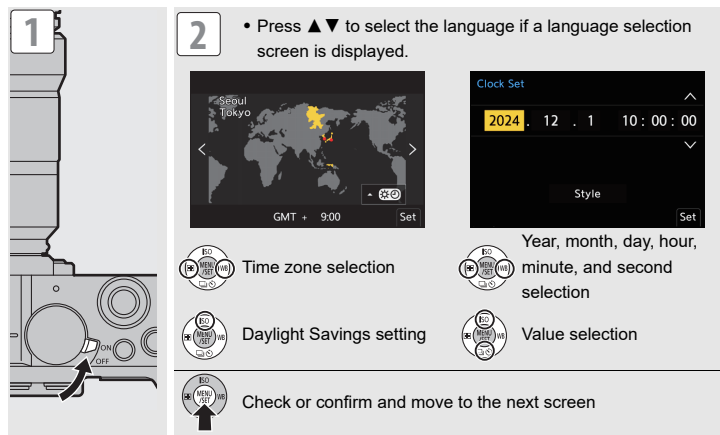

Taking Pictures

- Rotate the mode dial to select the recording mode ([iA]/[P]/[A]/[S]/[M]).
- Press the shutter button halfway (press it gently) to focus.
- Press the shutter button fully (press it further) to take pictures.

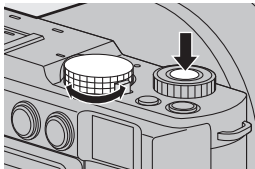

Recording Videos

- Rotate the mode dial to select the recording mode.
- Press the video rec. button to start recording.
- Press the video rec. button again to end recording.

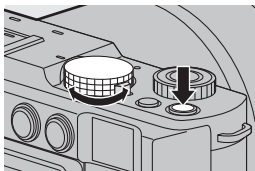

Playing Back Images

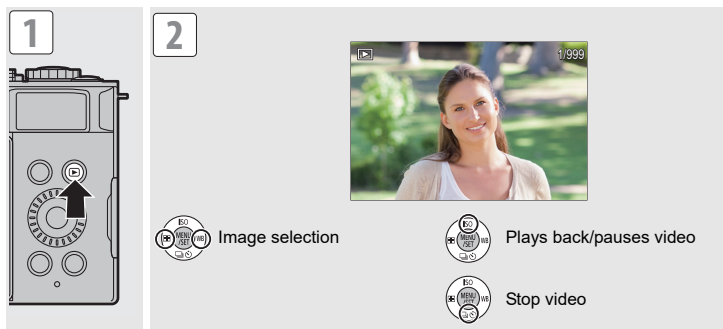

Cautions for Use

❖ Firmware of Your Camera/Lens

Firmware updates may be provided in order to improve camera capabilities or to add functionality.

- For the latest information on the firmware or to download/update the firmware, visit the following support site: <https://panasonic.jp/support/global/cs/dsc/download/index4.html> (English only)

❖ Handling of the Camera

The camera is not dust resistant, splash resistant, or waterproof.

Avoid using the camera in places with excessive dust or sand, or where water can come into contact with the camera.

❖ Be Sure to Perform Trial Recording in Advance

Be sure to perform trial recording in advance to check that recording can be performed normally. Please note that compensation cannot be provided in the event that recording could not be performed due to a problem with the camera or a card.

❖ Be Careful with Regard to Copyrights

Under copyright law, you may not use the images and audio you have recorded without the permission of the copyright holder.

❖ Caution with Strong Light Beams Such as Laser Light

Do not allow strong light beams, such as laser light, to be directly exposed to this camera (lens). These can destroy the image sensor and cause the camera to malfunction.

❖ The camera

Keep this unit as far away as possible from electromagnetic equipment (such as microwave ovens, TVs, video games etc.).

- If you use this unit on top of or near a TV, the pictures and/or sound on this unit may be disrupted by electromagnetic wave radiation.
- Do not use this unit near cell phones because doing so may result in noise adversely affecting the pictures and/or sound.
- Recorded data may be damaged, or pictures may be distorted, by strong magnetic fields created by speakers or large motors.
- Electromagnetic wave radiation may adversely affect this unit, disturbing the pictures and/or sound.
- If this unit is adversely affected by electromagnetic equipment and stops functioning properly, turn this unit off and remove the battery or disconnect AC adaptor. Then reinsert the battery or reconnect AC adaptor and turn this unit on.

Do not use this unit near radio transmitters or high-voltage lines.

- If you record near radio transmitters or high-voltage lines, the recorded pictures and/or sound may be adversely affected.

❖ Wi-Fi® Function

Use of the Wi-Fi function of the camera is presumed to be in countries where it is sold.

There is the risk that the camera violates the radio wave regulations if used in countries other than those where it is sold, and Panasonic takes no responsibility for any violations.

- Please be advised that Panasonic is not liable for any damage directly or indirectly caused by use (including use in combination with the products of other companies) or malfunction of this product.
- Please be advised that Panasonic is not liable for any damage to data caused by this product.
- The external design and specifications of this product, as described in this document, may differ from the actual product due to improvements made.

Main Specifications

The specifications are subject to change for performance enhancement.

Digital camera body (DC-S9):

Information for your safety

Power source:	9.0 V ===
Power consumption:	3.9 W (when recording with the monitor), 3.3 W (when playing back with the monitor) [When using the interchangeable lens (S-R2060)]

Type	
Type	Digital Single Lens Mirrorless camera
Lens mount	Leica Camera AG L-Mount
Recording media	SD memory card / SDHC memory card / SDXC memory card
Image sensor	
Image sensor	35 mm full-frame (35.6 mm×23.8 mm) CMOS sensor, a total of approx. 25,300,000 pixels, primary color filter
Effective number of pixels of the camera	Approx. 24,200,000 pixels
Monitor	
Type	Aspect ratio 3:2, 3.0 inches, approx. 1,840,000 dots monitor, capacitive touch screen
Interface	
USB	USB Type-C®, USB 10Gbps
HDMI	HDMI Type D
[MIC]	∅3.5 mm stereo mini jack
External dimensions / Mass (Weight)	
External dimensions	Approx. 126.0 mm (W)×73.9 mm (H)×46.7 mm (D) (4.96" (W)×2.91" (H)×1.84" (D)) (excluding the projecting parts)
Mass (Weight)	Approx. 486 g/1.08 lb (camera body, with battery and card) Approx. 403 g/0.89 lb (only camera body)
Operating environment	
Recommended operating temperature	0 °C to 40 °C (32 °F to 104 °F)
Permissible relative humidity	10 %RH to 80 %RH
Wi-Fi	
Compliance standard	IEEE 802.11a/b/g/n/ac (standard wireless LAN protocol)
Frequency range used (central frequency)	2412 MHz to 2462 MHz (1 to 11ch) 5180 MHz to 5320 MHz (36/40/44/48/52/56/60/64ch) 5500 MHz to 5720 MHz (100/104/108/112/116/120/124/128/132/136/140/144ch) 5745 MHz to 5825 MHz (149/153/157/161/165ch)
Encryption method	Wi-Fi compliant WPA™ / WPA2™ / WPA3™
Access method	Infrastructure mode
Bluetooth®	
Compliance standard	Bluetooth v5.0, Bluetooth Low Energy (BLE)
Frequency range used (central frequency)	2402 MHz to 2480 MHz

Battery pack (lithium-ion) (Panasonic DMW-BLK22):

Information for your safety

Voltage/capacity:	7.2 V / 2200 mAh
-------------------	------------------

The symbols on this product (including the accessories) represent the following:

=== DC

Trademarks and Licenses

- L-Mount is a trademark or registered trademark of Leica Camera AG.
- SDXC Logo is a trademark of SD-3C, LLC.



- The terms HDMI, HDMI High-Definition Multimedia Interface, HDMI Trade dress and the HDMI Logos are trademarks or registered trademarks of HDMI Licensing Administrator, Inc.



- USB Type-C® and USB-C® are registered trademarks of USB Implementers Forum.

- QuickTime and the QuickTime logo are trademarks or registered trademarks of Apple Inc., used under license therefrom.



- The Bluetooth® word mark and logos are registered trademarks owned by Bluetooth SIG, Inc. and any use of such marks by Panasonic Holdings Corporation is under license. Other trademarks and trade names are those of their respective owners.



- "Wi-Fi®" is a registered trademark of Wi-Fi Alliance®.

- "WPA™", "WPA2™", and "WPA3™" are trademarks of Wi-Fi Alliance®.

- QR Code is a registered trademark of DENSO WAVE INCORPORATED.

- Other names, company names, product names mentioned in this document are trademarks or registered trademarks of the companies concerned.

At least three (3) years from delivery of this product, Panasonic will give to any third party who contacts us at the contact information provided below, for a charge no more than our cost of physically performing source code distribution, a complete machine-readable copy of the corresponding source code covered under GPL V2.0 or LGPL V2.1, as well as the respective copyright notice thereof.

Contact Information: oss-cd-request@gp.jp.panasonic.com

The source code and the copyright notice are also available for free in our website below. <https://panasonic.net/cns/oss/index.html>

This product is licensed under the AVC Patent Portfolio License for the personal use of a consumer or other uses in which it does not receive remuneration to (i) encode video in compliance with the AVC Standard ("AVC Video") and/or (ii) decode AVC Video that was encoded by a consumer engaged in a personal activity and/or was obtained from a video provider licensed to provide AVC Video. No license is granted or shall be implied for any other use. Additional information may be obtained from MPEG LA, L.L.C. See <http://www.mpegla.com>

For the U.S.A. and Canada only

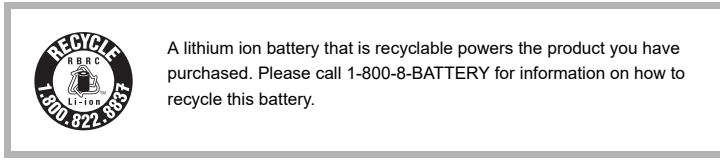

[For U.S.A.]

To dispose of your product, please recycle in accordance with local environmental regulations.

For further recycling please visit

<https://shop.panasonic.com/recycle>

Limited Warranty (ONLY FOR U.S.A.)

Panasonic Products Limited Warranty

Limited Warranty Coverage (For USA Only)

If your product does not work properly because of a defect in materials or workmanship, Panasonic Corporation of North America (referred to as "the warrantor") will, for the length of the period indicated on the chart below, which starts with the date of original purchase ("warranty period"), at its option either (a) repair your product with new or refurbished parts, (b) replace it with a new or a refurbished equivalent value product, or (c) refund your purchase price. The decision to repair, replace or refund will be made by the warrantor.

Product or Part Name	Parts	Labor
Digital Camera	1 Year	1 Year
All included Accessories (Except Non-Rechargeable Batteries)	90 Days	Not Applicable
Only Non-Rechargeable Batteries	10 Days	Not Applicable

During the "Labor" warranty period there will be no charge for labor. During the "Parts" warranty period, there will be no charge for parts. This Limited Warranty excludes both parts

and labor for non-rechargeable batteries, antennas, and cosmetic parts (cabinet). This warranty only applies to products purchased and serviced in the United States. This warranty is extended only to the original purchaser of a new product which was not sold "as is".

Mail-In Service—Online Repair Request

Online Repair Request

To submit a new repair request and for quick repair status visit our Web Site at

<http://shop.panasonic.com/support>.

When shipping the unit, carefully pack, include all supplied accessories listed in the Owner's Manual, and send it prepaid, adequately insured and packed well in a carton box. When shipping Lithium Ion batteries please visit our Web Site at

<http://shop.panasonic.com/support> as Panasonic is committed to providing the most up to date information. Include a letter detailing the complaint, a return address and provide a daytime phone number where you can be reached. A valid registered receipt is required under the Limited Warranty.

IF REPAIR IS NEEDED DURING THE WARRANTY PERIOD, THE PURCHASER WILL BE REQUIRED TO FURNISH A SALES RECEIPT/PROOF OF PURCHASE INDICATING DATE OF PURCHASE, AMOUNT PAID AND PLACE OF PURCHASE. CUSTOMER WILL BE CHARGED FOR THE REPAIR OF ANY UNIT RECEIVED WITHOUT SUCH PROOF OF PURCHASE.

Limited Warranty Limits and Exclusions

This warranty ONLY COVERS failures due to defects in materials or workmanship, and DOES NOT COVER normal wear and tear or cosmetic damage. The warranty ALSO DOES NOT COVER damages which occurred in shipment, or failures which are caused by products not supplied by the warrantor, or failures which result from accidents, misuse, abuse, neglect, mishandling, misapplication, alteration, faulty installation, set-up adjustments, misadjustment of consumer controls, improper maintenance, power line surge, lightning damage, modification, introduction of sand, humidity or liquids, or rental use of the product, or service by anyone other than a Factory Service Center or other Authorized Servicer, or damage that is attributable to acts of God.

THESE ARE NO EXPRESS WARRANTIES EXCEPT AS LISTED UNDER "LIMITED WARRANTY COVERAGE".

THE WARRANTOR IS NOT LIABLE FOR INCIDENTAL OR CONSEQUENTIAL DAMAGES RESULTING FROM THE USE OF THIS PRODUCT, OR ARISING OUT OF ANY BREACH OF THIS WARRANTY.

(As examples, this excludes damages for lost time, travel to and from the servicer, loss of or damage to media or images, data or other memory or recorded content. The items listed are not exclusive, but for illustration only.)

ALL EXPRESS AND IMPLIED WARRANTIES, INCLUDING THE WARRANTY OF MERCHANTABILITY, ARE LIMITED TO THE PERIOD OF THE LIMITED WARRANTY.

Some states do not allow the exclusion or limitation of incidental or consequential damages, or limitations on how long an implied warranty lasts, so the exclusions may not apply to you.

This warranty gives you specific legal rights and you may also have other rights which vary from state to state. If a problem with this product develops during or after the warranty period, you may contact your dealer or Service Center. If the problem is not handled to your satisfaction, then write to:

Panasonic Corporation of North America
Consumer Affairs Department
Two Riverfront Plaza
Newark NJ 07102-5490

PARTS AND SERVICE, WHICH ARE NOT COVERED BY THIS LIMITED WARRANTY, ARE YOUR RESPONSIBILITY.

Product registration is not mandatory. Failure to complete the form does not affect the consumer's warranty rights.

Shop Accessories!

for all your Panasonic gear

Go to

<http://shop.panasonic.com/support>

Get everything you need to get the most out of your Panasonic products
Accessories & Parts for your Camera, Phone, A/V products, TV, Computers & Networking, Personal Care, Home Appliances, Headphones, Batteries, Backup Chargers & more...

Customer Services Directory

For Product Information, Operating Assistance, Parts, Owner's Manuals, Dealer and Service info go to <http://shop.panasonic.com/support>

For the hearing or speech impaired TTY: 1- 877-833-8855