



Panasonic®

Owner's Manual Microwave Oven Household Use Only

Model No. NN-SN686S
NN-SN67HS
NN-SN65HS



Scan this code for product registration



READ ALL INSTRUCTIONS CAREFULLY BEFORE USING THE OVEN.

For assistance, please contact us via the web at:
<http://shop.panasonic.com/support> (U.S.A Only)

For microwave oven safety reference, please visit the FDA's web page at:
<http://www.fda.gov/radiation-emittingproducts/resourcesforyourradiationemittingproducts/ucm252762.htm>

Para obtener instrucciones en español, por favor visite la página web en:
<http://shop.panasonic.com/support>

F0003CU00AT
PA0224-0
Printed in China
© Panasonic Corporation 2024

CONTENTS

Safety Information

IMPORTANT SAFETY INSTRUCTIONS	1-3
Installation and Grounding Instructions	3-4
Food Preparation.....	4-5
Location of Controls	7

Operation

Using the Microwave for the First Time	8
Setting the Clock.....	8
Setting the Child Safety Lock	8
Setting the Child Safety Door Lock	9
Cooking	10
Setting the Timer	10
Setting a Standing Time.....	11
Setting a Delayed Start.....	11
Quick 30	12
Keep Warm.....	12
Popcorn.....	12
Inverter Turbo Defrost	13
Defrosting Tips & Techniques	13
Sensor Reheat	14
Sensor Cook.....	14
Sensor Cook Chart.....	15
Food Characteristics	16

Maintenance

Care and Cleaning of Your Microwave Oven.....	17
Shop Accessories	17
Before Requesting Service	18
Limited Warranty (Only for U.S.A.).....	19

General Information

Cookware Guide	6
Specifications.....	20
Trim Kit Information	20
User's Record.....	20

Información de Seguridad

INSTRUCCIONES IMPORTANTES DE SEGURIDAD	21-23
Instrucciones de Instalación y Para La Conexión a Tierra	23-24
Preparación de Alimentos.....	24-25

Información General

Guía de Utensilios de Cocina.....	26
-----------------------------------	----



IMPORTANT SAFETY INSTRUCTIONS

Your safety and the safety of others are very important.



We have provided important safety messages in this manual and on your appliance. Always read and obey all safety messages.

This is the safety alert symbol. It is used to alert you to potential hazards that can kill or hurt you and others.

All safety messages will follow the safety alert symbol and either the word "DANGER", "WARNING" or "CAUTION". These words mean:

DANGER

You can be killed or seriously injured if you don't immediately follow instructions.

WARNING

You can be killed or seriously injured if you don't follow instructions.

CAUTION

You can be exposed to a potentially hazardous situation which, if not avoided, may result in minor or moderate injury.

All safety messages will tell you what the potential hazard is, tell you how to reduce the chance of injury, and tell you what can happen if the instructions are not followed.



PRECAUTIONS TO AVOID POSSIBLE EXPOSURE TO EXCESSIVE MICROWAVE ENERGY

- (a) **DO NOT** attempt to operate this oven with the door open, since open-door operation can result in harmful exposure to microwave energy. It is important not to defeat or tamper with the safety interlocks.
- (b) **DO NOT** place any object between the oven front face and the door, or allow soil or cleaner residue to accumulate on sealing surfaces.
- (c) **DO NOT** operate the oven if it is damaged. It is particularly

important that the oven door close properly and that there is no damage to the:

- (1) door (bent),
- (2) hinges and latches (broken or loosened),
- (3) door seals and sealing surfaces.
- (d) The oven should not be adjusted or repaired by anyone except properly qualified service personnel.

Thank you for purchasing a Panasonic Microwave Oven

Your microwave oven is a cooking appliance and you should use as much care as you use with a stove or any other cooking appliance. When using this electric appliance, basic safety precautions should be followed, including the following:

WARNING

To reduce the risk of burns, electric shock, fire, injury to persons, or exposure to excessive microwave energy:

1. Read all instructions before using this appliance.
2. Read and follow the specific "**PRECAUTIONS TO AVOID POSSIBLE EXPOSURE TO EXCESSIVE MICROWAVE ENERGY**," above.
3. This appliance must be grounded. Connect only to a properly grounded outlet. See "**GROUNDING INSTRUCTIONS**" found on page 3.
4. As with any cooking appliance, **DO NOT** leave oven unattended while in use.
5. Install or locate this appliance only in accordance with the installation instructions found on page 3.
6. **DO NOT** cover or block any openings on this appliance.
7. **DO NOT** store this appliance outdoors. **DO NOT** use this product near water (for example, near a kitchen sink, in a wet basement, or near a swimming pool or similar locations).
8. Use this appliance only for its intended use as described in this manual. **DO NOT** use corrosive chemicals, vapors or non-food products in this appliance. This type of oven is specifically designed to heat or cook food. It is not designed for industrial or laboratory use. The use of corrosive chemicals in heating or cleaning will damage the appliance and may result in radiation leaks.
9. When cleaning surfaces of the door and oven that come together on closing the door, use only mild, non-abrasive soaps or detergents applied with a sponge or soft cloth.



IMPORTANT SAFETY INSTRUCTIONS (continued)

10. **DO NOT** allow children to use this appliance, unless closely supervised by an adult. **DO NOT** assume that because a child has mastered one cooking skill he/she can cook everything.
11. **HOT CONTENTS CAN CAUSE SEVERE BURNS. DO NOT ALLOW CHILDREN TO USE THE MICROWAVE.** Use caution when removing hot items.
12. **DO NOT** operate this appliance if it has a damaged cord or plug, if it is not working properly, or if it has been damaged or dropped.
13. **DO NOT** immerse cord or plug in water.
14. Keep cord away from heated surfaces.
15. **DO NOT** let cord hang over edge of a table or counter.
16. This appliance should be serviced only by qualified service personnel. Contact the nearest authorized service center for examination, repair or adjustment.
17. Some products such as whole eggs, with or without shell, narrow neck bottles and sealed containers (for example, closed glass jars) may explode and should not be heated in this oven.
18. To reduce the risk of fire in the oven cavity:
 - (a) **DO NOT** overcook food. Carefully attend appliance when paper, plastic, or other combustible materials are placed inside the oven to facilitate cooking.
 - (b) Remove wire twist-ties from paper or plastic bags before placing bag in oven.
 - (c) **If material inside the oven ignites, keep oven door closed, turn oven off, and disconnect the power cord, or shut off power at the fuse or circuit breaker panel.**
 - (d) **DO NOT** use the cavity for storage purposes. **DO NOT** leave **paper products, cooking utensils or food in the cavity when not in use.**
19. **Superheated Liquids:** Liquids, such as water, coffee or tea are able to be overheated beyond the boiling point without showing evidence (or signs) of boiling. Visible bubbling is not always present when the container is removed from the microwave oven. **THIS COULD RESULT IN VERY HOT LIQUIDS SUDDENLY BOILING OVER WHEN THE CONTAINER IS DISTURBED OR A UTENSIL IS INSERTED INTO THE LIQUID.** To reduce the risk of injury to persons:
 - (a) **STIR THE LIQUID BOTH BEFORE AND HALFWAY THROUGH HEATING.**
 - (b) **DO NOT heat water and oil, or fats together. The film of oil will trap steam, and may cause a violent eruption.**
 - (c) **DO NOT** use straight-sided containers with narrow necks.
 - (d) After heating, allow the container to stand in the microwave oven for a short time before removing the container.
20. **DO NOT** cook directly on the turntable. It can crack, and cause injury or damage to the oven.
21. For the oven designed for installation into a wall cabinet:
 - (a) **DO NOT** operate any heating or cooking appliance beneath this appliance.
 - (b) **DO NOT** mount unit over or near any portion of a heating or cooking appliance.
 - (c) **DO NOT** mount over a sink.
 - (d) **DO NOT** store anything directly on the top of the appliance surface when the appliance is in operation.

SAVE THESE INSTRUCTIONS

WARNING

TO AVOID THE RISK OF SHOCK:

DO NOT remove outer panel from oven. Repairs must be done only by a qualified service person.



TO REDUCE THE RISK OF EXPOSURE TO MICROWAVE ENERGY:

DO NOT tamper with, or make any adjustments or repairs to Door, Control Panel Frame, Safety Interlock Switches, or any other part of the oven. Microwave leakage may result.

Safety Precautions

TO AVOID THE RISK OF ARCING DAMAGE OR FIRE:

1. **DO NOT** operate the microwave oven empty, **cook small food portions unattended**, or use metal containers. When using the microwave oven without water or food, **or cook too small a serving**, microwave energy cannot be absorbed and will continuously reflect throughout the cavity. This will cause arcing and damage the oven cavity, door or other components.
2. **DO NOT** store flammable materials next to, on top of, or in the oven.

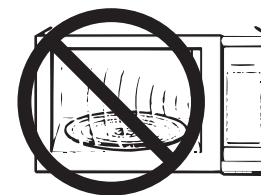



IMPORTANT SAFETY INSTRUCTIONS (continued)

- DO NOT** dry clothes, newspapers or other materials in the oven, or use newspaper or paper bags for cooking.
- DO NOT** hit or strike Control Panel. Damage to controls may occur.
- DO NOT** use recycled paper products unless the paper product is labeled as safe for microwave oven use. Recycled paper products may contain impurities, which may cause sparking.



TO AVOID THE RISK OF SCALDING:

POT HOLDERS should always be used when removing items from the oven. Heat is transferred from the HOT food to the cooking container and from the container to the Glass Tray. The Glass Tray can also be very HOT after removing the cooking container from the oven.



Glass Tray

- DO NOT** operate the oven without the Roller Ring and the Glass Tray in place.

For proper use of your oven, read remaining safety cautions and operating instructions.

- DO NOT** operate the oven without the Glass Tray fully engaged on the drive hub. Improper cooking or damage to the oven could result. Verify that the Glass Tray is properly engaged and rotating by observing its rotation when you press **Start**.
Note: The Glass Tray can turn in either direction.
- Use only the Glass Tray specifically designed for this oven.
DO NOT substitute any other glass tray.
- If the Glass Tray is hot, allow to cool before cleaning or placing in water.
- DO NOT** cook directly on the Glass Tray. Always place food in a microwave safe dish, or on a rack set in a microwave safe dish.
- If food or utensil on the Glass Tray touches oven walls, causing the tray to stop moving, the tray will automatically rotate in the opposite direction.

Roller Ring

- The Roller Ring and oven floor should be cleaned frequently to prevent excessive noise.
- Always replace the Roller Ring and the Glass Tray in their proper positions.
- The Roller Ring must always be used for cooking along with the Glass Tray.



Installation and Grounding Instructions

Examine Your Oven

Unpack oven, remove all packing material and examine the oven for any damage such as dents, broken door latches or cracks in the door. Notify dealer immediately if oven is damaged. **DO NOT** install if oven is damaged.

Placement of Oven

- The oven must be placed on a flat, stable surface. Place the front surface of the door 3 inches (7.6 cm) or more from the counter top edge to avoid accidental tipping of the microwave oven during normal use. For proper operation, the oven must have sufficient airflow. Allow 3 inches (7.6 cm) of space on both sides of the oven and 1 inch (2.5 cm) of space on top of the oven.
 - DO NOT** block air vents. If they are blocked during operation, the oven may overheat and be damaged.
 - DO NOT** place oven near a hot, damp surface such as a gas or electric range, sink, or dishwasher.
 - DO NOT** operate oven when room humidity is excessive.
- This oven is manufactured for household use only. It is not approved or tested for mobile vehicle, marine, or commercial use.

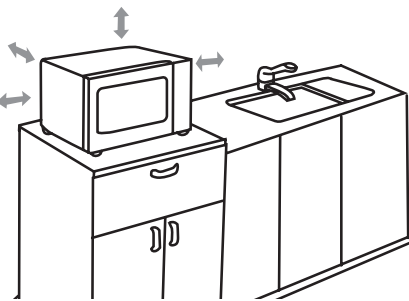

Installation

- DO NOT** block air vents. If they are blocked during operation, the oven may overheat. If the oven overheats, a thermal safety device will turn the oven off. The oven will remain inoperable until it has cooled.
- The oven is designed for installation into a wall cabinet by using the proper trim kit available from a local Panasonic dealer, follow all instructions packed with the kit.

WARNING: IMPROPER USE OF THE GROUNDING PLUG CAN RESULT IN A RISK OF ELECTRIC SHOCK.

Consult a qualified electrician or service person if the grounding instructions are not completely understood, or if doubt exists as to whether the appliance is properly grounded. If it is necessary to use an extension cord, use only a three-wire extension cord that has a three-prong polarized grounding plug, and a three-slot receptacle that will accept the plug of the appliance. The marked rating of the extension cord should be equal to or greater than the electrical rating of the appliance.

Grounding Instructions

THIS APPLIANCE MUST BE GROUNDED.

In the event of an electrical short circuit, grounding reduces the risk of electric shock by providing an escape wire for the electric current. This appliance is equipped with a cord having a grounding wire with a grounding plug.

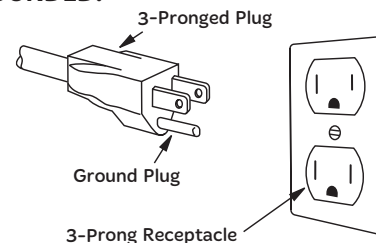



Installation and Grounding Instructions (continued)

The plug must be plugged into an outlet that is properly installed and grounded.

- **Plug into properly installed and grounded three-prong outlet.**
- **DO NOT** remove ground prong.
- **DO NOT** use an adapter.

Power Supply

1. A short power-supply cord is provided to reduce the risks resulting from becoming entangled in or tripping over a longer cord.
2. Longer cord sets or extension cords are available and may be used if care is exercised in their use. **DO NOT** let cord hang over edge of a table or counter.
3. If a long cord or extension cord is used,
 - (1) the marked electrical rating of the cord set or extension cord should be at least as great as the electrical rating of the appliance,
 - (2) the extension cord must be a grounding-type three-wire cord, and
 - (3) the longer cord should be arranged so that it will not drape over the countertop or tabletop where it can be pulled on by children or tripped over accidentally.

Wiring Requirements

The oven must be operated on a SEPARATE CIRCUIT. No other appliance should share the circuit with the microwave oven. If it does, the branch circuit fuse may blow or the circuit breaker

may trip. The oven must be plugged into at least a 20 A, 120 V, 60 Hz GROUNDED OUTLET. Where a standard two-prong outlet is encountered, it is the personal responsibility and obligation of the consumer to have it replaced with a properly grounded three-prong outlet. The VOLTAGE used must be the same as specified on this microwave oven (120 V, 60 Hz). Using a higher voltage is dangerous and may result in a fire or oven damage. Using a lower voltage will cause slow cooking. Panasonic is NOT responsible for any damages resulting from the use of the oven with any voltage other than specified.

TV / RADIO / WIRELESS EQUIPMENT INTERFERENCE

This product has been tested and found to comply with the limits for Microwave Oven, pursuant to Part 18 of the FCC Rules. This product can radiate radio frequency energy, which could cause interference to such products as radio, TV, baby monitor, cordless phone, Bluetooth, wireless router, etc., which can be confirmed by turning this product off and on. If present, the user is encouraged to try to correct by taking one or more of the following countermeasures:

- (1) Increase the spacing distance between the microwave oven and other product receiving the interference.
- (2) If possible, use a properly installed receiver antenna and/or reorient the receiving antenna of the other product receiving the interference.
- (3) Plug the microwave oven into a different outlet from the other product receiving the interference.
- (4) Clean door and sealing surfaces of the oven. (See Care and Cleaning of Your Microwave Oven)

If you have questions or concerns about any issue relating to your personal information, please contact the Panasonic Corporation of North America Office of Ethics and Compliance at privacy@us.panasonic.com.

Food Preparation

Follow these Safety Precautions when cooking in your oven.

IMPORTANT

Proper cooking depends upon the power, the time setting and quantity of food. If you use a smaller portion than recommended but cook at the time for the recommended portion, fire could result.

1) HOME CANNING / STERILIZING / DRYING FOODS / SMALL QUANTITIES OF FOODS

- **DO NOT** use your oven for home canning. Your oven cannot maintain the food at the proper canning temperature. The food may be contaminated and then spoil.
- **DO NOT** use the microwave oven to sterilize objects (baby bottles, etc.). It is difficult to keep the oven at the high temperature needed for sterilization.
- **DO NOT** dry meats, herbs, fruits or vegetables in your oven. Small quantities of food or foods with low moisture content can dry out, scorch or catch on fire if overheated.
- **DO NOT** prepare small food portions at high power. This can cause energy concentration at a fixed spot, which can lead to arcing and damage to your oven. Select a lower cook power setting when preparing small portions.

2) POPCORN

Popcorn may be popped in a microwave oven corn popper. Microwave popcorn that pops in its own package is also available. Follow popcorn manufacturers' directions and use a brand suitable for the cooking power of your microwave oven.

CAUTION: *When using pre-packaged microwave popcorn, you can follow recommended package instructions or use the Popcorn pad (refer to page 12). Otherwise, the popcorn may not pop adequately or may ignite and cause a fire. Never leave the oven unattended when popping popcorn. Allow the popcorn bag to cool before opening, and always open the bag facing away from your face and body to prevent steam burns.*



Food Preparation (continued)

3) DEEP FAT FRYING

- **DO NOT** deep fat fry in your microwave oven. Cooking oils may burst into flames and may cause damage to the oven and may result in burns. Microwave utensils may not withstand the temperature of the hot oil, and can shatter or melt.

4) FOODS WITH NONPOROUS SKINS

- **DO NOT COOK / REHEAT WHOLE EGGS, WITH OR WITHOUT THE SHELL.**

Steam buildup in whole eggs may cause them to explode, and possibly damage the oven or cause injury. Reheating SLICED hard-boiled eggs and cooking SCRAMBLED eggs is safe.



- **Potatoes, apples, whole squash and sausages** are examples of foods with nonporous skins. These types of foods must be pierced before microwave cooking to prevent them from exploding.

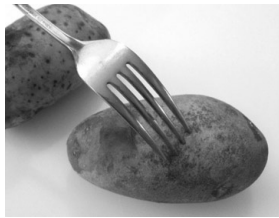

CAUTION: Cooking dry or old potatoes can cause fire.

5) GLASS TRAY / COOKING CONTAINERS / FOIL

- Cooking containers get hot during microwaving. Heat is transferred from the HOT food to the container and the Glass Tray. Use pot holders when removing containers from the oven or when removing lids or plastic wrap covers from cooking containers, to avoid burns.
- The Glass Tray will get hot during cooking. It should be allowed to cool before handling or before paper products, such as paper plates or microwave popcorn bags, are placed in the oven for microwave cooking.
- When using foil in the oven, allow at least 1-inch (2.5 cm) of space between foil and interior oven walls or door.
- Dishes with metallic trim should not be used, as arcing may occur.

6) PAPER TOWELS / CLOTHS

- **DO NOT** use paper towels or cloths that contain a synthetic fiber woven into them. The synthetic fiber may cause the towel to ignite. Use paper toweling under supervision.

7) BROWNING DISHES / OVEN COOKING BAGS

- Browning dishes or grills are designed for microwave cooking only. Always follow instructions provided by the manufacturer. **DO NOT** preheat browning dish more than six minutes.
- If an oven cooking bag is used for microwave cooking, prepare according to package directions. **DO NOT** use a wire twist-tie to close bag. Instead use plastic ties, cotton string or a strip cut from the open end of the bag.



8) THERMOMETERS

- **DO NOT** use a conventional meat thermometer in your oven. Arcing may occur. Microwave safe thermometers are available for both meat and candy.



9) BABY FORMULA / BABY FOOD

- **DO NOT** heat baby formula or baby food in the microwave oven. The glass jar or surface of the food may appear warm while the interior can be so hot as to burn the infant's mouth and esophagus.



10) REHEATING PASTRY PRODUCTS

- When reheating pastry products, check temperatures of any fillings before eating. Some foods have fillings, which heat faster and can be extremely hot, while the surface remains warm to the touch (for example, jelly donuts).

11) GENERAL OVEN USAGE GUIDELINES

- **DO NOT** use the oven for any purpose other than the preparation of food.

Cookware Guide

This section answers the question, "Can I use in the Microwave?"

Aluminum Foil

It is not recommended to use. Arcing can occur if foil is too close to oven wall or door and cause damage to your oven.



Browning Dish

Yes. Only use browning dishes that are designed for microwave cooking. Check browning dish information for instructions/heating chart. Do not preheat for more than six minutes.

Brown Paper Bags

No. They may cause a fire in the oven.



Microwave Safe

Yes. If labeled Microwave Safe, check manufacturers' directions for use in microwave heating. Some dinnerware may state on the back of the dish, "Oven-Microwave Safe".



Dinnerware

If unlabeled, use CONTAINER TEST below.

Disposable Polyester Paperboard Dishes

Yes. Some frozen foods are packaged in these dishes. Also can be purchased in some grocery stores.



Fast Food Cartons with Metal Handle

No. Metal handle may cause arcing.



Frozen Dinner Trays

If made for the microwave, then yes. If it contains metal, then no.



Glass Jars

No. Most glass jars are not heat resistant.



Heat Resistant Oven Glassware/Ceramic

Yes, but only ones for microwave cooking and browning. (See CONTAINER TEST below.)



Metal Bakeware

No. Metal can cause arcing and damage to your oven.



Metal Twist-Ties

No. May cause arcing which could cause a fire in the oven.



Oven Cooking Bag

Yes. Follow manufacturers' directions. Close bag with the nylon tie provided, a strip cut from the end of the bag, or a piece of cotton string. Do not close with metal twist-tie. Make six 1/2-inch slits near the closure.

Paper Plates/Cups

Yes. Use to warm cooked foods, and to cook foods that require short cooking time, such as hot dogs. **Do not microwave paper cups; they may overheat and ignite.**



Towels & Napkins

Yes, only paper napkins/towels. Use to warm rolls and sandwiches, only if labeled safe for microwave use. Do NOT use recycled paper towels.



Parchment Paper

Yes. Use as a cover to prevent splattering.

Plastic Cookware

Yes, with caution. Should be labeled, "Suitable for Microwave Heating."



Check Microwave Safe manufacturers' directions for recommended uses. Some microwave safe plastic containers are not suitable for cooking foods with high fat or sugar content. The heat from hot food may cause warping.

Plastic, Melamine

No. This material absorbs microwave energy. Dishes get HOT!

Plastic Foam Cups

Yes, with caution. Plastic foam will melt if foods reach a high temperature. Use short term only to reheat foods to a low serving temperature. **Do not microwave paper cups; they may overheat and ignite.**



Plastic Wrap

Yes. Use to cover food during cooking to retain moisture and prevent splattering. Should be labeled "Suitable for Microwave Heating". Check package directions.



Straw, Wicker, Wood

Yes, short term only. Use only for short term reheating and to bring food to a low serving temperature. Wood may dry out, split or crack.



Thermometers

Only microwave safe thermometers can be used, NOT conventional thermometers.



Wax Paper

Yes. Use as a cover to prevent splattering and to retain moisture.



CONTAINER TEST

TO TEST A CONTAINER FOR SAFE MICROWAVE OVEN USE: Fill a microwave safe cup with cool water and place it in the microwave oven along side the empty container to be tested; **heat one (1) minute at P10 (HIGH)**. If the container is microwave oven safe (transparent to microwave energy), the empty container should remain comfortably cool and the water should be hot. If the container is hot, it has absorbed some microwave energy and should NOT be used. This test cannot be used for plastic containers.



Location of Controls

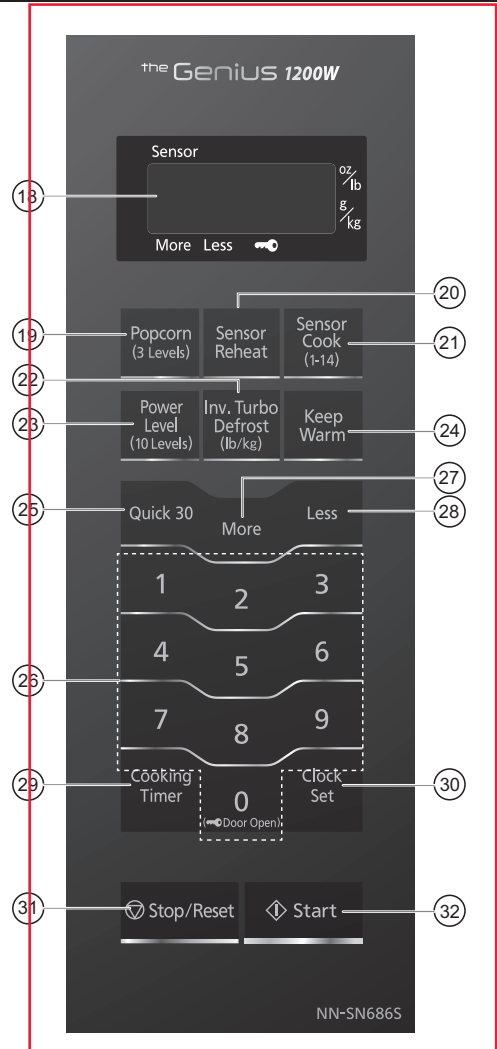
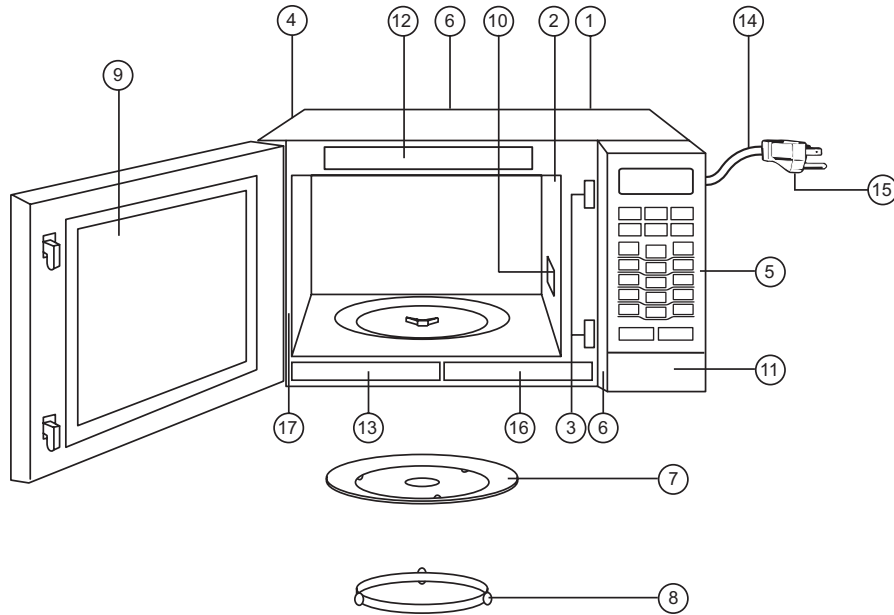

* The control panels of NN-SN686S/NN-SN67HS/NN-SN65HS have same key layout and function, even the different key name.

- | | |
|---|---|
| 1 External Air Vent | 21 Sensor Cook Pad (See page 14) |
| 2 Internal Air Vent | 22 Inverter Turbo Defrost Pad (See page 13) |
| 3 Door Safety Lock System | 23 Power level Pad (See page 10) |
| 4 Exhaust Air Vent | 24 Keep Warm Pad (See page 12) |
| 5 Control Panel | 25 Quick 30 Pad (See page 12) |
| 6 Identification Plate | 26 Number Pads |
| 7 Glass Tray | "0" pad: also acts as door open pad (See page 9) |
| 8 Roller Ring | 27 More Pad (See page 12, 14) |
| 9 Heat/Vapor Barrier Film (do not remove) | 28 Less Pad (See page 12, 14) |
| 10 Waveguide Cover (do not remove) | 29 Cooking Timer Pad (See page 9, 10, 11) |
| 11 Door Release Button | 30 Clock Set Pad (See page 8) |
| 12 Warning label | 31 Stop/Reset Pad |
| 13 Menu label | Before cooking: One tap clears all your instructions. During cooking: one tap temporarily stops the cooking process. Another tap cancels all your instructions, and time of day or colon appears in the display window. |
| 14 Power Supply Cord | 32 Start Pad |
| 15 Power Supply Plug | After cooking program setting, one tap allows oven to begin |
| 16 Warning label | |
| 17 Door hinges | |
| To prevent injury when opening or closing the door, keep fingers away from the door hinges. | |
| 18 Display Window | |
| 19 Popcorn Pad (See page 12) | |
| 20 Sensor Reheat Pad (See page 14) | |

functioning. If door is opened or **Stop/Reset** Pad is pressed once during oven operation, **Start** Pad must be pressed again to restart oven.

Beep Sound:

When a pad is pressed correctly, a beep will be heard. If a pad is pressed and no beep is heard, the unit did not or cannot accept the instruction. When operating, the oven will beep twice between programmed stages. At the end of any complete program, the oven will beep 5 times.

NOTE:

If no operation after cooking program setting, 6 minutes later, the oven will automatically cancel the cooking program. The display will return to clock or colon display.

NOTE:

The illustration is for reference only.

Operation

Using the Microwave for the First Time

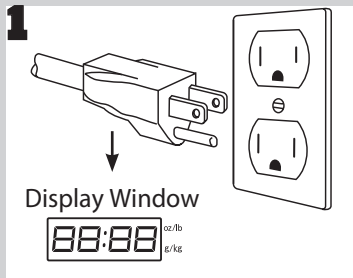

Plug into a properly grounded electrical outlet. The oven automatically defaults to the imperial measure system (oz/lb).

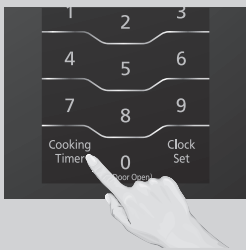
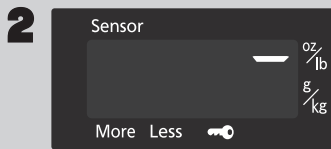

Press **Start** once, then Press **Cooking Timer** to cycle between the weight system, Metric (g/kg) or Imperial (oz/lb).

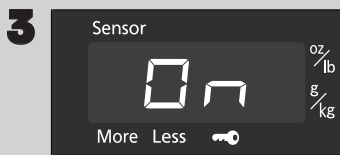

Press **Start** once, then Press **Cooking Timer** to cycle between the Beep on or Beep off.

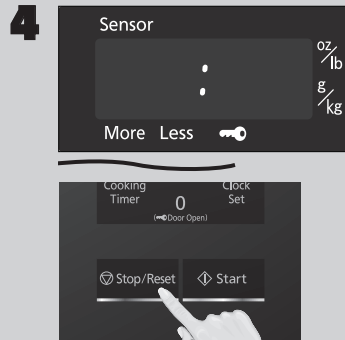

Press **Stop/Reset** to confirm; a colon (:) will appear in the display window.

NOTES:

These choices can be selected only when you plug-in the oven.

Setting the Clock

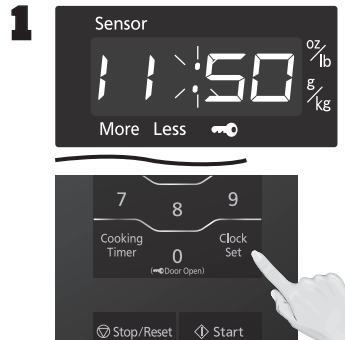

With the oven NOT cooking, press **Clock Set** once; the colon (:) will blink. Enter time of day using the **Number** pads.

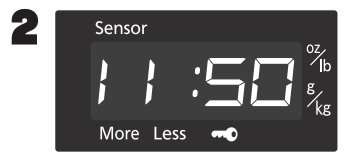

Press **Clock Set** to finish setting and the colon (:) will stop blinking.

NOTES:

1. To reset the clock, repeat steps.
2. The clock will retain the time of day as long as the oven is plugged in and electricity is supplied.
3. The clock is a 12-hour display.
4. Oven will not operate while colon (:) is flashing.

Setting the Child Safety Lock

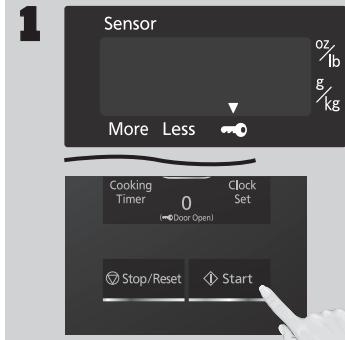

When the time of day appears in the display, press **Start** three times; "▼" will appear in the display.

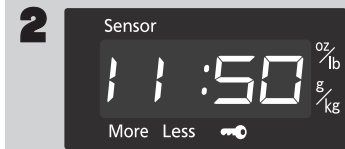

Press **Stop/Reset** three times; the display will return to the time of the day and Child Lock will be cancelled.

NOTES:

1. This feature prevents the electronic operation of the oven until cancelled. It does not lock the door.
2. To set or cancel child safety lock, **Start** or **Stop/Reset** pad must be pressed 3 times within 10 seconds.
3. You can set Child Lock feature when the display shows a colon or time of day.

Operation (continued)

Setting the Child Safety Door Lock

Your microwave is equipped with an electronic child-safety function, to be more precise: the door lock function, which enables the oven door to be "locked" so that children or anyone unfamiliar with it cannot operate it accidentally. Distinguishing from that of child safety lock, the door lock does not lock access to the microwave function, it simply prevents burning by opening the door accidentally. Specifically, the electronic child-safety door lock is activated or deactivated through specific buttons on the control panel.

When plugged in, the door lock is automatically activated as soon as cooking starts. The window flashes "▼" to indicate that the oven is locked. Follow below sequences to unlock the door, which must be finished within 10 seconds. If there is not any operation within 30 minutes from the end of cooking, the door would be unlocked automatically.

• To unlock the oven during or after cooking:



Press the "0" pad once.

2 Press door release button, the oven door is now unlocked. Open the door and take out the food with special care.

Simply leave the door lock feature disengaged if you don't need it temporarily, or follow the instruction to reactivate, the function setting should be under the circumstance that the oven door is unlocked and function setting must be finished within 10 seconds.

• To deactivate:

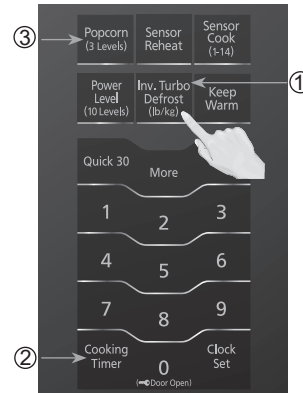

Press **Inverter Turbo Defrost - Cooking Timer - Popcorn** in sequence, a long beep will be heard, the door lock function is now invalid.

• To reactivate:

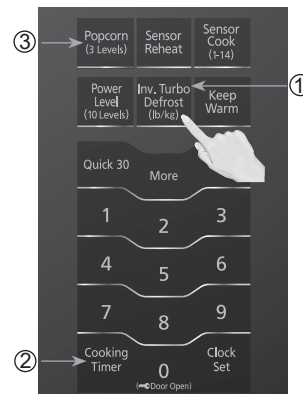

Press **Inverter Turbo Defrost - Cooking Timer - Popcorn** in sequence, the window will flash "▼", or replug the oven, both ways can reactivate the function.

Operation (continued)

Cooking

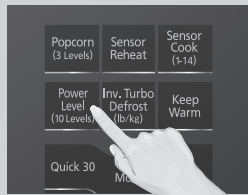
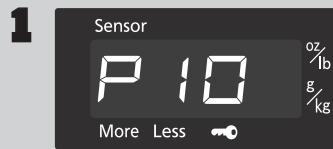

If cooking at high power (10), skip to step 2. Press **Power Level** until the desired power level appears in the display. P10 is the highest and P1 is the lowest.

Press	Power Level
once	P10 (HIGH)
twice	P9
3 times	P8
4 times	P7 (MED-HIGH)
5 times	P6 (MEDIUM)
6 times	P5
7 times	P4
8 times	P3 (MED-LOW)/ DEFROST
9 times	P2
10 times	P1 (LOW)

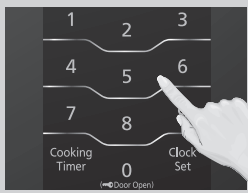
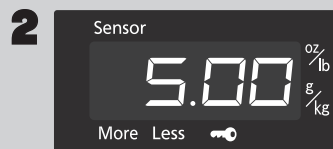

Set Cooking Time using the **Number** pads. P10 (HIGH) has max. cooking time of 30 minutes. For other power levels, the max. time is 99 minutes, 99 seconds.

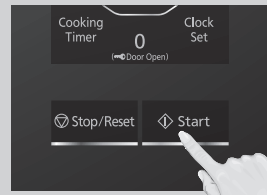
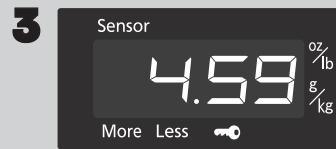

Press **Start**; the cooking will start and the time will count down in the display. At the end of cooking, five beeps will sound.

NOTES:

- For reheating, use P10 (HIGH) for liquids, P7 (MED-HIGH) for most foods, and P6 (MEDIUM) for dense foods.
- For defrosting, use P3 (MED-LOW) (MED-LOW).

DO NOT OVERCOOK: This oven requires less time to cook than older units. Overcooking will cause food to dry out and may cause a fire. A microwave oven's cooking power tells you the amount of microwave power available for cooking.

Stage Cooking:

For more than one stage of cooking, repeat steps 1 and 2 for each stage of cooking before pressing **Start**. The maximum number of stages for cooking is three. When operating, two beeps will sound between each stage. Five beeps will sound at the end of the entire sequence. Automatic function (such as sensor cook/reheat, popcorn and inverter turbo defrost) can not be used with 3 stage cooking.

Caution:

DO NOT defrost food at a high power setting. Doing so can cause energy concentration at a focused point, which can lead to arcing and damage to the oven. Use the "Defrost" function instead.

Setting the Timer

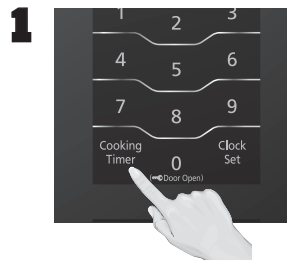

This feature allows you to program the oven as a kitchen timer. Press **Cooking Timer** once.

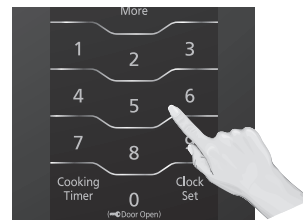
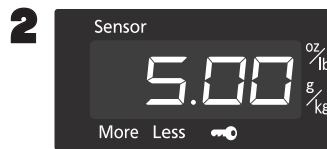

Set desired amount of time using **Number** pads (up to 99 minutes, 99 seconds).

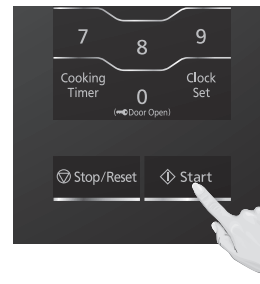
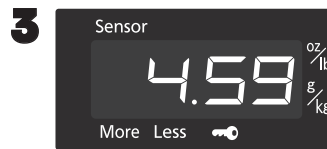

Press **Start**. The timer will count down without cooking and beep five times when done.

Caution: If oven lamp is lit while using the timer feature with door closed, the oven is **NOT** set properly; **STOP OVEN IMMEDIATELY** and re-read instructions.

Operation (continued)

Setting a Standing Time

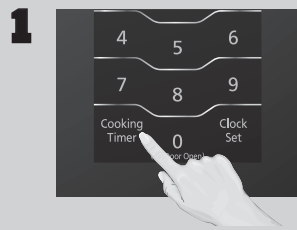

Some recipes call for a standing time after cooking. To do this, repeat steps 1 and 2 in the **Cooking** section on previous page. Then press **Cooking Timer**.

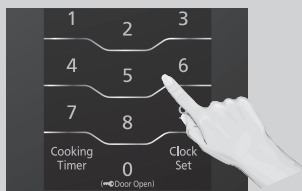
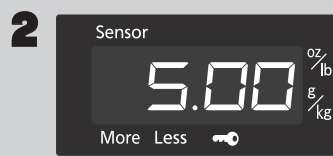

Set desired amount of stand time using **Number** pads (up to 99 minutes, 99 seconds).

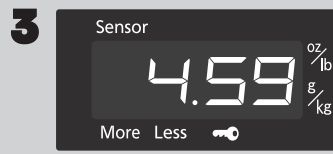

Press **Start**. The timer will start and then beep twice at the end of cooking time (the beginning of standing time). Five beeps will sound when standing time is done.

Setting a Delayed Start

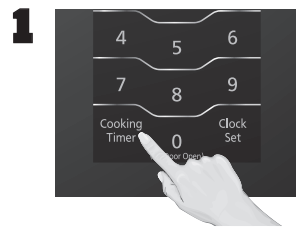

The start time can be delayed to start cooking at a later time. To do this, first press **Cooking Timer**.

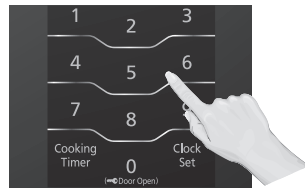
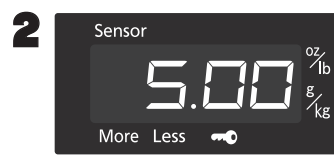

Enter the desired delay time (up to 99 minutes, 99 seconds) using the **Number** pads.

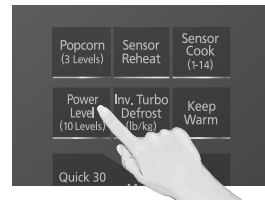
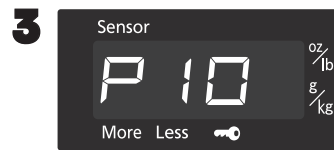

Press **Power Level** until the desired power level appears in the display. P10 is the highest and P1 is the lowest.

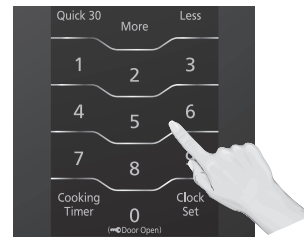
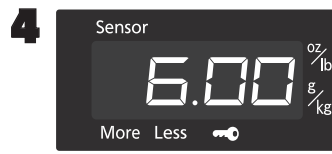

Set Cooking Time using the **Number** pads (see previous page for maximum times).

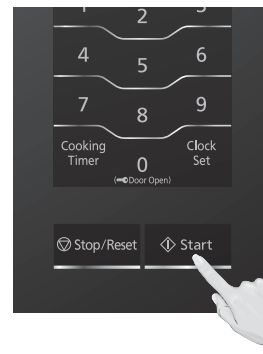
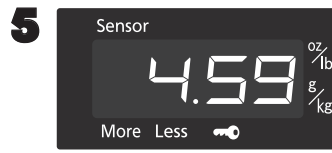

Press **Start**; the delay time will count down, then cooking will begin. At the end of cooking, five beeps will sound.

NOTES:

1. When each stage finishes, the oven will beep twice. At the end of the program, the oven will beep five times.
2. If the oven door is opened during Stand Time, Kitchen Timer or Delay Time, the time on the display will continue to count down.
3. Stand Time and Delay start cannot be programmed before any automatic function (such as sensor cook/reheat, popcorn and inverter turbo defrost). This is to prevent the starting temperature of food from rising.
4. When using Standing time or Delay Start, it's up to 2 power stages.

Operation (continued)

Quick 30

(Set or add cooking time in 30 seconds increments)

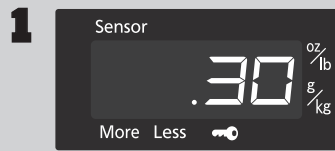

Press **Quick 30** until the desired cooking time (up to 5 minutes) appears in the display. Power Level is pre-set at P10.

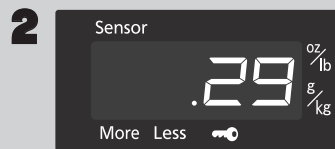

Press **Start**; the cooking will start and the time will count down in the display. At the end of cooking, five beeps will sound.

NOTES:

1. If desired, you can use other power levels. Select desired power level before pressing **Quick 30**.
2. After setting the time by **Quick 30** pad, you cannot use the **Number Pads**.
3. **Quick 30** pad can also be used to add more time during manual cooking.

Keep Warm

(Will keep food warm for up to 30 minutes after cooking)

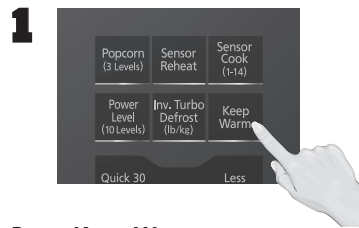

Press **Keep Warm**.

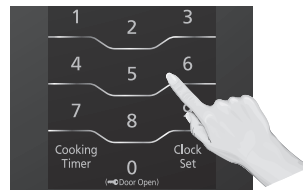
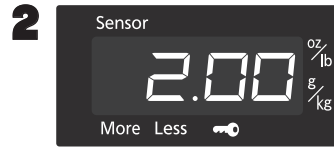

Set warming time using **Number pads**, up to 30 minutes. This example shows two minutes.

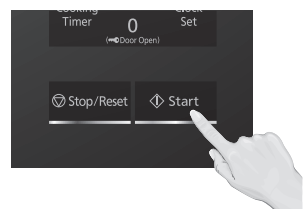
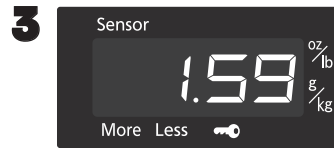

Press **Start**; the cooking will start and the time will count down in the display. At the end of cooking, five beeps will sound.

NOTES:

Keep Warm can be set as the final stage after cook time has been manually entered. It cannot be used with sensor or auto features.

Popcorn

(Example: To pop 3.5 oz (99 g.) of popcorn)

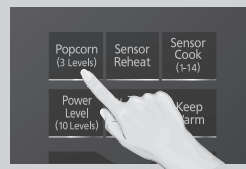
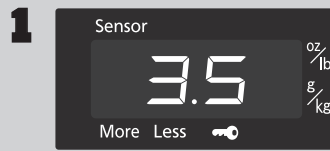

Press **Popcorn** until the desired size appears in the display. Once for 3.5 oz (99 g), twice for 3.0 oz (85 g), or three times for 1.75 oz (50 g).

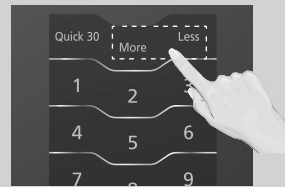
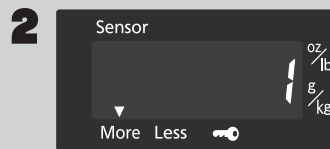

If desired, press **More** once to add 10 seconds or twice to add 20 seconds. Press **Less** once to subtract 10 seconds or twice to subtract 20 seconds.

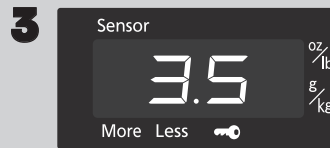

Press **Start**; After several seconds, cooking time appears in the display window and begins to count down.

NOTES:

1. Pop one bag at a time.
2. Place bag in oven according to manufacturers' directions.
3. Start with popcorn at room temperature.
4. Allow popped corn to sit unopened for a few minutes.
5. Open bag carefully to prevent burns, because steam will escape.
6. Do not reheat unpopped kernels or reuse bag.
7. If popcorn is of a different weight than listed, follow instructions on popcorn package.
8. **Never leave the oven unattended.**
9. **If popping slows to 2 to 3 seconds between pops, stop oven. Overcooking can burn popcorn or cause fire.**
10. When popping multiple bags one right after the other, the cooking time may vary slightly. This does not affect the popcorn results.

Operation (continued)

Inverter Turbo Defrost

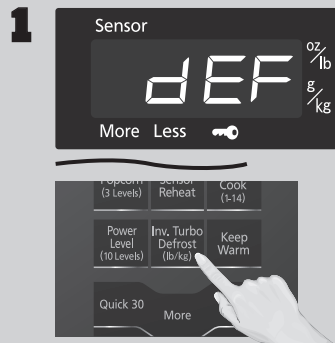

This feature allows you to defrost foods such as meat, poultry and seafood, simply by entering the weight. Press **Inverter Turbo Defrost**.



"DEF" will appear briefly in the display, then a dash will appear next to the weight units. Enter weight of the food using the **Number** pads.



Press **Start**. Defrosting will start. Larger weight foods will cause a signal midway through defrosting. If two beeps sound, turn over and/or rearrange foods.

NOTE:

The maximum weight for Inverter Turbo Defrost is 6 lbs. (3 kg).

Conversion

Follow the chart to convert ounces or hundredths of a pound into tenths of a pound. To use Inverter Turbo Defrost, enter the weight of the food in pounds (1.0) and tenths of a pound (0.1). If a piece of meat weighs 1.95 lbs or 1 lb 14 oz, enter 1.9 lbs.

Ounces	Hundredths of a Pound	Tenths of a Pound
0	.01 - .05	0.0
1 - 2	.06 - .15	0.1
3 - 4	.16 - .25	0.2
5	.26 - .35	0.3
6 - 7	.36 - .45	0.4
8	.46 - .55	0.5
9 - 10	.56 - .65	0.6
11 - 12	.66 - .75	0.7
13	.76 - .85	0.8
14 - 15	.86 - .95	0.9

Defrosting Tips & Techniques

Preparation For Freezing:

1. Freeze meats, poultry, and fish in packages with only one or two layers of food. Place wax paper between layers.
2. Package in heavy-duty plastic wraps, bags (labeled "For Freezer"), or freezer paper.
3. Remove as much air as possible.
4. Seal securely, date, and label.

To Defrost:

1. Remove wrapper. This helps moisture to evaporate. Juices from food can get hot and cook the food.
2. Set food in microwave safe dish.
3. Place roasts fat-side down. Place whole poultry breast-side down.
4. Select power and minimum time so that items will be under-defrosted.

5. Drain liquids during defrosting.
6. Turn over (invert) items during defrosting.

After Defrosting:

1. Large items may be icy in the center. Defrosting will complete during Standing Time.
2. Let stand, covered, following stand time directions on page 11.
3. Rinse foods indicated in the chart.
4. Items which have been layered should be rinsed separately or have a longer stand time.

FOOD	DEFROST TIME at P3 mins (per lb)	DURING DEFROSTING	AFTER DEFROSTING		
			Stand Time	Rinse	
Fish and Seafood					
Crabmeat [up to 3 lbs. (1.4 kg)]	6	Break apart/Rearrange	5 min.	YES	
Fish Steaks	4 to 6	Turn over			
Fish Fillets	4 to 6	Turn over/Rearrange			
Sea Scallops	4 to 6	Break apart/ Remove defrosted pieces			
Whole fish	4 to 6	Turn over			
Meat					
Ground Meat	4 to 5	Turn over/ Remove defrosted portion	10 min.	NO	
Roasts [2½-4 lbs. (1.1-1.8 kg)]	4 to 8	Turn over	30 min. in fridge.		
Chops/Steak	6 to 8	Turn over/Rearrange	5 min.		
Ribs/T-bone	6 to 8	Turn over/Rearrange			
Stew Meat	4 to 8	Break apart/ Remove defrosted pieces			
Liver (thinly sliced)	4 to 6	Drain liquid/Turn over/ Separate pieces			
Bacon (sliced)	4	Turn over			---
Poultry					
Chicken, Whole [up to 3 lbs. (1.4 kg)]	4 to 6	Turn over	20 min. in fridge		YES
Cutlets	4 to 6	Break apart/Turn over/ Remove defrosted Pieces	5 min.		
Pieces	4 to 6	Break apart/Turn over	10 min.		
Cornish hens	6 to 8	Turn over			
Turkey Breast [5-6 lbs. (2.3-2.7 kg)]	6	Turn over	20 min. in fridge		

Operation (continued)

Sensor Reheat

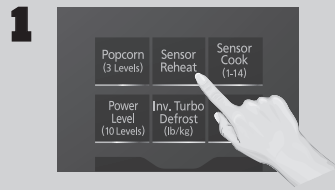

Press **Sensor Reheat**.

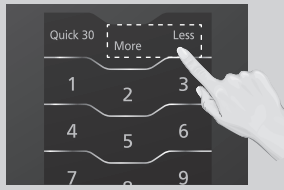
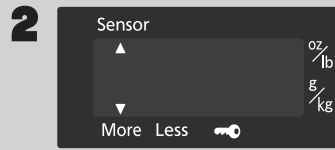

If desired, press **More** to add 20% more time than suggested. Press **Less** to subtract 20% cooking time.

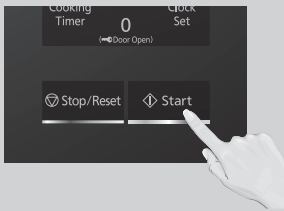
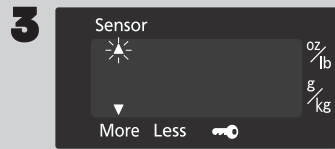

Press **Start**. Reheating is complete when five beeps sound.

NOTES:

1. After having used the Sensor Reheat feature a few times, you may decide you would prefer your food cooked to a different doneness – that is why you would utilize the **More/Less** pads.
2. When steam is detected by the Genius Sensor and two beeps sound, the remaining cooking time will appear in the display.

Casseroles: Add three to four tablespoons of liquid, cover with lid or vented plastic wrap. Stir when time appears in the display window.

Canned foods: Empty contents into casserole dish or serving bowl, cover dish with lid or vented plastic wrap. After reheating, let stand for a few minutes.

Plate of food: Arrange food on plate; top with butter, gravy, etc. Cover with lid or vented plastic wrap. After reheating, let stand for a few minutes.

DO NOT USE SENSOR REHEAT:

1. To reheat bread and pastry products. Use manual power and time for these foods.
2. For raw or uncooked foods.
3. If oven cavity is warm.
4. For beverages.
5. For frozen foods.

Sensor Cook

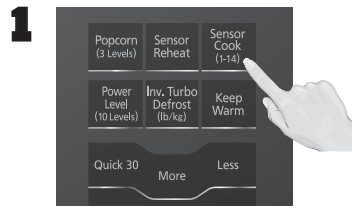

Press **Sensor Cook** until the number corresponding to the desired food appears in the display (*see chart on the next page*).

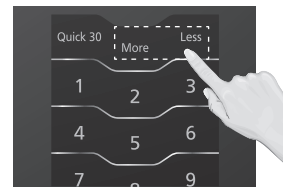
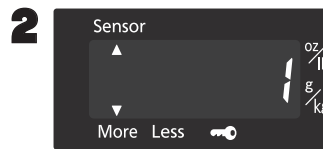

If desired, press **More** to add 20% more time than suggested. Press **Less** to subtract 20% cooking time.

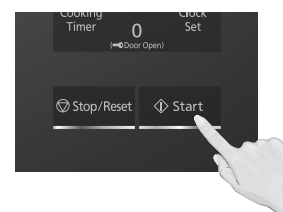
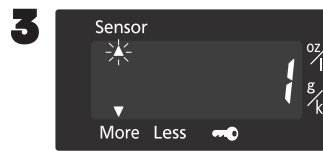

Press **Start**. Cooking is complete when five beeps sound.

NOTES:

1. After having used the Sensor Cook feature a few times, you may decide you would prefer your food cooked to a different doneness – that is why you would utilize the **More/Less** pads.

2. When steam is detected by the Genius Sensor and two beeps sound, the remaining cooking time will appear in the display.
3. Automatic features are provided for your convenience. If results are not suitable to your individual preference, or if serving size is other than what is listed on page 15, please refer to manual cooking on page 10.

For the best results with the GENIUS SENSOR, follow these recommendations:

BEFORE Reheating/Cooking:

1. The room temperature surrounding the oven should be below 95° F (35° C).
2. Food weight should exceed 4 oz. (110 g).
3. Be sure the glass tray, the outside of the cooking containers and the inside of the microwave oven are dry before placing food in the oven. Residual beads of moisture turning into steam can mislead the sensor.
4. Cover food with lid, or with vented plastic wrap. Never use tightly sealed plastic containers—they can prevent steam from escaping and cause food to overcook.

DURING Reheating/Cooking:

DO NOT open the oven door until two beeps sound and cooking time appears in the display. Doing so will cause inaccurate cooking since the steam from food is no longer contained within the oven cavity. Once the cooking time begins to count down, the oven door may be opened to stir, turn or rearrange foods.

AFTER Reheating/Cooking:

All foods should have a standing time.

Operation (continued)

Sensor Cook Chart

See the chart below for Sensor Cook categories.

Recipe	Serving/Weight	Hints
1. Oatmeal	½ - 1 cup (40 - 80 g)	Place oatmeal in a microwave safe serving bowl with no cover. Follow manufacturers' directions for preparation.
2. Breakfast Sausage	2 - 8 links	Follow manufacturers' directions for preparation of pre-cooked breakfast sausage. Place in a radial pattern.
3. Omelet	2 - 4 eggs	Follow basic Omelet recipe on this page.
4. Quinoa	¼ - 1 cups (45 - 180 g)	Place quinoa in a microwave safe 3 qt casserole dish. Add 2 parts water to 1 part quinoa. Cover with lid or vented plastic wrap. After 2 beeps, stir. Let stand 14 minutes before serving.
5. Soup	1 - 2 cups (250 - 500 ml)	Pour soup into a microwave safe serving bowl. Cover with lid or vented plastic wrap. Stir after cooking.
6. Frozen Entrées	8 - 28 oz. (220 - 800 g)	Follow manufacturers' directions for preparation. After 2 beeps, stir or rearrange. Be careful when removing the film cover after cooking. Remove facing away from you to avoid steam burns. If additional time is needed, continue to cook manually.
7. Frozen Pizza (single)	8 oz. (220 g)	Follow manufacturers' directions for preparation. Add more time of cooking if needed.
8. Potatoes	1 - 4 potatoes (6 - 8 oz. each) (170 - 220 g)	Pierce each potato with a fork 6 times spacing around surface. Place potato or potatoes around the edge of paper-towel-lined glass tray (Turntable), at least 1 inch (2.5 cm) apart. Do not cover. Turn over after 2 beeps. Let stand 5 minutes to complete cooking.
9. Fresh Vegetables	4 - 16 oz. (110 - 450 g)	All pieces should be the same size. Wash thoroughly, add 1 tbsp. of water per ½ cup of vegetables, and cover with lid or vented plastic wrap. Do not salt/butter until after cooking.
10. Frozen Vegetables	6 - 16 oz. (170 - 450 g)	Wash thoroughly, add 1 tbsp. of water per ½ cup of vegetables, and cover with lid or vented plastic wrap. Do not salt/butter until after cooking. (Not suitable for vegetables in butter or sauce.)
11. Rice	½ - 1½ cups (110 - 335 g)	Place rice with hot tap water in a microwave safe casserole dish. Cover with lid or vented plastic wrap. Let stand 5 to 10 minutes before serving.
12. Frozen Dinners	11 - 16 oz. (300 - 450 g)	Follow manufacturers' directions for covering or removing covers. Do not use frozen foods packaged in foil trays. After 2 beeps, stir or rearrange.
13. Pasta	2 - 8 oz. (55 - 220 g)	Place 2 oz. pasta with 3 cups hot tap water in a microwave safe 2 qt casserole, salt and oil, if desired, covered with lid or vented plastic wrap. For 4 oz. pasta use 4 cups water, for 6 oz. pasta use 6 cups water in 3 qt casserole, for 8 oz. pasta use 7 cups water.
14. Fish Fillets	4 - 16 oz. (110 - 450 g)	Arrange in a single layer. Cover with lid or vented plastic wrap.

OMELET

Basic Omelet Recipe

1 Tablespoon butter or margarine

2 Eggs

2 Tablespoons milk

Salt and ground black pepper, if desired

Heat butter in a microwave safe 9-inch pie plate, 20 seconds at P10, or until melted.

Turn the plate to coat the bottom with butter. Meanwhile, combine the remaining ingredients in a separate bowl, beat together and pour into the pie plate. Cook, covered with vented plastic wrap, using OMELET selection. Let stand 2 minutes. With a spatula, loosen the edges of the omelet from the plate, fold into thirds to serve. **Always beat the eggs before making the omelet.**

Yield: 1 Serving

Approx. cooking time: 4 minutes.

NOTE: Double ingredients for a 4-egg Omelet.

Food Characteristics

Food Characteristics

Bone and Fat

Both bone and fat affect cooking. Bones may cause irregular cooking. Meat next to the tips of bones may overcook while meat positioned under a large bone, such as a ham bone, may be undercooked. Large amounts of fat absorb microwave energy and the meat next to these areas may overcook.



Density

Porous, airy foods such as breads, cakes or rolls take less time to cook than heavy, dense foods such as potatoes and roasts. When reheating donuts or other foods with different centers be very careful. Certain foods have centers made with sugar, water, or fat and these centers attract microwaves (for example, jelly donuts). When a jelly donut is heated, the jelly can become extremely hot while the exterior remains warm to the touch. This could result in a burn if the food is not allowed to cool properly in the center.

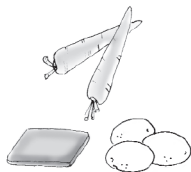

Quantity

Two potatoes take longer to cook than one potato. As the quantity of the food decreases so does the cooking time. Overcooking will cause the moisture content in the food to decrease and a fire could result. Never leave microwave unattended while in use.



Shape

Uniform sizes heat more evenly. The thin end of a drumstick will cook more quickly than the meaty end. To compensate for irregular shapes, place thin parts toward the center of the dish and thick pieces toward the edge.



Size

Thin pieces cook more quickly than thick pieces.



Starting Temperature

Foods that are at room temperature take less time to cook than if they are chilled, refrigerated or frozen.



Cooking Techniques

Piercing

Foods with skins or membranes must be pierced, scored or have a strip of skin peeled before cooking to allow steam to escape. Pierce clams, oysters, chicken livers, whole potatoes and whole vegetables. Whole apples or new potatoes should have a 1-inch strip of skin peeled before cooking. Score sausages and frankfurters. Do not Cook/Reheat whole eggs, with or without the shell. Steam buildup in whole eggs may cause them to explode, and possibly damage the oven or cause injury. Reheating SLICED hard-boiled eggs and cooking SCRAMBLED eggs is safe.

Browning

Foods will not have the same brown appearance as conventionally cooked foods or those foods which are cooked utilizing a browning feature. Meats and poultry may be coated with browning sauce, Worcestershire sauce, barbecue sauce or shake-on browning sauce. To use, combine browning sauce with melted butter or margarine and brush on before cooking. For quick breads or muffins, brown sugar can be used in the recipe in place of granulated sugar, or the surface can be sprinkled with dark spices before baking.

Spacing

Individual foods, such as baked potatoes, cupcakes and appetizers, will cook more evenly if placed in the oven equal distances apart. When possible, arrange foods in a circular pattern.

Covering

As with conventional cooking, moisture evaporates during microwave cooking. Casserole lids or plastic wrap are used for a tighter seal. When using plastic wrap, vent the plastic wrap by folding back part of the plastic wrap from the edge of the dish to allow steam to escape. Loosen or remove plastic wrap as recipe directs for stand time. When removing plastic wrap covers, as well as any glass lids, be careful to remove them away from you to avoid steam burns. Various degrees of moisture retention are also obtained by using wax paper or paper towels.

Cooking Time

Cooking times will vary because of food shape variations, starting temperature, and regional preferences. Always cook food for the minimum cooking time given in a recipe and check for doneness. If the food is undercooked, continue cooking. It is easier to add time to an undercooked product. Once the food is overcooked, nothing can be done.

Stirring

Stirring is usually necessary during microwave cooking. Always bring the cooked outside edges toward the center and the less cooked center portions toward the outside of the dish.

Rearranging

Rearrange small items such as chicken pieces, shrimp, hamburger patties or pork chops. Rearrange pieces from the edge to the center and pieces from the center to the edge of the dish.

Turning

It is not possible to stir some foods to distribute the heat evenly. At times, microwave energy will concentrate in one area of the food. To help ensure even cooking, these foods need to be turned. Turn over large foods, such as roasts or turkeys, halfway through cooking.

Standing Time

Most foods will continue to cook by conduction after the microwave oven is turned off. After cooking meat, the internal temperature will rise 5 °F to 15 °F (3 °C to 8 °C), if allowed to stand, tented with foil, for 10 to 15 minutes. Casseroles and vegetables need a shorter amount of standing time, but this standing time is necessary to allow foods to complete cooking to the center without overcooking on the edges.

Test for Doneness

The same tests for doneness used in conventional cooking may be used for microwave cooking. Meat is done when fork-tender or splits at fibers. Chicken is done when juices are clear yellow and drumstick moves freely. Fish is done when it flakes and is opaque. Cake is done when a toothpick or cake tester is inserted and comes out clean.

Check foods to see that they are cooked to the United States Department of Agriculture's recommended temperatures.

To test for doneness, insert a meat thermometer in a thick or dense area away from fat or bone. NEVER leave the thermometer in the food during cooking, unless it is approved for microwave oven use.

Temp	Food
160 °F	For fresh pork, ground meat, boneless white poultry, fish, seafood, egg dishes and frozen prepared food.
165 °F	For leftover, ready-to-reheat refrigerated, and deli and carryout "fresh" food.
170 °F	For white meat poultry.
180 °F	For dark meat poultry.

Care and Cleaning of Your Microwave Oven

Please see below and the following page for particular cleaning instructions for each section of the oven.

BEFORE CLEANING: Unplug oven at wall outlet. If outlet is inaccessible, leave oven door open while cleaning.

AFTER CLEANING: Be sure to place the Roller Ring and the Glass Tray in the proper position and press **Stop/Reset** Pad to clear the Display.

1. **Outside oven surfaces:** Clean with a damp cloth. To prevent damage to the operating parts inside the oven, water should not be allowed to seep into ventilation openings.
2. **Label:** Do not remove. Wipe with a damp cloth.
3. **Inside the Oven:** Wipe with a damp cloth after using. Mild detergent may be used if needed. Do not use harsh detergents or abrasives.
4. **Oven Door:** Wipe with a soft dry cloth when steam accumulates inside or around the outside of the oven door. During cooking, especially under high humidity conditions, steam is given off from the food. (Some steam will condense on cooler surfaces, such as the oven door. This is normal.) Inside surface is covered with a heat and vapor barrier film. **Do not remove.**
5. **Oven Cavity Floor:** Clean the bottom surface of the oven with mild detergent, water or window cleaner, and dry.
6. **Wave Guide Cover:** Do not remove Wave Guide Cover. It is important to keep cover clean in the same manner as the inside of the oven. Failure to do so may damage the cover.
7. **Control Panel:** The Control Panel is covered with a removable protective film to prevent scratches during shipping. Small bubbles may appear under this film, so if this is the case, remove by applying masking or clear tape to an exposed corner and pull gently. If the Control Panel becomes wet, clean it with a soft dry cloth. Do not use harsh detergents or abrasives.
8. **Glass Tray:** Remove and wash in warm soapy water or in a dishwasher.
9. **Roller Ring:** Roller Ring may be washed in mild soapy water or dishwasher. These areas should be kept clean to avoid excessive noise.

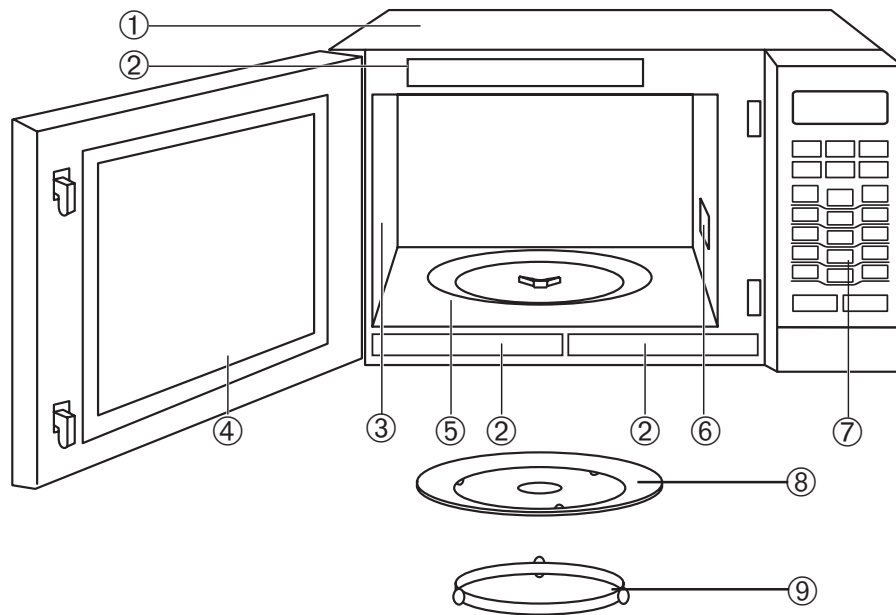

AS WITH ANY COOKING APPLIANCE, MICROWAVE OVENS REQUIRE THE SAME LEVEL OF CARE TO PREVENT OVERHEATING OR DAMAGE. IT IS IMPORTANT TO KEEP THE OVEN CLEAN AND DRY. FOOD RESIDUE AND CONDENSATION MAY CAUSE RUSTING OR ARCING AND DAMAGE TO THE OVEN. AFTER USE, WIPE DRY ALL SURFACES, INCLUDING VENT OPENINGS, OVEN SEAMS, AND UNDER GLASS TRAY.

Shop Accessories

Purchase Parts, Accessories and Instruction Books online for all Panasonic Products by visiting our Web Site at:

shop.panasonic.com/support

Parts Available to Order:

Instructions/Operating Manual (this book)	F0003CU00AT
Glass Tray	F06015Q00AP
Roller Ring Assembly	F290D6W50XP

Before Requesting Service

See below before calling for service, as most problems can easily be remedied by following these simple solutions:

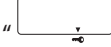
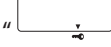
Problem	Solution
The oven causes TV interference.	Some radio, TV, Wi-Fi, cordless telephone, baby monitor, blue tooth or other wireless equipment interference might occur when you cook with the microwave oven. This interference is similar to the interference caused by small appliances such as mixers, vacuums, blow dryers, etc. It does not indicate a problem with your oven.
Steam accumulates on oven door and warm air comes from the oven vents.	During cooking, steam and warm air are given off from the food. Most of the steam and warm air are removed from the oven by the air which circulates in the oven cavity. However, some steam will condense on cooler surfaces such as the oven door. This is normal. After use, the oven should be wiped dry (see page 17).
Oven will not turn on.	The oven is not plugged in securely or needs to be reset; remove plug from outlet, wait ten seconds and re-insert. Main circuit breaker or main fuse is tripped; reset main circuit breaker or replace main fuse. There is a problem with the outlet; plug another appliance into the outlet to check if it is working.
Oven will not start cooking.	The door is not completely closed; close the oven door securely. Start was not pressed after programming; press Start . Another program is already entered into the oven; press Stop/Reset to cancel the previous program and enter new program. The program is not correct; program again according to the Operating Instructions. Stop/Reset has been pressed accidentally; program oven again.
The Glass Tray wobbles.	The Glass Tray is not positioned properly on the Roller Ring or there is food under the Roller Ring; take out Glass Tray and Roller Ring. Wipe with a damp cloth and reset Roller Ring and Glass Tray properly.
When the oven is operating, there is noise coming from the Glass Tray.	The Roller Ring and oven bottom are dirty; clean these parts according to Care and Cleaning of Your Microwave Oven (see page 17).
The indication light "  " appears in the display window.	The CHILD SAFETY LOCK was activated by pressing Start three times; Deactivate CHILD SAFETY LOCK by pressing Stop/Reset three times.
The indication light "  " flashes in the display window.	The CHILD SAFETY DOOR LOCK was activated. Unlock CHILD SAFETY DOOR LOCK by pressing " 0 " once, then pressing the door release button.
The oven stops cooking and "H00", "H97" or "H98" appears in the display.	The oven's power supply has failed; please contact an authorized Service Center (see next page).

Limited Warranty (Only for U.S.A.)

Panasonic Products Limited Warranty

Limited Warranty Coverage (For USA Only)

If your product does not work properly because of a defect in materials or workmanship, Panasonic Consumer Electronics Corporation (referred to as "the warrantor") will, for the length of the period indicated on the chart below, which starts with the date of original purchase ("warranty period"), at its option either (a) repair your product with new or refurbished parts, (b) replace it with a new or a refurbished equivalent value product, or (c) refund your purchase price. The decision to repair, replace or refund will be made by the warrantor.

Product or Part Name	Labor	Parts
ALL PARTS (EXCEPT MAGNETRON TUBE)	1 yr.	1 yr.
MAGNETRON TUBE	1 yr.	5 yr.

During the "Labor" warranty period there will be no charge for labor. During the "Parts" warranty period, there will be no charge for parts.

This warranty only applies to products purchased and serviced in the United States. This warranty is extended only to the original purchaser of a new product which was not sold "as is".

Mail-In Service – Online Repair Request

Online Repair Request

To submit a new repair request, and for quick repair status visit our Web Site at: <http://shop.panasonic.com/support>

When shipping the unit, carefully pack and send it in the original (or supplied) carton. Include a letter detailing the complaint along with the bill of sales and provide a daytime phone number where you can be reached. A valid registered receipt is required under the Limited Warranty.

When shipping Lithium Ion batteries please visit our web site at <http://shop.panasonic.com/support> as Panasonic is committed to providing the most up to date information.

IF REPAIR IS NEEDED DURING THE WARRANTY PERIOD, THE PURCHASER WILL BE REQUIRED TO FURNISH A SALES RECEIPT/PROOF OF PURCHASE INDICATING DATE OF PURCHASE, AMOUNT PAID AND PLACE OF PURCHASE. CUSTOMER WILL BE CHARGED FOR THE REPAIR OF ANY UNIT RECEIVED WITHOUT SUCH PROOF OF PURCHASE.

Limited Warranty Limits And Exclusions

This warranty ONLY COVERS failures due to defects in materials or workmanship, and DOES NOT COVER glass, plastic parts, temperature probes (if included) and normal wear and tear or cosmetic damage. The warranty ALSO DOES NOT COVER damages which occurred in shipment, or failures which are caused by products not supplied by the warrantor, or failures which result from accidents, misuse, abuse, neglect, bug infestation, mishandling, misapplication, alteration, faulty installation, set-up adjustments, maladjustment of consumer controls, improper maintenance, power line surge, lightning damage, modification, or commercial use (such as in a hotel, office, restaurant, or other business), rental use of the product, service by anyone other than a Factory Service center or other Authorized Servicer, or damage that is attributable to acts of God.

THERE ARE NO EXPRESS WARRANTIES EXCEPT AS LISTED UNDER "LIMITED WARRANTY COVERAGE".

THE WARRANTOR IS NOT LIABLE FOR INCIDENTAL OR CONSEQUENTIAL DAMAGES RESULTING FROM THE USE OF THIS PRODUCT, OR ARISING OUT OF ANY BREACH OF THIS WARRANTY.

(As examples, this excludes damages for lost time, travel to and from the servicer, loss of or damage to media or images, data or other memory or recorded content. The items listed are not exclusive, but for illustration only.)

ALL EXPRESS AND IMPLIED WARRANTIES, INCLUDING THE WARRANTY OF MERCHANTABILITY, ARE LIMITED TO THE PERIOD OF THE LIMITED WARRANTY.

Some states do not allow the exclusion or limitation of incidental or consequential damages, or limitations on how long an implied warranty lasts, so the exclusions may not apply to you.

This warranty gives you specific legal rights and you may also have other rights which vary from state to state. If a problem with this product develops during or after the warranty period, you may contact your dealer or Service Center. If the problem is not handled to your satisfaction, then write to:

Panasonic Corporation of North America
Consumer Affairs Department
Two Riverfront Plaza
Newark NJ 07102-5490

PARTS AND SERVICE, WHICH ARE NOT COVERED BY THIS LIMITED WARRANTY, ARE YOUR RESPONSIBILITY.

Product registration is not mandatory. Failure to complete the form does not affect the consumer's warranty rights.

Shop Accessories!

for all your Panasonic gear

Go to

<http://shop.panasonic.com/support>

Get everything you need to get the most out of your Panasonic products

Accessories & Parts for your Camera, Phone, A/V products, TV, Computers & Networking, Personal Care, Home Appliances, Headphones, Batteries, Backup Chargers & more...

Customer Services Directory

For Product Information, Operating Assistance, Parts, Owner's Manuals, Dealer and Service info go to <http://shop.panasonic.com/support>

For the hearing or speech impaired TTY: 1-877-833-8855

As of January 11, 2023

Specifications

Power Source	120 V, 60 Hz
Power Consumption	12.4 Amps, 1,480 W
Cooking Power*	1,200 W
Outside Dimensions (W x H x D)	20 1/16" x 12 1/4" x 15 13/16" (525 mm x 310 mm x 401 mm)
Oven Cavity Dimensions (W x H x D)	13 15/16" x 9 15/16" x 14 3/8" (355 mm x 251mm x 365 mm)
Operating Frequency	2,450 MHz
Net Weight	Approx. 25.5 lbs (11.5 kg)

*IEC Test procedure

Specifications subject to change without notice.

Trim Kit Information

Trim Kit Cabinet

Model Number	NN-TK621S
Outside Dimensions (W x H)	27" x 16 1/2" (684 mm x 419 mm)
Cabinet Opening (W x H x D)	25 1/2" x 15 5/16" x 21" (648 mm x 389 mm x 533 mm)

User's Record

The serial number of this product may be found on the back side of the oven or on the left side of the control panel. You should note the model number and the serial number of this oven in the space provided and retain this book as a permanent record of your purchase for future reference.

Model No. _____

Serial No. _____

Date of Purchase _____

Scan this code for product registration





INSTRUCCIONES IMPORTANTES DE SEGURIDAD

Su seguridad y la seguridad de los demás son muy importantes.



Hemos suministrado mensajes importantes de seguridad en este manual y en su electrodoméstico. Siempre lea y cumpla con todos los mensajes de seguridad.

Este es el símbolo de alerta de seguridad. Se usa para alertar sobre posibles peligros que pueden causarle heridas o la muerte, a usted y a otras personas.

Todos los mensajes de seguridad seguirán al símbolo de alerta de seguridad y la palabra "PELIGRO", "ADVERTENCIA" o "PRECAUCIÓN". Estas palabras significan:

PELIGRO

No seguir las instrucciones de inmediato puede ocasionarle lesiones graves o la muerte.

ADVERTENCIA

No seguir las instrucciones puede ocasionarle lesiones graves o la muerte.

PRECAUCIÓN

Puede quedar expuesto a una situación de posible peligro que, si no se evita, puede causarle lesiones menores o moderadas.

Todos los mensajes de seguridad le indicarán cuál es el posible peligro, le dirán cómo reducir la probabilidad de lesiones y qué puede suceder si no se siguen las instrucciones.



PRECAUCIONES PARA EVITAR POSIBLE EXPOSICIÓN EXCESIVA A LA ENERGÍA DEL MICROONDAS

- (a) **NO** intente poner en funcionamiento este horno con la puerta abierta, ya que el funcionamiento del mismo con la puerta abierta puede provocar una exposición dañina a la energía de microondas. Es importante que no anule ni fuerce los dispositivos de seguridad.
- (b) **NO** coloque objetos entre la parte frontal del horno y la puerta, ni permita que se acumule tierra ni residuos del líquido limpiador sobre la superficie de sellado.
- (c) **NO** ponga en funcionamiento el horno si se encuentra dañado. Es fundamental que la puerta del horno cierre correctamente y que ninguna de las siguientes partes se encuentre dañada:
 - (1) la puerta (doblada),
 - (2) las bisagras y las trabas (rotas o flojas),
 - (3) el sellado de las puertas o las superficies de sellado.
- (d) Sólo permita que personal de mantenimiento calificado repare o arregle el horno.

Gracias por comprar un Horno de microondas Panasonic

Su horno de microondas es un electrodoméstico para cocinar, y usted debe tener tanto cuidado como con la cocina u otro electrodoméstico para cocinar. Cuando utilice este aparato electrodoméstico, siga las instrucciones de seguridad básicas, incluso las que figuran a continuación:

ADVERTENCIA

Para disminuir el riesgo de quemaduras, descargas eléctricas, incendios, lesiones a personas o excesiva exposición a energía de microondas:

1. Lea todas las instrucciones antes de utilizar este electrodoméstico.
2. Lea y siga las "**PRECAUCIONES PARA EVITAR POSIBLE EXPOSICIÓN EXCESIVA A LA ENERGÍA DE MICROONDAS**" específicas que aparecen arriba.
3. Este electrodoméstico debe tener conexión a tierra. Sólo conéctelo a un tomacorriente con una adecuada conexión a tierra. Vea las "**INSTRUCCIONES PARA LA CONEXIÓN A TIERRA**" en la página 3.
4. Al igual que con cualquier electrodoméstico para cocinar, **CONTROLE** su horno mientras lo usa.
5. Instale o ubique este electrodoméstico solo en conformidad con las instrucciones de instalación de la página 3.
6. **NO** cubra ni bloquee ninguna abertura de este aparato.
7. **NO** guarde este aparato en el exterior. **NO** utilice este producto cerca del agua (por ejemplo: cerca de un fregadero, en un sótano húmedo o cerca de una piscina o ubicación similar).
8. Utilice este aparato sólo para su uso previsto, según se describe en este manual. **NO** utilice productos químicos corrosivos, vapores o productos no alimenticios en este aparato. Este tipo de horno ha sido diseñado específicamente para calentar o cocinar alimentos. No ha sido diseñado para uso industrial o en laboratorios. El uso de químicos corrosivos, ya sea para calentarlos o limpiar, dañará el electrodoméstico y podrá provocar escapes de radiación.
9. Al limpiar la superficie de las uniones de la puerta y el horno cuando se cierra la puerta, utilice sólo jabones o detergentes suaves y no abrasivos y aplíquelos con una esponja o paño suave.



INSTRUCCIONES IMPORTANTES DE SEGURIDAD (continuación)

10. **NO** deje que los niños utilicen este electrodoméstico, a menos que los supervise un adulto. **NO** asuma que un niño puede cocinar cualquier cosa porque dominó una habilidad de cocción.
11. **EL CONTENIDO CALIENTE PUEDE PROVOCAR QUEMADURAS GRAVES. NO PERMITA A LOS NIÑOS USAR EL MICROONDAS.** Tenga cuidado cuando retire el contenido caliente.
12. **NO** ponga en funcionamiento este aparato si tiene algún cable o enchufe dañado, si no funciona correctamente o si se dañó o se cayó.
13. **NO** sumerja el cable ni el enchufe en agua.
14. Evite el contacto del cable con superficies calientes.
15. **NO** permita que el cable cuelgue del borde de una mesa o mostrador.
16. Sólo el personal de mantenimiento calificado podrá reparar este aparato. Comuníquese con el centro de servicio técnico autorizado más cercano para su control, reparación o ajuste.
17. Algunos productos como los huevos enteros, con o sin cáscara, botellas de cuello angosto y los recipientes sellados (por ejemplo, frascos de vidrio cerrados), pueden explotar y por lo tanto no deben calentarse en este horno.
18. Para reducir el riesgo de incendio en la cavidad del horno:
 - (a) **NO** cocine demasiado los alimentos. Observe cuidadosamente el aparato cuando coloque papel, plástico u otros materiales inflamables dentro del horno para facilitar la cocción.
 - (b) Retire las tiras de alambre de las bolsas de papel o plástico antes de colocar las mismas en el horno.
 - (c) **Si se prende fuego el material dentro del horno, mantenga la puerta cerrada, apague el horno y desconecte el cable de alimentación desde el fusible o desde el panel interruptor.**
 - (d) **NO** utilice la cavidad para almacenar cosas. **NO deje productos de papel, utensilios de cocina o alimentos dentro de la cavidad cuando no se encuentre en uso.**
19. **Líquidos calentados en exceso:** Los líquidos como el agua, el café o el té pueden recalentarse más que el punto de ebullición y no mostrar evidencias (o signos) de ebullición. No siempre se observan las burbujas cuando retira el recipiente del horno de microondas. ESTO PUEDE HACER QUE, AL TOCAR EL RECIPIENTE O INTRODUCIR UN UTENSILIO EN EL LÍQUIDO MUY CALIENTE, ÉSTE SE DESBORDE. Para reducir el riesgo de lesiones en las personas:
 - (a) **Revuelva el líquido antes y a la mitad del proceso de calentado.**
 - (b) **NO caliente agua y aceite, o grasas, juntos. La película de aceite atraparé el vapor y podrá causar una erupción violenta.**
 - (c) **NO** utilice recipientes con lados rectos y cuello angosto.
 - (d) Después de calentar algo, deje el recipiente en el microondas durante un corto lapso de tiempo antes de retirarlo.
20. **NO** cocine directamente sobre la plataforma giratoria. Se puede romper y causar lesiones o daños al horno.
21. Para hornos diseñados para instalarse en un mueble:
 - (a) **NO** ponga en funcionamiento ningún electrodoméstico para calentar o cocinar debajo de este electrodoméstico.
 - (b) **NO** monte la unidad sobre una parte de un electrodoméstico para calentar o cocinar ni cerca de éste.
 - (c) **NO** lo monte sobre un fregadero.
 - (d) **NO** guarde nada directamente sobre la parte superior de la superficie del electrodoméstico cuando este se encuentre en funcionamiento.

CONSERVE ESTAS INSTRUCCIONES



ADVERTENCIA

PARA EVITAR EL RIESGO DE DESCARGAS:

NO retire el panel exterior del horno. Sólo una persona de mantenimiento calificada podrá reparar el horno.

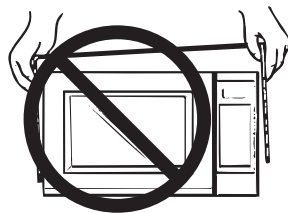

PARA REDUCIR EL RIESGO DE EXPOSICIÓN A LA ENERGÍA DEL MICROONDAS:

NO apriete, arregle o repare la puerta, el marco del panel de control, los interruptores de dispositivos de seguridad, ni ninguna otra parte del horno. Puede causar pérdidas en el microondas.

Precauciones de seguridad

PARA EVITAR EL RIESGO DE ARCOS ELÉCTRICOS O INCENDIOS:

1. **NO** opere el horno de microondas vacío, **ni cocine porciones pequeñas de alimentos sin supervisión**, ni utilice recipientes de metal. Al usar el horno de microondas sin agua o alimentos, **o cocinar una porción demasiado pequeña**, su energía no puede ser absorbida y se reflejará de manera continua a través de la cavidad. Esto ocasionará la formación de arcos eléctricos y daños a la cavidad del horno u otros componentes, lo que podría derivar en un peligro de incendio.
2. **NO** guarde material inflamable junto al horno, ni arriba ni dentro de él.

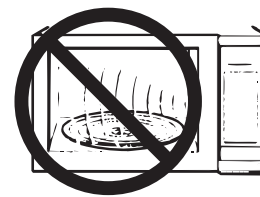

⚠️ INSTRUCCIONES IMPORTANTES DE SEGURIDAD (continuación)

3. **NO** seque ropa, periódicos u otros materiales en el horno, ni use periódicos o bolsas de papel para cocinar.

4. **NO** golpee ni pegue en el panel de control. Pueden causarse daños a los controles.

5. **NO** use productos de papel reciclado a menos que el producto de papel tenga una etiqueta que indique que es seguro para su uso en horno de microondas. Los productos de papel reciclado pueden contener impurezas que pueden provocar chispas.



2. **NO** ponga en funcionamiento el horno sin que la bandeja de vidrio esté totalmente acoplada al buje de accionamiento. Puede provocar daños al horno o mala cocción. Verifique que la bandeja de vidrio esté bien acoplada y gire, observando su rotación cuando presiona **Comenzar (Start)**.

Nota: La bandeja de vidrio puede girar en cualquier dirección.

3. Use solo la bandeja de vidrio específicamente diseñada para este horno. **NO** sustituya por ninguna otra bandeja de vidrio.

4. Si la bandeja de vidrio se encuentra caliente, deje que se enfríe antes de limpiarla o de colocarla en agua.

5. **NO** cocine directamente sobre la bandeja de vidrio. Siempre coloque alimentos en un plato seguro para microondas o en una rejilla en un plato seguro para microondas.

6. Si los alimentos o utensilios en la bandeja de vidrio tocan las paredes del horno, y hacen que la bandeja deje de moverse, la bandeja automáticamente rotará en dirección contraria.

PARA EVITAR EL RIESGO DE QUEMADURAS:

Siempre se deberán usar AGARRADERAS para quitar elementos del horno. El calor se transfiere de los alimentos CALIENTES al recipiente de cocción y del recipiente a la bandeja de vidrio. La Bandeja de vidrio también puede estar muy CALIENTE después de sacar el recipiente de cocción del horno.



Bandeja de vidrio

1. **NO** ponga en funcionamiento el horno sin que el anillo de rodillo y la bandeja de vidrio estén en su lugar.

Anillo de rodillo

1. El anillo de rodillo y la base del horno deben limpiarse con frecuencia para evitar el exceso de ruido.

2. Siempre reemplace el anillo de rodillo y la bandeja de vidrio en sus posiciones correctas.

3. Siempre que utilice la bandeja de vidrio para cocinar, use el anillo de rodillo.

Para el uso apropiado del horno lea las precauciones restantes de seguridad e instrucciones de funcionamiento.

⚠️ Instrucciones de Instalación y Para La Conexión a Tierra

Examine su horno

Desembale el horno, quite todo el material de embalaje y examine el horno para ver si tiene daños, como abolladuras, trabas de puertas rotas o roturas en la puerta. Notifique de inmediato al distribuidor si existen daños en el horno. **NO** instale si el horno está dañado.

Ubicación del horno

1. El horno debe colocarse en una superficie plana y estable. Coloque la superficie frontal de la puerta a tres pulgadas o más del borde del mostrador para evitar vuelcos accidentales

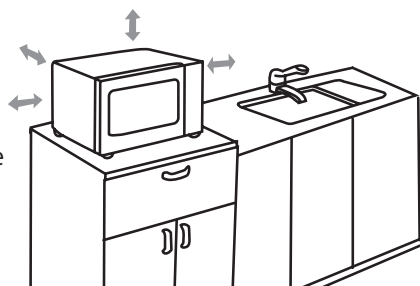

del horno de microondas durante el uso normal. Para un funcionamiento correcto, el horno debe tener suficiente flujo de aire. Deje 7,6 cm (3 pulgadas) de espacio en ambos lados del horno y 2,5 cm (una pulgada) de espacio por encima del horno.

(a) **NO** bloquee las entradas y salidas de aire. Si se bloquean durante su funcionamiento, el horno puede recalentarse y dañarse.

(b) **NO** coloque el horno cerca de una superficie caliente y húmeda, como una cocina de gas o eléctrica, fregadero o lavavajillas.

(c) **NO** ponga en funcionamiento el horno cuando haya excesiva humedad ambiental.

2. Este horno fue manufacturado para el uso doméstico únicamente. No fue probado para usarse en ningún tipo de vehículo terrestre, marítimo o de uso comercial.

Instalación

1. **NO** bloquee las entradas y salidas de aire. Si se bloquean durante su funcionamiento, el horno puede recalentarse. Si el horno se recalienta, un dispositivo de seguridad térmica apagará el horno. El horno permanecerá sin funcionar hasta que se haya enfriado.

2. El aparato ha sido diseñado para su instalación en un armario de pared utilizando el kit de ajuste apropiado disponible de un distribuidor local de Panasonic, siga todas las instrucciones incluidas con el kit.

ADVERTENCIA: EL USO INCORRECTO DEL ENCHUFE A TIERRA PUEDE REPRESENTAR UN RIESGO DE DESCARGA ELÉCTRICA.

Consulte con un electricista calificado o con el personal de mantenimiento si no comprende alguna de las instrucciones de conexión a tierra, o si tiene alguna duda en cuanto a la conexión a tierra correcta del aparato. Si necesita utilizar un cable alargador, utilice sólo uno con tres hilos que cuente con un enchufe a tierra para tres puntas, polarizado, y un tomacorriente con tres ranuras que acepte el enchufe del aparato. La clasificación marcada del cable alargador debe ser igual o mayor a la clasificación eléctrica del electrodoméstico.

Instrucciones para la conexión a tierra

Este electrodoméstico debe tener conexión a tierra.

En caso de producirse un cortocircuito eléctrico, la conexión a tierra reduce el riesgo de una descarga eléctrica ya que proporciona un cable de escape para la corriente eléctrica. Este aparato se encuentra equipado con un cable con conexión a tierra y un enchufe a tierra.

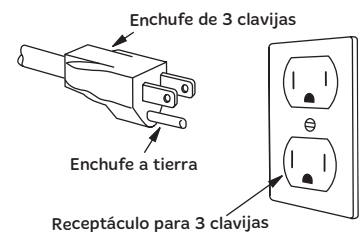



Instrucciones de Instalación y Para La Conexión a Tierra (continuación)

El enchufe debe conectarse en un toma corriente correctamente instalado y que tenga conexión a tierra.

- **Conecte en un toma corriente para tres clavijas correctamente instalado y con conexión a tierra.**
- **NO** quite la clavija a tierra.
- **NO** use un adaptador.

Alimentación

1. El microondas trae un cable de alimentación corto para reducir el riesgo de enredarse o tropezar con un cable más largo.
2. Se encuentran disponibles juegos de cable más largos o cables alargadores y se pueden utilizar si se tiene cuidado en su uso. **NO** permita que el cable cuelgue del borde de una mesa o mostrador.
3. Si utiliza un cable largo o cable alargador,
 - (1) la clasificación eléctrica marcada del juego del cable o del cable alargador debe ser por lo menos igual a la clasificación eléctrica del aparato,
 - (2) el cable alargador debe ser un cable con descarga a tierra con tres hilos y
 - (3) el cable alargador debe estar dispuesto de manera tal que no se pliegue sobre la superficie del mostrador o de una mesa en donde un niño pueda tirarlo o tropezar involuntariamente.

Requisitos de cableado

Debe ponerse en funcionamiento el horno en un CIRCUITO SEPARADO. Ningún otro aparato compartirá el circuito con el horno de microondas. Si así fuera, el fusible de circuito del ramal puede

explotar o puede saltar el disyuntor. El horno se enchufará en un TOMA CORRIENTE A TIERRA de al menos 20 A, 120 V, 60 Hz. Donde se encuentre un toma corriente para dos clavijas estándar, será obligación y responsabilidad personal del consumidor reemplazarlo por un toma corriente para tres clavijas correctamente conectado a tierra. El VOLTAJE utilizado debe ser el mismo especificado en este horno de microondas (120 V, 60 Hz).

El uso de voltaje más alto es peligroso y puede causar incendios o daños al horno. El uso de voltaje más bajo puede provocar una cocción lenta. Panasonic NO asume responsabilidad por daños que resulten del uso del horno con voltajes que no sean los especificados.

TV / RADIO / INTERFERENCIAS EQUIPOS INALÁMBRICOS

Este producto ha sido evaluado y cumple con los límites para Hornos de Microondas, según la Parte 18 de las normas de la FCC. Este producto puede emitir energía de radio frecuencia, lo que podría producir interferencia en radios, TVs, monitor de bebé, teléfono inalámbrico, Bluetooth, router inalámbrico o equipos similares, lo que se puede confirmar apagando este producto y volviéndolo a encender. Si está presente, se alienta al usuario a tratar de corregirlo tomando una o más de las siguientes medidas:

- (1) Aumente la distancia de separación entre el horno microondas y otro producto que recibe la interferencia.
- (2) Si es posible, utilice una antena receptora correctamente instalado y / o reorientar la antena receptora de la otra receptora product la interferencia.
- (3) Enchufe el horno de microondas a una toma diferente de la otra producto que recibe la interferencia.
- (4) Limpia la puerta y las superficies de sellado del horno. (Vea Cuidado y Limpieza de su horno de microondas)

Si tiene preguntas o inquietudes sobre algún problema relacionado con su información personal, comuníquese con la Oficina de Ética y Cumplimiento de Panasonic Corporation of North America en privacy@us.panasonic.com.

Preparación de Alimentos

Siga estas Precauciones de seguridad cuando cocine en su horno.

IMPORTANTE

La cocción correcta depende de la potencia, configuración de tiempo y cantidad de alimentos. Si usa una porción más pequeña que la recomendada pero la cocina en el momento para la porción recomendada, puede producirse un incendio.

1) PREPARADO DE CONSERVAS CASERAS / ESTERILIZACIÓN / DESHIDRATAR ALIMENTOS / PEQUEÑAS CANTIDADES DE ALIMENTOS

- **NO** use el horno para preparar conservas caseras. Su horno no puede mantener los alimentos a la temperatura adecuada de preparado de conservas. Los alimentos pueden contaminarse y echarse a perder.
- **NO** use el horno de microondas para esterilizar objetos (mamaderas, etc.). Es difícil mantener el horno a la temperatura elevada necesaria para la esterilización.
- **NO** deshidrate carnes, hierbas, frutas o verduras en el horno. Las cantidades pequeñas de alimentos o alimentos con poco contenido de humedad pueden secarse, quemarse o prenderse fuego si se recalientan
- **NO** prepare porciones demasiado pequeñas a alta potencia. Esto puede generar concentración de energía en un punto fijo, que puede generar arcos eléctricos y dañar su horno. Seleccione un ajuste de potencia de cocción menor al preparar porciones pequeñas.

2) PALOMITAS DE MAÍZ

Las palomitas de maíz pueden prepararse en un recipiente para palomitas de maíz especial para microondas. También hay disponibles palomitas de maíz para microondas que se preparan en su propio paquete. Siga las indicaciones del fabricante de palomitas de maíz y use una marca adecuada para la potencia de cocción de su horno de microondas.

PRECAUCIÓN: Cuando use palomitas de maíz para microondas preempacadas, puede seguir las instrucciones recomendadas en el paquete o usar la tecla Palomitas de maíz (Popcorn) (consulte la página 12). De lo contrario, las palomitas de maíz tal vez no se cocinen correctamente o pueden causar un incendio. Siempre controle el horno cuando esté preparando palomitas de maíz. Deje enfriar la bolsa de palomitas de maíz antes de abrirla, y siempre abra la bolsa lejos de su rostro y cuerpo para evitar quemarse con el vapor.



Preparación de Alimentos (continuación)

3) FRITURAS CON GRASA

- **NO** fría con grasa en su horno de microondas. Los aceites de cocina pueden explotar en llamas y causar daños al horno y pueden provocar quemaduras. Es posible que los utensilios para microondas no soporten la temperatura del aceite caliente y se pueden romper o derretir.

4) ALIMENTOS CON PIEL NO POROSA

• **NO COCINAR/RECALENTAR HUEVOS ENTEROS, CON O SIN CÁSCARA.**

- La acumulación de vapor en los huevos enteros puede hacerlos explotar y posiblemente dañe el horno o cause lesiones. Recalentar huevos duros



EN RODAJAS y cocinar huevos REVUELTOS es seguro.

- **Las papas, manzanas, la calabaza entera y las salchichas** son algunos ejemplos de alimentos con piel no porosa. Estos tipos de alimentos pueden perforarse antes de la cocción en microondas para evitar que exploten.



PRECAUCIÓN: Cocinar papas viejas o secas puede causar incendios.

5) BANDEJA DE VIDRIO / RECIPIENTES DE COCCIÓN / PAPEL DE ALUMINIO

- Los utensilios para cocinar se calientan durante la cocción en microondas. Use soportes para lo caliente, cuando saque los utensilios del horno o cuando quite tapas o cubiertas de envoltura de plástico de los utensilios de cocina, para evitar quemaduras.
- La Bandeja de vidrio se calentará durante la cocción. Debe dejarse enfriar antes de manipularla, o antes de colocar productos de papel, como platos de papel o bolsas de palomitas de maíz para microondas en el horno para su cocción en microondas.
- Al usar papel aluminio en el horno, permita por lo menos de 2,5 mm (1 pulgada) de espacio entre el papel aluminio y las paredes del horno o la puerta interior.
- Los platos con borde metálico no se deberán usar, ya que puede producirse un arco eléctrico.

6) TOALLAS DE PAPEL/PAÑOS

- **NO** use toallas de papel o paños que contengan fibra sintética tejida en ellos. La fibra sintética puede prender fuego la toalla. Use toallas de papel bajo supervisión.

7) PLATOS PARA DORAR/BOLSAS DE COCCIÓN EN HORNO

- Los platos para dorar o parrillas están diseñadas para cocción en microondas únicamente. Siempre siga las instrucciones del fabricante. **NO** precaliente un plato para dorar más de seis minutos.
- Si se usa bolsa de cocción en horno para la cocción en microondas, prepare según las indicaciones del paquete. **NO** use una tira de alambre para cerrar la bolsa. En cambio, use tiras de plástico, cuerda de algodón, o una tira cortada del extremo abierto de la bolsa.

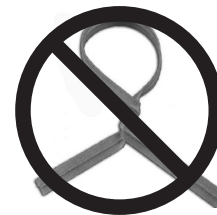

8) TERMÓMETROS

- **NO** use un termómetro de carnes convencional en su horno. Puede producirse un arco eléctrico. Hay disponibles termómetros seguros para microondas, para carnes y dulces.



9) ALIMENTOS Y FÓRMULA PARA BEBÉS

- **NO** caliente alimentos o fórmula para bebés en el horno de microondas. El frasco de vidrio o la superficie de los alimentos pueden parecer tibios mientras que el interior puede estar tan caliente que le queme la boca y esófago al bebé.



10) RECALENTAR PRODUCTOS DE PASTERÍA

- Cuando recaliente productos de pastelería, verifique las temperaturas de cualquier relleno antes de comer. Algunos alimentos tienen relleno, que se calienta más rápido y puede ser extremadamente caliente, mientras que la superficie sigue tibia al tacto (por ejemplo, donas con jalea).

11) PAUTAS GENERALES DE USO DEL HORNO

- **NO** use el horno para ningún fin excepto para preparar alimentos.

Guía de Utensilios de Cocina

Esta sección responde a la pregunta “¿Qué puedo usar en el microondas?”

Papel de aluminio

No se recomienda su uso. Se puede producir un arco eléctrico si el papel está demasiado cerca de la pared del horno o la puerta, y puede dañar el horno.



Plato para dorar

Sí. Solo use platos para dorar diseñados para cocción en microondas. Verifique la información del plato para dorar, para ver las instrucciones/tabla de calentamiento. No precaliente más de seis minutos.

Bolsas de papel marrón

No. Pueden causar un incendio en el horno.



Seguro para microondas

Sí. Si tiene etiqueta de Seguro para microondas, verifique las indicaciones del fabricante para el uso para calentar en microondas. Cierta vajilla puede indicar en el reverso “Seguro para uso en horno de microondas”.



Vajilla

Sin etiqueta, use la PRUEBA DEL RECIPIENTE a continuación.

Platos de cartón de poliéster w

Sí. Algunos alimentos congelados están envasados en estos platos. También se pueden comprar en algunas tiendas de comestibles.



Cartones de locales de comida rápida con asa de metal.

No. El asa de metal puede causar arco eléctrico.



Bandejas de comidas congeladas

Si son para microondas, sí. Si contiene metal, no.



Frascos de vidrio

No. La mayoría de los frascos de vidrio no son resistentes al calor. Horno resistente al calor.



Cristalería/Cerámica

Sí, pero solo para cocción y dorado en microondas. (Ver la PRUEBA DEL RECIPIENTE a continuación).



Fuentes de horno de metal

No. El metal puede provocar arco eléctrico y dañar el horno.



Tiras de metal

No. Pueden causar arco eléctrico, que puede provocar un incendio en el horno.



Bolsa de cocción en horno

Sí. Siga las indicaciones del fabricante. Cierre la bolsa con la tira de nylon suministrada, un corte de tira del extremo de la bolsa o un trozo de cuerda de algodón. No cierre con la tira de metal. Haga seis cortes de media pulgada cerca del cierre.

Tazas y platos de papel

Sí. Úselos para calentar alimentos cocidos, y para cocinar alimentos que requieran corto tiempo de cocción, como los perros calientes. **No coloque tazas de papel en el microondas, pueden recalentarse y prenderse fuego.**



Toallas y servilletas

Sí, solo toallas/servilletas de papel. Úselas para calentar bocadillos y sándwiches, solo si tienen la etiqueta de Seguro para uso en microondas. NO utilice toallas de papel reciclado.



Papel de pergamino

Sí. Úselo como cubierta para evitar salpicaduras.

Vajilla de plástico

Sí, con precaución. Deberá tener la etiqueta “Adecuado para calentar en microondas”.



Verifique las instrucciones de los fabricantes de Seguridad para microondas, para ver los usos recomendados. Algunos recipientes de plástico seguros para microondas no son adecuados para cocinar alimentos con alto contenido de grasa o de azúcar. El calor de los alimentos calientes puede causar deformaciones.

Plástico, melamina

No. Este material absorbe la energía del microondas. ¡Los platos se CALIENTAN!

Tazas de espuma de plástico

Sí, con precaución. La espuma de plástico se derretirá si los alimentos llegan a una temperatura alta. Use a corto plazo solamente para recalentar alimentos a una baja temperatura para servirlos. **No coloque tazas de papel en el microondas, pueden recalentarse y prenderse fuego.**



Envoltorio plástico

Sí. Use para cubrir alimentos durante la cocción para retener la humedad y evitar salpicaduras. Deberá tener la etiqueta “Adecuado para calentar en microondas”. Verifique las indicaciones del paquete.



Paja, mimbre, madera

Sí, solo a corto plazo. Use solamente para recalentar a corto plazo alimentos a una baja temperatura para servirlos. La madera puede secarse, romperse o quebrarse.



Termómetros

Solo los termómetros seguros para microondas podrán usarse, NO los convencionales.



Papel encerado

Sí. Use como cubierta para evitar salpicaduras y conservar la humedad.



PRUEBA DEL RECIPIENTE

PARA EVALUAR SI UN RECIPIENTE ES SEGURO PARA SU USO EN HORNO DE MICROONDAS: Llene una taza segura para microondas con agua fría y colóquela en el horno de microondas junto con el recipiente vacío a evaluar; **caliente un (1) minuto a P10 (ALTA)**. Si el recipiente es seguro para uso en horno de microondas (transparente a energía de microondas), el recipiente vacío deberá permanecer frío y el agua deberá estar caliente. Si el recipiente está caliente, absorbió algo de la energía del microondas, y NO se debe usar. Esta prueba no se puede usar para recipientes de plástico.



Panasonic Consumer Electronics Company,
Division of Panasonic Corporation of North America
Two Riverfront Plaza
Newark, New Jersey 07102

Website: <http://shop.panasonic.com/support>