

Panasonic

LUMIX S9

Owner's Manual
<Quick Start Guide>
Digital Camera
DC-S9

Please read these instructions carefully before using this product, and save this manual for future use.

Owner's Manual <Complete Guide>



Refer to "Owner's Manual <Complete Guide>" (HTML format/PDF format) for details about how to use the camera and notes on use.

<https://panasonic.jp/support/dsc/oi/S9/index.html>

If you have any questions, visit
Canada : www.panasonic.ca/english/support

Panasonic Canada Inc.

5770 Ambler Drive, Mississauga, Ontario L4W 2T3
www.panasonic.com

© Panasonic Entertainment & Communication Co., Ltd. 2024

DVQX2518YA
F0424KN1084

PP Printed in China

Dear Customer,

Thank you for choosing Panasonic!

You have purchased one of the most sophisticated and reliable products on the market today. Used properly, we're sure it will bring you and your family years of enjoyment. Please take time to fill in the information below. The serial number is on the tag located on the underside of your camera. Be sure to **retain this manual** as your convenient camera information source.

Date of Purchase	Dealer Phone No.
Dealer Purchased From	Model No.
Dealer Address	Serial No.

Please note that the actual controls and components, menu items, etc. of your Digital Camera may look somewhat different from those shown in the illustrations in this Owner's Manual.

Information for Your Safety

WARNING:

To reduce the risk of fire, electric shock or product damage,

- Do not expose this unit to rain, moisture, dripping or splashing.
- Use the recommended accessories.
- Do not remove covers.
- Do not repair this unit by yourself. Refer servicing to qualified service personnel.

Product identification marking

Product	Location
Digital camera	Bottom

THE FOLLOWING APPLIES ONLY IN CANADA.

How to Display Certification and Compliance Information

Certification and compliance information for this camera can be viewed on the menu screen.

- 1 Select the [Others] tab of the [Setup] menu.
- 2 Select [Approved Regulations] and confirm your selection.

CAN ICES-003(B) / NMB-003(B)

Model : DC-S9

IC : 216A-DCS9

This device contains licence-exempt transmitter(s)/receiver(s) that comply with Innovation, Science and Economic Development Canada's licence-exempt RSS(s). Operation is subject to the following two conditions:

- (1) This device may not cause interference.
- (2) This device must accept any interference, including interference that may cause undesired operation of the device.

5150-5350 MHz band is restricted to indoor operations only.

The available scientific evidence does not show that any health problems are associated with using low power wireless devices. There is no proof, however, that these low power wireless devices are absolutely safe. Low power Wireless devices emit low levels of radio frequency energy (RF) in the microwave range while being used. Whereas high levels of RF can produce health effects (by heating tissue), exposure of low-level RF that does not produce heating effects causes no known adverse health effects. Many studies of low-level RF exposures have not found any biological effects. Some studies have suggested that some biological effects might occur, but such findings have not been confirmed by additional research. DC-S9 has been tested and found to comply with ISED radiation exposure limits set forth for an uncontrolled environment and meets RSS-102 of the ISED radio frequency (RF) Exposure rules.

About the battery pack

CAUTION

Battery pack (Lithium ion battery pack)

- Use the specified unit to recharge the battery pack.
- Do not use the battery pack with equipment other than the specified unit.
- Do not get dirt, sand, liquids, or other foreign matter on the terminals.
- Do not touch the plug terminals (+ and -) with metal objects.
- Do not disassemble, remodel, heat or throw into fire.

If any electrolyte should come into contact with your hands or clothes, wash it off thoroughly with water.

If any electrolyte should come into contact with your eyes, never rub the eyes. Rinse eyes thoroughly with water, and then consult a doctor.

CAUTION

- Danger of explosion if battery is incorrectly replaced. Replace only with the type recommended by the manufacturer.
- When disposing of the batteries, please contact your local authorities or dealer and ask for the correct method of disposal.

- Do not heat or expose to flame.
- Do not leave the battery(ies) in a car exposed to direct sunlight for a long period of time with doors and windows closed.
- Do not expose to low air pressure at high altitudes.
- Do not expose to extremely low air pressure, as this may result in explosions or leakage of flammable liquids and gases.

Warning

Risk of fire, explosion and burns. Do not disassemble, heat above 60 °C (140 °F) or incinerate.

- Always use a genuine Panasonic Tripod Grip (DMW-SHGR2: optional).
- Use a Premium High Speed HDMI micro cable (Type D–Type A plug) with the length less than 3 m (9.8 feet).
- Use a stereo microphone cable with the length less than 3 m (9.8 feet).
- Keep the accessory shoe cover out of reach of children to prevent swallowing.
- Keep the memory card out of reach of children to prevent swallowing.

Standard Accessories

Product numbers correct as of October 2024.

Digital camera body

Battery pack DMW-BLK22	Body cap ^{*1} 1HE1MC891Z
Shoulder strap DVPW1035Z	Accessory shoe cover ^{*1} DVKV1118Z/K (Black)

Interchangeable lens "LUMIX S 20-60mm F3.5-5.6"^{*2}

S-R2060	Lens hood 1ZE4SR2060Z	Lens rear cap ^{*4} RGE1Z276Z
	Lens cap ^{*4} CGE1Z293Z	

Interchangeable lens "LUMIX S 18-40mm F4.5-6.3"^{*3}

S-R1840	Lens cap ^{*4} 6GE1SR1840Z	Lens rear cap ^{*4} RGE1Z276Z
---------	--	---

*1 This is attached to the camera at the time of purchase.

*2 This is supplied with Lens Kit DC-S9K.

*3 This is supplied with Lens Kit DC-S9N.

*4 This is attached to the lens at the time of purchase.

- If any accessories are lost, customers in Canada should visit our support page at www.panasonic.ca/english/support for further information about obtaining replacement parts.

Names of Important Parts

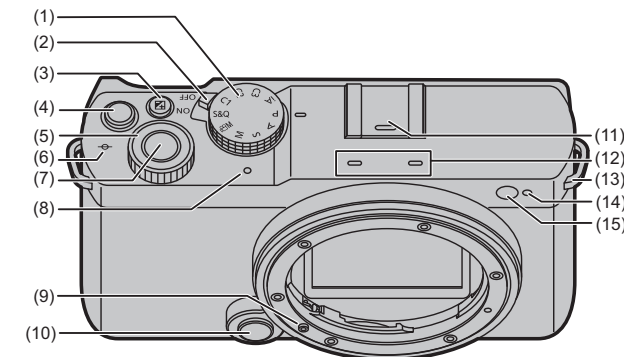

- (1) Mode dial
- (2) Camera on/off switch
- (3) [] (Exposure compensation) button
- (4) Video rec. button
- (5) Front dial
- (6) [] (Recording distance reference mark)
- (7) Shutter button
- (8) Charging light/Network connection light
- (9) Lens lock pin (Lens fitting mark)
- (10) Lens release button
- (11) Accessory shoe (accessory shoe cover)
- (12) Stereo microphone
- (13) Shoulder strap eyelet
- (14) Self-timer light/AF assist light
- (15) Illumination sensor

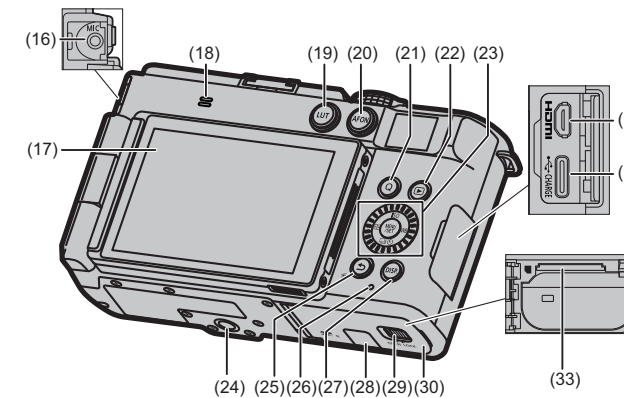

- (16) [MIC] socket
- (17) Monitor/Touch screen
- (18) Speaker
- (19) [LUT] button
- (20) [AF ON] button
- (21) [Q] (Quick menu) button
- (22) [] (Playback) button
- (23) Control dial ()
Cursor buttons
▲/[ISO] (ISO sensitivity)
▼/[] (Drive mode)
◀/[] (AF mode)
▶/[WB] (White balance)
[MENU/SET] button ()
- (24) Tripod mount
- (25) [] (Cancel) button/
[] (Delete) button
- (26) Card access light
- (27) [DISP.] button
- (28) DC coupler cover
- (29) Release lever
- (30) Card/Battery door
- (31) HDMI socket
- (32) USB port
- (33) Card slot

Attaching a Shoulder Strap

Attach a shoulder strap to the camera with the following procedure to prevent it from dropping.

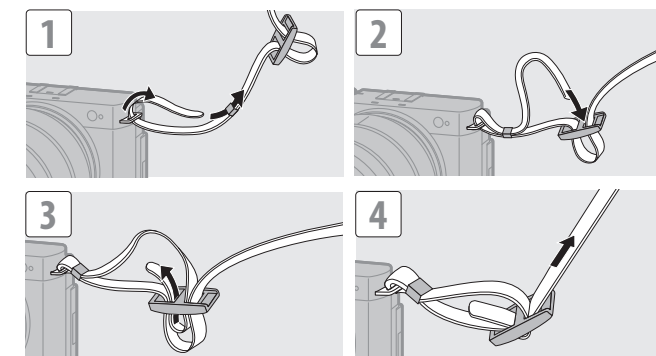

Charging the Battery

Charge using an AC adaptor (optional/commercially available) and a USB connection cable (commercially available).

- 1 Set the camera on/off switch to [OFF].
- 2 Insert the battery into the camera.

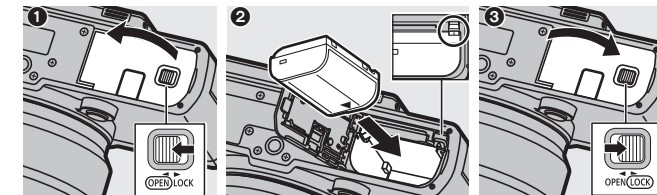

- 3 Connect the camera USB port and the AC adaptor using the USB connection cable.

- 4 Connect the AC adaptor to an electrical outlet.

- The charging light turns red and charging begins. The charging light turns off when charging is complete.

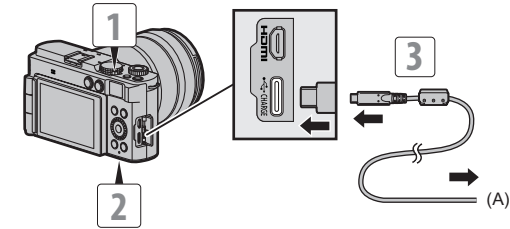

(A) To the AC adaptor

Charging time	Approx. 240 min
---------------	-----------------

- Using either the camera body and the optional AC Adaptor (DMW-AC11) or the camera body and the supplied accessories of the optional Battery Charger (DMW-BTC15).

Cautions

- The battery that can be used with the camera is DMW-BLK22. (As of May 2024)
- Always use genuine Panasonic batteries (DMW-BLK22).
- If you use other batteries, we cannot guarantee the quality of this product.
- It is recommended to use the Panasonic AC Adaptor (DMW-AC11: optional) or the supplied accessories of the Panasonic Battery Charger (DMW-BTC15: optional) for charging.
- You can charge with the camera body using a commercially available AC adaptor and a USB connection cable.
*Recommended specifications for the commercially available AC adaptor
 - Supports 5 V/3 A (15 W) DC output
 - USB Type-C terminal*Use a USB connection cable with 15 W output or better for charging.
- You can also use an AC adaptor with 5 V/500 mA or better for charging. However, charging time may be longer than with the recommended AC adaptor.
- Operation is not guaranteed with all commercially available devices.
- Using charging methods other than those specified may result in fluid leakage, overheating, combustion, rupturing, etc., and these may cause injury.
- This battery may present a risk of fire or chemical burn if mistreated.
- Place the removed battery in a plastic bag, and store or keep away from metallic objects (clips, etc.).
- When disposing of the batteries, please contact your local authorities or dealer and ask for the correct method of disposal.

Inserting Cards (Optional)

You can use SD memory cards with this camera.

- For information on memory cards with confirmed operation, check the following support site:
<https://panasonic.jp/support/global/cs/dsc/connect/index.html>
(English only)

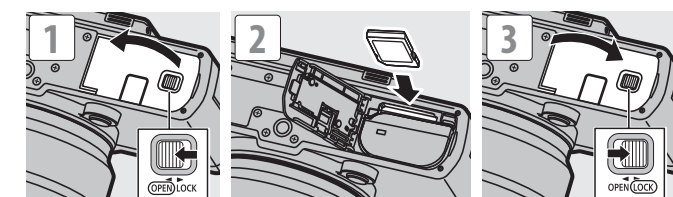

- Match the orientation of the cards as shown in the figure and then insert them firmly until they click.
- To remove a card, confirm that the corresponding card access light has turned off, push the card until it clicks, then pull the card out straight.
- Format the cards with the camera before use.
[] → [] → [] → Select [Card Format]

Attaching a Lens

The lens mount of this camera is compliant with the L-Mount standard of Leica Camera AG.

- Refer to catalogs/websites for information regarding supported lenses. <https://panasonic.jp/support/global/cs/dsc/connect/index.html> (English only)

Attaching commercially available accessories that do not comply with the L-Mount standard may lead to operation failure or malfunction of the camera.

If a failure or malfunction occurs due to this cause, the warranty will be void.

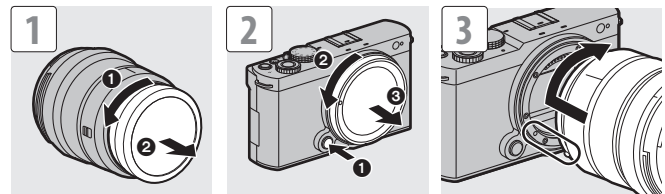

- When removing the lens or body cap, rotate while pressing the lens release button.

How to Extend/Retract the Lens [When the Interchangeable Lens (S-R1840) Is Attached]

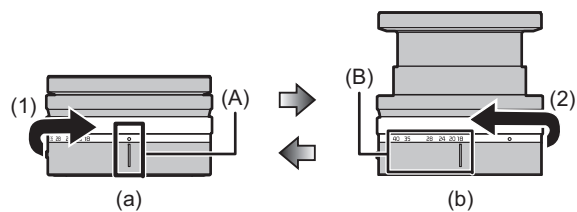

(a) Lens retracted

(b) Ready for recording

❖ How to Extend the Lens

Rotate the zoom ring in the direction of arrow (1) from position (A) (the lens is retracted) to position (B) (18 mm to 40 mm) to extend the lens.

- When the lens barrel is retracted, images cannot be recorded.

❖ How to Retract the Lens

Rotate the zoom ring in the direction of arrow (2) from position (B) (18 mm to 40 mm) to position (A) to retract the lens.

- At the 18 mm position, you will feel a click. Keep rotating to the (A) position.
- When you are not recording images, we recommend that you retract the lens.

- Attach and remove the lens only when the lens barrel is retracted.
- A message is displayed if the lens barrel is retracted and recording is not possible. Rotate the zoom ring to extend it.

Setting the Clock (When Turning On for the First Time)

When you turn the camera on for the first time, a screen to set the time zone and clock appears. Follow the message to make the settings.

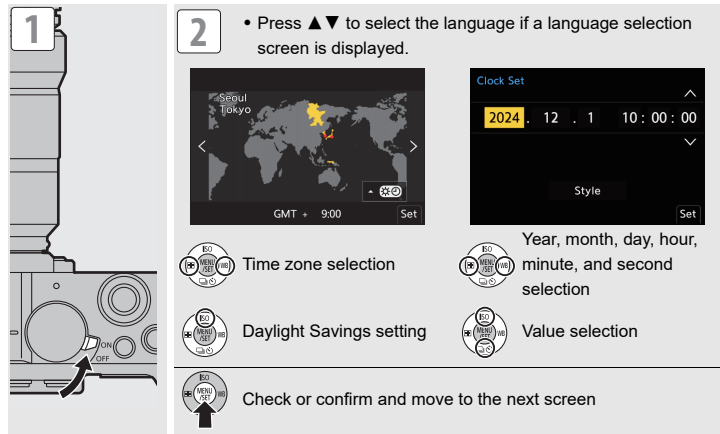

Taking Pictures

- Rotate the mode dial to select the recording mode ([iA]/[P]/[A]/[S]/[M]).
- Press the shutter button halfway (press it gently) to focus.
- Press the shutter button fully (press it further) to take pictures.

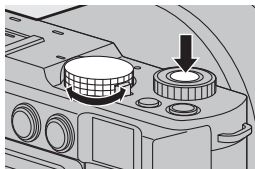

Recording Videos

- Rotate the mode dial to select the recording mode.
- Press the video rec. button to start recording.
- Press the video rec. button again to end recording.

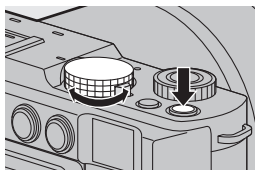

Playing Back Images

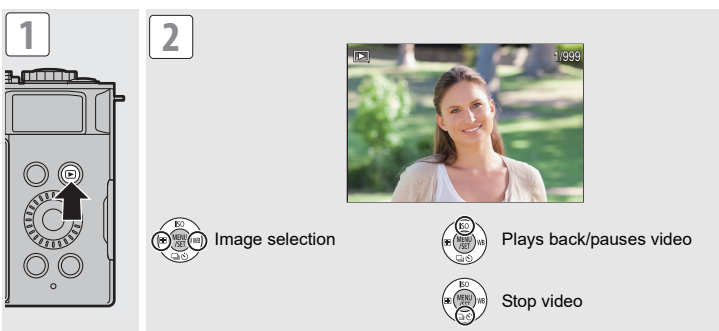

Cautions for Use

❖ Firmware of Your Camera/Lens

Firmware updates may be provided in order to improve camera capabilities or to add functionality.

- For the latest information on the firmware or to download/update the firmware, visit the following support site: <https://panasonic.jp/support/global/cs/dsc/download/index4.html> (English only)



❖ Handling of the Camera

The camera is not dust resistant, splash resistant, or waterproof.

Avoid using the camera in places with excessive dust or sand, or where water can come into contact with the camera.

❖ Be Sure to Perform Trial Recording in Advance

Be sure to perform trial recording in advance to check that recording can be performed normally.

Please note that compensation cannot be provided in the event that recording could not be performed due to a problem with the camera or a card.

❖ Be Careful with Regard to Copyrights

Under copyright law, you may not use the images and audio you have recorded without the permission of the copyright holder.

❖ Caution with Strong Light Beams Such as Laser Light

Do not allow strong light beams, such as laser light, to be directly exposed to this camera (lens). These can destroy the image sensor and cause the camera to malfunction.

❖ The camera

Keep this unit as far away as possible from electromagnetic equipment (such as microwave ovens, TVs, video games etc.).

- If you use this unit on top of or near a TV, the pictures and/or sound on this unit may be disrupted by electromagnetic wave radiation.
- Do not use this unit near cell phones because doing so may result in noise adversely affecting the pictures and/or sound.
- Recorded data may be damaged, or pictures may be distorted, by strong magnetic fields created by speakers or large motors.
- Electromagnetic wave radiation may adversely affect this unit, disturbing the pictures and/or sound.
- If this unit is adversely affected by electromagnetic equipment and stops functioning properly, turn this unit off and remove the battery or disconnect AC adaptor. Then reconnect the battery or reconnect AC adaptor and turn this unit on.

Do not use this unit near radio transmitters or high-voltage lines.

- If you record near radio transmitters or high-voltage lines, the recorded pictures and/or sound may be adversely affected.

❖ Wi-Fi® Function

Use of the Wi-Fi function of the camera is presumed to be in countries where it is sold.

There is the risk that the camera violates the radio wave regulations if used in countries other than those where it is sold, and Panasonic takes no responsibility for any violations.

- Please be advised that Panasonic is not liable for any damage directly or indirectly caused by use (including use in combination with the products of other companies) or malfunction of this product.
- Please be advised that Panasonic is not liable for any damage to data caused by this product.
- The external design and specifications of this product, as described in this document, may differ from the actual product due to improvements made.

Main Specifications

The specifications are subject to change for performance enhancement.

Digital camera body (DC-S9):

Information for your safety

Power source:	9.0 V ===
Power consumption:	3.9 W (when recording with the monitor), 3.3 W (when playing back with the monitor) [When using the interchangeable lens (S-R2060)] 4.0 W (when recording with the monitor), 3.4 W (when playing back with the monitor) [When using the interchangeable lens (S-R1840)]

Type	
Type	Digital Single Lens Mirrorless camera
Lens mount	Leica Camera AG L-Mount
Recording media	SD memory card / SDHC memory card / SDXC memory card
Image sensor	
Image sensor	35 mm full-frame (35.6 mm×23.8 mm) CMOS sensor, a total of approx. 25,300,000 pixels, primary color filter
Effective number of pixels of the camera	Approx. 24,200,000 pixels
Monitor	
Type	Aspect ratio 3:2, 3.0 inches, approx. 1,840,000 dots monitor, capacitive touch screen
Interface	
USB	USB Type-C®, USB 10Gbps
HDMI	HDMI Type D
[MIC]	∅3.5 mm stereo mini jack
External dimensions / Mass (Weight)	
External dimensions	Approx. 126.0 mm (W)×73.9 mm (H)×46.7 mm (D) (4.96" (W)×2.91" (H)×1.84" (D)) (excluding the projecting parts)
Mass (Weight)	Approx. 486 g/1.08 lb (camera body, with battery and card) Approx. 403 g/0.89 lb (only camera body)
Operating environment	
Recommended operating temperature	0 °C to 40 °C (32 °F to 104 °F)
Permissible relative humidity	10 %RH to 80 %RH

Wi-Fi	
Compliance standard	IEEE 802.11a/b/g/n/ac (standard wireless LAN protocol)
Frequency range used (central frequency)	2412 MHz to 2462 MHz (1 to 11ch) 5180 MHz to 5320 MHz (36/40/44/48/52/56/60/64ch) 5745 MHz to 5825 MHz (149/153/157/161/165ch)
Encryption method	Wi-Fi compliant WPA™ / WPA2™ / WPA3™
Access method	Infrastructure mode
Bluetooth®	
Compliance standard	Bluetooth v5.0, Bluetooth Low Energy (BLE)
Frequency range used (central frequency)	2402 MHz to 2480 MHz

Battery pack (lithium-ion) (Panasonic DMW-BLK22):

Information for your safety

Voltage/capacity:	7.2 V / 2200 mAh
--------------------------	------------------

The symbols on this product (including the accessories) represent the following:

=== DC

Trademarks and Licenses

- L-Mount is a trademark or registered trademark of Leica Camera AG.
- SDXC Logo is a trademark of SD-3C, LLC.
- The terms HDMI, HDMI High-Definition Multimedia Interface, HDMI Trade dress and the HDMI Logos are trademarks or registered trademarks of HDMI Licensing Administrator, Inc.

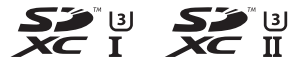

- USB Type-C® and USB-C® are registered trademarks of USB Implementers Forum.
- QuickTime and the QuickTime logo are trademarks or registered trademarks of Apple Inc., used under license therefrom.
- The Bluetooth® word mark and logos are registered trademarks owned by Bluetooth SIG, Inc. and any use of such marks by Panasonic Holdings Corporation is under license. Other trademarks and trade names are those of their respective owners.
- "Wi-Fi®" is a registered trademark of Wi-Fi Alliance®.
- "WPA™", "WPA2™", and "WPA3™" are trademarks of Wi-Fi Alliance®.
- QR Code is a registered trademark of DENSO WAVE INCORPORATED.
- Other names, company names, product names mentioned in this document are trademarks or registered trademarks of the companies concerned.



At least three (3) years from delivery of this product, Panasonic will give to any third party who contacts us at the contact information provided below, for a charge no more than our cost of physically performing source code distribution, a complete machine-readable copy of the corresponding source code covered under GPL V2.0 or LGPL V2.1, as well as the respective copyright notice thereof.

Contact Information: oss-cd-request@gg.jp.panasonic.com

The source code and the copyright notice are also available for free in our website below. <https://panasonic.net/cns/oss/index.html>

This product is licensed under the AVC Patent Portfolio License for the personal use of a consumer or other uses in which it does not receive remuneration to (i) encode video in compliance with the AVC Standard ("AVC Video") and/or (ii) decode AVC Video that was encoded by a consumer engaged in a personal activity and/or was obtained from a video provider licensed to provide AVC Video. No license is granted or shall be implied for any other use. Additional information may be obtained from MPEG LA, L.L.C. See <http://www.mpegla.com>

For the U.S.A. and Canada only

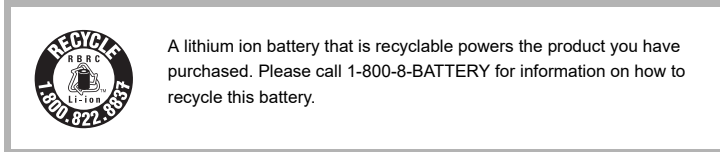

Limited Warranty (ONLY FOR CANADA)

Panasonic Canada Inc.

5770 Ambler Drive, Mississauga, Ontario L4W 2T3

PANASONIC PRODUCT – LIMITED WARRANTY

Panasonic Canada Inc. warrants this product to be free from defects in material and workmanship under normal use and for a period as stated below from the date of original purchase agrees to, at its option either (a) repair your product with new or refurbished parts, (b) replace it with a new or a refurbished equivalent value product, or (c) refund your purchase price. The decision to repair, replace or refund will be made by Panasonic Canada Inc.

Digital Camera	One (1) year, parts and labour
Digital Camera Peripherals	One (1) year, parts and labour
Digital Camera Accessories	Ninety (90) days, parts and labour

This warranty is given only to the original purchaser, or the person for whom it was purchased as a gift, of a Panasonic brand product mentioned above sold by an authorized Panasonic dealer in Canada and purchased and used in Canada, which product was not sold "as is", and which product was delivered to you in new condition in the original packaging.

IN ORDER TO BE ELIGIBLE TO RECEIVE WARRANTY SERVICE HEREUNDER, A PURCHASE RECEIPT OR OTHER PROOF OF DATE OF ORIGINAL PURCHASE, SHOWING AMOUNT PAID AND PLACE OF PURCHASE IS REQUIRED

LIMITATIONS AND EXCLUSIONS

This warranty ONLY COVERS failures due to defects in materials or workmanship, and DOES NOT COVER normal wear and tear or cosmetic damage. The warranty ALSO DOES NOT COVER damages which occurred in shipment, or failures which are caused by products not supplied by Panasonic Canada Inc., or failures which result from accidents, misuse, abuse, neglect, mishandling, misapplication, alteration, faulty installation, set-up adjustments, misadjustment of consumer controls, improper maintenance, improper batteries, power line surge, lightning damage, modification, introduction of sand, humidity or liquids, or rental use of the product, or service by anyone other than a Authorized Servicer, or damage that is attributable to acts of God.

Dry cell batteries, printer ink cartridge and paper are also excluded from coverage under this warranty. Rechargeable batteries are warranted for ninety (90) days from date of original purchase.

THIS EXPRESS, LIMITED WARRANTY IS IN LIEU OF ALL OTHER WARRANTIES, EXPRESS OR IMPLIED, INCLUDING ANY IMPLIED WARRANTIES OF MERCHANTABILITY AND FITNESS FOR A PARTICULAR PURPOSE. IN NO EVENT WILL PANASONIC CANADA INC. BE LIABLE FOR ANY SPECIAL, INDIRECT OR CONSEQUENTIAL DAMAGES RESULTING FROM THE USE OF THIS PRODUCT OR ARISING OUT OF ANY BREACH OF ANY EXPRESS OR IMPLIED WARRANTY. (As examples, this warranty excludes damages for lost time, travel to and from the Authorized Servicer, loss of or damage to media or images, data or other memory or recorded content. This list of items is not exhaustive, but for illustration only.)

In certain instances, some jurisdictions do not allow the exclusion or limitation of incidental or consequential damages, or the exclusion of implied warranties, so the above limitations and exclusions may not be applicable. This warranty gives you specific legal rights and you may have other rights which vary depending on your province or territory.

WARRANTY SERVICE

For product operation, repairs and information assistance, please visit our Support page: www.panasonic.ca/english/support