

Technics®



EAH-AZ60 EAH-AZ40

Digital Wireless Stereo Earphones
Owner's Manual

Thank you for purchasing this product.

Please read these instructions carefully before using this product, and save this manual for future use.

Register online at <http://shop.panasonic.com/support>
(U.S. customers only)

If you have any questions, visit:

In the U.S.A.:

<http://shop.panasonic.com/support>

In Canada:

www.panasonic.ca/english/support

IMPORTANT SAFETY INSTRUCTIONS

Read these operating instructions carefully before using the unit. Follow the safety instructions on the unit and the applicable safety instructions listed below. Keep these operating instructions handy for future reference.

- 1 Do not use this apparatus near water.
- 2 Protect the power cord from being walked on or pinched particularly at plugs, convenience receptacles, and the point where they exit from the apparatus.
- 3 Unplug this apparatus during lightning storms or when unused for long periods of time.
- 4 Refer all servicing to qualified service personnel. Servicing is required when the apparatus has been damaged in any way, such as power-supply cord or plug is damaged, liquid has been spilled or objects have fallen into the apparatus, the apparatus has been exposed to rain or moisture, does not operate normally, or has been dropped.
- 5 Clean only with dry cloth.

Safety precautions



A lithium ion battery that is recyclable powers the product you have purchased. Please call 1-800-8-BATTERY for information on how to recycle this battery.

For US and Canada only
Pour les É.-U. et le Canada seulement

THE FOLLOWING APPLIES ONLY IN THE U.S.A. AND CANADA.

This device complies with Part 15 of FCC Rules and Innovation, Science and Economic Development Canada's licence-exempt RSS(s). Operation is subject to the following two conditions:

- (1) this device may not cause interference, and
- (2) this device must accept any interference, including interference that may cause undesired operation.

EAH-AZ60

FCC ID: ACJ-EAH-AZ60

Model: EAH-AZ60

IC: 216A-EAHAZ60

EAH-AZ40

FCC ID: ACJ-EAH-AZ40

Model: EAH-AZ40

IC: 216A-EAHAZ40

This transmitter must not be co-located or operated in conjunction with any other antenna or transmitter.

(For the U.S.A. only)

This equipment complies with FCC radiation exposure limits set forth for an uncontrolled environment and meets the FCC radio frequency (RF) Exposure Guidelines as this equipment has very low levels of RF energy.

(For Canada only)

EAH-AZ60 and EAH-AZ40 have been tested and found to comply with ISED radiation exposure limits set forth for an uncontrolled environment and meet RSS-102 of the ISED radio frequency (RF) Exposure rules.

THE FOLLOWING APPLIES ONLY IN THE U.S.A.

FCC Note:

This equipment has been tested and found to comply with the limits for a Class B digital device, pursuant to Part 15 of the FCC Rules.

These limits are designed to provide reasonable protection against harmful interference in a residential installation. This equipment generates, uses, and can radiate radio frequency energy and, if not installed and used in accordance with the instructions, may cause harmful interference to radio communications.

However, there is no guarantee that interference will not occur in a particular installation. If this equipment does cause harmful interference to radio or television reception, which can be determined by turning the equipment off and on, the user is encouraged to try to correct the interference by one or more of the following measures:

- Reorient or relocate the receiving antenna.
- Increase the separation between the equipment and receiver.
- Connect the equipment into an outlet on a circuit different from that to which the receiver is connected.
- Consult the dealer or an experienced radio/TV technician for help.

FCC Caution:

Any unauthorized changes or modifications to this equipment would void the user's authority to operate this device.

This device complies with Part 15 of the FCC Rules. Operation is subject to the following two conditions:

- (1) This device may not cause harmful interference, and
- (2) this device must accept any interference received, including interference that may cause undesired operation.

Supplier's Declaration of Conformity

EAH-AZ60

Trade Name: Technics

Model No.: EAH-AZ60

Responsible Party: Panasonic Corporation of North America

Two Riverfront Plaza, Newark, NJ 07102-5490

Support Contact: <http://shop.panasonic.com/support>

EAH-AZ40

Trade Name: Technics

Model No.: EAH-AZ40

THE FOLLOWING APPLIES ONLY IN CANADA.

CAN ICES-3(B)/NMB-3(B)

■ Unit

WARNING:

To reduce the risk of fire, electric shock or product damage,

- **Do not expose this unit to rain, moisture, dripping or splashing.**
- **Use only manufacturer's recommended accessories.**
- **Do not remove covers.**
- **Do not repair this unit by yourself. Refer servicing to qualified service personnel.**

Avoid the use in the following conditions

- High or low extreme temperatures during use, storage or transportation.
 - Disposal of a battery into fire or a hot oven, or mechanically crushing or cutting of a battery, that can result in an explosion.
 - Extremely high temperature and/or extremely low air pressure that can result in an explosion or the leakage of flammable liquid or gas.
- Do not place this unit near a heat source.
 - Do not listen with this unit at high volume in places where you need to hear sounds from the surrounding environment for safety, such as at railroad crossings, and construction sites.
 - Keep this unit away from something susceptible to the magnetism. Such devices as a clock may not operate correctly.
 - Be aware that this unit (earphones) may get warm while charging or immediately after charging. Depending on your constitution and health status, putting the earphones on may trigger adverse reactions such as skin redness, itching, and rash if the earphones have just been taken out of the charging cradle and are still warm.

■ Built-in battery

- Do not heat or expose to flame.
- Do not leave the unit in a car exposed to direct sunlight for a long period of time with doors and windows closed.

■ Earphones/Earpieces

- Keep the earphones and the earpieces out of reach of children and pets to prevent swallowing. After use, put them in the charging cradle and close the lid for storage.
- Securely attach the earpieces. If they are left in the ears after coming off, injury or sickness may be caused.

- Keep the earphones clean. After use, make sure there is no earwax, foreign matter, etc., attached to the earpieces. If there is earwax, foreign matter, etc., attached, remove the earpieces from the earphones and clean them. (→ 37, “Earpiece cleaning”)
 - If you clean the earpieces (B) while they are attached to the earphones, you may damage the protective mesh on the earphones (A).
 - Remove earwax, foreign matter, etc., that has attached to the protective mesh of the earphones by blowing on it, etc. You may block the protective mesh if you try to remove with a cotton swab, etc., which can lead to malfunctions.
 - If hair styling product, make-up, etc., gets onto the earphones, wipe off immediately with a soft dry cloth. (Do not touch the protective mesh as this can have an effect on audio characteristics.)
- Store the earphones in the charging cradle to protect them from foreign matter, etc., getting on them.
- Keep your ears clean. Earwax and other foreign matter attached to the holes of the earpieces can change the acoustic characteristics, such as making the sound smaller, and also be the cause of malfunctions.

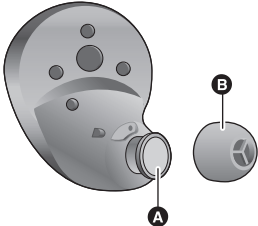

■ Allergies

- Discontinue use if you experience discomfort with the earphones or any other parts that directly contact your skin.
- Continued use may cause rashes or other allergic reactions.

■ Precautions for listening with the Earphones

- Excessive sound pressure from earphones and headphones can cause hearing loss.
- Do not use your earphones at a high volume. Hearing experts advise against continuous extended play.
- If you experience a ringing in your ears, reduce volume or discontinue use.
- Do not use while operating a motorized vehicle. It may create a traffic hazard and is illegal in many areas.
- You should use extreme caution or temporarily discontinue use in potentially hazardous situations.

This unit may receive radio interference caused by mobile telephones during use. If such interference occurs, please increase separation between this unit and the mobile telephone.

Use only the supplied USB charging cord when connecting to a computer.

The symbols on this product (including the accessories) represent the following: --- DC



Conforms to
UL STD 62368-1.
Certified to CAN/CSA STD
C22.2 No.62368-1.
Conforme à la norme CAN/CSA
C22.2 No.62368-1.

About Bluetooth®

Panasonic bears no responsibility for data and/or information that is compromised during a wireless transmission.

■ Frequency band used

This unit uses the 2.4 GHz frequency band.

■ Certification of this unit

- This unit conforms to frequency restrictions and has received certification based on frequency laws. Thus, a wireless permit is not necessary.
- The actions below are punishable by law in some countries:
 - Taking apart/modifying this unit.
 - Removing specification indications.

■ Restrictions of use

- Wireless transmission and/or usage with all Bluetooth® equipped devices is not guaranteed.
- All devices must conform to standards set by Bluetooth SIG, Inc.
- Depending on the specifications and settings of a device, it can fail to connect or some operations can be different.
- This unit supports Bluetooth® security features. But depending on the operating environment and/or settings, this security may not be sufficient. Transmit data wirelessly to this unit with caution.
- This unit cannot transmit data to a Bluetooth® device.

■ Range of use

Use this unit at a maximum range of 10 m (33 ft).

The range can decrease depending on the environment, obstacles or interference.

■ Interference from other devices

- This unit may not function properly and troubles such as noise and sound jumps may arise due to radio wave interference if this unit is located too close to other Bluetooth® devices or the devices that use the 2.4 GHz band.
- This unit may not function properly if radio waves from a nearby broadcasting station, etc. is too strong.

■ Intended usage

- This unit is for normal, general use only.
- Do not use this system near an equipment or in an environment that is sensitive to radio frequency interference (example: airports, hospitals, laboratories, etc).

Notes on LDAC

EAH-AZ60

The LDAC setting of this unit is disabled at the time of purchase. Enable the setting to enjoy LDAC. The LDAC setting can be changed with the “Technics Audio Connect” app (free of charge).^{*1}

(Set in [Settings] → [Connection mode setting] on the app. Follow the on-screen instructions to operate.)

The audio codec settings on the playback device may also need to be changed.^{*2}

*1 When playing back music on a device on which you cannot install the “Technics Audio Connect” app, change the LDAC settings of this unit on another Bluetooth® device on which the app has been installed.

*2 Refer to the operating instructions of the playback device for details.

Note

- This unit complies with the “High Resolution Audio” standard of the Japan Audio Society.
- To enjoy wireless high-resolution quality (sound quality certified by the High-Res Audio Wireless logo), use a playback device with the High-Res Audio Wireless logo and set the Bluetooth® sound quality setting to sound quality priority mode / LDAC 990 kbps.
- In modes other than the above (connection priority mode, etc.), playback may not be possible with high resolution quality.

Table of contents

IMPORTANT SAFETY INSTRUCTIONS	2
Safety precautions	2
About Bluetooth®	6
Notes on LDAC	7

Before use

Accessories	9
Maintenance	9
(Important) About water resistance	10
How to fit the earphones	11
• How to fit the earphones	11
• Tips for better sound quality (Changing earpieces)	12
Part names	13

Preparation

Charging	15
• Using the USB charging cord (supplied) to charge the earphones and the charging cradle	15
• Charging the earphones with the charging cradle	16
• Battery level notification	17
Turning the earphones on and off	19
Install the app “Technics Audio Connect”	20
Connecting a Bluetooth® device	21
• Connecting by pairing (registering) your earphones with a Bluetooth® device	21
• Connecting a paired Bluetooth® device	22

Operation

Listening to music	23
Making a phone call	24
Using the external sound control	25
Useful functions	26
• Using the app “Technics Audio Connect”	26
• Activating voice functions	26
• Creating multi-point connections	27
• Using just one earphone	27
Operating with the touch sensors	28

Other

Restoring to the factory settings	29
Copyright, etc.	30
Troubleshooting	31
• Sound and audio volume	31
• Bluetooth® device connection	31
• Phone Calls	31
• General	32
• Power supply and charging	32
Specifications	33
When disposing of the product	36
Earpiece cleaning	37
Useful information (Only for Latin American countries)	40

Expressions used in this document

- Pages to be referred to are indicated as “→ ○○”.
- The product illustrations may differ from the actual product.
- Unless otherwise indicated, illustrations in these operating instructions are of EAH-AZ60.

Marks denoting model names

- Functionality differences between models are indicated with the model marks below.

EAH-AZ60: EAH-AZ60 EAH-AZ40: EAH-AZ40

Accessories

Please check and identify the supplied accessories.

To order accessories, contact the dealer from whom you have made your purchase.

1 x USB charging cord

(Input Plug: USB Type-A Shape, Output Plug: USB Type-C Shape)

EAH-AZ60

1 x Earpieces set (2 each of sizes XS1, XS2, S1, S2, M, L, and XL) (M size fitted to the earphones)

- There are two types each for sizes XS and S. Use the type that yields the best noise cancelling effect.

EAH-AZ40

1 x Earpieces set (2 each of sizes XS, S, M, and L) (M size fitted to the earphones)

Only for U.S.A.:

To order accessories, refer to “Limited Warranty”.

Maintenance

Clean this unit with a dry and soft cloth.

- When the unit is very dirty, wipe off the dirt with a cloth that has been dipped in water and well wrung, then wipe with a dry cloth.
- Do not use solvents including benzine, thinner, alcohol, kitchen detergent, a chemical wiper, etc. This might cause the exterior case to be deformed or the coating to come off.
- Wipe off dust from the charging terminals with a soft, dry cloth. Do not use pointy objects.

Remove the earpieces from the earphones and get rid of earwax, foreign matter, etc.

- If you clean the earpieces while they are attached to the earphones, you may damage the protective mesh on the earphones. (Do not touch the protective mesh as this can have an effect on audio characteristics.)

Keeping the battery performance

- During the long period of disuse, full charge this unit once every 6 months to keep the battery performance.

(Important) About water resistance

Specifications for this unit are equivalent of IPX4 of IEC 60529, the protection level of electronic device enclosures that protects from splashes, and is not designed to be totally waterproof.

■ About IPX4 (liquid ingress protection level against splashing water)

This unit is compatible to operate after splashing from nozzles approximately 1.8 L/min (0.5 gal/min) of room temperature tap water from every direction approximately 20 cm (8 in) from this unit for 10 minutes.

The charging cradle and the USB charging cord (supplied) are not water resistant.

Water resistance is not guaranteed under all conditions.

■ Cautions for use in places where the unit may get wet (from spray, rain, etc.)

Observe the following precautions. Incorrect operation cause malfunction.

- Do not charge the charging cradle or the earphones while your hands are wet or while there are still water droplets on this unit (earphones or charging cradle).
- Do not use the USB charging cord.
- Do not apply soapy water or detergent or immerse in water.
- If water drops get onto the unit in cold climates, wipe off with a soft, dry cloth.
- If water gets onto the earphones or microphone, wipe off with a soft, dry cloth.
 - Sound may get smaller or get distorted.
 - If there are water drops left in the earpieces, you may hear the sound at reduced volume or you may not be able to hear anything at all. If this is the case, remove the earpieces and get rid of the water drops.

**If water does get into the earphones or the charging cradle, cease use and consult your dealer.
Malfunction due to improper handling by you will not be covered by the warranty.**

How to fit the earphones

Fit the earphones correctly in order to get adequate noise cancelling effect and acoustics. Select and fit the special earpieces that suit the sizes of your ears, left and right.

How to fit the earphones

1 Check the orientation and L (left) and R (right) of the earphones.

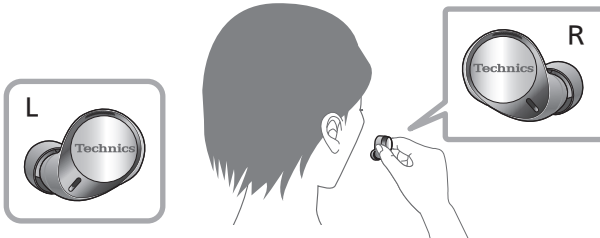

2 Fit the earphones firmly as per the illustration.



- Confirm that the earphones will not fall from your ears after you have fitted them.
 - The left earphone has a raised dot indicating the L side.
 - If the earphones fall out easily, replace with earpieces (supplied) of a different size.
- For information on how to remove and fit the earpieces, refer to “Tips for better sound quality (Changing earpieces)”.
(→ 12)

Tips for better sound quality (Changing earpieces)

Properly fit earpieces are essential for optimal sound and noise cancellation (**EAH-AZ60** only). Choose the size that fits snugly in your ears.

(The earpiece size that fits best may be different for the left and right ears.)

How to remove the earpieces

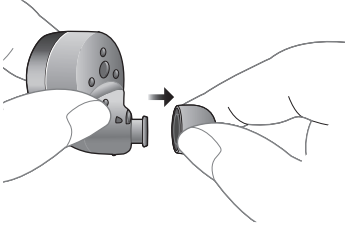

- Hold the earpiece with your fingertips and twist slightly to pull it out.

How to attach the earpieces

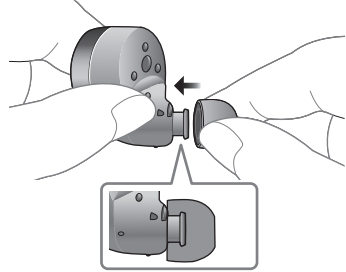

- Make sure the earpieces are fitted firmly into your ears and confirm that they are not at an angle.

Part names

Main unit (earphones)

("Earphones" hereafter in the instructions)

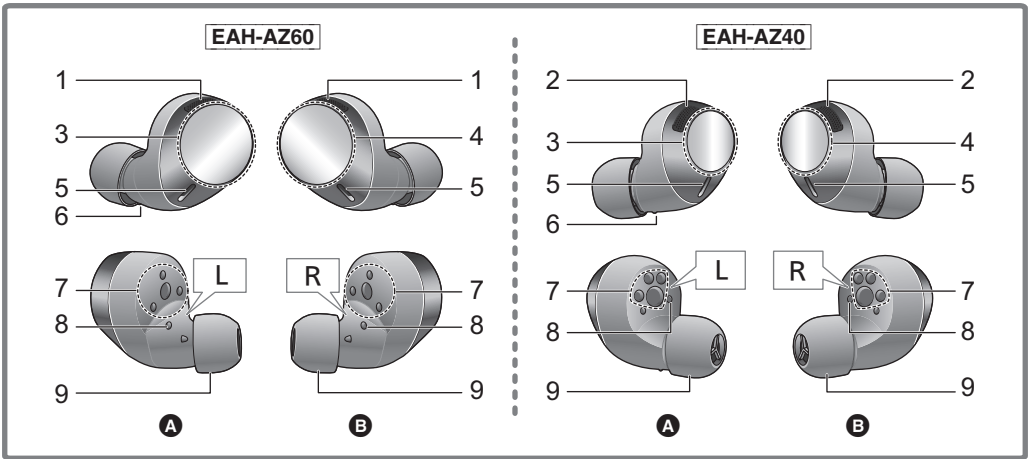

A L side earphone (left)

B R side earphone (right)

1 **EAH-AZ60** Microphone for noise cancelling

2 **EAH-AZ40** Microphone for external sounds

3 Touch sensor (L) (left)

4 Touch sensor (R) (right)

- Touching these enables you to perform a variety of operations. (→ 28, "Operating with the touch sensors")

5 Microphones for calls

6 Raised dot indicating the L side

7 Charging terminals

8 Earphone LEDs^{*1}

9 Earpieces

*1 Examples of earphone LED lighting/blinking patterns

Both earphone LEDs (L and R) blink alternately in blue and red	Bluetooth® pairing (registration) standby
Blinking slowly (blue) ^{*2}	Bluetooth® connection standby
Blinking twice about every 5 seconds (blue) ^{*2}	When connected with Bluetooth® (playing back music/in a call, etc.)
Blinking (blue) ^{*2}	A call is being received

*2 The battery is low when it is blinking in red. (→ 17, "Battery level notification")

Main unit (charging cradle)

("Charging cradle" hereafter in the instructions)

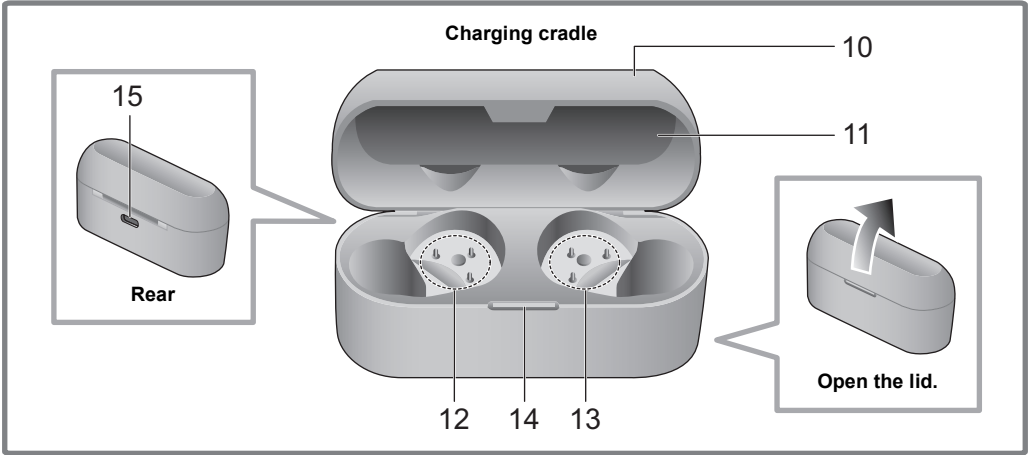

10 Charging cradle lid

11 Certification information label

- The model number is shown on the certification information label.

12 Terminal section (for the L side earphone)

13 Terminal section (for the R side earphone)

- Do not touch the terminal sections with bare hands.

14 Charging cradle LED*³

15 Charging terminal

- Connect the USB charging cord (supplied) to this terminal when charging. (→ 15, "Charging")

*3 Refer to page 15 - 18 for information about the earphone LEDs lighting and blinking during charging.

Charging

The rechargeable battery (installed in the unit) is not charged initially. Charge the battery before using the unit.

- Proper charging is not possible if there is dust or droplets of water on the charging terminal and the terminal sections of the earphones or charging cradle. Remove the dust or water droplets before charging.

Note

- Charge in a room temperature between 10 °C and 35 °C (50 °F and 95 °F).
- While the earphones are in the charging cradle and charging, it is not possible to turn the earphone power on or connect to Bluetooth® devices.

Using the USB charging cord (supplied) to charge the earphones and the charging cradle

When the earphones have not been put into the charging cradle, the charging cradle itself is charged.

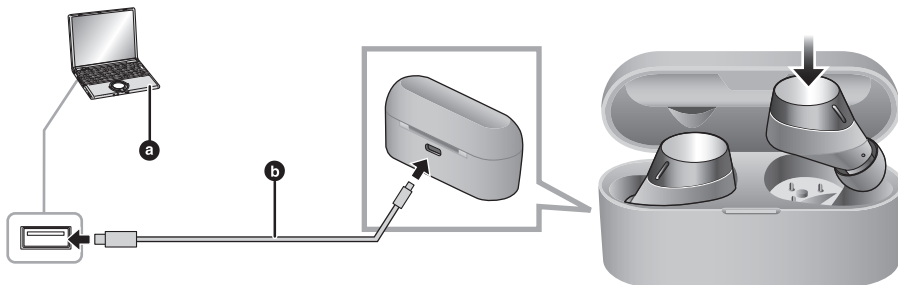

- a**: Power source (ex. PC)
- b**: USB charging cord (supplied)

1 Use the USB charging cord (supplied) to connect the charging cradle to a 5.0 V power source (500 mA or higher).

- Charging cradle starts charging:
 Battery fully charged: The charging cradle LED lights off.
 Battery not charged: The charging cradle LED lights (green, yellow or red).
- Check the direction of the USB charging cord terminals and plug in/out straight holding onto the plug. (It may result in malfunction by the deforming of the terminal if it is plugged in obliquely or in wrong direction.)

2 Put the earphones into the charging cradle.

- Confirm the L side and R side of the earphones, and match the positions of the charging terminals on the earphones with the terminal sections in the charging cradle. (Charging of the earphones will not start if the positions do not match.)
- When the earphones are inserted, the charging cradle LED (cyan) flashes twice. If it is not flashing, the earphones are not inserted correctly.

3 Confirm that the charging cradle LED (cyan) has flashed. (charging starts)

- While charging the earphones, the charging cradle LED (cyan) flashes when the lid of the charging cradle is opened.
- While charging the cradle, the charging cradle LED (green, yellow or red) lights when the lid of the charging cradle is closed.
- **Charging time (The time required to charge the batteries from empty to full)**

Earphones	Approx. 2 hours
Charging cradle	Approx. 2.5 hours
Earphones with Charging cradle	EAH-AZ60 Approx. 3.5 hours
	EAH-AZ40 Approx. 3 hours

Note

- Do not use any other USB charging cords except the supplied one. Doing so may cause malfunction.
- Charging may not be performed or may stop if the computer is in or switched to standby or sleep mode.

Charging the earphones with the charging cradle

Earphones can only be charged with a charged charging cradle. You can charge your earphones while you are out, even if there is no power source.

- When the charging cradle is fully charged, it can charge the earphones about 2 times.

1 Put the earphones into the charging cradle.

- When the earphones are inserted, the charging cradle LED (cyan) flashes twice. If it is not flashing, the earphones are not inserted correctly.

2 Confirm that the charging cradle LED (cyan) has flashed. (charging starts)

- While charging the earphones, the charging cradle LED (cyan) flashes about 4 seconds when the lid of the charging cradle is opened.
- It takes approx. 2 hours to charge the earphones from empty to full.

Battery level notification

The LEDs lighting or flashing on this unit indicate the remaining battery charge.

■ Earphones

When the battery level starts to run low while you are using the earphones, the blinking earphone LEDs change from blue to red, then you will be notified by one beep every 5 minutes. When no charge remains, you will hear a guidance message and then the unit automatically turns off.

■ Charging cradle

When you open the charging cradle lid, the charging cradle LED light or blink for about 4 seconds to indicate the charge remaining in the battery.

- If the charging cradle LEDs do not light even when you open the charging cradle lid, there is no charge in the battery. Charge the unit.

When charging with the USB charging cord with the earphones stored in the charging cradle

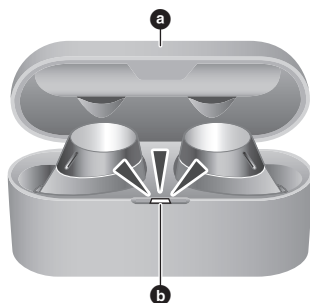

- a: Lid
- b: LED

Charging cradle		Charging status
LED	Lid	
Cyan*1	Open	Charging the earphones
Lights off	Close / Open	Earphones and charging cradle's batteries are full.
Green		Charging the charging cradle There is plenty of charge in the battery.
Yellow		
Red		

*1 Blinking

When charging with the USB charging cord with the earphones outside the charging cradle

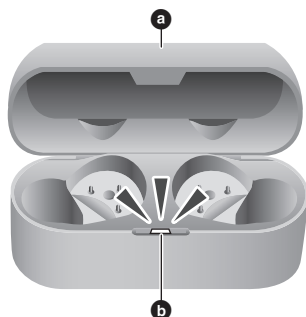

- a: Lid
- b: LED

Charging cradle		Charging status
LED	Lid	
Lights off	Close / Open	Charging cradle's battery is full.
Green		Charging the charging cradle There is plenty of charge in the battery.
Yellow		
Red		

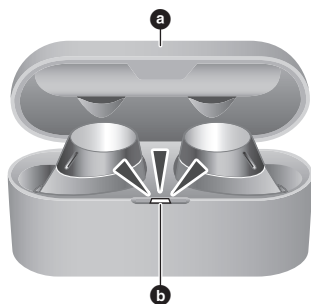
When charging with the earphones stored in the charging cradle (USB charging cord not connected)

- a**: Lid
b: LED

Charging cradle		Charging status
LED	Lid	
Cyan*2, 3	Open	Charging the earphones
Green*3		There is plenty of charge in the charging cradle.
Yellow*3		
Red*3		The charge in the charging cradle is running low.

*2 Blinking

*3 The charging cradle LED lights or blinks for about 4 seconds when you open the charging cradle lid, and then goes out.

Turning the earphones on and off

■ To turn the earphones on

Take the earphones out of the charging cradle.

- The earphones turn on. A beep will sound and the earphone LEDs blink (blue)* slowly.
 - * The batteries are low when they are blinking in red.

■ To turn the earphones off

Put the earphones into the charging cradle.

- When the earphones are inserted, the charging cradle LED (cyan) flashes twice. If it is not flashing, the earphones are not inserted correctly.



Note

- If something with a magnet in it is brought close to the earphones while they are being used, the earphones may turn off. Move the item with the magnet in it away if this occurs.

Install the app “Technics Audio Connect”

By creating a Bluetooth® connection with a smartphone or tablet installed with the “Technics Audio Connect” app (free of charge), you can enjoy a wide variety of features, such as the following:

- Software updates
- Change the operating button of touch sensor (Customization of touch sensor)
- Customization of various settings (Connection mode setting/Auto power off setting/Guidance language setting, etc.)
- “Switch/Find headphones” function
- Check remaining battery charge
- Access to this document

Preparation

- Turn on the unit.

1 Download the “Technics Audio Connect” app (free of charge) to the smartphone or tablet.



Android:
Google Play



iOS:
App Store



2 Start up the “Technics Audio Connect” app.

- Follow the on-screen instructions to operate.

Note

- Always use the latest version of the “Technics Audio Connect” app.
- There may sometimes be changes made to the operating procedures, displays, etc., on the “Technics Audio Connect” app. Refer to the support site for details.

Connecting a Bluetooth® device

Preparation

- Put the earphones into the charging cradle.
- Place the Bluetooth® device within approx. 1 m (3.3 ft) from the unit.
- Check the device operation using its operation instructions as required.
- Using the “Technics Audio Connect” app (free of charge) makes connecting with Bluetooth® simple.

Connecting by pairing (registering) your earphones with a Bluetooth® device

1 Take both earphones (L and R) out of the charging cradle.

- When pairing with a device for the first time:
This unit will start to search for a Bluetooth® device to connect to, and the earphone LEDs will light alternately in blue and red.
- When pairing with a device after the first time:
Both earphones should be placed temporarily in the charging cradle for 10 seconds.
After that remove them from the cradle and within 5 seconds while the earphone LED lights (blue), touch and hold the sensor (L or R) for 7 seconds until the LED starts flashing Red/Blue, indicating that you have entered the pairing mode.

2 Turn on the Bluetooth® device and enable the Bluetooth® function.

3 From the Bluetooth® menu of the Bluetooth® device, select device name “EAH-AZ60” or “EAH-AZ40”.

- A BD address (Bluetooth® Device address: an alphanumeric character string that is displayed by and unique to the device) may be displayed before “EAH-AZ60” or “EAH-AZ40” is displayed.
- If prompted for a passkey, input the passkey “0000 (four zeros)” of this unit.
- When the earphone LEDs blink (blue)* twice at approximately 5 second intervals, pairing has been completed and connection has been established.
* The batteries are low when they are blinking in red.

e.g. **EAH-AZ60**

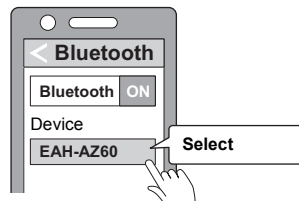

4 Confirm that the earphones and the Bluetooth® device are connected.

Note

- It is easier to pair if you disable the Bluetooth® function of the first device when pairing with a device after the first.
- When pairing with a device after the first time, if the connection with the device does not complete within 5 minutes, the pairing mode on the earphones cancels and they transition to connection standby mode. Perform pairing again.
- You can pair a maximum of 10 Bluetooth® devices with the earphones. When you pair a device after the maximum has been exceeded, previous devices are overwritten. To use overwritten devices again, do the pairing again.

Connecting a paired Bluetooth® device

- 1 Take the earphones out of the charging cradle.**
 - The earphone LEDs light (blue) and the earphones turn on about 4 seconds later. A beep will sound, and the earphone LEDs (blue)* will blink slowly.
 - * The batteries are low when they are blinking in red.
- 2 Do Steps 2 to 3 of “Connecting by pairing (registering) your earphones with a Bluetooth® device” (→ 21).**
- 3 Confirm that the earphones and the Bluetooth® device are connected.**

Note

- This unit remembers the device lastly connected. Connection may be automatically established after step 1 (see above).
- The unit can connect to a maximum of two Bluetooth® devices at the same time. (→ 27, “Creating multi-point connections”)

Listening to music

If the Bluetooth® compatible device supports the “A2DP” and “AVRCP” Bluetooth® profiles, music can be played back with remote control operations on the unit.

- A2DP (Advanced Audio Distribution Profile): Transmits audio to the unit.
- AVRCP (Audio/Video Remote Control Profile): Allows remote control of the device using the unit.

1 Connect the Bluetooth® device and the unit. (→ 21, “Connecting a Bluetooth® device”)

2 Select and play the music or the video on the Bluetooth® device.

- The unit's earphones will output the music or the audio of the video being played back.
- For operating procedures during music playback (→ 28, “Operating with the touch sensors”)
- Operating time may become shorter depending on the usage conditions.

■ Attention

- The unit might leak sound depending on the volume level.
- When the volume is increased to near maximum level, music may sound distorted. Decrease the volume until the distortion is cleared.

Making a phone call

With Bluetooth® enabled phones (cell phones or smartphones) that support the “HSP” or “HFP” Bluetooth® profile, you can use the unit for phone calls.

- **HSP (Headset Profile):**

This profile can be used to receive monaural sounds and establish two-way communication using the microphone on the unit.

- **HFP (Hands-Free Profile):**

In addition to the HSP functions, this profile has the incoming and outgoing calls function.

(This unit does not have a function that allows you to make phone calls independently of a Bluetooth® enabled phone.)

1 Connect the Bluetooth® device and the unit. (→ 21, “Connecting a Bluetooth® device”)

2 Touch a touch sensor (L or R) on the earphone once to answer an incoming call.

- During an incoming call, ringtone will sound from the unit and the earphone LEDs will blink.
- (HFP only) To reject a phone call, touch and hold a touch sensor (L or R) for about 2 seconds.

3 Start talking.

- The earphone LEDs will repeatedly blink 2 times during a call.
- To mute the voice during a call, touch the touch sensor (R) twice.
(To cancel muting, touch the touch sensor (R) twice again while muting.)
- To switch the noise level of the other party during a call, touch the touch sensor (R) 3 times.
Voices will be easier to hear when you reduce the audio noise from the other party.
This function is effective in reducing the noise heard from continuous sources (ventilation fans, etc.) in the vicinity of the other party.
- The volume can be adjusted during a phone call.
For operating procedures (→ 28, “Operating with the touch sensors”)

4 Touch and hold an earphone touch sensor (L or R) for about 2 seconds to end the call.

Note

- There may be instances when hands free setting needs to be done on the Bluetooth® enabled phone.
- Depending on the Bluetooth® enabled phone, you may hear incoming and outgoing call ringtones of the phone from the unit.
- You can have the Bluetooth® enabled phone make phone calls by using the microphone of the unit and an app of the Bluetooth® enabled phone. (→ 26, “Activating voice functions”)

Using the external sound control

The external sound control function switches between Noise cancelling and Ambient sound.

1 While wearing the earphones, touch and hold the touch sensor (R) for about 2 seconds.

- The mode is switched each time you touch and hold the touch sensor. (A guidance message will notify you of the mode you switched to.)

EAH-AZ60



- The default level setting is "Noise cancelling".
- When the "Technics Audio Connect" app is used, you can set to "Ambient sound OFF".

EAH-AZ40



- The default level setting is "Ambient sound OFF".

2 Adjust the volume of the playback device.

■ Noise cancelling (**EAH-AZ60** only)

Reduces the sounds (noise) you can hear from outside.

- Noise cancelling can be optimised with the "Technics Audio Connect" app. Adjust it beforehand to achieve the best condition.
- While using the noise cancelling function, a very small amount of noise which is generated from the circuit that reduces noise may be heard, but this is normal and not indicative of any trouble. (This very-low-level noise may be heard in quiet places or in the blank parts between tracks.)

■ Ambient sound

You can hear ambient sound through the microphones embedded in the earphones while enjoying music.

Useful functions

Using the app “Technics Audio Connect”

By creating a Bluetooth® connection with a smartphone installed with the “Technics Audio Connect” app (free of charge), you can enjoy a wide variety of features, such as changing the settings on the earphones. (→ 20)

Activating voice functions

You can use a touch sensor on the earphone to activate the voice functions (Amazon Alexa, Siri etc.) on your smartphone or similar device.

- 1 Connect the Bluetooth® device and the unit. (→ 21, “Connecting a Bluetooth® device”)**
- 2 Touch and hold the touch sensor (L) on the earphone until the voice function is activated.**

- The voice assistant function on the Bluetooth® device is activated.

Note

- For details about voice function commands, refer to the operating instructions for the Bluetooth® device.
- The voice function may not work depending on the smartphone, etc., specifications and the app version.

After doing Step 1 above, complete the setup below to use Amazon Alexa as your voice assistant.

- 1 In the “Technics Audio Connect” app, select Amazon Alexa as your voice assistant.
 - 2 Touch the “Sign in with Amazon” button.
 - After signing into Amazon, you will need to add headphones in the device setup.
- Install the latest version of the Amazon Alexa app.
 - Alexa is not available in all languages and countries. Alexa features and functionality may vary by location.
 - For more details, refer to the manuals or similar support materials of the apps.

Creating multi-point connections

A maximum of two Bluetooth® devices can be connected at the same time.

For information about the connection and registration of Bluetooth® devices and the unit (→ 21, “Connecting a Bluetooth® device”)

- 1 Pair this unit with each of the Bluetooth® devices.**
- 2 Connect the first Bluetooth® device and the unit.**
- 3 Connect the second Bluetooth® device and the unit.**

Note

- For more details, including more specific setup instructions, refer to the operating instructions for the Bluetooth® devices.
- This may not work with some apps and software.

Using just one earphone

By pairing (registering) this unit, you can also use just one of the earphones independently.

For example, if you take just the R side earphone out and leave the L side earphone in the charging cradle, the R side earphone will connect to the smartphone. This way, you can listen to music or make a call with one earphone while charging the other. (→ 21, “Connecting a Bluetooth® device”) The sound will be monaural.

- When you are using just one of the earphones, taking the other earphone out of the charging cradle will automatically connect the earphones wirelessly with each other and switch use to both earphones. The sound will be stereo.

Operating with the touch sensors

You can operate the touch sensors on the earphones to change to the Bluetooth® pairing mode, or remote control the Bluetooth® device.

- Depending on the Bluetooth® device or the app, even if you operate the touch sensors on the earphones, some functions may not respond or may operate differently from the descriptions below.

■ List of operations available with the touch sensors

Function	Touch sensor (L)	Touch sensor (R)
Listening to music		
Playback/pause	Touch once	
Raise the volume	Touch rapidly 3 times	–
Lower the volume	Touch rapidly 2 times	–
Forward a track	–	Touch rapidly 2 times
Back a track	–	Touch rapidly 3 times
Making a phone call		
Receive a phone call	Touch once while receiving the call	
Raise the volume	Touch rapidly 3 times	–
Lower the volume	Touch rapidly 2 times	–
Mute the voice of the call*1	–	Touch rapidly 2 times during the call
Switch the noise level heard from the other party	–	Touch rapidly 3 times during the call
Reject a phone call	Touch and hold for about 2 seconds while receiving the call	
End a phone call	Touch and hold for about 2 seconds during the call	
Change control of external sounds	–	Touch and hold for about 2 seconds
Start the voice assistant	Touch and hold for about 2 seconds	–
Set to the Bluetooth® pairing mode*2	(→ 21, "Connecting a Bluetooth® device")	
Return to the factory settings	(→ 29, "Restoring to the factory settings")	

*1 To cancel muting, touch the touch sensor (R) twice again while muting.

*2 With both earphone LEDs (L and R) blinking alternately in blue and red

Note

- Using the "Technics Audio Connect" app (free of charge) makes changing the operating button of touch sensor. (Customization of touch sensor)
- You can also use just one side of the earphones independently. In this case, it is only possible to perform operations available on the side you are using.
- A beep sounds to indicate that you have touched to reach either the maximum or minimum volume level.

Restoring to the factory settings

When you want to delete all pairing device information, etc. in the earphones, you can restore the earphones to the factory settings (original settings upon purchase).

- 1 Put both earphones (L and R) into the charging cradle to charge the earphones fully.**
- 2 Take the R side earphone out of the charging cradle.**
- 3 While the earphone LED lights (blue) (about 5 seconds), touch and hold the touch sensor (R) for about 7 seconds.**
 - The earphone LED will light alternately in blue and red.
- 4 Release your finger from the touch sensor (R).**
- 5 Touch and hold the touch sensor (R) for about 10 seconds.**
 - The earphone LED (blue) blinks rapidly, and when the power turns off, the earphone returns to the factory settings.
- 6 Do the same Steps 2 to 5 above for the L side earphone.**

Note

- To re-pair the earphones with a Bluetooth® device, delete the registered information (device name: EAH-AZ60 or EAH-AZ40) on the device, then pair the earphones with the Bluetooth® device again. (→ 21)
- Some setting values, such as the language settings for voice prompts and Amazon Alexa, are kept.

Copyright, etc.

The Bluetooth® word mark and logos are registered trademarks owned by Bluetooth SIG, Inc. and any use of such marks by Panasonic Corporation is under license.

Other trademarks and trade names are those of their respective owners.

Apple, the Apple logo and Siri are trademarks of Apple Inc., registered in the U.S. and other countries. App Store is a service mark of Apple Inc.

Google, Android, Google Play, and other related marks and logos are trademarks of Google LLC.

Amazon, Alexa and all related logos are trademarks of Amazon.com, Inc. or its affiliates.

EAH-AZ60 LDAC and LDAC logo are trademarks of Sony Corporation.



Other system names and product names appearing in this document are in general the registered trademarks or trademarks of the respective developer companies.

Note that the ™ mark and ® mark do not appear in this document.

This product incorporates the open source software other than the software licensed under the GPL V2.0 and/or LGPL V2.1. The software categorized as above are distributed in the hope that it will be useful, but WITHOUT ANY WARRANTY, without even the implied warranty of MERCHANTABILITY or FITNESS FOR A PARTICULAR PURPOSE. Please refer to the detailed terms and conditions thereof shown at the following web page.

<https://panasonic.jp/support/global/cs/audio/download/index.html>

Troubleshooting

Before requesting service, make the following checks. If you are in doubt about some of the check points, or if the remedies indicated in the chart do not solve the problem, refer to “Customer Services Directory”* if you reside in the U.S.A., or refer to “CONTACT INFORMATION”* if you reside in Canada, or consult your dealer for instructions.

* Refer to “Limited Warranty”.

Sound and audio volume

No sound.

- Make sure that the earphones and the Bluetooth® device are connected correctly. (→ 21)
- Check if music is playing on the Bluetooth® device.
- Make sure that the earphones are turned on and the volume is not set too low.
- Pair and connect the Bluetooth® device and the earphones again. (→ 21)
- Check if the Bluetooth® compatible device supports “A2DP” profile. For details on profiles, see “Listening to music” (→ 23). Also refer to the operating manual for the Bluetooth® compatible device.

Low volume.

- Also raise the volume on the Bluetooth® device, not just on the earphones.
- Make sure there is no earwax, foreign matter, etc., attached to the earpieces of the earphones.
Remove the earpieces from the main unit (earphones) and refer to “Earphones/Earpieces” (→ 5) to clean them.

Sound from the device is cut off. / Too much noise. / Sound quality is bad.

- Sound may be disrupted if signals are blocked. Do not fully cover the earphones with the palm of your hand, etc.
- The device may be out of the 10 m (33 ft) communication range. Move the device closer to the earphones.
- Remove any obstacle between the earphones and the device.
- Switch off any wireless LAN device when not in use.

Bluetooth® device connection

The device cannot be connected.

- You can pair a maximum of 10 Bluetooth® devices with the earphones. When you pair a device after the maximum has been exceeded, previous devices are overwritten. To use overwritten devices again, do the pairing again.
- Delete the registration information for this unit from the Bluetooth® menu, etc., of the Bluetooth® device, then pair again. (→ 21)

Phone Calls

The voice of the person on the other end of the call is small.

- Also raise the volume on the Bluetooth® device, not just on the earphones.

Cannot make a phone call.

- Check if the Bluetooth® compatible device supports “HSP” or “HFP” profile. For details on profiles, see “Listening to music” (→ 23) and “Making a phone call” (→ 24). Also refer to the operating manual for the Bluetooth® enabled phone.
- Check the audio settings on the Bluetooth® compatible telephone, and if the setting does not allow communication with this unit, change the setting. (→ 21)

The other party finds it hard to hear your voice during a call.

- The earphones detect your voice with voice activity detection microphones to enable the other party to hear it. Your voice cannot be detected if the earpieces are not fitted snugly into your ears. Replace with earpieces that fit snugly into your ears. (→ 12)

General

Cannot operate the earphones.

- Try turning the power off and on. (After placing once into the charging cradle and waiting for about 15 seconds, take them out again.) (→ 19)
- Touch sensor operations may be off. For more details, refer to the operating instructions for the “Technics Audio Connect” app.

The left and right batteries deplete at different rates.

- There may be some difference between left and right due to signal and usage conditions.

Amazon Alexa is not responding.

- Make sure that the Amazon Alexa app is activated.
- Make sure that the voice assistant is set to Amazon Alexa.
- Make sure that data communication is enabled on the mobile device.
- Make sure that the device is paired with the Amazon Alexa app.

Power supply and charging

Cannot charge the unit.

- Is the USB charging cord connected firmly to the USB terminal of the computer? (→ 15)
- Have the earphones been put into the charging cradle correctly? (→ 15)
- If the charging cradle LED (cyan) does not flash even after putting the earphones into the charging cradle, then there is no charge remaining in the charging cradle battery. First charge the charging cradle.
- Make sure to charge in a room temperature between 10 °C and 35 °C (50 °F to 95 °F).
- Make sure the computer is turned on and is not on standby or sleep mode.
- Is the USB port you are currently using working properly? If your computer has other USB ports, unplug the connector from its current port and plug it into one of the other ports.
- If the measures mentioned above are not applicable, unplug the USB charging cord and plug it in again.
- Is the unit already fully charged? If you are trying to charge and the charging cradle LED goes out soon after starting, then the charging cradle is fully charged. If the charging cradle LED (cyan) does not blink with the earphones in the charging cradle when the lid of the charging cradle is opened, then the earphones are fully charged.
- If the charging time and operating time get shorter, the batteries in the earphones and charging cradle may be getting depleted. (Charging cycles for built-in batteries: about 500 times each)

The earphones or charging cradle get warm during charging.

- The earphones and charging cradle may get warm while charging, but this is normal.

The earphones do not turn on.

- After placing once into the charging cradle and waiting for about 15 seconds, take them out again.

The charging cradle LED does not light or blink even when you open the charging cradle lid.

- There is no charge in the battery. Use the USB charging cord (supplied) to charge. (→ 15)
- Take the earphones out of the charging cradle, and after unplugging the USB charging cord, close the lid and leave it for 3 minutes. Then open the lid of the charging cradle and confirm that the power turns on.

The charging cradle LED (red) blinks rapidly.

- The unit are not charged correctly. Unplug the USB charging cord and plug it in again.
If it still blinks red again, refer servicing to qualified service personnel.

The charging cradle LED (cyan) blinks rapidly.

- The earphones are not inserted correctly. Please reinsert the earphones correctly.
- There is dust or droplets of water on the terminals of the earphones and charging cradle. Remove dust and water droplets.

Specifications

■ General

	EAH-AZ60	EAH-AZ40
Power supply (Charging cradle)	DC 5 V, 500 mA	
Internal Battery	Earphones: 3.7 V, Lithium polymer 85 mAh Charging cradle: 3.7 V, Lithium polymer 650 mAh	Earphones: 3.7 V, Lithium polymer 55 mAh Charging cradle: 3.7 V, Lithium polymer 450 mAh
Operating time*1 (Earphones)	Approx. 7.0 hours (Noise cancelling: ON, AAC) Approx. 7.5 hours (Noise cancelling: OFF, AAC) Approx. 5.5 hours (Noise cancelling: ON, SBC) Approx. 6.0 hours (Noise cancelling: OFF, SBC) Approx. 4.5 hours (Noise cancelling: ON, LDAC) Approx. 5.0 hours (Noise cancelling: OFF, LDAC)	Approx. 7.5 hours (AAC) Approx. 5.5 hours (SBC)
Quick charge Operating time*1 (Earphones)	15 min. charge, Approx. 70 min. (Noise cancelling: ON, AAC)	15 min. charge, Approx. 90 min. (AAC)
Operating time*1 (Earphones + Charging cradle)	Approx. 24 hours (Noise cancelling: ON, AAC) Approx. 25 hours (Noise cancelling: OFF, AAC) Approx. 22 hours (Noise cancelling: ON, SBC) Approx. 23 hours (Noise cancelling: OFF, SBC) Approx. 16 hours (Noise cancelling: ON, LDAC) Approx. 17 hours (Noise cancelling: OFF, LDAC)	Approx. 25 hours (AAC) Approx. 19 hours (SBC)

	EAH-AZ60	EAH-AZ40
Call time*¹ (Earphones)	Approx. 4.0 hours (JMV: ON) Approx. 5.5 hours (JMV: OFF)	Approx. 3.0 hours (JMV: ON) Approx. 5.0 hours (JMV: OFF)
Waiting Time*¹ (Earphones)	Approx. 9 hours (Noise cancelling: ON) Approx. 15 hours (Noise cancelling: OFF, Auto power off does not work)	Approx. 19 hours (Auto power off does not work)
Charging time*² (25 °C (77 °F))	Earphones: Approx. 2.0 hours Charging cradle: Approx. 2.5 hours Earphones with Charging cradle: Approx. 3.5 hours	Earphones: Approx. 2.0 hours Charging cradle: Approx. 2.5 hours Earphones with Charging cradle: Approx. 3.0 hours
Charging temperature range	10 °C to 35 °C (50 °F to 95 °F)	
Operating temperature range	0 °C to 40 °C (32 °F to 104 °F)	
Operating humidity range	35 %RH to 80 %RH (no condensation)	
Mass (Weight)	Earphone: Approx. 7 g (0.25 oz) (one side only: L and R are the same) Charging cradle: Approx. 45 g (1.6 oz)	Earphone: Approx. 5 g (0.18 oz) (one side only: L and R are the same) Charging cradle: Approx. 30 g (1.1 oz)

*1 It may be shorter depending on the operating conditions.

*2 The time required to charge the batteries from empty to full.

■ Bluetooth® section

	EAH-AZ60	EAH-AZ40
Bluetooth® system specification	Ver. 5.2	
Wireless equipment classification	Class 1 (9 dBm)	
Max RF Power e.i.r.p	14 dBm	
Frequency band	2402 MHz to 2480 MHz	
Supported profiles	A2DP, AVRCP, HSP, HFP	
Supported codec	SBC, AAC, LDAC	SBC, AAC
Operating distance	Up to 10 m (33 ft)	

■ Earphones section

	EAH-AZ60	EAH-AZ40
Driver units	8 mm (5/16 in)	6 mm (1/4 in)
Microphone	Mono, MEMS Microphone	

■ Charging cradle section

Charging terminal	USB Type-C Shape
-------------------	------------------

■ Accessory section

	EAH-AZ60	EAH-AZ40
USB Charging Cord (Input Plug: USB Type-A Shape, Output Plug: USB Type-C Shape)	Approx. 0.2 m (0.66 ft)	
Earpieces set	XS1, XS2, S1, S2, M, L, XL each 2 pcs., (Size M Attached)	XS, S, M, L each 2 pcs., (Size M Attached)

■ Water resistant

Water resistant	IPX4 equivalent (earphones only)
-----------------	----------------------------------

• Specifications are subject to change without notice.

When disposing of the product

The built-in batteries are a valuable recyclable resource. When disposing of this unit, rather than disposing of in general waste (non-combustible garbage), follow the local national laws and take to the appropriate collection point. Contact your local government organization if you are unsure of your local collection point. Refer to the specifications in this document for information about the batteries.

Earpiece cleaning

Regular cleaning is necessary to continue using the earpieces comfortably.

Earwax and other foreign matter attached to the holes of the earpieces can change the acoustic characteristics, such as making the sound smaller, and also be the cause of malfunctions.

1 Remove the earpieces.

- Grip the earpieces and twist gently as you pull off.
- If you clean the earpieces while they are attached to the earphones, you may damage the protective mesh on the earphones.

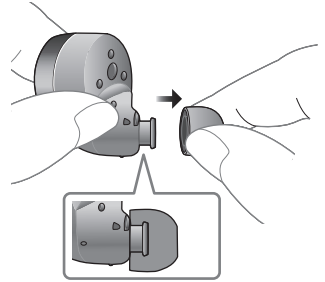

2 Use cotton swabs, etc., to gently wipe the outside of the earpieces to remove foreign matter.

- Regularly use a diluted neutral detergent to hand wash the earpieces, and wipe off the moisture well after washing. (→ 38, "When the earpieces are very dirty")
- If you clean the earpieces while they are attached to the earphones, you may damage the protective mesh on the earphones.

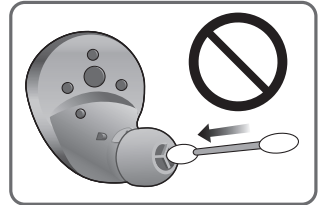
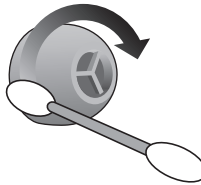

3 Remove earwax, foreign matter, etc., that has attached to the protective mesh of the earphones by blowing on it, etc.

- If hair styling product or make-up gets onto the earphones, wipe off immediately with a soft dry cloth. (Do not touch the protective mesh as this can have an effect on audio characteristics.)
- You may block the protective mesh if you try to remove with a cotton swab, etc., which can lead to malfunctions.

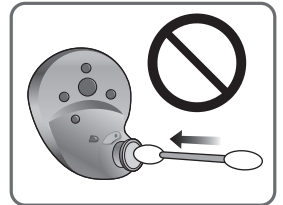
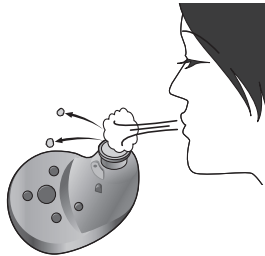

4 Attach the earpieces.

- Make sure the earpieces are fitted firmly onto the earphones and confirm that they are not at an angle.
- Store the earphones in the charging cradle to protect them from foreign matter, etc., getting on them.

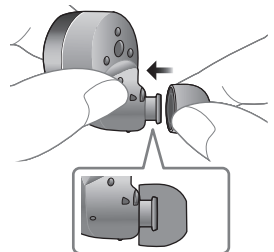

■ When the earpieces are very dirty

1 Wash the earpieces with the tips of your fingers.

(Using a diluted neutral detergent in warm water is effective.)

- Do not remove the sponges from the earpieces.

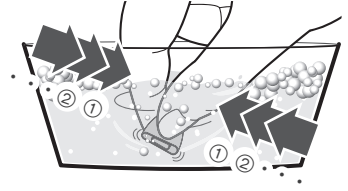
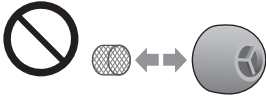

2 Rinse well with clean water after washing.

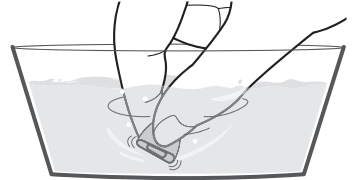

3 Put in between a soft, dry cloth, press firmly 3 to 5 times to ensure the moisture is eliminated.

- After washing the earpieces, eliminate the moisture and dry thoroughly.

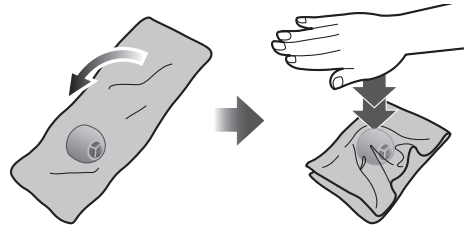

Declaration of Conformity (DoC)

Hereby, "Panasonic Corporation" declares that this product is in compliance with the essential requirements and other relevant provisions of Directive 2014/53/EU.

Customers can download a copy of the original DoC to our RE products from our DoC server:

<http://www.ptc.panasonic.eu>

Contact to Authorized Representative:

Panasonic Marketing Europe GmbH,

Panasonic Testing Centre, Winsbergring 15, 22525 Hamburg, Germany

Type of wireless	Frequency band	Maximum power (dBm e.i.r.p)
Bluetooth®	2,402 - 2,480 MHz	14 dBm

Declaration of Conformity for Radio Equipment in UK

Panasonic Corporation declares that the radio equipment type (Model Numbers are referred in the Operating Instructions) is in compliance with The Radio Equipment Regulations 2017. The full text of the UK declaration of conformity is available at the following internet address:

<https://www.ptc.panasonic.eu/compliance-documents>

Contact in the UK : Panasonic Testing Centre on behalf of Panasonic UK,

a branch of Panasonic Marketing Europe GmbH (Importer),

Maxis 2, Western Road, Bracknell, Berkshire, RG12 1RT

Disposal of Old Equipment and Batteries**Only for European Union and countries with recycling systems**

These symbols on the products, packaging, and/or accompanying documents mean that used electrical and electronic products and batteries must not be mixed with general household waste. For proper treatment, recovery and recycling of old products and used batteries, please take them to applicable collection points in accordance with your national legislation.

By disposing of them correctly, you will help to save valuable resources and prevent any potential negative effects on human health and the environment.

For more information about collection and recycling, please contact your local municipality. Penalties may be applicable for incorrect disposal of this waste, in accordance with national legislation.

**(Note for the battery symbol (bottom symbol)):**

This symbol might be used in combination with a chemical symbol. In this case it complies with the requirement set by the Directive for the chemical involved.

For Thailand only

This telecommunication equipment conforms to NTC/NBTC technical requirement.

For Singapore only

Complies with
IMDA Standards
DB01017

Useful information (Only for Latin American countries)

Customer Service

Customer Service Directory

Obtain products information and operative assistant; localize the closer distributor or Service Center; buy spare parts and accessories by our Web Site to Latin America or calling our Contact Center:

COUNTRY	WEB SITE	CONTACT CENTER
Panama	www.panasonic.com/pa/soporte/	800-7262
Colombia	www.panasonic.com/co/soporte/	01-8000-947262
Ecuador	www.panasonic.com/pa/soporte/	1-800-726276
Costa Rica	www.panasonic.com/pa/soporte/	800-7262737
El Salvador	www.panasonic.com/pa/soporte/	800-7262
Guatemala	www.panasonic.com/pa/soporte/	1-801-811-7262
Uruguay	www.panasonic.com/pa/soporte/	0-800-7262
Paraguay	www.panasonic.com/pa/soporte/	Web Site
Chile	www.panasonic.com/cl/soporte/	800-390-602 022-797-5000
Peru	www.panasonic.com/pe/soporte/	0800-00726
Venezuela	www.panasonic.com/pa/soporte/	Web Site
Mexico	www.panasonic.com/mx/soporte/	800-847-7262 55-5000-1200
Argentina		0800-333-7262 0810-321-7262
Dominican Rep.	www.panasonic.com/pa/soporte/	809-200-8000

For Caribbean countries that speak English please enter this web site in order to find information of our products and operative assistant:
www.panasonic.com/caribbean

For the United Kingdom and Ireland customers

Sales and Support Information

Customer Communications Centre

- For customers within the UK: 0333 222 8777
- For customers within Ireland: 01 447 5229
- Monday–Friday 9:00 am–5:00 pm (Excluding public holidays).
- For further support on your product, please visit our website:
www.technics.com/uk/

**UK
CA**

Importer for UK

Panasonic UK, a branch of Panasonic Marketing Europe GmbH, Maxis 2,
Western Road, Bracknell, Berkshire, RG12 1RT

Manufactured by:

Panasonic Corporation
Kadoma, Osaka, Japan

Authorized Representative in Europe:

Panasonic Marketing Europe GmbH
Panasonic Testing Centre
Winsbergring 15, 22525 Hamburg, Germany



Panasonic Corporation of North America
Two Riverfront Plaza, Newark, NJ 07102-5490
<http://shop.panasonic.com>

Panasonic Corporation
<http://www.panasonic.com>



Panasonic Canada Inc.
5770 Ambler Drive, Mississauga, Ontario L4W 2T3
www.panasonic.com

© Panasonic Corporation 2021

PNQP1654ZA
F0921MH0